



This is a digital copy of a book that was preserved for generations on library shelves before it was carefully scanned by Google as part of a project to make the world's books discoverable online.

It has survived long enough for the copyright to expire and the book to enter the public domain. A public domain book is one that was never subject to copyright or whose legal copyright term has expired. Whether a book is in the public domain may vary country to country. Public domain books are our gateways to the past, representing a wealth of history, culture and knowledge that's often difficult to discover.

Marks, notations and other marginalia present in the original volume will appear in this file - a reminder of this book's long journey from the publisher to a library and finally to you.

Usage guidelines

Google is proud to partner with libraries to digitize public domain materials and make them widely accessible. Public domain books belong to the public and we are merely their custodians. Nevertheless, this work is expensive, so in order to keep providing this resource, we have taken steps to prevent abuse by commercial parties, including placing technical restrictions on automated querying.

We also ask that you:

- + *Make non-commercial use of the files* We designed Google Book Search for use by individuals, and we request that you use these files for personal, non-commercial purposes.
- + *Refrain from automated querying* Do not send automated queries of any sort to Google's system: If you are conducting research on machine translation, optical character recognition or other areas where access to a large amount of text is helpful, please contact us. We encourage the use of public domain materials for these purposes and may be able to help.
- + *Maintain attribution* The Google "watermark" you see on each file is essential for informing people about this project and helping them find additional materials through Google Book Search. Please do not remove it.
- + *Keep it legal* Whatever your use, remember that you are responsible for ensuring that what you are doing is legal. Do not assume that just because we believe a book is in the public domain for users in the United States, that the work is also in the public domain for users in other countries. Whether a book is still in copyright varies from country to country, and we can't offer guidance on whether any specific use of any specific book is allowed. Please do not assume that a book's appearance in Google Book Search means it can be used in any manner anywhere in the world. Copyright infringement liability can be quite severe.

About Google Book Search

Google's mission is to organize the world's information and to make it universally accessible and useful. Google Book Search helps readers discover the world's books while helping authors and publishers reach new audiences. You can search through the full text of this book on the web at <http://books.google.com/>

EDL TRANSFER

N 4ZPS 3



64c 336

Bd. June, 1882.

KH63



*Bought with
the Library Fund
of 1842.*

9 Jan., 1846.

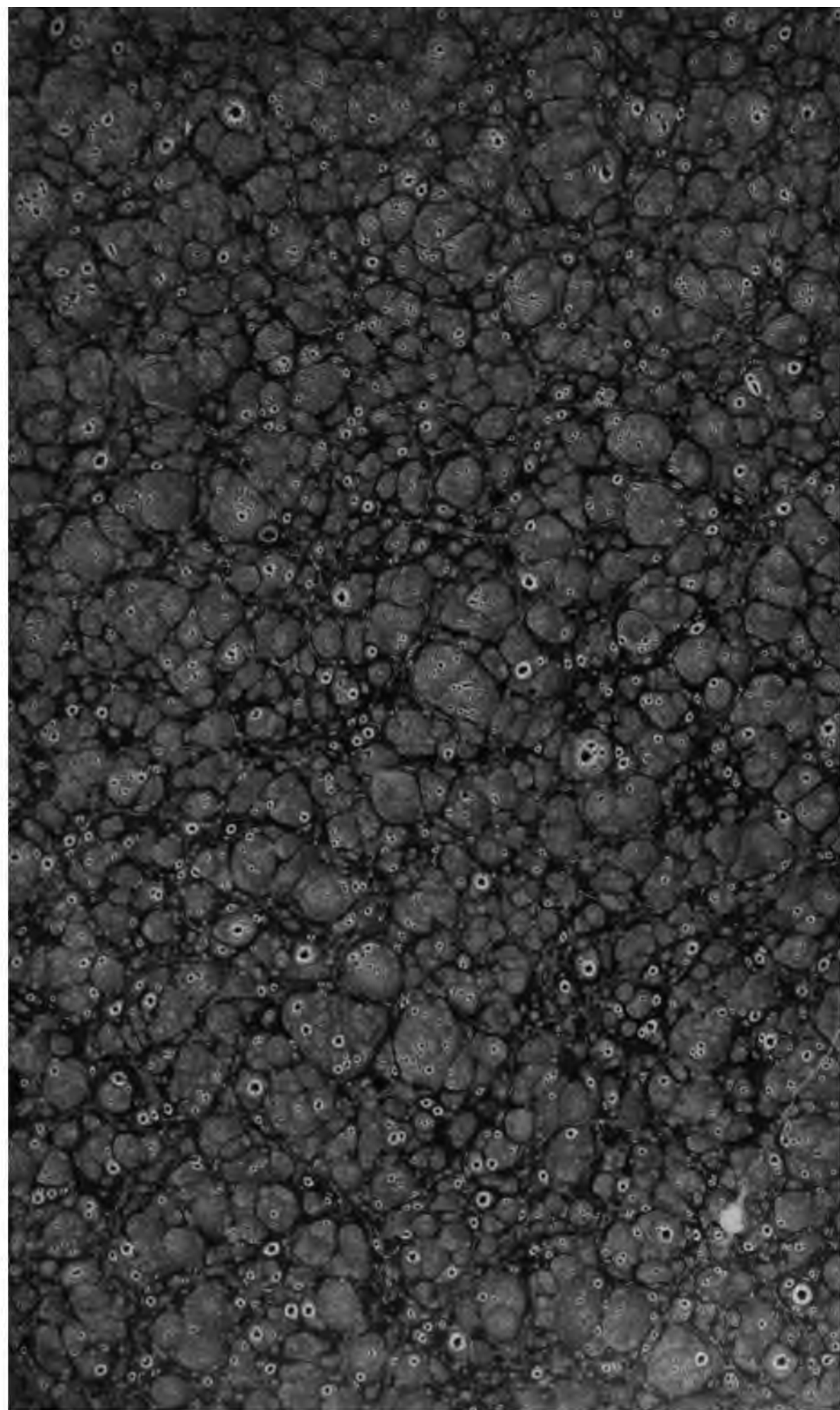







THE
PENNY CYCLOPÆDIA

OF

27

THE SOCIETY

FOR THE

DIFFUSION OF USEFUL KNOWLEDGE.

VOLUME XXIV.

TAI-WAN—TITLARKS.

LONDON:

CHARLES KNIGHT AND Co., 22, LUDGATE STREET.

MDCCCXLII.

Price Seven Shillings and Sixpence, bound in cloth.

R. 376
R.R. 2400, 14

COMMITTEE.

Chairman—The Right Hon. LORD BROUGHAM, F.R.S., Member of the National Institute of France.
Vice-Chairman—The Right Hon. EARL SPENCER.
Treasurer—JOHN WOOD, Esq.

William Allen, Esq., F.R. & R.A.S.
Captain Beaufort, R.N., & C. and R.A.S.
George Burrows, M.D.
Professor Carey, A.M.
John Conolly, M.D.
William Coulson, Esq.
The Right Rev. the Bishop of St. David's, D.D.
J. F. Davis, Esq., F.R.S.
Sir Henry De la Beche, F.R.S.
The Right Hon. Lord Denman.
Samuel Duckworth, Esq.
The Right Rev. the Bishop of Durham, D.D.
T. F. Killa, Esq., A.M., F.R.A.S.
John Killotson, M.D., F.R.S.
Thomas Falconer, Esq.
John Forbes, M.D., F.R.S.
Sir I. L. Goldamid, Bart., F.R. and R.A.S.
Francis Henry Goldsmid, Esq.

B. Gompertz, Esq., F.R. and R.A.S.
Professor Graves, A.M., F.R.S.
G. B. Greenough, Esq., F.R. and L.S.
Sir Edmund Head, Bart., A.M.
M. D. Hill, Esq., Q.C.
Rowland Hill, Esq., F.R.A.S.
Right Hon. Sir J. C. Hobhouse, Bart., M.P.
Thos. Hodgkin, M.D.
David Jardine, Esq., A.M.
Henry B. Ker, Esq.
Professor Key, A.M.
Sir Denis Le Marchant, Bart.
Sir Charles Lemon, Bart., M.P.
George C. Lewis, Esq., A.M.
James Loch, Esq., M.P., F.G.S.
George Long, Esq., A.M.
Professor Malden, A.M.
A. T. Malkin, Esq., A.M.

Mr. Sergeant Manning.
R. I. Murchison, Esq., F.R.S., F.G.S.
The Right Hon. Lord Nugent.
W. S. O'Brien, Esq., M.P.
Professor Quain.
P. M. Roget, M.D. Sec. R.S., F.R.A.S.
R. W. Rothman, Esq., A.M.
Sir Martin Archer Shee, F.R.A., F.R.S.
Sir George T. Staunton, Bart., M.P.
John Taylor, Esq., F.R.S.
Professor Thomson, M.D., F.L.S.
Thomas Vardon, Esq.
Jacob Walker, Esq., M.A.
Jan. Walker, Esq., F.R.S., Pr. Inst., Civ. Eng.
H. Waymouth, Esq.
Thos. Webster, Esq., A.M.
Right Hon. Lord Wrottesley, A.M., F.R.A.S.
J. A. Yates, Esq.

LOCAL COMMITTEES.

Alton, Staffordshire—Rev. J. P. Jones.
Angloen—Rev. E. Williams.
— Miller, Esq.
Barnstable—Bancraft, Esq.
William Gribble, Esq.
Belfast—Jas. L. Drummond, M.D.
Birmingham—Paul Moon James, Esq., *Treasurer*.
Bristol—James Williams, Esq.
Bristol—J. N. Sanders, Esq., F.G.S. *Chairman*.
J. Reynolds, Esq., *Treasurer*.
J. R. Estlin, Esq., F.L.S., *Secretary*.
Calcutta—James Young, Esq.
C. H. Cameron, Esq.
Cambridge—Rev. Leonard Jenyns, M.A., F.L.S.
Rev. John Lodge, M.A.
Rev. Prof. Sedgwick, M.A., F.R.S. & G.S.
Canterbury—John Brent, Esq., *Alderman*.
William Masters, Esq.
Cardiff—Thomas Barnes, M.D., F.R.S.E.
Canterbury—R. A. Poole, Esq.
William Roberts, Esq.
Chester—Henry Potts, Esq.
Chichester—C. C. Dendy, Esq.
Cochernouth—Rev. J. Whitridge.
Corfu—John Crawford, Esq.
Plato Petrides.
County—C. Bray, Esq.
Donagh—Thomas Evans, Esq.
Derby—Joseph Strutt, Esq.
Edward Strutt, Esq., M.P.
Devonport and Stonehouse—John Cole, Esq.
John Norman, Esq.
Lt. Col. C. Hamilton Smith, F.R.S.
Durham—The Very Rev. the Dean.
Edinburgh—J. S. Traill, M.D.

Strwia—Josiah Wedgwood, Esq.
Exeter—J. Tyrrell, Esq.
John Milford, Esq. (*Convener*).
Glamorganshire—W. Williams, Esq., *Aberpergwm*.
Glasgow—K. Finlay, Esq.
Alexander McGregor, Esq.
James Couper, Esq.
A. J. D. D'Orsey, Esq.
Guernsey—F. C. Lukis, Esq.
Hitcham, Suffolk—Rev. Professor Henslow, M.A., F.L.S. & G.S.
Hull—Jas. Bowden, Esq.
Leeds—J. Marshall, Esq.
Lewes—J. W. Woollgar, Esq.
Henry Browne, Esq.
Liverpool Loc. As.—J. Mulleneu, Esq.
Rev. Wm. Shepherd, L.L.D.
Maldstone—Clement T. Smyth, Esq.
John Case, Esq.
Manchester Loc. As.—G. W. Wood, Esq., M.P., *Ch.*
Sir Benjamin Heywood, Bt., *Treasurer*.
Sir George Phillips, Bart., M.P.
T. N. Winstanley, Esq., *Hon. Sec.*
Merthyr Tydfil—Sir J. J. Guest, Bart., M.P.
Minchinhampton—John G. Ball, Esq.
Neath—John Rowland, Esq.
Newcastle—Rev. W. Turner.
T. Sopwith, Esq., F.G.S.
Newport, Isle of Wight—Ab. Clarke, Esq.
T. Cooke, Jun., Esq.
R. G. Kirkpatrick, Esq.
Newport Pagnell—J. Millar, Esq.
Norwich—Richard Bacon, Esq.
Wm. Forster, Esq.
Oxford, Essex—Dr. Corbett.

Oxford—Ch. Daubeny, M.D. F.R.S., *Prof. Chem.*
Rev. Baden Powell, *Sav. Pot.*
Rev. John Jordan, M.A.
Pash, Hungary—Const. Szechenyi.
Plymouth—H. Woolcombe, Esq., F.A.S., *Ch.*
Wm. Snow Harris, Esq., F.R.S.
E. Moore, M.D., F.L.S., *Secretary*.
G. Wightwick, Esq.
Prattage—Rt. Hon. Sir H. Brydges, Bart.
A. W. Davis, M.D.
Ripon—Rev. H. P. Hamilton, M.A., F.R.S., G.S.
Rev. P. Kwart, M.A.
Rutlin—The Rev. the Warden.
Humphreys Jones, Esq.
Ryde, I. of Wight—Sir Rd. Simeon, Bt.
Salisbury—Rev. J. Barstt.
Sheffield—J. H. Abraham, Esq.
Shepton Mallet—G. F. Burroughs, Esq.
Shrewsbury—R. A. Slaney, Esq.
South Petherton—John Nicholett, Esq.
Stockport—H. Marsland, Esq., *Treasurer*.
Henry Coppock, Esq., *Secretary*.
Sydney, New S. Wales—W. M. Manning, Esq.
Swansea—Matthew Moggridge, Esq.
Tewkesbury—Rev. W. Evans.
John Rundle, Esq., M.P.
Truro—Henry Sewall Stokes, Esq.
Truro—Dr. Yeats.
Ulverston—Robert Blorton, Esq.
Virginia, U. S.—Professor Tucker.
Worcester—Chas. Hastings, M.D.
C. H. Hebb, Esq.
Wrexham—Thomas Keworth, Esq.
Major Sir William Lloyd.
Yarmouth—C. E. Humbold, Esq.
York—Rev. J. Kenrick, M.A.
John Phillips, Esq., F.R.S., F.G.S.

THOMAS COATES, Esq., *Secretary*, No. 50, Lincoln's Inn Fields.

THE PENNY CYCLOPÆDIA

OF

THE SOCIETY FOR THE DIFFUSION OF
USEFUL KNOWLEDGE.

T A I

T A I

TAI-WAN (*Taywan*) is the Chinese name of an island which in Europe is known by the name of Formosa, and Hermosa, and, according to the Dutchman Valentyn, is called by the aborigines Pèkan or Pæk-and. It lies between $21^{\circ} 58'$ and $25^{\circ} 15'$ N. lat., and between 120° and 122° E long., and extends from south by west to north by east about 240 miles. In width it varies much. From its most southern point, where it is only about four miles wide, it increases gradually, so that at 23° N. lat. it is 60 miles wide, and at 24° N. lat. nearly 100 miles. Its northern portion decreases in width, but very slowly, for near its northern end it is still 60 miles wide. A rough calculation gives the surface an extent of about 14,000 square miles, which is about half the area of Ireland, and 3000 square miles more than that of Sicily.

The north-western point of Tai-wan is only about 80 miles from the coast of the Chinese province of Fukian, or Fokian; but farther south the channel of Fokian, as the sea between Tai-wan and China is called, grows wider. In the parallel of Amoy, $24^{\circ} 40'$ N. lat., it is 150 miles across, and still wider south of that parallel. This part of the China Sea contains several banks, and the soundings are also extremely irregular, especially in the vicinity of the Ponghu or Phenghu Islands, called also Pescadores, or Fisher Islands. The southern extremity of Tai-wan is divided from the Bashee Islands, which are south-east of it, by the channel of Formosa, which is nearly 80 miles wide, and has also very irregular soundings.

The broad promontory which terminates the island on the south, and forms the south-east and south-west cape, is a low flat, but at the distance of about two miles the country suddenly rises into mountains, which continue to run in an unbroken chain northward nearly through the middle of the island to its northern extremity, terminating with high cliffs at the north-east cape. As it is certain that this range of mountains, which is called Ta Shan, or Great Mountain, is nearly the whole year round covered with snow, its elevation has been estimated by Humboldt at about 12,000 feet above the sea. The declivities of these mountains, with the exception of the crests of the most elevated portion, are covered with fine trees and pasture-grounds, and thus the island, when seen from the sea, presents a very pleasing appearance, whence it was called Hermosa by the Europeans who advanced thus far into the Indian Sea. These mountains have never been visited by Europeans, but from the accounts of the Chinese geographers, which have been collected by Klaproth, it appears that there is more than one volcano on this island. The Tshykang (Red Mountain), south of the town of Fung-shan-hian, was once an active volcano, and there is still a lake of hot water on Shin Mountains. The Phy-nan-my-ahan, south-east of Fung-shan-hian, emits in the night-time a brilliant lustre. The Ho-shan (Fire-Mountain), south-east of Tshu-lo-hian, is said to contain many wells from which flames issue. There are some other mountains which exhibit traces of volcanic

action, and sulphur constitutes an important article of export.

The mountains have a steep declivity on both sides, but on the west side they terminate at a considerable distance from the sea, so as to leave a wide tract between them and the shore. This tract has an undulating surface, and terminates on the sea in a low sandy beach. The adjoining sea is full of sand-banks and shoals, and can only be approached in a few places by vessels drawing more than eight feet of water. On the east of the Ta-shan range the mountains seem to occupy nearly the whole space between the crest of the range and the sea, and high rocks line the shore. There are no soundings along this coast. This circumstance, united to the strong current which sets along this side from south to north, is probably the reason why this part of Tai-wan has never been visited by European vessels; nor does it appear that Japanese or Chinese vessels have any intercourse with this part of the island. It is an unknown portion of the globe.

Rivers are numerous on the west side, but as they originate in a very elevated region, from which they descend in continuous rapids and cataracts, they bring down a considerable quantity of earthy matter, which they deposit at their mouths, forming bars, which have so little water as to admit only small vessels: this however seems to be no great disadvantage, as there are numerous islands along the shore, between which junks of ordinary size (about 200 tons burden) find good anchorage. Some of the rivers however are said to be navigable for a considerable distance inland, especially the Tan-shuy-khy, which falls into the Tan-shuy-kiang Bay, which lies in the narrow part of the channel of Fukian. The rivers also offer the great advantage of an abundant irrigation, though they are sometimes destructive to the crops by their inundations.

No portion of the ocean is subject to such violent gales as the sea surrounding Tai-wan on the west and east. Both monsoons, the north-eastern and the south-western, blow in the direction of the channel of Fukian, and as they are confined between two high mountain-ranges, the mountains of Fukian and of Tai-wan, their violence is much increased. At the change of the monsoons the most violent gales come on suddenly, and are accompanied by typhons, whirlwinds, and waterspouts. Many Chinese vessels are annually lost at these seasons. The Japan Sea, which lies north of Tai-wan, is noted for its terrible tempests. In the vicinity of the island the north-eastern monsoon generally lasts nine months, as it continues to blow to the beginning of June. In other respects the climate of the island is very temperate, neither the heat nor the cold being excessive on the plains along the western coast. The island is subject to earthquakes, and they are sometimes very violent. In 1782 the whole lower portion was laid waste, and the sea inundated the country to the base of the mountains for

twelve hours. A great part of the capital was destroyed, and some hundreds of junks were lost.

The soil of the lower tracts and the more gentle slopes of the mountains is very fertile, and produces abundance of corn, which is exported to the harbours of Fukian, of which the island is said to be the granary. It produces rice of excellent quality; also wheat, millet, maize, and several kinds of vegetables, among which are truffles. The sugar-cane is extensively cultivated, and the sugar made in the island goes to China, as far as Peking. Orchards are carefully attended to. They produce oranges, pine-apples, guavas, cocoa-nuts, areca-nuts, jack-fruit, and other fruits found in the East Indies; also peaches, apricots, figs, grapes, pomegranates, and chestnuts. Melons are also much grown. Only green tea is cultivated, and it is stated that it forms an article of export to China, where it is used as a medicine. The blossoms of the wild jasmine are dried and exported to China, where they are used to give a scent to the tea. Other articles of export are camphor, pepper, aloes, and timber. Timber abounds in the large forests in the northern districts of the island. It is also stated that coffee, cotton, and silk are produced to a small amount.

The domestic animals are cattle, buffaloes, horses, asses, and goats, but sheep and hogs are rare. The horses are small, and the Chinese find them unfit for their cavalry. It is said that on the eastern unknown portion of the island there are many beasts of prey, as tigers, leopards, and wolves, but they are not found on the western side, where wild hogs, deer, monkeys, pheasants, and game are very abundant. Salt is made to a great extent, and, together with sulphur, forms a large article of export.

The population consists of Chinese settlers and of aborigines. The Chinese are only found on the west side of the island, where they first settled a hundred and eighty years ago (1662). Their number many years ago was stated to be about 500,000 individuals. They are mostly from Fukian, and have preserved the customs of their original country, and the spirit of industry and enterprise by which their countrymen are distinguished. A considerable number of aborigines are settled among the Chinese, to whom they are subject, and are obliged to pay a tribute in corn and money. The collectors of the tribute are Chinese, who are required to know the language of the aborigines for the purpose of explaining to them the orders of the court. It is said that the oppression to which the aborigines are subject from these interpreters frequently causes them to rise in rebellion. These aborigines are of a slender make, and in complexion resemble the Malays, but they do not differ from the Chinese in features. Their language shows that they belong to the widely spread race of the Malay nations; and it is said that they greatly resemble the Horaforas of the Moluccas. Their religion resembles what is called Shamanism. The Dutch took some steps to convert them to Christianity, but their sway on the island was too limited and of too short a duration to produce any lasting effect. Nothing is known of the aborigines who inhabit the east side of the island. They are not subject to the Chinese, and are said to be continually at war with them. Inhabiting a country covered with lofty mountains, they are said to subsist mostly on the produce of the chase and by fishing.

The Chinese portion of Tai-wan is divided into four districts, which, from south to north, are Fung-shan-hian, Tai-wan-hian, Tshul-lo-hian, and Thang-hua-hian. The capital, Tai-wan-fu, is a considerable place, and has a garrison of 10,000 troops. The wall was built in 1725. The streets are straight, and intersect one another at right angles: they are full of shops, which are abundantly provided with all articles of Chinese industry. The largest building is that which was erected by the Dutch during their short sway in Tai-wan. There is still a small church built by the Dutch. It is stated that 1000 junks can anchor in the harbour; but as the single entrance, at spring-tides, has but from nine to ten feet of water, only vessels of moderate size can enter it. There was formerly another entrance, which had a greater depth of water, and for the protection of which the Dutch had built the fortress of Zelandia; but it is said that this entrance has been filled up with sand. The commerce of this place with China is considerable. Wu-teou-kiang, which was visited by Lind-say in 1832, has a harbour, which was then crowded with junks and numerous coasting vessels which brought the pro-

duce of the country, especially rice and sugar, to this place. Tan-shuy-kiang, at the embouchure of the river Tan-shuy-kiang, is at the innermost recess of a fine bay, which is large enough for a numerous fleet, but has not been visited by Europeans. The best harbour is near the northern extremity of the island, and is called Ky-long-shai: the Dutch call it Quelong. It is capacious enough to contain 30 large vessels, and is the station of the Chinese navy at the island. An active commerce is carried on at this place.

The commerce of the island is limited to that with the eastern provinces of China, especially Fukian, to which it sends its agricultural produce, with sulphur and salt, and from which it imports tea, raw silk, woollen and cotton stuffs, and other manufactures. It is stated that the number of junks that annually enter the ports amounts to more than 1000. The navigation of the channel of Fukian, though difficult on account of the gales and the rough sea, is rendered much less so by the situation of the Ponghu Islands, which offer a safe refuge in time of danger. These rocky islands are thirty-six in number, most of them very small, and a few somewhat larger. The largest has an excellent harbour, in which vessels of between nine and ten feet draught may anchor in security. The Chinese have erected some fortifications on them, as they have occasionally been taken possession of by pirates, who frequently infest the adjacent coast of China.

Opposite the southern extremity of the eastern coast of Tai-wan is the island of Botol Tabago-xima. It is elevated, and about ten miles in circumference. It is surrounded by a sea without soundings, and no navigator has ever landed on it. It is said to be very populous.

It appears that the island of Tai-wan was known to the Chinese and Japanese at an early period, but they did not settle on it nor subject it to their sway. When the Dutch appeared in these seas, following the track of the Portuguese, they found no Chinese settlement either on the Ponghu Islands or on Tai-wan. They erected some fortification on the Ponghu Islands, and in 1634 they built the fortress of Zelandia at the entrance of the harbour of Tai-wan-fu, where there was then a small town. They built also a small fortress at the harbour of Ky-long-shai. The protection which was thus offered to emigrants induced a large number of families from Fukian to settle in the island, and the colony rose rapidly in importance. Meanwhile China was laid waste by the wars which terminated in the overthrow of the Ming dynasty and the establishment of the present family on the throne. The adherents of the former dynasty maintained their footing longest in the eastern and southern provinces, Chekiang, Fukian, and Quangtun, but being pressed by their enemies, they abandoned the mainland, and continued the war on the sea. One of their chiefs, Tshing-tshing-kung, called by the Europeans Koxinga, sailed, after the loss of a battle, to the Ponghu Islands, and occupied them. Hence he proceeded to Tai-wan, and finding only a very weak garrison in the Dutch fortress, he took it, after a siege of four months, in 1662. Thus the Dutch lost the island, after having been in possession of it for twenty-eight years. Tshing-tshing-kung, the new king of Tai-wan, favoured the settling of his countrymen, the inhabitants of Fukian, and thus the island in a short time was converted into a Chinese colony. He was also favourable to the English, who had, during his reign, a commercial establishment on the island, from which they carried on an active commerce with Amoy. The province of Fukian, which continued its opposition to the victorious Mantchoos longer than any other part of China, had been compelled to submit to their sway: and as Tshing-tshing-kung had died, and the throne of Tai-wan was occupied by a minor, a Chinese fleet in 1682 took possession of the Ponghu Islands. The Chinese were also preparing a descent on Tai-wan, when, in 1683, the council which governed in the name of the young prince thought it most prudent to surrender the island to the court of Peking without a war.

(Père du Maille, *Lettres édifiantes et curieuses*, vol. xviii.; Klapproth's *Description de l'Isle de Formose, extraite de livres Chinois*, in *Mémoires relatifs à l'Asie*: La Pérouse, *Voyage autour du Monde*: and Lind-say's *Voyage of the vessel Amherst along the coast of China*, in *Parliamentary Reports*, 1831.)

TALAPOINS is the name given by the Portuguese, and after them by other European nations, to the Buddhist

priests, or rather monks, of Siam, and is supposed to be derived from the fan which they always carry, usually made of a leaf of the palmyra-tree, and hence, says Crawford (*Journal of Embassy to Siam*, p. 358), denominated by the Sanscrit word *Talpat*. Tal is the common Indian name for the palmyra; and the older travellers give Talapa as the Siamese word for a fan. In the Pali (or learned tongue) the Talapoins of Siam are said to be called Thaynka; but in the common language of the country they are spoken of, as well as to, simply by the term Chau-cou, or Chau-ca, which signifies My lord (or literally Lord of me), the first of the two forms being that commonly used, the other that employed to express extraordinary inferiority on the part of the speaker. (La Loubere, *Du Royaume de Siam*, i. 407.) Mr. Crawford states that they are called Phra, which he says is a Pali word signifying Lord, applied also to Gautama or Buddha, to the king, to the white elephant, to the idols of Buddha, &c. By the Burmese the Talapoins are said to be called Rahans, whence seems to come the name Raulins, given to them by the Mohammedans; as by the Chinese they are called Ho-changi; in Tibet, Lama-seng or Lamas; and in Japan, Bonzes. (Prevost, *Histoire Générale des Voyages*, vi. 328; and Dr. Fr. Buchanan, 'On the Religion and Literature of the Burmas' in *Asiatic Researches*, vol. vi.) In Ceylon the name for the ordinary priests is stated to be Tirounnanse; but, as the novices are said to be styled Saman Eroo Ounnanse, and certain inspectors, exercising a general superintendence over the temples, Naïke Ounnanse and Mahanaïke Ounnanse, it would seem that the name for priests of all kinds is Ounnanse. (Joinville, 'On the Religion and Manners of the People of Ceylon,' in *Asiatic Researches*, vol. vii.) Samana, or Somona, according to Dr. Buchanan, is a title given in Burma both to the priests and to the images of Buddha; whence the Buddhists are often called Samanians. It is derived, he says, from the Sanscrit word Saman, signifying gentleness or affability.

Ample information on the subject of the Talapoins is given by La Loubere, who visited Siam in 1687-8, in quality of envoy from the French king, in his work entitled '*Du Royaume de Siam*,' 2 vols. 12mo., Amsterdam, 1691, vol. i., chaps. 17, 18, 19, 21, pp. 341-368 and 381-426; and by Mr. Crawford, in his 'Journal of an Embassy from the Governor-General of India to the Courts of Siam and Cochin China' (in 1821-22), 4to., London, 1828, pp. 350, &c. They are, as has been stated, a species of monks living in communities of from ten to some hundreds, and employing their time in devotion, religious study, and meditation, and in begging, or rather receiving alms, for they are not permitted actually to solicit charity. Their monasteries, in which each monk has his separate cell, are always adjoining to some temple; but it does not appear that the Talapoins officiate as priests or ministers of religion in our sense of the term. Neither are they considered as forming or belonging to the literary or learned class: the pursuit of any secular study is looked upon as unseemly and profane in a Talapoin; and in fact they are mostly very ignorant. Yet the instruction of youth in the elements of learning appears to be chiefly or exclusively in their hands. Every Siamese, we are told, becomes a Talapoin for some time. 'Every male in the kingdom,' says Mr. Crawford, 'must at one period or another of his life enter the priesthood, for however short a time. Even the king will be a priest for two or three days, going about for alms like the rest, and the highest officers of the government continue in the priesthood for some months.' Usually, it may be supposed, a man goes through the ceremony of getting himself made a talapoin without any intention of permanently forsaking the world; but if he enters one of the sacred communities a second time, he cannot again withdraw from it. The Talapoins are said to be very numerous; but they seem to consist for the greater part of mere temporary members of the order, and of persons who have thus entered it for the second time in advanced life. Its advantages, or temptations, are, a life of idleness, exemption from taxation and from the conscription, security of subsistence and comfortable raiment, together with the ceremonious marks of respect with which a talapoin is everywhere treated. All the monasteries are endowed by the government, or by wealthy individuals, under whose protection they are considered to be. La Loubere has given a drawing of one; and another is described in Finlayson's account of 'The Mission to Siam and Hué in 1821-22,'

p. 110. In their dresses of yellow cotton or silk, which are of the same fashion with those of the Buddhist priests in Ava and Ceylon, the Talapoins of Siam present a highly favourable contrast to the rags and squalidity of the general population. On the other hand, a talapoin is not only separated from society by being condemned to celibacy, and is prohibited from possessing property, but is expected to observe very strictly several of the precepts of the national religion which are very little attended to by anybody else, especially the prohibitions against the slaying of animals (although they will eat them when slain), stealing, adultery, lying, and drinking wine. There are different orders of Talapoins, and La Loubere says there are also female Talapoins, whom he calls Talapouines; but these, according to Crawford, are only a few old women who are allowed to live in the unoccupied cells of some of the monasteries. The national head of the Talapoins, styled the Son-krat, is appointed to that dignity by the king, and always resides in the royal palace.

TALAVE'RA DE LA REYNA, or LA REAL, a large town of Spain, formerly in the province of Toledo, but now, since the late division of the Spanish territory, the capital of the province of its name. It is situated on the right bank of the Tagus, at the end of an extensive and well cultivated plain, 38° 52' N. lat., 6° 39' W. long. It was called by the Romans Eborā Talabriga, as the inscriptions and remains found in its territory show. It has a fine Gothic church, the foundation of the celebrated Rodrigo Ximenez, archbishop of Toledo, the author of a history of the Arabs and a Latin chronicle of Spain, about the beginning of the thirteenth century. The town is badly built, and the streets are narrow and crooked. The population does not exceed 12,000, who are chiefly occupied in the manufacture of pottery and hardware, for which Talavera is famous all over Spain. A large silk manufactory, which belongs to the government, employs also many of the population. In July, 1809, Talavera was the scene of a battle between the British under Wellington (then General Wellesley) and the French commanded by Jourdan. The battle was long and obstinately contested, but it ended in the complete defeat of the French. The exhausted condition of the English troops, who were without provisions, prevented them from following up their advantage and pursuing the enemy. There is another town, in La Mancha, called Talavera la Vieja, 'or 'the old.'

TALC, a mineral which occurs crystallized and massive, and it is probable that some distinct species of minerals have been so called. Primary form of the crystal a rhomboid, but usually occurs in the secondary form of hexagonal laminae, and sometimes in long prisms. Cleavage distinct, perpendicular to the axis. It is easily separable into thin plates, which are flexible, but not elastic. It is easily scraped with a knife, and the powder is unctuous to the touch. Colour white, green, greyish, and blackish-green and red. Becomes negatively electrical by friction; lustre pearly. Transparent; translucent; opaque. Specific gravity 2.713.

Crystallized talc is mostly white, or of a light green colour; is met with in serpentine rocks in small quantity, with carbonate of lime, actinolite, steatite, and massive talc, &c. It is found in the mountains of Salzburg and the Tyrol: it occurs in many other parts of the world, as in Cornwall, in Kynan's Cove, where a bed of it underlies serpentine. It also occurs in Scotland, in Glen Tilt, Perthshire; and in Saxony, Silesia, and Piedmont, &c.

The massive varieties of talc are less flexible than the crystallized: they are principally of an apple-green colour, and sometimes of a radiated structure. It is met with in considerable quantity in beds in micaceous schistus, gneiss, and serpentine.

Some of the varieties of talc are infusible; others become white, and yield a small button of enamel with borax.

Indurated talc is massive, of a greenish grey colour; the structure is schistose and curved: it is of a shining and sometimes of a pearly lustre, and somewhat translucent. It is soft and rather unctuous to the touch. Its specific gravity is 2.9.

It occurs in primitive mountains in clay slate and serpentine, in several countries on the continent of Europe; in Britain, in Perthshire and Banffshire in Scotland, and in the Shetland Islands.

According to Vauquelin, lamellar talc consists of

Silica	62
Magnesia	27
Alumina	1·8
Oxide of iron	3·2
Water	6

100·

Steatite, chlorite, and other magnesian minerals are nearly allied to mica, and they are by some mineralogists considered as varieties of the same substance.

TALEGALLA. Mr. G. R. Gray makes the *Megapodiinae* the third and last subfamily of his *Palamedeidae* (PALAMEDÆ, Linn.).

The *Megapodiinae* comprise the following genera:—*Tulegalla*, Less. (*Alectura*, Lath.; *Talegallus*, Less.; *Numida*, James; *Catheturus*, Sw.); *Megapodius*, Quoy et Gaim. [MEGAPODIIDÆ; CRACIDÆ, vol. viii., p. 132]; *Mesites*? J. Geoffr.; *Menura*, Shaw (*Parkinsonius*, Bechst.; *Megapodius*, Wagl.) [MÆNURA]; *Alecthelia*, Less. (nec Swains.) [CRACIDÆ, vol. viii., p. 133].

We proceed in this article to notice the genera *Tulegalla*, *Leipou*, and *Megapodius*, the natural history of which, especially with regard to their habits and nidification, has lately been satisfactorily made out.

And first of

Talegalla.

Generic Character.—Bill very robust, very thick, one-third of the length of the head compressed above, with the upper mandible convex; nostrils basal, lateral, oval-oblong, pierced in a large membrane; lower mandible less high but wider than the upper, nearly straight below, with smooth edges, the branches widened at the base, and that width filled up by a feathered membrane; cheeks entirely naked; head and neck furnished with feathers with simple barbules. Wings rounded, moderate, the first quill very short, the second rather longer, the third longest of all, the fourth and fifth diminishing in length after the third. Tail rather long, rounded; tarsi rather robust, moderately long, furnished with large scutella in front; toes rather long, the middle longest, the external shortest; the three front toes furnished at their origin with a membranous border, which is widest between the external and middle toes; claws convex, flattened below, slightly curved and moderately robust; the hind-toe long, resting entirely on the ground, and furnished with an equally robust claw. (Lesson.)

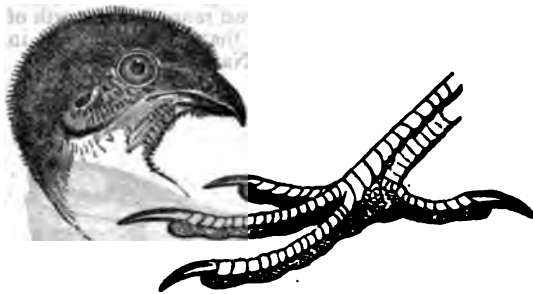

Head and foot of *Talegalla*. (Gould.)

Example, *Talegalla Lathamii*.

Latham, in his *General History of Birds* (vol. i.), described and figured this bird under the name of the *New Holland Vulture*; but, correcting his error, he, in the tenth volume, placed it among the Gallinaceous Birds, with the generic name of *Alectura*, which had been previously employed to designate a group of Flycatchers.

M. Lesson places the genus at the end of the *Phasiacidae*.

Mr. Swainson, in his *Classification of Birds* (vol. i., 1836), treating of the *Vulturidae*, notices this species, under the name of the New Holland Vulture, as being so like a rasorial bird, that some authors have hesitated (not having seen a specimen) as to what order it really belonged. 'So completely indeed,' says he, 'has nature disguised this rare and extraordinary vulture in the semblance of that type which it is to represent in its own family, that it has even been classed by one writer with the *Menura* of the same Continent; and it must be confessed that if clear conceptions of the difference between analogy and

affinity are not entertained, such a classification has some plausible reasons to recommend it. In fact, the feet of the two birds are formed nearly on the same principle; but, then, so are those of *Orthonyx*, a little seasonal bird not much bigger than a robin. All three genera, in short, are remarkable for their large disproportionate feet, long and slightly curved claws, and the equality of length, or nearly so, of the outer and the middle toe. It is by instances such as these that we perceive the full extent of those unnatural combinations which result from founding our notions of classification from one set of characters, and forgetting to look at the full consequences of carrying those notions into extended operation. Nor is this the only peculiarity of the New Holland Vulture; for, unlike all others of its family, it possesses eighteen feathers in its tail. 'An examination of the bill,' Mr. Swainson gives a cut of it, 'which is decidedly raptorial, joined with many other considerations, shows that all these are but analogical relations to the *Rasores*, while the real affinities of the bird are in the circle of the *Vulturidae*, of which it forms the rasorial type. A perfect specimen of this very rare vulture, now before us (procured by Mr. Allan Cunningham in the forests adjoining Van Diemen's Land), enables us to speak of its structure from personal examination.' In the synopsis to Mr. Swainson's second volume (1837), we find it in the family *Vulturidae*, under the name of *Catheturus* (which cannot be retained, between *Neophron* and *Gypaetus*, recorded as the rasorial type of the *Vulturidae*. And yet it is no bird of prey at all. Latham, in his tenth volume, and Lesson, were right in considering it a rasorial species.

Mr. Gould, to whom we are indebted for a full and satisfactory account of the habits of this extraordinary bird, to which we shall presently advert, modestly says:—'After all the facts that have been stated, I trust it will be evident that its natural situation is among the *Rasores*, and that it forms one of a great family of birds peculiar to Australia and the Indian Islands, of which *Megapodius* forms a part; and in confirmation of this view I may add, that the sternum has the two deep emarginations so truly characteristic of the *Gallinaceae*; at all events it is in no way allied to the *Vulturidae*, and is nearly as far removed from *Menura*.' It seems to us that *Talegalla Lathamii* may be considered, in a degree, as the representative of the turkey in Australia.

Description.—Adult male: whole of the upper surface, wings, and tail, blackish-brown; the feathers of the under surface blackish-brown at the base, becoming silvery-grey at the tip; skin of the head and neck deep pink-red, thinly sprinkled with short hair-like blackish-brown feathers; wattle bright yellow, tinged with red where it unites with the red of the neck; bill black; irides and feet brown.

Female about a fourth less than the male in size, but so closely the same in colour as to render a separate description unnecessary. She also possesses the wattle, but not to so great an extent. (Gould.)

Size about that of a turkey.

Mr. Gould gives the following synonyms:—*New Holland Vulture*, Lath.; genus *Alectura*, *ibid.*; *Alectura Lathamii*, J. E. Gray; *New Holland Vulture*, *Catheturus Australis*, Sw.; *Meleagris Lindeargii*, Jameson; *Brush Turkey* of the colonists; *Woolah* of the aborigines of the Namoo.

Habits, Nidification, &c.—Mr. Gould describes *Talegalla Lathamii*, or the *Wattled Talegalla*, as a gregarious bird, generally moving about in small companies, much after the manner of the *Gallinaceae*, and, like some species of that tribe, as very shy and distrustful. When it is disturbed, he states that it readily eludes pursuit by the facility with which it runs through the tangled brush. If hard pressed, or where rushed upon by their great enemy, the native dog, the whole company spring upon the lowermost bough of some neighbouring tree, and, by a succession of leaps from branch to branch, ascend to the top, and either perch there or fly off to another part of the brush. They resort also to the branches of trees as a shelter from the sun in the middle of the day, a habit which Mr. Gould notices as greatly tending to their destruction; for the sportsman is enabled to take a sure aim, and the birds, like the ruffed grouse of America, will allow a succession of shots to be fired till they are all brought down.

But the most remarkable circumstance connected with the economy of this bird is its nidification, for it does not

hatch its eggs by incubation. It collects together a great heap of decaying vegetables as the place of deposit of its eggs, thus making a hot-bed, arising from the decomposition of the collected matter, by the heat of which the young are hatched. Mr. Gould describes this heap as the result of several weeks' collection by the birds previous to the period of laying, as varying in quantity from two to four cart-loads, and as of a perfectly pyramidal form. This mound, he states, is not the work of a single pair of birds, but is the result of the united labour of many: the same site appeared to Mr. Gould to be resorted to for several years in succession, from the great size and entire decomposition of the lower part, the birds adding a fresh supply of materials on each occasion previous to laying.

'The mode,' says Mr. Gould in continuation, 'in which the materials composing these mounds are accumulated is equally singular, the bird never using its bill, but always grasping a quantity in its foot, throwing it backwards to one common centre, and thus clearing the surface of the ground for a considerable distance so completely, that scarcely a leaf or a blade of grass is left. The heap being accumulated, and time allowed for a sufficient heat to be engendered, the eggs are deposited, not side by side, as is ordinarily the case, but planted at the distance of nine or twelve inches from each other, and buried at nearly an arm's depth, perfectly upright, with the large end upwards: they are covered up as they are laid, and allowed to remain until hatched. I have been credibly informed, both by natives and settlers living near their haunts, that it is not an unusual event to obtain nearly a bushel of eggs at one time from a single heap; and as they are delicious eating, they are eagerly sought after. Some of the natives state that the females are constantly in the neighbourhood of the heap about the time the young are likely to be hatched, and frequently uncover and cover them up again, apparently for the purpose of assisting those that may have appeared; while others have informed me that the eggs are merely deposited, and the young allowed to force their way unassisted. In all probability, as nature has adopted this mode of reproduction, she has also furnished the tender birds with the power of sustaining themselves from the earliest period; and the great size of the egg would equally lead to this conclusion, since in so large a space it is reasonable to suppose that the bird would be much more developed than is usually found in eggs of smaller dimensions. In further confirmation of this point, I may add, that in searching for eggs in one of the mounds, I discovered the remains of a young bird, apparently just excluded from the shell, and which was clothed with feathers, not with down, as is usually the case: it is to be hoped that those who are resident in Australia, in situations favourable for investigating the subject, will direct their attention to the further elucidation of these interesting points. The upright position of the eggs tends to strengthen the opinion that they are never disturbed after being deposited, as it is well known that the eggs of birds which are placed horizontally are frequently turned during incubation. Although, unfortunately, I was almost too late for the breeding-season, I nevertheless saw several of the heaps, both in the interior and at Illawarra: in every instance they were placed in the most retired and shady glens, and on the slope of a hill, the part above the nest being scratched clean, while all below remained untouched, as if the birds had found it more easy to convey the materials down than to throw them up. In one instance only was I fortunate enough to find a perfect egg, although the shells of many from which the young had been excluded were placed in the manner I have described. At Illawarra they were rather deposited in the light vegetable mould than among the leaves, which formed a considerable heap above them. The eggs are perfectly white, of a long, oval form, three inches and three-quarters long by two inches and a half in diameter.' (*Birds of Australia*.)

The same author relates that these birds, while stalking about the wood, frequently utter a loud clucking noise; in various parts of the bush, he observed depressions in the earth, which the natives informed him were made in dusting themselves. The stomach is stated to be extremely muscular; and he found one of which he dissected filled with seeds, berries, and a few insects.

The same composer with which these birds sit to be shot at, as above noticed, must, as Mr. Gould observes, lead to an

early extinction of the race; an event, he remarks, much to be regretted, since, independently of its being an interesting bird for the aviary, its flesh is extremely delicate, tender, and juicy. There is no doubt that this species may be domesticated, and it would make a noble addition to those foreign denizens of the poultry-yard which enrich our homesteads and tables. Mr. Gould saw a living specimen, which was in the possession of Mr. Alexander M'Leay for many years. 'On my arrival at Sydney,' says Mr. Gould, 'this venerable gentleman took me into his garden and showed me the bird, which, as if in its native woods, had for two successive years collected an immense mass of materials similar to those above described. The borders, lawn, and shrubbery over which it was allowed to range presented an appearance as if regularly swept, from the bird having scratched to one common centre everything that lay upon the surface: the mound in this case was about three feet and a half high, and ten feet over. On placing my arm in it, I found the heat to be about 90° or 95° Fahr. The bird itself was strutting about with a proud and majestic air, sometimes parading round the heap, at others perching on the top, and displaying its brilliantly coloured neck and wattle to the greatest advantage: this wattle it has the power of expanding and contracting at will; at one moment it is scarcely visible, while at another it is extremely prominent.'

Before Mr. Gould left New South Wales, this bird, which, during the greater part of the period when it was in Mr. M'Leay's possession, was at large, and usually associated with the fowls in the poultry-yard, was unfortunately drowned in a tank or water-butt. On dissection it was found to be a male, thereby proving, as Mr. Gould remarks, that the sexes are equally employed in forming the mound for the reception of the eggs.

Locality.—Mr. Gould states that the extent of the range of this species over Australia is not yet satisfactorily ascertained. It is known, he says, to inhabit various parts of New South Wales from Cape Howe on the south to Moreton Bay on the north; but the cedar-cutters and others, who so frequently hunt through the brushes of Illawarra and Maitland, have nearly extirpated it from those localities, and it is now most plentiful in the dense and little-trodden brushes of the Manning and Clarence. Mr. Gould was at first led to believe that the country between the mountain-ranges and the coast constituted its sole habitat; but he was agreeably surprised to find it inhabiting the scrubby gullies and sides of the lower hills that branch off from the great range into the interior. He procured specimens on the Brezi range to the north of Liverpool Plains, and ascertained that it was abundant in all the hills on either side of the Namoi. (*Ibid.*)



Talegalla Lathamii. (Gould.)

M. Lesson describes the species from New Guinea, which serves as the type of his genus *Talegalla Cuvieri*, figured in the *Zoologie de la Coquille*, as entirely black, of the size of a common small hen, and recalling to the observer some of the forms of the *Porphyryones*. [*RALLIDE*, vol. xix., p. 281.]

The history of *Talegalla* affords a striking instance of the futility of classification based upon reasoning which has no sufficient data for its foundation: most of the errors

of our zoological systems may be traced to the same source.

Leipoa. (Gould.)

Generic Character.—Bill nearly as long as the head, slender, tumescent at the base, the edges undulated and incurved at the base, the nostrils ample, oblong, covered with an operculum, and placed in a central hollow. Head

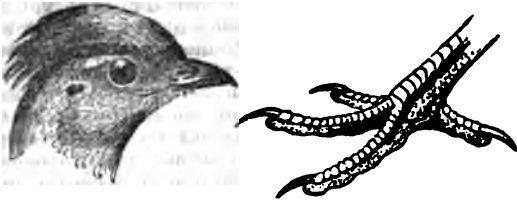

Head and Foot of *Leipoa*.

subcrested. *Wings* ample, rounded, concave; fifth primary quill the longest; the tertiaries nearly as long as the primaries. *Tail* rounded, tail-feathers fourteen. *Tarsi* moderate, robust, covered with scuta anteriorly, and posteriorly with scales which are rounded and unequal. *Toes* rather short; lateral toes nearly equal. (Gould.)

Example, *Leipoa ocellata*, *Ocellated Leipoa*. (Gould.)

Description.—Head and crest blackish-brown; neck and shoulders dark ash-grey; the fore part of the neck from the chin to the breast marked by a series of lanceolate feathers, which are black with a white stripe down the centre; back and wings conspicuously marked with three distinct bands of greyish white, brown and black near the tip of each feather, the marks assuming an ocellated form, particularly on the tips of the secondaries; primaries brown, their outer webs marked with two or three zigzag lines near their tip; all the under surface light buff, the tips of the flank feathers barred with black; tail blackish-brown, broadly tipped with buff; bill black; feet blackish-brown. (Gould.)

In size this beautiful bird is inferior to *Tulegalla Lathamii*, and it is more slender and more elegantly formed. According to Mr. Gould, it is the *Ngow* of the aborigines of the lowland; *Ngow-oo* of the mountain districts of Western Australia; and *Native Pheasant* of the colonists of Western Australia.

Habits, Food, Nidification, &c.—Mr. Gould, in his *Birds of Australia*, gives an account, collected by Mr. John Gilbert, from G. Moore, Esq., advocate-general, Mr. Armstrong, the aboriginal interpreter, and some of the more intelligent natives of Western Australia. The *Ocellated Leipoa* is there described as a ground-bird, never taking to a tree except when closely hunted: when hard pursued, it will frequently run its head into a bush, and is then easily taken. Food generally consisting of seeds and berries. The note mournful, very like that of a pigeon, but with a more inward tone. Eggs deposited in a mound of sand, the formation of which is the work of both sexes. According to the natives, the birds scratch up the sand for many yards around, forming a mound about three feet in height, the inside of which is constructed of alternate layers of dried leaves, grasses, &c., among which twelve eggs and upwards are deposited, and are covered up by the birds as they are laid; or, as the natives express it, 'the countenances of the eggs are never visible.' Upon these eggs the bird never sits, but when she has laid out her lay, as the henwives say, the whole are covered up, when the mound of sand resembles an ant's nest. The eggs, which are white, very slightly tinged with red, and about the size of a common fowl's egg, are hatched by the heat of the sun's rays, the vegetable lining retaining sufficient warmth during the night; they are deposited in layers, no two eggs being suffered to lie without a division. The natives, who are very fond of the eggs, rob these hillocks two or three times in a season; and they judge of the number of eggs in a mound by the quantity of feathers lying about. If the feathers be abundant, the hillock is full; and then they immediately open and take the whole. The bird will then begin to lay again, again to be robbed, and will frequently lay a third time. Upon questioning one of the men attached to Mr. Moore's expedition, he gave to Mr. Gilbert a similar account of its habits and mode of incubating; adding, that in all the mounds they opened, they found ants almost as numerous as in an ant-

hill; and that in many instances that part of the mound surrounding the lower portion of the eggs had become so hard, that they were obliged to chip round them with a chisel to get the eggs out; the insides of the mounds were always hot.

Captain Grey, of the 83rd regiment, who had just returned from his expedition to the north-west coast, informed Mr. Gould that he had never fallen in with the nests but in one description of country, viz. where the soil was dry and sandy and so thickly wooded with a species of dwarf *Leptospermum*, that if the traveller strays from the native paths, it is almost impossible for him to force his way through. In these close scrubby woods small open glades occasionally occur, and there the *Ngow-oo* constructs its nest,—a large heap of sand, dead grass and boughs, at least nine feet in diameter and three feet in height; Captain Grey had seen them even larger than this. Upon one occasion only he saw eggs in these nests; they were placed some distance from each other, and buried in the earth. Captain Grey states that he is not sure of the number, but the account given by the natives led him to believe that at times large numbers were found.

Locality.—Western Australia. Mr. Moore saw a great many of them about sixty miles north of Perth; but its most favourite country appears to be the barren sandy plains of the interior, 100 miles north and east of York. The farthest point north at which Captain Grey saw the breeding-places was Gantheaume Bay. Captain Grey states that the natives of King George's Sound say that the same or a nearly allied species exists in that neighbourhood. (*Birds of Australia*.)



Leipoa ocellata. (Gould.)

Megapodius.

In the article *CRACIDÆ* (vol. viii., p. 132) the generic character of *Megapodius* and an account of *Megapodius Duperreyi* is given. It is there stated that it would seem that the *Megapodius* of the Philippines leaves its eggs to the fostering heat of the sun. Mr. Gould, in the great work from which we have already drawn such interesting accounts of this extraordinary group of birds, has, from the notes of Mr. Gilbert, laid before the public a most satisfactory statement relative to the habits of *Megapodius Tumulus*

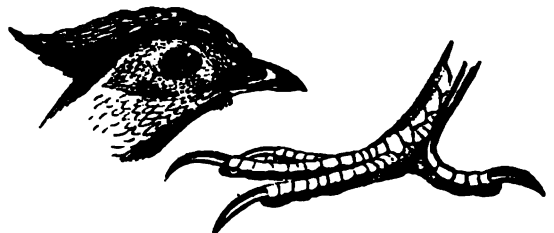

Head and foot of *Megapodius*. (Gould.)

Description.—Head and crest very deep cinnamon-brown; back of the neck and all the under surface very dark grey; back and wings cinnamon-brown; upper and under tail-coverts dark chestnut-brown; tail blackish-brown; irides generally dark brown, but in some specimens light reddish-brown; bill reddish-brown, with yellow

edges; tarsi and feet bright orange, the scales on the front of the tarsi from the fourth downwards, and the scales of the toes, dark reddish-brown. (Gould.)

Size about that of a common fowl.

This is the *Oreogorgia* of the aborigines of the Cobourg Peninsula; the *Jungle-fowl* of the colonists of Port Essington.

Habits, Food, Nidification, &c.—On Mr. Gilbert's arrival at Port Essington his attention was attracted to numerous great mounds of earth which were pointed out to him by some of the residents as being the tumuli of the aborigines. The natives, on the other hand, assured him that they were formed by the *Jungle-fowl* for the purpose of hatching its eggs. But this last statement appeared so extraordinary, and so much at variance with the general habits of birds, that no one in the settlement believed them, and the great size of the eggs brought in by them as the produce of this bird strengthened the doubt of the veracity of their information. Mr. Gilbert however, knowing the habits of *Leipoa*, took with him an intelligent native, and proceeded about the middle of November to Knocker's Bay, a part of Port Essington harbour comparatively but little known, and where he had been informed a number of these birds were to be seen. He landed beside a thicket, and had not advanced far from the shore when he came to a mound of sand and shells, with a slight mixture of black soil, the base resting on a sandy beach, only a few feet above high-water mark: it was enveloped in the large yellow-blossomed *Hibiscus*, was of a conical form, twenty feet in circumference at the base, and about five feet high. On asking the native what it was, he replied, '*Oreogorgia Rambal*' (*Jungle-fowl's* house or nest). Mr. Gilbert scrambled up the sides of it, and found a young bird in a hole about two feet deep; the nestling, apparently only a few days old, was lying on a few dry withered leaves. The native assured Mr. Gilbert that it would be of no use to look for eggs, as there were no traces of the old birds having lately been there. Mr. Gilbert took the utmost care of the young bird, placed it in a moderate-sized box, into which he introduced a large portion of sand, and fed it on bruised Indian corn, which it took rather freely. Its disposition was wild and intractable, and it effected its escape on the third day. While it remained in captivity, it was incessantly employed in scratching up the sand into heaps, and Mr. Gilbert remarks that the rapidity with which it threw the sand from one end of the box to the other was quite surprising for so young and small a bird, its size not being larger than that of a small quail. At night it was so restless that Mr. Gilbert was constantly kept awake by the noise it made in endeavouring to escape. In scratching up the sand the bird only employed one foot, and having grasped a handful as it were, threw the sand behind it with but little apparent exertion, and without shifting its standing position on the other leg: this habit, Mr. Gilbert observes, seemed to be the result of an innate restless disposition and a desire to use its powerful feet, and to have but little connection with its feeding; for, although Indian corn was mixed with the sand, Mr. Gilbert never detected the bird in picking any of it up while thus employed.

Mr. Gilbert continued to receive the eggs without any opportunity of seeing them taken from the ground until the beginning of February, when, on again visiting Knocker's Bay, he saw two taken from a depth of six feet, in one of the largest mounds he had met with. In this instance the holes ran down in an oblique direction from the centre towards the outer slope of the hillock, so that although the eggs were six feet deep from the summit, they were only two or three feet from the side. 'The birds,' says Mr. Gilbert in continuation, 'are said to lay but a single egg in each hole, and after the egg is deposited the earth is immediately thrown down lightly until the hole is filled; the upper part of the mound is then smoothed and led over. It is easily known when a *Jungle-fowl* has recently excavating, from the distinct impressions of feet on the top and sides of the mound, and the earth so lightly thrown over, that with a slender stick the opening of the hole is readily detected, the ease or difficulty of thrusting the stick down indicating the length of time that may have elapsed since the bird's operations. It is easy enough; but to reach the eggs requires much exertion and perseverance. The natives dig

them up with their hands alone, and only make sufficient room to admit their bodies, and to throw out the earth between their legs; by grubbing with their fingers alone they are enabled to follow the direction of the hole with greater certainty, which will sometimes, at a depth of several feet, turn off abruptly at right angles, its direct course being obstructed by a clump of wood or some other impediment. Their patience is however often put to severe trials. In the present instance the native dug down six times in succession to a depth of at least six or seven feet without finding an egg, and at the last attempt came up in such a state of exhaustion that he refused to try again; but my interest was now too much excited to relinquish the opportunity of verifying the native's statements, and by the offer of an additional reward I induced him to try again: this seventh trial proved successful, and my gratification was complete when the native with equal pride and satisfaction held up an egg, and, after two or three more attempts, produced a second: thus proving how cautious Europeans should be of disregarding the narrations of these poor children of nature, because they happen to sound extraordinary or different from anything with which they were previously acquainted.'

Upon another occasion Mr. Gilbert and his native, after an hour's excessive labour, obtained an egg from the depth of about five feet. It was in a perpendicular position. The holes in this mound (which was fifteen feet high and sixty in circumference at the base, and, like the majority of those that he had seen, so enveloped in thickly foliaged trees as to preclude the possibility of the sun's rays reaching any part of it) commenced at the outer edge of the summit and ran down obliquely towards the centre: their direction therefore, Mr. Gilbert observes, is not uniform. The mound was quite warm to the hands.

How the young effect their escape does not appear; some natives told Mr. Gilbert that the nestlings effected their escape unaided; but others said that the old birds at the proper time scratched down and released them. The natives say that only a single pair of birds are ever found at a mound at a time. Our space will not permit a more detailed account of these highly curious mounds; but the reader should consult Mr. Gould's highly valuable work for other particulars: we can only spare room for Mr. Gilbert's description of the general habits of this interesting species.

The *Jungle-fowl* is almost exclusively confined to the dense thickets immediately adjacent to the sea-beach: it appears never to go far inland, except along the banks of creeks. It is always met with in pairs or quite solitary, and feeds on the ground, its food consisting of roots which its powerful claws enable it to scratch up with the utmost facility, and also of seeds, berries, and insects, particularly the larger species of Coleoptera. It is at all times a very difficult bird to procure; for although the rustling noise produced by its stiff pinions when flying away be frequently heard, the bird itself is seldom to be seen. Its flight is heavy and unsustained in the extreme; when first disturbed it invariably flies to a tree, and on alighting stretches out its head and neck in a straight line with its body, remaining in this position as stationary and motionless as the branch upon which it is perched: if however it becomes fairly alarmed, it takes a horizontal but laborious flight for about a hundred yards with its legs hanging down as if broken. I did not myself detect any note or cry, but from the native's description and imitation of it, it much resembles the clucking of the domestic fowl, ending with a scream like that of the peacock. I observed that the birds continued to lay from the latter part of August to March, when I left that part of the country; and, according to the testimony of the natives, there is only an interval of about four or five months, the driest and hottest part of the year, between their seasons of incubation. The composition of the mound appears to influence the colouring of a thin epidermis with which the eggs are covered, and which readily chips off, showing the true shell to be white: those deposited in the black soil are always of a dark reddish-brown; while those from the sandy hillocks near the beach are of a dirty yellowish white: they differ a good deal in size, but in form they all assimilate, both ends being equal: they are three inches and five lines long by two inches and three lines broad.' (*Birds of Australia.*)

Mr. Gould has thus given the history of these three

nearly allied genera, forming, as he observes, part of a great family of birds whose range will be found to extend from the Philippines through the islands of the Indian Archipelago to Australia. *Megapodius Tumulus* is, according to him, rather numerously spread over the whole of the Cobourge Peninsula on the north coast of the Australian continent, where the British settlement of Port Essington is now established; and he thinks that future research will require us to assign to it a much wider range, probably over the whole extent of the north coast.



Megapodius Tumulus, Mound-raising Megapode, with nest in the distance. (From Gould.)

TALENT (*τάλαντον*) was the highest denomination of Greek weights and money, and was also commonly used by Greek writers as the translation of words signifying a certain weight in other languages. It is necessary to observe that the talent is properly only a denomination of weight. There was no coin of that name; and when used in reference to money, it meant originally a talent-weight of gold or silver, and afterwards a certain quantity of current money, the weight of which (supposing the real and nominal value of the coin to be the same) amounted to a talent.

I. **THE HEBREW TALENT, OR KIRKAR** (כִּרְקָר), contained 3000 shekels, and, according to Mr. Hussey's computation, its weight was 93 lbs. 12 ozs. avoirdupois, and its value as silver-money 396*l.* 5*s.* 10*d.* [SHEKEL.] The Hebrews had no gold money of their own.

II. THE GREEK TALENT.

The following were the principal denominations of weight and money among the Greeks:—*δβολός*, *δραχμή*, *μνᾶ*, *τάλαντον*, of which the *δβολός* was the smallest. Their relative proportions are shown in the annexed table:—

Obol			
6	Drachma		
600	100	Mina	
36,000	6000	60	Talent.

This system prevailed throughout Greece, but the actual values of the talent varied in different states. Most of these variations may be included under two chief standards, namely, the Attic and the Aeginetan.

1. *The Attic Talent.*—The value of the Attic talent before the time of Solon is a matter on which we possess hardly any historical information, though we may perhaps arrive at a very probable result. Looking then at the system after Solon had remodelled the coinage [Solon], we find that the Attic silver money was celebrated for its purity; and therefore from the coins of that period which still exist we may determine the value of the standard with tolerable certainty. Now the chief coin was the drachma of silver, the average weight of which, from the time of Solon to that of Alexander the Great, is found to be 66.5 grains. From this we get the following values in avoirdupois weight:—

	lb.	oz.	gr.
Obol	11.08
Drachma	66.5
Mina	15	83.75
Talent	56	15½	100.32

This was the standard always used for silver money, and was therefore called 'the silver standard.'

Besides this there was another standard, the chief of which was called *the commercial mina* (*ἡ μινᾶ ἑμπορίαι*) and contained 138 drachmae, 'according to the weights in the silver mint' (see a decree in *BG Inscript.*, i. 123, § 4); that is, not that a commercial contained 138 commercial drachmae, but that quite a different standard from that used for silver its unit being to that of the latter in the ratio 100:100; while the relative proportions of the weight the same in both systems. The following table sh value of the Attic commercial standard:—

	lb.	oz.	gr.
Obol	15.29
Drachma	91.77
Mina	1	4½	93.69
Talent	75	5½	14.69

These weights were used for all commodities, except as were expressly required by law to be sold by the standard.

This commercial standard is most probably, as has been shown, the real ancient Attic standard, as it is before the time of Solon. The purpose of Solon's was to lower the value of money, in order to debtors. The only direct information we have of the change is the statement of Plutarch 'Solon made the mina of 100 drachmae, which formerly contained 73,' which is probably a mistake by Plutarch, through not understanding the *W. Androtion*, whose authority he follows. The true seems undoubtedly to be, that out of the same quantity of silver which in the ancient standard made 73 drachmae Solon coined 100, or a mina; that is, that he lowered the standard in the ratio of 100:73. Now the ratio commercial to the silver standard is 138:100 = 1.38. Hence the commercial standard and the old Attic differed by a small fraction.

Still this ratio of 100:73 is a very singular one for to have adopted. The most probable explanation Solon meant to lower the standard by a quarter, in the ratio of 100:75, and that the new coinage accident of not uncommon occurrence in minting found, when actually made, to be a little too light, and in the ratio of 72½:100, or, in round numbers, 72:100, instead of 75:100; and that to preserve the purity of the Attic mint, this, its actual value was adopted as its nominal value.

This view is strongly confirmed by a reference to another standard mentioned by Greek writers, namely *Euboic talent*. This talent was often reckoned as to the Attic (compare Herod., iii. 89, with Pollux, but it is also described with greater precision by *Var. Hist.*, i. 22), as having to the Attic the ratio 72:70, which is the same as 75:72½. Now if we suppose that the intended value of Solon's talent had the real value the ratio of 75:72½, we have this in value equal (neglecting a very small fraction) to the *Euboic talent*. Hence it is inferred that Solon, prior to lowering the Attic standard, and perceiving the advantage of assimilating it to that of the neighbouring island of Euboea, intended to adopt the latter for his new standard; but that in fact a slight difference was caused by accident.

The Romans reckoned both the Attic and Euboic talents as equal to 80 Roman pounds (compare *Pol.* 14, with xxii. 26, and *Liv.* xxxvii. 43, with xxxviii. 10).

The Attic commercial standard underwent an alteration by the edict above referred to, which made its mina = 150 drachmae (silver)
its 5 minæ = 6 minæ (commercial)
its talent = 65 minæ (commercial)

In this new standard the five-minæ weight was equal to 7 lb. 13½ oz. 14.96 grs., and the talent to 85 lb. 7.07 grs.

The Athenians took the greatest care of their standards of weight. The principal sets were lodged in the polis, and there were other sets in the Prytaneum at Piræus, and at Eleusis. The highest coin used by the Athenians was the drachm, or piece of four drachmae; the mina and were never coined, but were paid in drachmae, obols. The following table shows the value of all the denominations of Attic silver money, according to the computation of Mr. Hussey:—

	s.	d.	farthings.
Chalcus (of copper)			8125
½ Obol			1625
¼ Obol			325
Obol		1	25
Diobolon		3	1
Triobolon		4	5
Tetrobolon		6	2
Drachma		9	3
Didrachm		1	7 2
Tetradrachm		3	3
Mina		4	1 3
Talent	243	15	

2. *The Aeginetan talent.* It is a disputed question what was the ratio of the Aeginetan to the Attic talent. Pollux (ix. 76, 86) says that the Aeginetan talent contained 10,000 Attic drachmae, and the Aeginetan drachma 10 Attic obols, which would give the ratio of 5 : 3 for that of the Aeginetan to the Attic talent. According to this statement, the Aeginetan drachma weighed 110 grains English. Now the existing coins give an average of only 90 grains; and the question therefore is whether we are to follow Pollux or the coins. Mr. Hussey takes the latter course, explaining the statement of Pollux as referring to the debased drachma of later times, which was about equal to the Roman denarius. Böckh adheres to the statement of Pollux, explaining the lightness of the existing coins by the well-known tendency of the ancient mints to depart from the full value. He has supported his view by some very strong and ingenious arguments, and on the whole he appears to be right.

There were other talents used by the Greeks and Romans, most of which seem to have been derived from one of these two standards, but the accounts of ancient writers respecting them are very contradictory. Their values are discussed at length by Böckh and Hussey.

The most important variations of the Aeginetan standard were those used in Macedonia, Corinth, and Sicily.

The above talents were all reckoned in silver money. There was also a talent of gold, which was much smaller. It was used chiefly by the Greeks of Italy and Sicily, whence it was called the *Sicilian talent* as well as the *gold talent*. It was equal to 6 Attic drachmae, that is, about ½ oz. and 1 grs. It was divided by the Italian Greeks into 24 *nummi*, and afterwards into 12, each *nummus* containing ½ *litrae*. When Homer uses the word *talent*, we must always understand by it this small one of gold. In other classical writers the word generally means the Attic talent.

(Böckh, *Metrolog. Untersuch.*; Hussey, *Ancient Weights and Money*; *Dictionary of Greek and Roman Antiquities*, 1842.)

TALENTS. At common law, when the number of jurors in attendance was so small, or so much diminished by challenges that a full jury could not be had, a writ (then in Latin) issued to the sheriff, commanding him to summon *such* (tales) other fit persons, &c. for the purpose of making up the jury. The jurors so procured were called *talesmen*, from the Latin word used in the writ. By the Statute 35 Hen. VIII., c. 6, the defect of jurors might, at the request of the plaintiff or defendant in an action, be supplied from *such* other able persons of the said county then present, and these were ordinarily called, from the word in the Latin writ, '*tales de circumstantibus*.' Subsequent statutes extended and regulated the application of this writ. But the act now in force is 6 Geo. IV., c. 50; and the 10th section, which contains the existing law on the subject, and is in the following words:—'Where a full jury shall not appear before any court of assize or Nisi prius, or before any of the superior civil courts of the three counties palatine, or before any court of great sessions, or where, after appearance of a full jury, by challenge of any of the parties, the jury is likely to remain untaken for default of jurors, every such court, upon request made for the making by any one thereto authorised or assigned by the court, or on request made by the parties, plaintiff or defendant, demandant or tenant, or their respective attorneys, in any action or suit, whether popular or private, shall command the sheriff or other minister, to whom the making of the return shall belong, to name and appoint, as often as need shall require, so many of *such* other able men of the county then present as shall make up a full jury; and the sheriff or other minister aforesaid shall, at such command of the court, return *such* men duly qualified as shall

be present, or can be found to serve on such jury, and shall add and annex their names to the former panel, provided that where a special jury shall have been struck for the trial of any issue, the talesman shall be such as shall be empannelled upon the common jury panel to serve at the same court, if a sufficient number of such men can be found; and the king, by any one so authorised or assigned as aforesaid, and all and every the parties aforesaid, shall and may, in each of the cases aforesaid, have their respective challenges to the jurors so added and annexed, and the court shall proceed to the trial of every such issue with those jurors who were before empannelled, together with the talesmen so newly added and annexed, as if all the said jurors had been returned upon the writ of precept awarded to try the issue.' (2 Williams's Saunders, 349 n. (1).) [Jury.]

TALIACO'TIUS, GASPAR, TAGLIACOZIO, or TAGLIACOZZI, was professor of anatomy and surgery at Bologna, where he died in 1553, at the age of 64 years. His name is now known chiefly through his reputation for restoring lost noses; but during his life he was equally celebrated for his knowledge of anatomy and his excellence as a lecturer. These last are indeed the only qualities for which he is praised in a tablet put up after his death in one of the halls of the school at Bologna. A statue erected in the amphitheatre formerly recorded his skill in operating by representing him with a nose in his hand.

Some writers have spoken of the original Taliacotian operation as a mere fable, pretending that it never could have been followed by success. But several credible witnesses have recorded that they either saw Taliacotius operating, or saw patients to whom he had restored noses which very closely resembled those of natural formation. The truth is that the operation which Taliacotius really performed is not commonly known; the generally-entertained notion of it being derived from the accounts of those who had some reason to misrepresent it. It will therefore be worth while to give a somewhat detailed account of it.

The work in which it is described was first published forty-four years after Taliacotius' death, with the title '*De curtorum chirurgia per insitionem libri duo, Venetiis 1597, folio.*' It is divided into two parts, of which the first is chiefly devoted to a disquisition upon the dignity of the nose, lips, and ears, and upon their offices and general construction, and the theory of the operation, which he considers to be exactly analogous to that of grafting upon trees. In the second book he describes the mode of operating, dwelling first at great length upon the necessary number and character of the assistants, the kind of bed to be used, its position with regard to light, &c., and several other minor matters, on all which he speaks like one thoroughly experienced in surgery. In the operation itself he used the following plan:—A part of the skin of the upper arm of the proper size, and bounded by two longitudinal parallel lines, being marked out over the middle of its fore part, was seized between the blades of a very broad pair of nippers. Each blade was about three inches broad, so that it might include the whole length of the portion of skin to be removed, and had a long slit near its edge through which a narrow knife could be passed. The portion of skin of which the new nose was to be formed being raised up by the assistant who held it in the nippers, Taliacotius with a long spear-shaped knife transfixed it through the slits in the blades of the nippers, and cut it through the whole length of the latter from above downwards. Through the aperture thus made, which might be compared to a very broad incision for a seton, a band covered with appropriate medicines was passed, and by being drawn a little every day, the wound was kept open like a seton wound. When all the inflammation had passed away, which was usually in about fourteen days, the flap of skin was cut through at its upper end, and thus a piece bounded by three sides of a parallelogram was raised from the arm, and remained attached to it by nothing but its fourth side or lower end. In this state it was allowed to cicatrize all over, till it acquired the character of a loose process of skin. This being, after some days, completed, and the piece of skin having become firm and hard, it was deemed ready for engrafting. The head therefore being cleanly shaved, a dress and bandage of singular construction, intended for the maintenance of the arm in its due position, were carefully fitted on. Then

these being laid aside, the seat of the old nose was scarified in a triangular space till it had a smooth bleeding surface. A pattern of this surface, being taken on paper, was transferred to the inner surface of the piece of skin on the arm, and a portion of the latter, of the same form and size, was in the same manner made raw. Sutures were placed in corresponding parts of the edges of both these wounds, and they were brought together, the arm being held up with its fore part towards the face, and the palm of the hand upon the head, by the dress and bandage already mentioned. The parts were thus retained in apposition for about twenty days, at the end of which, the surfaces having united, the bandages were taken off, and the portion of skin which was now affixed to both the face and the arm was cut away from the latter. It almost directly became white and cold, but it did not slough, and gradually increased in vascularity and heat. In about fourteen days it was usually firm and secure in its place; and as soon as this was evident, the skin was shaped into the resemblance of a nose by cutting it according to carefully-measured lines and by forming the nostrils in it. A tedious succession of operations were performed upon it before the repair was deemed complete; but at length it is said that in general the restoration was truly admirable. Taliacotius himself however admits that it had, even in the best cases, several defects.

After this account, no one can reasonably doubt that Taliacotius's operation was very often successful. That it should be superseded by the Indian method, as it is called, in which the skin for the new nose is taken from the forehead, is due to the latter being a less tedious and less painful operation, rather than to its being more certain of success. The number of instances in which later attempts to imitate the Taliacotian operation have failed, are due to its having been performed not according to the original method, but according to some of the plans which Taliacotius is erroneously supposed to have followed.

The indecent joke which Butler has made popular in his 'Hudibras' has little foundation. Taliacotius does indeed discuss the propriety of taking the skin for a new nose from the arm of another person; and he concludes that for several reasons it would, if it were possible, be better to do so: but he says he cannot imagine how it would be possible to keep two persons fastened together for the necessary time and with the necessary tranquillity, and that he never heard of the plan being attempted. The tale of the nose falling off when the original proprietor of the skin died, is founded on an absurd story which Van Helmont relates to prove at how great a distance sympathy can act. A gentleman at Brussels, he says, had a new nose made for him by Taliacotius from the arm of a Bolognese porter; and about thirteen months afterwards, as he was walking in Brussels, it suddenly became cold and dropped off, at the very instant at which the porter died at Bologna. Similar stories are told by Campanella, Sir Kenelm Digby, and others; but, as already shown, they are not even fair satires, for Taliacotius never attempted to transfer the skin of one man to the body of another.

(Bambilla, *Storia delle Scoperte fatte dagli Uomini Illustri Balsani*, vol. ii.; Sprengel, *Geschichte der Chirurgie*, Zacher Theil, p. 195.)

TALIESSIN. [WELSH LANGUAGE.]

TALIONIS, LEX, the law of retaliation; the notion of which is that of a punishment which shall be the same in kind and degree as the injury. This punishment was a part of the Mosaic Law: 'breach for breach, eye for eye, tooth for tooth: as he hath caused a blemish in a man, so shall it be done to him again' *Levit.* xxiv. 20. The name 'talio' occurs in the provisions of the Twelve Tables: it is not there defined what it means, but the signification of the term may be collected from other places. The word contains the same element as the word *talis*, 'such,' or 'like.'

TALIPAT or TALIPOT PALM. [CORYPHA.]

TALISH. [GEORGIA.]

TALISMAN an Arabic word, supposed to be derived from the Greek *talisma* τάλισμα, is a figure cast in metal or cut in stone, and made with certain superstitious ceremonies, when two planets are in conjunction, or when a certain star is at its culminating point. A talisman thus prepared is supposed to exercise an influence over the bearer, preserving him from disease, rendering him invul-

nerable in battle, and so forth. They were probably used originally to avert disease, for we find them mentioned in the history of medicine among all ancient nations. The Egyptians made use of figures of sacred animals, such as the ibis and the scarabæus, which they wore generally suspended from their necks. The Arabs and the Turks did the same, when they were idolaters; but after their conversion to Islam, they used sentences from the Koran, taken chiefly from the surah, or chapter, entitled 'The Incantation.' These they wore inscribed on rolls of vellum or paper, enclosed in a silver box, and suspended from their neck: or else engraven upon a signet ring. Military men used similar sentences from the Koran on the hilt or blade of their swords; on their shields, helmets, and other pieces of armour; or woven into their garments. Christian nations even were not exempt from this superstition. In the middle ages, relics of saints, consecrated candles, and rods, rosaries, &c. were employed, and still are, in Spain and in some parts of Italy. The African negroes have their *fetich*, and the American Indians their *medicine*.

(Reinaud, *Monuments Mussulmans du Cabinet du Duc de Blacas*, Paris, 1826.)

TALLAGE is derived, according to Lord Coke, from the law Latin word *tallagium* or *tailagium*, which, as he says, 'cometh of the French word *tailer*, to share or cut out a part, and metaphorically is taken when the king or any other hath a share or part of the value of a man's goods or chattels, or a share or part of the annual revenue of his lands, or puts any charge or burthen upon another: so as *tallagium* is a general word, and doth include all subsidies, taxes, tenths, fifteenths, or other burthens or charge put or set upon any man.' It was generally however confined in its sense to taxes received by the king. The most important statute on the subject is entitled 'De Tallagio non concedendo,' which was passed in the 34th year of Edward III. to quiet the discontent then universal throughout the kingdom. It had arisen among the commons in consequence of the king having taken a tallage of all cities, boroughs, and towns without the assent of parliament. He was embroiled also with the nobles and landowners, from having attempted, unsuccessfully however, to compel all freeholders of land above the value of twenty pounds to contribute either men or money towards his wars in Flanders. The first chapter of the statute is the most important: 'Nullum tallagium vel auxilium per nos, vel heredes nostros in regno nostro ponatur, seu levetur sine voluntate, et assensu archiepiscoporum, episcoporum, comitum, baronum, militum, burgensium, et aliorum liberorum communium de regno nostro.' 'No tallage or aid may be set or levied by us or our heirs in our kingdom without the good will and assent of the archbishops, bishops, counts, barons, knights, burgesses, and other free men of the commons of our kingdom.'

These words, as Lord Coke says, are 'plain without any scruple, absolute without any saving; and, if there could have been perfect reliance on their operation, must have been entirely satisfactory. But the same king had just violated almost the same engagements entered into by himself only six years before. (25 Edward I., c. 5, 6, 7. 'Confirmationes Chartarum' 2 *Inst.*, 530. [SUSSEX.]

TALLEYRAND-PERIGORD, CHARLES MAURICE DE. This extraordinary man is, and must long, perhaps forever, continue a mystery. In the *Éloge* of M. de Renouard, pronounced by M. de Talleyrand, in the *Académie des Sciences Morales et Politiques*, only three months before his own death, he said: 'A minister for foreign affairs must possess the faculty of appearing open, at the same time that he remains impenetrable; of being in reality reserved, although perfectly frank in his manners.' The precept was his own portrait. His power of concealing his opinions, and his steady adherence to the principle of allowing attacks upon his character to dissipate by time for want of opposition, have had the effect of keeping his contemporaries ignorant of his real character. This taciturnity has frequently occasioned his being subject to imputations which he did not deserve; at times it has beyond a doubt acquired for him a reputation for ability greater than he deserved. It is believed that M. de Talleyrand has left memoirs of his life, or at least of the most important transactions in which he was engaged, but with strict injunctions that they shall not be published until thirty years shall have elapsed from the time of his death. If this be

true, even when the public shall have been put in possession of the contents of these papers, it will only have acquired another statement in addition to those previously in its possession, by the comparison of which it must have to guess at the truth. At present however, while these memoirs continue a sealed book, and scarcely any of M. de Talleyrand's intimate friends have yet contributed their fragments of information, no resource is left to the biographer but by collating his writings, his ostensible share in the politics of his age, and the incidental communications of himself or his acquaintances to estimate as near as he can what probable foundation in reality there is for the accounts of M. de Talleyrand, which have been compiled from what may be called public gossip.

Charles Maurice de Talleyrand-Périgord was born on the 13th of February, 1754, the eldest of three brothers. His family was ancient and distinguished; but he was neglected by his parents, and placed at nurse in one of the faubourgs of Paris. The effects of a fall when about a year old rendered him lame for life, and being on this account unfit for the military career, he was obliged to renounce his birthright in favour of his second brother, and enter the church. The contempt and aversion for him, which his parents did not attempt to conceal, impressed a gloomy and taciturn character on the boy. From the charge of his nurse he was transferred to the Collège d'Harcourt, and thence successively to the seminary of St. Sulpice and to the Sorbonne. In all of these institutions he maintained the character of a shy, proud, bookish lad. He showed in after-life a taste for literature, and such an extensive acquaintance with and appreciation of science as sits gracefully on the statesman; and the taste and knowledge must have been acquired at an early age, for his turbulent career after he was fairly launched into busy life left little leisure for that purpose.

By the time he had attained his twentieth year his reputation for talent and his confirmed health appear to have reconciled the vanity of his parents to the necessity of acknowledging him. They introduced him to the society of his equals in rank for the first time at the festivities with which the coronation of Louis XVI. was celebrated (1774), under the title of the Abbé de Périgord. His opinions and tastes, and his temperament, combined to render the clerical profession an object of detestation to him, but he could not escape from it. He availed himself to the full extent of the indulgence with which his age and country regarded the irregularities of the young and noble among the priestly order; but the pride and reserve with which twenty years of undeserved neglect had inspired his confident and strong character served him in part as a moral check. He was a strict observer of the appearances exacted by the conventional morality of society; and this good taste exerted a powerful influence over his whole future career. Thrown back upon himself from the beginning, he had necessarily become an egoist; vigorous both in mind and body, he had a healthy relish of pleasure, and he engaged with eagerness in the pursuits of pleasure; but the enjoyments of the mere voluptuary were insufficient for one of his intellectual character and fastidious tastes.

In 1776 Voltaire visited Paris. M. de Talleyrand was introduced to him, and the two interviews he had with him left such a deep impression that he was accustomed to talk of them with a lively pleasure till the close of his life. Voltaire and Fontenelle were M. de Talleyrand's favourite authors; upon whom he formed his written and still more his conversational style. Conversational talent was in great demand at Paris when he entered the world, and both his love of pleasure and his love of power prompted him to cultivate that which he possessed. That he did so with eminent success the concurrent views of the best judges of his age declare. Excellence of this kind is like excellence in acting: it is impossible to convey an adequate impression of it to posterity. The reporters of flashes of wit and felicitous turns of conversation uniformly communicate to them something of their own inferiority, and vulgarise them in the telling. Again, superior excellence in conversation is an art; the artist is and ought to be judged not by his materials, but by the success with which he uses them. Written *bon mots* are necessarily estimated by their originality, the quantity and quality of thought expressed in them: they are judged as we judge the writings of a poet: whereas the person who introduces them with

effect in conversation ought to be judged as we judge the actor, of whom we do not think less because he merely says what the poet has put into his mouth.

The robust and healthy Epicurean who requires the stimulus of intellectual in addition to physical pleasures, is almost inevitably driven to seek the former in the pursuits of ambition. M. de Talleyrand was no exception to the general rule. And the Abbé de Périgord must have displayed, even when he was apparently, when perhaps he believed himself to be, living only for pleasure, qualities which inspired a belief in his business capacity; for in 1780, while yet only in his twenty-sixth year, he was appointed general agent of the clergy of France. He discharged the functions of this important office for eight years. The Gallic church was all along the most independent in its relations to the Papal chair of any church that remained in communion with Rome. It was also a powerful church viewed in its relations to the state, of which it formed an element. Its revenue derived from landed property was large, that derived from other sources perhaps still larger: it had regular assemblies in which it legislated for itself, determined what contributions it ought to pay to the state, and in what proportions its members were to be assessed. Here was a wide field for cultivating experimentally a talent for administration. Nor was this all: the dignified clergy of France took an active part in secular politics. There is a passage in the éloge of M. de Reinhard already alluded to, which seems an echo of the impressions received by M. de Talleyrand in this period of his life:—'I will hazard the assertion that his (M. de Reinhard's) first studies had been an excellent preparation for the diplomatic career. The study of theology in particular had endowed him with a power, and at the same time with a dexterity of ratiocination, which characterise all the documents which have proceeded from his pen. To guard myself against the charge of indulging in paradox, I must here enumerate the names of some of our most distinguished statesmen, all theologians, and all distinguished in history for the success with which they conducted the most important political transactions of their times.' And he follows up the remark with a very respectable list. The general agent of the clergy was their minister of state: and M. de Talleyrand, while he continued to fill the office, was a powerful subject, and occupied a conspicuous place in the eye of the public. In 1788 he was appointed bishop of Autun.

The commencement of his political career, in the strict acceptance of the term, is synchronous with this promotion. An article upon M. de Talleyrand in an early number of the 'Edinburgh Review'—the materials for which were furnished by Dumont,—asserts that he owed his advancement to the see of Autun to a 'discours sur les Loteries,' which he pronounced in his capacity of agent for the clergy of France, in the Assembly of Notables which met at Versailles, in February, 1787. As bishop of Autun he was a member of the États Généraux convoked in May, 1789, which continued to sit as an Assemblée Constituante till it dissolved itself on the 30th of September, 1791. The interval from the meeting of the Notables till the dissolution of the Assembly is an important one in any attempt to solve the problem of M. de Talleyrand's real character.

Previously to the meeting of the States-General, M. de Talleyrand indicated the course he intended to pursue, in a discourse which he addressed to the assembled clergy of his diocese; and in which he advocated the equality of all citizens in the eye of the law, and free discussion. When the three orders, by assenting to meet as one body, had enabled the Assembly to proceed to business, the precise directions given by many of the baillages to their deputies were found an impediment in the way of practical legislation: M. de Talleyrand moved that they should be entirely disregarded, and carried his motion. A constituent committee was appointed immediately after the capture of the Bastille, and he was the second person nominated a member of it. In this capacity he was called upon to take part in maturing measures which have had a lasting influence upon the progress of affairs in France: the first of these was the re-distribution of the national territory into districts better adapted than the old provinces for the purposes of government; the second was, the organization of a system of finance. In the financial discussions which took place in the committee and Assembly, M. de Talleyrand retained

his dislike of lotteries. He supported all or most of the various loans proposed by Necker; and seconded Mirabeau's exhortations to keep faith with the national creditor. He suggested practical measures with a view to this end, and among others the sale of church lands: he had previously supported the abolition of tithes, reserving however a competent provision for the priesthood, and even improving the condition of the poorer clergy. He also proposed to establish a *casse d'amortissement*, as an additional guarantee to the state's creditors. The task of making arrangements for levying the part of the revenue derived from taxes upon persons exercising professions, and upon transfers of property, devolved upon M. de Talleyrand. Connected with his labours in preparing a new territorial division of France, and a new method of collecting the national revenue, was the motion which he made and carried in the Assembly, in August, 1790, to the effect that the king should be intreated to write to his Britannic majesty, to engage the parliament of England to concur with the National Assembly in fixing a natural unit of weights and measures; that, under the auspices of the two nations an equal number of commissioners from the Academy of Sciences and the Royal Society of London might unite to determine the length of the pendulum in the latitude of 45°, or in any other latitude that might be thought preferable, and to deduce from thence an invariable standard of weights and measures. At the same time that he was taking part with his colleagues of the Constituent Committee in these labours he was charged by them with the important task of preparing the report upon national education, which was read to the Assembly on the 10th, 11th, and 19th of September, 1791. The basis of the system advocated in this report was the secularization of instruction: education was to be the gift of the state, not of the church; the state was to provide instruction for those who proposed to enter the church, exactly as it was to provide instruction for those who proposed to enter any of the other learned professions. Equal stress was laid upon the establishment of elementary schools in every canton; and of a higher class of schools, for the benefit of those who were not destined to embrace a learned profession, in the chief town of every district. Two acts of M. de Talleyrand, which have been much commented upon, appear to be as it were necessary collaries of the principles avowed in the legislative career we have been passing in review:—his appearance as principal actor in the theatrical celebration of the anniversary of the capture of the Bastille; and his taking upon him the office of consecrating the national clergy.

It is absolutely necessary that some estimate be formed of the conduct and character of M. de Talleyrand while a member of the first National Assembly, as a guide to an appreciation of his far more enigmatical subsequent career. M. de Talleyrand entered the Assembly with the reputation of a dexterous negociator, which he had acquired in his discharge of the office of agent to the clergy. He had then, and he retained in after-life, the character of a self-indulgent man, of a man with a large instinct of self-preservation, but also of a humane man. The disciple of Voltaire and Fontenelle could scarcely be a very zealous Christian, but M. de Talleyrand had always been a respecter of conventional morality: his was precisely that kind of disposition and intellect that supports a church not from belief, but as a useful engine for preserving order in society. M. de Talleyrand, like all the literati of his day, had a theoretical belief in the equality of men: at the same time that with regard to the privileges of the nobility, he was inclined to support them in the same way that he did the authority of the church—as a useful political engine. But involuntarily and perhaps unconsciously M. de Talleyrand was a warmer partisan of the aristocracy than the clergy: he was noble by birth and attached by taste to the habits of a select society, whereas the ecclesiastical character forced upon him against his will had something repulsive to him. In short, M. de Talleyrand saw clearly the rottenness and the absurdity of many of the old institutions of his country: he was willing, desirous, that government should be organized and act in a manner to promote the general happiness; but he had no faith in the capacity of men for self-government; and he had been educated in a church, many of whose members were at that time obliged to reconcile their consciences to remaining in it by adopting the maxim that they were deceiving

men for their own good. M. de Talleyrand's idea, and he entertained it in common with a considerable number, was, that the Revolution might be guided, checked, and rendered useful by approximating the constitution of the French to that of the English government. He cared little for the creed of the church, but he wished to preserve the church, and to render it in France what the established church was in England. Hence his care, even while laying hands on the property of the church for the exigencies of the state, to retain an adequate provision for the clergy: hence his anxiety to identify the clergy with the nation. His anxiety to establish a constitution modelled upon that of England was always avowed. His views, the views he adopted, it is not meant to attribute originality to them, regarding territorial divisions and the organization of local government, finance, and education, though overborne for a time in the storm of the Revolution, have revived and been adopted by the Empire, the Restoration, and the present dynasty. The recklessness as to the means by which he attained his ends which he displayed even at this period of his career is no evidence of insincerity, but merely of the want of faith in men, which the treatment he had experienced in early life, and his observation of the society he habitually mixed in, had instilled into him. It was his weakness through life to pride himself in the display of his power of refined mockery, regardless of the enemies it created: he gave vent to his spirit of raillery in actions as well as in words; and thus lent a grotesque colouring to his *coups d'état*, which rendered them more startling than if they had been as prosaic as those of other men. The world is perhaps less startled with the atrocity of passion in a statesman, than with a laughing air which shows his contempt for it. The most startling of his devices is his solemn inauguration of the constitutional monarchy by the religious celebration of the 14th of July. But the love of theatrical presentation and the delusive belief that good may be effected by it is strong in every man at some period of his life. Talleyrand in all likelihood looked forward at that moment to being the founder and future primate of a church which should be to France what the Anglo-Episcopal has been to England. The means to which he was driven to have recourse in order to carry through the installation of the national bishops, undecieved him, and brought back his early disgust for the profession with redoubled force. He not long after resigned his bishopric of Autun, and at the same time renounced his ecclesiastical character.

The history of M. de Talleyrand from the dissolution of the Constituent Assembly, in September, 1791, till the overthrow of the monarchy, on the 10th of August, 1792, would be instructive were it merely as a demonstration of the folly of the self-denying ordinance with which that body terminated its career. Its members were declared ineligible to the next assembly, and also incapable of receiving any appointment from the crown until two years had elapsed from the date of its dissolution. The consequence was, that M. de Talleyrand among others was rendered incapable of any legislative or ministerial office. It was at that time an object with all who desired that the Revolution should have fair play, to preserve peace with England, which, although still ostensibly neutral, was every day presenting additional symptoms of alienation. The court party hated M. de Talleyrand for having taken part frankly with the Revolution; the republicans hated him for his advocacy of a limited monarchy: all parties distrusted him on account of his eternal sneer; but all parties agreed that he was the only man whose talents fitted him for the delicate mission to England. And it was impossible to appoint him to it. He was dispatched however, in January, 1792, without any ostensible diplomatic character, to sound the English ministry, and attempt to commence negotiations. His want of an official character allowed the queen to indulge her feelings of personal dislike to the ex-bishop of Autun by turning her back upon him when he was presented at St. James's; and this reception at once ensured his exclusion from general society, and rendered him powerless. After the accession of the Gironde to office, the attempt to ensure at least neutrality on the part of England was renewed: Chauvelin was sent to England as nominal, and along with him Talleyrand as real ambassador. By this time however the French government had become as obnoxious to the general public of England as to the court circles: the torrent was probably

ng to have been stemmed by Talleyrand, even he had been in a condition to act directly and in

He could do nothing, forced as he was to act by the immutability of a man too jealous and opinionative to own honestly to the directions of one whose will necessarily made him feel himself a mere puppet. His good faith at this period in labouring to pre-arrange between England and France, as the only means of rendering a constitutional monarchy possible in either country, and the steadiness with which he pursued his object, undaunted by the most gross personal attacks, are satisfactorily established by the narrative of

Talleyrand was at Paris when the events of the 10th of August put an end to the monarchy; and it required all his activity to enable him to obtain passports from Danton, which saved him to quit Paris. He fled to England, and saved little of his property, he was obliged to leave his library there to procure himself the means of subsistence. The English government, jealous of his power, some time ordered him to leave the country in twenty-four hours; and proscribed in France, he was obliged with a dilapidated fortune, to seek refuge in America, which he had almost attained his fortieth year.

M. de Staël has claimed, and apparently with a good reason, the credit of instigating Chenier to demand the fall of M. de Talleyrand after the fall of Robespierre and the end of the reign of terror. The National Institute was founded about this time, and M. de Talleyrand in his absence been appointed a member of the class of letters and political science. At the first sitting of this class which he attended he was elected secretary, an office which he held for six months. During this period he wrote several papers, afterwards published in the *Mémoires de des Sciences Morales et Politiques de l'Institut*, which are justly considered not only as the most original of his published writings, but as those which are most indisputably his own. The first of these is an *Essai sur les Avantages à retirer de Colonies dans les Circonstances présentes*; the second, *Des sur les relations Commerciales des Etats-Unis d'Amérique.* The latter is, properly speaking, a dissertation—perhaps rather a 'pièce justificative' applied to the other. The great object of both is to point out the importance of colonies to a country like France, and the revolutionary fervour, though beginning to wane, was still sufficiently powerful to prolong the reign of terror and suffering, unless measures were adopted to put an end to it. There can be no mistake as to the views of M. de Talleyrand himself. They are such only to occur to a person entertaining the political views he had advocated in the Constituent Assembly, and who had been exiled by the 'reign of terror' which decimated his countrymen, was living in a country where a revolution had quietly and speedily subsided into a system of government; in a country where he felt that a stranger becomes at once a native, and a Frenchman never a foreigner. Not satisfied with pointing out the manner colonies might be rendered powerful assistants in tranquillising France, the essayist entered deeply into the principles of colonization, explaining the advantages derived from colonies, and the law by which the political advantages might be perpetuated even in the political relations with the mother-country had in his treatment of his subject he evinces a clear insight into the structure of society both in America, and just and extensive views in political economy.

Not however so much the political talent displayed in his essays, as M. de Talleyrand's skill in employing his influence of the salons of Paris, that obtained the appointment of foreign minister under the Directory. Here again he was indebted to Madame de Staël, led him through her influence with Barras. M. de Talleyrand accepted office under this unprincipled government with a perfect knowledge of its character and its

His conviction that a Frenchman could never be in America prompted him to grasp at the first opportunity of returning to his native country: his shrewdness and taste for expensive luxuries rendered it necessary for him, and political business was the lucrative employment for which he was qualified. Nothing in his life to contradict the belief that he

again engaged in politics with a desire to promote what was right and useful as far as he could; but he engaged in them aware that he might be ordered to do what he disapproved of, and prepared to do it, under the plea that his functions were merely ministerial, and that the responsibility rested upon his employers. His position under the Directory was consequently an equivocal one. He was engaged, so long as he occupied it, in intrigues which had for their aim the maintenance of himself in office, even if his employers should be turned out; and he was obliged to do their dirty work. The part which he took in the attempt to extort money, as a private gratification, from the American envoys who arrived in Paris in October, 1797, was probably forced upon him by the directors: had it been his own project, it would have been conceived with more judgment, and the Americans would not have been driven to extremes, for he understood their national character. But allowing himself to be used in such a shabby business betrays a want of self-respect, or a vulgarity of sentiment, or both. He had his reward; for when public indignation was excited by the statements of the American envoys, the minister of foreign affairs was sacrificed to the popular resentment.

Having adopted a profession in which success could only be expected under a settled government, believing a monarchical government to be the only one which could give tranquillity to his country, and anxious with many others to run up a make-shift government out of the best materials that offered, he naturally attached himself to the growing power of Bonaparte. When the future emperor returned from Egypt, M. de Talleyrand had been six months in a private station; though, had he still retained office, he might with equal readiness have conspired to overturn the Directory. Bourrienne is not the best of authorities, but the earlier volumes of the memoirs which pass under his name are less falsified than the later; and an anecdote which he relates of Talleyrand's interview with the first consul, after being reappointed minister of foreign affairs, is so characteristic, that its truth is highly probable:—"M. de Talleyrand, appointed successor to M. de Reinhart at the same time that Cambacérès and Lebrun succeeded Sieyès and Roger Ducas as consuls, was admitted to a private audience by the first consul. The speech which he addressed to Bonaparte was so gratifying to the person to whom it was addressed, and appeared so striking to myself, that the words have remained in my memory:—"Citizen Consul, you have confided to me the department of foreign affairs, and I will justify your confidence; but I must work under no one but yourself. This is not mere arrogance on my part: in order that France be well governed, unity of action is required: you must be first consul, and the first consul must hold in his hand all the main-springs of the political machine—the ministries of the interior, of internal police, of foreign affairs, of war, and the marine. The ministers of these departments must transact business with you alone. The ministries of justice and finance have, without doubt, a powerful influence upon politics; but it is more indirect. The second consul is an able jurist, and the third a master of finance: leave these departments to them; it will amuse them; and you, general, having the entire management of the essential parts of government, may pursue without interruption your noble object, the regeneration of France." These words accorded too closely with the sentiments of Bonaparte to be heard by him otherwise than with pleasure. He said to me, after M. de Talleyrand had taken his leave, "Do you know, Bourrienne, Talleyrand's advice is sound. He is a man of sense." He then added smilingly:—"Talleyrand is a dexterous fellow; he has seen through me. You know I wish to do what he advises; and he is in the right. Lebrun is an honest man, but a mere book-maker; Cambacérès is too much identified with the Revolution: my government must be something entirely new."

Napoleon and Talleyrand may be said to have understood each other, and that in a sense not discreditably either. The good sense of both was revolted by the bloodshed and theatrical sentiment, the blended ferocity and coxcombry of the Revolution: both were practical statesmen, men with a taste and talent for administration, not mere constitution-makers. Like most men of action, neither of them could discern to the full extent the advantage an executive government can derive from having the line of

action to a considerable extent prescribed by a constitution; but Talleyrand saw better than Napoleon that the laws which protect subjects by limiting the arbitrary will of the ruler, in turn protect him by teaching them legitimate methods of defending their rights. In another respect they resembled each other—neither was remarkably scrupulous as to the means by which he attained his ends; though this laxity of moral sentiment was kept in check by the natural humanity of both. Their very points of difference were calculated to cement their union. The observant self-centred mind of Talleyrand was lamed by its want of power to set others in motion: it is only through sympathy that the contagious love of action can be conveyed. The impassioned and imaginative soul of Napoleon was made to attach others to him and whirl them along with him; and this power was often too strong for itself: Napoleon, though capable of reflection, was too often hurried away by his instinctive impulses. Each of these men felt that the other was a supplement to himself. Talleyrand really admired and appreciated Napoleon. If he flattered him, it was by the delicate method of confirming him in the opinions and intentions which met his approbation. He dared to tell the First Consul truths which others were afraid to utter; and he ventured to arrest at times the impetuosity of Napoleon, by postponing the fulfilment of his orders until he had time to cool. He opposed, as long as there was any prospect of success, the divorce from Josephine; but his virtue gave way in the business of the Duke d'Enghien, for even though we exculpate him from participation in the execution of that prince, to gratify his master he sanctioned the violation of a neutral territory. This was however the only instance, in so far as Bonaparte is concerned, of his sacrificing the duty of a friend to flattery that can be brought home to him. Napoleon's frequent recurrence, in his conversations at St. Helena, to the subject of Talleyrand's defection, his attempts to solve the question at what time that minister began to betray him, show his appreciation of the services he had received from him.

For a time their alliance continued harmonious, and that was the time of Napoleon's success. The arrangement of the Concordat with the pope was the basis of the future empire, and that negotiation was accomplished by Talleyrand. The treaty of Lunéville, secularising the ecclesiastical principalities of Germany; the treaty of Amiens, recognising on the part of England the conquests of France, and the new form given to the Continental states by the Revolution; the convention of Lyon, which gave form to the Cisalpine republic; all bear the impress of the peculiar views of M. de Talleyrand. And the minister of foreign affairs was fully aware of his own consequence. In 1801, when obliged by the state of his health to use the waters of Bourbon l'Archambault, he wrote to Napoleon:—I regret being at a distance from you, for my devotion to your great plans contributes to their accomplishment. After the battle of Ulm, Talleyrand addressed to the emperor a plan for diminishing the power of Austria to interfere with the preponderance of France, by uniting Tyrol to the Helvetic republic, and creating the Venetian territory into an independent republic interposed between the kingdom of Italy and the Austrian territories. He proposed to reconcile Austria to this arrangement by ceding to it the whole of Wallachia, Moldavia, Bessarabia, and the northern part of Bulgaria. The advantages contemplated from this arrangement were that of removing Austria from interfering in the sphere of French influence without exasperating it, and that of raising in the East a power better able than Turkey to hold a balance with Russia. Napoleon paid no attention to the proposal. After the victory of Austerlitz, Talleyrand again pressed it upon his notice, but equally without effect. No change in the feelings of the emperor and his minister can positively be traced to this event; but we see on the one hand a particular rejection of a favourite proposal, and on the other a silent and rather contemptuous rejection of it. We find at a much later period Napoleon complaining of the premisses with which Talleyrand was accustomed to repeat any advice which he considered important; at the same time Talleyrand speaking of Napoleon as one who could not be served because he would not listen to advice. And we cannot but see in the difference of opinion just mentioned the commencement of that coolness which induced Talleyrand, on the 9th of August, 1807, to resign the portfolio of

foreign affairs and accept the nominal dignity of vice-grand-elector of the empire in addition to the titles of grand-chamberlain and prince of Benevento, which had previously been conferred upon him. An unprecedented career of victory had rendered Napoleon impatient of success; the consciousness of important services had rendered Talleyrand impatient of neglect; and the alienation thus originated was increased and confirmed by the dashing but vulgar soldiers, who formed such an influential part of the emperor's court, and their silly and vulgar wives, who could not pardon M. de Talleyrand his superior refinement, and who had all in turn smarted under his insupportable sarcasm. Napoleon in exile is said to have represented the resignation of M. de Talleyrand as involuntary, and rendered necessary by his stock-jobbing propensities. It is not impossible that the minister may have speculated more deeply in the funds than was altogether proper; but had there been no other reason for his dismissal, Napoleon could, and often did, wink at more flagrant pecuniary delinquencies. M. de Talleyrand, in his character of grand-chamberlain, did the honours of the imperial court at Erfurt; and was on more than one occasion privately consulted by the emperor, who one day said, "We ought not to have parted." In 1809 however the ex-minister was so loud and unreserved in his condemnation of the Spanish expedition, that Napoleon, on his return from the Peninsula, deprived him of the office of chamberlain. The last five years of the empire elicited many caustic criticisms from M. de Talleyrand, which were duly carried to the ears of the emperor, who retorted by sallies of abuse which irritated the prince without rendering him less powerful. In 1812 M. de Talleyrand is said to have predicted the overthrow of the empire. In 1813 overtures were made to him with a view to his resuming the portfolio of foreign affairs, but without success. In 1814 he re-appeared on the stage of active life on his own account.

In 1814, as vice-grand-elector of the empire, he was a member of the regency, but was prevented joining it at Blois by the national guard refusing to allow him to quit Paris—not much against his will. When Paris capitulated, the emperor Alexander took up his residence in the house of the prince of Benevento. The words attributed by the Memoirs of Bourrienne to Talleyrand, in his conversations with those in whose hands the fortune of war had for the time placed the fortunes of France, are characteristic, true, and in keeping with his opinions and subsequent conduct:—There is no other alternative but Napoleon or Louis XVIII. After Napoleon there is no one whose personal qualities would ensure him the support of a nation. A principle is needed to give consistency to the new government, whatever it may be; Louis XVIII. respects a principle. Anything but Napoleon or Louis XVIII. is an intrigue, and no intrigue can be strong enough to support him upon whom it might confer power. This view leads consistency to the conduct of M. de Talleyrand at the close of Napoleon's career. Their alliance had long been dissolved; they stood confronting each other as separate and independent powers. M. de Talleyrand had advocated a limited monarchy, until the old throne was violently broken up and overturned; he had been obliged to construct a new monarchy and a new aristocracy out of the fragments of old institutions which the Revolution had left; he saw France again without a government, and, with his principles, he might have consistently taken refuge under any government, holding, as he did, the opinion that any government is better than none, and that any man may hold office under it provided he take care to do as much good and as little harm as he can. But M. de Talleyrand did more: he exerted the influence he possessed over Alexander to obtain the confirmation of constitutional forms with the recognition of legitimacy. Louis XVIII. saved appearances by insisting upon being allowed to grant the charter spontaneously, but it was M. de Talleyrand's use of the remains of the revolutionary party that made him feel the necessity of this concession. As minister Talleyrand insisted upon its observance with a precision that rendered him as much an object of aversion to the courtiers of the Restoration as ever the pedantic Chamberlain was to the gay triflers who surrounded Charles II. When he set out for the congress of Vienna, in September, 1814, the court of France is said to have presented the aspect of a school at the commencement of the holidays. The powers who had refused to concede to Napoleon a

of a victorious army anything beyond the limits in 1792, gave more favourable terms to M. de Talleyrand, the representative of a nation upon which they were to place a king. He baffled the emperor Alexander, angrily, 'Talleyrand conducts himself as if he were the minister of Louis XIV.' On the 5th of January, 1815, with Lord Castlereagh and Prince Metternich, having previously obliged Prussia to remain with a third of Saxony, and Russia to cede a grand-duchy of Warsaw. The imbecility of the emperor, by inviting the descent of Napoleon at Frejus, settled everything. M. de Talleyrand dictated the constitution of Cambrai, in which Louis XVIII. consented to the peace, and promised to make no further demands.

He suggested the more liberal interpretation of the constitution, announced from the same place. He objected to the extension of the democratic principle in the Chamber of Deputies, recommended the peerage hereditary, and induced the emperor to appoint a second time, to institute a cabinet which he was nominated the first president.

Constitutional monarchy, the object of his earlier efforts, was now definitively established; but the part he had to perform in it was that of a leader of opposition. In his note of the 21st of September, 1815, he proposed to the emperor, against the new terms which he had offered to impose upon France. He said they were conditions as only conquest could warrant. 'There is no conquest where the war has been carried on by the possessor of the territory, that is, the sovereign; and sovereignty being identical. But when war is carried on against a usurper in behalf of the legitimate sovereign, there can be no conquest; there is only the re-conquest of the territory. But the high powers have viewed the act of Bonaparte in the light of an act of usurpation, and Louis XVIII. as the real sovereign of France: they acted in support of the king's rights, and ought to be held to them. They contracted this engagement by the constitution of the 13th and their treaty of the 25th of July, 1801, in which they admitted Louis XVIII. as an ally against a common enemy. If there can be no conquest, there can be no more war; and henceforth the only object of war is to be fruitless: Louis XVIII. bowed to the emperor, and his powerful allies; and M. de Talleyrand resigned his office two months before the conclusion of the treaty of Fontenoy, and secured the frontiers of France and amerced her contribution. By this step M. de Talleyrand endeavoured to contribute essentially to strengthening constitutional monarchy, to which, if he had any pride in his life preserved his attachment. Had he been party to the treaty, he must have shared with the emperor and the Bourbons the odium which attached to it; and hence thrown the opposition into the hands of the enemies of the constitution. In his office, he obtained a voice potential in the Chamber of Deputies; and no English nobleman could have discharged the duties of an opposition leader. For his salon was a place of resort for the liberal party; in society he aided it by his talents; in the chamber of peers he supported it by the weight of his name and experience. He defended the liberty of the press in opposition to the emperor's supported trial by jury in the case of offences committed in the internal affairs of Spain in 1823. In his office of conduct he was materially instrumental in creating a liberal party within the pale of the Chamber of Deputies; and to the existence of such a party was, in a small degree the result of the revolution of 1830, which, though the dynasty was changed, the constitution survived in its most important outlines. That also placed Prince Talleyrand in a condition to fulfil what had been one of his most earnest wishes at the close of his political career—an alliance between England and constitutional governments. To this he had laboured strenuously in 1792; to this was one of the first objects he aimed at when he became minister for foreign affairs under the emperor, and he accomplished it as representative of Louis

Philippe Talleyrand was appointed ambassador extraordinary and plenipotentiary to the court of Great

Britain on the 5th of September, 1830; and he held the appointment till the 7th of January, 1835, when he was succeeded by General Sebastiani. During these four years M. de Talleyrand, besides obtaining the recognition of the new order of things in France by the European powers, procured a similar recognition of the independence of Belgium, and concluded the quadruple alliance of England, France, Spain, and Portugal, for the purpose of re-establishing the peace of the Peninsula.

After his return from the mission to England, M. de Talleyrand retired from public life. The only occasion on which he again emerged from domestic retirement was when he appeared at the Académie des Sciences Morales et Politiques, to pronounce the *éloge* of Count Reinhard, only three months before his own death. He died on the 20th of May, 1838, in the eighty-fourth year of his age.

The object of this sketch has been to present, as far as the very imperfect materials which are attainable would permit, a view of this very extraordinary man undistorted by any partisan feeling either with regard to his person or principles. It must be admitted in favour of M. de Talleyrand that he was warmly beloved by those who were his intimate friends, and by all who were at any time employed under him. It must also be allowed that when his life is contemplated as a whole, it bears the imprint of a unity of purpose animating his efforts throughout. Freedom of thought and expression, the abolition of antiquated and oppressive feudal forms and the most objectionable powers of the church, the promotion of education, the establishment of a national religion, and a constitutional government compounded of popular representation and an hereditary sovereign and aristocracy—these were the objects he proposed for attainment when he entered the arena of politics. He attempted to approach this ideal as far as circumstances would admit at all periods of his long career; and he ended by being instrumental in establishing it. No act of cruelty has been substantiated against him; and the only charges of base subserviency that appear to be satisfactorily proved, are his participation in the attempt to extort a bribe from the American envoys, and in the violation of an independent territory in the seizure of the Duc d'Enghien. His literary was subordinate to his political character. It is difficult to say how much of the writings published in his name were really his own. Lately, we are informed upon good authority, he was in the habit of explaining his general views on a subject to some one whom he employed to bring this communication into shape; and when the manuscript was presented to him, he modified and retouched it until it met his views, throwing in a good deal of that wit which gave zest to his conversation. The domestic life of M. de Talleyrand has not been alluded to; for almost every statement regarding it is poisoned by the small wit of the coteries of Paris.

The report upon education of 1791; a report to the first consul upon the best means of re-establishing the diplomatic service of France; the essays upon colonization, and the commercial relations of England and America; and the *éloge* of M. de Reinhard—may all be regarded as his own composition. The first is the most commonplace; the other three are master-pieces in their different ways. They bespeak an elegant and accomplished mind, a shrewd insight into character and the structure of society, and a felicitous and graphic power of expression. The wit of M. de Talleyrand was the wit of intellect, not of temperament. It was often full of meaning; always suggestive of thought; most frequently caustic. His reserve, probably constitutional, but heightened by the circumstances of his early life, and cultivated upon principle, was impenetrable. In advanced life it seemed even to have affected his physical appearance. When at rest, but for his glittering eye, it would have been difficult to feel certain that it was not a statue that was placed before you. When his sonorous voice broke upon the ear, it was like a possessing spirit speaking from a graven image. Even in comparatively early life, his power of banishing all expression from his countenance, and the soft and heavy appearance of his features was remarked as contrasting startlingly with the manly energy indicated by his deep powerful voice. Mirabeau in the beginning, Napoleon at the close of the Revolution, threw him into the shade; but he outlasted both. The secret of his power was patience and pertinacity; and his life has the appearance of being preternaturally lengthened out when we recollect

the immense number of widely removed characters and events of which he was the contemporary. It may be said on the one hand that he accomplished nothing which time did not in a manner bring about; but on the other it may be said, with equal plausibility, that scarcely any of the leading events which have occurred in France in his day would have taken the exact shape they assumed had not his hand interfered to give them somewhat of a bias or direction. Next to Napoleon, he certainly is the most extraordinary man the revolutionary period of France has given birth to.

Études et Portraits Politiques, par A. Mignet, Bruxelles, 1841, pp. 131-194; *Rapport sur l'Instruction Publique fait au nom du Comité de Constitution à l'Assemblée Nationale, les 10, 11, et 19 Septembre, 1791*, par M. de Talleyrand, Paris, 1791-4; *Edinburgh Review*, vols. vi. and vii.; *Mémoires par Etienne de Dumont; Correspondance between the Envoys of the American States and M. de Talleyrand, Minister for Foreign Affairs in France*, London, 1798, 12mo.; *Considérations sur les principaux Evénemens de la Révolution Française*, par Mme. la Baronne de Staël; *Dir. Années d'Éril*, par la même; *Mémoires par A. L. F. de Bourienne*, Paris et Londres, 1831; *Mémorial de St. Hélène; Mémoires pour servir à l'Histoire de France sous Napoléon*, par MM. les GG. Montholon et Gourgaud; *Eloge de M. le Comte de Reinhard prononcé à l'Académie des Sciences Morales et Politiques*, par M. le Prince de Talleyrand, dans la Séance du 3 Mars, 1838, Paris, 1838.)

TALLIS, THOMAS, who is considered the patriarch of English cathedral music, was born at about the same period as the famous Italian ecclesiastical composer Palestrina, whose birth took place in the year 1520.

It has been stated, but most probably erroneously, that Tallis was organist to Henry VIII. and his successors. He undoubtedly was a gentleman of the chapel to Edward VI. and Mary; and under Elizabeth the place of organist was added to his other office. He seems to have devoted himself wholly to the duties of the church, for his name does not appear to anything in a secular form. His entire Service, including prayers, responses, Litany, and nearly all of a musical kind comprised in our liturgy, and in use in our cathedrals, appears in Dr. Boyce's Collection, together with an anthem which has long been in high repute with the admirers of severe counterpoint. But for the smaller parts of his Service he was indebted to Peter Marbeck, organist of Windsor, who certainly is entitled to the credit of having added those solemn notes to the suffrages and responses which, under the name of Tallis, are still retained in our choirs, and listened to with reverential pleasure. [MARBECK.]

In 1575 Tallis published, in conjunction with his pupil, Bird (or Byrde), *Cantiones Sacre*, master-pieces of their kind; and these are rendered the more remarkable from

having been protected for twenty-one years by a patent from Queen Elizabeth, the first of the kind that ever was granted. One of these, 'O sacrum convivium,' was adapted by Dean Aldrich to the words 'I call and cry,' and is the above-mentioned anthem, which still continues to be frequently performed in most of our cathedrals. Two more of his anthems are printed in Dr. Arnold's Collection.

Tallis died in 1585, and was buried in the parish church of Greenwich, in the chancel of which Strype, in his continuation of Stowe's *Surrey*, tells us he saw a brass plate, on which was engraved, in old English letter, an epitaph, in four stanzas of four lines each, giving a brief history of this renowned composer. The plate was carried away, and most likely sold by weight, by some barbarian, when the church was repaired about a century ago. The verses are to be found in Hawkins, Burney, and most other publications relating to English church music.

TALLOW. [FAT.]
TALLOW-MINERAL or MOUNTAIN. [HATCHETINE.]
TALLOW-TREE. [STILLINGIA.]

TALLY. This word appears to be derived from the French *taille*, or *tailler*, each of which expresses the idea of cutting or notching.

The use of notched sticks or tallies may be traced to a very remote period, and there is reason to believe that they were among the earliest means devised for keeping accounts. Some writers conceive that the Greek symbolon (σύμβολον) was in some cases a species of tally, which was used between contracting parties; being broken in two, and one-half given to each. In the 'Pictorial Bible' note on *Ezek. xxxvii. 20*, much curious information is brought together on the subject of writing or marking with notches upon sticks. The writer of that note refers to the tablets of wood called *axones*, upon which the Athenians inscribed the laws of Solon, and to the practice of the antient Britons, who, he says, 'used to cut their alphabet with a knife upon a stick, which, thus inscribed, was called *Coelbren y Boirdl*, "the billet of signs of the bards," or the Bardic alphabet.' 'And not only,' he continues, 'were the alphabets such, but compositions and memorials were registered in the same manner.' These sticks, he adds, were commonly squared, but were sometimes three-sided; each side, in either case, containing one line of writing. A cut which accompanies the note from which we quote, shows the manner of mounting several such inscribed sticks in a frame, so that they might be read conveniently. Another illustration, of later date, is the clog-almanac described by Dr. Plot, in 1686, as still common in Staffordshire. Such calendars, which had the various days marked by notches of different forms and sizes, were sometimes made small enough to carry in the pocket, and sometimes larger, for hanging up in the house. Similar calendars are said to have been formerly used in Sweden. Perhaps the most curious of the illustrations collected in the note

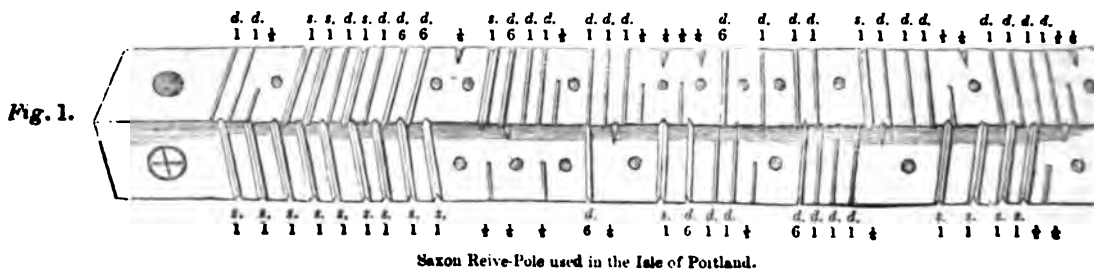

referred to is the Saxon Reive-Pole, which either is, or has been down to a recent period, used in the Isle of Portland for collecting the yearly rent paid to the king as lord of the manor. This rent, which amounts to 14*l.* 14*s.* 3*d.*, is collected by the reive, or steward, every Michaelmas: the sum which each person has to pay being scored upon a squared pole, a portion of which is represented in the subjoined cut, with figures to mark the amount indicated by each notch. 'The black circle at the top,' observes

Southwell, and that side of the pole contains the account of the tax paid by the parishioners; each person's account being divided from that of his neighbour by the circular indentations between each. In the present instance the first pays 2*l.*, the second 4*s.* 2*d.*, the next one farthing, and so on.' The other side of the pole which is represented in the cut is appropriated to the parish of *Wakem*, of which the cross within a circle is the distinctive mark.

The tallies used in the Exchequer (one of which is represented by *fig. 2*) answered the purpose of receipts

well as simple records of matters of account. They consisted of squared rods of hazel or other wood, upon one side of which was marked, by notches, the sum for which the tally was an acknowledgment; one kind of which standing for 1000*l.*, another for 100*l.*, another for 20*s.*, 1*s.*, &c. On two other sides of the tally, opposite to each other, the amount of the sum, the name of the payer, and the date of the transaction, were written by an officer called the writer of the tallies; after this was done, the stick was cleft longitudinally in such a manner that each piece retained one of the two sides, and one-half of every notch cut in the tally. Each piece was then delivered to the person who had paid the money, for which it was a receipt or acquittance, while the other was preserved in the Exchequer. Madox writes respecting these rude and primitive records, 'The use of them was very ancient; coeval, for aught I know, with the Exchequer itself in England.' They were finally discontinued at the remodelling of the Exchequer in 1834; it is worthy of recollection that the fire by which the records of Parliament were destroyed was supposed to have originated in the over-heating of the flues in which the charred tallies were being burnt. Clumsy as the contrivance may appear, tallies were effectual in the prevention of forgery, since no ingenuity could produce a false tally which should perfectly correspond with the counter-tally preserved at the Exchequer; and no alteration of the tally was expressed by the notches and the inscription upon the stick undetected when the two parts of the stick were fitted together. A correspondent of the 'Gentleman's Magazine' for November, 1834 (p. 480), states that attempts were attempted immediately after the discontinuance of tally receipts. The officers of the Exchequer were commonly called *tellers* (*talliers*), as well as several other professions, derived their name from the word tally. Many different kinds of tally are used in gardens and nurseries, to bear either numbers referring to a catalogue, or the names of the plants near which they are used. Loudon describes several sorts, of wood, metal, stoneware, brick, &c., in his 'Encyclopædia of Gardening.' Wooden tallies are sometimes marked by notches instead of writing or painting; particular forms or combinations of notches being used to represent either Arabic numerals or the Roman letters commonly employed in calculation. Tallies formed of brick-earth, with a recess containing a printed card, which is sheltered by a piece of glass, have been introduced of late years, and are particularly recommended for use in arboretums. Instead of wooden tallies in the ground, like tallies of wood and metal, brick tallies are formed with a broad base, which rests upon its surface. Pictorial Bible, note on Ezek. xxxvii. 20; Madox's History of the Exchequer, &c. A popular history of the tally is given in vol. xxiv. of the *Mirror* (pp. 325 and 326), partly condensed from the *Times* newspaper.)

TALMA, FRANÇOIS JOSEPH, an eminent French comedian, was born in Paris, January 15th, 1763. His father, who was a dentist, went to England shortly after the birth of his son, and practised his profession for some years in London. At nine years of age young Talma returned to France, and was placed in a school at Chaillot, which was kept by Monsieur Lamarguère, a great actor of the drama, who delighted to discover and encourage a similar taste in any of his pupils. A year after Talma had joined the school he was intrusted with a part in an old tragedy, called 'Simois, Fils de Tamerlane,' which Monsieur Lamarguère had selected for performance by his scholars; and so deeply did the future comedian enter into the feeling of the character, that he burst into a flood of tears at the recital of the sorrows of the hero, whose brother he represented. At the age of fifteen he wrote a little drama, in the composition of which he further developed his knowledge of the stage. He visited London, and returned a second time to Paris at the latter end of the year 1781, when he commenced the study of logic in the Collège Mazarin. In 1782 he made a *coup d'essai* at the Théâtre de Doyen, in the character of Seide, in the tragedy of 'Mahomet.' A number of friends, appointed by himself, to judge of his success, pronounced it a failure: 'He had not *le feu sacré*.' Talma deferred to this unfavourable opinion, and resumed the study of his father's profession; but a few days afterwards the very same friends were called together, C., No. 1490.

upon to reverse their judgment and confess their mistake. On the 21st of November, 1787, he made his débüt at the Théâtre Français, and in 1789 created a great sensation by his performance of Charles IX. At the commencement of the French Revolution he nearly fell a prey to a severe nervous disorder. On his recovery and the retirement of Larive, Talma became the principal tragic actor. He reformed the costume of the stage, and first played the part of Titus in a Roman toga. During the reign of Napoleon he enjoyed the emperor's friendship; and was no less honoured or esteemed by Louis XVIII. In 1825 he published some 'Reflections' on his favourite art; and on the 11th of June, 1826, appeared for the last time on the stage in the part of Charles VI. During his last illness the audiences of the Théâtre Français every evening called for an official account of the state of his health previously to the commencement of the performances. He died on the 19th of October following, and was buried in the cemetery of Père la Chaise, in presence of an immense crowd. MM. Arnault, Jouy, and Lafourc pronounced orations over his grave. The Théâtre Français remained closed for three evenings, and the Opéra Comique and Odéon were also closed on the day of his funeral. The actors of the Brussels theatre (of which company he was an associate) wore mourning for him for forty days, and a variety of honours were paid to his memory at the principal theatres throughout France and the Netherlands. Talma is said to have created seventy-one characters, amongst the most popular of which were those of Orestes, Œdipus, Nero, Manlius, Cæsar, Cinna, Augustus, Coriolanus, Hector, Macbeth, Hamlet, Othello, Leicester, Sylla, Regulus, Danville (in 'L'Ecole des Vicillards'), Leonidas, Charles VI., and Henry VIII. He has been accused, remarks one of his biographers, of having spoken the verse of tragedy as though it were prose; but this avoidance of the jingle of rhyme was one of the greatest improvements which he introduced upon the French stage. In person he was about the middle height, square-built, and with a most expressive and noble countenance. His voice was exceedingly fine and powerful, his attitudes dignified and graceful. In private life he was distinguished for his manly frankness, his kind disposition, and unaffected manners. He spoke English perfectly, and was a great admirer of England and her institutions. He was the friend and guest of John Kemble, and was present in Covent Garden Theatre when that great actor took his leave of the stage.

(*Almanach des Spectacles*, 1827; *Biographie Nouvelle des Contemporains*; *New Monthly Mag.*; *Personal Recollections*.)

TALMUD. [HEBREW LANGUAGE.]

TALPA. [TALPIDÆ.]

TALPASOREX, M. Lesson's name for a genus of *Sorex*, comprising the *Shrew-mole*. [Vol. xxii., p. 265.]

TALPIDÆ, the family of *Moles*.

The genus *Talpa*, as it stands in the 12th edition of the *Systema Naturæ*, between the genera *Dipodops* and *Sorex*, comprises two species only, *Talpa europæa*, the Common Mole, and *Talpa asiatica*. [CHRYSOCHLORIS.]

Cuvier places the *Moles*, confining them to the genus *Talpa*, between *Sorex* [SORECIDÆ] and *CONDYLURA*.

Mr. Swainson places the genus *Talpa* between *Chrysochloris* and *Centenes*. [TENREC.]

ORGANIZATION.

Skeleton.—The cranium is elongated and pointed, and



Skull of Mole.

there is a peculiar bone for the support and working of the muzzle. The part which extends from the internal

side of the jaws terminates in three points, the one in the middle larger and more distant from the external edge than the other two. The very short arm attached by

means of a long bladebone, and sustained by a vigorous clavicle, carries an extremely wide hand, the palm of which is always turned outwards or backwards. No known

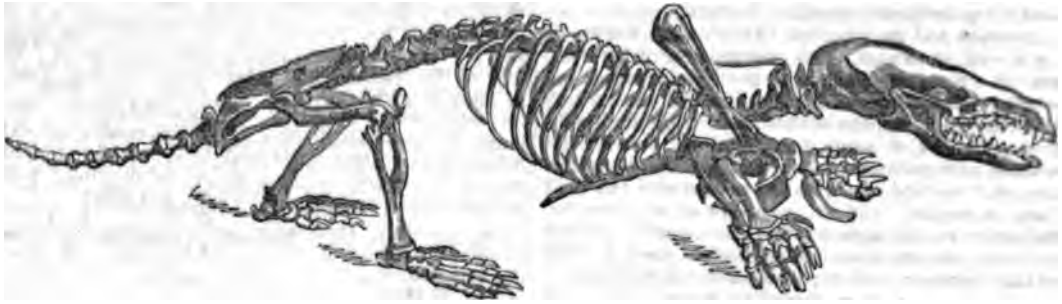

Skeleton of Mole. (De Blainville.) The nuchal bone and accessory carpal sabre-shaped bone are here shown.

living form has the compressed phalangeal bones seen in *Glyptodon* except the mole. The second phalanx of the anterior digits or fingers of the mole is the only known living analogue of the similar bone in the hind-foot of *Glyptodon*. The sternum, like that of the birds and bats, has an elevation or crest affording room for the large pectoral muscles. The pelvis and hinder extremities are comparatively feeble. The bones of the pubis are not joined.

This bony framework is set in motion by very powerful muscles. Those of the anterior extremities, the chest, and the neck are most vigorous, and in the cervical ligament a peculiar bone is even formed. The wide hand, which is the great instrument of action, and performs the offices of a pickaxe and shovel, is sharp-edged on its lower margin, and, when clothed with the integuments, the fingers are hardly distinguishable, but the terminating claws project long, strong, flat, and trenchant.

Let us compare for a moment the bats with the moles with reference to their locomotion. Both are insectivorous, but how widely different in their conformation. The bat has to winnow its way through the air: the mole, like the bat, has to react against a given medium, a very different one, certainly; and is endowed with a power of moving through that medium by means of a modification of the locomotive organs beautifully adapted to its density. Instead of the lengthened bones of the forearm that so well assist the bat to make its way with outstretched wing through the air, all in this part of the organization of the mole is short and compact, to enable it to bore through the dense medium where it is to live and move and have its being. The development is all anterior: the fore part of the mole forms an elongated cone; the posterior part is narrow and small, and the whole of its proportions are admirably fitted to assist it, so to speak, in flying through the earth. The long and almost round scapula, the expanded humerus, the enormous power, in short, of the anterior extremities, and the great strength and compactness of the fingers, are all fitted for the digging duty they have to do. Add to this a soft short-cut velvety coat, to which no particle of soil ever adheres, and you have the perfection of organization for rapid progress through the ground.

Nor is it void of interest to observe the niceties of adaptation according to circumstances. The *CHRYSOCHLORIS* (*Talpa aurea* of the older authors) is an inhabitant of Africa, and burrows in sand. This medium required a modification of organization different from that required to permeate the heavier soils, and we have it. Though some of the bones are strong, the general strength is less than in the common Mole. The principal burrowing instrument is the great double anterior toe (ring-finger), and there is an enormous development of the pisiform bone.

In the museum of the Royal College of Surgeons, in London, No. 282 G, of the *Physiological Series*, shows the anterior half of the body of a Mole (*Talpa Europaea*, Linn.), in which the diaphragm and principal muscles of the right extremity are dissected and exposed, as illustrative of one of the principal structures for burrowing.

Nervous System and Senses.—(*Touch.*)—The muzzle of the mole is evidently a delicate organ of touch, and that sense is considerably developed in the large and broad hands and feet. Neither is the tail without a considerable share of sensation, to give notice to the animal of the approach of any attack from behind.

Taste and Smell.—The gustatory and olfactory nerves, especially the latter, appear to be very sensitive.

Sight.—Almost rudimentary. The little eye is so hidden in the fur, that its very existence was for a long time denied. It appears to be designed for operating only as a warning to the animal on its emerging into the light; and indeed more acute vision would only have been an incumbrance. No. 1772 (*Mus. Coll. Reg. Chir., Phys. Series*) is the anterior part of a mole (*Talpa Europaea*, Linn.), showing the minute circular palpebral orifices defended by the short thick fur.

Hearing.—But if the sight be imperfect, the sense of hearing is very highly developed, and the tympanum very large, though there is no external ear, or rather, no projecting concha. No. 1608, in the department of the museum of the Royal College of Surgeons above referred to, exhibits the anterior part of a mole (*Talpa Europaea*, Linn.), from which the hair has been removed, to show the external orifices of the ears and eyes, in both of which bristles are placed. No. 1609 is also the anterior part of the same animal with the fur left on, showing the entrance to the meatus auditorius externus unprovided with a projecting concha, or external ear, which would be an impediment in the act of burrowing, and an unnecessary appendage: the meatus is defended in this animal, which lives habitually in the soil, by the smallness of the external opening. John Hunter, in his *Manuscript Catalogue*, introductory of this part of the series, observes that an external concha is not to be found in many animals whose life is principally led underground, such as the mole; and perhaps because the earth assists considerably in vibration.

There is nothing that calls for any particular notice in the *Digestive System* of the Mole. The alimentary canal is short, simple, without a cæcum. The voracity of the mole corresponds with the activity and rapidity of its digestive powers.

Generative and Urinary Systems.—No. 2505 of the *Physiological Series* in *Mus. Coll. Reg. Chir.* exhibits a mole with the abdomen laid open to show the testes as they appear in winter. They are lodged in large cremasteric pouches in the perinæal region, making no projection externally. The right testis is drawn into the abdomen by the side of the bladder, and its posterior extremity may be seen attached to the inverted cremaster: the left testis has its anterior extremity projecting into the abdominal cavity. The prostatic glands, which consist of an aggregate of cæcal tubes, are just visible behind the bladder. No. 2506 is a mole killed in February, and prepared to show the increased size of the testes, and the commencing sexual development of the prostatic canals. No. 2507 is a mole killed in the beginning of March, and prepared to show a further increase of the testes and accessory prostatic glands: the latter have now advanced forwards on each side of the urinary bladder, so as to encompass its neck: the left testis has been drawn back into the abdomen, and its attachment to the inverted cremasteric pouch displayed. No. 2508 is a mole killed about the latter end of March, and dissected to show the complete development of the testes and prostatic glands. The long penis and its two crura, surrounded by the erector muscles, are also shown. No. 2509 is a mole which was killed in autumn, prepared to show the collapsed state of the testes, and the atrophied condition of the pro-

static glands; but the testes in this case had not yet returned to the small size which they exhibit in winter. No. 2510 is a preparation showing a side view of the male organs of generation; and No. 2511 exhibits the male organs of *Chrysochloris capensis*. (*Cat.*, vol. iv.)

The increase and decrease of the testes in Birds and Fossils are well shown in preparations in the same noble museum; the first in Nos. 2457 to 2462 (both inclusive), the second in Nos. 2412 and 2411. John Hunter, in his 'Animal Economy,' observes that these seasonal or periodical changes are common to all animals which have their seasons of copulation. 'In the buck,' says that great physiologist, 'we find the testicles are reduced to a very small size in winter; and in the land-mouse, mole, &c., this diminution is still more remarkable. Animals, on the contrary, who are not in a state of nature, have no such change take place in their testicles; and not being much affected by seasons, are consequently always in good condition, or in a state to which other animals that are left to themselves can only attain in the warmer season. Therefore in man, who is in the state we have last described, the testicles are nearly of the same size in winter as in summer; and nearly, though not exactly, the same thing may be observed in the horse, ram, &c., these animals having their seasons in a certain degree. The variation above taken notice of is not confined to the testicles, but also extends to the parts which are connected with them: for in those animals that have their seasons for propagation the most distinctly marked, as the land-mouse, mole, &c., the vesiculae are hardly discernible in the winter; but in the spring they are very large, varying in size in a manner similar to the testicle. It may however be alleged that the change in these bags might naturally be supposed to take place, even admitting them to be seminal reservoirs; but what happens in the prostate gland, which has never been supposed to contain semen, will take off the force of this objection; since in all animals which have such a gland, and which have their season for propagation, it undergoes a limited change. In the mole the prostate gland is hardly discernible, but in the spring becomes very large, and is filled with mucus.'

No. 2407 exhibits the posterior part of a mole (*Talpa Europæa*), with the female generative and urinary organs exposed. The uterus is turned to the right side, principally to display the course and attachments of the ovarian and uterine ligaments. The ovarian ligament commences anterior and external to the kidney, and carries forward with it a fold of the peritoneum as it advances to the ovarium. The uterine ligament, or ligamentum rotundum, is continued from the extremity of the cornu uteri, and runs along the posterior edge of the preceding fold to the part corresponding to the abdominal ring in the male, where it expands upon the fascia. The left ovary and oviduct, the cornua and corpus uteri, are also exhibited. The ovary is tuberculate, and included in an almost complete peritoneal capsule. The oviduct is attached to this capsule, and pursues a wavy course to the horn of the uterus. No. 2408 displays the female organs of a mole *in situ*, the ventral parietes of the abdomen and chylopoietic viscera having been removed. The cornua uteri, cylindrical tubes, describe three abrupt curves before joining the corpus uteri, with which they form almost a right angle. The body of the uterus is continued without any constriction or interruption into the vagina: the whole canal is somewhat flattened, and is disposed in two or three vertical curves or folds before it leaves the abdomen. No. 2409 is also the posterior half of a mole, with the female organs similarly displayed, but minutely injected. The cornua uteri are divaricated, to display the extent of the broad ligaments. No. 2410 is a section of a mole, in which the left ovary, oviduct, and uterine horn, and the left side of the uterus and vagina, have been removed, but exposing the remainder of the generative apparatus *in situ*, and exhibiting its relative position to the urinary bladder, the rectum, and the pelvis. The contracted area of the uterine cavity, the absence of any os tincæ dividing it from the vagina, and the distinct muscular and internal membranous tunics of the flattened tortuous utero-vaginal canal, are clearly displayed. A bristle is inserted into the right horn of the uterus, and another is passed through the clitoris, which is perforated by the urethra. 'Thus,' continues Professor Owen, the author of the catalogue, 'the urethra, vagina, and rectum open by distinct orifices

on the exterior of the body, and all three canals are anterior to the pubic bones, and consequently outside the pelvis.'

No. 1224 of the same series exhibits the kidney of a mole injected and longitudinally divided. The uninjected tubuli may be plainly seen extending through the cortical substance, as is shown in the injections of the kidney of the horse, Nos. 1200 to 1214, both inclusive. (*Cat.*, vol. ii.)

Generic Character.—Body stout and thick, furry; head elongated, pointed; muzzle cartilaginous, strengthened by the snout-bone; eyes very small; no external ears; anterior feet short and wide, with five united toes armed with trenchant nails proper for digging; posterior feet with five toes also, but weak; tail short.

Dental Formula:—Incisors $\frac{6}{8}$; canines $\frac{1-1}{0}$; molars

$$\frac{7-7}{7-7} = 44.$$

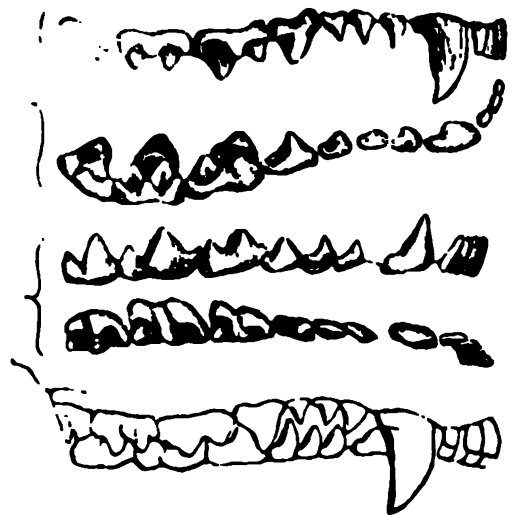

Teeth of Mole, e. naturally enlarged. (F. Cuv.)

Example, *Talpa Europæa*, the common mole.

This well-known animal, so familiar to all that it would be a needless waste of space to describe it, is *La Taupe* of the French, *Talpa* of the ancient and modern Italians, *Topo* of the Spanish, *Toupeira* of the Portuguese, *Maulwurf* of the Germans, *Mol* of the Dutch, *Mulvad* and *Sark* of the Swedes, *Muldwarp* of the Danes; *Mole*, *Mole-warp*, *Moldwarp*, and *Want* of the modern British; and *Gradd* and *Tereh daeur* of the ancient British.

Habits, Food, Reproduction, &c.—'A subterraneous life,' says Pennant, speaking of the mole, 'being allotted to it, the seeming defects of several of its parts vanish; which, instead of appearing maimed or unfinished, exhibit a most striking proof of the fitness of their contrivance. The breadth, strength, and shortness of the fore-feet, which are inclined sideways, answer the use as well as the form of hands, to scoop out the earth, to form its habitation, or to pursue its prey. Had they been longer, the falling in of the earth would have prevented the quick repetition of its strokes in working, or have impeded its course: the oblique position of the fore-feet has also this advantage, that it flings all the loose soil behind the animal.'

'The form of the body is not less admirably contrived for its way of life: the fore-part is thick and very muscular, giving great strength to the action of the fore-part, enabling it to dig its way with great force and rapidity, either to pursue its prey or elude the search of the most active enemy. The form of its hind parts, which are small and taper, enables it to pass with great facility through the earth that the fore-feet had flung behind; for had each part of the body been of equal thickness, its flight would have been impeded and its security precarious.'

'The skin is most excessively compact, and so tough as not to be cut but by a very sharp knife; the hair is very short and close-set, and softer than the finest silk; the usual colour is black, not but that there are instances of these animals being spotted, and a cream-coloured breed is sometimes found in my lands near Downing.'

The smallness of the eyes (which gave occasion to the ancients to deny it the sense of sight*) is to this animal a peculiar happiness; a small degree of vision is sufficient for an animal ever destined to live underground; had these organs been larger, they would have been perpetually liable to injuries by the earth falling into them; but nature, to prevent that inconvenience, hath not only made them very small, but also covered them very closely with fur. Anatomists mention (besides these) a third very wonderful contrivance for their security, and inform us that each eye is furnished with a certain muscle, by which the animal has the power of withdrawing or exerting them, according to its exigencies.

To make amends for the dimness of its sight, the mole is amply recompensed by the great perfection of two other senses, those of hearing and of smelling: the first gives it notice of the most distant approach of danger; the other, which is equally exquisite, directs it in the midst of darkness to its food: the nose also, being very long and slender, is well formed for thrusting into small holes in search of the worms and insects that inhabit them. These gifts may with reason be said to compensate the defect of sight, as they supply in this animal all its wants and all the purposes of that sense.

It is supposed that the verdant circles so often seen in grass-grounds, called by country-people *fairy rings*, are owing to the operations of these animals, who, at certain seasons perform their burrowings by circumgyrations, which, loosening the soil, give the surface a greater fertility and rankness of grass than the other parts within or without the ring.

The mole breeds in the spring, and brings four or five young at a time: it makes its nest of moss, and that always under the largest hillock, a little below the surface of the ground. It is observed to be most active, and to cast up most earth, immediately before rain, and in the winter before a thaw, because at those times the worms and insects begin to be in motion and approach the surface: on the contrary, in very dry weather this animal seldom or never forms any hillocks, as it penetrates deep after its prey, which at such seasons retires far into the ground. During summer it runs in search of snails and worms in the night time among the grass, which makes it the prey of owls. The mole shows great art in skinning a worm, which it always does before it eats it; stripping the skin from end to end, and squeezing out the contents of the body.

Thus far Pennant: but the most diligent and instructive historian of the mole is Henri Le Court, who, flying from the terrors that came in the train of the French revolution, buried himself in the country, and, from the attendant on a court, became the biographer of this humble animal. The discoveries of this indefatigable observer have been laid before the public in the work of De Vaux (1803), and a summary of them by Geoffroy St. Hilaire, in the *Cours d'Histoire Naturelle des Mammifères*. The latter visited Le Court for the purpose of testing his observations, and appears to have been charmed by the facility and ingenuity with which Le Court traced and demonstrated the subterranean labours of this obscure worker in the dark.

One of the experiments which Le Court made afforded ample proof of the rapidity with which the mole will travel along its passages. He watched his opportunity, and when the mole was out on its feed at one of the most distant points from its sanctuary or fortress, to which point the mole's high road leads, Le Court placed along the course of that road between the mole and the fortress several little camp-colours, so to speak, the staff of each being a straw and the flag a bit of paper, at certain distances, the straws penetrating down into the passage. Near the end of the subterranean road he inserted a horn, the mouth-piece of which stood out of the ground. When all was ready, Le Court blew a blast loud enough to fright all the moles within hearing from their propriety, and the little gentleman in velvet, whose presence at the spot he had well ascertained, was affected accordingly. Down went the little flags in succession with an astonishing celerity, as the horrified mole, rushing along towards his sanctuary, came in contact with the flag-straws; and such mettle had terror put into the animal's heels, that the spectators

affirmed that its swiftness was equal to the speed of a horse at a good round trot.

This experiment was perfectly satisfactory as to the auditory and travelling powers of the mole; but another made by Le Court equally proved that the amount of vision possessed by the animal is amply sufficient for its wants, and that, with all the imperfections of this sense, its sight warns it of danger. Le Court took a spare water-pipe or gutter open at both ends. Into this pipe he introduced several moles, successively. Geoffroy St. Hilaire stood by to watch the result, at the farther end of the tube. As long as the spectators stood motionless, the introduced mole made the best of his way through the pipe and escaped; but if they moved, or even raised a finger, the mole stopped and then retreated. Several repetitions of the experiment produced the same results.

But we must describe the mole's domain. The principal point is the habitation, or, as it has been termed, the fortress, and is constructed under a considerable hillock raised in some secure place, often at the root of a tree, under a bank, or any shelter that offers protection. The fortress is domed by a cement, so to speak, of earth which has been beaten and compressed by the architect into a compact and solid state. Within, a circular gallery is formed at the base, and communicates with a smaller upper gallery by means of five passages, which are nearly at equal distances. Within the lower and under the upper of these galleries is the chamber or dormitory, which has access to the upper gallery by three similar passages. From this habitation, we should here observe, the high road by which the proprietor reaches the opposite end of the encampment extends, and the various galleries or excavations open into this road, which the mole is continually carrying out and extending in its search for food, and which has been termed its hunting-ground. But to return to the chamber. From it another road extends, the direction of which is downward at first, and that for several inches, when it again rises to open into the high road of the territory. Some eight or nine other passages open out from the external circular gallery, but the orifices of these never come opposite to the passages which connect the external gallery with the internal and upper gallery. The extent of these passages is greater or less, according to circumstances, and they each return by an irregular and semicircular route, opening at various distances from the habitation into the high road, which differs considerably from all the other passages and excavations, both in construction and with regard to the use to which it is applied. From the habitation this road is carried out nearly in a straight line and forms the main passage of communication between the habitation, the different portions of the encampment, and the alleys leading to the hunting-ground which open into it on each side. In diameter it exceeds the body of a mole, but its size will not admit of two moles passing each other. The walls, from the reiterated pressure of the mole's sides against them, become smooth and compact, and its course is remarkable for the comparative absence of mole-hills, which are frequent in connection with the alleys and quarries, as they have been termed, in constructing which the earth is removed out of the way to the surface. Sometimes a mole will lay out a second or even a third road in order to the extension of its operations. Sometimes several individuals use one road in common, though they never trespass on each other's hunting-grounds. In the event of common usage, if two moles should happen to meet, one must retreat into the nearest alley, unless both should be pugnacious, in which case, the weakest is often slain. In forming this tunnel, the mole's instinct supplies the place of science, for he drives it at a greater or less depth, according to the quality of the soil, or concurrent circumstances. When there is nothing superincumbent threatening a disturbance of its security, it is often excavated at a depth of some four or five inches; but if it is carried under a road or a stream, a foot and a half of earth, sometimes more, is left above it. Thus does the little animal carry on the subterranean works necessary for his support, travelling, and comfort; and his tunnels never fall in.

The alleys opening out from the sides of the high road have generally a somewhat downward inclination from their commencement towards their end. It has been observed that when, on opening one of these alleys, a plen-

* * Aut oculis cepti fodere cubilia talpæ. Varg., Oe. r. 1., 183.

ply of food is found, the mole proceeds to work
ch alleys from its termination, up-heaving new
as it advances in quest of prey: should how-
soil be barren of the means of existence, the ani-
mences another alley at a different part of the
d. The quality and humidity of the soil, which
the abundance of earth-worms, determine the
r less depth of the alleys.

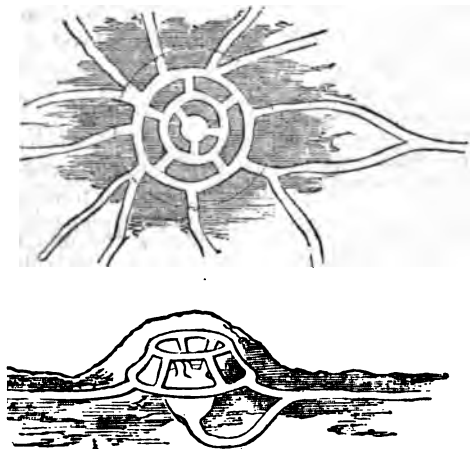

Habitation or fortress of Mole.

a road being the highway of communication
erent hunting-grounds, it is necessarily passed
regularly in the course of the day, and it is in this
the mole-catcher sets his traps or practices his
o intercept the animal between its habitation and
where it is carrying on its labours. Some mole-
will tell you that the hours when the moles move
and four, and others that, near the coast, their
nts are influenced by the tides; to which state-
e hearer is at liberty to give as much credence as
es. Besides the various traps which are set for them,
or very lately was, a man who travelled the coun-
a dog and destroyed them without any trap at all,
llowing process: Taking his station at the pro-
and place, attended by his dog, and armed with
r spud, he waits till the dog indicates the pre-
the mole, and then spears or spuds the animal
moves in its run. Pointers will stop at moles as
as at game, when the latter are straying on the

s the excavations already noticed, the moles pur-
her mode of hunting in light loose soils, newly
n gentle rains have led the earth-worms towards
e, along which they follow the worms up, rapidly
a shallow trench in the superficial layer of the
e female, when with young, is said to be princi-
d to this easier method of subsistence.

animal passions are strong in the mole, and it is
ous animal. It has been supposed that it
easable as well as an animal feeder, and, as a
the former, the fragments of roots, &c., found in
ch have been appealed to; but there can be no
at these vegetable matters had been conveyed
stomach with the earth-worms (their favourite
d the larvæ of insects. The structure of its teeth
; that its food should be animal, and indeed mice,
rugs, and even birds have been known to fall
to its voracity; but it eschews toads even when
by hunger, deterred probably by the acrid secre-
their skin. [Frogs, vol. x., p. 493.] All doubts
e carnivorous nature of the mole have however
noved by the experiments of M. Flourens, who
moles restricted to carrots, turnips, various
erbs, and vegetable substances which were
ly supplied to them, died of hunger. The mole
ppears to require much nourishment, and a short
es fatal to it.

ust not omit to notice the provision of this ani-
cure a supply of water, for its voracity makes it
rinker. If a pond or ditch be at hand in those
e many moles use the same common highway,
always formed to the reservoir: when it is too

distant, the animal sinks little wells in the shape of deep
perpendicular shafts, which hold water. These wells have
sometimes been seen brim-full.

During the season of love, at which time bloody battles
are fought between the males, the male pursues the female
with ardour through numerous divaricating superficial
runs wrought out with great rapidity, termed 'coupling
runs' and 'rutting angles' by our mole-catchers, and
'traces d'amour' by the French. The sexual attachment
appears to be very strong in the moles. Le Court often
found a female taken in his trap, and a male lying dead
close to her. The period of gestation is two months at
least, and the young are generally produced in April, but
have been found from that month to August. From four
to five is the general number, though from three to six
have been recorded, and in one case seven* in one nest.
The nest is distinct, usually distant from the habitation,
and not always crowned with a hillock; but when a hil-
lock exists, it is much larger than an ordinary mole-hill.
It is constructed by enlarging and excavating the point
where three or four passages intersect each other; and
the bed of the nest is formed of a mass of young grass,
root-fibres, and herbage. In one case, Geoffroy St. Hi-
laire and Le Court counted two hundred and four young
wheat-blades.

In the Museum of the Royal College of Surgeons in
London, No. 3573 of the Physiological Series is the pos-
terior half of a pregnant mole, with the uterus and three
fœtuses, each about half an inch in length, exposed *in
situ*: the ovarium is contained in a thin and transparent
peritoneal capsule, around which the oviduct may be ob-
served passing in the form of an opaque, white, narrow
band: the uterine dilatation next the left ovarium remains
open, and the fœtus is exposed inclosed in its membranes;
the other uterine dilatations are left entire; they resemble
blind pouches developed from one side of the uterine
tube. No. 3574 is the posterior extremity of the trunk of
a pregnant mole, with the uterus and five fœtuses dis-
played *in situ*; one of the dilated chambers of the left
uterine horn is laid open, and the fœtus is exposed with
its membranes. The placenta is a spongy, vascular sub-
stance, in the form of an oblong flat band, with its long
axis parallel to that of the fœtus. One of the uterine
chambers, with the corresponding chorionic sac, is laid
open in the right horn of the uterus, and the fœtus is dis-
placed. No. 3575 presents the female organs of a preg-
nant mole with four fœtuses, each one inch and a quarter
in length; one of these is exposed *in situ* in the uterine
sac, two others hang suspended by their membranes and
the placenta from the parietes of the uterus: in the lower
of these embryos the fœtal placenta is partly separated
from the maternal portion, showing the fine areolar struc-
ture of the latter, which receives the fœtal placental
filaments: the maternal placenta is minutely injected, but
no portion of injection has passed into those fœtal fila-
ments which are here exposed; the capacity of the chori-
on is very little larger than the fœtus which it contains.
In the embryo which has been displaced from the chori-
onic sac, the short umbilical cord, and the characteristic
form of the short and strong fossorial anterior extremities,
may be discerned: the external apertures of the eyes and
ears are completely closed. The canal leading from the
uterine horns to the external opening of the vagina is laid
open, showing the absence of any os tincæ dividing the
uterus from the vagina: a bristle is passed into the ure-
thra, which is continued through the clitoris. The author
of the catalogue (Professor Owen) observes that the pecu-
liar position of the vagina of the mole, on the outside of
the pelvis, is well displayed in No. 2810, above noticed,
and that by this modification the contracted pelvis offers
no impediment to parturition. (*Cat.*)

Heavy charges have been brought against the mole by
agriculturists and horticulturists, and the more grave ac-
cusation of being ancillary to the destruction of dykes has
been in some instances proved upon it. Mr. Bell, in his
interesting *History of British Quadrupeds*, sums up the
evidence against it and in its favour thus:—'In order to
arrive at a true solution of the question, it is necessary to
divest our minds as well of the prepossessions of the natu-
ralist as of the prejudices of the agriculturist; for we shall
probably find, as in most other cases, that the truth lies
between the two extremes. According to its accusers,

* Loudon's 'Magazine of Nat. Hist.', vol. viii.

there is no portion of its labours, no peculiarity of its habits, no function of its organization, that is not the means or the cause of ravage and devastation to our cultivated grounds. The soil, say they, is rendered dry and sterile by its subterranean roads; the crops are killed by the exposure or the destruction of the roots; the plants themselves are overthrown by the construction of the mole-hills, or they perish from their roots being eaten, or they are dug up and scattered by the superficial furrows which the animal ploughs up either in search of food or in pursuit of its mate; large quantities of young corn too are carried off by it to form its nest; and, finally, its abandoned fortress becomes the resort of the field-mouse and other noxious animals. Thus the field and the meadow, the garden and the plantation, are alike the scenes of its ravages; and De Vaux calculates that the loss which it occasions to the spring corn alone may be calculated at one-eighth of the whole produce. Then, on the other hand, these prejudiced judges allow nothing for the benefit which arises from the destruction of innumerable worms, and of insects both in the larva and perfect state: this advantage is in fact denied by De Vaux, who declares that the mole feeds only on the most harmless of those animals, the earth-worm, and that it refuses those which are injurious to mankind. Its more benevolent advocates, on the other hand, contend not only that the injury which it perpetrates is slight, but that it is more than counterbalanced by the benefit which it produces by turning up and lightening the soil, and especially by its immense destruction of earth-worms and many other noxious animals which inhabit the superficial layer of the ground, and occasion great injury to the roots of grass, corn, and many other plants. If we examine the real nature and degree of its injuries on the one side, and its utility on the other, we shall probably find that both parties are erroneous. The fact of its devastations cannot be denied, it is only in the degree and extent of them that the estimation is incorrect; and whilst its utility in clearing the ground of worms and similar causes of injury must also be allowed, it can scarcely be sustained that the lightening of the soil by the turning up of its hillocks is, at most, more than a very equivocal source of advantage.

Thus we see that 'much may be said on both sides.' We have heard advocates for the mole declare that in great sheep-walks whence they have been rooted out, the whole character of the feed has been altered, and the exterminators have been obliged to introduce them again, and we have heard such stories denied. Too much stress however may be laid on its services as a destroyer of the earth-worm; for it may be well doubted whether it aids the agriculturist by the destruction of an animal that does so much for the soil. [LUMBRICUS, vol. xiv., p. 196.]

Whatever may be the merits of the case, the persecution of these animals in cultivated countries amounts almost to a war of extermination. The numbers annually slaughtered are enormous. Mr. Bell states that Mr. Jackson, a very intelligent mole-catcher, who had followed the craft for thirty-five years, had destroyed from forty to fifty thousand. But all mole-exterminators must yield to Le Court, who, in no large district, took, in five months, six thousand of them.

Moles are good swimmers, and their bite is very sharp: when their blood is up, their ferocity is great, and they keep their hold like a bull-dog.

As to the question whether the species under consideration is the *aspulax* (ἀσπάλαις) of Aristotle, who describes his animal as blind, see the article MURINE, vol. xv., p. 516.

Geographical Distribution.—The common mole is found throughout the greater part of the continent of Europe and its larger islands. In Greece it is said to be comparatively rare. We are overrun with it in most parts of England and Wales, but it does not appear to have been found in the northern extremity of Scotland, though it is frequent enough in the south. There is no record of its having been seen in the Orkney Isles, Zetland, or Ireland.

The Prince of Musignano has well figured, in his excellent work, *Iconografia della Fauna Italica*, the species under consideration and the *Talpa caeca*, which may be the *Aspalax* of Aristotle. In this last species the middle incisive teeth are longer than the rest; in the common mole they are all equal, and De Vaux states that there is some difference, though not great, in the habits and architecture of the two species. Mr. Bell suggests

that as both species are inhabitants of Europe, the original trivial name *Europæa* should be dropped, and Brisson's name, *vulgaris*, be adopted for the common species.

For Dr. Richardson's account of the true moles brought from America, see the article *Sorex*, vol. xxii., p. 265.

Fossil Moles.

The fossil remains of the mole have been found in the bone-caverns; as, for example, in the cave at Köstritz and at Paviland (see Buckland, *Reliquiæ Diluvianæ*). They have also been found in the bone-caverns in Belgium (Schmerling).

Bones of moles have been obtained from the brown clay of Norfolk: they were, we understand, first taken for the remains of lizards.

The questions which arise upon this discovery are:—

1st. Were they true fossils of that formation or subsequently introduced? and this their condition might determine.

2nd. Are the fossil remains identical with the bones of the common mole?

An inspection of the remains themselves might convey a solution of both these questions, and we are informed that the fossils are, through the kindness of Professor Sedgwick, about to be sent up to Professor Owen.

But throughout this inquiry it will be necessary to bear in mind that though this quadruped is a denizen of the earth, performing all its functions, with little exception, below the surface, and though we might for that reason be led to expect the frequent occurrence of its remains in a fossil state, true fossil bones of the mole have not hitherto been described. The danger to be guarded against with regard to those specimens found in the newer and superficial strata is that a burrowing animal may have penetrated into those fossiliferous beds subsequently to their formation and the deposit of their organized contents. We therefore look forward to Professor Owen's opinion upon the condition of these remains and their specific distinction with much interest.

TALUS, or TALUT, probably from 'taglio,' Ital., a cut, is a term used chiefly by writers on fortification, in speaking of a rampart or parapet, to signify a surface which is inclined to the horizon. Thus the upper surface of a parapet is called the superior talus or slope; and that surface of a rampart or parapet which is towards the country, or towards the town, is called the exterior, or the interior, talus of the work (*Fig. 2, BASTION*).

The superior talus of a parapet is usually formed in a plane which, if produced towards the country, would nearly meet the top of the counterscarp before it, in order that the defenders of the rampart may be able to fire into the covered way in the event of the latter being occupied by the enemy, their muskets being laid upon that slope. The exterior or the interior talus of any work of earth usually forms, with the horizon, an angle of 45 degrees; such being the inclination at which the surface of earth, of medium tenacity, will stand unsupported.

TAMAN, a peninsula, or rather a delta-island, is formed by the main branch of the river Kuban, which empties itself into the Black Sea, and a small branch of the same river, which flows into the Sea of Azof north of the old fortress of Temruk. The western or large part of the island stretches between the sea of Azof on the north and the Black Sea on the south, and is bounded on the west by the Strait of Yenikale, the ancient Bosphorus Cimmerius, and the Bay of Taman. The island resembles the open claws of a lobster, embracing the Bay of Taman. Its length is 57 miles, and its greatest breadth 22 miles, but the real surface is far from corresponding to these dimensions, the middle of the island being occupied by the large Temruk-skoi Liman, or Lake of Temruk, and the whole of the remaining part being notched by creeks and bays in such a manner as to present rather the skeleton of an island than a real island. The south-western part of Taman, the ancient peninsula of Corocondama (Pomp. Mela, i. 19; Strabo, p. 404. Casaub.) presents a solid mass traversed by several ranges of hills from 150 to 180 feet high: they run from west to east, and near the village of Sennaya-Balka form a bifurcation. One branch runs between the Kubanskoi Liman, or the lake formed by the Kuban before it reaches the sea, and the lake of Temruk, and terminates in a slip of land which divides this lake into two unequal parts. The other branch, the direc-

which is north-east, forms the isthmus between the land of Temruk on the east, and the bay of Taman on the west, and terminates before it reaches the isthmus between the land of Temruk and the Sea of Azof. The northern part of Taman, or the peninsula between the Sea of Azof and the bay of Taman, is no less elevated above the sea, but although it is a continuation of the mainland, it is separated from the eastern hills by a flat sandy isthmus which seems to have been covered by the sea at a period not very remote from our own times. All these are mere masses of sand and pebbles cemented together. The higher part of them is barren, but the slopes, the low grounds between them and the sea or the marshes are covered with soil and fit for agriculture. They are rich pasture-grounds. The isthmus between the lake of Temruk and the bay of Taman, and principally the isthmus between the lake of Temruk and the Kubanskoi, have a very pleasant aspect, being covered with numerous farmhouses of the Cossacks; and on the meadows are numerous flocks of cattle, some of which are driven across the strait from the neighbouring coast of Crimea. The eastern part of Taman is formed by a wide and narrow isthmuses, and a somewhat broader isthmus of lowland between the two branches of the isthmus. The whole of this country is marshy, partly covered with pastures and partly with a luxuriant vegetation of rushes and reeds, which, in the neighbourhood of Kaláus, as Dr. Clarke states, attain a height of sixteen to twenty feet. Everywhere there is a communication between land and water; gulfs become creeks, creeks are changed into marshes, and as soon as they get a continental aspect, the waters again swallow up. In the rainy season, says Pallas, all this is overflowed by the waters of the Kuban, and the part of Taman is separated from the continent by a narrow lake which extends from one sea to the other, but notwithstanding the apparently overwhelming of the waters, the solid element makes constant land. Thus M. Dureau de la Malle is correct when, in his *Géographie Physique de la Mer Noire*, he says 'the lakes on the shore of the Sea of Azof, which are separated from the sea only by flat and narrow isthmuses, have been bays and gulfs, and that the barriers between them and the open sea are a deposit formed by shifting masses of mud and sand carried into this strait by the Don and its tributary rivers. As to the whole of the island of Taman, it is also a mere reproduction of the immense quantities of clay and mud which the Sea of Azof and the Kuban have deposited at the mouth of this river. The western and eastern part however in its whole geognostical structure is connected to the opposite continent of the Crimea, from which it has apparently been separated by the current of the Black Sea Bosphorus. Two characteristic peculiarities of the part are the Sewernaya Kossa, a long and narrow slip of land which stretches from the extremity of the northern peninsula in a direction to the middle of the mouth of the strait; and the cluster of small islands, the principal of which was known to the Byzantines by the name of Atech, which extend from Point Yunaya to the strait till they reach the centre of the strait. These islands will probably become a continuous land, and when the opposite Sewernaya Kossa, will separate the whole bay of Taman from the Bosphorus. Numerous craters are situated on the ridge of the hills of the Bay of Taman, as well as along the lake of Azof. They present all the external appearances of volcanoes; though the matter which they throw out is not lava, but a thick mud of a deep black colour, which is discharged at irregular periods. The largest of these craters is situated on the southern extremity of the northern peninsula, and a description of the most remarkable of it is given by Pallas in the work cited below. Pallas attributes these phenomena to the burning of an extensive layer of coals, upon which indeed the island of Taman seems to repose. The apparition of a new island, which, on the 5th of September, 1799, suddenly rose from the Sea of Azof, near the coast of Temruk, a phenomenon which was preceded and accompanied by a series of earthquakes, and all the other symptoms of a volcanic eruption, was undoubtedly the effect of the same volcanic cause. The new island however soon disappeared into the sea.

The Greeks knew this remarkable island under the name of Eion (*Εἰών*), and founded several colonies in it. The most considerable of them were—Phanagoria, a famous commercial town, which contained a beautiful temple of Aphrodite of Apaturon (Strabo, p. 495. Casaub.); Kepos, or Kepi, a colony of the Milesians; Hermonassa, founded by the Ionians; and Achilleion: some ruins and marbles are the only traces that remain of their antient splendour. The island belonged for a long period to the kingdom of Bosphorus, and was afterwards conquered by Pharnaces, the son of Mithridates. At the beginning of the middle ages it belonged to the dominions of the Goths, and afterwards of the Khazars, a Turkish people, renowned for their industry and commerce. It was then known under the name of Tamatarkha. In the tenth century a Russian prince founded there the petty kingdom of Tmutarakán; the greater part of the inhabitants however were Tsherkessians and Turks, and, from the time of the invasion of the Mongols, the Tartars remained the only masters of it. Numerous old tombs still attest their long residence on the island. They were at last driven out by the Russians, who re-peopled the country with Cossacks in order to defend it against the invasions of the Tsherkessians beyond the Kuban. There are now only two towns: Tmutarakán, the Tamatarkha of the middle ages and the Phanagoria of the Greeks; and the present town of Phanagoria, which was built by the Russians on the shore of the bay of Taman, three miles east from Tmutarakán, on account of its harbour being deeper than that of the latter town.

(Pallas, *Bemerkungen auf einer Reise in den Südlichen Provinzen des Russischen Reiches*; Dr. Clarke, *Travels in Russia*. The best map of the island of Taman is contained in the great Atlas of Russia published at St. Petersburg; the map in Pallas's *Bemerkungen* is also good; that of Dr. Clarke has some interest for lovers of antiquities, but is far from being geographically exact.)

TAMARICACEÆ. [ANT-EATER, vol. ii., p. 65.]

TAMARICACEÆ, a small natural order, belonging to the syncarpous group of polypetalous Exogens. The species are either shrubs or herbs, having straight rod-like branches, with alternate entire leaves, resembling scales; the flowers are in dense spikes or racemes. The calyx is 4-5-parted, persistent; the petals inserted into the calyx, both with imbricate aestivation; stamens hypogynous, distinct or united, equal in number with the petals or twice as many; ovary superior, with a short style and 3 stigmas; fruit a capsule, 3-valved, 1-celled, with numerous seeds, which are comose; embryo straight with an inferior radicle.



Tamarix germanica. a, cutting, showing the straight branches and scale-like leaves; b, single flower; c, flower with calyx and corolla removed showing monadelphous stamens; d, capsule with comose seeds escaping.

This order is placed by De Candolle with those which have perigynous stamens, but there is no doubt now that

it has hypogynous stamens, although closely related to the perigynous order Illecebraceæ. It has also affinities with Portulacæ, Lythraceæ, Onagraceæ, and Reaumuriaceæ.

The species are found only in the Old World; the greatest number being met with in the basin of the Mediterranean. According to Ehrenberg, the order is bounded on the south by the 8th or 9th parallel of N. lat., and on the north by that of 50° and 55°, in Siberia, Germany, and England.

The plants of this order are innocuous, and all are more or less astringent; and their ashes after burning are remarkable for possessing a large quantity of sulphate of soda. *Myricaria Germanica* is recommended as a diuretic. [TAMARIX.]

TAMARINDS, Medical Properties of. Of the two varieties of the only species of this genus, the fruit is much larger in the East Indian than the West Indian. The shell being removed, there remains the flat square hard seeds, imbedded in a pulp, with membranous fibres running through it. In the East Indies the pulp is dried, either in the sun, and this is used for home consumption, or with salt added, and dried in copper ovens, which kind is sent to Europe. (Crawford's *Indian Archipelago*.) This sort, called natural tamarinds, is much darker and drier than the West Indian, which are called prepared tamarinds.

The West Indian tamarinds reach maturity in June, July, and August, when they are collected, and the shell being removed, they are put into jars, either with layers of sugar put between them, or boiling syrup poured over them, which penetrates to the bottom. Prepared tamarinds therefore contain much more saccharine matter than the others. According to Vauquelin, prepared tamarinds contain per cent. citric acid 9.40, tartaric acid 1.55, malic acid 0.45, bitartrate of potash 3.25, sugar 2.5, gum 4.7, vegetable jelly (pecten) 6.25, parenchyma 34.35, water 27.55. This prepared pulp has a pleasant acid astringent taste, with a somewhat vinous odour.

It presents an example of one of those natural combinations of gummy, saccharine, and acid principles which are of such great utility in hot climates. It is used not only in India, but in Africa, as a cooling article of food, and the travellers across the deserts carry it with them to quench their thirst. In Nubia it is allowed to stand in the sun till a kind of fermentation takes place: it is then formed into cakes, one of which dissolved in water forms a refreshing drink. In India a kind of sherbet is made with it, and by the addition of sugar it becomes a source whence vinegar is readily obtained. In the fevers and bilious complaints, and even dysenteries of these climates, it proves highly serviceable; in small quantity it acts as an astringent, but in larger it proves laxative. Boiling water poured over tamarinds yields a drink which is very grateful in the inflammatory complaints of our own country, particularly in the bilious fevers of autumn. An agreeable whey may be made with it, by boiling two ounces of tamarind-pulp with two pints of milk. Tamarinds are frequently given along with senna, but they are said to lessen its purgative property. They form an ingredient in the *confectio sennæ* and *confectio cassiæ*.

In times of scarcity in India the seeds are eaten, being first toasted and then soaked for a few hours in water, when the dark skin comes easily off; they are then boiled or dried, and taste like common field-beans.

TAMARINDUS, the name of a genus of plants belonging to the Rectembryous division of the natural order Leguminosæ. It possesses the following characters:—calyx cleft, tubular at the base, the three upper lobes are reflexed, the two lower ones joined together, but usually indented at the apex; petals 3, alternate with the three upper lobes of the calyx, the middle one cucullate and the lateral ones ovate; the stamens are 9 or 10 in number, two or three of which are longer than the others, united at the base, and bearing anthers, whilst the remainder are sterile; the fruit is a legume seated on a pedicel, 1-celled, compressed, with from 3 to 6 seeds, and the valves filled with pulp between the endocarp and epicarp, their inner and outer lining; the seeds are ovato-quadrate in form, possessing cotyledons unequal at the base.

There are only two species belonging to this genus, both of which are trees with abruptly pinnate leaves, bearing many pairs of small leaflets and racemes of flowers.

The *Tamarindus Indica*, the East Indian Tamarind, was the earliest known species, for a knowledge of which, in

Europe, we are indebted to the Arabians. Dr. F. Hamilton, in his commentary on the *Hortus Malabaricus*, remarks on the specific designation of this plant, that it is 'a vile pleonasm,' the fact of its being Indian being referred to in the generic name *Tamar-Indus*, whence our word Tamarind. The Indian Tamarind is distinguished by its elongated legumes, which are six times or more longer than they are broad. It is a native of various districts in the East Indies and also of the tropical parts of Africa. It forms a handsome tree with spreading branches bearing leaves of a light colour and flowers with a straw-coloured calyx and yellow petals, streaked with red: the filaments of the stamens are purple and the anthers brown. The timber of this tree is very firm, hard, and heavy, and is applied to many useful purposes in building.

The second species is the *Tamarindus Occidentalis*, the West Indian Tamarind, which is distinguished from the other by possessing short legumes not more than three times longer than they are broad. It is a native of South America and the West India Islands, forming also a large spreading tree, with yellowish flowers streaked with red and purplish stamens.

These plants may be grown in this country, by sowing the seeds, which can be easily obtained, in a hot-bed, and when the young plants obtain a height of two or three inches, planting them out in separate pots. For the medical and dietetic properties of the tamarind see TAMARINDS.

TAMARIX, the name of a genus of plants, the type of the natural order Tamaricaceæ. It has a 4- or 5-parted calyx; 4 or 5 petals; 4 or 5 stamens alternating with the petals, united at the base; a tapering ovary with 3 stigmas; erect tufted seeds, the tuft being composed of a number of hairs proceeding from the apex of the seed. The species have generally paniculated spikes of small flowers of a red colour.

T. gallica, the French tamarisk, is a glabrous glaucous shrub, with minute acute leaves clasping the stem, with slender lateral spikes of flowers, five times longer than broad. This species is a native of France, and also along the Mediterranean: it is also a native of the coasts of Cornwall, Hampshire, and Sussex, in England. Ehrenberg has described a great number of varieties of this species, one of which, the *T. g. mannifera*, known by its glaucous powdery appearance, he says, produces the manna of Mount Sinai. This manna however does not contain any crystallizable mannite, but, according to Mitscherlich, consists of nothing more than a mucilaginous sugar. This is one of the species of this genus remarkable for the large quantity of sulphate of soda which its ashes contain.

T. Indica, the Indian Tamarisk, is a glabrous greenish plant, with stiff twiggy branches; short ovate acute leaves with white edges; elongated spikes of flowers, with bracts shorter than the flowers and longer than the pedicels, and stamens longer than the corolla. This plant is a native of the East Indies. It is subject to the attacks of a cynips, which produce galls that possess astringent properties, and, according to Dr. Royle, they are on this account used in medicine by the native doctors of India. The same property also renders them valuable in dyeing. Other Indian species of the Tamarisk produce galls, which are used for the same purposes as those of *T. Indica*.

T. Africana, the African Tamarisk, is a glabrous glaucous shrub, with lanceolate imbricated leaves, with dense, scaly, simple, sessile racemes, with ovate chaffy bracts, and a 3-valved capsule. This is a native of the sands along the shores of the Mediterranean. It is found in Mauritiana, around the Bay of Naples, in Egypt, and in the Levant. It has very much the appearance of *T. Gallica*, but its flowers are larger, and bark darker. Like *T. Gallica*, its ashes yield a large quantity of sulphate of soda. The bark, as in most of the species, is slightly bitter and astringent, and has been used in medicine as a tonic.

T. Orientalis, the Eastern Tamarisk, is a tree attaining a height of from 10 to 20 feet: it is glabrous all over, with minute, distant, sheathing, mucronate leaves, with slender lateral spikes of flowers, and a 4-valved capsule. This is a native of Arabia, Persia, and the East Indies, and is one of the largest and most elegant of the species of the Tamarisk. One of the finest specimens of this tree existing is at Babylon. The *T. Chinensis* appears to be a variety of this plant.

Nearly all the species are elegant and delicate shrubs

ing a prominent position in the shrubbery. The species do not require much care in their cultivation; they will grow in almost any soil or situation, and propagated by cuttings planted out in the open either in the spring or autumn, where they will strike root. Those requiring heat and protection rest in a soil composed of loam and peat, and may be propagated by cuttings placed in sand under a glass.

PUFF-BIRDS, Cuvier's name for the *Puff-Birds*. Swainson, in addition to his description in the *Illustrations*, speaking of these birds in his *Illustration*, says, that they sit for hours together on a withered branch, from which they dart upon such as come sufficiently near, and that the Hermit (*fonassa*, Vieill.) have similar habits. [BARBETS, p. 434; KINGFISHERS, vol. xiii., p. 227.]

AULIPAS. [MEXICAN STATES.] BOW, a province of Great Russia, is situated between 30° 30' and 55° 20' N. lat., and between 39° 40' and 53° long. The area is 24,200 square miles, and the population 1,600,000. It is bounded on the north by Novgorod, and for a very small distance on the east by Wladimir; on the south by Woronesh; on the west by Riasan, Tula, and Orel (by the two last for a small distance); and on the east by Penza.

The government is a uniformly level country, without mountains, large rivers, or considerable lakes: on the north and east are great forests and on the south extensive marshes.

The soil in the northern half is sandy, marshy, and in the southern part it mostly consists of loam and mould, and is fertile and productive. The climate produces excellent pasturage, and when they have been dug under cultivation, make good arable land: the steppes are designated as steppes only because they are composed of wood. The river Oka enters the government from the north, but passes only through one circle, where it is joined by the Mokscha, a considerable stream of which the Oka is a tributary. The Oka runs northwards to join the Don.

Another great Russian river, the Don, passes through a small part of the government. In the forests on the north there are marshes which might easily be drained.

The mineral-waters at Lepetzka are celebrated and frequently frequented. The climate is temperate and not so cold in winter than in Tula and Riasan, and is owing to the slope of the open plains towards the north.

The northern part of Tambow has a poor soil, but it is very fertile, and this province ought to be cultivated by a better system of cultivation were it not for the soil. In the south the land does not require to be manured, and needs no manure, but acquires from the manure of cattle sufficient strength to produce fresh crops, and generally yield from five to ten fold. In the north it is indeed not manured, but after yielding five or six fold it is fallow for some years; and then it produces a crop to five fold. All kinds of corn usually grown in Russia, wheat, rye, oats, millet, and buckwheat, and other pulse; poppies, great quantities of hemp, flax, and hemp are cultivated only in some parts.

Horticulture is in a very backward state, for though there are many gardens, only the most ordinary vegetables are cultivated; some hops are grown in the garden, but there is little fruit, and that of the most ordinary kind.

Though the forests are so extensive, it is not so in the northern circles that there is sufficient wood for building. The crown forests supply timber for the government: in their vicinity the inhabitants are for the most part carpenters, coopers, and cartwrights, or employ themselves in making pitch, tar, lamp-black, and charcoal. The tanning of cattle is carried on to a very great extent in the pastures and meadows of the steppes. The government from Tambow to Nova Khopertskaja-Krepost is with immense herds of oxen and horses. Oxen are bred for draught, and great numbers are fattened for the market. Sheep and swine are bred in great numbers, and the wool of the sheep is coarse: of late years the wool has been improved by the importation of merinos. Poultry suffices for the consumption of the inhabitants: there is little game, and fish is by no means abundant.

Among the wild animals are the marmot and the beaver. Great quantities of bees are kept. The minerals are lime, freestone, iron, and some saltpetre.

C., No. 1491.

The manufactures of this government are unimportant: the peasantry barely make their own clothing: in some parts they manufacture wooden utensils, and agricultural implements, which they take to the fairs. A great advance has however been made within the last twenty-five years. The brandy-distilleries are numerous. The export trade in the products of the country is very considerable. The principal articles are wheat (1,200,000 chetwerts, or 864,000 English quarters), cattle, honey, tallow (400,000 poods, or about 500 English cwt.), butter, cheese, wool, hemp, iron, brandy, hides, coarse cloth, and wooden wares. Properly speaking there is no great commercial town. Tambow, Selatma, and Morschansk alone have some commerce with foreign countries.

The great majority of the inhabitants are Russians. There are some thousands of converted Tartars and Mordwins, and a few gypsies. These Tartars and Mordwins live in the same manner as the Russians, but retain their own dialect, and live apart from the Russians, and generally intermarry with their own people. The religion of the Mohammedan Tartars requires a different mode of life. Among these various nations the Tartars are the most civilised, have the most knowledge, and the purest morals, and enjoy the most prosperity.

Education is at a low ebb. According to Schnitzler, only 1 out of 325 of the population receives any school instruction. The only printing-office belongs to the government.

The Greek church is under the bishop of Tambow and Schazk, who has in his diocese 739 parishes and 6 monasteries. The Mohammedan Tartars have their mosques, imams, and teachers.

Tambow, the capital of the government, is situated nearly in the centre of the province, on the river Zna, in 52° 44' N. lat. and 41° 45' E. long. It is a large town, with 20,000 inhabitants, and was founded in 1636, as a bulwark against the Nogay Tartars. Scarcely any traces of the ancient fortifications now remain. There is nothing remarkable in the town, which has however been much improved in its appearance since the beginning of this century. Almost all the houses are built of wood: the principal buildings are the monastery of Our Lady of Casan, in which there are two churches; seven stone and six wooden churches, the gymnasium, and the civil hospital. There is a military school, founded and endowed by the nobility in 1802, a seminary for priests, and a district school. The bishop resides in this city. The inhabitants manufacture shawls, kersey, sailcloth, cordage, and woollen cloth; and there is an Imperial alum and vitriol manufactory. The inhabitants carry on some trade, but their chief occupation is agriculture.

The following are the other chief towns. Jelatma, the most northerly town in the government, situated on the left bank of the Oka, carries on by means of that river a very great trade with Moscow: it has ten churches, eight of which are of stone: the inhabitants, 6000 in number, have some manufactures of woollen cloth, vitriol, and sulphur. Koslow, situated on the Lesnoi Woronesh, has above 8000 inhabitants, who follow various trades and professions: near the town is the convent Troitzkoi, where a great annual fair is held. There are eight churches, of which five are of stone: the principal trade of the town is in oxen, salt meat, and hides. Lipetsk, on the Woronesh, near the north extremity of the government of that name, a town with 6500 inhabitants, is celebrated for its mineral-waters, which were first used in the reign of Peter the Great. Morschansk, a town of 6000 inhabitants, situated on the Zna, has manufactures of linen, sail-cloth, cordage, and tallow, and a brisk trade in corn, cattle, and honey. (Hassel, *Geography*; Stein; Horschelman; Schubert; Schnitzler.)

TAMBURI'NI, PIETRO, born at Brescia, in 1737, studied in his native town, took holy orders, and was made professor of philosophy, and afterwards of theology, in the episcopal seminary of Brescia. After filling those chairs for twelve years, he was invited to Rome, where Clement XIV. (Ganganelli) made him director of the studies of the Irish College, in which situation he remained for six years. In 1778 he was recalled to Lombardy by the empress Maria Theresa, and appointed professor of theology in the university of Pavia, and at the same time director of the studies of the German Hungarian college in that city, and also censor of the press. In 1795 he was

made Professor Emeritus, with a pension. In 1797, when the French invaded Lombardy, Tamburini was obliged by the new government to resume active duties at Pavia, as professor of moral philosophy and of 'jus naturæ,' an arduous tax in those times of confusion of ideas and of barefaced licentiousness. Tamburini boldly fulfilled his duties, and effected some good by proclaiming wholesome principles from his chair. Shortly afterwards his chair was suppressed, but he was appointed rector of the lyceum of his native town, Brescia. When Bonaparte assumed the government in France and North Italy, Tamburini was sent again to Pavia as professor of moral philosophy and of 'jus naturæ et gentium,' in which chair he continued for eighteen years, till some years after the Restoration, when the emperor Francis made him again Professor Emeritus and præsul of the faculty of law and politics in the university of Pavia. Tamburini was also a knight of the order of the Iron Crown. He died at Pavia, in March, 1827, at ninety years of age, a few days after the death of his brother professor, Volta. His remains were buried with the greatest honours, being followed to the grave by the whole of the professors and above six hundred students, with marks of sincere respect and deep regret.

The work for which Tamburini is mostly known is 'Idea della Santa Sede,' published anonymously at Pavia, in 1784. An extract from the author's preface will convey some idea of the nature of this work: 'It very often happens that to the most common and hacknied expressions a vague and indeterminate meaning is attributed. A word was originally fixed upon to signify a certain thing. The idea of it was perhaps clear and precise in its origin, but as in the course of time the ideas of men change, the word is still retained, though people attach to it different meanings. Hence obscurity and confusion and interminable disputes arise, and still the sound of the disputed word is kept up, without conveying any distinct idea of what it means. Numberless examples might be quoted of such an occurrence. For instance, in our own times everybody speaks of the Holy See, the Apostolic See, the chair of St. Peter, the Roman church, which are so many expressions signifying the same thing, and which in ancient times expressed a simple and clear idea, but which now convey to the minds of people the most vague and indeterminate notions. Things the most disparate are identified; people confound one subject with another, the see with the incumbent, the chair with the court of Rome, the court with the church; and from this medley arises a confusion of ideas through which every decree that proceeds from Rome becomes invested with the most respectable authority of the chair of St. Peter, of the Apostolic See, of the church of Rome—a confusion followed by the most pernicious consequences not only to local churches, but also to the universal church, and to the Apostolic See itself. In order to support certain decretals which emanated from Rome, some shortsighted theologians have attributed to the Roman See new prerogatives unknown to the earlier ages of the church, and they have had recourse to a supposed infallibility. . . . Other men have contested these prerogatives, and in the warmth of the controversy the real claims of the Holy See have been overlooked and forgotten. . . . One party has maintained that, on the plea of infallibility, every decision emanating from Rome ought to be received with blind obedience, whilst the other party has imagined that by overthrowing the privilege of infallibility every authority ascribed to it can be boldly denied. . . . Both these extremes proceed from the want of just and exact notions on the nature, the character, and the properties of the Holy See. The present work is intended to establish these notions. A little French book fell into my hands, entitled 'Dissertation Canonique et Historique sur l'Autorité du Saint Siège, et les Décrets qu'on lui attribue.' In the first part the author has well explained the idea of the Holy See and of the Congregations sitting at Rome; and in the second part he has maintained the primacy of that see. I have adopted the most important principles of this little work, compressing or enlarging its various parts, and fitting the whole to the wants of our times and country. I have explained also the essential rights annexed to the primacy of the Roman see, and have given some general rules in order to calculate the value and merit of the Roman decretals, and to make our own conduct prac-

tically harmonize with the obedience which we owe to the authority of the see of Rome.'

At the appearance of Tamburini's work it was stigmatized as Jansenistical, although the author has not gone perhaps so far as some of the French Jansenists, or as Bishop Ricci and his synod of Pistoia. [JANSENISTS; Prus VI.] The reasoning is closely argumentative, and supported by numerous references. Several refutations of it were published at Rome and other towns of Italy. The other works of Tamburini are—1, 'Introduzione allo Studio della Filosofia Morale,' Milan, 1797; 2, 'Lezioni di Filosofia Morale e di Naturale e Sociale Diritto,' 4 vols., Pavia, 1806-12; 3, 'Elementa Juris Naturæ,' Milan, 1815; 4, 'Cenni sulla Perfeibilità dell' Umana Famiglia,' Milan, 1823; in which the author refutes the exaggerated notions of indefinite perfectibility and universal happiness in human societies. The philosophy of Tamburini is of the Eclectic kind.

(Defendente Sacchi, *Varietà Letterarie*, vol. i.; Maffei, *Storia della Letteratura Italiana*, b. vi., ch. 13; *Antologia di Firenze*, Nos. 39, 76.)

TAME, River. [STAFFORDSHIRE.]

TAMER, River. [CORNWALL.]

TAMERLANE. [TIMUR.]

TA'MIAS. [SQUIRRELS, vol. xxii., pp. 398, 399, &c.]

TAMMEAMA. [SANDWICH ISLANDS.]

TAMPI'CO. [MEXICAN STATES.]

TAMUL. [HINDUSTAN, p. 228.]

TAMUS, the name of a genus of plants belonging to the natural order Dioscoreaceæ. This genus is dioecious, the stamens growing on one plant, and the pistils on another. The flowers are alike in having a perianth, which is 6-parted, the calyx and corolla being undistinguishable. In the male flowers there are 6 stamens. In the female flowers the remains are seen of 6 abortive stamens; the ovary is trilocular; the style trifid, with 3 stigmas: the fruit a berry. This genus is supposed to be the *Uva Taminiæ* of Pliny: hence its present name.

Tamus communis, the common Black Briony, has undivided cordate, acuminate leaves, and is a very common plant in hedges and thickets throughout Europe. It is a frequent plant in England. It has a long, winding stem, spreading in all directions, and reaching from branch to branch of hedges and thickets: its flowers are greenish-white; the fruit is of a red colour, and hangs in bunches from its trailing branches. The berries are likely to be plucked and eaten by children: they are not however poisonous, although the whole plant contains a bitter acrid principle, which renders it unwholesome. This acrid principle is destroyed by heat; and as the roots of this plant contain a great deal of starch or fecula, a wholesome and nutritious food may be obtained from them by washing and boiling. On the surface of the roots are found blackish tubercles, which contain a larger quantity of acrid principle than the rest of the plant, and these should be removed previous to preparing the roots for eating. The young shoots of this plant taste, when boiled, like asparagus, and are eaten by the Moors with oil and salt.

TAMWORTH, a municipal and parliamentary borough on the border of Staffordshire and Warwickshire: the municipal borough, which includes the greater part of the town, and the parish, which is far more extensive, having an area of 12,920 acres, are divided between the two counties: the parish is partly in the northern and partly in the southern division of Offlow hundred in the county of Stafford, and partly in Hemlingford hundred in Warwickshire. The church is in Staffordshire, on which account the town is commonly described as being in that county. Tamworth is 102 miles in a direct line north-west of the General Post-office, London, or 129 miles by the London and Birmingham Railway to Hampton in Arden, and from thence by the Birmingham and Derby Junction Railway.

The town first comes into notice in the time of the Heptarchy: several of the Mercian kings appear, from the date of charters granted by them, to have had their residence at Tamworth. In the Danish wars a fort was built here in the reign of Edward the Elder (A.D. 913) by his sister Ethelfleda, lady of Mercia, who died at Tamworth, A.D. 920, and Mercia passed under the direct dominion of Edward, who received the submission of the Tamworth men, A.D. 922. Shaw (*Hist. of Staffordshire*) ascribes to

da the mound on which the present ruins of the stand, but the ruins themselves are of later date. I ditch, yet visible, called 'the king's dyke,' which nds the town on three sides, is supposed by Shaw to yet greater antiquity than the time of Edward. In xon 'Chronicle' the town is called Tamaworthige, veorthige, Tamanweorthe, or Tamweorthe: in other t writings the orthography is still further varied. lace is not described in 'Domesday;' but the 'bur-(burgesses) of Tamworth, are mentioned in that , in the notice of other places.

r the Conquest, the castle and adjacent territory ranted to Robert Marmion, hereditary champion to kes of Normandy; and afterwards, on the extinction male line of his family in the time of Edward I., to the family of Frevile. The castle now belongs quis Townshend. Sir Walter Scott has enumerated orth tower and town' among the possessions of his us Marmion: but the family had become extinct efore, as observed by Sir Walter in the Appendix to m.

town stands on the north bank of the rivers Tame nker, just at their junction, and consists of several not very regularly laid out. The streets are paved, d not been lighted when the Municipal Boundary issioners' Report was drawn up (*Parl. Papers for* the inhabitants were however about to assess lves for the purpose. 'The church is a large and me edifice, with a fine tower, and a crypt under the church. Some portions are of decorated date, me perpendicular, and both good: some of the vs have had very fine tracery. In the tower is a

ouble staircase, one from the inside and one from , each communicating with a different set of floors tower.' (Rickman's *Gothic Architecture*.) The e of the castle are on a mound close to the Tame: e of various periods, and some modern buildings een added to adapt the whole to the purposes of a residence: the castle commands a fine prospect. are some Dissenting places of worship; an alms- founded by Guy, the founder of Guy's Hospital in ark; a town-hall, with a small and inconvenient eath; and two bridges, one over the Tame, the ver the Anker.

population of the municipal borough in 1831 was hat of the whole parish (containing several hamlets vnships) 7182. Some manufactures are carried on; : whole number of men employed in them in the was, in 1831, only 38. Some coals and brick-earth g in the neighbourhood, and bricks and tiles are

The market is on Saturday: there are three char- aires for cattle and merchandise, and several new r cattle only; some of them held at Fazeley in the

The Coventry Canal passes near the town. orth was a borough by prescription; but the owing declined and ceased to be regarded as a com- n, was incorporated anew by letters patent of

Elizabeth: the governing charter is one of Charles the Municipal Reform Act the borough has four and twelve councillors, but is not to have a n of the peace except on petition and grant.

inal jurisdiction of the corporation had fallen use before the passing of that act, as well as the of record: quarter-sessions were held, but for civil es only.

worth first sent members to parliament in the reign abeth: it still returns two members. The number on the register in 1835-6 was 531: in 1839-40,

living of Tamworth is a perpetual curacy, of the eary value of 170*l.*, with a glebe-house. There are parish the perpetual curacies of Fazeley, Wiggind Wilnecote, of the clear yearly value of 235*l.* (glebe-house), 92*l.* and 90*l.* respectively: the curate worth presents to Wigginton and Wilnecote. There so in the parish two chapelries, Amington and

were in the borough, in 1833, three endowed and nendowed day-schools, with 183 children, namely 21 girls, and 20 children of sex not stated; and y-schools, with 203 children, viz. 97 boys and the rest of the parish were one infant-school, supported by subscription, with 88 children, namely

41 boys and 47 girls; ten day-schools of all kinds, with 96 boys, 80 girls, and 80 children of sex not stated, making 256 children in all; and three Sunday-schools, with 288 children, namely 150 boys and 138 girls. (*Shaw's Staf-fordshire; Parliamentary Papers*.)

TANA-ELF. [TRONDHEIM.]

TANACE'TUM, a genus of plants belonging to the natural order Compositæ, and the suborder Corymbiferae or Asteraceæ. The involucre is imbricated and hemispherical. The receptacle is naked; the flowers of the ray are 3-toothed, those of the disk 5-toothed, tubular, and hermaphrodite. The fruit, an achenium, is crowned with a membranous margin, or pappus. The flowers are yellow.

The most common species is the *Tanacetum vulgare*, common *Tansy*. It has bipinnatifid leaves, with serrated sections or lacinia. This plant is abundant in Great Britain and throughout Europe, on the borders of fields and road-sides. It possesses in a high degree the bitterness of the whole order Compositæ, which, in the section Corymbiferae, is combined with a resinous principle. It is recommended and has been extensively used in medicine as an emmenagogue and anthelmintic. Although the flavour and smell of this plant are both at first disagreeable, a taste for it may be acquired, and it has been used in cookery for the purpose of flavouring puddings and sauces. The young shoots yield a green colouring-matter, and are used by the Finlanders for the purpose of dyeing their cloths of that colour. It is said that if meat be rubbed with the fresh leaves, it will not be attacked by the flesh-fly.

TA'NAGERS. The genus *Tanagra* of Linnæus stands, in the 12th edition of the *Systema Naturæ*, between *Emberiza* and *Fringilla*, in the order *Passeres*.

Cuvier characterises the genus as having a conical bill, triangular at its base, slightly arched at its *arête*, and notched towards the end: wings and flight short. He observes that they resemble our sparrows in their habits, and seek for seeds as well as berries and insects. The greater part, he remarks, force themselves upon the attention of the spectator of an ornithological collection by their vivid colours. He places the genus between the *Drogonos* (*Edolius*, Cuv.) and the Thrushes (*Turdus*, Linn.), thus subdividing it:—

1. The Euphonous or Bullfinch Tanagers (*Euphones*, ou *Tangaras Bouvreuils*).

These have a short bill, presenting, when it is seen vertically, an enlargement on each side of its base: tail short in proportion.

Examples, *Tanagra violacea*, *Cayennensis*, &c.

2. The Grosbeak Tanagers.

Bill conic, stout, convex, as wide as it is high; the back of the upper mandible rounded.

Examples, *Tanagra magna*, *atra*, &c.

3. Tanagers, properly so called.

Bill conic, shorter than the head, as wide as it is high, the upper mandible arched and rather pointed.

Examples, *Tanagra Talao*, *tricolor*, &c.

4. Oriole Tanagers (*Tangaras Loriots*).

Bill conic, arched, pointed, notched at the end.

Examples, *Tanagra gularis*, *pileata*, &c.

5. Cardinal Tanagers.

Bill conic, a little convex, with an obtuse projecting tooth on the side.

Examples, *Tanagra cristata*, *brunnea*, &c.

6. Ramphocela Tanagers.

Bill conic, with the branches of the lower mandible convex, backwards.

Examples, *Tanagra Jacapa*, *Brasilica*, &c.

The views of Mr. Vigors on the subject of this group will be found in the article FRINGILLIDÆ.

Mr. Swainson remarks that the *Tanagrinae*, or *Tanagers*, form that group which is probably the most numerous, as it certainly is the most diversified of all those in the comprehensive family of the *Fringillidæ*. As the dentostral division of that family, it is, he observes, typically distinguished from all the others by the bill having a distinct and well-defined notch at the end of the upper mandible, the ridge or culmen of which is much more curved than the gonyx; or, in other words, the culmen is more curved downwards than the gonyx is upwards: this inequality, he further states, as in the genus *Ploceus*, very much takes off from that regular conic form of bill so highly characteristic

of the greater number of the finches; so that the combination of these two characters is, he thinks, perhaps the best distinction of the whole group. Another peculiarity, he adds, of these birds consists in their geographic range; for the whole, as far as has hitherto been ascertained, are natives of the warmer parts of America, being most abundant in those regions nearest to the equinoctial line. 'They are,' says Mr. Swainson in continuation, 'in general small birds, the largest being intermediate between a sparrow and a thrush, while the majority do not exceed the size of a linnet; some few are even smaller. It is quite evident, from the great strength of bill possessed by some, and the notch which is conspicuous in all, that these birds feed upon seeds and creeping insects picked from the branches of trees, for very few of them are ever seen upon the ground. Their colours in general are bright; and, in a large number, particularly rich and beautiful. The little birds forming the genus *Aglaia*, in fact, are ornamented with the most vivid hues or glossed with rich reflections of gold, rendering them inferior only to the Humming Birds. Some possess considerable vocal powers; and the notes of the subgenus *Euphonia*, as its name implies, are said to be particularly musical. The impossibility however of providing the Tanagers with their native sweet food has prevented them from ever being brought alive to the European menageries, to which their beauty would render them the greatest ornaments.'

Mr. Swainson then dwells on the obscurity which attends the examination of this group, which he states to be one of the most difficult to be understood in the whole circle of ornithology. He points out, for instance, that the comparative strength of the bill is so variable in the same subgenus, that such variation, indicative of genera in other families, is in this no more than a discrimination of sections or species. Nothing, according to him, can illustrate this fact more than the affinity between *Pitylus* and *Turdicola*. Looking to the types of each, he observes, we should say that they did not belong even to the same subfamily; for the bill of the first is nearly as large as in the hawfinches (*Coccothraustes*, HAWFINCH), while that of *Turdicola* is so comparatively slender that it seems more akin to the LARKS than to the Tanagers; and yet, he remarks in continuation, between these two extremes or types, he had, when he wrote, before him such a perfect series of graduated forms, wherein not only the bill, but all the other subordinate characters of the two groups, progress in such a perpetual and almost imperceptible manner, that he was actually at a loss to know where *Turdicola* ends and *Pitylus* begins. The foregoing affinity being admitted, and it should be remembered that some of the best ornithological writers have placed it as a genus in a totally different family, Mr. Swainson next proceeds to inquire into the cause of so remarkable a variation in the bill of such closely-united species. He first states that nearly the whole of the seed-eating birds of Tropical America are composed of the Tanagers, which, in those regions, supply the place of the other finches so abundant in all parts of Europe. The innumerable small and hard fruits produced in the American forests are, he observes, the appointed food of the Tanagers, the parrots living principally upon the larger nuts, and the bill of the former birds is constructed accordingly. After noticing the disparity of the bills in the finches, taking the common linnet and the hawfinch for example, he remarks how little reliance can be placed on such diversity in determining genera: but this, he observes, will not explain the great difference which often exists in the size and plumage of species which all writers agree in arranging within the limits of the same subgenus; and he takes the restricted genus *Pitylus*, Cuv., as an example. Some of the species of that genus are green, some black, others grey; and in size they vary from the dimensions of a sparrow to those of a small thrush.

The doubts which, in Mr. Swainson's opinion, hang over the correctness of the views which he entertained with respect to the natural affinities of these birds, may, he says, be said to hinge almost entirely upon his not having been able to examine specimens of *Fringilla Zena*, which has certain peculiarities which lead him to expect that it forms the type of one of the principal divisions among the Tanagers, or that it connects his genus *Aglaia* with *Pipillo*. On the first supposition, *F. Zena* would, according to Mr. Swainson, constitute the passage from the true sparrows (*Pyrgita*) to the subgenus *Tanagra* proper; while by the

second, *Pipillo* would stand intermediate between *Aglaia* and *Tanagra*, and thus constitute the rasorial genus of the whole subfamily; and this latter arrangement appears to him to be the natural one. He considers that the two typical groups or genera are *Tanagra* and *Phænisoma*; while those which he thinks aberrant are *Nemosia*, *Aglaia*, and *Pipillo*. It was only between the two last of these that he had not as yet discovered any affinity sufficiently strong to justify the belief that these five genera form a circle more or less complete; the difficulty being how to connect *Aglaia* with *Pipillo*. He then takes a review of the genera, for which we must refer our readers to the work itself; and, in the *Synopsis* at the end of the volume, makes the *Tanagrinae*, which he places between the *Coccothraustinae* and the *Fringillinae*, consist of the following genera and subgenera, all of which he characterizes:—

Tanagrinae.

Subfamily Character.—Bill equally conic; the upper mandible more or less arched, and very distinctly notched. Feet formed for perching. Claws broad and fully curved.

Genera.

Turdicola, *Tanagra* (with the subgenera *Pitylus*, *Tanagra*, and *Ramphopsis*). *Phænisoma* (with the subgenera *Phænisoma*, *Tachyphonus*, and *Leucopygia*). *Nemosia*. *Aglaia* (with the subgenera *Euphonia* and *Tanagrella*). *And Pipillo* (with the subgenus *Arremon*). (*Classification of Birds.*)

The Prince of Canino (*Birds of Europe and North America*) places the *Tanagrinae* between the *Fringillinae* and the *Emberizinae*. *Pyrranga* is the only genus recorded as belonging to the *Tanagrinae*.

Mr. G. R. Gray makes the *Tanagrinae* the third subfamily of the *Fringillidae*, arranging it between the *Coccothraustinae* and *Fringillinae*. The following genera are enumerated by Mr. Gray as belonging to the third subfamily:—

Emberizoides, Temm.; *Pipilo*, Vieill.; *Embernagra*, Less.; *Arremon*, Vieill.; *Cissops*, Vieill.; *Pitylus*, Cuv.; *Tanagra*, Linn.; *Saltator*, Vieill.; *Spindalis*, Jard. and Selby; *Ramphopsis*, Vieill.; *Lamprotes*, Sw.; *Pyrranga*, Vieill.; *Lanio*, Vieill.; *Tachyphonus*, Vieill.; *Nemosia*, Vieill.; *Tanagrella*, Sw.; *Euphonia*, Desm.; *Cularpiza*, G. R. Gray; *Stephanophorus*, Strickl.; *Cypsnagra*, Less.

Mr. Gray, with his usual industry, gives the numerous synonyms of each genus. (*List of the Genera of Birds*, 2nd edition, 1841.)

We select Nuttall's description of the *Scarlet Tanager*, or *Black-winged Summer Red-Bird*, *Tanagra rubra*, Linn. (subgenus *Pyrranga*).

The male is scarlet-red, with the wings and notched tail black: the base of the plumage is ash, then white. The female, young, and male in autumn, are dull green, inclining to yellow in the latter; yellow beneath; wings and tail dusky. Length about six inches and a half; alar extent ten inches and a half.

'This splendid and transient resident,' says Nuttall, 'accompanying fine weather in all his wanderings, arrives from his winter station in tropical America from the beginning to the middle of May, and extends his migrations probably to Nova Scotia as well as Canada. With the shy, unsocial, and suspicious habits of his gaudy fraternity, he takes up his abode in the deepest recesses of the forest, where, timidly flitting from observation, he darts from tree to tree like a flashing meteor. A gaudy sylph, conscious of his brilliance, and the exposure to which it subjects him, he seems to avoid remark, and is only solicitous to be known to his humble mate, and hid from all beside. He therefore rarely approaches the habitations of men, unless perhaps the skirts of the orchard, where he sometimes however builds his nest, and takes a taste of the early and inviting, though forbidden cherries.'

'Among the thick foliage of the tree in which he seeks support and shelter, from the lofty branches, at times, we hear his almost monotonous *tship-witee*, *tship-idee*, or *tshukadee*, *tshukadee*, repeated at short intervals, and in a pensive under-tone, heightened by the solitude in which he delights to dwell. The same note is also uttered by the female when the retreat of herself and young is approached; and the male occasionally utters, in recognition to his mate, as they perambulate the branches, a low whispering *'tuit*, in a tone of caution and tenderness. But besides these calls on the female, he has also, during the period of his incubation, and for a considerable time after,

musical strain, resembling somewhat, in the mellow-its tones, the song of the fiving Baltimore. The to which I have hearkened appear like 'tshooove ait, 'vehöwit wait, and 'wait, 'vehöwit rea wait, er additions of harmony, for which no words are :. This pleasing and highly musical meandering lelivered for hours, in a contemplative mood, in e tree with his busy consort. If surprised, they her, but soon return to their favourite station in iding boughs of the shady oak or hickory. This ; some resemblance to that of the Red-eyed Vireo npass and strain, though much superior, the 'wait ng whistled very sweetly in several tones, and with ; so that, upon the whole, our *Pyrranga* may be d as duly entitled to various excellencies, being to the farmer, brilliant in plumage, and harmo-voice.'

Food, &c.—The same author describes the nest ; built about the middle of May, on the horizontal ; of some shady forest-tree, commonly an oak, but es in an orchard tree) as but slightly put together, y framed of broken rigid stalks of dry weeds or u-twigs, loosely interlaced together, and partly ; narrow strips of Indian hemp (*Apocynum*), some grass-leaves, and pea-vine runners (*Amphicarpa*), rail materials; the interior being sometimes lined slender, wiry, brown stalks of the Canadian cistus (*hemum*), or with slender pine-leaves; the whole platted as to admit the light through the inter- The three or four eggs are dull blue, spotted with hree shades of brown or purple, most numerous the larger end. As soon as their single brood, fledged early in July, is reared, they leave for the nerally about the middle or end of August.

emale,' says this interesting author in continuation, great solicitude for the safety of her only brood; in approach to the nest, appears to be in great dis- apprehension. When they are released from her mediate protection, the male, at first cautious and now attends and feeds them with activity, being er indifferent to that concealment which his gaudy ems to require from his natural enemies. So to his now interesting brood is the Scarlet Tana- he has been known, at all hazards, to follow for ile one of his young, submitting to feed it atten- rough the bars of a cage, and, with a devotion :spair could not damp, roost by it in the branches me tree with its prison.'

ood of this species consists mostly of winged uch as wasps, hornets, and wild bees, the smaller eetles, and other *Coleoptera*. Seeds are supposed metimes resorted to, and they are very fond of und other berries.

August that the moult of the male, when ' he es his nuptial scarlet for the greenish-yellow livery male,' commences. (*Manual of the Ornithology nited States and of Canada*.)

IGRI'NÆ. [TANAGERS.]

AIS. [DON.]

IRO. [Po.]

RED, of Hauteville in Normandy, was a feudal ho lived in the latter part of the tenth and begin- he eleventh century. After doing military service e years under Richard the Good, duke of Nor- he retired to his hereditary mansion, where he or, and reared up a numerous family of twelve l three daughters. All his sons were remarkable omeliness, their great strength, and their courage. st, Serlon, followed William the Bastard in his of England, and the others went successively to u fortune in Apulia, where Rainulf, another Nor- enturer, had already obtained the countship of rom Sergius, duke of Naples. William, one of 's sons, called 'Fier à bras,' or strong of arm, became ' Apulia, and after his death, his brother Robert, 'iskard, or 'the wise,' became duke of Apulia and , and the founder of the Norman dynasty of Sicily. , Two, *History of*.] Their father Tancred died at eat age at Hauteville. Traces of the château of e according to old popular tradition, were still w years since in a pretty valley near Hauteville, s north of the town of Marigny, in the arrondisse- Coutances department of La Manche. (Gaultier

d'Arc, *Histoire des Conquêtes des Normands en Italie, en Sicile, et en Grèce*.)

TANCRED, son of Eudes, a Norman baron, and of Emma, sister of Robert Wiskard, duke of Apulia, ac- cording to some (Gaultier d'Arc, *Histoire des Conquêtes des Normands en Italie, en Sicile, &c.*), and nephew of Bohemund, son of Wiskard, and prince of Tarentum ac- cording to others (Giannone and the authorities he quotes), was serving with Bohemund under Roger, duke of Apulia, son and successor of Wiskard, at the siege of Amalfi, A.D. 1096, when the report of the great crusade which was pre- paring for the East determined Bohemund, who was not on good terms with Duke Roger, to join the Crusaders. Tancred followed him with a vast number of men from Apulia and Calabria. The exploits, true or fabulous, of Tancred, in Syria and Palestine, have been immortalized by Tasso in his poem of 'La Gerusalemme.'

TANCRED, king of Sicily. [SICILIES, Two, *History of*.]

TANGENT. In the article CONTACT we have given the first notion on this subject, which we now resume in a somewhat more general manner, annexing the usual de- tails of formulæ, but without proof.

It is usual to apply the word tangent to the tangent *straight line* only, on which see DIRECTION: generalizing the definition, it will be as follows:—Of all curves of a given species, or contained under one equation, that one (B) is the tangent to a given curve (A) at a given point, which passes through that given point, and is nearest to the curve (A): meaning that no curve of the given species can pass through the given point, so as to pass between (B) and (A), immediately after leaving the point at which the two latter intersect.

To ascertain the degree of contact of two curves which meet in a point, proceed as follows. Let $y = \phi x$ and $y = \psi x$ be the equations of the curves, and a the abscissa at the point of contact; so that $\phi a = \psi a$. At the point whose abscissa is $a+h$, the difference of the ordinates of the curves is, by Taylor's theorem,

$$(\phi'a - \psi'a)h + (\phi''a - \psi''a)\frac{h^2}{2} + (\phi'''a - \psi'''a)\frac{h^3}{2 \cdot 3} + \dots$$

as to which, generally speaking, it will be found that h can be taken so small that the series shall be convergent: if this be not so, the method of arresting the series given in TAYLOR'S THEOREM must be employed. Now of two

series of the form $Ah^m + Bh^{m+1} + \dots$ the value of that in which m is the greater will diminish without limit as com- pared with the other, when h diminishes without limit. Consequently, every curve $y = \psi x$, which has $\psi'a = \phi'a$, will approach, before the point of contact is attained, nearer to $y = \phi x$ than any other in which $\psi'a$ is not $= \phi'a$. Again, when $\phi'a = \psi'a$, those cases of $y = \psi x$ in which $\psi''a = \phi''a$, will approach nearer to $y = \phi x$ than any in which $\phi''a$ is not $= \psi''a$; and so on. Hence, to make $y = \psi x$ have the closest possible contact with $y = \phi x$ when $x = a$;—give such values to the constants in $y = \psi x$ as will satisfy as many as possible of the equations $\phi a = \psi a$, $\phi'a = \psi'a$, $\phi''a = \psi''a$, &c. consecutively from the beginning. This is a brief sketch, which can be filled up from any elementary work; and the following are the principal results:—

1. When the string of equations is satisfied up to

$\phi^{(n)}a = \psi^{(n)}a$, the contact is said to be of the n th order.

2. In contact of the n th order, the deflection $\phi(a+h) - \psi(a+h)$ diminishes with h^{n+1} , and vanishes in a finite ratio to it.

3. In contact of an even order, the curves intersect at the point of contact; in contact of an odd order, they do not intersect at that point.

4. When curves have a contact of the n th order, no curve, having with either a contact of an order inferior to the n th at the same point, can pass between the two.

5. A straight line, generally speaking, can have only a contact of the first order with a curve; and the equation to the tangent straight line of the curve $y = \phi x$, when $x = a$, is $y - \phi a = \phi'a(x - a)$. But if it should happen that $\phi''a = 0$, $\phi'''a = 0$, &c., up to $\phi^{(n)}a = 0$, then for that point the tangent has a contact of the n th order. Thus, at a point of contrary flexure the tangent has a contact of the second order, at least, with the curve.

6. A circle, generally speaking, can be made to have a contact of the second order with a curve, and the equation

of the most tangent circle, or circle of CURVATURE, to the curve $y = \phi x$, at the point $x = a$, is

$$\left(x - a + \frac{\phi/a(1+\phi'^2)^{3/2}}{\phi''/a} \right)^2 + \left(y - \phi a - \frac{1+\phi'^2}{\phi''/a} \right)^2 = \frac{(1+\phi'^2)^3}{\phi''^2}$$

This circle cuts the curve, generally speaking: if not, as for example, at the vertices of an ellipse, it is evidence that the circle has a contact of some higher and odd order. The centre of the circle of curvature is a point on the normal, being that at which the normal touches the evolute. [INVOLUTE AND EVOLUTE.]

Not only is the term tangent most generally applied to the closest straight line only, but frequently only to that portion of the straight line which falls between the point of contact and the axis of x . Again, the normal is a straight line perpendicular to the tangent, drawn through the point of contact: but this term also is frequently applied only to that portion which falls between the point of contact and the axis of x . It is with reference to this limitation that the terms subtangent and subnormal are to be understood: the first meaning the distance from the foot of the tangent to the foot of the ordinate; the second that from the foot of the ordinate to that of the normal. The formula for the subtangent is $\phi a \div \phi' a$; that for the subnormal $\phi a \times \phi' a$.

Let β be the angle made by the tangent with the axis of x ; usually the angle made by that part of the tangent which has positive ordinates with the positive side of the axis of x . Then β , at the point whose abscissa is x , is determined by the equation

$$\tan \beta = \frac{dy}{dx}; \text{ and subtangent} = y \frac{dx}{dy}, \text{ subnormal} = y \frac{dy}{dx}.$$

If we take the more general mode of measurement proposed in STURM, this equation remains equally true. Now, keeping strictly to that mode, let β be the angle made by the tangent with the axis of x , θ the angle made by the radius vector r with the axis of x , and μ that made by the tangent with the radius vector. It will be found, then, that in all cases

$$\mu = \beta - \theta, \quad \tan \mu = r \frac{d\theta}{dr}.$$

Unless the mode of attributing signs be carefully attended to, these last equations, though always considered as universally true, are not so in reality.

We now come to the consideration of a surface. The mode of defining contact of a given order resembles that adopted with reference to a curve. Thus if $z = \phi(x, y)$ and $z = \psi(x, y)$ be the equations of two surfaces coinciding when $x = a, y = b$, so that $\phi(a, b) = \psi(a, b)$, then if the point be taken at which $x = a + h, y = b + k$, the contact of the two surfaces is of the n th order, when the deflection

$$\phi(a+h, b+k) - \psi(a+h, b+k)$$

being developed in powers of h and k by Taylor's Theorem, shows no terms lower than those of the form $A h^n + B h^{n-1} k + \dots + M k^n$. This is tantamount to the following: two surfaces have a contact of the n th order when any plane whatever drawn through the point of contact cuts the surfaces in two curves which have a contact of the n th or a higher order.

Every surface has at every point a plane which has a complete contact of the first order. If $z = \phi(x, y)$, and x, y, z be the co-ordinates of the point of contact, and ξ, η, ζ those of any point in the tangent plane, then the equation of the tangent plane is

$$\zeta - z = \frac{dz}{dx}(\xi - x) + \frac{dz}{dy}(\eta - y).$$

But if the equation be given in the form $\phi(x, y, z) = 0$, it is

$$\frac{d\phi}{dx}(\xi - x) + \frac{d\phi}{dy}(\eta - y) + \frac{d\phi}{dz}(\zeta - z) = 0.$$

In the first case, the equations of the normal, a line drawn through the point of contact perpendicular to the tangent, are

$$\xi - x + \frac{dz}{dx}(\zeta - z) = 0, \quad \eta - y + \frac{dz}{dy}(\zeta - z) = 0.$$

In the latter case, they are

$$\frac{\xi - x}{\frac{d\phi}{dx}} = \frac{\eta - y}{\frac{d\phi}{dy}} = \frac{\zeta - z}{\frac{d\phi}{dz}}.$$

The tangent plane may 1. not cut the surface at in a sphere: 2. coincide with the surface thro whole line, as in the cone or cylinder: 3. cut the as in the case of an hyperboloid made by revolution of an hyperbola about the minor axis (the figure of a common dice-box). The criterion of distinction between these cases depends on the value of

$$\frac{d^2z}{dx^2} \cdot \frac{d^2z}{dy^2} - \left(\frac{d^2z}{dxdy} \right)^2, \text{ say } U,$$

at the point of contact. Imagine a plane to pass through the normal, cutting the surface in the curve (C) and the tangent plane in the straight line (L). Then, while the plane revolves about the normal, (L) is always tangent to (C).

1. Let U be positive. Then (L) has never more than a contact of the first order with (C), the surface nowhere passes through the tangent plane, and we have only such contact as is seen at any point of a sphere or ellipsoid.

2. Let $U = 0$. Then (L) has never more than a contact of the first order with (C), except when the plane is in one position, in which there is a contact of a higher order. If $U = 0$ at the point of contact only, and begin to take value at all adjacent points, nothing more would appear than in the last case, except that in one particular direction from the point of contact, and in its opposite, the surface would seem to grow nearer to the tangent plane than in any others. But if $U = 0$ at all points of this surface, this approach to the tangent plane in one particular direction becomes more marked: for the surface lies on that plane in a straight line, that is to say, every tangent plane meets the surface in a straight line infinitely extended both ways; and the plane is tangent to the surface at every point of that straight line. Such surfaces, namely those in which U is always $= 0$, are developable, or can be unrolled without any overlapping, rumpling, or tearing. Cones and cylinders are instances. Again, if $U = 0$, not throughout the whole surface, but throughout one particular line upon it, that line will be a plane curve, and its plane will be tangent to the surface at every point in which it meets the surface.

3. Let U be negative. Then (L) has never more than a contact of the first order with (C), except in two different positions, in both of which there is contact of a higher order. Draw lines marking out these two positions of (L), and consequently dividing the tangent plane into four parts, with four angles round the point of contact. In one pair of the opposite angles, the surface lies on one side of the tangent plane, and in the other on the other.

Again, as the plane which revolves round the normal takes its different positions, the curvature of the section (C) changes. The two positions of the revolving plane in which the curvatures are greatest and least (algebraically) are at right angles to one another. We shall not enter into the mathematical formulæ connected with this subject, but shall only endeavour to give a popular illustration of this remarkable point.

Suppose an eggshell, unbroken, to be placed with either vertex uppermost. The descent will be equally rapid in all directions, or the curvature at the highest point of all the vertical sections will be the same. But suppose the shell to be so placed that some point intermediate between the two vertices is uppermost. The descent will not then be equally rapid in all directions, or the curvatures of the vertical sections will not be the same. The direction of most rapid descent will be at right angles to that of least rapid descent. The tangent plane has here a contact of the first of the three kinds above mentioned. If there be a contact of the second kind, all the circumstances are the same, except that the direction of least rapid descent gives, comparatively speaking, no descent at all at the first instant. If we take a cylinder, or other developable surface, and

igent plane horizontal, there is absolutely no one direction, or, by going along the tangent an remain entirely on the surface, in one ceron, as before observed. And the direction of descent is at right angles to this direction of

case of the third kind, suppose a saddle placed and we take the lowest point of the seat. The ne then cuts through the saddle horizontally. ections there is descent, in others ascent, with ns in which there is, comparatively speaking, nt nor descent. The direction of most rapid ch is from the lowest point of the seat directly head or tail of the animal, is at right angles tion of most rapid descent. Mathematically e curvatures of the vertical sections are some- ve, and sometimes negative, and the direction est negative (or algebraically least) curvature ngles to the direction of the greatest positive cally greatest) curvature.

nts connected with the apparent physical cha- e tangent, which have been in various places his article, it will be more convenient to con- nder the word VELOCITY.

'NIA, the name of a genus of plants belonging al order Apocynaceæ. This name was given u Petit Thouars to the plant which produces ed Tanghin poison of Madagascar. The genus infundibuliform corolla, with a clavate tube, d throat: the anthers are subsessile; the fruit ith a fibrous ligneous putamen or stone, which or two seeds. The specific name *T. venen-* en to the plant which yields the poison. It aves, with erect branches, and paniculated vers. At the time Du Petit Thouars described e stated that it was closely allied to the Cerbera and since its cultivation by Mr. Telfair in the here can be no doubt of its belonging to the era, and the plant is now called *C. Tanghin*. e island this plant attains the size of a tree, and wood which may be used for many kinds of But the part which yields the poison is the e fruit. Although this kernel is small, not than an almond, Mr. Telfair says that it con- a poison to kill twenty persons. Its great use ar was as a means of trial, the innocent being le to resist its action, whilst the guilty suffered luence. Radama, the late king of Madagascar, s of abolishing its use, but found great diffi- ng so on account of the prejudices of the na- Telfair witnessed a sad instance of its use. adama was taken ill, and got well by the use but this medicine affected his mouth, so that on produced upon his 'skid,' or physician, was gh had been poisoned. He therefore insisted ghin should be administered to himself and nts of the household, in order to ascertain the . The king protested against the procedure,

The whole household were shut up during thout food, and in the morning were brought d. The presiding 'skid,' or physician, then e Tanghin bean to a pulp between two stones, a small quantity to the back of the tongue of lual. The effects varied in different indivi- ome it produced vomiting, and the poison be- from the stomach, they recovered. In others were brought on with violent efforts at vomit- on destroyed life. (*Botanical Magazine*, fol.

R. [MAROCCO.]

. [SEA-WEEDS.]

' is the historical name of a country in Asia, pies the centre of the eastern, more extensive, evated table-land of that continent [ASIA, vol. here a nation, which originally inhabited Tibet, led Tang, founded an empire in the seventh ch was very powerful for a long time, and was by Genghis Khan in 1227. The country still name of Tangut, though at present a part of rated in the Chinese province of Kansî, whilst aly in possession of two Mongol nations, ros and the Torbod Mongols.

orders on China Proper on the north-west, ex- een 33° and 42° N. lat., and between 94° and

107° E. long. To the south of it is Tibet; to the west Chinese Turkistan, or the government of Thian-Shan Nanlu; and to the north Mongolia, of which also a portion is included within the lately erected province of Kansî. As the boundary-lines of the country are not politically determined, it is not possible to give an estimate of the area.

The southern portion of Tangut, or that which lies south of 38° N. lat., is one of the most mountainous tracts on the globe, and extends over the upper course of the river Hoang-ho and the basin of the lake of Khookhoo-nor. Along its southern border there is a very elevated range, which divides the upper courses of the rivers Hoang-ho and Yan-tse-kiang, and is called the Bayan Khara range. [BAYAN KHARA MOUNTAINS.] Another elevated range traverses the country in the same direction from east to west near 38° N. lat. This range rises at a short distance from the banks of the Hoang-ho north of the town of Lan-tcheou, and in its eastern part is called Kilian Shan; but farther west it takes the name of Nan Shan (or Southern Chain). It rises to a great elevation, especially towards the west, where many of their summits are covered with snow and united by extensive glaciers. This mountain-chain is supposed to be connected with the Kuenluen range near 92° E. long. These two ranges above mentioned occupy a great portion of the country between 33° and 38° N. lat., and nearly the whole of the remainder of the country is filled up by a third range, which connects these two ranges, and extends from south-east to north-west, being on the north united to the Nan Shan, and on the south to the Bayan Khara Mountains. This chain bears the name of Siue Shan, or Snowy range, on account of the numerous summits which rise above the snow-line. The river Hoang-ho breaks through this range, but the huge rocky masses compel the river to make a great bend towards the west between 34° and 36° N. lat., and the circuit which the river makes shows the immense extent of these masses of rock. In this part of its course the river is said to be hemmed in by lofty mountains, so that no communication can be established along the banks. Its course above this bend is very imperfectly known, and the fabulous accounts of its sources show that they have never been visited even by Chinese geographers. The river enters a wide valley by a narrow gorge formed by two very elevated mountains a little above the town of Ho-cheou (36° N. lat. and 102° E. long'). At the opening of this gorge is a fortress, called Tsy-shy-kuan.

Tangut is separated from China Proper by a fourth range, the mountains of Sifan, which run south and north, being connected at their southern extremity with the Bayan Khara Mountains and the Siue Shan by an extensive mountain-knot, which is in the country formerly called Sifan, whence the chain has obtained its name. Though this range is less elevated than the Siue Shan, it rises in several places above the snow-line, and occupies a considerable width. It is supposed to terminate near the banks of the Hoang-ho, a few miles south of 38° N. lat. Opposite to it and on the northern banks of the river rises another chain, which may be considered as the continuation of the mountains of Sifan; but this range, which continues along the western bank of the river as far north as 42° N. lat., rises only to a moderate elevation, and is stated to occupy in many places only three or four miles in width: it is called Holang Shan, and slopes on the west down into the steppe of the Olôth Tshoros. This range is distinguished from all the other ranges of Tangut by being thickly wooded on its eastern declivity.

Only a small portion of the countries enclosed by these mountain masses is fit for cultivation. It does not appear that there is any cultivation in the upper valley of the Hoang-ho above the fortress of Tsy-shy-kuan. Below that place and as far as Lan-tcheou, the valley is wider, and narrow tracts along the banks of the river are cultivated and fertile. This part of the valley is compared with that of the Adige in Tyrol. Farther down, and as far as the neighbourhood of Ning-hia, a town built on the western banks of the Hoang-ho, at the eastern declivity of the Holang Shan (38° 32' N. lat.), the valley has not been visited by Europeans. At this place the river runs in a wide valley which has been rendered fertile by numerous canals, which are fed by the waters of the river, and in which rice is extensively cultivated. There are also numerous plantations of fruit-trees. The soil contains much saltpetre. The town of Ning-hia, the antient capital of Tangut, is of considerable extent, being fifteen li (equal to five miles) in cir-

cut. It has some very good manufactures of carpets and paper, and a considerable commerce with the nomadic tribes who wander about in the country west of the Holang Shan. Below the town of Ning-hia the valley of the Hoang-ho grows wider, as the range of the Holang-shan retires farther west, but its fertility decreases. About eighteen miles from Ning-hia the canals cease and no rice is cultivated. Other grain is still grown about 30 miles farther north, where the country gradually changes into a sandy, arid desert, interspersed with hills, swampy tracts, and pastures.

The lateral valley of Si-ning-tcheou opens to the Hoang-ho from the west above the town of Lan-tcheou between the Kilian Shan and the most elevated portion of the Siue Shan. The valley is not extensive, but appears to be fertile: it contains the town of Si-ning-tcheou, which is not quite as large as Ning-hia, but a much more commercial place, as the road which connects northern China with Hlassa in Tibet passes through it. This road leads from Si-ning-tcheou westward over a chain to the lake of Khookhoo-nor, which is of great but unknown extent. It is an alpine lake enclosed by high mountains, and has no outlet. The remainder of the road lies partly over numerous large mountain-masses, furrowed only by narrow glens and ravines, and partly over rocky and sandy tablelands, and the whole is described as a desert, in which only a small number of nomadic mountaineers are met with, and where the traveller for forty days' journey finds no other accommodation than the tents of the poor mountaineers. In spite of the difficulties, the road, as it appears, is much travelled, and the bazars of Si-ning-tcheou are well provided with provisions and articles of luxury. Even coffee and dates may be got there. This town is also the depôt of the Turkish rhubarb, which grows, as it appears, only on the more elevated parts of the Siue Shan and Kilian Shan, and is sent from Si-ning-tcheou to all parts of the world. Before the commerce between China and Siberia was established, this article was brought to Europe through Turkistan, Persia, and Turkey, and therefore is still called Turkey rhubarb, though at present it comes through Kiachta and Russia. When the Jesuits, who had been sent to these countries by the emperor Kang-hi, were at Si-ning-tcheou, they were astonished at seeing the quantity of rhubarb which, during the months of October and November, was daily brought from the adjacent mountains to the town.

The northern part of Tangut, with the exception of the valley of the Hoang-ho, is occupied by a wide desert plain, which constitutes a portion of the Gobi. [Gobi, vol. xi., p. 286.] The steep declivities of the Kilian and Nan Shan however do not come close to the desert, but are separated from it by a hilly tract from 30 to 50 miles wide, which contains some extensive tracts fit for cultivation, and in which some large towns have been built, as the great commercial route which connects China with the countries of Western Asia runs longitudinally through this hilly tract, and is confined to it by the extensive sandy desert on the north, and the still less practicable mountain-desert which bounds it on the south. According to our best information, the ranges of the Kilian Shan, and especially of the Nan Shan, are covered with eternal snow, and one would imagine that they give origin to rivers which bring down a great volume of water, but that is not the case. The volume of water is very moderate: a part of it is consumed in irrigating the adjacent fields, and the remainder is absorbed by the sandy soil, as soon as it reaches the plain, after having left the hilly tract. This evidently shows that the watershed of the mountains must be at a very moderate distance from the Gobi. The surface of the hilly tract consists of an alternation of high lands and of depressions, running from the mountains northward to the border of the desert. The high lands are of considerable extent, their upper surface broken and rocky, and only occasionally covered with a thin layer of earth unfit for the growth of trees. In general the rocks are bare. The depressions between these high grounds are less extensive, but exhibit a considerable degree of fertility where they are irrigated. Even in those parts which are beyond the reach of irrigation, they are chiefly cultivated. To protect this hilly region, and the great commercial road which runs through it, against the nomadic tribes of the Gobi, the Chinese have continued the Great Wall along its northern border westward to 96° E. long., and along the wall are built the fortresses which protect the line and the towns

through which the road runs. The road leaves the valley of the Hoang-ho at the town of Lan-tcheou [CHINA, vol. vii., p. 80], the capital of Kansu, and runs in a north-north-west direction over a stony and hilly country to the town of Liang-tcheou, a considerable place, of which however nothing is reported, except that the district in which it is situated is fertile, and contains a great number of villages. From Liang-tcheou the road runs north-west to Kan-tcheou-foo, a large and well-built town, which has many manufactures of woollen stuffs and felts, which articles are in great demand among the nomadic tribes of the Olöth Tshoros, who inhabit the contiguous part of the Gobi, and bring to the place their wool, horses, cattle, and sheep. It receives also large quantities of rhubarb from the Kilian Shan. From Kan-tcheou-foo the road continues in a north-west direction to So-tcheou, a large and well fortified town, with numerous bazars, well provided with provisions and manufactured articles. The town is divided into two sections, one of which is occupied by the Chinese, and the other by the foreign merchants from Bokhara and Turkistan. The latter is divided from the former by a separate wall, the gates of which are shut at night: in other respects foreigners do not experience any different treatment from natives. As So-tcheou is the last large place through which the caravans pass before they enter the desert between Tangut and Thian-shan-nahr: the commerce is very great, especially in provisions. About 50 or 60 miles west of So-tcheou is the most western gate of the Great Wall, called Kia-yu-kooan, or the gate of the You-stone (jasper), through which the caravans pass to enter the desert of Han-hai, which must be traversed in order to reach Hami in Thian-shan-Nanlu. The last-mentioned town is 960 li, or 320 miles, from the gate of Kia-yu-kooan, and that is the width of the Gobi at this place, which is considered the narrowest part of it.

The towns hitherto noticed lie along the great caravan-road, but farther west the Chinese geographers mention other places of importance. The largest, as it seems, is Ngan-si-foo, a town of the first rank, and the capital of the whole district. North-west of it, and on the border of the desert, is the town of Yu-men-kiang, which is built near a pass between high hills, through which a road leads northward to Hami, of which we have no information. South-west of Ngan-si-foo are the towns of Toong-hoang-kiang, and Sha-tcheou. The last-mentioned place, whose name means Sandtown, seems to be the last inhabited place towards the west. It has not been visited by Europeans, except by Marco Polo, who describes it as rather a large place: he says that the inhabitants live on the produce of their fields and orchards, and have little commerce. From his account, and that of a Chinese traveller, it is evident that two roads run north-west and west from this place. Marco Polo reached it after traversing the desert of Lop, by a thirty days' journey, having departed from the town of Lop, which is on the banks of the lake of the same name. The intermediate tract was mostly covered with sand, but in some places the soil consisted of bare and broken rocks. A Chinese traveller departing from Sha-tcheou, and taking the western route, seems to have traversed a still worse country, until he reached the town of Khotan. [THIAN-SHAN-NANLU.]

That portion of the Gobi which lies north of the Great Wall contains many tracts which are covered with grass, and supply pasture to the Olöth Tshoros, but others have a sandy or stony soil, and are quite barren. In some places there are extensive swamps, especially where the rivers are lost, which descend from the Kilian Shan, among which the Etzina probably runs more than 200 miles. But the Han Hai, or that portion which lies between the gate of Kia-yu-kooan and Hami, is nearly uninhabited, as water is rarely met with, and the grassy tracts are still less frequent. The sand with which the surface is covered is very fine, and frequently raised into the air by strong winds.

Our information respecting the climate of Tangut is very scanty. The cold in winter is intense, and lasts for several months. The Jesuits found the Hoang-ho near 40° N. lat., at the end of November, covered with thick ice, so that the caravan was able to pass over it, though the river was more than 300 yards wide. At Ning-hia a heavy fall of snow was experienced in the middle of April. In summer the heat is great, but much less than in the low countries of China; the climate is considered as extremely healthy.

We are no better acquainted with the productions of

Tangut. Every kind of grain is grown in the few tracts whose soil is fit for cultivation, and rice is raised where irrigation is practicable. The nomadic nations have numerous herds of camels, horses, and cattle, and large flocks of sheep and goats. In the mountain-region is found the yak or mountain-cow, whose tail gives the chowry. It is used for riding as a saddle-horse. In the desert are numerous wild animals, such as wild hogs, deer, the argali, and the ibex. It is also said that in the woods of the Holang there are wild horses. Wild cattle are found on the declivity of the Kilian Shan. No mines are worked. In the desert some extensive tracts are covered with agates, cornelians, and other precious stones, which are collected by the nomadic tribes and sent to China.

The inhabitants of Tangut are a very mixed race. The nomadic tribes inhabit the Gobi, and occupy also the mountain-ranges north of Lake Khookoo-nor, but the nomads who are in possession of the mountain-region south of Lake Khookoo-nor, derive their origin from Tibet. It is even supposed that in this part there may still exist small tribes of the Miotse and Yuet-shi, who are considered as the aborigines of this region, but have been nearly exterminated by the wars with their neighbours the Mongols and the inhabitants of Tibet. It is not known if that Turkish nation which is called Sobko, and which inhabits the western part of the Kuen-luen mountains [TIBET], extends over the western districts of Tangut. The agricultural population is mostly composed of Chinese and their descendants, among whom a small number of families of Turkish origin are settled. But in the towns a number of Turkish settlers seems to be considerable. They are Mohammedans, and there are mosques in the principal towns of Tangut, especially in those which lie on the caravan road. All the other inhabitants are Buddhists. In the time of Marco Polo there were also Nestorian Christians in the towns, but they have disappeared.

The Chinese emperors subjected the country of Tangut probably during the dynasty of Han, shortly before the birth of Christ, and maintained their authority over this and the countries farther west to the eighth century, in spite of their long protracted wars with the Hiongnu, a Turkish nation which then was in possession of the desert north of Tangut. In the middle of the seventh century they extended their dominion even over Western Turkistan to the eastern banks of the Caspian Sea. But in the eighth century Tangut was occupied by a nation of Tibetan origin, which founded in these parts the empire of Thufan; and though it was overthrown by the Chinese, and some Turkish tribes, their allies, in the ninth century, the Tibetans erected in the following century the empire of Tangut or Hia, which maintained its power till it was destroyed by Genghis Khan, in 1227, and by its overthrow the conqueror opened to his countrymen the road to China, of which they took possession a few years afterwards. With the downfall of the dynasty of the Mongols (1341), the best part of Tangut remained under the sway of the emperors of the dynasty of Ming, though the Mongols after their retreat from China had occupied the northern and more desert portion of it, where they maintained their independence to the end of the seventeenth century. In the wars of the Galdan of the Olöth [SONGARIA, vol. xxii., p. 245], a tribe of the Olöth Mongols expelled the Khalkas from the country west of the Hoang-ho, and took possession of it.

But after the defeat of the Galdan, they submitted to the Chinese emperor in 1690, and since that time the whole of Tangut has been annexed to China. The Chinese are very assiduous in promoting agriculture in the country, and in increasing the agricultural and commercial resources, this being considered the most efficacious mode of subduing the nomadic tribes which inhabit the northern districts of Tangut. To give to its measures stability and to forward their extension, it has conquered the greater part of Tangut, with some of the adjacent countries, into a province of China Proper, under the name of Kansai. (Du Halde's *History of China*; *Erskunde von Asien*, vol. i.)

ORE, a district in Southern Hindustan, was formerly an independent kingdom or principality, and though under British superintendence, is still governed by its own ruler. The district is included in the province of the Carnatic and presidency of Madras: it is bounded on the east by the Bay of Bengal, and extends from Point Calymere, P. C., No. 1492.

10° 18' N. lat., to the mouth of the Coleroon, 11° 25' N. lat. To the north and west it is bounded by the Coleroon and the district of Trichinopoli; and to the south and west by the sea and the territory of the Polygars.

The river Cavery, near Trichinopoli, separates into two branches, of which the northern is called the Coleroon, and falls into the sea a little to the north of Devicotta; the southern branch retains its name of Cavery. These two streams however, after flowing about twenty miles at some distance, again approach each other, and are only prevented by a narrow neck of land from re-uniting and discharging the whole river by the channel of the Coleroon. To prevent this junction large mounds have been formed, and are kept in repair at a considerable expense. The Cavery, thus separated from the Coleroon, flows through the flat territory of Tanjore, and divides into a number of smaller streams, which are conducted into reservoirs and canals for the purpose of irrigation: by this means nearly the whole district, which would otherwise be a sandy desert, is rendered one of the most fertile in Hindustan. From Devicotta to the salt swamp near Point Calymere, and from the Bay of Bengal to the city of Tanjore, the whole country, with its rich covering of alluvial soil, has the appearance of a garden: from Tanjore to Trichinopoli it is like a desert.

The principal product of the district is rice, of which two crops are obtained annually; the next in importance is indigo: both are exported to Madras in considerable quantities, besides cocoa-nuts, grain, paddy, and lamp-oil.

The district of Tanjore has never been in the actual occupation of the Mohammedans. Its Hindu religious structures are therefore uninjured, and in no part of Hindustan are they so numerous, so large, and so imposing. There is hardly a village without its brick pagoda and lofty gateway. Almost all the principal offices are in the hands of the Brahmins, and they are also the chief landholders.

Besides the capital, Tanjore, the principal towns are the following:—Carical, 10° 55' N. lat., 79° 55' E. long. Comboconam, 11° N. lat., 79° 25' E. long., is the ancient capital of the rajas of Tanjore: there are remains which indicate its former splendour, and its pagodas and tanks are still very fine: it is chiefly inhabited by Brahmins. Devicotta (*Devicata*, the fort of the goddess), 11° 20' N. lat., 79° 55' E. long. Nagore, 10° 49' N. lat., 79° 55' E. long., a sea-port with a considerable export and import trade. **NEGAPATAM. TRANQUEBAR.** The villages are numerous, and the population dense.

The ancient sovereigns of Tanjore were the Chola dynasty, who probably gave to the whole district the name Chola Mandala (corrupted into Coromandel), the former term in Sanscrit signifying an orbit or circle, and thence a region or tract of country. The kingdom of Tanjore was wrested from its original Hindu sovereigns by the Mahratta chief Eccojee, the brother of Sevajee, in 1675. It has ever since been retained by the Mahratta race; so that, though the language of the inhabitants is Tamul, the language of the court is Mahratta. In 1771 a dispute broke out between Mohammed Ali, the nabob of the Carnatic, and Tuljajee, the raja of Tanjore, with respect to the keeping in repair the mounds which prevent the stream of the Cavery from falling into the Coleroon. The mounds are in the territory of Trichinopoli, and the nabob, as sovereign of that territory, claimed the right of repairing, and consequently of neglecting to repair, by which a portion of the nabob's territory might have been fertilized, and nearly the whole of Tanjore rendered a desert. The raja had been compelled to pay tribute to the nabob, but had never been subject to him, and appealed to the British to protect him in his right to repair, which had always been exercised by the rajas of Tanjore, and for which, he contended, he paid his tribute. The British however took the part of the nabob. On the 20th of August, 1773, the siege of the city of Tanjore was commenced, and a passage twelve feet wide having been completed across the wet ditch which surrounds the walls of the forts, on the 16th of September, when the sun was in the meridian and the raja's troops were taking repose, the British unexpectedly made the assault, and carried the fortress, with hardly any resistance, the raja and his family being taken prisoners. The raja was then made subject to the nabob; but in consequence of the disapprobation which these proceedings met with in England, on the 11th of April, 1776, the re-

restoration of the raja to his former independence was proclaimed by the British. In 1790 the territory of Tanjore was subjected by treaty to British authority. The raja retains the forts of Tanjore, which are garrisoned by him, subject however to the condition of placing them in the hands of the British in case of war in the province. He has a clear allowance of a lac of rupees annually, and one-fifth of the surplus revenue of the territory, after payment of the civil and military establishments, which amounts to at least a lac more. He also retains his palaces, and also a tribute paid to him by Tranquebar.

The present raja is Sewajee, the son of Sarbojee, who was adopted by the previous raja Tuljajee, or Julia Maha, and who was intrusted by him at his death to the missionary Schwarz. Of the circumstances under which the sovereign power was ultimately obtained by Sarbojee from Ameer Sing, the half-brother of Tuljajee, an account is given in the article SCHWARZ.

(Hamilton's *East India Gazetteer*; Malcolm's *Travels in Hindustan and China in 1836-7*; Mill's *History of British India*, by H. H. Wilson.)

TANJORE, the capital of the district of Tanjore, in 10° 47' N. lat. and 79° 13' E. long., is about 40 miles east from Trichinopoli, and about 57 miles west from the Bay of Bengal, direct distances. The city is situated not far from the south bank of the Cavery, and is five or six miles in circumference, including the suburbs. It is a place of great strength, being defended by two forts, which are connected, and both are surrounded by walls built of large stones, and by broad and deep wet ditches. The city is in a flourishing state: it is regularly built, and is said to contain a larger proportion of good houses than any other town in Southern Hindustan. The population is probably not less than 70,000 or 80,000. The palace of the raja, where he resides, is in the larger fort: in one of the halls of audience is a colossal statue of Sarbojee, by Flaxman, which was executed by commission from Sarbojee himself. The pagodas of Tanjore are very large, with paved yards and extensive gardens: one of the largest in Hindustan is situated in the smaller fort: it contains a bull finely sculptured in black granite. The Protestant Mission church was built at the expense of the missionary Schwarz: it is a spacious and handsome structure, and has been thoroughly repaired by the present raja. Schwarz was buried behind the pulpit; the spot is marked by a slab, on which is an inscription in English poetry, ascribed to the raja Sarbojee. Service is performed in the church on Sundays both in Tamil and in English. The Protestant communicants belonging to the Tanjore mission amount to about 750, and there are also between 400 and 500 Roman Catholic converts, under priests who are chiefly Jesuits from Goa.

(Hamilton's *East India Gazetteer*; Malcolm's *Travels in Hindustan and China*.)

TANK, a reservoir for water or other fluids. The name is sometimes applied to large open receptacles, or ponds, formed by excavating the ground and disposing the removed earth in the form of banks to retain the water; but the tanks which will here be especially treated of are the smaller covered reservoirs used to collect and retain water and liquid manure for domestic and agricultural purposes. Respecting the construction of ponds it will be sufficient to refer to EMBANKMENT, vol. ix., p. 373, for the method of forming the retaining banks, and to CANAL, vol. vi., p. 219, for a description of the process of puddling with clay, which is always necessary in forming a reservoir in a porous soil, unless the more expensive method of paving or lining with chalk, bricks, stone, or timber, be resorted to. See also SLUICK, vol. xxii., p. 142, for a notice of the means used to regulate the drawing off of water from ponds, and to prevent accident from their becoming over-filled.

In high mountainous pastures, tanks are indispensable to supply both men and cattle with water; and they ought to be very carefully constructed of such materials as are at hand. In the pastures of the Jura, between France and Switzerland, the tanks are usually made of wood, in the following manner: a square excavation is made in the ground, which, if necessary, is lined with a coating of clay or impervious earth to prevent the escape of the water; fir-trees, deprived of their bark, are then laid close together and fastened with wooden pins, so as to form the floor, and the sides are lined in a similar manner. The tank is covered with a roof of the same mate-

rials; but this, instead of rising from the sides to a point or ridge, according to the form usually adopted in roofing, is made in the shape of an inverted hollow pyramid, so that it acts as a funnel to conduct all the rain-water which falls upon it into the tank, at the same time that it keeps the tank cool, and prevents evaporation. Such tanks are usually placed at a small distance from the habitation and cowhouse, if there be one; and the water from their roofs is conducted, in spouts made of small trees sawn in two and roughly hollowed out, to the funnelled roof of the tank. They are usually of a cubical form, from 15 to 20 feet square; but if a larger size be required, an oblong shape is preferred, the depth and width seldom exceeding 20 feet. After being once filled, these tanks seldom fail to afford an abundant supply of water, although, in summer, thirty or forty head of cattle may have to be supplied exclusively from them.

The importance of collecting rain-water for domestic purposes, especially in districts where springs are deficient or lie at a great depth, has been much overlooked in this country. Waistell, in the work referred to at the end of this article, urges the importance of placing spouts round all the buildings of a farm to collect the rain-water which falls upon them into a tank or tanks; observing that, besides the value of the supply of water thus obtained, the buildings will be benefited by the walls and foundations being kept drier than when the water from the roof is suffered to fall upon them. He states that the quantity of water that falls annually upon every hundred superficial feet or square of building (in Great Britain is about 1400 imperial gallons; and this statement appears to be fully borne out by the observations recorded in the article RAIN, vol. xix., p. 270. If therefore the external surfaces of roofs were adapted to the collection of the rain-water which falls upon them, and means were provided for conveying it to covered tanks, in which it might be preserved from evaporation, and kept free from any admixture of impurities, almost every house might be readily and cheaply supplied with a quantity of wholesome water sufficient for the ordinary wants of its inhabitants. The extensive roofs of churches and other public buildings might be employed in like way to collect water for the supply of ponds or tanks for public use. In some cases even the drainage of lands might also be made available, as the water may be submitted to any required process of filtration before it is allowed to enter the tank.

Tanks or cisterns to hold water for domestic purposes may be conveniently situated beneath the surface of the ground, so that, being paved over, they occupy no valuable space. They are formed of stone slabs grooved into each other and set in cement; of Welsh slate; of large paving-tiles bedded in cement; of brick-work; of plates of cast-iron; or of thick wooden planks, protected by charring and pitching, or lined with sheet-lead. The brick tanks described by Waistell are circular, the sides being built like a well, with bottoms of an inverted dome-shape, of very slight convexity. The top is also dome-shaped, and has an opening in the centre large enough to receive a man, in order that the tank may be thoroughly cleaned out when necessary. This opening, which may be upon the surface of the ground, or a little above it, should be covered with an oak flap pierced with a number of holes, or with an iron grating. The depth and width of the tank should, it is stated, be nearly equal. If necessary, a smaller brick chamber may be constructed alongside of the tank, in which the water may be filtered through gravel, sand, charcoal, &c. before entering it. It is recommended to make the opening by which water enters the tank near the top. Brick tanks of this description may be rendered water-tight by laying the inner course of bricks in cement, and plastering the whole of the inside with the same to the thickness of about three-quarters of an inch. To enable them without injury to bear the great weight of water when nearly full, the earth should be rammed closely round the brickwork, and it should be allowed to settle thoroughly before any great quantity of water is admitted. Loudon describes another kind of brick tank, contrived by Mr. Mallet to save expense in construction, by adopting a figure of maximum capacity and minimum surface. Mallet proposes, when the tank is large, to adopt the spherical form; and when of less than five or six feet in diameter, that of a short vertical cylinder with hemispherical ends. By puddling

roundabout the tank, the necessity for the use of cement is avoided.

The forty-ninth volume of the 'Transactions' of the Arts (part ii., p. 12), is a communication from Sir Gilbert respecting a cheap method of cisterns for receiving water from the roofs of cottages which has been successfully practised at Eastbourne.

A reservoir having been dug seven feet deep and the same wide, the bottom was covered with a liquid mortar composed of one measure of lime (made of chalk marl) well beaten up with three measures of clean sea-sand. The side walls were made of the same materials, leaving a small space at the top of the wall, which space was filled up with the same mortar or liquid mortar. The tank was then roofed with a dome, formed, without any centering, of bricks well bedded in mortar. A hole was left in the top and covered with a hood, within which was a pulley with a rope and bucket for drawing water from the tank. This account was published in 1833, and an article appeared in the 'Labourers' Friend' in which it is stated that such tanks had been used very useful during three dry summers. One, less than seven feet deep and wide, had supplied two labourers' cottages at that time, while most of the springs in the neighbourhood were dry. This paper describes a brick cistern sloping sides, the diameter at the base being three feet at the top, and with a dome-shaped top making each row of bricks project one-third of an inch immediately below it, and balancing the weight by filling up the back with earth as the work proceeded. The flint tanks, constructed as above described at Eastbourne workhouse, is twenty-three feet long and eleven feet wide. Only ninety bushels of lime were used for its construction, including two coats of plaster. The cost of the work was executed at ten shillings per square foot.

In the article last quoted from, it is observed that a cistern has been supposed to promote the purity of the water reserved in tanks. If so, it may be easily proved.

Where the prevailing winds do not blow soot upon the roof, the water is found to remain pure for drinking, without clearing out the rubbish once a year.

In order to tanks for water, every farm-yard should be so constructed as to collect the liquid portion of the manure, which is shed by the rain through the refuse litter, and the droppings of the stalled cattle. Though not yet general in England, in France, Germany, and especially in Belgium, such tanks are considered as necessary in any of its most common buildings. They are constructed of an oblong shape, of brick well laid with one or more divisions, and capable of containing at least ten times as many hogsheads as there are stalls on the farm. They are vaulted over, with a circular aperture, in which a pump is placed, sufficient to draw a man occasionally to clear out the sediment.

The liquid has been pumped up. The best method is to contain a large quantity in the smallest space possible like those before described; but they cannot be made sufficiently large, and a cubical form, instead of several cubics in succession, is preferred. On a farm of 200 acres of arable land should be 15 feet deep, and 45 long, giving 3 cubics of 15 feet, capable of containing upwards of 10,000 cubic feet.

In this tank the urine is diluted with water too rapid decomposition, and also to retain a certain amount which is formed; for which purpose gypsum and a small quantity of copper are sometimes put into the tanks. The walls should be not sandy, clay will answer instead of mortar. The brickwork, and a plastering of lime or cement will be sufficient to keep out the worms: but in the case of soils the bottom and sides must be puddled, with the liquid; and it may be advantageous to plaster the walls in cement altogether. The liquid from the stalls and stables is carried into the tank by a main drain constructed of brick or stone, and which receives a number of smaller drains from every part of the yards and sheds. Thus the litter in the yard is always pure, and none of the richness of the manure is lost by it.

When the tank is vaulted like a cellar under the stalls and stables, which are washed out twice every

day, and all the dung and water are swept into a cess-pool communicating with the tank. Thus a very diluted, but rich liquid soon fills the first division of the tank: a sluice is then shut, and the next washings run into a second division, and when that is full, into a third. In the meantime the contents of the first tank have undergone a certain fermentation, by which the caustic ammonia first evolved has become mild and impregnates the water. It is then in a fit state to be carried on the land in tubs or water-carts. When properly diluted, it accelerates vegetation in a surprising degree; but if put on fresh, it burns the grass or any vegetable it touches, because the ammonia is in a caustic state. If a cow drop her urine in a field in a hot summer's day, all the grass it has touched becomes yellow and is burned up: but if the same happen in rainy weather, the spot soon becomes very green, and the grass luxuriant; because, in this case, the urine is amply diluted and its caustic nature corrected. Those who live near gas-works may collect the ammoniacal gas-water in a tank, and, by the addition of sulphuric acid in very small quantities, they may produce a very fertilising liquid, which will stimulate vegetation, and be a very good manure.

The necessary concomitant of a tank, whether for water or manure, is a water-cart, that is, a large cask put upon wheels to bring water from some distance. When there are no means of bringing water in pipes, a water-cart is quite indispensable. It is simply a cask placed on the frame of a cart, with a plug-hole in the end or lower part, from which the water may be let out by a cock, or drop on a flat board or into a bucket with holes, so as to spread it about. The plug-hole is shut by a valve inside, which can be opened by means of a string, the pressure of the liquid keeping it close to the plug-hole.

Many of the artificial manures, of which a number have been lately proposed, would make excellent liquids by merely mixing them up with water in a tank, and allowing a certain degree of fermentation to take place. Thus nothing is lost, and all volatile substances are taken up by the water. The soluble portions are dissolved and the earthy matters diffused, so as to be more equally spread over the land. If it be true that the ammonia found in some plants is chiefly derived from the very small portion discovered in rain water, it follows that a scarcely perceptible impregnation with this salt may have most powerful effects on vegetation.

When a farm-yard is situated on a hill, and there are fields or pastures on a lower level, at no great distance from it, the liquid from the tank may be conducted by channels lined with clay, having small sluices to direct the streams to any particular field. It may thus be made to irrigate temporarily a considerable surface, which it will greatly enrich. It may be led into the common furrows between the lands or stitches in ploughed land, and allowed to soak in them, and then it can be spread with the earth of the furrow, by means of broad shovels, over the growing crops, and will greatly invigorate them. This species of irrigation is common in Lombardy, where much ingenuity is shown in the manner in which water is made to flow in small rivulets between the rows of growing vegetables. The water here is supplied by streams, but the same method would distribute the tank-liquor with great effect. A very small quantity of this liquor, allowed to flow into the main feeder of a water-meadow, will soon prove how great effects are produced by impregnations which are scarcely perceptible by chemical analysis.

Small as the experience has hitherto been in this country of the advantages of liquid-manure tanks, it has sufficiently proved their use to induce every man who constructs a farm-yard and erects buildings to take in the tank as an essential part of his plan; and even if it only collected the refuse fluids which are allowed to run off in common sewers from most houses, it would soon repay the cost of its construction, while it rendered the ditches in the neighbourhood less subject to noxious emanations from the corrupted matter which now flows into them. The passage of air into or out of a manure-tank, and the consequent exhalation of noxious vapours, may be prevented by the use of air-traps, similar in principle to those described under SEWERS, vol. xxi., p. 319, at the points where the drains enter it.

The use of metallic cisterns or tanks, in lieu of wooden casks, for containing a supply of fresh water for long

voyages, is one of the great improvements effected of late years in naval economy. The nineteenth volume of the 'Transactions' of the Society of Arts contains an account of experiments on this subject, by General Samuel Bentham, in 1796 and the following years, the success of which induced the Society, in 1801, to present to him their gold medal. Large earthen jars have been tried for this purpose; but, while they keep the water very pure, they are not so convenient for general use as metallic tanks, which may be fitted to the shape of the vessel, so as to avoid any loss of room.

(Waistell's *Designs for Agricultural Buildings*; Loudon's *Encyclopædia of Cottage, Farm, and Villa Architecture*; *Transactions of the Society of Arts*, vols. xix. and xlix.; *Labourers' Friend Magazine*, 1837, p. 131.)

TANNAHILL, ROBERT, born at Paisley, in Scotland, on the 3rd of June, 1774, was the son of poor parents, by whom he was brought up to the occupation of a weaver, which he pursued in his native town and at Glasgow throughout the short period of his life. The earliest predilection of Tannahill was for poetry, and his taste was formed by the constant study of Allan Ramsay, Fergusson, and Burns. He failed to attain the spirit of these masters of Scottish song; but his pieces generally excel theirs in grace and sweetness. A specimen of this sweetness is found in his famous song, 'Gloomy winter's now awa:'

'Tow'ring o'er the Newton woods,
Layrocks fan the snow-white clouds;
Siller saughs, wi' downie buds,
Adorn the banks sae brierie, O.
Round the sylvan fairy nooks
Feath'ry breckans fringe the rocks,
'Neath the brae the burnie jouks,
Ilka thing is cheerie, O.'

'Jessy, the flower of Dumblane,' is his best-known effort. The 'Song of the battle of Vittoria' has the merit of redeeming from the degradation of worthless words one of the finest airs of Scottish minstrelsy, and restoring it from a whistled jig to the solemn tone of a triumphal song.

His songs were commonly inspired by the immediate occasion; were the unlaboured fruit of his imagination or feelings. Besides the charm of harmony and of a perfect mastery of his language, which is almost exclusively Saxon, they derive not a little of their effect from the vein of desponding melancholy which runs through them. This melancholy was in some degree constitutional in Tannahill, but it was aggravated by the neglect of the world, and a hopelessness of ever raising himself above circumstances so unfavourable to genius as those in which fortune had thrown him. A kindred spirit, the Ettrick Shepherd, made a long pilgrimage to visit him at Paisley. After a night spent in the most delightful interchange of feeling, Mr. Hogg took his departure. 'Farewell, we shall never meet again,' were the words emphatically pronounced on this occasion by Tannahill, and their meaning was shortly afterwards explained. He committed suicide by drowning himself, in his thirty-sixth year. His remains are interred at Paisley.

Tannahill's songs were published in Paisley, in his lifetime, in a small volume. They are in every modern collection of Scottish melodies, and are occasionally printed (under Tannahill's name) with selections from Burns. For his life, see Chambers's *Scottish Biography*.

TANNER, THOMAS, was the eldest son of the Rev. Thomas Tanner, vicar of Market Lavington, Wiltshire, where he was born, 25th January, 1674. In November, 1689, he was entered a student of Queen's College, Oxford; but after having taken his degree of B.A., he removed in January, 1694, to All Souls, and he was elected a fellow of that society, 2nd Nov., 1696. So early as 1693, when he was only nineteen, he had published proposals for printing all the works of the antiquary John Leland, from the original manuscripts; but this design, which was afterwards partially executed by Hearne, did not receive such encouragement as to induce him to proceed with it. The reputation he had very early acquired for his knowledge of English antiquities may appear from the fact that Anthony à Wood, at his death in 1695, left his papers to Tanner's care. That same year Tanner published at London his first work, an 8vo. volume, entitled 'Notitia Monastica, or a Short Account of the Religious Houses in England and Wales.' Having taken orders, he was soon after appointed by Dr. Moore, bishop of Norwich, one of his chaplains; and having, in 1701, married Rose, the

eldest daughter of that prelate, he received various preferments from his father-in-law; the chancellorship of Norwich about the time of his marriage; the office of commissary for the archdeaconry of Norfolk in 1703; that of commissary for the archdeaconry of Sudbury in 1707; and, in 1713, a prebend in the cathedral of Ely, to which diocese Moore had been by this time removed. Meanwhile Tanner's wife had died, at the age of twenty-five, in 1706. In the same year he was presented by a friend to the rectory of Thorp, near Norwich; and he then married Frances, daughter of Jacob Preston, Esq., of London, whom however he lost in 1718. His next publication, a new edition of Wood's 'Athenae Oxonienses,' enlarged by the addition of 500 new lives from Wood's manuscripts, appeared at London, in 2 vols. fol., in 1721. In December that year Tanner, who had taken his degree of D.D. in 1710, was appointed by Dr. Green, bishop of Norwich, to the archdeaconry of Norfolk; and in 1723 he resigned his prebend at Ely, and was appointed canon of Christ's Church, Oxford. He was consecrated to the bishopric of St. Asaph, in January, 1732; and in May, 1733, he married Mrs. Elizabeth Scottow of Thorp, receiving with her a fortune of 15,000*l.*; but he did not long enjoy these accessions of wealth and honour, his death taking place at Oxford on the 14th of December, 1735. By his second wife he left one son Thomas, who died rector of Hadley and Monks' Ely in Suffolk, and prebendary of Canterbury, in 1760. His widow married Robert Britiffe, Esq., M.P., and survived to 1771. A new edition of the 'Notitia Monastica,' with large additions (in part by the editor), was published in a folio volume at London, in 1744, by the bishop's brother, the Rev. John Tanner, vicar of Lowestoft in Suffolk; and a third edition, considerably improved, by the Rev. James Nasmyth, appeared at Cambridge, in the same form, in 1787. The greater part of this last impression having been consumed in a fire which happened in Mr. Nichols's printing-house, on the night of Monday, the 8th of February, 1808, the book is very scarce. But Tanner's literary reputation rests principally on his great biographical and bibliographical work, entitled 'Bibliotheca Britannico-Hibernica, sive de Scripturis qui in Anglia, Scotia, et Hibernia, ad Saeculi xvii. initium floruerunt, literarum ordine, juxta familiarum nomina, dispositis, Commentarius,' which had been the labour of his leisure for forty years, and which was published, in folio, at London, in 1748, under the care of the Rev. Dr. David Wilkins. It is a work of extensive research and great general accuracy. Bishop Tanner had made large collections of charters, grants, deeds, and other instruments relating to the national antiquities, which he bequeathed to the Bodleian Library. Some letters from him are published in Dr. Bliss's collection of 'Letters written by Eminent Persons,' &c., 2 vols. 8vo., Lon., 1813. (*Biographia Britannica*.)

TANNIC ACID, or TANNIN, a peculiar vegetable acid existing in every part of the bark of each species of quercus, but especially in the bark: it is found however in the greatest quantity in the gall-nut. The name of this substance is derived from its property of combining with the skins of animals, or in tanning, by which they are rendered impervious to water, and prevented from putrefying.

To prepare tannic acid, galls are to be reduced to coarse powder, and digested in a percolator in æther which has been previously mixed and shaken with water: in the lower part of the vessel two strata of liquid appear, the heavier of which is a strong solution of tannic acid, by evaporating which, and by subsequent purification, the acid is obtained possessing the following properties:—It is a colourless or slightly yellowish mass, which does not crystallize, but resembles dried gum. It is readily soluble in water; the solution has an astringent but not a bitter taste; it reddens vegetable blues, and decomposes alkaline carbonates with effervescence; weak alcohol dissolves it, but æther only slightly; when the aqueous solution is exposed to the air, especially if the temperature be high, oxygen gas is absorbed, and an equal volume of carbonic acid gas evolved, while the tannic acid is converted into gallic and elagic acids. Tannic acid precipitates gelatin from solution; the compound has been called *tannogelatin*, and when the acid is in excess a viscid elastic mass is formed, which contains about half its weight of tannic acid; when the liquid from which the gelatin is pre-

tated is heated to ebullition, the tannogelatin is resolved; tannic acid also precipitates albumen and ch.

When dried at 212° tannic acid consists of

Eighteen equivalents of carbon . . .	108
Five equivalents of hydrogen . . .	5
Nine equivalents of oxygen . . .	72

Equivalent . . . 185

With Three equivalents of water . . . 27

When exposed to a temperature of 240°, the water is expelled.

Tannic acid combines with the alkalis to form salts, which are called *tannates*, and it precipitates most metallic oxides from solution. The salts of protoxide of iron undergo no change when a solution of tannic acid is added to them; but by exposure to the air a deep bluish-black precipitate is formed. Tannate of peroxide of iron, formed by the action of the acid on a persalt of the metal, is the basis of writing-ink, and is a black pulverulent precipitate.

TANNIN, ARTIFICIAL. It has been shown by Mr. Hatchett, that when powdered charcoal has been digested a considerable time in dilute nitric acid, it is dissolved, and a reddish-coloured liquid is obtained, which by care-ful evaporation yields a brown glossy substance, amounting to about 120 parts from every 100 of charcoal employed.

The properties of this substance are that its taste is insipid and bitter, is soluble in water and in alcohol, and forms with a solution of gelatin an insoluble precipitate, consisting, according to Mr. Hatchett, of 36 of tannin and 64 of gelatin in 100 parts. Sulphuric acid and hydrochloric acid, when added to a solution of artificial tannin, produce brown-coloured precipitates, which are soluble in water; the alkalis combine with this tannin, and it is a precipitate of difficult solubility when added to barytes, or strontia water, and also with most metallic solutions. These precipitates are of a brown colour; unnatural tannin, the artificial resists the action of nitric acid.

When camphor and various resins, as shell-lac, benzoin, dragon's blood are digested in sulphuric acid till it becomes black, a variety of artificial tannin is procured; when the blackened acid is poured into water, a black residue is deposited, which, by digestion in alcohol, furnishes a brown matter soluble in water, and forming an insoluble compound with gelatin.

Although in certain respects the above artificial substance agrees with tannic acid, yet the late discoveries as to the real nature of this principle tend to the opinion that the natural compound is essentially different from the artificial.

TANNIN, PURE, or TANNIC ACID, Medical Properties of. This substance in combination with extractive has been long known under the name of tannin, and recognized as the active principle in almost all astringent vegetables. [ASTRINGENTS.] As many of these are powerful in restraining excessive discharges, whether of the bowels or otherwise, it was conjectured that the pure principle would be yet more efficacious than when in a state of combination. Accordingly it has been administered in some passive hæmorrhages, chiefly from the uterus and the bronchial tubes. To effect any good it requires to be given for several days in small doses. It is with difficulty absorbed into the circulation, being with reluctance taken up by the lacteals, and producing great constipation, from its direct astringent action on the intestinal canal, with which it is brought into contact.

Tannic acid has been recommended in cases of the acute organic diseases affecting the uterus, accompanied with wasting discharges. These it may for a time moderate, but the constipation induced never fails ultimately to aggravate the disease and discomfort of the patient. There is little therefore to induce practitioners to use it.

TANNING is the process of converting the skins of animals into leather, by effecting a chemical combination of the gelatin of which they principally consist, with an astringent vegetable principle called *tannin*. (See vol. iii., p. 379; LEATHER, vol. xiii., p. 379; preceding chemical articles on TANNIN.) The object of the process is to produce such a combination as may render them, as observed by

Dr. Ure, unalterable by the external agents which tend to decompose them in their natural state; and, in connection with the subsequent operations of dressing, or currying, to bring them into a state of pliability and impermeability to water which may adapt them for the many useful purposes to which leather is applied. Similar effects are produced by forcing oil or grease into the pores of the skin, or by preparation with alum; processes which may be briefly noticed in connection with the more immediate subject of this article.

The preparation of skins by tanning or other analogous processes has been practised from the earliest times; and, although it has engaged the attention of several scientific men, and has been the subject of many curious experiments, it has received less modification from recent improvements in chemical science than many other manufacturing processes. Several plans which have been suggested with a view to expediting the process, which, on the old system, is a very tedious one, have been found to deteriorate the quality of the leather, and have therefore been wholly or partially abandoned; and others, which appear to be more successful, are as yet adopted by a few manufacturers only. One of the probable causes of this comparatively slow progress of improvement in the leather manufacture is suggested in an interesting article on 'Tanning,' in the seventh edition of the 'Encyclopædia Britannica,' the author of which observes that, owing to the slow turning of money in consequence of the length of time occupied in tanning the heavier kinds of skins or hides, the tanner 'must have capital enough to pay for twelve months' hides, bark, &c., labour, and contingent expenses, besides keeping a stock of leather; and, when his capital has been turned at the end of twelve or more months, it must pay him, in one single profit, the interest, &c. of twelve months.' 'This,' he proceeds to say, 'has confined the trade to a few wealthy individuals, who look upon tanning as an investment for capital rather than as a business which might be improved by science; and, being in comfortable circumstances, they are not driven to personal exertion and close application, which would be required of less wealthy tradesmen.' 'It is,' he adds, 'from these circumstances, that tanning has been more stationary than any other manufacture, and that the few improvements which have been made in it have not been made by tanners.'

The larger and heavier skins operated upon by the tanner, as those of bulls, buffaloes, oxen, and cows, are technically distinguished as *hides*; while the name *skins* is applied to those of smaller animals, as calves, sheep, and goats. The process necessary to convert hides into the thick hard leather used for the soles of boots and shoes, and for similar purposes, will be first noticed. The hides are brought to the tanner either in a fresh state, when from animals recently slaughtered, or, when imported from other countries, dried or salted, and sometimes both, for the sake of preserving them from decomposition. In the former case the horns are removed, and the hide is scraped to cleanse it from any small portions of flesh or fatty matter which may adhere to the cutis; but in the latter it is necessary to soften the hides, and bring them as nearly as possible to the fresh state, by steeping them in water, and repeated rubbing or beating. After this the hair is removed; sometimes by steeping the hides for several days in a solution of lime and water, which has the effect of loosening the hair and epidermis, or outer skin; and sometimes by suspending them in a close chamber called a *smoke-house*, heated a little above the ordinary temperature of the atmosphere by means of a smouldering fire; in which case the epidermis becomes loosened by incipient putrefaction. In either case, when the hair and epidermis, or cuticle, are sufficiently loosened, they are removed by scraping with a curved knife, the hide being laid upon a convex bench, or 'beam.' The hides are prepared for the actual tanning, or immersion in a solution of bark, by steeping them for a few days in a pit containing a sour solution of rye or barley flour, or in a very weak menstruum consisting of one part of sulphuric acid mixed with from five hundred to a thousand parts of water. By this process, which is called 'raising,' the pores of the hides are distended and rendered more susceptible of the action of the tan, and the substance of the skin is apparently increased; but, as the process does not add to the gelatin of the skin, a hide which is much thickened by

the raising process loses its substance when condensed by the shoemaker's hammer.

Different tanners vary much in the details of the above-described preparatory processes, as well as in those which follow, and which constitute the actual tanning, or conversion of the prepared 'pelt' into leather. Oak bark is the substance most commonly used to supply the astringent principle, and it is crushed or ground to a coarse powder in a bark-mill. The comparative efficiency of this and other vegetable substances used for the same purpose is stated under BARK, vol. iii., p. 457. In the old method of tanning, which is not yet entirely abandoned, the hides and powdered bark were laid in alternate layers in the tan-pit, which was then filled with water to the brim. After some months the pit was emptied and re-filled with fresh bark and water, and this process was repeated whenever the strength of the bark was exhausted. In this way the time required for impregnating the hides varied, according to their thickness and other circumstances, from one to four years. The process has been greatly expedited by the improvements introduced in consequence of the experiments of M. Seguin, a French chemist, which are detailed in Nicholson's 'Journal,' vol. i., p. 271 (quarto series, published in the year 1797), of tanning with concentrated solutions of bark, formed by passing water through a mass of powdered bark, until, by successive infiltrations, it is completely deprived of its soluble tanning principle. Seguin expected that, by the use of very strong solutions, hides and skins might be tanned in as many days as, under the old system, they would require months; but these expectations have been very imperfectly realised in practice, although the new system, which has been very extensively adopted, has been productive of an important saving of time. Without entering into a minute investigation of the objections to the use of concentrated tanning infusions, it may be sufficient to state that, as observed by the late Sir Humphry Davy, in his valuable paper on the operation of astringent vegetables in tanning, published in the 'Philosophical Transactions' for 1803, experience shows that skins which are quickly tanned, by the use of strong solutions, produce leather of less durable quality than that which is slowly formed. Dr. Ure, in reference to this important point, says (*Dict. of Arts, &c.*, p. 1226):—'The older tanners, who prided themselves on producing a substantial article, were so much impressed with the advantages of slowly impregnating skin with astringent matter, that they employed no concentrated infusion (ooze) in their pits, but stratified the skins with abundance of ground bark, and covered them with soft water, knowing that its active principles are very soluble, and that, by being gradually extracted, they would penetrate uniformly the whole of the animal fibres, instead of acting chiefly upon the surface, and making brittle leather, as the strong infusions never fail to do.' In illustration of these remarks, he states that 100lbs. of skin, quickly tanned in a strong infusion of bark, will produce 137lbs. of leather, while the same weight of skin, slowly tanned in a weak solution, produce only 117½lbs.; the additional 19½lbs. in the former case tending to swell the tanner's bill, although it deteriorates the leather, and causes it to contain less of the textile animal solid. Leather so highly charged with tannin is, moreover, so spongy as to allow moisture to pass readily through its pores: but the saving of time and increase of product are strong temptations to the tanner to adopt the system of tanning with concentrated infusions.

The variations of practice among different tanners extend to the substance used as an astringent, as well as to the manner of applying it. Ground oak-bark, which was formerly the only material in common use, and is still the most general, produces good leather of a light-fawn colour. Valonia, of which considerable quantities are imported for the use of tanners, produces leather of great solidity and weight, the colour of which is inclined to grey, and which, according to the 'Encyclopædia Britannica,' is more impervious to water than that made with oak-bark. Valonia consists of the acorns of the *Quercus Ægilops* [*QUERCUS*, vol. xix., p. 214], and is brought from the Levant and the Morea. Catechu, or terra japonica, the inspissated extract of the *Acacia Catechu* [*CATECHU*, vol. vi., p. 367], produces leathers of a dark reddish fawn colour, which is light, spongy, and very

perVIOUS to water. Another substance which has been used of late years is a kind of bean-pod called *divi-divi*. These substances may be used either individually or in various combinations. In the methods of preparing tanning solutions there is also considerable variety. Some tanners use cold water for the purpose, and others hot water or steam; others again, instead of pure water, employ ooze, or tanning liquid, which has been exhausted by use. A further point of difference is found in the strength of the solutions used, which vary exceedingly. When the impregnation of the hides with tannin is effected by laying them flat in the tan-pits, they are frequently taken out to renew the solution; and the skins which have lain near the top of one pit are laid near the bottom of the next, so as to equalize the amount of hydrostatic pressure. Sometimes the tanning is facilitated by suspending the skins vertically in the liquid, by which means they are penetrated quickly; but the plan requires considerable room; and, unless the skins are frequently moved, it occasions injurious folds in the leather. Another plan, which answers well for small light skins, that require but a short time for tanning, is to sew up the skin into the form of a bag, to fill it with tan-liquor, and then immerse it in the pit. The great space required is the principal objection to this plan. In whichever of the above ways the tanning is effected, the hide is subjected to the action of solutions increasing progressively in strength, until it is so perfectly penetrated, that when cut through it presents a uniform brown colour; any appearance of a light streak in the middle of its thickness being an indication of imperfect tanning. When the process is complete, the hides are hung up in a shed, and allowed to dry slowly; and, while they are drying, they are compressed by beating or rubbing, or by passing them between rollers, to give them firmness and density. A yellow deposit is now found upon the surface of the leather, to which the name of 'bloom' or 'pitching' is technically given; and, although this deposit is subsequently removed by the shoemaker in the operation of buffing, and forms a useless addition to the weight and cost of the leather, the prejudice of purchasers requires that it be left on the surface by the tanner. According to the explanation of the 'Encyclopædia Britannica,' this bloom consists of the finer portion of the gelatin from the interior of the skin, dissolved by the exhausted ooze which remains upon the surface by capillary attraction; and the waste and deterioration occasioned by its formation should be prevented by the careful removal, by pressure, of the exhausted ooze.

Although, owing to the many differences in the practice of tanning, no definite time can be stated for the various operations mentioned above, it may be observed that the usual period required for tanning such hides as are used for the soles of men's boots is from six to twelve months, and that from fifteen to eighteen months are required in preparing those of the thickest kinds, which are termed 'buits' or 'backs.' It remains, before noticing the processes of preparing the thinner kinds of leather, to advert to some of the methods which have been contrived for effecting a greater saving of time than could be accomplished by any of those previously mentioned.

Several schemes have been devised for forcing a tanning solution through the pores of the hide by mechanical pressure. Mr. Francis Spilsbury obtained a patent in 1823 for effecting this object in the following manner:—The hides, after being freed from hair, cleansed, and otherwise prepared in the usual manner, were to be carefully examined as to soundness, any accidental hole being then sewed up, so as to make the skin water-tight. Three frames were to be provided of similar shape, and of such a form and size that when laid upon each other, with two hides placed between them, the frames might be screwed together by bolts passing through projecting ears, so that the whole should form a flat water-tight chamber, circumscribed by the middle frame. This apparatus being then placed in a vertical position, tan-liquor was introduced into the chamber or cavity between the hides through a pipe inserted in the centre frame; the air being allowed to escape by another pipe, which should be closed as soon as the chamber became filled with the liquid. The tan-liquor being supplied from an elevated cistern, any required degree of hydrostatic pressure might be produced in the chamber,

f which was to distend or swell out the sides, the liquid through the pores of the skins, its appearance on the outer sides like drops of perspiration. When the leather appeared to be tanned, the liquor was drawn off by a stop-cock, the frames were unscrewed, and the compressed hide were cut off. Spilbury's process was used; the reason of its failure being, according to the author before quoted, in the 'Encyclopædia Britannica,' a large excess of tannin dissolves gelatin; so that a large quantity of gelatin was found on the outer sides of the form of long masses of slime, while the leather which was in weight, was very porous, and unequally tanned, the consequence of the tan-liquor penetrating most thin parts or weakest parts of the hide. The principle of this method not being generally adopted, several similar plans were subsequently contrived by different persons; but these, or most of them, have proved unsuccessful. Of these, allusion may be made to the process patented by Mr. Drake, which consisted in conveying two skins together (after they had received their ordinary tanning), so as to form a bag, which was filled with tan-liquor. The hide was compressed between two vertical frames or racks, by which it was prevented from swelling at the sides, and the liquor was confined to a stratum. As in the last process, the aqueous solution of the tan-liquor percolated through the hides; the penetration of the leather was facilitated by the use of a room so as to promote evaporation from the faces of the bags or skins. To prevent the racks or frames from producing permanent marks on the leather, it is necessary to shift the bags occasionally during the process. In another somewhat different plan, contrived by Mr. Cox, the hides were conveyed up in the form of bags, and supported by a screw-press; and in the process of Mr. Chaplin, the hides were laid in an inclined position, and turned periodically during the action of the tan. With every improvement, it is difficult to tan a hide equally by any one method, and the objection urged against Spilbury's process is to all the modifications of it. In another plan, which has been tried under several forms, the tan-liquor is applied to both sides of the hides, which are placed in an air-tight vessel, and is forced into their pores by means of pneumatic pressure, the air being previously pumped out. This operation may be repeated as often as necessary, until the hides gradually increasing in strength; air being pumped in to fill the pores of the hide between each immersion. Another plan which may be alluded to here is that of Mr. Osmond Cagwell, described by the *Gineer's and Mechanic's Encyclopædia*, vol. ii., in the 'Journal' of the Franklin Institute. It consists in laying the hides upon a quantity of sawdust, in shallow boxes, of which any required number are arranged in a suitable framework, about twelve inches deep. The hides are not laid flat, but their edges a little raised, so that their upper surfaces were troughs capable of holding a layer of the solution, which must be replenished from time to time by filters through the hide and the sawdust, or some porous substance upon which it is laid. The liquor runs off from the bottom of the box or trough, and is somewhat inclined for that purpose, into a vessel provided for it. 'The improvement consists,' according to the specification quoted by Hebert, 'in the application of oak or other bark to hides or skins in the same manner as that when the glutinous (gelatinous) part of the hide has absorbed and become mixed with the tan, or astringent principle, the other part of the hide (the water) may pass off, and leave the hide to receive more of the solution; and so on till it is completely tanned. The operation was performed, it is stated, in a similar manner; but as the outer parts or edges of the hides were not perfectly tanned by it, it was necessary to convey them in vats in the usual manner for three or four days, to complete the process. If the principle of this method is to be advantageous, this, which forms a great improvement in Mr. Cagwell's scheme, might be readily applied to the recent than any of the above-mentioned plans proposed by Messrs. Herepath and Cox, of Bristol; and, as present experience can show, appears to

effect the desired object very completely. Their process, which was patented November 16, 1837, is founded upon the principle of washing a sponge, by alternately allowing it to imbibe water, and then forcibly expressing it. In the old system of tanning, the hide may be compared to a sponge, which, after being saturated in a weak solution, is removed to a stronger, without the fluid contained in its pores being squeezed out; while in the new plan the weak infusion, or ooze, is forced out of the pores of the hide before it is subjected to a stronger, so that the fresh ooze may be able to act more efficiently. This is effected by connecting a number of hides together by strings, so as to form a continuous belt, and passing them between rollers turned by steam or other power, while they are being removed from one solution to another. In order to produce a tolerably uniform belt or continuous sheet of hides, they are either placed alternately head to head and tail to tail; or, if laid across the belt, with the heads and tails towards each side alternately. In one of the arrangements described in the specification, the hides are united into an endless band, and are always passed between the rollers (of which a pair is erected over each pit) in one direction; but in another plan the ends of the belt are not connected together, and the motion of the rollers is reversed when necessary, so that the belt of hides may be delivered into the tan-liquor alternately on each side of the apparatus. The latter arrangement is that described in the recently published article in the 'Encyclopædia Britannica,' from which the following details are derived. The lower roller is about thirty inches in diameter, and is covered with horsehair cloth; and the upper roller, which is pressed against the lower one with any determinate degree of force by means of weighted levers, is only about eighteen inches in diameter, and is covered with woollen cloth. By this process a strong hide may, it is stated, be tanned through in from one to two months, and calf-skins and *kips* (the hides of young cattle) in from twenty to thirty days. Double the usual quantity of work is performed; one-half of the capital required in the common process is rendered unnecessary; the saving on bark, labour, and general cost of manufacture is about 14d. per lb.; and the increase in the weight of butt leather, as compared with that made in the usual way, is as 34 lbs. to 28 lbs. The very thick hides, known as 'butts,' when prepared by the patent process, are sent to market within four months from the time of their delivery in the tanner's yard; and the profits arising from quick returns, great weight of leather produced, and reduced cost of production, are stated to be eight times as great as upon the old plan, the prices of hides, bark, and leather being the same. It should be further observed that the leather made in this way is more elastic and impervious to water than any other.

Although the general principles involved in the preparation of all kinds of leather are the same, and some of the processes above described are performed with little variation upon the skins of smaller animals as well as upon the thick hides of various kinds of oxen, the precise course of operations requires many modifications which cannot be here described. Of the preparation of several of the lighter and more ornamental kinds of leather, a familiar account is given in No. 652 of the 'Penny Magazine,' which is devoted to a sketch of the processes followed at one of the great leather-manufactories of Bermondsey. We have hitherto alluded chiefly to the preparation of the thick hides used for sole-leather, among which several varieties may be found, each distinguished by a different technical name, by which its thickness, quality, or mode of preparation is known; but the thinnest and weakest hides, as well as the skins of calves and other animals, are also prepared for use as upper-leathers, in which case it is necessary to reduce their thickness by shaving or paring them down upon the flesh or inner side, before they are subjected to the action of the tanning infusions. Such hides or skins also require, after leaving the hands of the tanner, to be rubbed, softened, and dressed by the currier, in order to bring them to the necessary degree of flexibility and smoothness. The currier also has recourse to shaving or paring with a peculiarly formed knife, to bring the skin to the requisite tenuity; and it is his office to blacken the surface, which, for common shoe-leather, is done on the flesh side, although for some purposes leather is blackened upon the outer or *grain* side. Horse-hides, which are comparatively weak and thin, are sometimes

dressed in the latter way, under the name of *cordovan* hides, from the circumstance of such leather having been formerly made at Cordova in Spain. Calf-skins supply the quality of leather most generally preferred for the upper part of boots and shoes.

Of the thin skins prepared for ornamental purposes, many are tanned with a substance called sumach, prepared from a plant of the same name. [RURS, vol. xix., p. 484.] At the establishment above referred to, which is commonly known as the Neckinger Mills, sumach leather is extensively prepared; the most important kind being that called 'Morocco,' which is made from goat-skins. In the routine of operations described in the paper from which we quote, the processes of cleansing the skins from fleshy impurities, and removing the hair, &c., present no material variation from those before described. During these processes, the lime employed to assist in the depilation enters the pores of the skin so completely, that it would impede the action of the tanning liquid if allowed to remain. It is therefore removed by immersion in an alkaline solution, which opens the pores in a way resembling the process of 'raising,' described in a previous column. The tanning is then performed by sewing up each skin into the form of a bag, with the grain or hair-side outwards, and nearly filling it with a strong solution of sumach in water. The bag is then fully distended by blowing into it, and the aperture is tied up: after which it is thrown into a large shallow vessel filled with hot water containing a little sumach. The distended bags float in this vessel, and are occasionally moved about with a wooden instrument, until the solution which they contain has thoroughly penetrated their substance. Owing to the thinness of the skins and the heat to which they are exposed, this operation is performed in a few hours. The process is expedited by taking the bags out of the solution and piling them upon a perforated bench or rack at the side of the tub, so that their own weight may force the confined liquid through the pores. When the tanning is completed, the bags are opened to remove the sediment of the sumach; the skins are washed, rubbed on a board, and dried; after which they are ready for dyeing and finishing with a ridged instrument, which imparts to the surface that peculiar grain by which morocco leather is distinguished. An inferior kind of leather, known as 'imitation morocco,' is prepared in a similar manner from sheep-skins. The wool is removed from these skins by the fellmonger; after which they are subjected to great pressure in a hydrostatic press, in order to remove the oleaginous or greasy matter which they contain in a much larger quantity than goat-skins. Surprising as it may appear, these, as well as larger and thicker skins, are often divided or split by a machine into two thicknesses, each of which may be made into leather suitable for some of the purposes to which it is applied, as the covering or lining of books, work-boxes, hats, &c.

Tawing is the name applied to the process by which the skins of sheep, lambs, and kids are converted into soft leather by the action of alum. Of this kind of leather gloves are usually made. Skins intended for tawing pass through a series of operations resembling those by which skins are prepared for tanning, but they are then subjected to a solution of alum and salt, to which, for the superior kinds of leather, flour and yolks of eggs are added, instead of a vegetable astringent solution. Sometimes the skins are put into a kind of barrel with the solution, and then the whole is made to rotate rapidly, by which the skins are quickly penetrated; and in other cases the impregnation is effected in an open tub, the skins being worked in the pasty liquid with the hands, or trampled upon by the naked feet of a man, until the emulsion is thoroughly incorporated with them. They subsequently require a good deal of stretching and rubbing over a kind of blunt-edged knife, and some other finishing operations, to give them the requisite smoothness and suppleness. Many of the gloves sold as kid are really made of lamb-skins, of which considerable numbers are imported from the shores of the Mediterranean. These are brought with the wool on; and, as it would be injured by the action of lime, it is loosened by inducing fermentation or incipient putrefaction in subterranean vaults or cellars; an operation which requires great nicety, since the pelt would be injured by allowing the fermentation to proceed too far. After the wool has been removed, and the skins have been scraped

to free them from a slimy substance which exudes from the pores, the pelts are immersed in lime-water for a few days, to remove the grease which yet remains in them. The subsequent operations of removing the lime, tawing, &c., are similar to those required for other skins. In tawing sheep-skins with the wool on, for housings and similar articles, the wool side is carefully folded inwards, to protect it from the tawing liquid or paste, which is then applied to the flesh side only. Other skins are occasionally converted into leather without removing the wool or hair.

The only other kind of leather to be here noticed is that in which oil or grease is forced into the pores of the skin, to take the place of the animal matter, which would tend to its decomposition by putrefaction. This kind of leather takes its name from a fine soft leather prepared from the skin of the chamois goat; and the process by which it is made is called shamoying or shammying. Such leather was formerly very much used as an article of clothing, especially by soldiers; and it is still applied to several useful purposes, for which its peculiar softness and pliability renders it valuable. Wash-leather may be cited as a common example of this kind of preparation. The skins of deer, goats, sheep, &c. are dressed in this way; and much shamoyed leather is made from the inferior or least regular portion of split skins, in cases where the grain side has been taken off carefully of a uniform thickness for preparation in a different way. In general, when whole skins are shamoyed, the grain surface is removed by scraping or rubbing with pumice-stone. After the usual preparation with lime-water, and subsequent washing in a sour infusion of bran or some similar liquor, to remove the lime and open the pores, the skins are made as dry as possible by wringing or pressing them, and, in the process practised at the Neckinger Mills, are then exposed to the action of fulling-stocks, which consist of heavy wooden hammers, faced with copper, and set in motion by connection with a revolving shaft. A wheel revolves near the head of each hammer, of which two are mounted together in one framework; and this wheel is made, during its revolution, alternately to raise the hammer about a foot, and to let it fall into a trough fitted to receive its head. The leather, or rather a roll of the skins which are to be made into leather, is placed in this trough, and beaten by the hammers until it is perfectly dry. Cod-oil is then poured upon the skins, and forced into their pores by the action of the hammers or stocks; the form of the trough being such that the skins gradually turn themselves over and over during the operation, to render the beating uniform. When the oil is thoroughly beaten in, the skins are hung up to dry, after which they are returned to the trough to receive a fresh supply of oil and a repetition of the beating. This is repeated eight or nine times, until two or three gallons of oil have been imbibed by one hundred skins; and when they are sufficiently impregnated with it, they are placed in large tubs, or hung up in close heated chambers, in which they undergo a kind of fermentation, by which the pores are distended, and the action of the oil upon the fibres is completed; and finally they are immersed in a weak solution of potash, which removes whatever excess of oil may have remained in the leather, forming with a saponaceous mixture. They are then hung up in the open air to dry.

(Dr. Ure's *Dictionary of Arts, &c.*, art. 'Leather;' *Encyclopædia Britannica*, seventh edit., art. 'Tanning;' Hebert's *Engineer's and Mechanic's Encyclopædia*, art. 'Leather;' *Penny Magazine*, No. 652.)

TANSILLO, LUIGI, born of a noble family at Nola in the kingdom of Naples, about the year 1510, wrote in his youth a licentious poem, entitled 'Il Vendemmiatore,' or 'the Vintager,' wherein he deals largely in the obscene jokes and scurrilities in which the peasantry of his country indulge during the vintage season, something after the manner of the antient Saturnalia. This poem, which the author did not intend for the press, was published by some friend through an abuse of confidence. In order to make amends, Tansillo wrote a pious poem, entitled 'Le Lagrime di San Pietro,' of which a part only was published before his death. A more complete edition of it was published in 1606. Malherbe made a translation, or rather wrote an imitation of it, entitled 'Les Larmes de St. Pierre, imitées du Tansille, au Roi Henri III.,' 1587. Tansillo resided chiefly at Naples, at the court of the Spanish viceroy

o de Toledo and his son Don Garcia. He accompanied the viceroy in an expedition against the Barbary. He died about 1584. He wrote also a georgical titled 'Il Podere,' and another didactic poem, 'La Balia,' besides sonnets, canzoni, and other poems, in which he has displayed great poetical talent. He has been compared by some with Petrarca. The edition of Tansillo's works was published at Venice in 1738, in 4to. (Tiraboschi, *Storia della Letteratura Italiana*; Corniani, *Secoli della Letteratura Italiana*.)

[TANACETUM.]
ALIDÆ, a family of Wading Birds. [GRALLA-

genus *Tantalus* of Linnæus stands between the *Ardea* and *Scolopax*, in the twelfth edition of the *Nature*.

It places the genus *Tantalus* between the *Openans*, Lacép.; *Anastomus*, Ill.) and the *Spoonbills* (Linn.). He characterizes the genus as having the nostrils, and the bill of a stork; but the back of the bill is, he observes, rounded, and its point curved upwards and slightly notched on each side: a portion of the bill, and sometimes of the neck, is, he adds, defemured. He notices the following species: the

Tantalus, *Tantalus loculator*, Linn.; the African, *Tantalus Ibis*, Linn.; and the Ceylonese *Tantalus leucocephalus*, the largest of all.

Of *Tantalus Ibis*, he remarks that it is white slightly tinged with purple on the wings, with a yellow beak, and the face naked and red, adding that it was formerly regarded by naturalists as the bird so much resembling the antient Egyptians under the name of *Ibis*. Recent researches had proved that the *Ibis* is a different species, of which he intends to treat thereinafter. He states, is not commonly found in the East, that it had been brought from Senegal. *Tantalus* ranges in the family *Culicivores*.

Mr. Vigors, in the *Règne Animal*, as the senior of Cuvier's *Longirostres*, between *Scolopax enisus*, Cuv.

the legs short and reticulated: these are the most robust, and have the largest bill.

Of this genus Cuvier notices the following species:—

L'Ibis sacré (*Ibis religiosa*, Cuv.; *Abou-Hannes*, Bruce, pl. 35; *Tantalus Æthiopicus*, Lath.). For the adult of this species he refers to *Ossemens Fossiles*, tom. i., pl. 1 and 2 (skeleton and perfect bird); and for the young to Savigny, *Descrip. de l'Égypte, Hist. Nat. des Ois.*, pl. 7.

'This,' says Cuvier, 'is the most celebrated species: it was reared in the temples of antient Egypt, with veneration which approached to worship; and it was embalmed after its death, as some said, because it devoured the serpents which would otherwise have become dangerous to the country:—according to others, because there was a resemblance between its plumage and some of the phases of the moon: finally, according to other some, because its advent announced the rising of the Nile. For a long time it was thought that this *Ibis* of the Egyptians was the *Tantalus* of Africa: we now know that it belongs to the genus of which we are treating. It is as large as a hen, with white plumage, except the end of the wing-feathers, which is black; the last coverts have their barbs elongated, loose, black, with violet reflections, and thus covering the end of the wings and tail. The bill and the feet are black, as well as all the naked part of the head and neck: this part is covered in youth, at least on its upper surface, with small blackish feathers. The species is found throughout the extent of Africa.' [ABOU-HANNES.]

The other species noticed by Cuvier are—*L'Ibis rouge* (*Scolopax ruber*, Linn.; *Tantalus ruber*, Gm.) and *L'Ibis vert*, vulg. *Courlis vert* (*Scolopax falcinellus*, Linn.). (*Règne Animal*.)

The following is the description of *L'Ibis vert* (*Ibis falcinellus*):—Purplish chestnut, with deep green mantle. The young with the head and neck sprinkled with whitish. Locality, South of Europe and North of Africa. (*Règne Animal*.)

This, Cuvier observes, is to all appearance the species which the antients called the *Black Ibis*. [ABOU-HANNES, vol. i., p. 38.]

The views of Mr. Vigors with regard to the position of *Tantalus* will be found in the article *HERONS*, vol. xii., p. 165.

Mr. Swainson states that the *Tantalidæ*, or Ibises, are large and very singular birds, living almost entirely on the swampy banks of rivers and fresh waters, rarely, if ever frequenting open shores, like the more typical waders. He observes that their habits and structure seem compounded of those belonging to the *HERONS* on one side and to the *Rails* [*RALLIDÆ*] on the other: their flight and size, he says, remind us of the former, while their long toes and insectivorous nature are more in unison with the latter. He traces their analogy to the *Tenuirostres* in the metallic colours of their plumage and in their having their heads frequently bare of feathers, as in the *Ampelidæ* and other tenuirostral types. The majority, he remarks, live in tropical latitudes.

In the *Synopsis* the following characters of the family (which is placed between the *Ardeidæ* and *Rallidæ*) are given:—

Tantalidæ.

Family Character.—Size large. Bill hard, considerably lengthened, cylindrical, and curved from the base. Face and head more or less naked. Hinder toe on the same plane as the others. Plumage metallic.

Genera.

Anastomus, Ill. **Open beak.** Bill straight, hard, heavy, solid, compressed, marked with longitudinal wrinkles. Upper mandible very straight; the base thickened at the top and as high as the crown; the tip notched; the margin dentated: under mandible greatly curved upwards, and only touching the upper at the base and at the tip.

Example, *Anastomus lamelligerus*.

Tantalus, Linn. Bill nearly as thick at the base as the head; cylindrical and attenuated towards the tip, which are slender and slightly bent: margins entire. Upper mandible notched. Nostrils naked, vertical, basal, oval-oblong. Toes connected at the base.

Example, *Tantalus loculator*.

Ibis, Antiq. Bill much more slender; cylindrical, and arched from the base. Nostrils basal, lateral. Wings broad, ample: the second and third quills longest.

Example, *Ibis ruber*.



Ibis religiosa, Cuv.—Adult.

Mr. Gmelin, because their bill, arched like that of the *Ibis*, is nevertheless much more feeble, and without arch at the point, whilst the nostrils, pierced to the back of its base, are each prolonged into a furrow to the tip. The bill, he adds, is rather nearly square at its base: there is always, he remarks, some part of the head, or even of the neck, covered with feathers. The external toes are notably longer at their base, and the hind toe is sufficiently long to be of use on the earth. Some of the species, he observes, have been described in No. 1493.

Aramus, Vieill. Bill lengthened, slightly curved towards the point, which is entire and inflexed. Under mandible curved from about the middle and angulated. Furrow of the nostrils long. Nostrils lateral, remote from the base, longitudinal. Feet long. Hallux elevated. Anterior toes divided at their base. Wings moderate; the two first quills shorter than the third, which is the longest. America.

Example, *Aramus scolopaciæ*. (Classification of Birds.)

The Prince of Canino places the *Tantalidæ* between the *Psophidæ* and *Scolopacidæ*, and arranges under the former the genera *Tantalus* and *Ibis*. (*Birds of Europe and North America*.)

Mr. G. R. Gray makes the *Tantalinae* the fifth and last subfamily of the *Ardeidæ*, placing it next to the *Ciconinæ*, and arranging under it the following genera:—

Tantalus, Linn. *Ibis*, Mœhr. *Geronticus*, Wagl. *Cercibis*, Wagl. *Theristicus*, Wagl. *Phimosus*, Wagl. *Harporion*, Wagl. *Falcinellus*, (Ray) Bechst. *Aramus*, Vieill.

Mr. Gray gives the synonyms of all these genera. (*List of Genera of Birds*, 2nd edit.)

We proceed to illustrate the Ibises of America by Nuttall's description of the *Scarlet Ibis*, *Ibis rubra* of Vieillot, *Tantalus ruber* of Linnæus, *Red Curlew* of Catesby.

This species is 23 inches in length and 37 in alar extent. Bill 5 inches long, thick, and of a somewhat square form at the base, gradually bent downwards and sharply ridged; black, except near the base, where it inclines to red. Iris dark-hazel. The face naked, slightly wrinkled, pale-red. Chin bare, wrinkled also. Plumage rich, glowing scarlet, except about three inches of the extremities of the four outer quill-feathers, which are deep steel-blue. Legs pale red; the three anterior toes united by a membrane as far as the first joint. (Nuttall.)

'This brilliant and exclusively American species, inhabits chiefly,' says Nuttall, 'within the tropics, abounding in the West India and Bahama Islands, and south of the equator, at least as far as Brazil. They migrate in the course of the summer (about July and August) into Florida, Alabama, Georgia, and South Carolina; but retire into Mexico, or the Caribbean Islands, at the approach of cool weather. They generally associate in numbers, frequenting the borders of the sea, and the banks and æstuaries of neighbouring rivers, feeding on small fry, shellfish, crustacea, worms, and insects, which they collect at the ebbing of the tide. They are said to be in the habit of perching on trees in companies; but they lay their eggs, which are greenish, on the ground, amidst the tall grass of the marshes, on a slight nest of leaves. When just hatched, the young are black, soon changing to grey, but are nearly white before they are able to fly; by degrees they attain their red plumage, which is not complete until the third year. The young and old associate in distinct bands. In the countries where they abound, they are sometimes domesticated, and accompany the poultry. The Ibis shows great courage in attacking the fowls, and will even defend itself from the insidious attacks of the cat. It is generally esteemed as good food; and its rich and gaudy plumage is used by the Brazilians for various ornaments.' (*Manual of the Ornithology of the United States and of Canada*.)

TANTALITE. [COLUMBIUM.]

TANTALUM. [COLUMBIUM.]

TANTALUS. (Ornithology.) [TANTALIDÆ.]

TANYSIPTERA. [KINGFISHERS, vol. xiii., p. 232.]

TAORMINA. [MESSINA; TAUROMENIUM.]

TAOS. [MEXICAN STATES.]

TAP ROOT. [ROOT.]

TAPAJOS. [BRAZIL.]

TAPE WORM. [ENTOZOA.]

TAPESTRY (French, *Tapiserie*; Italian, *Tappezzeria*).

This name is most commonly applied to the textile fabrics, usually composed of wool or silk, and sometimes enriched with gold and silver, woven or embroidered with figures, landscapes, or ornamental devices, and used as a lining or covering for the walls of apartments. It is derived from the French 'tapis,' which is from the Latin 'tapetum,' 'tapes,' 'tapete.' The Latin word is the same as the Greek 'tapes' or 'tapis' (τάπης, τᾰπίς). The Latin and Greek words signified a carpet or covering for a bed or couch. The French 'tapis,' though generally applied to carpets, is also used to express other figured cloths used

as coverings, such as the coverings of tables; whence, most probably, we have the common expression 'on the tapis,' as applied to subjects under discussion or consideration. Of the use of the word tapestry in this more extended sense, there is an instance in Shakspeare's 'Comedy of Errors,' act iv., sc. 1, where Antipholus of Ephesus sends to Adriana, informing her that

'in the Greek
That's covered o'er with Turkish tapestry,
There is a purse of ducats,' &c.

Johnson, who cites this passage, gives also one from Dryden, in which tapestry is used in the sense of carpet:

'The casements are with golden tissue spread,
And horses' hoofs, for earth, on silken tapestry tread.'

In this more general sense the term is used by M. Achille Jubinal, in his recently published work, entitled 'Recherches sur l'Usage et l'Origine des Tapisseries,' in which he extends his inquiry to worked or figured cloths (tapisseries à ymaiges) used for many other purposes than the covering of walls. To this work we are indebted for much of the following information respecting the history of tapestry.

The early history of the art of producing figured fabrics by the loom may be more conveniently treated of under Weaving than in this place; and it may be sufficient here to observe, that although the loom was employed from the earliest times by the Greeks and Romans for the production of ordinary tissues, its application to the weaving of ornamented or figured fabric was chiefly Oriental. It is probable also that many of the early tapestries were embroidered by hand or worked with the needle. This kind of work, of which the Bayeux tapestry is a celebrated example, was continued long after the practice of weaving tapestry in the loom had become common. The ornamented curtains of the Jewish tabernacle, described in the twenty-sixth, thirty-fifth, and thirty-sixth chapters of Exodus, are generally considered to have been embroidered by the needle. Jubinal supposes that they were worked with a needle in thread of silk, gold, or wool, in such a manner as to imitate the brilliancy of the plumage of birds; but he conceives that the veil of the Holy of Holies, which is described in the English translation of the Bible as of 'cunning work' (*Exodus*, xxvi. 31; and xxxvi. 35), and which was ornamented with cherubim, was produced by the skill of the weaver, 'that is to say, executed by the shuttle with woofs of various colours, and in woven stuff.'

The Jews are supposed to have derived their skill in embroidery and other ornamental work of similar character from the Egyptians, who produced figured cloths both by the needle and the loom, and practised the art of introducing gold thread or wire into such work. Wilkinson observes (*Manners and Customs of the Antient Egyptians*, vol. iii., p. 128), 'Many of the Egyptian stuffs presented various patterns worked in colours by the loom, independent of those produced by the dyeing or printing process, and so richly composed that they vied with cloths embroidered by the needle.' Jubinal quotes several ancient authors who refer to figured tissues as made and used by the Egyptians and other nations of antiquity. Tapestry was used by the Babylonians to represent the mysteries of religion, and to perpetuate historical facts. Philostratus, in his Life of Apollonius of Tyana, mentions Babylonian tapestry ornamented with silver and gold. The Greeks practised the art of embroidering figures upon cloth, and attributed its invention to Minerva. Homer alludes, in several passages of the 'Iliad' and 'Odyssey,' to embroidered stuffs of the character designated by Jubinal 'tapisseries à ymaiges,' among which he comprises even some articles of dress. Without attempting to pursue the investigation of this subject minutely, a general idea of the character of these ornamental tissues may be given by a reference to the article 'Peplum' in the 'Dictionary of Greek and Roman Antiquities,' edited by Dr. Smith; the author of the article 'Peplum' observes, that of all the productions of the loom, shawls were those upon which the greatest skill and labour were employed; and that the subjects represented upon them were so various and tasteful, that poets delighted to describe them. He adds that 'Euripides describes one which represented the sun, moon, and stars; and which, with various others containing hunting-

and a great variety of subjects, belonged to the of Apollo at Delphi, and was used to form a magnet for the purpose of an entertainment (*Ion*, 62); for it is to be observed that stores of shawls only kept by wealthy individuals (Homer, *Odyssey*, -108), but often constituted a very important part treasures of a temple (Euripides, *Ion*, 329, 330), been presented to the divinity on numerous occasions by suppliants and devotees. (Homer, *Iliad*, vi., ; Virgil, *Æneid*, i., 480, *Ciris*, 21-35.)

al substances appear to have been used by the as materials for the ornamental fabrics alluded binal states that flax, wool, and byssus [Byssus, . p. 81] entered into their composition; and richest colours, embroidery, precious stones, and re used in them. It is not very clear in what d manner gold was applied in many cases. In d verse of the thirty-ninth chapter of Exodus, peaks of beating gold into thin plates, and then it into wires, to work it into the ephod with cunrk; and Wilkinson states that probably the gold used in Egyptian embroidery was formed in like and rounded by the hammer. Beckmann (*His-inventions*, vol. ii., p. 212, &c.) enters minutely question, and states that he had not met with a passage in antient authors where mention is made being wire-drawn; yet Jubinal thinks that gold haps sometimes used in antient tapestry in the fine drawn wires, flattened and wound round n a manner resembling modern gold thread. He upposes that gold was sometimes introduced suby to the weaving of the tissue, by loosening its and inserting the gold between the threads.

as are the notices of tapestry in antient writers, rmation respecting it during the middle ages is h fuller. Jubinal observes that we find females in working tapestry with the needle from the epochs of the French monarchy. Gregory of riting towards the close of the sixth century, in rption of the rejoicings which followed the prof Christianity by Clovis and his people, speaks of ets being shaded with painted cloths or curtains (*pictis*), and the churches being adorned with ; and again, in describing the consecration of ch of St. Denis, he mentions tapestries embroith gold and garnished with pearls. The fabrica-tapestry-hangings by the loom appears to have rduced into France, at the earliest, about the stury, until which time the needle had been used ly in their production; and, long after that he two processes were practised concurrently. ime we often find embroidered cloths enumerated he decorations of churches. Jubinal quotes Fa-be for the statement that many tapestries were the church of Auxerre prior to the year 840; plates that, about 983, there existed in the abbey orent, at Saumur, a great manufactory of stuffs, y tapestries, which were woven by the inmates. mtemporary notices, it is evident that there was a d manufacture of tapestry at Poitiers as early as for was the manufacture of tapestry confined to it this period. The inhabitants of the north of also practised it, and English embroidery was imired and highly prized on the Continent. In also, where the art had been cultivated from the antiquity, fine embroidery was produced in the century. Much of the early Oriental tapestry med with grotesque figures; and, long after it usual to depict natural figures and scenery upon such devices were often used in ornamental

twelfth and thirteenth centuries the use of tapes-ded greatly. It passed from churches and monas-which it had been used for curtains, palls, altar-stments, &c., to the residences of the nobility. ng this change, Jubinal observes:—'If, in the of the cloister, the monks had, as we have seen, the weaving of wool and silk for the sake of oc-ladies and their followers, shut up in their castles e long evenings of winter, the tedium of which rupted only by the perusal of works of piety or embroidered with their needles the glorious our forefathers. The high walls of these cold

rooms, built of stone, spoke far more effectually to the hearts and imaginations of those who lived under their protecting shelter, when they were covered with interesting histories, with important instruction, or with glorious remembrances of the past, than when nothing appeared to veil their nakedness.' The use of tapestry in this way was one of the luxuries introduced from the East in consequence of the increased intercourse occasioned by the crusades. The crusaders brought accounts of the Oriental practice of covering walls with prepared and ornamented skins, chiefly those of goats and sheep. These, which were probably at first used of their natural size and shape, were, at a later period, cut into rectangular pieces, about two feet high, and rather less in width, and united by sewing into very solid and handsome hangings, which were well adapted to resist damp. Such hangings, or leather tapestry, were manufactured much at Venice and Cordova, and were sometimes either gilt all over, or ornamented with gilt devices, in which case they bore the name of *d'or basané*. The Oriental origin of the more ordinary kind of tapestry is indicated by the name *Sarazins* or *Sarazinois*, which was frequently applied in France to the early manufacturers.

Numerous allusions to the use of tapestry in the fourteenth and fifteenth centuries, collected from contemporary documents, are given by Jubinal. It was then not only used to cover the nakedness of interior walls, but was also employed, on great occasions, as for instance on the public entries of princes, to decorate streets, and to impart a joyful appearance to towns and public places. It formed part of the decorations of festal halls, and was employed to ornament the galleries and other erections required at tournaments. Rich embroidery was also much employed in the decorations of the horses and men who formed the actors in those chivalric amusements; and the brilliant, though often grotesque devices of heraldry, which formed so important a part of the display upon such occasions, afforded extensive employment to the workers of tapestry and other ornamented tissues.

The art of making tapestry, for which the Flemings had been celebrated from the twelfth century, made considerable progress in Flanders in the fourteenth century, and attained its highest perfection there in the fifteenth. Guicciardini has ascribed the invention of tapestry to Flanders; but, if received at all, this statement must be supposed to refer merely to such as is produced by the loom. It is certain however that Europe is much indebted to the Flemings for the revival and improvement of tapestry, and for the production of many of the finest specimens yet existing. The countess of Wilton, whose interesting volume on 'The Art of Needlework' contains much information upon the subject of tapestry, is probably correct in assuming that the *weaving* of tapestry-hangings was not practised until they had become, from custom, a thing of necessity. 'Unintermitting and arduous,' she observes, 'had been the stitchery practised in the creation of these coveted luxuries, long, very long, before the loom was taught to give relief to the busy finger.' Tapestry manufactories were early established at Brussels, Antwerp, Oudenarde, Lisle, Tournay, Bruges, and Valenciennes; but that of Arras* was more celebrated than any other, and its productions were so highly prized, that the name *arras* became a common expression for the finest tapestry generally, whether made in that place or elsewhere. The hangings of Arras, as well as those of other manufactories in France, were, says Jubinal, for the most part executed in wool. Hemp and cotton were also used in them, but no silk or gold thread. The fabrication of tapestries formed of these substances was carried on chiefly at Florence and at Venice. The recollection of this difference is important in discovering where old tapestries were made, and Jubinal refers to instances of the difference in some of those engraved in his great work on this description of monuments. Writing of the period under consideration, he observes that the devices (*ymaiges*) of the tapestry were very various. We have seen that they sometimes represented scenes from antient history, from the fabulous stories of heroes, and from modern historical events; but the imagination of the tapestry-designers did not stop

* Tapestry of Arras, representing the battles of Alexander the Great, formed part of the present sent by the king of France, in 1595, to the sultan Bajazet, to induce him to ransom some captives taken at the battle of Nicopolis. (Manspherson, *Annals of Commerce*, vol. 1., p. 606.)

there. The hangings of the fourteenth century often represented hunts, fantastical animals, or the occupations peculiar to the different seasons of the year; and romantic and chivalric poems afforded a rich store of subjects for illustration. Jubinal quotes inventories of tapestries, receipts, &c., of the fourteenth century, in which tapestries of the above and of several other varieties are mentioned. The account given of those belonging to Charles V. of France is particularly curious. It is taken from an inventory preserved in the Bibliothèque du Roi, which, besides tapestries ornamented with figures, mentions heraldic tapestries (*tapisseries d'armoirie*), and *tappiz velus*, or hairy or shaggy tapestry. The fifteenth century affords many similar documents, though Jubinal does not give them so fully. He gives however very long extracts from a MS. in the Bibliothèque du Roi respecting some old tapestries, from which it is evident that the names *tapis Sarrazinois* and *tapis de Turquie** were often applied to hangings fabricated in the West, they being probably made in imitation of Oriental work. At this epoch tapestry was often alluded to by poets, and to it is attributed the fabrication of most of the tapestries to which the term 'tapisseries historiées' has been applied.

The sixteenth century, which was an age of general improvement in France, gave a new impulse to the production of tapestry. Francis I. founded the manufactures of Fontainebleau, in which threads of gold and silver were skilfully introduced into the work. It was, we are informed, with this new impulse that the practice was commenced of weaving tapestry in a single piece, instead of composing it, as before, of several smaller pieces joined together. This prince brought Primaticcio from Italy [PRIMATICCIO, FRANCESCO, vol. xix., p. 1], and, among other works of art, commissioned him to make designs for several tapestries, which were woven at Fontainebleau. Francis spared no pains in the encouragement of this department of the fine arts. He engaged Flemish workmen, whom he supplied with silk, wool, and other materials, and paid liberally for their labour; and documents exist to prove that he also patronized the tapestry-makers of Paris. Henry II., the son and successor of Francis, continued to encourage the manufactory at Fontainebleau, and established a manufactory of tapestry on the premises of the Hôpital de la Trinité, which attained its highest celebrity in the reign of Henry IV., and produced many fine tapestries. In 1504 Du Boung, the most eminent artist connected with this establishment, made there the celebrated tapestries of St. Meri, which were in existence until a recent period; and these pleased Henry IV. so much, that he determined to re-establish the manufactory of tapestry at Paris, where it had been interrupted by the disorders of the preceding reigns. This he did in 1597, bringing Italian workers in gold and silk to assist in the work.

The narrative of M. Jubinal, from which most of the preceding facts are taken, does not extend later than the close of the sixteenth century; but, to continue the history of the tapestry manufactory in France without interruption, we may turn to the volume recently published by the Countess of Wilton. A few years after the events last mentioned, as appears from his 'Memoirs,' the Duc de Sully, Henry's minister, was actively engaged in promoting this branch of industry. In 1605 were laid the foundations of new edifices for the tapestry-weavers, in the horse-market at Paris; and at that time, or a little later, Flemish workmen were engaged to superintend the manufactory. The establishment languished, if it did not become quite extinct, after the death of Henry IV.; but when the royal palaces, especially the Louvre and the Tuileries, were receiving their rich decorations, in the reign of Louis XIV., his minister Colbert revived it, and from that time the celebrated royal tapestry-manufactory of the Gobelins dates its origin. This was established in premises which had been erected by celebrated dyers

named Gobelin [GOBELIN, vol. xi., p. 286], but which were purchased by Louis XIV. in or about the year 1666, and adapted to the tapestry-manufacture, under the name of Hôtel Royal des Gobelins. Foreign artists and workmen were engaged, laws were drawn up for the protection and government of the manufactory, and everything was done to render it, what it has ever since remained, the finest establishment of the kind in the world. 'The quantity of the finest and noblest works that have been produced by it,' observes the work above referred to, 'and the number of the best workmen bred up therein, are incredible; and the present flourishing condition of the arts and manufactures of France is, in great measure, owing thereto.' The production of tapestry at the Gobelins is said to have attained the highest perfection in the time of the minister Colbert and his successor M. de Louvois. Le Brun, when chief director of the establishment, made many designs for working after; and M. de Louvois caused tapestry to be made from some of the finest designs of Raphael, Julio Romano, and other Italian painters. A further account of this celebrated manufactory is given in the elegant volume which has just appeared under the title of 'The Hand-book of Needlework,' the authoress of which writes under her maiden name, Miss Lambert. She states that the manufactory declined greatly at the Revolution, but was revived under the government of Napoleon, and has ever since been carried on successfully, though by no means to the same extent as formerly. About 1802 ninety persons were employed in it, chiefly in preparing tapestry for the palace of St. Cloud. 'The pieces executed,' according to the work last named, 'are generally historical subjects, and it occasionally requires the labour of from two to six years to finish a single piece of tapestry.' 'The productions of this manufactory,' says the same authority, 'which is entirely supported by the government, are chiefly destined for the royal palaces, or for presents made by the king; but some few pieces, not designed as such, are allowed to be sold.' Wool is the only material now used; it being found to retain its colours better than any other; and in connection with the weaving establishment is one for dyeing wools, under the direction of able chemists, in which many colours are dyed for this purpose exclusively. From a passage in Evelyn's 'Diary' (Oct. 4. 1693), in which he speaks with admiration of some new French tapestry he had seen in the apartments of the duchess of Portsmouth, it appears that the productions of this manufactory were known in England at that time.

The preceding historical notices respecting tapestry refer almost exclusively to France, but we must retrace our steps to take a brief review of the use and manufacture of this kind of fabric in England. Respecting the Anglo-Saxon period, it is observed in the 'Pictorial History of England' (vol. i., p. 323):—'The dwellings of the higher classes appear to have been completely and sometimes splendidly furnished: their walls were hung with silk richly embroidered with gold or colours. The needle-work for which the English ladies were so famous was herein displayed to great advantage. Ingulphus mentions some hangings ornamented with golden birds in needle-work, and a veil or curtain on which was represented in embroidery the destruction of Troy. In the Anglo-Saxon poem of Beowulf we read that, in 'the great wine-chamber'—

'There shone variegated with gold
The web on the walls,
Many wonders to the sight
Of each of the warriors
That would gaze on it became visible.'

'The Saxon term for a curtain or hanging was *wærifst*; and, in the will of Wynflæda, we find the bequest of a long *heall wærifst* and a short one. The same lady also bequeaths three coverings for benches or settles *sel-hæragl*.' THE BAYeux TAPESTRY (vol. iv., p. 68) is perhaps the most ancient piece of needlework in existence. It was probably owing to the expense of such hangings, when of large size, and the very long time required for their production, that the less comfortable device of painting the walls of chambers was extensively adopted in the early Norman period. Of this time the work before quoted observes (vol. i., p. 635):—'The hangings of needle-work and embroidery which adorned the walls of the Anglo-Saxon palaces, seem to have been partially superseded in the course of this period by the fashion of

* In describing, in a subsequent page, a remarkable Persian tapestry of the sixteenth century, embellished with emblematical devices which belong to the possession of the Marquis de Lognon, at Aix, Jubinal observes that the finest Persian tapestries are the produce of Khorassan, especially of the town of Yazd. These, he adds, are what we commonly call Turkish tapestries, not because they come from the Ottoman empire, but because, before the discovery of the passage round the Cape of Good Hope, Turkey formed the only way of communication with Persia. The establishment of the royal tapestry manufactory in France put an end to the importation of foreign tapestry; but the art of working it is stated to be continued successfully in the East, even to our own day.

on the walls themselves, or the wainscot of the same historical or fabulous subjects which have been displayed in threads of colours and many instances might be enumerated of this kind of art, but it is sufficient to refer to the directions of Henry III. early in his reign, for the painting of the scotched chamber in Winchester castle with the figures with which it had been previously adorned; an instance presumed by Walpole to indicate the very existence of historical painting in England. The allusion to appears to have extended considerably to the reigns of Henry III. and his immediate successors, according to the same authority (vol. i., p. 102). The paintings were, in several instances, directed to be in imitation of needle-work tapestries. Lady Wilton's that tapestry of needle-work, like the Bayeux of Matilda, which 'had been used solely for the decoration of altars, or the embellishment of other portions of edifices, on occasions of festival or the performance of solemn rites, had been of much more general use amongst the luxurious inhabitants of the island than was introduced into England as furniture hanging in the palace of Castile.' That tapestry was not originally introduced by that queen will be seen by the facts above; and we know not whether there is any authority for the statement that the mention, by the Countess of Paris, of her having used tapestry for covering the walls of her apartments, the word being apparently used in the sense of carpet. (*St. of England*, vol. i., p. 865, note.) Chaucer alludes to a 'tapiser,' in company with a 'webbe' and among his Canterbury pilgrims; from which circumstance it may be presumed that the business was not common one towards the close of the fourteenth century.

In the fifteenth century the use of tapestry continued in England; but then, and for long after, the principal supply appears to have been from the Continent. In the sixteenth century a kind of hanging was introduced which holds a place intermediate between wall-papers and woven or embroidered tapestry. Shakspeare alludes to these hangings under the name of cloths.*

The appearance of the rich tapestry common in the sixteenth century is admirably described by Spenser, in the *Shepherd's Calendar*, book iii., canto ix., in the account of the apartments seen by Britomart in the apartments of the Busirane, in the following lines:—

Round about the walls yclothed were
The goodly arras of great majesty,
Woven with gold and silke so close and nere,
At the rich metall lurked privily,
Faining to be hid from envious eye;
There, and there, and every where, unawares
Shew'd itselfe, as if shone unwillingly;
There a discolour'd snake, whose hidden snares
Though the greene gras his long bright burnisht back declares.

Spenser described what he was in the habit of seeing, and the art remains yet exist to attest the accuracy of his description; although in most cases the brilliancy of the gold threads and the beauty of the colours are impaired, and in some instances the gold and silver have been artfully withdrawn, their intrinsic value too strong a temptation for cupidity to resist.

The introduction of tapestry-weaving into England is attributed to a gentleman named Sheldon, late in the reign of Henry VIII. Lady Wilton mentions indeed the introduction by Walpole of its origin as early as the reign of Edward III.; but if any attempt was made to introduce the art at that time, it does not appear to have any important result. According to her 'Art and Mystery of Tapestry,' Sheldon allowed an artist, named Robert, to use his manor-house at Burcheston, in Warwickshire, for the practice of the art; and mentioned him in which was dated 1570, as 'the only auter and artificer of tapistry and arras within this realme.' At Burcheston were worked in tapestry, on a large scale, in Oxfordshire, Worcestershire, Warwickshire, and Wiltshire, some fragments of which were, it is said, in the collection at Strawberry Hill. Little is known of this establishment. James I. endeavoured to revive the manufacture of tapestry by encouraging the formation of an establishment at

Mortlake, about 1619, under the management of Sir Francis Crane. James I. gave 2000*l.* towards the formation of this establishment, which appears to have been originally supplied with designs from abroad, but subsequently by an artist named Francis Cleyne, or Klein, a native of Rostock, in the duchy of Mecklenburg, who was engaged for the purpose. This undertaking was a favorite hobby both with James and his successor, who regarded Cleyne so favourably that he bestowed upon him, in 1625, an annuity of 100*l.* (Rymer's *Fœdera*, vol. xviii., p. 112), which he enjoyed until the civil war. In the same year Charles I. granted 2000*l.* a year for ten years to Sir Francis Crane, in lieu of an annual payment of 1000*l.* which he had previously covenanted to pay for that term, as the grant recites, 'towards the furtherance, upholding, and maintenance of the worke of tapestries, latelie brought into this our kingdome by the said Sir Francis Crane, and now by him and his workmen practised and put in use at Mortlake, in our countie of Surrey;' and of a further sum of 6000*l.* due to the establishment for three suits of gold tapestries. (*Fœdera*, vol. xviii., p. 60.) After the death of Sir Francis Crane, his brother, Sir Richard, sold the premises to the king, and during the civil war they were seized as royal property. After the Restoration, Charles II. endeavoured to revive the manufacture, and employed Verrio to make designs for it, but the attempt was unsuccessful. Lady Wilton however conceives that, although languishing, the work was not altogether extinct, 'for,' she observes, 'in Mr. Evelyn's very scarce tract entitled "Mundus Muliebris," printed in 1690, some of this manufacture is amongst the articles to be furnished by a gallant to his mistress.' During its period of prosperity, this manufacture produced the most superb hangings, after the designs of celebrated painters, with which the palaces of Windsor Castle, Hampton Court, Whitehall, St. James's, Nonsuch, Greenwich, &c., and many of the mansions of the nobility, were adorned. Five, at least, of the cartoons of Raphael, which appear to have been bought by Charles I. for that purpose, were worked in tapestry at Mortlake. These celebrated works were designed for the purpose of being copied in tapestry, and were originally worked in Flanders. [*CARROON*, vol. vi., p. 330.] An act of parliament was passed in 1663 to encourage the linen and tapestry manufactures of England, and to restrain the great importation of foreign linen and tapestry.

The use of the word 'hangings,' as applied to tapestry, as well as to other kinds of lining for rooms, perhaps sufficiently indicates the manner in which such decorations were formerly put up. 'The tapestries,' observes the Countess of Wilton, 'whether wrought or woven, did not remain on the walls as do the hangings of modern days: it was the primitive office of grooms of the chamber to hang up the tapestry, which, in a royal progress, was sent forward with the purveyor and grooms of the chamber.' She relates a curious anecdote in illustration of this practice. Henry IV. of France, wishing to do honour to the pope's legate, the cardinal of Florence, when visiting St. Germain-en-Laye, sent orders to hang up the finest tapestry; but, by an awkward blunder, the suit selected for the cardinal's chamber was embellished with satirical emblems of the pope and the Roman court. The mistake was discovered by the Duc de Sully, on whose authority the anecdote is given, and another suit was substituted for that with the offensive devices. In a subsequent chapter, on 'The days of good Queen Bess,' after showing the universality of tapestry and similar decorations in the houses of the nobility and gentry of England, it is stated that tapestry was at that time suspended upon frames, which were probably, in many cases, at a considerable distance from the walls, as we frequently read of persons concealing themselves, like Falstaff (*Merry Wives of Windsor*, act iii., scene 3), 'behind the arras.'

The interest attached to ancient tapestries as historical monuments, as well as in the character of works of art, is of no mean order. The most important work on this department of archæology is that of M. Jubinal, the author of the historical treatise quoted in the former part of this article, entitled 'Les Anciennes Tapisseries Historiées,' in which are given minute descriptions, illustrated by many large folio plates, of the most remarkable tapestries made from the eleventh to the sixteenth century, and preserved to the present time. Such monuments, as he observes in his preface, sometimes represent to us, with a charming and

* In the edition (1821) many references to this kind of substitute for embroidered tapestry, by various authors, are given. See notes on 'it,' act iii., s. 2 (vol. vi., pp. 434-6), and 'Henry IV.,' Part 2, vol. xviii., p. 84). From the latter passage it would appear that alluded to were sometimes painted in water-colours.

faithful *naïvete*, grave historical events, and sometimes scenes of gaiety. There they show us a siege or a tournament; here, a feast; a little farther, a chace; and always, whether chace, banquet, tournament, or siege, all is, as Montaigne would have said, pourtrayed to the life; they all retrace to us most literally the mode of life of our fathers, showing us their residences, their churches, their dresses, their arms, and even (thanks to their explanatory legends) their language at different epochs. Further than this, if we refer to the inventory of Charles V., made in 1379, we find that all the French literature of the fruitful ages preceding the era of that wise monarch had been by his orders translated into wool.' At a later period, although the beauty of tapestry was increased by improvements in the arts of weaving and dyeing, and by the adoption of superior designs, much of its peculiarly interesting character was lost. Jubinal, in the smaller work frequently quoted in the earlier part of this article, regrets the disappearance of the Gothic labels, which contained quaint descriptions of the subjects represented; of the peculiar architecture of the middle ages (*architecture à ogives*), and of the furniture and dresses of our forefathers; and he conceives that their place is but ill supplied by the imitation, 'clever in the great masters, but detestable in their disciples,' of Greek and Roman forms, of which he refers to 'celebrated and grievous examples in the compositions of Rubens reproduced by the manufactory of the Gobelins; in the tapestries of Beauvais, and in those of Aubusson.'

In the primitive method of working tapestry with the needle, the wool was usually applied to a kind of canvas, and the effect produced was coarse and very defective; but some finer kinds of tapestry were embroidered upon a silken fabric. The process of weaving by the loom, after the manner known as the *haute lisse*, or high warp, was practised in the tapestries of Flanders (and, according to Jubinal, in those of England also), as early as the fourteenth and fifteenth centuries; the only essential difference between these and the productions of modern times being that previously noticed, the comparative size of the pieces woven in the loom. The weaving of tapestry, both by the 'haute lisse' and the 'basse lisse,' appears to be of Oriental invention; and the difference between the two methods may be briefly described. In the 'haute lisse' the loom, or rather, the frame with the warp-threads, is placed in a perpendicular position, and the weaver works standing; while in the 'basse lisse' the frame with the warp is laid horizontally, and the weaver works in a sitting position. In weaving with the 'basse lisse,' which, Miss Lambert observes, is now relinquished, the painting to be copied is laid beneath the threads of the warp, which are stretched in a manner resembling that of common weaving, the pattern being supported by a number of transverse threads stretched beneath it. The weaver, sitting before the loom, and leaning over the beam, carefully separates the threads of the warp with his fingers, so that he may see his pattern between them. He then takes in his other hand a kind of shuttle, called a *flûte*, charged with silk or wool of the colour required, and passes it between the threads, after separating them in the usual way by means of trolldes worked by the feet. [WEAVING.] The thread of wool or shoot thus inserted is finally driven close up to the finished portion of the work by means of a reed or comb formed of box-wood or ivory, the teeth of which are inserted between the threads of the warp. In this process the face of the tapestry is downwards, so that the weaver cannot examine his work until the piece is completed and removed from the loom. The frame of the 'haute lisse' loom consists of two upright side-pieces, with large rollers placed horizontally between them. The threads of the warp, which usually consist of twisted wool, are wound round the upper roller, and the finished web is coiled round the lower one. The cartoon, or design to be copied, is placed perpendicularly behind the back or wrong side of the warp, and then the principal outlines of the pattern are drawn upon the front of the warp, the threads of which are sufficiently open to allow the artist to see the design between them. The cartoon is then removed so far back from the warp that the weaver may place himself between them with his back towards the former, so that he must turn round whenever he wishes to look at it. Attached to the upright side-pieces of the frame are contrivances for separating the threads of

the warp, so as to allow the *flûte*, or broach, which carries the wool, to pass between them. Like the weaver with the 'basse lisse,' the operator works, as it were, blind-fold; but by walking round to the front of the loom he may see the progress of his work, and may adjust any threads, which have not been forced into their right position by the reed or comb, with a large needle, called an *aiguille à presser*. The process of working with the 'haute lisse' is much slower than the other, and is indeed, says Jubinal, almost as slow as that of working with the needle. Lady Wilton, in describing the productions of the Hôtel Royal des Gobelins, observes that 'Not the least interesting part of the process was that performed by the *rentrayeurs*, or fine-drawers, who so unite the breadths of the tapestry into one picture, that no seam is discernible, but the whole appears like one design.' Now, however, the pieces are woven so wide that joining is very seldom resorted to, even for the largest pieces.

(Jubinal, *Recherches sur l'Usage et l'Origine des Tapisseries à Personnages, dites Historiées; The Art of Needlework*, edited by the Right Honourable the Countess of Wilton; *The Handbook of Needlework*, by Miss Lambert; &c.)

TAPHOZO'US. [CHEIROPTERA, vol. vii., p. 24.]

TAPIO'CA, a farinaceous substance, prepared in South America from two species of Janipha, or the bitter and sweet Cassava or Manioc plants, which two were long regarded as one species, and comprehended under the name of *Jatropha Manihot*, till Pohl distinguished them, calling the bitter *Manihot utilisima*, and the sweet *Manihot Aipi* (Pohl, *Pl. Brasil.*, ic. i. 32 t. 24). The chief distinction between them is that a 'tough ligneous fibre or cord runs through the heart of the sweet Cassava root, of which the latter is destitute.' Though the bitter contains a highly acid and poisonous juice, from which the sweet is exempt, yet the bitter is cultivated almost to the entire exclusion of the other, which is probably owing to the greater facility with which it can be ground or rasped into flour, owing to the absence of the ligneous centre. The poisonous principle of the bitter manioc is thought to be of the nature of hydrocyanic acid. (Guibourt, *Hist. des Drogues*, tom. ii., p. 455. 3ième ed.) It is easily dissipated or decomposed by heat or fermentation; hence the flour becomes perfectly wholesome in the process of baking the cassava bread. [CASSAVA, vol. vi., p. 344.] The juice, after expression, may be inspissated by long boiling, or formed into a soup, with fish and spices, called *cassarepo*. By means of molasses it can be fermented and converted into intoxicating drink.

The *fecula*, or flour, after the juice has been carefully expressed, having been washed, and dried in the air without heat, is termed *mouchaco* in Brazil, *moussach* in the Antilles, and *cypipa* in Cayenne. This constituted the Brazilian arrow-root of English commerce. When this *fecula* is prepared by drying on hot plates, it becomes granular, and is called *tapioca*. It occurs in irregular lumps or grains, and is partially soluble in cold water. The granules, diffused through water, and examined by the microscope, are of great uniformity of size, and smaller than those of arrow-root from the *Marantas*. Tapioca is very nutritious and easy of digestion, being free from all stimulating qualities. It is therefore very necessary to distinguish it from an artificial tapioca made with gum and potato starch, which is in larger granules, whiter, more easily broken, and more soluble in cold water than the genuine.

TAPIR, *Tapirus*, the name of a genus of pachydermatous quadrupeds.

Linnaeus does not notice the Tapir in the 12th his last) edition of the *Systema Nature*; but Gmelin quotes it as the Hippopotamus (terrestris) pedibus posticis sulcatis. (*Syst. Nat.* x. i., p. 74. n. 2.)

Gmelin introduces it under the title *Tapir*, between HIPPOPOTAMUS and SUS.

Cuvier arranges the genus as the last of his *Pachydermes Ordinaires*, making it immediately succeed the extinct *Palæotheria* and *Lophiodons*. The genus was well known to the older zoologists who wrote on the natural products of America, as we shall hereafter see.

ORGANIZATION.

Skeleton. When viewed in profile, the pyramidal elevation of the skull of the Tapir, calling to mind what is to

in the hog, strikes the observer forcibly. But the skull of the Tapir differs from that of the hog in having no premaxillary bones; and also in this, that its anterior line is not defined by the meeting of the lateral faces, and it is only at the front that it is dilated into a triangle, which is formed by the frontal bones: these are early united and directed backwards. At the middle of the base of this triangle, which the bones of the nose are articulated, is a deep furrow which penetrates between them; and from the two sides above the orbits descends a deep furrow produced by the structure of the upper border of the orbit, and approaches towards the suborbital hole: it serves for the insertion of the muscles of the proboscis. The sphenoid bone descends lower than the mid-height of the head, is not united to the orbit, and has the postorbital apophyses but little

part of the cranium which is in the temporal fossa. The occiput is a small demi-oval extremely thin plate, because the occipital crest projects considerably backwards in a parabolic shape. The occipital condyles rest on the cranium. The frontal bones descend in the temple, and are there articulated with the ethmoidal, the palatine, the two sphenoids, and the temporal. The parietals are square, very large, occupy a great portion of the sagittal crest, and united also between them. The nasal bones are no less striking a feature in the form of the cranium. They are very short, articulated to the frontals by their base, and to those of the upper jaw by a descending apophysis; but they are free and unattached, forming a kind of triangular penthouse above the nostrils. This structure, which reminds one of the trunk of the elephant, indicates the presence of a moveable proboscis. The aperture of the nostrils thus becomes extremely long, nearly horn-shaped, and bordered in great part by the maxillary bones, which advance well beyond the bones of the nose, to form the projecting part of the muzzle, they carry the intermaxillary bones which (a remarkable thing, observes Cuvier) are ankylosed together in the individual examined, although it was very young, and consequently not a single bone, and Cuvier remarked the same thing in other crania. It was only in a nascent state when no tooth had come forth, that he found the high arch separates the maxillaries from each other. The intermaxillaries form a ceiling under the upper border of the orbit and the half of the face due to the *os maleæ*, or jugal bone; the rest to the zygomatic bone. The zygomatic arch is curved downwards in the anterior portion, and upwards at its posterior end, projects moderately outwards. The *os unguis*, or orbital bone, touches the malar bone, and advances a little into the cheek, and moderately into the orbit. There are also lacrymal bones in the very border of the orbit, and each is provided with an apophysis, the upper of which is the suborbital hole is oval, rather large, and at a distance in front of the suture, which unites the orbit to the lacrymal to the maxillary bone. The hole is elliptical and very long, in great part, directed downwards.

The suborbital hole is oval, rather large, and at a distance in front of the suture, which unites the orbit to the lacrymal to the maxillary bone. The hole is elliptical and very long, in great part, directed downwards. The posterior nasal fossæ notch the palatine from the maxillary bone corresponds to the third. The palatine bones contribute much to the structure of the orbit, and the sphenoid very little: these are short and truncate, with a small hook which is the internal pterygoid wing, and which remains a considerable time a detached bone. The sphenoid does not reach the parietal in the temporal fossa, but is separated from it by the squamous portion. The sphenoid bone there forms a long and narrow tract, which extends forward for the length of the upper border of the maxillary bone up to the suborbital canal. Behind the sphenoid is the cavity of the temporal bone, which is very thin, and is formed by a semicircular lamina, descending vertically and then curving itself forwards and inwards: it interrupts the lateral motion of the lower jaw. Between this and the mastoid apophysis is a rather narrow notch through which the meatus auditorius internus is found. The mastoid apophysis descends as low as this lamina. It reaches the orbit by its anterior tubercle, and the occipital condyle. The hole analogous to the sphenoid-palatine is in the middle of the orbital tract of the palatine bone. The sphenoid bone of the pterygo-palatine bone is below it, on the side of the palatine with the maxillary bone. The

optic foramen is small, and placed on the suture of the frontal and of the anterior sphenoid bones. The sphenoid orbital and round foramina are only separated from each other by a delicate lamina. There is a rather large vidian canal. The oval hole is confounded with the anterior and posterior apertures, so that a great portion of the petrous bone is separated from the sphenoid and basilar by a space. The tympanic bone does not appear to be ever ankylosed with the neighbouring bones, and falls easily, as in the hedgehog, the opossum, &c.

The lower jaw exhibits a striking width at its ascending ramus, and presents a rounded contour backwards at its posterior angle. Its coronoid apophysis elevates itself in the form of a pointed falx above the condyle, which is transverse and large. The two jaws are a little concave laterally at the vacant interval of the teeth, and are very much narrowed there; their edge is trenchant.



Skull of American Tapir.

Bones of the Neck and Trunk.—The lateral apophyses of the atlas are wide, but little extended outwards: the spinous process of the axis is an elevated crest; the transverse processes are small and irregular; the odontoid is large and obtuse; the transverse processes of the three succeeding vertebræ descend obliquely, are a little widened at the end and cut nearly square; their spinous processes are very small. The fifth cervical vertebra has a small apophysis on its transverse process, which, for the rest, resembles that of the preceding vertebræ, but is rather longer: its spinous process is also rather longer; still more is that of the seventh vertebra, the transverse process of which is very small—in short, a simple tubercle. The articular facets of the cervical vertebræ rise obliquely from within outwards, so that the articular facet of one vertebra is below that which responds to the preceding vertebra. The bodies of the vertebræ are convex forward and concave behind, an organization which is more or less repeated in the rest of the spine. The number of dorsal vertebræ amounts to twenty; the spinous apophysis of the second is the longest. They decrease and incline backwards to the eleventh, from which they become straight, square, and nearly equal. Their articular apophyses are so fitted that those of one vertebra are in advance and above those which correspond with it in the vertebra below. Cuvier found twenty pairs of ribs in one individual, nineteen in another, eight of which are true, all slender and rounded for the greatest part of their length. The breast-bone is composed of five bones: its anterior portion is compressed, and projects in the form of a ploughshare. There are four lumbar vertebræ, the transverse apophyses of which are rather large. Those of the last, which are rather shorter and oblique, are articulated with the first sacral vertebra. These transverse apophyses have on their base the same elevated crests as the dorsals have for articulation with the ribs.

The *os sacrum* of the adult consists of seven vertebræ, the spinous apophyses of which are distinct and inclined backwards; the five last of these apophyses are short and terminate by a widened disk. The tail has seven vertebræ.

Bones of the Extremities.—The blade-bone has a strong semicircular notch towards the lower part of its anterior border; the rest of this border is round as well as the upper border: the posterior border makes an angle upwards and then descends a little concave. There is neither acromion nor coracoid process, if a hook-like process be excepted. The spine of the bone terminates at the lower third of it, its greatest projection is at its middle; the articular surface is oval and higher than it is long. This

blade-bone, says Cuvier, emphatically, and not more emphatically than truly, cannot be confounded with that of any other animal.

The head of the humerus is powerful, behind the axis of the bone. Its large tuberosity is bilobated by a rounded notch; its bicipital canal is simple and not wide; the ridge is little marked; the condyles do not project much. The radial articular face is divided by a projecting rib into an entire pulley on the internal side, and the half of

one on the external side; both the one and the other correspond to projections of the radius, so that this last has no rotation. It is even probable, observes Cuvier, that with age it is anchylosed to the ulna, which remains throughout its length on the external edge of the arm. The upper head of the radius is nearly rectangular; its body, rounded in front, is flattened behind. The body of the ulna is triangular. One of its crests follows the external crest of the radius.

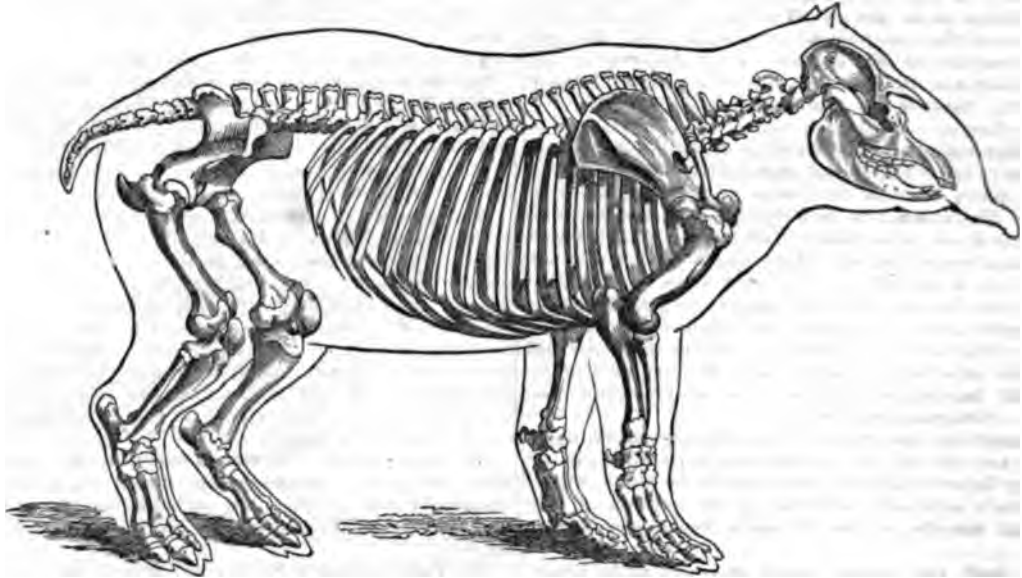

Skeleton of American Tapir.

The carpus of the Tapir bears a near resemblance to that of the RHINOCEROS, especially in having, like it, a single small bone articulated with the wedge-shaped and unciform bones, in lieu of the trapezoid and thumb; but this bone is articulated with the metatarsal bone of the index, which is not the case in the rhinoceros. The other bones of the wrist are nearly of the same form, excepting that their width is less in proportion to their height, a condition which is true even with regard to the unciform bone, although it has to carry two complete metacarpals, whilst in the rhinoceros it only carries one and the vestige of another. The pisiform bone is also longer in proportion in the Tapir. The metacarpal of the middle finger is longest and straightest; those of the index and ring-finger are curved nearly symmetrically one with reference to the other, as in the rhinoceros. But the Tapir has also one small, short, and rather irregular metacarpal. The three first fingers are those which touch the earth, and their unguis phalanges resemble those of the rhinoceros; the little finger does not touch the ground. The first phalanges are longer than they are wide, but the contrary is the case with regard to the second.

The widened part of the ossa ilii is very broad transversely, and a little concave outwards. The external edge of this bone is larger than the internal one; the anterior border is largely concave, and the two spines are, as it were, truncated; its neck is narrow, with reference to its length; the oval holes are longer than they are wide, and the posterior extremity of the ischium terminates in a point very distant from its correspondent. The anterior passage of the pelvis is as long as it is wide, and nearly circular.

The femur has its great trochanter pointed, forming a projection backwards, and giving off a rib which descends along the external border. Besides the two ordinary trochanters, there is a third, which is flattened and recurved in front. In these points its resemblance to that of the horse is perceptible, but it differs much in having the two borders of the rotular pulley nearly equal. The fibula is curved outwards, which separates it a little from the tibia: this last has its upper head rather marked, but the tuberosity which terminates this end above is obtuse and curved but little. Its lower head is wider than it is long, is oblique, and its antero-posterior diameter on the

internal side is wider, and this border more projecting than that of the fibular side.

The tarsus of the Tapir is still better modelled carpus after that of the rhinoceros, of which it can be only a repetition: only the os calcis is much elongated and more compressed; but its facets are the same. The neck of the astragalus is longer and to the cuboid bone by a narrower facet. There is no vestige of a hind toe, but the little finger is represented by an elongated bone, bent at the end, articulated to the phoid, to the small cuneiform and the external phoid bones. The posterior tubercle of the cuboid bone is projecting and less hooked than in the rhinoceros. (*mens Fossiles.*)

Cuvier, in his osteological comparison of the Indian Tapir with the American form, observes that a glance at the profile of their respective crania is sufficient to impress upon the observer their specific differences. The forehead of the Indian Tapir is, he observes, so convex, that it rises higher than the occiput: it elevates in its rise the nasal bones, which much prolongs the ascending part of the jaws and the descending portion of the frontal bones along the external aperture of the bony nostrils, thus giving much wider room for the comparatively large proboscis, and adding length to the furrows where the muscles are inserted. This organization, he observes, explains why the Indian Tapir has a more powerful and extensible trunk than that of America. There is even, he adds, in the Indian species, on the base of the nasal bones at their junction with the frontal bones, and on each side, a deep fossa which does not exist in the other species. This elevation of the forehead is accompanied by a depression of the occipital crest, which, far from forming a pyramid, as in the American species, rather descends backwards. The aperture of the bony nostrils, so enlarged by the prolongation of the maxillary bones, terminates below and forwards by more elevated intermaxillaries, which are for the rest anchylosed together in early youth as in the American Tapir.

The interval between the canine and the first molar is less in proportion in the Indian Tapir, whose dentition is otherwise the same with that of the American species.

The zygomatic apophysis of the Indian species is a little higher backward and less forward: its mastoid apophysis is more transversally turned.

The occipital surface of the skull offers a difference corresponding to that of the profile, inasmuch as it is less high, but it is also much wider in proportion; and from its width results another difference in the upper surface of the cranium, namely, that the sagittal crest, instead of remaining throughout its length linear and narrow, bends much backwards, and even remains rather wide at a point where it is most narrowed by the approximation of the two temporal fossæ. The triangle which these two fossæ leave in front upon the frontal bones is also wider than its surface more convex. The triangle formed by the frontal bones of the nose is wider at its base. For the rest, the composition of the cranium, the connexion of its sutures, its foramina, entirely resemble, as well as the teeth, those of the American species. Cuvier then remarks that the rest of the skeleton of the Tapir species does not offer such appreciable differences. The blade-bone of the Indian species is rather the wider; the notch towards the lower part is smaller and deeper. The anterior hook of the great tuberosity of the humerus is more projecting; the unciform bone of the manus is narrower; the last phalanges of the middle and ring toe are wider and more rounded, and the same may be said of the middle toe of the hind feet; the great trochanter of the femur is larger; the neck of the astragalus is shorter: but all these differences, Cuvier observes, are of so little importance, that, without those of the cranium, they would hardly justify the conclusion of specific distinction. (*Ossæmens Fossiles*.)

Mr. Yarrell, in the 4th vol. of the *Zoological Journal*, gives an account of the post-mortem appearances in an American Tapir brought to this country by Lieut. Maw, R.N., which survived its arrival in the gardens of the Zoological Society in the Regent's Park only a few hours.

When dead, the animal, which was said to be about twelve months old, measured from the nose to the root of the tail 48 inches, and its girth was 35 inches. The incisor teeth $\frac{6}{8}$ were very much used; the edges coming into close contact when the molars are in action. The canines $\frac{-1}{-1}$ were small in the upper jaw, and removed a short distance from the lateral incisor, for the admission of the

upper canines of the lower jaw; the molars were $\frac{4-4}{3-3}$ of those in the lower jaw, the first had three lobes, with five points; the second and third two lobes, with four points. Of the four upper molars, the first had two outer and one inner point; the other three had each two lobes with four points: all the parallel points or tubercles were connected transversely by a slight triangular ridge; and each of these triangular ridges, with their connected tubercles, shut into similarly shaped cavities in the teeth opposed to them, throughout the whole length of their continuous surfaces. The second, third, and fourth upper molars had each a small additional but less elevated tubercle on the external anterior angle, increasing somewhat in size from the second tooth backwards. On cutting away the bones of the palate in order to the complete removal of the brain, Mr. Yarrell found the crown of the molar tooth on each side, posterior to, and somewhat within the line of range of, the last exposed molar tooth had a fifth tubercle of increased magnitude.

The cartilage of the septum narium was thick and strong, and the central ridge of the skull very much elevated. The ligamentum nuchæ was composed of three strong cord-like portions, two of which, passing in a parallel direction from the elongated spinous process of the first vertebra, were inserted together upon the extreme superior posterior angle of the central ridge of the cranium, supporting the whole length of the elevated crest and the third portion of this strong ligament passed between the other two, and was inserted into the more elevated portion of the elongated spinous process of the

anterior portion of the sternum was keel-like and triangular in shape, and projected forwards. There were several ribs on each side and four lumbar vertebrae. The intercostal cartilages were firm: the rings however were incomplete throughout. One large and one small lobe formed the right lung; one large and two small ones the

left: they were inflamed. The pericardium, which was loaded with fat, was of unusual thickness; but the heart presented nothing remarkable: the coats of the arteries were particularly thick and firm.

The œsophagus was narrow: the stomach presented a single cavity, rather small, measuring, when moderately distended with air, 8 inches only from right to left, and 15½ inches in circumference: the parietes were thickened about the pylorus, but the internal surface was not examined, the organ having been preserved entire: it contained a loose mass of tow, hair, string, and shreds of cloth.

The spleen was narrow, thin, and 12 inches long. The liver was divided into four lobes:—two, one large and one small, on the right side; and two, large and equal, on the left; the lower of these last was divided and notched on the edge. There was no gall-bladder. The small intestines, uniform in size throughout their length, measured 21 feet, and were inflamed. The cæcum was capacious compared with the stomach, measuring 14 inches in the line of its long axis, and 24 inches in girth at the largest part, and had two deep and several smaller circular indentations externally, and marked with one strong longitudinal band on each surface; tapering somewhat to a point at its closed extremity, but without any appendix vermiformis. The colon, at two feet from its commencement, doubled suddenly upon itself, and formed a fold 16 inches long, the inner surfaces of which were closely connected. The large intestines measured seven feet in length.

The sexual organs (the animal was a female) presented about the uterus, its cornua, and the ovaria, a degree of vascularity which rendered it probable that the period of life was approaching when breeding would have commenced.

Mr. Yarrell refers to Sir Everard Home's paper in *Phil. Trans.* (1821), in which Sir Everard points out the differences existing in the skulls of the Sumatran and American Tapirs, and has described a part of the viscera of the former. In the Sumatran Tapir the stomach is large, the intestinal canal very long, and the cæcum small; in the American Tapir the stomach is small, the intestines of moderate length, and the cæcum large.

Mr. Yarrell adds, that, of the species described, the length of the Sumatran Tapir is eight feet; and the whole length of its intestinal canal is 89 feet 6 inches. Proportion as 11 to 1.

The length of the American Tapir is four feet; and the whole length of its intestinal canal 28 feet. Proportion, as 7 to 1.

In the *Physiological Series*, preserved in the Museum of the Royal College of Surgeons in London, No. 734, is the anus of an American Tapir, in which, as in the ordinary mammalia, the intestinal canal has a distinct external orifice, situated behind, and not, as in the osseous fishes, in front of the genito-urinary outlet. Professor Owen, the author of the Catalogue, remarks that this example of the mammiferous type of anus is preserved on account of the peculiar jagged appearance and abrupt termination of the common integument at the verge of the anus.

No. 1217 of the same series is a section of the kidney of a Tapir (*Tupir Americanus*), with the arteries injected, and the pelvis laid open to show the terminations of the tubuli uriniferi, as in the horse. No. 1236 is the suprarenal gland of an American Tapir laid open, showing the central dark-coloured substance very distinctly. No. 2778 exhibits part of the vagina, with the urethro-sexual canal, vulva, and clitoris of the American Tapir, in which the clitoris projects within the anterior margin of the vulva: it is a short pyramidal body with two small lateral lobes. The urethro-sexual canal is separated from the vagina by a broad transverse semilunar fold, beneath which is the wide aperture of the urethra. No. 2527 B, is the distal extremity of the penis of the Sumatran Tapir. The upper and lateral parts of the base of the glans present three rounded processes, beyond which the extremity of the glans is continued forwards, and terminates in a large truncate slightly convex surface, in the middle of which is situated the orifice of the urethra.

Generic Character.—Molars presenting on their crown before they are worn, two transverse and rectilinear tubercles (collines). Nose terminated in a small moveable proboscis, but not terminated with an organ of touch like that

Vol. XXIV.—H

of the elephant; neck rather long; skin rather thick, and covered with hair, looking as if it had been close shorn; two inguinal mammae. Anterior feet with four toes; posterior feet with three toes.

Dental formula:—incisors $\frac{6}{6}$; canines $\frac{1-1}{1-1}$; molars $\frac{7-7}{6-6}$
=42.

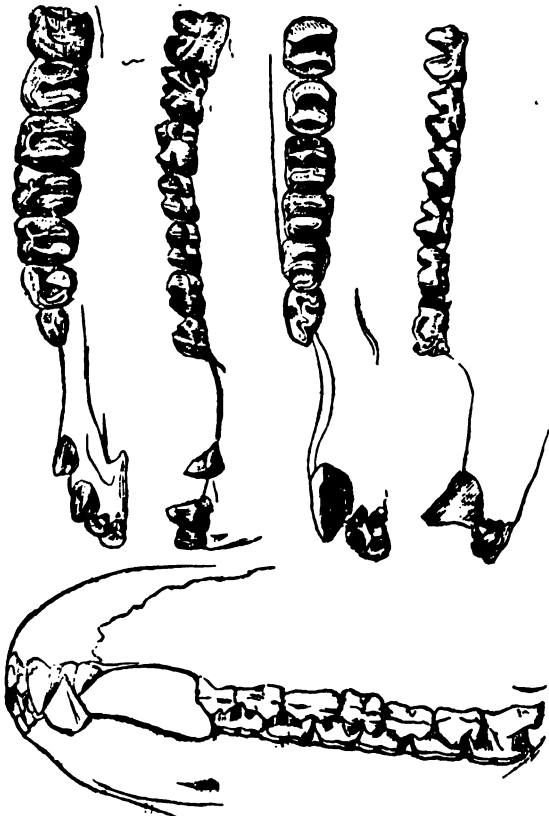

Teeth of Sumatran Tapir.

Geographical Distribution.—Asia and America. M. Lesson observes that it was for a long time believed that this genus was peculiar to America; but that the rich and beautiful discoveries of MM. Diard and Duvaucel have proved that it is also proper to Asia: of which observation more will presently be said.

ASIATIC TAPIR.

Up to the year 1816 it appears to have been thought that the Tapir form was confined to America, and the species known in collections as the American Tapir seems to have been regarded as the only example of the genus. M. Lesson, who so sweepingly claims the discovery of the Asiatic species for French naturalists, is not the only zoologist of that country who puts forth such pretensions. Mr. Bennett has thus corrected those pretensions:—

‘Some vague notices had reached Sir Stamford Raffles of the existence of a similar animal in Sumatra and the Malayan Peninsula; but to Major Farquhar belongs the credit of having first procured a specimen and submitted its description to the world at large. The history of this transaction affords too striking an illustration of the injustice of certain among the French zoologists to the merits of our countrymen to be passed over without observation. “The knowledge of this animal in France,” says M. Desmarest, in his ‘Mammalogie,’ carefully shielding himself under an equivocal form of expression, “is due to M. Diard.” But M. Lesson goes farther; and echoing, as usual, the dicta of his predecessor with a slight addition of his own, speaks of the Indian tapir as a species “discovered by M. Diard.” Again, in the ‘Dictionnaire des Sciences Naturelles,’ M. Desmarest, forgetful of his former caution, heightens the farce still more by asserting that its “discovery in the forests of Sumatra and the Peninsula of Malacca is due to MM. Duvaucel and Diard.” In none of these works is the least indication given that the animal in question had previously been even seen by an English-

man; much less is the fact suffered to transpire before M. Diard had “discovered” it, not in the Sumatra or the Malayan Peninsula, but in the name of the Governor-general of British India at Barrackpore, full description, together with a figure of the animal, of its skull, had been laid before the Asiatic Society by Major Farquhar, for publication in their ‘Revue Zoologique.’ This latter circumstance, it is true, was not mentioned by M. Frederick Cuvier when he figured the tapir of Sumatra in his splendid work, from a drawing made by Major Farquhar in the Barrackpore menagerie, or by that gentleman himself in the published part of his accompanying ‘Revue,’ but there seems to have been no intention on the part of M. Cuvier wilfully to mislead their readers. That M. Diard could not have been actuated by any such desire to appropriate the discovery proved by several passages in the note appended to Major Farquhar’s original description, in which he speaks of the gallant officer as “the excellent officer who has enriched zoology with so important a discovery,” and attributes the “honour” to him “alone.” M. Lesson, too, in the recent edition of his ‘Règne Animal,’ rejects the unmerited distinction in favor of Major Farquhar and friend; and candidly quotes, as the first European, in this instance, more fortunate countryman, “our friend, M. Diard.” This, we trust that we shall hear no more of the claims of the Indian tapir by MM. Diard and Duvaucel, who have too many real claims on the consideration of zoologists to require to be tricked out in the borrowings with which it has hitherto been the custom of our neighbours to invest them.” (*The Gazetteer of the Zoological Society delineated*, vol. i.)

Dr. Horsfield states that the first intelligence of the existence of this interesting animal in Sumatra was communicated to the government of Fort Marlborough at Bencoolen in the year 1772, by Mr. Whalfeldt, who was employed in making a survey of the coast. In the month of August of that year, it is, according to Dr. Horsfield, recorded, that Mr. Whalfeldt laid before the government his observations on the places southward of Bencoolen. He met with the tapir at the mouth of one of the rivers. He considered it to be the hippopotamus, and described it by that name; but the drawing which accompanied his report identifies it, says the Doctor, with the tapir. Dr. Horsfield adds that this mistake in the name may be explained, when it is recollected that in the edition of the ‘Systema Naturæ’ of Linnæus the animal was placed as a species of hippopotamus, while in the subsequent edition no mention is made of that animal.

The learned author of the ‘History of Sumatra,’ William Marsden, Esq., continues Dr. Horsfield, “I was at that time secretary to the government at Bencoolen; and public owes to his zeal in collecting every valuable information relating to that island the first notice of the existence of this animal, which is by the Malays called *Kuda-ayr*, literally hippopotamus. After the first discovery, in 1772, the tapir was not mentioned for a considerable period. From the same source, Sir T. S. Raffles, which has furnished the name, appears that in the year 1805 a living specimen was sent to Sir George Leith, when lieutenant-governor of Sumatra. It was afterwards observed by Major Farquhar in the city of Malacca. A drawing and description of the animal was communicated by him to the Asiatic Society in 1816. A living subject was afterwards sent to the menagerie at Barrackpore from Bencoolen. At this place a drawing was made by M. Diard in the year 1818, which was accompanied by an extract from the description of Major Farquhar, was communicated to his friends in Paris, in March, 1819, M. Fred. Cuvier published it in his lithographic work on the mammalia of the French Republic in Paris.”

‘In the month of September, 1820, the first specimen of the Malayan tapir was received in England by Sir Thomas Stamford Raffles, with the general zoological collection of mammalia and birds, the descriptive catalogue of which, being contained in the 13th vol. of the ‘Transactions of the Linnean Society,’ has been already published. This specimen of tapir was accompanied by a complete skeleton, and the thoracic and abdominal viscera preserved in spirits of wine.’ Dr. Horsfield then notices the use made by Sir Everard Home of the animal in the paper above alluded to.

• Calling him ‘Parkhurst’s answer.’

ing specimen of this species was lately brought to entry, and publicly exhibited in the garden of the Zoological Society of London, where it died more than a year ago.

Description of *Tapirus Malayanus*—*Tapirus Indicus* of some zoologists; *Le Muiba*, F. Cuv., *Mamm.*:—The Tapir resembles in form the American, and has a flexible proboscis, which is six or eight inches in length.

Its general appearance is heavy and massive, somewhat resembling the hog. The eyes are small; the ears are small, and bordered with white. The skin is thick and is generally covered with short hair. There is no mane, as in the American species. The tail is very short and almost destitute of hair. The legs are short and the fore-feet furnished with four-toes, the hind-feet with three. In the upper jaw there are seven molars on each side, one small canine inserted exactly on the suture between the molar and incisor bone, and in front six incisors, the two outer of which are elongated into tusks. In the under jaw there are six molars; the canines are large; and the number of incisors, the outer of which are the smallest, is the same as in the upper jaw. The general colour is glossy black, with the exception of the back, rump, and sides of the head, which are white, and separated by a defined line of black.

This is the description of Sir Stamford Raffles, for the purpose of which we can vouch, having compared it with the living animal in the garden of the Zoological Society. Farquhar describes a young Tapir of this species which he had alive in his house thus:—‘It appears that

until the age of four months it is black, and beautifully marked with spots and stripes of a fawn colour above and white below. After that period it began to change colour, the spots disappeared, and at the age of six months it had become of the usual colour of the adult.’ (See post, American Tapirs.)

Marsden, as we have already seen, notices the animal as the Hippopotamus; *coodo-ayer*. In Sumatra, according to Sir Stamford Raffles, it is known by different names in different parts of the country: thus by the people of Limun it is called *Saladang*; by those of the interior of Manna, *Gindol*; in the interior of Bencoolen, *Babi Alu*; and at Malacca, *Tennu*.

Habits.—The habits of this species in a state of nature are probably similar to those of the American Tapirs. In captivity, Major Farquhar describes it as of a mild and gentle disposition. ‘It became as tame and familiar as a dog; fed indiscriminately on all kinds of vegetables, and was very fond of attending at table to receive bread, cakes, or the like.’ Sir Stamford Raffles adds that the living specimen sent from Bencoolen to Bengal was young, and became very tractable. It was allowed to roam occasionally in the park at Barrackpore, and the man who had charge of it informed Sir Stamford that it frequently entered the ponds, and appeared to walk along the bottom under water, and not to make any attempt to swim. Sir Stamford also states that the flesh is eaten by the natives of Sumatra.

The individual exhibited in the Regent’s Park was very mild and gentle.

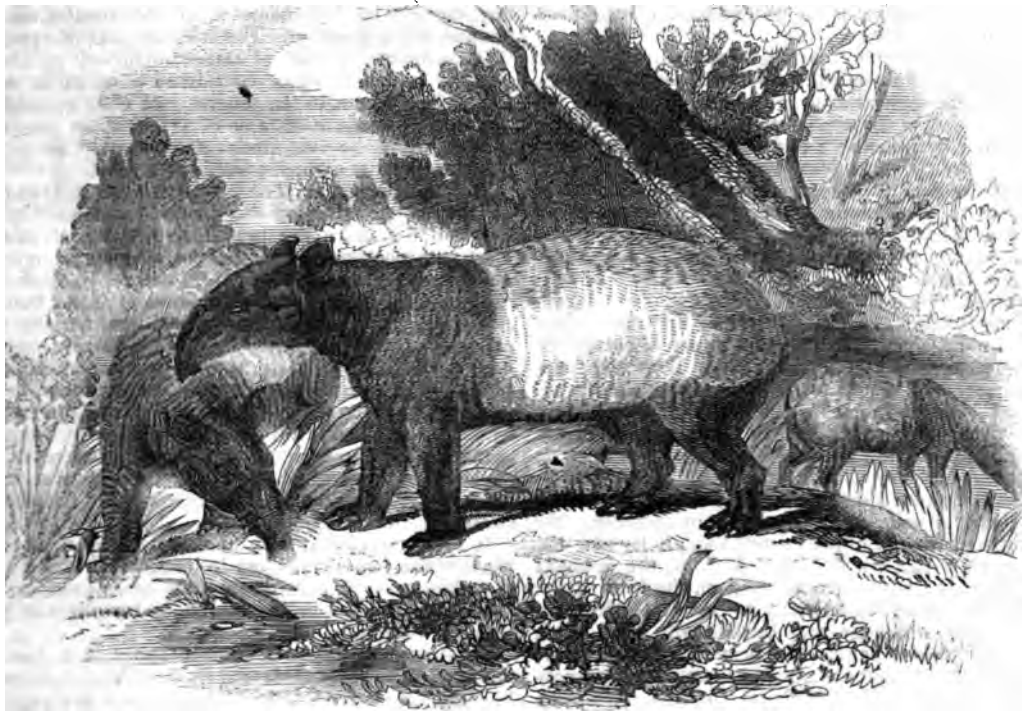

Tapir Malayanus.

AMERICAN TAPIRS.

de Laet (1633), speaking of the province of Vera Cruz, mentions that among the living quadrupeds which are found there, the greatest is that which the barbarians call *Danta*, and the Spaniards *Danta*, an animal not unlike a tapir, with shorter legs and articulated after the manner of the elephant's; the anterior feet have, he states, five hoofs, the posterior only four. The head he describes as oblong, the forehead rather narrow, the eyes small in proportion to the bulk, and the proboscis as being long and pendulous above the mouth. When the animal is angry, he states that it erects itself, and grinning shows its teeth, which are like those of hogs. The ears are small, the neck contracted, the tail short with few hairs, the skin very thick, so that it may scarcely be grasped by the hand or perforated by a spear. It feeds, he says, on grass and sylvan herbage. The

natives, he adds, eat its flesh, and relate that they are taught venesection by this animal, for when it finds itself overloaded with blood, by rubbing against rocks it opens the veins of the legs and lets blood. There can be no doubt that the animal here meant is one of the American Tapirs.

Marcgrave gives a very rude figure, not however to be mistaken for anything but a Tapir, under the name of *Tapiereté*, *Anta* of the Spaniards, describing it and its habits with considerable general accuracy; but Mr. Bennett observes that he speaks of the teeth as consisting of ten incisors and ten molars in each jaw, an error which Mr. Bennett remarks held its ground for nearly two centuries, and having passed successively through the writings of Ray, Brisson, Buffon, Gmelin, and Blumenbach, was first corrected by Geoffroy St. Hilaire.

Towards the close of last century the fabulous clouds

that had gathered about the history of this animal began to clear away before the lights of observation. Buffon had noticed the only American Tapir then known, as the largest animal of the New World; but this can hardly be said of it when the Elk and the Wapiti are remembered. Geoffroy St. Hilaire and Baron Cuvier first accurately defined its zoological characters; and Sonnini and D'Azara gave a correct account of its habits. Buffon's figure, after a drawing by La Condamine, was the first at all approaching to accuracy. A living individual was afterwards brought to France, but died before its arrival at Paris, and furnished a still better design, published with further information, derived chiefly from Sonnini, and M. Bajan's memoir on the anatomy of the species, in the Supplement to Buffon, vol. vi. : but still some of the errors were retained; nor was the account of two other individuals living in the menagerie belonging to the Prince of Orange, by Allamand, complete.

Lieut. Maw, in his *Journal of a Passage from the Pacific to the Atlantic* (1829), speaks of the Tapir as common in the woods and rivers about Eguas, there called *Anta*, and which is the same animal with the *Sachywaka*, *Dante*, or *Gran Bestia* of Peru, of which they had heard much both before and since embarking. Two kinds were described to them, one having the tips of its ears white, and which is the largest; when young it was stated to be striped and spotted like a deer, the spots disappearing as it grows older, till it becomes entirely of a dusky bay colour. Here we have a clear intimation of the knowledge of two species by those inhabiting the spot.

The form of the species best known has since been rendered familiar to Englishmen by the exhibition of living specimens in the gardens of the Zoological Society of London in the Regent's Park.

But this is not the only American Tapir; for M. Roulin, about thirteen years since, laid before the French Academy a description and figures of a new species inhabiting the mountainous parts of the same districts, the plains of which are frequented by the other; and his account is given in the *Annales des Sciences Naturelles*: from this it would appear that the American Tapir of the mountains is more nearly allied to the Asiatic species than the American Tapir of the plains.

We take as our example the species first known, *Tapir Americanus*, Gmel.

Description. General colour throughout deep brown approaching to black. Sides of the lower lip, band on the under and middle part of the chin, upper edges of the ears, and naked line at the junction of the hoofs pure white. Scanty hair of the body very short, closely adpressed to the surface; hardly distinguishable at a short distance. The skin beneath it is of great density, being, according to M. Roulin, not less than seven lines thick on the back, and eight or nine lines on the cheek, and so tough that Sonnini frequently shot at a female which was crossing the river with her young, without disturbing her or making her turn out of her course, though he saw the impression of a ball which he had fired on the animal's cheek. There is a thick rounded crest on the back of the neck, extending from the forehead as low as the level of the eyes to the shoulders, and bristled with a not thick mane of stiff blackish hairs. Mr. Bennett remarks that it is peculiar to the present species, but is not found, according to M. Roulin, in the female at Cayenne: although D'Azara states that the female is equally furnished with it in Paraguay. In the female brought by Lieut. Maw from Para, and formerly in the menagerie of the Zoological Society of London, it was very conspicuous. Head very long; muzzle prolonged and covered above with hair of the same colour as that of the body, but naked and flesh-coloured at its extremity (which is flattened) and underneath. Eyes very small, of a dull lead colour.

The colour of the individual dissected by Mr. Yarrell was rusty reddish-brown, with indications of lighter spots and horizontal lines on the ribs, flanks, and thighs. 'These fawn-coloured spots and stripes,' says Mr. Yarrell, 'are common to both species of Tapir' (the Sumatran and the American species then known are meant) 'while young; that of Sumatra not exhibiting till it is six months old any appearance of the well-defined black and white colour which afterwards distinguishes the adult animal.' (*Zool. Journ.*, vol. iv.)

Mr. Bennett, too, remarks that the young is of a much

lighter brown than the adult, with numerous small white spots on the cheeks, a whitish muzzle, and six or eight complete narrow bands of white passing along each side of the body from the shoulders to the haunches. 'Regular rows,' says Mr. Bennett, in continuation, 'of small white spots, placed at equal distances from each other, alternate with these bands. The upper parts of the limbs are marked in a similar manner; their inner sides, as well as the under surface of the body, are white; and their extremities of the ground-colour of the whole body, with a few fainter spots scattered over them. Before the end of the first year of their age this livery becomes completely lost: it is partially visible in the young specimen in the Society's museum, but not at all in the living individuals at the Gardens (1830). Similar markings occur in the young of the Sumatran species, and also, we may observe, in that of the Hog in its native state. The adult female of the present species has generally a considerable number of whitish hairs intermingled with the brown, which gives her somewhat of a grizzled appearance.' (*Gardens and Menagerie of the Zoological Society delineated.*)

Locality. South America. 'Few animals of equal size,' says the author last quoted, 'have so extensive a range as the American Tapir. It is found in every part of South America to the east of the Andes, from the Straits of Magellan* to the Isthmus of Darien; but appears to be most common within the tropics. M. Roulin dwells upon it as a singular fact that although it occurs as far as 40° south of the equator, it ceases suddenly at about 8° north, in a situation where it is extremely abundant, and where no adequate cause has yet been assigned to bar its further progress, no large rivers nor lofty mountains intervening, nor any change in the character of the vegetation of the country being manifest. The left bank of the *Atrato* near its mouth, and the part of Darien inhabited by the independent Indians, may be considered as its northern limit. Its highest range, in the province of *Maraquita* at least, appears to be from 3000 to 3600 feet above the level of the sea, while the new species discovered by M. Roulin is only met with at a much greater elevation.'

Habits, Chace, &c. The inmost recesses of deep forests are the chosen haunts of this species, which is not gregarious, and flies from the proximity of man. It is for the most part nocturnal in its habits, sleeping or remaining quiet during the day, and at night seeking its food, which in its natural state, consists of shoots of trees, buds, wild fruits, &c. If we are to believe D'Azara, and he was an accurate observer, it is very fond of the barrero, or nitrous earth of Paraguay. It is however a most indiscriminate swallower of everything filthy or clean, nutritious or otherwise, as the farrago found in the stomach of the individual dissected by Mr. Yarrell showed. Pieces of wood, clay, pebbles, and bones are not unfrequently taken out of the stomachs of those which are killed in the woods: and one kept by D'Azara gnawed a silver snuff-box to pieces and swallowed the contents.

It is a powerful animal, and everything in the under-wood of the forest gives way to its rush. It is in the habit of making runs or roads through the brushwood, and these beaten tracks are usually selected by travellers in passing through the forests.

Quiet and peaceable in its demeanour, it is hunted for the sake of its tough hide and its flesh, which, though not liked by the European (for it is coarse and dry), is relished by the unsophisticated palate of the Indian.

The lasso is not often employed in its capture, not only from its haunts being generally unfavourable to that mode of hunting, but because its determined rush and strength will at a single effort snap the line which is strong enough to arrest the career of a bull. The hunters will sometimes lie in wait with their dogs near a Tapir's road as evening approaches, and so get between him and the water to which he usually directs his course for the purpose of bathing and wallowing at the commencement of his nocturnal career. He makes a good fight and inflicts severe wounds upon the dogs with his teeth, especially if he can reach the water, where he stands at bay, breast deep and defies the fiercest of them; for as they are compelled to swim to the attack, the Tapir bides his time, and seizing them by the lacks of their necks as they successively come within his reach, shakes them off, not without biting a piece out.

* Apparently not at present.

it would seem that the most common method of g them is by imitating their sharp but not very histle, and thus bringing them within shot of the poisoned arrow.

Maw, who, as we have above seen, brought a animal of this species to England, speaks of it as upon herbs and the branches of trees, and going nto the water, walking along or rather perhaps he bottoms of rivers. 'It possesses,' says Lieut. great strength, particularly in the fore part of the but is harmless, except when attacked. It is said directly through the thickets without following vious track.* We were told that when the Tapir ed by a Tiger' (*Felis Onça*) [LEOPARD, vol. xiii., p. he Tiger generally springs upon the Tapir's back, e latter rushes into the woods and endeavours to assailant by dashing him against some large tree. h strongly and apparently heavily made, the Tapir o be fleet.' (*Journal of a Passage, &c.*)

species is mild in captivity and easily domesticated. states that several tame Tapirs are permitted to go ty through the streets of Cayenne, and to wander woods, whence they return in the evening to the here they are kept and fed. He adds that they are of attachment to their owner, and expresses his that care and attention might convert its qualities h, docility, and patience to account as a beast of

American Tapir.

FOSSIL TAPIRS.

Buckland, in his *Reliquiæ Diluvianæ*, notices the of Tapir in company with those of rhinoceros, t, horse, ox, deer, hyæna, bear, tiger, fox, wolf, n, hog, and beaver, in the Val d'Arno, on the y of Mr. Pentland; and in his interesting and in- first plate illustrative of his *Bridgewater Treatise* : Tapir in little among the mammalia of the first of the Tertiary series (Eocene of Lyell). In the 1 sand (Miocene of Lyell), Professor Kaup o species larger than those now living. uld be borne in mind that the second or Miocene of tertiary deposits contains a mixture of the ex- ra of lacustrine mammalia of the first or Eocene uth the earliest forms of existing genera. M. rs first noticed this in the Faluns of Touraine, he remains of *Palæotherium*, *Anthracootherium*, *hiodon* were found mixed with the bones of the mastodon, rhinoceros, hippopotamus, and horse. mains were fractured and rolled, and sometimes with flustra, and must, Dr. Buckland observes, en derived from carcasses drifted into an æstuary

Meyer records the following species: *Tapir sis*, Croiz. and Job., from the diluvium, Puy-de- ussac; *Tapir Mastodontoides*, Harlan, from Ken- rith a justifiable query, whether it is a Tapir at d *Tapir Priscus*, Kaup, from the Epplesheim sand. alludes to other remains noticed in the works of Clift, and Eichwald. (Diluvium, Irawadi.) nd, in his 'View of the Fauna of Brazil,' states that n vain looked for either remains or foot-prints of g Tapir; whence he concludes, that it does not e in caves: but he says that he is in possession l bones which evidently belong to the genus,

* above.

Dr. Owen believes this so-called Tapir to be the young of *Mastodon*

though they are too imperfect to determine their relation to the recent animal.

TAPPING, or Paracentésis (in Surgery), is the operation usually employed for the removal of fluid from any of the serous cavities of the body in which it has collected in a dangerous quantity. It is accomplished by means of an instrument called a trocar, and a tube, or canula, in which it exactly fits. The trocar is of steel, cylindrical through the chief part of its length, and terminated by a three-sided pyramid which ends in a very sharp point. The canula being placed upon its shaft, the trocar is thrust into the cavity containing the fluid, and being then withdrawn through the canula, the latter is retained in the aperture till all the fluid is discharged. The diseases for which tapping is chiefly performed are ascites, hydrothorax, hydrocele, and, occasionally, hydrocephalus, and effusions of fluid in the pericardium.

TAPTU. [HINDUSTAN, p. 211.]

TAPUH. [SOOLOO ARCHIPELAGO.]

TAR, a well-known empyreumatic product.

The properties of tar are, that it is a viscid brown semi-fluid mass, which long preserves its softness. If it be mixed with water, it acquires a yellow colour and the taste of tar, with slightly acid properties; this solution is well known by the name of tar-water, and has been used in medicine. Tar is soluble in alcohol, in æther, and in the fixed and volatile oils.

If tar be distilled with water, there passes over a brown liquid which consists of much empyreumatic oil and some oil of turpentine; this product is called oil of tar; by redistillation with water it becomes colourless; the substance remaining in the still is pitch; so that, in fact, tar is a mixture of oil and pitch.

Within a few years, tar has been subjected to a minute examination by Reichenbach, who has obtained from it a variety of substances possessing very different properties; the most important of these is creasote. [CREASOTE.]

After what has been stated of the many different compound substances of which tar is constituted, no exact analysis could of course be stated; its chief constituent is carbon, combined with hydrogen and oxygen, and a small portion of azote.

TAR (French, *Goudron*; German, *Theer*; Italian, *Catrame*; Spanish, *Alquitran*; Polish, *Smola Gesta*; Russian, *Degot*, *Smola shitkaja*; Swedish, *Tjära*), is obtained from wood or coal by distillation in close vessels, or in piles from which the air is excluded. Pitch (French, *Poix*; German, *Pech*; Italian, *Pece*; Spanish, *Pez*; Russian, *Smola gustaja*) is commonly obtained by the inspissation of tar, or by boiling it until all the volatile matters are driven off. For the chemical properties of tar, see the preceding article.

Tar is extensively manufactured from the roots and branches of pines and firs in Norway, Sweden, Germany, Russia, North America, and other countries in which those trees abound; but that made in the north of Europe is considered far superior to what is produced in the United States. The process usually followed is described in Dr. E. D. Clarke's 'Travels in Scandinavia,' and is, he states, similar to that which, according to Theophrastus and Dioscorides, was practised by the antient Greeks. He observes indeed that 'there is not the smallest difference between a tar-work in the forests of Westro-Bothnia and those of antient Greece.' After describing the noble forests which cover the soil down even to the water's edge, about the inlets of the Gulf of Bothnia, Dr. Clarke says, 'From the most southern parts of Westro-Bothnia to the northern extremity of the Gulf, the inhabitants are occupied in the manufacture of tar, proofs of which are visible in the whole extent of the coast. . . . The situation most favourable to the process is in a forest near to a marsh or bog; because the roots of the fir, from which tar is principally extracted, are always most productive in such places. A conical cavity is then made in the ground (generally in the side of a bank or sloping hill), and the roots of the fir, together with logs and billets of the same, being neatly trussed in a stack of the same conical shape, are let into this cavity. The whole is then covered with turf, to prevent the volatile parts from being dissipated, which, by means of a heavy wooden mallet, and a wooden stamper worked separately by two men, is beaten down and rendered as firm as possible above the wood. The stack of billets is then kindled, and a slow combustion of the fir takes place,

without flame, as in making charcoal. During this combustion the tar exudes; and a cast-iron pan being at the bottom of the funnel, with a spout which projects through the side of the bank, barrels are placed beneath this spout to collect the fluid as it comes away. As fast as the barrels are filled, they are bunged and made ready for exportation.' 'From this description,' he adds, 'it will be evident that the mode of obtaining tar is by a kind of distillation *per descensum*; the turpentine, melted by the fire, mixing with the sap and juices of the fir, while the wood itself, becoming charred, is converted into charcoal.' The process of tar-making in Sweden, north of the Bothnian Gulf, has been more recently described in Laing's 'Tour in Sweden,' in which work it is stated that fir-trees which are stunted in growth, or from their situation unsuitable for the saw-mill, are prepared for this purpose by peeling off the bark to the height of one or two fathoms up the stem. This is done by degrees, so that the tree may not decay and dry up at once, but may remain for five or six years in a vegetative state,—alive, but not growing. The sap, thus checked in its circulation, makes the wood richer in tar, so that, when cut down, the tree is almost entirely converted into the substance from which tar is distilled. The roots, rotten stubs, and scorched trunks of trees felled in clearing land, are all applied to the purpose of producing tar. It is stated, in the last-mentioned work, that the state of the weather during the process of burning or distilling greatly affects the amount of produce. The labour required to convey the tar from the forests to the rivers is often very great; and not unfrequently the barrels are committed to the stream in order to pass rapids or falls.

In some parts of France and Switzerland tar is extracted in a kind of oven or kiln, built of stone or brick, in the form of an egg, with its smaller end downwards. These kilns are sometimes as much as ten feet deep and six feet in diameter; and they are provided with a gun-barrel or tube at the lower end to conduct the tar, as it is made, to vessels placed to receive it. The wood is cut into billets, and freed from its bark; and the kiln is filled with bundles of billets, chips being inserted to fill up the interstices. A layer of chips is also placed at the top of the kiln, which, when charged, is covered over with flat stones, so arranged as to form a kind of vaulted chimney. Fire is applied to the dry chips at the top, through an opening left in the centre, and, as soon as the pile is fairly lighted, the chimney is closed in with a large stone, and wet earth is heaped upon the top of the kiln until the escape of smoke is effectually prevented. It is however necessary occasionally to refresh the fire by the admission of a little air through holes in the sides of the kiln. The average product of tar is stated to be from ten to twelve per cent. of the weight of the charge; but the red wood and the knots furnish about one-fourth of their weight of tar. By this plan the wood is charred more equally, and the tar is of superior quality. A considerable quantity of lamp-black collects upon the stones which form the roof and chimney of the kiln, and this is removed after each operation. Probably a still better plan would be to distil the wood in close retorts, similar to those used in the manufacture of coal-gas; but any such apparatus is unsuitable for the wild forest districts in which tar is principally made.

The great importance of tar and pitch as naval stores enabled the Tar Company of Sweden, in 1703, to put England to considerable inconvenience, by refusing to supply those articles excepting at their own price, in such quantities as they might choose, and in Swedish shipping. This circumstance induced parliament to offer bounties for the importation of these and other naval stores from the British colonies in North America, a measure which produced highly beneficial results. It was computed at that period that the annual consumption of foreign tar and pitch in Great Britain and Ireland was about 1000 lasts, and that of other European countries about 5000 lasts, of which four-fifths was tar; and it was stated that besides Sweden, which afforded the chief supply, considerable quantities were made in Norway and in Russia. Probably this estimate was much too small; for Anderson states that in 1730 the quantity of tar annually shipped from Archangel in Russia was computed to be 40,000 lasts. The American war of independence, by interrupting the trade between England and North America, revived the former difficulty respecting the supply of tar, and led to

the establishment of the manufacture of tar from pit-coal; an object which had been previously attempted. Becher, a foreign chemist, who lived about the time of Charles II., is supposed to have been the first to propose the making of coal-tar; and it was made for many years in the bishopric of Liege, and in other parts of Germany; the coal being distilled in a kind of still formed of cast-iron. No. 228 of the 'Philosophical Transactions' (vol. xix., p. 544, which was published in May, 1697, contains an 'Account of the making (of) pitch, tar, and oil out of a blackish stone in Shropshire, communicated by Mr. Martin Ele, the inventor of it.' The mineral used is described as a blackish porous rock, lying over the strata of coal, in Broseley, Bentley, Pitchford, &c.; and the bituminous part was separated by breaking the rock to powder, and boiling it with water. About the year 1779, in consequence, as before stated, of the American war, some lamp-black manufacturers at Bristol turned their attention to the manufacture of tar from pit-coal; and in 1781, Lord Dundonald, a nobleman distinguished for his scientific pursuits, obtained a patent for improvements upon the process previously followed. Mr. Pitt, of Pendeford, near Wolverhampton, in a letter addressed to the Society of Arts, in 1790, on the subject of converting the smoke of steam-engine furnaces into tar, alludes to three establishments at Bradley, Tipton, and Dudley Wood, erected by Lord Dundonald and the gentlemen associated with him; and states that the business was then carried on with success. 'These tar-works,' says Mr. Pitt, 'are erected in the vicinity of large iron and coal works: the iron-masters furnish the tar-works with raw coal *gratis*, and receive in return the cokes produced by such coal; and the proprietors of the tar-works have the smoke only for their labour and interest of capital. (*Transactions of the Society of Arts*, vol. ix., p. 132.) The process adopted at these works is fully detailed by Mr. Pitt. The manufacture of coal-tar has not proved so important as was at one time anticipated, although for some purposes it is deemed superior to that made from wood. The author of the article 'Navy,' in the *Supplement to the Encyclopædia Britannica*, considers tar from sea-coal to be an important resource in case of England being compelled to revert to her own resources for naval stores; and observes that for painting or tarring wood-work of every kind, it is said to stand exposure to the weather better than the common tar. He also refers to the pitch-lake of Trinidad [TRINIDAD] as a source whence an almost inexhaustible supply of mineral pitch and tar might be obtained. Tar is produced in large quantities in the manufacture of coal-gas; but in some districts its value is considered so trifling that it is mixed with the fuel by which the retorts are heated. It is usually separated from the gas by condensation; but the introduction of a quantity of brushwood into the condenser, so as to form a mechanical interruption to the passage of the gas, is found greatly to assist the operation.

The import duty upon tar has been for some years past 12s. per last,* if from British possessions, and 15s. if from foreign countries; but under the new tariff of Sir Robert Peel (1842), it is respectively 6*l.* and 2s. 6*l.* per last. The quantity imported in the five years from 1835 to 1839, was 60,622 lasts, or about 12,124 lasts per annum; of which 58,106 lasts, or 11,621 lasts annually, were entered for home consumption. During this period the duty amounted to 44,023*l.*, or upon an average 8804*l.* per annum. Of the above quantity Russia furnished about 50,155 lasts; the United States, 6446 lasts; Sweden, 2297 lasts; Denmark, 1300 lasts; and Norway, 348 lasts: the remainder being made up of small quantities from Germany, Prussia, &c.

Pitch is extensively manufactured in Great Britain, yet the quantity imported in 1829 is stated, by McCulloch, to have been about 10,752 cwt. The duty is 10*l.* per cwt., if from foreign countries, and 9*l.* if from British possessions; or, under the new tariff, 6*l.* and 1*l.* per cwt. respectively.

* Dr. E. D. Clarke's *Travels in Scandinavia*, sec. i., pp. 251, 252; Laing's *Tour in Sweden* in 1834, p. 176; Macpherson's *Annals of Commerce*; McCulloch's *Dictionary of Commerce*.

TARA. [SIBERIA.]

TARABLOUS. [SYRIA.]

TARAI. [HINDUSTAN, p. 217.]

* A last is twelve barrels, and each barrel is, by the Custom-House regulations, to contain not more than thirty-one gallons and a half.

TARAKAI is the name of a large island, which has figured on our maps under the name of Saghalien or Ughalian, and has at different times been supposed to be called Tchoka, Karaito, and Sandan. This island extends from south of 46° to $54^{\circ} 20'$ N. lat., more than 600 miles in length, but the width is various. Towards the southern extremity, north of the Bay of Aniva, it is nearly 100 miles wide, but it soon contracts to about 25 miles, which is about its average width as far north as the Bay of Patience, where it suddenly expands to 120 miles, Cape Patience forming far out into the Pacific. From this point (49° N. lat.) northward the island again grows narrower, but very gradually, so that at 51° N. lat. it is still nearly 80 miles wide. Farther north its average width does not exceed 40 miles. The area of the island probably exceeds 30,000 square miles, which is not much more than that of Scotland, if we include the islands.

Tarakai extends along the eastern coast of Asia between 2° and 145° E. long., and is separated from the continent by a strait, which is called the Gulf of Tartary, because a country of the Mantchoos for a long time was known by the name of Tartary. This gulf or strait is 200 miles wide at its most southern extremity, but it grows narrower as we advance farther north, until near $51^{\circ} 30'$ N. lat. it is less than 40 miles wide. So far this sea has been navigated, but at that point a shoal extends across the gulf on which there is only water for boats. That portion of the gulf which lies between $51^{\circ} 30'$ and $52^{\circ} 30'$ N. lat. is not known. Krusenstern thinks that this part of the coast of Tarakai is united to the continent of Asia by an isthmus, but La Perouse expressly states that dried fish is carried from the western shores of the island to the river Amur in boats, which could not be done if the isthmus of Krusenstern existed. It may appear strange that these two navigators have not been able to decide this point, as one led up from the south to $51^{\circ} 30'$, and the other from the north to nearly 53° N. lat., but they found the sea always covered with thick fogs, and hardly ever could see a few miles before them, and the water shoaled so suddenly and constantly that they did not think it advisable to proceed farther. If an isthmus exists, it must be near $52^{\circ} 30'$ N. lat., where a low sandy cape certainly stretches so far to the east as to approach very near the western shores of the island. North of this narrow and shallow part, the gulf presents a circular basin, about 50 miles wide, which receives the waters of the river Amur, and is therefore called by Krusenstern the Liman of the Amur. This basin is connected with the sea of Okhotsk by a strait, which in the narrowest part is about ten miles wide. It does not appear that there is any current in this gulf, which is in favour of the opinion of Krusenstern. The southern extremity of Tarakai is divided from the island of Yeso by the Strait of La Perouse, which, between Cape Crillon on Tarakai and between Cape Soja on Yeso, is hardly thirty miles wide, and in which the tides run with great velocity. La Perouse, who visited the Gulf of Tartary in June, found the southern winds were blowing nearly uninterruptedly; Broughton, who was there in September, experienced the same from the north and north-eastern winds.

Although the coast of the island is of great extent and much indented, it does not appear that there are many good harbours. Along the western shores only open roads have been found. At the southern extremity of the island, between Cape Crillon and Cape Aniva, is an open bay, the Bay of Aniva, which is enclosed by two long tongues of land, and extends 50 miles from south to north. There is good anchorage at its most southern extremity. The projecting headland, which runs near 49° N. lat., on the eastern side of Tarakai, and terminates with Cape Patience, encloses the Bay of Patience, which is very extensive, but open and exposed to the northern and southern winds. At the most northern extremity of the island is the Northern Bay, between the headland of that name and Cape Mary. It is not very large, but in several places good anchorage and shelter. The island is naturally divided into three tracts: the mountainous, which occupies the southern portion; the level, in the middle; and the hilly tract, which extends over the northern districts. The mountain-region is the highest, and comprehends more than one-half of the island, terminating on the north at Cape Délisle de la Croÿère (near 51° N. lat.). A chain of mountains begins at Cape Crillon, and continues in an uninterrupted line northward

to an elevated summit called Peak Bernizel, where it seems to be united to another and lower chain, which traverses the eastern peninsula, and incloses the Bay of Aniva on the east. Cape Aniva is formed by a high isolated hill, which is connected by a low isthmus with the chain of hills which lies farther north, and joins the principal range at Peak Bernizel. Farther north occur other summits, as Peak Lamanon, Peak Mongez, and Mount Tiara: the two last mentioned are north of 50° N. lat. None of these summits have been measured, but their elevation probably does not exceed 5000 feet above the sea-level. Along the western coast the mountains in some places come close up to the water's edge, but a narrow level tract generally separates them from the shore, and this tract is covered with high trees, while the delivities of the mountains are mostly bare, probably owing to the rapidity of their slope. Extensive flats occur at Aniva Bay and the Bay of Patience. The low country which skirts the shore on the eastern side of the mountains appears to be more extensive and less interrupted than that along the western shores. On the eastern side the shore in some places is level and low, and in others elevated. The country extending from 51° to 53° N. lat. is so low that the shores are not visible at the distance of five or six miles, and it is sandy and overgrown with bushes. The interior is in general level, partly sandy and partly swampy, and a great part of it is covered with short bushes or small trees. A number of low sand-hills are dispersed over the country, which are destitute of trees, and appear like islands in a sea of verdure. The hilly tract occupies the most northern part of the island, or that which extends from 53° N. lat. to Cape Elizabeth. The coast is in general high and steep, being generally composed of perpendicular white cliffs. There are only a few tracts in which the coast sinks down to the level of the sea; and here the villages are built. The interior consists of a succession of high hills covered with full-grown trees to the very summits; the valleys which intervene between them are partly wooded and partly covered with a fine close turf. This part of Tarakai seems to possess a considerable degree of fertility.

Climate.—As European navigators have only occasionally visited this island, and have only stayed there a few days, or at the utmost a couple of weeks, our information respecting the climate is extremely deficient. We only know that even at the beginning of June the higher summits of the mountains have still some snow on them, which indicates that the country must be much colder than Great Britain, which is nearly at the same distance from the pole: otherwise the summer months seem to be temperate, but the continual fogs which enclose the island nearly all the year round are more dense than those that occur on the coasts of Nova Scotia.

Productions.—No kind of grain is cultivated, not even round the settlements of the Japanese, nor are orchards or kitchen-gardens mentioned. The inhabitants however derive profit from the spontaneous products of the soil: they dry the roots of a species of lily for winter food, and collect great quantities of garlic and angelica, which are found on the skirts of the woods. The forests consist of oak, maple, birch, and medlar, but chiefly of fir. Large tracts are covered with juniper-trees. Gooseberries, raspberries, and strawberries abound, and also wild celery and water-cresses. It does not appear that wild animals are numerous: only martens and bears are mentioned, and even these do not seem to be common. The sea supplies the inhabitants with the means of subsistence. Salmon is perhaps nowhere so abundant as in the Gulf of Tartary. The account of La Perouse in this respect seems hardly credible. Dried and smoked salmon, together with the skins of salmon, are prepared for the foreign market, and constitute the principal articles of export. Herrings, which are very abundant, are likewise cured and exported. Cod occurs, but it does not seem to be taken to such an amount as to form an article of export. Whales are numerous in the Strait of La Perouse and along the eastern coast, and train-oil in bladders is an article of export. In the same parts seals, fur-seals (*Phoca ursina*), sea-lions (*Phoca jubata*), and sea-otters (*Lutra marina*) are very frequent. No mines are worked.

The inhabitants are aborigines, among whom a few Japanese have settled on the Bay of Aniva, and a few Mantchoos on the Northern Bay. In the Japanese settlements are a few Japanese officers, but no Chinese authorities have been

seen, nor is this island enumerated among the possessions of the Chinese. The aborigines call themselves *Ainos* (i.e. men), and are at present known under that name as a nation. This nation extends northward to the peninsula of Kamtchatka, of which it occupies the most southern extremity near Cape Lopatka, and it inhabits the Kurile Islands, the Japanese island of Yeso, Tarakai, and the coast of the continent of Asia from the mouth of the Amur river southward to the very boundary-line of Corea. They never cultivate the soil, nor apply themselves to hunting wild animals, and they keep no domestic animals except dogs, which they use in winter for drawing their sledges, like the inhabitants of Kamtchatka. La Perouse found them somewhat shorter in stature than Europeans, rarely exceeding five feet six inches, and some hardly five feet. Their countenances are benevolent and friendly; they have tolerably large eyes, thick lips, rather high cheek-bones, and a somewhat broad and compressed nose. Their cheeks and chins are covered with long, thick, black beards: there are many individuals whose body is covered with hair, as occasionally is the case in Europe. The only kind of manufacture among them is a kind of cloth made of the bark of willow-trees, which are very common in the island, and do not seem to differ from the European species. They use in this manufacture a machine. The other articles of cloth they obtain by barter from the Japanese and Mantchoos. They show also some skill in the erection of their huts and the building of their boats. Their huts are of wood, covered with the white bark of birch, and have a roof of wood thatched with dry straw. La Perouse compares them with the cottages of the peasants of France. Their boats are of large size and strongly built. Some of their costumes are evidently adopted from the Chinese, as the practice of letting their nails grow to a considerable length, and their mode of saluting by prostration. Like them, they sit on mats, and eat with little sticks. Their language does not resemble either that of the Japanese, Chinese, or Mantchoos. The Mantchoos visit the northern and western coast to barter dried and smoked salmon, and dried herrings, for some nankeens, tobacco, and utensils. The Japanese visit the southern and eastern districts, where they obtain train-oil, herrings and salmon, and a few furs, and give in return lacquered wooden eating and drinking vessels, tobacco and tobacco-pipes, kitchen utensils, rice, coarse cotton-cloth, and some minor articles.

(La Pérouse's *Voyage round the World*; Broughton's *Voyage of Discovery in the Northern Part of the Pacific*; Krusenstern, *Voyage round the World*; and Krusenstern's *Recueil de Mémoires explicatifs, &c.*: Langsdorf's *Voyages and Travels in various Parts of the World*.)

TARANTASIA, or TARANTAISE. [SAVOY.]

TARANTISMUS is the name given to a peculiar nervous affection which was long supposed to be the consequence of the bite of the Tarantula Spider. It seems to have occurred frequently in the kingdom of Naples during the sixteenth century, and to have been nearly similar in its characters to the disease which was originally called St. Vitus's dance [CHOREA], and to that which has occasionally prevailed in parts of Scotland, and has been called the 'leaping ague.'

The patients, nearly all of whom were women, soon after being bitten (as it was supposed) used to fall into a profound stupor, from which nothing roused them but the sound of such music as pleased them, on hearing which they had an irresistible desire to dance. So long as the music continued, and was in tune and sufficiently lively, they would go on jumping and dancing till they fell exhausted; and, all the time, some used to shriek, some to laugh and sing, some to weep. When, after a short rest, they had recovered from their fatigue, they would again begin to dance with as much vigour as before, unless the music were played slowly or confusedly, when they would stop and grow anxious and melancholy, or even, if the music were not soon made agreeable to them, would fall into a dangerous state of stupor. The disease used to last about four days, and seemed to be cured by the profuse perspirations brought on by the active exercise; but it often returned at the same time in the following year, or even for a succession of years, and on every occasion required the same treatment.

Since it has been found that the bite of the Tarantula can produce no such strange effects as these, many have suspected that the disease ascribed to it never really

existed, but was feigned for the purpose of exciting or for the pleasure of dancing. There is good reason to believe that in most instances it was merely counterfeited, but there can be no doubt that such a disease had actually existed, and had given occasion to the practice of it. Besides its similarity to diseases whose reality is admitted, such as the St. Vitus's dance and the leaping ague, cases have occasionally been met with at times which closely resemble it, and in which there is but a just suspicion of fraud. Such a case is recorded by Mr. K. Wood, in the seventh volume of the *Chirurgical Transactions*; another is recorded by Crichton, in the 31st volume of the *Edinburgh and Surgical Journal*; and in the *Cyclopædia of Medical and Surgical Medicine*, art. 'Chorea,' several cases of a kind of chorea are related. All these however occur in the Tarantismus and the St. Vitus's dance, and have assumed the characters of epidemics, and are apt to propagate themselves, as all convulsive diseases are apt to do among nervous and superstitious people, by the propensity to imitation, the effects of which are frequently seen in the production of hysteria, and other similar diseases.

TARANTO, a town of Apulia, in the kingdom of Naples, in the administrative province of Lecce. It is an archbishop's see, and the head of a district: it contains 18,000 inhabitants. It occupies only a small part of the site of the ancient Taranto, being confined to the island or peninsula at the end of the inner harbour or Mare piccolo, on which stood the fortress or acropolis of Tarentum. There are few remains of the ancient town. Modern Taranto is built: it is fortified and has a castle, several churches, and convents. It carries on some trade by sea in silk and wool. It has also some manufactures of linen and of silk, the name of a kind of mussel or shell-silk, the filaments of which are woven into gloves and articles. A part of the population is employed in the culture of oysters, which are found in excellent quantities on the coast. The inner harbour is nearly filled up, but the outer or large port is a fine bay, and is protected by two forts which are situated at the mouth. Taranto has the reputation of being the only safe harbour in that part of the eastern coast of Italy which extends from Messina to Leucas. The large gulf which lies between the Calabria and the Iapygian peninsula is called the Gulf of Taranto. Much wool is grown in the neighbourhood of Taranto. Two lagoons, one of them of considerable extent, which lie south-east of the town, and which communicate with the sea, yield a great quantity of salt by evaporation. The district of Taranto contains above 87,000 inhabitants. [OTRANTO, TERRA DI.] (Neigebaur; Serri-tori; Rivera, *Considerazioni sulle due Sicilie*; Petrosino, *Storia del Regno di Napoli*.)

Antient Tarentum, the Taras (Τάρας) of the Greeks, was one of the principal, or rather the principal Greek cities on the east coast of Italy. It is said to have been a town of the Messapians, to which were joined some Cretan colonies, the neighbouring town of Ugento. About 694 B.C., according to the story, Phalantus, one of the Parthenians, or mate sons of the Spartan women born during the Trojan war, of their husbands in the first Messenian war, having his country with a number of others of the same colony arrived on the coast of Iapygia, took Tarentum, expelled the original inhabitants. He organized a colony, and remained at the head of it until he was expelled by an insurrection, and withdrew to Buzium, where he died. (Justin, iii. 4.) A war between the Tarentines and the Iapygians ensued, in which the Perseus of Rhegium assisted the Tarentines, but they were defeated by the Iapygians, who destroyed a great number of the Tarentines. (Diodorus, xi.) Tarentum however recovered from its losses, and it flourished by commerce, and became a powerful city of Magna Græcia. Heraclea was the chief city of Tarentum. Herodotus iii. 136 mentions Aristagoras as king of Tarentum in the time of Darius Hyphantes. The government however underwent several changes. Strabo vi. 193 speaks of Tarentum as being at that time a democracy. Archytas, a native of Tarentum, is said to have made a body of laws for the Tarentines. [ARCHYTAS.] About 338 B.C. the Tarentines, being engaged in a war with their neighbours the Lucanians, applied to

assistance. Archidamus, the son of Ageilaus, was taken to them, and he was killed in fighting on their side. A few years after, being hard pressed by the Lucanians Brutii, the Tarentines applied to Alexander, king of Macedonia, and uncle to Alexander the Great. He came to Tarentum with troops, obtained considerable advantages, but was at last surprised and killed by the Brutii, near Pantalium, B.C. 323. (Justin, xii. 2; Livy, viii. 24.) The Tarentines had by this time degenerated; like most of the Greeks on the Italian coast, they had become luxurious and effeminate. Ælian (*Var. Hist.*, xii. 30) speaks of their habit of drinking early in the morning, and their appearance intoxicated in the forum.

In the year 282 B.C. the Romans, after having conquered the Samnites, made war upon the Lucanians. The Tarentines, who saw with jealousy the encroachments of Rome, expectedly attacked a Roman fleet, commanded by the consul L. Valerius, which was sailing near their coast, and killed a great many of the crew. The Roman consul sent commissioners to demand reparation for the damage done, but the Tarentines treated them with insult.

Notwithstanding, however to a sense of their danger, they applied to Pyrrhus, king of Epirus, for assistance, and sent vessels to convey him over with his troops, B.C. 281. Pyrrhus found that the Tarentines were too effeminate to furnish him much support, and he was obliged to assume a more powerful position in order to enforce something like order and discipline among them. Chiefly with his own troops, he was engaged in the war against Rome for several years, but was at last defeated by the consul M. Curius Dentatus, and he was obliged to re-embark for Epirus; leaving however a garrison at Tarentum, B.C. 275. [PYRRHUS.] The Tarentines were again obliged to quarrel with the Epirote garrison, which was sent by the Carthaginians for assistance to drive away the Epirotes.

The Romans having had notice of this transaction through Milo, the Epirote commander, sent the consul L. Papirius Cursor, who took Tarentum, and expelled the Epirote garrison to return home. It appears never from Livy (*Epitome*, xv. 1) that the Tarentines, being treated with severity, were placed in the condition of slaves of Rome, which they continued to be till after the battle of Cannæ, when Hannibal, who occupied Campania and Apulia, began to carry on secret intelligence with some of the Tarentine chief citizens, who were dissatisfied with their forced Roman alliance.

In the year 212 B.C. the hostages of the Tarentines ran away from Rome, but being pursued and overtaken near the city, they were brought back, and after being beaten and tortured were thrown down the Tarpeian rock. This punishment irritated the people of Tarentum, and they were obliged to make a treaty with Hannibal, and his troops were admitted into the city by night. The Roman garrison was expelled from the citadel was besieged by sea and by land.

The example of Tarentum was followed by Metapontum and Thurium. The Roman garrison in the citadel of Thurium defended it most gallantly, although they suffered greatly from want of provisions. An attempt which was made to introduce supplies by vessels from Sicily was frustrated by the Tarentine squadron under Democrates, who destroyed the loss of several Roman ships. In 209 B.C. the consul Q. Fabius Maximus retook Tarentum by surprise, through the treachery of the garrison left by Hannibal, which consisted of Brutian auxiliaries. The Tarentines made only a slight defence. Nico, Democrates, and Demomenus, the leaders of the party which was hostile to Rome, fell during the assault. A great booty was made of arms and money. The Romans, said to be nearly equal to that made at the siege of Syracuse. But the consul Fabius abstained from carrying off the statues of the gods, saying he would leave the Tarentines their angry deities. (Livy, xxv. 7, 11; xxvii. 15, 16.)

From that time Tarentum remained in subjection to Rome; and although it greatly declined in wealth and importance, it was still a considerable place in the time of Augustus. Horace calls it 'molle Tarentum' (*Satir.*, ii. 274) 'imbelle Tarentum' (*Epist.*, i. 7). The Greek language and manners were retained by the inhabitants till the fall of the Western Empire. Tarentum was one of the chief strongholds retained by the Byzantine empire in Southern Italy. About A.D. 774, Romualdus, the first duke of Beneventum, took Tarentum from the Byzantines. The Saracens landed at Tarentum about A.D. 840. The town was afterwards several times taken and re-taken. P. C., No. 1495.

taken and sacked, and it was during this period that the old town on the mainland was abandoned, and the inhabitants retired to the island as being more fitted to their reduced numbers, and also better capable of defence. At the breaking up of the Longobard state of Beneventum, Tarentum was for a time a separate principality, like Capua and Salerno. In the eleventh century it was taken by the Normans with the rest of Apulia, and Robert Guiscard made his son Bohemund prince of Tarentum. Under the Suabian dynasty, Frederic II. gave the principality of Tarentum to his illegitimate son Manfred. Charles II. of Anjou gave it to his younger son Philip, whose descendants acted a considerable part in the civil wars of the kingdom of Naples under Joanna I. Tarentum came afterwards into the possession of the powerful family of the Orsini, upon whose extinction it reverted to the crown.

(Giannone; Giovani, *De Antiquitate et varia Tarentinorum Fortuna*; D'Aquino, *Delicæ Tarentinæ Libri IV.*, Naples, 1771.)

TARARE. [RHÔNE.]

TARASCON, a town in France, in the department of Bouches du Rhône, 452 miles south-south-east of Paris, by Auxerre, Lyon, Valence, Le Pont St. Esprit, and Beaucaire; and 48 miles west-north-west of Aix, the capital of the department.

Tarascon is mentioned by Strabo, who writes the name *Ταράσκων*, and by Ptolemy, who writes it *Ταρουσκόν*; but it appears to have been of little importance in ancient times. Under the counts of Provence, to whom in the middle ages it was subject, it was of more consequence from its frontier position. It had a castle at least as early as A.D. 1251; of which the present castle occupies the site. This latter was built, according to Millin, by Louis II. of Anjou, count of Provence (A.D. 1384-1417); but according to other authorities Charles II. *le Boiteux* (A.D. 1285-1309) commenced the structure and Louis finished it. It is popularly called 'Château du Roi René' ('King René's Castle'), but it was undoubtedly erected before his accession.

The town is on the left bank of the Rhône, immediately opposite Beaucaire, on a rocky site sufficiently elevated above the bed of the river to secure it from inundation. The communication with Beaucaire was antiently by a stone bridge; a mass of stone-work, the remains of this bridge, lately existed, and probably still exists, in the middle of the river, between the two towns; the rest of the bridge had been swept away by the stream. In later times the communication was by two bridges of boats, extending one from each bank to this fragment of the old bridge. Within the last few years a suspension bridge of iron-bars has been constructed.

Tarascon is surrounded by an old ruined wall flanked with towers, and is entered by three gates. Some of the streets are straight and tolerably wide. The castle is a picturesque Gothic building of freestone in pretty good preservation: from the platform on the top of the castle there is an extensive view along the valley of the Rhône. Sainte Marthe (Martha) is the principal church in the town; in the crypt is a monument with a marble statue apparently sculptured early in the 16th century, and shown as the monument of Sainte Marthe. In the same church is the uncouth figure of a monster called the Tarasque, which, according to the legend, fed on human flesh and haunted the banks of the Rhône between Arles and Tarascon, and was overcome by Sainte Marthe. This figure is paraded through the city on Whit-Monday amidst the shouts of the idlers of the place, whose riotous behaviour frequently leads to serious accidents: it also makes part of the procession on the festival of Sainte Marthe. These customs, which had been disused after the Revolution, were renewed under the empire of Napoleon, if not before. There are a town-hall, a court-house, a commercial court (*Tribunal de Commerce*), two hospitals, a theatre, barracks, and abattoirs, or public slaughter-houses; these are most of them, if not all, modern buildings.

The population of the commune, in 1831, was 9225 for the town, or 10,967 for the whole commune. The neighbourhood of the town is very fertile, and a considerable trade is carried on in corn, wine, and oil; and the townsmen are engaged in throwing silk and spinning cotton-yarn, and in manufacturing hussars' and grenadiers' caps, hats, brandy, vinegar, and starch; there are tan-yards and cooperages. There are three fairs in the year. The industry of the inhabitants and their lively temperament

impart to the place an air of life and activity which contrasts remarkably with the ordinary dulness of Beaucaire.

Tarascon has a communal college or high school and a public library of 2000 vols. : it was the birth-place of Leon Ménard, the antiquary. The town was for a long time after the Revolution the seat of a subprefecture, or capital of an *arrondissement*; but about the time of the first restoration of the Bourbons, the subprefecture was removed to Arles.

(Vaysse de Villiers, *Itinéraire Descriptif de la France*; Millin, *Voyage dans les Départemens du Midi de la France*; *Dictionnaire Géographique Universel*.)

There is another town in France called Tarascon, in the department of Ariège, and on the river Ariège above Foix: it is from its position sometimes distinguished as Tarascon-sur-Ariège. D'Anville is disposed to identify it with the Tarasconienses of Pliny (*Hist. Nat.*, lib. iii., c. 5, 6), which others would fix at Tarascon on the Rhône. Tarascon-sur-Ariège is a small place, a mart of the ironstone dug in the adjacent Pyrenees. The population is probably about 1500.

TARAXACUM. [LEONTODON.]

TARAZONA, a considerable district of Aragon in Spain, bordering on the north and east on the province of Navarre; on the south on the province of Soria; and on the west on the *Corregimiento* de Borja. The capital, Tarazona, the ancient Turisao, is situated at the foot of a lofty mountain-range called the Moncayo, on the banks of the river Queiles, in 41° 55' N. lat., 2° 4' W. long. Tarazona is the see of a bishop, who is suffragan of Saragossa. The town is badly built, and the streets narrow and crooked. With the exception of the cathedral, a fine Gothic pile erected in the thirteenth century, there is no other building worth notice. Miñano (*Diccionario Geográfico*, vol. viii., p. 392) estimates the population of Tarazona at 10,000 inhabitants, in 1827. The neighbourhood is well cultivated, and yields abundant crops of all sorts of grain. There is also a small town in La Mancha called Tarazona.

TARBES, a town in France, capital of the department of Hautes Pyrénées, or High Pyrenees: about 400 miles from Paris, in a direct line south-south-west; 453 miles by the shortest road through Orléans, Châteauroux, Limoges, Périgueux, Agen, and Auch; or 533 miles by Limoges, Cahors, Montauban, Toulouse, and Auch, which is the route given by Reichard in his *Itinéraire*. It is in 43° 13' N. lat. and 0° 5' E. long.

Tarbes is mentioned in the 'Notitia Provinciarum et Civitatum Galliae,' where it is called Turba: it was the chief town of the Bigerrones, Bigerri, or Begerri, a nation which has given name to the district of Bigorre. In the town or adjacent to it was a fortress, called, in the 'Notitia,' *Castrum Bigorra*, the site of which is now occupied by the cathedral. In the middle ages, Tarbes was the capital of the county of Bigorre; it suffered from the ravages of the Saracens and the Normans, and was held for a time by the English. There was some sharp fighting near the town, in the campaign of the Duke of Wellington, A.D. 1814.

Tarbes is situated in a fertile plain, nearly 1000 feet above the level of the sea, watered by the Adour (on the left bank of which the town stands) and by the Lechez, and bounded on the south by the Pyrenees. The town is walled; the streets are well laid out, broad, paved, and watered by little brooks or streams, which contribute both to coolness and cleanliness. There are two public places or squares, that of Maubourget, which is planted with trees, and that of Marendieu, remarkable for its size; beside these two places, there is an agreeable promenade, called Le Prado, outside the walls. The houses in the town are generally of two or three stories, well built, of brick, some of marble, and roofed with slates. They have for the most part good gardens. The principal public buildings are the cathedral; the prefect's office, formerly the residence of the bishop, which from its elevated situation commands a pleasant prospect; and a handsome theatre of quite modern erection. The old castle of the counts of Bigorre is used as a prison. Tarbes has five faubourgs, or suburbs, on the five roads which lead from it in different directions: the suburbs are that of Rabastens on the east, on the right bank of the Adour, which separates it from the town; that of Vic on the north; that of Bagneres on the south; all on the roads leading respectively to those places; that of Sainte Anne on the west,

on the road to Pau; and that of Sainte Catherine on the south-west, on the road to Lourdes and Argelès.

The population of the commune, in 1826, was 8712; in 1831, 9706; in 1836, 12,630. There are copper-mills and manufactories for copper utensils, paper-mills, and tanneries; the town is the general mart for the supply of the department; there is a considerable market every fortnight for agricultural produce of every kind and for cattle, much frequented by the Spaniards, who make large purchases of live stock. There is a marble-quarry near the town.

Tarbes has a subordinate court of justice and a commercial court, some fiscal and other government offices; a communal high school with a library, and school buildings of good architecture; a free school of drawing and architecture; an hospital; a society of agriculture; and a government stud, for which there are two large ranges of stables and a handsome riding-school, just outside the town.

The *arrondissement* of Tarbes has an area of 505 square miles, and comprehends 197 communes: the population, in 1831, was 104,022; in 1836, 110,542; and is divided into eleven cantons, or districts, each under a justice of the peace. The bishopric of Tarbes dates from the sixth century, and now comprehends the department: the bishop is a suffragan of the archbishop of Auch.

(Millin, *Voyage dans les Dép. du Midi de la France*; Malte Brun, *Géographie Universelle*; *Dictionnaire Géographique Universel*.)

TARDIGRADA. Cuvier's name for the first family of the *ERENTATA*, comprising, of living genera, the Sloths only. [AI; UNAI.] The *Tardigrada* form the eighth order in Illiger's method, and comprise the Sloths and *Prochilus*; but the latter cannot be said to have any claim to such a collocation. [BEAR, vol. iv., pp. 90, 91.]

TARDIVOLA. Mr. Swainson's name for a genus of the subfamily TANAGRINÆ, and thus characterized by him:—

Bill lengthened, conic, somewhat slender: the sides not gibbous; the commissure slightly or not at all sinuated. Wings very short; the first quill shorter than the four next, which are equal and longest. Tail lengthened, rounded or graduated. Feet large. Tarsus and toes long. Outer toe rather shorter than the inner. Claws slender, slightly curved.

Example, *Turdicola sphenura*. [TANAGERS.]

TARE. We hardly know whether *all* the words *tare*, *tret*, *cloff*, *suttle*, *gross*, *net*, are still used in commerce; they all hold their places in works of arithmetic. *Tare* is said to be the allowance for the weight of the box or bag in which goods are packed; *tret*, an allowance of 4lb. in 104lb. for waste; *cloff*, an allowance of 2lb. in 3 cwt., that the weight may hold good when sold by retail; the *gross* weight, that of the goods and package together; the *suttle* weight, that which remains when *tare* only is allowed; the *net* weight, that which remains when all allowances are made. We shall merely state what we know of these words.

Tare (written *tara* in some of our older arithmetical works) is made from the Italian *tarare*, to abate. In its language *tara* is a technical term implying abatement of any kind, not for weight of package only. We believe *cloff* to have been the English word which originally stood for the allowance for package: in our older arithmeticians, *tare* and *cloff* generally go together, and the latter seems to be for the package, the former for other abatements. *Cloff* or *clough* is defined in an old dictionary as that wherein any thing is put for carriage sake. Humphrey Baker (1562) speaks only of *tare* and *cloff*; Masteron (1592), of *tara*, *cloff*, and *tret*, but the first two terms are used together. We cannot find *cloff* used in the sense given to it by our modern books of arithmetic until about the end of the seventeenth century.

Tret seems to be from the Italian *tritare*, to crumble. Stevinus, in his Latin treatise on book-keeping, uses *retrementum* in the sense of deduction from the quantity charged for. *Gross* weight needs no explanation: the Italian form *netto* was formerly used for net weight. It being well known that these terms generally come to us from the Italian, we must suppose *suttle* to be from *suttile*, which is used in the sense of fine and valuable, and is applied to the finer part, as separated from the coarser. One of our old writers (Masteron, 'Arithmetike,' 1592) uses *suttle* weight in a manner which makes us imagine we see the origin of the *hundred* weight being a hundred

and twelve pounds. Without any explanation, as if it were matter of notoriety, he contrasts *suttle* and *averduois* weight, the former having 100 pounds to the hundred-weight, the latter 112. In the rougher sort of goods, at the same period, the tare was (as appears by the tables they give) very often 12 pounds in 112: perhaps then the hundredweight of 112 pounds was only an allowance for the weight of the box, barrel, or other package.

TARES are a most important green crop in the improved systems of agriculture, especially on heavy soils, where they thrive best. When sown in autumn, with a small inkling of wheat or rye, they cover the ground in spring, and supply abundance of fodder in summer. A good crop of tares is fully equal in value, if not superior, to one of red clover: it comes off the ground in sufficient time to give the land a hasty summer tillage, which is so useful in destroying weeds, and to allow turnips to be sown in the same season. They smother annual weeds if the crop is plentiful, which should always be secured by an abundant manuring: thus they are a good substitute for a summer fallow in heavy soils, and amply repay the labour and manure bestowed upon them.

There are many species and varieties of tares; but that which is found the best adapted for agricultural purposes

is the common tare (*Vicia sativa*), of which there are two principal varieties, very slightly differing in appearance, one of which is hardy, and will stand the severest winters: the other is more tender, and is therefore only sown in spring; but it has the advantage of vegetating more rapidly, so that spring tares sown in March will be fit to cut within a fortnight or three weeks after those which were sown in autumn. By sowing them at regular intervals from September to May, a succession of green tares of perfection, that is, in bloom, or when the pods are formed, may be cut for several months, from May to October. A prudent farmer arranges his crops so that he shall have artificial green food for his horses and cattle at least six months in the year, by having tares fit to cut between the first and second cut of clover. When there are more tares than is absolutely required for this purpose, and the weather permits, they make excellent hay; or, if the weather is not favourable, they are cut and given to sheep, which are folded on the portion already cut. It is an advantage to have portable racks for this purpose, so that the fodder may not be trod under foot and wasted; and the tares may be placed between hurdles, tied two and two, which form extemporaneous racks. It is prudent to use sufficient seed for another year; but a crop of seed-ures raised for sale is seldom profitable, as they greatly exhaust the soil: and the price varies so much in different seasons, that it becomes too much of a speculation for a farmer. The difficulty in distinguishing the seed of the winter tare from the spring variety is so great, that it should either be raised at home, or only purchased from neighbours, or from the most respectable seedsmen. It is a common practice with dealers to mix the seeds of the winter tares, after the time of sowing is past, with spring tares, which are in request at a later period. The inconvenience of this is, that they do not vegetate equally, and consequently the winter tare is not in bloom when the spring tare is fit for the scythe. Foreign tares, which are imported in large quantities, are often the growth of southern climates, and will not stand the winter; or they have been raised from seed sown in spring, so as to be really spring tares. The difference is probably more owing to habit than to any real botanical distinction between them. When spring tares are sown in autumn instead of winter tares, they may occasionally stand the frost, if not very severe; but, in general, they rot on the ground and never recover; whereas the real hardy winter tares, whose vegetation is slower, seem insensible to the severest

at the early part of summer green rye and tares, mixed, are sold at a great price in large towns, for horses which are worked hard and been highly fed in winter. They are as a gentle laxative, and cool the blood: near London, where every produce is forced with an abundance of manure, tares are often fit to cut early in May, and the ground is immediately ploughed and planted with potatoes, or sown with mangel wurzel or ruta baga, which come in in September or October, in time for wheat-sowing. Two very profitable crops are raised during the time the land, according to the old system, would have

been fallow; and at the same time it is left as clean, by careful hoeing, as the best fallow would have made it.

There are a great many species of tares or vetches, for the terms are synonymous, many of which have been proposed to be introduced into general cultivation; but none seem, on the whole, to be so well adapted to our climate as the common tare: some have biennial and some perennial roots. The *Vicia biennis* has a strong stem and large leaves, and grows four or five feet high; but it is not so succulent as the common sort. It might, perhaps, by cultivation and early cutting, become a useful early fodder, and it may be worth while to make some experiments with it. There are several species of tares which grow wild in bushes and hedges; but they have never been cultivated in the fields, perhaps from the difficulty in collecting the seeds, which shed as soon as they are ripe. Of these, the *Vicia craca* appears most deserving of attention. It bears its blue flower on stems or spikes longer than the leaves, which are downy. It is very common in France among wheat; and, although a decided weed there, it is not much dreaded by the peasants, as it improves the fodder greatly. It has the appearance of great luxuriance in its growth, where it meets with a proper support. If it were mixed with some plants with a strong stem, such as the Bokhara clover (*Melilotus arborea altissima*), which itself affords much fodder, it might probably be cultivated to great advantage.

In the south of France there is a white perennial vetch or tare, called *Vicia pisiformis*, which is cultivated for its white seeds, of which soups are made, as with the pea and lentil. It grows in very light soils; and, although indigenous to a southern climate, it is said not to be impatient of frost. It has been called by some the Canadian lentil, or the white tare.

We shall only notice one more of the wild tares, which is an annual; it is called the yellow tare (*Vicia lutea*). It grows in stony soils and among bushes, is very branching, and rises from one to two feet high. From some experiments made by the Agricultural Society of Versailles several years ago, it would appear that this tare might be cultivated with great advantage, and is even superior to the common sort, because it can be cut two or three times during the summer, and affords a very good pasture in winter, which does not stop its vegetation: it will even bloom in a mild winter. Although short, it is so thick upon the ground, that its first cut is as heavy as that of the common tare, which is seldom worth cutting a second time.

Tares should be sown on land which is well pulverised. If after wheat, the stubble should be ploughed in with a deep furrow after a powerful scarifier has gone over the land several times to loosen it: five or six cart-loads of good farm-yard dung should be ploughed in. The tares should be drilled or dibbled, and the surface well harrowed. The intervals should be hoed early in spring: this will accelerate the growth, and insure a complete covering of the ground. As soon as the tares show the flower, they may be cut daily till the pods are fully formed; after this, any which remain uncut should be made into hay or given to sheep; for if the seeds are allowed to swell, the ground will be much exhausted. Another piece should be ready to cut by this time, and thus there may be a succession of tares and broad clover from May to November. Tares may be sown as late as August, on a barley or rye stubble, for sheep-feed early in winter, or to be ploughed in to rot in the ground where beans or peas are intended to be sown early in spring: this is perhaps the cheapest mode of manuring the land, the only expense being the seed; for the tillage is necessary at all events. In light soils, tares and buckwheat sown together immediately after barley or rye harvest, will produce a considerable crop of vegetable matter, which may be ploughed in in November. In favourable seasons, wheat may be sown immediately after, without fearing the effect of two white crops following each other; for the tares and buckwheat intervening, by their shade, and the two ploughings of the ground, one when they are sown, and the second when they are ploughed in, will entirely destroy all weeds, and give to the soil that improvement which will enable it to bear as good a crop of wheat as it would have done had it been sown the year after on a clover ley. Clover, which could not be sown with the barley, from the foul state of the land, may be sown among the wheat in the next spring, when it is hoed for the

second time. This is held out as a hint to show how an accidental interruption in a rotation may be remedied without any loss of crop or great deviation. As no rule is without exception, so no rotation can always be strictly adhered to; and those crops which admit of being sown at different times of the year are of the greatest use as substitutes for others which could not be conveniently sown without materially altering the succession of crops. In the common course of cultivation of heavy soils, where occasional fallows are necessary to clean the land, one-half of the land which requires fallowing may be sown with tares; and thus the clean unproductive summer fallow will only return at every second rotation. If the tares have been manured, or if they are fed off with sheep folded upon the land, the wheat or other crop which is sown after them will be as good as on a clean fallow, or after a good crop of clover. This alone would make tares a valuable crop; and they may be compared in their effect on heavy lands to turnips on lighter soils.

The seeds of the tare are occasionally ground into meal and made into bread. It is a very poor food; and when there is more seed than can be profitably disposed of, it may be given to pigs: but poultry, especially pigeons, are very fond of it. When given to horses, the seeds of tares are found very heating; and although they produce a fine glossy coat, they are not to be recommended for this purpose.

TARENTUM. [TARANTO.]

TARGUMS, or CHALDEE PARAPHRASES OF THE OLD TESTAMENT. During the Babylonish captivity, the language of the Jews was affected by the Chaldee dialect spoken at Babylon, to such an extent, that upon their return they could not understand the pure Hebrew of their sacred books; and therefore, when Ezra and the Levites read the law to the people, they found themselves obliged to add an explanation of it, undoubtedly in Chaldee. (*Nehem.*, viii. 8.) [HEBREW LANGUAGE; ARAMAEAN LANGUAGE.] In course of time such explanations were committed to writing, and from their being not simple versions, but explanatory paraphrases, they were called by the Chaldee word *Targum* (תרגום), which signifies 'an explanation.'

There are ten Targums extant:—1. *The Targum of Onkelos*, on the Pentateuch, is the most antient. Onkelos is supposed to have lived at Babylon. The Babylonish Talmud makes him a contemporary of Gamaliel, at the very beginning of the Christian era. No critics place him lower than the second century. His language approaches nearer than that of the other Targums to the pure Chaldee of the books of Daniel and Ezra. He follows the Hebrew text so closely, that his work is less a paraphrase than a version, and he is free from the fables which prevailed among the later Jews.

2. *The Targum of Jonathan Ben Uzziel*, on the Prophets, is by many ascribed to an author contemporary with Onkelos, or even a little older, namely, Jonathan the son of Uzziel, a disciple of the elder Hillel. The mention of his name in the Talmuds proves him to have lived earlier than the fourth and fifth centuries. But Jahn points out certain internal marks, from which he concludes that this Targum was compiled, towards the end of the third century after Christ, from other paraphrases, some of which at least were considerably older. The Jews make Jonathan contemporary with the prophets Malachi, Zechariah, and Haggai, and relate marvellous stories respecting the composition of his Talmud.

This Targum is more paraphrastic than that of Onkelos; its dialect is not so pure; the version is not so accurate, and indeed varies in accuracy in different parts; but it is free from the fabulous stories of the later Talmuds. It comprises the Prophets, in the Jewish sense of the word, namely, the books of Joshua, Judges, Samuel, Kings, Isaiah, Jeremiah, Ezekiel, and the twelve minor Prophets.

3. *The Targum of the pseudo-Jonathan*, on the Pentateuch, is so called from its having been erroneously ascribed to Jonathan Ben Uzziel. In purity of dialect, in its general style, and in its mode of exposition, it is far inferior to the Targum of Jonathan. It abounds in silly fables, and displays great ignorance of Hebrew on the part of its author. From internal evidence, such as its mention of the Turks and Lombards, it is evident that it could not have been written earlier than the seventh, or perhaps the eighth, century.

4. *The Jerusalem Targum*, on the Pentateuch, or however it omits large portions, and sometimes only single words, is evidently later than that pseudo-Jonathan, which it generally follows closely sionally departing from it for the worse. Its dia very impure, abounding in Greek, Latin, and Persian

The other Targums scarcely deserve a separate account of them, and lists of the editions and versions of the Targums, will be found in the works at the end of this article. Taken together, the T form a paraphrase of the whole of the Old Testame cept the books of Daniel, Ezra, and Nehemiah, called the less for such an exposition, as they are to extent written in Chaldee.

(Prideaux's *Connection*, pt. ii., bk. viii.; the 'ductions' of Horne and Jahn.)

TARIFA, a small sea-port town situated in the rowest part of the Strait of Gibraltar, on a point c projecting into the sea; in 36° 3' N. lat. and W. long. The Arabs called it Jezirah Tarif (the of Tarif), because a Berber, named Tarif Ibn Al-ma'feri, who was the lieutenant of Músa Ibn N landed on the little island facing the port with a force, two years before the final conquest of Spain Arabs. [Moors.] Tarifa is now a dependency of which has been made of late the capital of a provi the same name. In 1205 it was besieged by the A under Abú Yúsof, but it was stoutly defended by Alonso Perez de Guzman 'el Bueno,' the progen the dukes of Medina Sidonia, who would not surren fortress to them, notwithstanding they threatened head his only son, which they did before his eye 1340 a great battle was fought near Tarifa, betwe phonso XI. of Castile and Abú-l-hasan, sultan of F Morocco, when the former was victorious.

TARIFF, a table of duties to be paid on goods i or exported. The principle of a tariff depends comm commercial policy of the body by which it is d the details are constantly fluctuating with the c interests and the wants of the community, or in of commercial treaties with other states. The Bri has undergone six important alterations within a sixty years, namely in 1787, in 1809, 1819, 1825, 183 1842. The act embodying the tariff of 1833 is the Wm. IV., c. 56. Its character has been described Report of a Committee of the House of Commons in on the Import Duties, as presenting 'neither congru unity of purpose: no general principles seem to hav applied. The tariff often aims at incompatible the duties are sometimes meant to be both product revenue and for protective objects, which are freq inconsistent with each other. Hence they som operate to the complete exclusion of foreign produc in so far no revenue can of course be received; times, when the duty is inordinately high, the revenue becomes in consequence trifling. An made to protect a great variety of particular the expense of the revenue and of the commercial course with other countries.' The schedules to th 3 & 4 Wm. IV., c. 56, contain a list of 1150 artic each of which a specific duty is affixed. The un rated articles are admitted at an *ad valorem* dut and of 20 per cent, the rate having previously b and 50 per cent. In 1838-9, seventeen articles pr 94½ per cent. of the total customs' duties, and t remainder only 5½ per cent., including twenty-nine, produced 3½ per cent. The following table of the t 1833, showing the duties received in 1838-9, is an a of one prepared by the inspector-general of imports: parliamentary committee to which allusion has made:—

	No. of Articles.
1. Articles producing on an average less than 24l.	349
2. Ditto less than 240l.	132
3. Ditto less than 713l.	45
4. Ditto less than 2,200l.	107
5. Ditto less than 22,180l.	63
6. Ditto less than 183,864l.	10
7. Ditto less than 2,063,865	9
8. Articles on which no duty has been received	147
	862
	22.1

The new tariff, which is on the point of becoming law, contains very numerous alterations. Cattle and fresh meat are admitted, for the first time, on payment of duty; and the reduction of duty on salt-meat is considerable. Time will be required to show the result of the various changes which it contains. The heads of the tariff are comprised under nineteen heads, and the articles enumerated are as many as those in the tariff of 1833.

TARIK. [RODERIC.]

TARLTON, RICHARD, a comic actor of great celebrity in the reign of Queen Elizabeth, was born in the hundred of Condoover, in Shropshire. The date of his birth is not known. He died in 1588, and was buried (September 3) at St. Leonard's, Shoreditch, London.

Tarlton was especially distinguished for his performance of the clowns of the old English drama, in which he is spoken of as having been unrivalled, and seems besides to have been one of those clowns who spoke 'more than was set down for them:' he was famous for his extempore wit, which indeed must have been an important addition to the dull and vulgar speeches generally assigned to the clowns before Shakspeare's time—he interlarded with his wit the lean and hungry prose. Dr. Cave, 'De Politica,' Oxford, 4to., 1588, says (we translate Cave's Latin), 'We English have our Tarlton, in whose voice and countenance dwells every kind of comic expression, and whose eccentric brain is filled with humorous and witty conceptions.'

Stow mentions that Tarlton was one of the twelve actors whom Queen Elizabeth, in 1583, constituted grooms of the chamber at Barn Elms: he seems indeed to have been one of her especial favourites; for Fuller says, that 'when Queen Elizabeth was serious (I dare not say sullen), and out of good humour, he could undumpish her at his pleasure. Her highest favourites would, in some cases, go to Tarlton before they would go to the queen, and he was their usher to prepare their advantageous access to her.'

One of Tarlton's last performances was in 'The Famous Victories of Henry V.,' this was in 1588, at the Bull in Bishopsgate Street, to which theatre he seems to have been generally attached. Of this play, which is a much earlier one than Shakspeare's 'Henry V.,' a full account is given in the introductory notice to 'Henry VI., Parts I. and II.,' in Knight's 'Pictorial Shakspeare.' It is one of the 'Six Old Plays,' printed by Nichols in 1779.

Tarlton is known to have written at least one play, 'The Seven Deadly Sins,' which, though never printed, and now lost, was much admired. Gabriel Hervey, in his 'Four Letters and certain Sonnets especially touching Robert Greene and other Parties by him abused,' 4to., 1792, speaks of a work written by Thomas Nashe, 'right formally conveyed according to the stile and tenour of Tarlton's president, his famous playe of 'The Seven Deadly Sinnes,' which he designates as a 'most deadly but most lively playe.'

There is a portrait of Tarlton, in his clown's dress, with his pipe and tabor, in the Harl. MS. 3885; and a similar portrait of him (probably the one is a copy of the other) in the title-page of a pamphlet called 'Tarlton's Jestes,' 4to., 1611. A copy of the former portrait is given in Knight's 'Shakspeare,' at the end of 'Twelfth Night.' The peculiar flatness of his nose is said to have been occasioned by an injury which that feature received in parting some dogs and bears.

(Baker's *Biographia Dramatica*, by Reed and Jones.)

TARN, a river in France, belonging to the system of the Garonne. It rises near Mount Lozère, one of the Cévennes, in the department of Lozère, and flows first west to Sainte Enimie in the same department, 27 miles, and then south-west 27 miles to Milhau, in the department of Aveyron; from thence west-south-west 88 miles, by Alby and Gaillac, department of Tarn, to St. Sulpice; and from thence 48 miles north-west and west by Montauban (department of Tarn and Garonne) into the Garonne, below Massignac. The navigation is marked in Brué's map of France as commencing at Gaillac, and has a length of about 60 miles: other authorities make the navigation commence at Alby, and this statement agrees with the official accounts, which assign to the river a navigation of 90 miles. It has several tributaries, but none of them are navigable. [FRANCE; GARONNE; TARN (department); TARN ET GARONNE.]

TARN, a department in the south of France, bounded

on the north and north-east by that of Aveyron, on the south-east by that of Hérault, on the south by that of Aude, on the south-west and west by that of Haute-Garonne, and on the north-west by that of Tarn and Garonne. The form approximates to that of a parallelogram, having its sides respectively facing the north-east, south-east, south-west, and north-west. The extreme length from north-west to south-east, from the neighbourhood of Penne on the Aveyron to the border of the department of Hérault, near St. Pons, is 65 miles; the extreme breadth, from the neighbourhood of Valence to that of Puy-Laurens, is 46 miles. The area is estimated at 2222 square miles, which is somewhat under the average area of the French departments, and rather greater than the conjoint areas of the two English counties Surrey and Sussex. The population, in 1826, was 327,653; in 1831, 335,844; and in 1836, 346,614, showing an increase in five years of 10,770 persons, or above 3 per cent., and giving 156 inhabitants to a square mile. In amount and density of population it is below the average of the French departments, and is very far below the county of Surrey alone in amount, and in density of population below both Surrey and Sussex. Alby, the capital, is on the Tarn, 339 miles in a straight line nearly due south of Paris, or 482 miles through Orléans, Châteauroux, Limoges, Cahors, Montauban, and Toulouse; a very circuitous route, but the only one laid down in Reichard's Road-book.

The department is very mountainous in the south-east part, where it comprehends a portion of the Cévennes. A range of hills branching off from this chain, and running nearly parallel to it, crosses the north-west part of the department, skirting the valley of the Tarn; and there are some other ranges of less elevation and importance. The peak of the Cévennes, which overlooks the town of Sorèze, in the south of the department, has an elevation of 1760 feet. The eastern side of the department, bounded by a line drawn southward or south by east from the junction of the Viaur and the Aveyron, is chiefly occupied by the granitic or other primary or by the earlier secondary formations: west of this boundary-line the tertiary formations prevail; only on the banks of the Cerou and the Aveyron in the northern part, and about Puy-Laurens in the southern part of the department, the secondary formations, which lie between the cretaceous group and the new red-sandstone group, crop out from beneath the tertiary rocks. The mineral productions are of no great importance. There was, in 1834, only one coal mine worked; it gave employment to 273 workmen within the mines and 42 others, making a total of 315: the quantity of coal produced was 19,933 tons, and the total value 13,152*l.*, or 13*s.* 9*d.* per ton on the average. The quantity produced in 1835 was 18,420 tons. There were, in 1834, two iron-works with three forges for the manufacture of wrought-iron: the ore was converted directly into malleable iron, and charcoal was the only fuel employed. Lead and copper ore are said to be found, but no mines are now worked. There are marble-quarries, plaster-pits, and pits for porcelain and potters' clay.

The department belongs entirely to the basin of the Garonne. The Tarn, one of the principal feeders of that river, touches the border of the department just above the junction of the little river Rance, and flows along the border till that stream (which belongs altogether to the department of Aveyron) joins it; it then quits the border and flows westward to Alby and then south-west to the junction of the Agout, shortly after which it quits the department to enter that of Haute Garonne: the navigation commences at Gaillac, or, according to some authorities, at Alby. Just above Alby the Tarn has a fall, or rather a series of falls, over the steep face of a limestone rock, in which it has worn a number of channels, which so divide the stream, that when the water is low it may be crossed by leaping from one prominence to another: this fall is called Saut du Sabot or Saut du Tarn. The tributaries of the Tarn which belong to this department are the Aveyron, the Tescou, and the Agout. The Aveyron has only a small part of its course in this department, and another small part along the border; its affluent the Viaur has part of its course along the border: but the Cerou and the Verre, two other affluents of the Aveyron, belong to this department almost entirely. The Agout rises in the department of Hérault, but belongs almost entirely to this department

as do its affluents, the Vian (which receives the Vebre), the Gijou (which receives the Gijas and the Berlou), the Tauré (which receives the Larn and the Larnette), the Sor, the Bagas, and the Adou. None of the tributaries of the Tarn or their affluents are navigable, though some of them are of considerable length, the Aveyron being above 120 miles, the Vian 60, the Agout 75, and the Adou 45; the others are smaller.

There are in the department five Routes Royales, or government roads, which had, January 1, 1837, an aggregate length of 207 miles, of which 116 miles were in good repair, 85 miles out of repair, and 6 miles unfinished. None of these roads are of the first class: the principal are those which lead from Alby south-west, by Gaillac, Lisle, and Rabastens, to Toulouse; south, by Réalmont and Castres, across the Cévennes into Languedoc; east by Villefranche to La Cavalerie, on the high road from Paris to Montpellier; and north-east by Carmeaux to Rodez, in the department of Aveyron. Roads branch from the Alby and Toulouse road at Gaillac, and lead, one west to Montauban and Bordeaux, one north by Cahusac and Cordes to Aurillac, in the department of Cantal. Another road leads from Castres by Lavaur to Toulouse. The departmental roads had at the same time an aggregate length of 485 miles, of which 296 were in repair and 189 out of repair. The vicinal roads had an estimated aggregate length of 7500 miles in round numbers.

The area of the department is equal to rather more than 1,400,000 acres; considerably more than one-half of this is under the plough. The soil, except in the mountainous parts, is generally fertile; but agriculture is in a very backward state; manures are neglected, and the system of rotation is very faulty. These deficiencies are chiefly observable in the arrondissements of Alby and Gaillac, which comprehend the beautiful valley of the Tarn: in the arrondissements of Castres and Lavaur, in the south of the department, improvements have been more readily adopted. The produce in grain, comprehending wheat, barley, oats, rye, maize, and buckwheat, is sufficient to supply the consumption of the department and to leave a little for exportation. Pulse, flax, hemp, woad, aniseed, coriander, and saffron are also raised; the growth of woad is of long establishment and considerable importance. The meadow and grass lands may be estimated at about 100,000 acres, and the heaths, commons, and other open pastures at 150,000 acres. The valleys and the slopes of the hills afford good pasturage, and the breeding of cattle is one of the principal sources of the wealth of the department. Sheep and pigs are numerous, and the veal is in high repute. The breed of horses is improving. The vineyards occupy nearly 80,000 acres; the cultivation of the vine is very skilfully and carefully managed. The red wines of Cuzac, Causagnet, St. Juféry, St. Amarans, and Gaillac are of the first class; those of Meillhart, La Roque, Florentin, La Grave, Tecon, and Rabastens are of the second class; Gaillac produces some white wines. The average produce of the vintage is estimated at above 430,000 hectolitres, valued at 5,500,000 francs. The orchards and gardens occupy about 6000 acres. The olive is not cultivated to any extent.

The woodlands occupy 200,000 acres; the oak, the beech, the ash, the maple, the chestnut, the walnut, the mulberry, and the wild cherry-tree are common.

Bees are numerous, but the breeding of the silkworm is not carried on to the extent of which it is capable. The wild boar, the roebuck, the wolf, the fox, the badger, the polecat, and the hedgehog are found; and small game is tolerably abundant.

The department is divided into four arrondissements, as follows:—

Name.	Position.	Area in Square Miles.	Population.		Com. munes.	Cens. Cons.
			1831.	1836.		
Alby	N. E.	553	80,954	84,929	96	8
Castres	S.	861	131,154	136,188	95	14
	and E.					
Gaillac	N. W.	496	71,323	72,001	79	8
Lavaur	S. W.	312	52,413	53,496	57	5
		2,222	335,844	346,614	327	35

In the arrondissement of Alby are—Alby, on the Tarn; population, in 1831, 9049 for the town, or 11,665 for

the whole commune; in 1836, 11,801 for the comm [Alby]; Castelnau and Lescure, on the Tarn; Rodez pop. 2100 for the town, or 2660 for the whole commune; on the Adou, and Villefranche and Denat on a tributary that river; Valence, Carmeaux, Monestiés, and Salles-le-Cerou, or its tributaries; Villeneuve, on the Vian, and Pampellonne, on the Vian. Castelnau, distinguished as Castelnau-de-Bonnafoux, is built on a slope rising to the north bank of the Tarn, just below Alby, and is commanded by an old castle. Lescure was antiently fortified; it is a little above Alby. Réalmont has a Protestant church, and is a tolerably well-built town: there are linen manufactories and a bleach-green; serge and corduroy and worsted hose are also made; eight fairs are held in the town. Villefranche has nine considerable cattle-fairs; Valence is regularly laid out with straight streets, a well-wooded district, from which a considerable quantity of timber is sent to Alby, Gaillac, and Bordeaux; the town has five large fairs, chiefly for cattle. Leather and saddlery are made at Carmeaux; and considerable trade is carried on at Monestiés in linen, thread, and cattle. Moneys has thirteen fairs, Salles two, and Villeneuve distinguished as Villeneuve-sur-Verre five. Pampellonne, or Pampellonne, is surrounded by the remains of its fortifications, has two gates. There are two principal streets, and large places or squares. Considerable business is done in horsecloths, which are manufactured; and there are yearly fairs.

In the arrondissement of Castres are—Castres, on Agout, population, in 1831, 12,032 for the town, or 16,000 for the whole commune; in 1836, 17,002 for the whole commune [CASTRES]; Brassac, Fort-de-Ferrières, Roquecourbe, Burlats, and Vielmeur, all on the Agout; Anglès, Hautpoul, Mazamet; pop. 3896 for the town, or 7006 for the whole commune, and La Brugière, on the Tauré or its tributaries; La Caune (pop. 1650 for the town, or 3691 for the whole commune), on the Gijas; Vabres, on the Gijas; Mondragon, on the Adou; La Bessonnié and Lautrec, between the Adou and the Agout; and Dourgne and Sorèze (pop. 1574 for the town, or 2817 for the whole commune) in the southern corner of the department. Brassac, distinguished as Brassac-de-Belfort, is the centre of a considerable manufacture of dimity and other cotton goods carried on in the village of Brassac-Castelnau, which is included in the commune of the town; and other villages around. Fort de Ferrières takes its name from an antient fort, once used as a state prison, now as a manufactory cotton goods. Roquecourbe, situated in a fertile district, has a Protestant church, and is the seat of a considerable manufacture of woollen stockings; it has four yearly fairs. Vielmeur, or Vielmeur, has a manufacture of cotton yarn, and of knitted stockings; it has five fairs. Anglès manufactures of woollen and cotton yarn, and woollen cotton goods. Hautpoul has an antient castle, forms the capital of the barony of Hautpoulois; it was stormed in 1212, by Simon de Montfort. Mazamet is a busy town; it has a number of manufactories for woollen goods of various sorts, some dye-houses, and several paper-mills; it has four fairs for cattle, wool, and manufactured goods. Flannels, blankets, and other woollens are manufactured at La Brugière, distinguished as La Brugière-Dulac; hosiery and dimity at La Caune; and calicoes, dimities, and other cotton goods, and flannel at Vabres, distinguished as Vabres-des-Sénégats. Vabres has a Protestant church; four fairs are held in the year. Mondragon, now of little importance, was formerly of considerable note; it has six yearly fairs, a number of pigs are sold here. Lautrec is on a high eminence, and has the ruins of an antient castle; it has yearly fairs. The neighbourhood produces good wine and melons. Lautrec was formerly a viscounty; it was held in the time of François I., by Odon de Foix, a general of considerable distinction in the Italian wars of that king. Dourgne has some manufactories of coarse woollens, the cattle fairs, and in the environs some important quarries of white and gray marble. Sorèze had formerly a Benedictine abbey, where twelve young persons of noble families, but without fortune, received a gratuitous education; it has now a college or high school, one of the most important in the south of France. Cotton yarn, woollen articles, and leather are made; and there are yearly fairs. Sorèze was fortified by the Huguenots in the middle of the sixteenth century, but the ramparts were demolished in 1629.

stroyed in the reign of Louis XIV. At La Roer Castres, are two remarkable natural curiosities: her treulant, a mass of stone, comprehending cubic feet, and resting on a very narrow base, so as to vibrate sensibly when pushed, like the Logan Stone, in Cornwall; and the grotto which bears the name of St. Dominic, from having served as a retreat celebrated ecclesiastic.

arrondissement of Gaillac are—Gaillac (population 5552 for the town, or 7725 for the whole commune in 1836, 8199 for the commune), on the Tarn; population 1726 for the town, or 5065 for the whole commune Rabastens (pop. 3417 for the town, or 6966 for the commune), on the same river; Penne, on the right bank; Cordes (pop. 2239 for the town, or 2602 for the commune), on the Cerou; Cestayrols, Cahuzac, Castelnaudmirail, and Puiceley, on or near the Verre; Salles, near the Tescou; and Cadalen, between the Tarn and Adou. Gaillac is on the right or north bank of the river, and is an old town without any striking public buildings. There are an hospital and a small theatre. East of Gaillac is a suburb, well laid out and pleasantly situated. There are many brandy distilleries and cooperages, and one or two dye-houses, and yards for building boats and ver-crast. Trade is carried on in corn, wine, and other articles; there are seven yearly fairs. Lisle (otherwise Alby), on the right bank of the Tarn, is a small town in a place or square regularly laid out and adorned with a fountain. Considerable trade is carried on in corn, and there are seven yearly fairs for cattle, linen and wool. Rabastens, in a fertile plain on the right bank of the Tarn, is an ill laid out and ill-built town. It is a pleasant suburb, and adjacent to it an agreeable promenade. Some blankets are manufactured, and trade is carried on in corn, wine, and fruit: there are many yearly fairs. Rabastens has the ruins of an antient castle which was taken by Simon de Montfort in the reign of the thirteenth century, and by the English in the fourteenth century. Cordes is on an elevated site on the left bank of the Cerou: it has a handsome square, and the ruins of an antient castle: leather and iron are manufactured; there is a considerable market for corn and fruit, and there are six yearly fairs. Castelnaud de Montmirail was antiently a town of strength: it is in a district fertile in corn and coarse marble is quarried in the neighbourhood. It is on a height on the right bank of the Verre, not far from Castelnaud de Montmirail; the chief business of the town is the manufacture of casks, joiners' and other work, and cheeses of great delicacy: there are four yearly fairs. Abundance of wood is obtained in the adjacent forest of Grésine. Salvaiguac, or Salvagnac, is situated on an eminence not far from the left bank of the Tescou: it has some iron-forges, and considerable trade is carried on in cattle: there are six yearly fairs. Trade in cattle is carried on at Cadalen.

arrondissement of Lavaur are—Lavaur or Laveur, Agout (population in 1831, 4422 for the town, or the whole commune; in 1836, 7205 for the commune Giroussens and St. Sulpice, on or near the same river; Puy-Laurens (population 1799 for the town, or 6160 for the whole commune), near the head of the Giron, an antient feeder of the Garonne; and Graulhet (population 58 for the town, or 5097 for the whole commune) on or near the Adou. Lavaur is on the left bank of the Agout, which is here crossed by a modern bold construction. The town was defended by a castle protected by a castle in the eleventh century. Religious wars which signalised the early part of the thirteenth century, it was one of the strongholds of the counts, from whom it was taken, A. D. 1211, by Simon de Montfort, who committed the most fearful cruelties. The town is divided into the old town and the new town, together ill built. The chief branch of industry is silk-throwing. The raw silks of Haut or Upper Languedoc are brought here; and when thrown are sent to Nimes and other places, where silk-stuffs for the upholsterers, and silks are made; and there are dye-houses and tanneries: there are three yearly fairs. Lavaur has a high school, a small public library, an agricultural society, and a court of justice. Giroussens was formerly a town of strength, and the object of contest in the English wars of the fourteenth century. It stands on the right

bank of the Agout: the townsmen manufacture brown pottery, but their ware is less in request than formerly. There is one yearly cattle-fair. Puy-Laurens is on a small eminence commanding the surrounding fertile plain. It was one of the strongholds of the Huguenots in the religious wars of the sixteenth century: but the fortifications were raised in the reign of Louis XIII. The town appears to have been after this still occupied by the Protestants, who had here an Academy of Sciences, which was suppressed after the revocation of the Edict of Nantes. Silk-throwing is carried on, and there is considerable trade with Spain in horses and mules: there are five well-attended yearly fairs. Graulhet, on the left bank of the Adou, has a considerable manufacture of hats and woollen stuffs, and a number of tan-yards. Considerable trade in horses is carried on, and there are five cattle-fairs. The district round the town is fertile: the millstones are dug.

The population, when not otherwise described, is from the census of 1831.

That part of France which now constitutes this department was chiefly comprehended, in the earliest historical period, in the territory of the Ruteni. The southern portions were comprehended in the territory of the Umbranci, and the south-western in that of the Tolosates. That part of the territory of the Ruteni which was comprehended in the department is considered by D'Anville to have been occupied by the Ruteni Provinciales, distinguished by Cæsar by that epithet from the other Ruteni, as being within the limits of the Roman province at the time of his command in Gaul. The Umbranci and Tolosates were also within the province. The Ruteni were defeated by Fabius Maximus, B. C. 121, and it was probably at this time that part of them (the Ruteni Provinciales) became subject to Rome. The independent Ruteni took an active part in the general revolt of the Gauls under Vercingetorix, near the close of Cæsar's command, and were sent by Vercingetorix to ravage the lands of the Volcae Arecomici, who were Roman provincials. They were subdued by Cæsar. All these nations appear to have belonged to the great Celtic stock. Under the Romans the Ruteni (including the Ruteni Provinciales) appear to have been comprehended in the province of Aquitania Prima; the Umbranci and Tolosates, in Narbonensis Prima. The town of the Albienses (*Civitas Albiensium*) of the 'Notitia' was probably Alby: the Albigi of the anonymous Geographer of Ravenna was probably the same place. No other Roman town can be identified with any locality within the department. The river Tarn is noticed by Ausonius (*Mosellæ Descriptio*, 465) and Sidonius Apollinaris (*Carmen*, xxiv. 45) under the name of Tarnis: the former bestows on it the epithet 'aurifer,' 'the gold-bearing;' the second calls it 'citus,' the 'swift.'

In the middle ages, and down to the period of the Revolution, the larger portion of this department was known as the territory of L'Albigeois; the arrondissement of Lavaur, and the adjacent parts, formed the district of Le Bas (Lower) Lauraguais: both these were comprehended in Le Haut (Upper) Languedoc. Alby was the chief town of L'Albigeois; Lavaur of Bas Lauraguais.

Upon the downfall of the Roman Empire this part of France passed into the hands of the Visigoths, and subsequently of the Franks under Clovis. The district of L'Albigeois was part of the great duchy of Guienne in the time of the later kings of the Merovingian dynasty. It was subsequently held in succession by the counts of Toulouse, the viscounts of Béziers, and the counts of Carcassonne: and was, in the early part of the thirteenth century, the scene of the fearful cruelties perpetrated in the crusade against the Albigeois or Albigenes, a sect deriving their name from the district, and persecuted by the Romish church as heretical. [ALBIGENES.] In the sequel of this crusade the district of L'Albigeois was annexed to the crown. The district of Lauraguais was successively held by the counts of Carcassonne and Barcelona; one of these latter, having become king of Aragon, ceded Le Lauraguais to the Viscount of Béziers, who again ceded it to St. Louis, king of France. It was alienated by Louis XI., who gave it to the counts of Auvergne, but was reunited to the crown by Henri IV.

TARN ET GARONNE, a department in the south of France, situated between 43° 47' and 44° 23' N. lat., and 0° 40' and 2° 0' E. long. It is bounded on the north by the department of Lot, on the north-east by that of Avey-

ron, on the east and south-east by that of Tarn, on the south by that of Haute Garonne, on the south-west by that of Gers, and on the north-west by that of Lot et Garonne. Its form is irregular; the greatest length is from north-east to south-west, from the border of the department of Aveyron near Parisot, to the bank of the little river Larax, near Lavit-de-Lomagne, 64 miles; the greatest breadth at right angles to the length, is from the border of the department of Lot et Garonne, near Montaigut, to the border of the department of Haute Garonne, near Grizalles, 44 miles. The area of the department is estimated at 1421 square miles, which is not so much as two-thirds of the average area of the French departments, and is rather less than the area of the English county of Sussex. The population, in 1826, was 241,586; in 1831, 242,509; and in 1836, 242,184, showing a very trifling increase (598 persons, less than 0.25 per cent.) in the ten years from 1826 to 1836; and in the latter half of the term a positive decrease. The number of inhabitants to a square mile, in 1836, was 170, which is rather above the average density of the population of France; but the department is inferior in amount of population to most other departments; and both in amount and density of population to the English county with which we have compared it. Montauban, the capital, is 335 miles in a direct line south by west of Paris, or 408 miles by the road through Paris, Orléans, Châteauroux, Limoges, and Cahors.

This department was not one of those formed at the first establishment of the departmental division of France by the National Assembly, A.D. 1790; but was created by a senatus-consultum under the reign of Napoleon, A.D. 1808. It was formed from the arrondissement of Montauban, taken from the department of Lot; the arrondissement of Castel Sarraasin, taken from the department of Haute Garonne; the cantons of Auvillard, Montaigut, and Valence, taken from the arrondissement of Agen, in the department of Lot et Garonne; the canton of Lavit-de-Lomagne, taken from the arrondissement of Lectoure, in the department of Gers; and the canton of St. Antonin, taken from the arrondissement of Villefranche, in the department of Aveyron. The department thus formed was divided into three new arrondissements, Montauban, Moissac, and Castel Sarraasin.

The department has no mountains and scarcely any hills; slight undulations alone vary its surface. The greater part is occupied by the tertiary formations of the basin of the Gironde: the part north-east of St. Antonin, on the Aveyron, and Puy-la-Roque, is occupied by the secondary formations which intervene between the chalk and the red marl or new red sandstone. Some of our authorities enumerate coal among the productions of the department; but this is hardly consistent with its geological character, nor were any coal-mines wrought in 1834 and 1835, of which the official returns are before us. Some iron is obtained; and there was, in 1834, one iron-work, with two furnaces for making pig-iron, and five forges for making wrought-iron. Charcoal was the fuel almost exclusively employed. Marble and good freestone are quarried in the north-east parts of the department; and limestone, marl, and potters'-clay are dug in several places.

The department belongs altogether to the basin of the Garonne. The Garonne itself enters it on the south side, a little below Grenade, and flows north-west by Verdun and Le-Mas-Garnier, to the junction of the Tarn: it then flows a few miles west by Auvillard; and turning again north-west, and passing Valence, quits the department. It has about 40 miles of its course (49 miles, according to the official account) in this department, navigable throughout. The Tarn enters the department on the south-east: it flows first north-west by Montauban to the neighbourhood of La Française; and then, in a winding channel, westward into the Garonne, which it joins on the right bank: its whole course in this department may be estimated at 36 miles (40 according to the official account), navigable throughout. These are the only navigable rivers. Of smaller streams, the Garonne receives on the left bank the Lambon, the Gimone, and the Serre, above the junction of the Tarn; and the Larax, or Rats, below the junction of that river. The Barguelone (formed by the junction of the Grande Barguelone and the Petite Barguelone) and the Saône (which receives the Seine) join the Garonne on the right bank, below the junction of the

Tarn, and beyond the limits of the department, to which however a considerable part of their course belongs. Aveyron, a considerable feeder of the Tarn, which it joins the right bank, between Montauban and La Française, the lower part of its course in this department or along its boundary. The Tarn receives also the Tescou (of which the Tescounet is a feeder) and the Lemboulas (of which the Latté is a feeder), both on the right bank. The Tarn also receives the Seye, the Bonnette, and the Lerc, on the right bank; and the Verre and the Tause on the left bank.

The department had, 1 Jan., 1837, seven Routes Royales or government roads, with an aggregate length of 60 miles, viz. 150 miles in good repair and 8 miles unfinished; the aggregate length of the departmental roads at the same time was 234 miles, viz. 156 miles in good repair and 78 miles unfinished: the bye-roads and lanes of the department of above 4200 miles. The principal communication is that from Paris to Montauban and Toulouse: it enters the department on the north side, at the village of Madeleine, and runs southward by Causeade and Réalville to Montauban; and from thence, still southward, by Grizalles, a little beyond which it quits the department to Toulouse. A road from Montauban runs west-north-parallel to the course first of the Tarn, afterward of the Garonne, by La Française, Moissac, and Valence, to deaux: another road runs south-west, by Montcaumon, Beaumont-de-Lomagne, to Auch; and a third, east-east, to Gaillac and Alby, in the adjacent department of Tarn. A road which enters the department on the east runs by Caylus and Septfonds, and, uniting with the road from Paris to Toulouse at Causeade, forms the communication between Rodez and Montauban. A road runs from Moissac along the valley of the Garonne, by Castel Sarraasin, St. Porquier, Scatalen, and Fignan, to Toulouse, forming the shortest communication between Montauban and Toulouse.

The climate is generally mild, but subject to violent storms which occasion frequent attacks of catarrh and rheumatism. The mean temperature in winter is from 36° to 40° Fahrenheit, that of spring and autumn from 59° to 63°, and that of summer from 81° to 86°. Rains are frequent in spring: the summer heat increases gradually towards the end of July, when it is very great: autumn is the sanest season of the year: winter, though not so cold, is generally dry. Snow rarely falls.

The area of the department may be estimated at 910,000 acres in round numbers, of which about 600,000 acres, or above six-tenths, are under the plough. The soil is various; in some parts stiff and clayey, in some sandy; so sandy in some places as to be incapable of cultivation. The greater part however is very fertile: the plains and alluvial tracts which line the banks of the Garonne, the Tarn, and the Aveyron, are among the most fertile in France; but those along the banks of the Garonne are liable to be injured by the inundations of that river. The farms are generally separated by quick-hedges adorned with clumps of the wild quince-tree. The most important article of agricultural produce is wheat, which is of excellent quality. It is ground into flour, especially at Montauban; and large quantities are exported to the West Indies. Barley, oats, rye, maize, pulse, potatoes, vegetables of excellent quality, rape, flax, and hemp, are also cultivated to a considerable extent.

The meadows have an extent of about 43,000 or 44,000 acres, the heaths and open pastures of more than 41,000 acres. The number of horned cattle and sheep is not in any means so considerable as it might be: the breed of sheep has been however gradually improving, and the wool is of good quality. Horses, fitted for the cavalry, are reared; and a considerable number are bred for the Spanish market. The breeding of swine is on the increase. Poultry, especially ducks and geese, is numerous: they are salted in considerable quantity; their livers, which sometimes weigh two pounds, are made into the pies for which this part of France, Toulouse especially, is so famous. The quills also form an important article of trade.

The vine is extensively cultivated on the slopes of the more elevated plains, where the soil is commonly of a whitish colour, of mingled clay and fine sand, little adapted for the growth of corn, but suited to the vine which succeeds admirably in the district between the

The vineyards have an extent of about a large part of their produce is made into portation. The wine is of fair quality, but and in general of a deep colour, which it

and gardens occupy about 4500 acres: the chestnut trees are of great size: the white cultivated in order to rear the silk-worm, object of attention, though not so extensively made. The woods occupy about 110,000 and fresh-water fish are abundant: great the lamprey and the shad are taken in the spring.

ent is divided into three arrondissements,

Situation.	Area in Sq. miles.	Population in 1831.	Population in 1836.	Cantons.	Communes.
E.	619	107,853	106,799	11	62
N.W.	341	62,489	62,735	6	49
S.W.	461	72,167	72,650	7	80
	1421	242,509	242,184	24	191

arrondissement of Montauban are—Montauban, population, in 1831, 18,255 for the town, or whole commune; in 1836, 23,865 for the [MONTAUBAN]; La Française (pop. 3686), near on, St. Antonin (pop. 2861 for the town, or whole commune), Montricoux, Bioullé, Négreville (pop. 3030), on or near the Aveyron; the Verre; Parisot, on the Seye; Caylus the town, or 5319 for the whole commune), e; Puy-la-Roque, Septfons, Caussade (pop. on, or 4479 for the whole commune), on or its affluents; Montpezat and Molières, Lemboulas; Mirabel, between the Lerc and; and Montclar, on the Tescounet. La manufacture of pottery from the fine clay in the neighbourhood. St. Antonin is on of the Aveyron, at the junction of the Bonre manufactures of serge and other woollen are are tan-yards and paper-mills: cons is carried on in leather and dried plums. s twelve yearly fairs: marble is quarried i. Négrepelisse was formerly inhabited Huguenots; and when Louis XIII. besieged u. 1621), he put a garrison into this town; ants rose upon the garrison, and put them consequence of which the town was taken he royal army. Cotton goods are woven, ried on in corn, wine, and hemp: there are

At Réalville considerable trade is carried flour: there are five yearly fairs. Bruni-work. Caylus has eleven yearly fairs, and Caussade has some manufactures of linen and the townsmen carry on trade in corn, id truffles: there are eight yearly fairs.

arrondissement of Moissac are—Moissac, on the e Tarn (population, in 1831, 5050 for the for the whole commune; in 1836, 10,618 e) [MOISSAC]; Auvillard or Auvillar (popo the town, or 2302 for the whole comaronne; Valence (population 1994 for the or the whole commune), between the Garguelone; Lauzerte (population 1753 for \$ for the whole commune) and Miramont, rguelone; Monjoy or Montjoye and Castelnear the Saône; Le Bourg-du-Visa, on a the Saône; Montaigu or Montaigu (popu the town, or 4172 for the whole commune) n the Seune; and Dunes, near the western department. At Auvillard or Auvillar ten Auvillards) are manufactures of earthen-d hose: there are four yearly fairs. The is productive in wine. Valence (distinge d'Agen) has four yearly fairs: the leather and prepare quills for writing, picturesque situation on a rocky eminence, of the Lendou with the Petite Barguelone: irts, where much business is done in corn, e. Montaigu has some manufactures of nd leather, and five yearly fairs. Dunes arly fairs for cattle, corn, and linen cloth. o. 1496.

In the arrondissement of Castel-Sarrasin are—Castel-Sarrasin, near the right bank of the Garonne (population, in 1831, 3346 for the town, or 7092 for the whole commune; in 1836, 7408 for the commune); Verdun (population 1809 for the town, or 4234 for the whole commune), Le Mas-Garnier, and St. Nicolas-de-la-Grave, on the Garonne; St. Porquier, Scatalen, Montech, Fignan or Finhan (population 1600 for the town, or 1730 for the whole commune), and Grizalles or Grizolles (population 1724 for the town, or 2091 for the whole commune), between the Tarn and the Garonne; Bouillac, near the Lambon; Beaumont de Lomagne (population 3126 for the town, or 4130 for the whole commune), on the Gimone; and Lavit de Lomagne, near the Serre. Castel-Sarrasin suffered much in the religious wars, and the quantity of bones and of arms dug up in the neighbourhood bears testimony to the frequency or severity of the conflicts it has witnessed. The town is agreeably situated in a fertile plain about a mile from the Garonne, and is well built. The old walls and ditches have been destroyed, and replaced by agreeable promenades. The townsmen manufacture serge and other woollen stuffs, hats, and leather: there are three yearly fairs. There are one or two subordinate government offices. Verdun, distinguished from other places of the same name as Verdun-sur-Garonne, is on the left bank of the river: it has much declined from its former importance, but has still some woollen manufactures and three yearly fairs. St. Nicolas-de-la-Grave is known for the excellent melons grown in the surrounding district: there are four yearly fairs. St. Porquier is known for the extensive cultivation of tobacco and saffron in the neighbourhood: it has three yearly fairs. Grizalles or Grizolles is in a fertile plain, a short distance from the right bank of the Garonne: the townsmen manufacture a considerable quantity of cutlery, especially excellent scissors: there are three yearly fairs for cattle and horses. At Beaumont-de-Lomagne coarse cloth and other woollens, hats, and leather are manufactured, and trade is carried on in corn: there are seven fairs in the year.

The population, when not otherwise described, is that of the commune, and from the census of 1831.

This part of France, at the earliest historical period, was occupied by the Cadurci, a Celtic people, who were north of the Garumna (now the Garonne), the Tarnis (now the Tarn), and the river now known as the Tescou; by the Tolosates, also Celts, who inhabited the part south of these rivers; and by the Lactorates (of the Aquitanian stock), in whose territories that small portion of the department which lies south of the Garonne and west of the Larax or Rats was included. Perhaps some small portions of the north-western border may have belonged to the Nitiobriges, a Celtic people, and some portions of the eastern border to the Ruteni, who were also Celts: but these portions, if there were any, must have been very small. The Tasconi of Pliny, who appear to have left their name to the little rivers Tescou and Tescounet, on the banks of which they dwelt, were probably either a subdivision of the Tolosates, or a small tribe subject to them. In the Roman division of Gaul the Tolosates, with the Tasconi, were included in the province of Narbonensis Prima; the Cadurci and the Ruteni in that of Aquitania Prima; and the Nitiobriges and Lactorates in Novempopulana.

Only two places mentioned by Roman authorities are supposed to have been in this department. Cosa, mentioned in the Theodosian or Peutinger Table, was probably on the bank of the Aveyron, near Réalville; and the Fines of the same authority may be placed on the Tescou, near the junction of the Tescounet.

In the middle ages, the north-western parts, about Montaigu, Castel-Sagrât, and Valence, as far south as the Garonne, were included in L'Agenois; the northern and north-eastern parts, as far south as the Tarn, in the district of Le Bas Quercy, except just about Parisot and St. Antonin, which belonged to La Basse Marche in Rouergue; L'Agenois, Quercy, and Rouergue were all subdivisions of Guienne. South of the Garonne the whole was included in Gascogne or Gascony; the part west of the Larax being comprehended in Le Condomois, a district of Gascogne Proper; and the part eastward of the Larax in Lomagne and Rivière-Verdun, two districts in Bas (Lower) otherwise Noir (Black) Armagnac. The districts between the Garonne and the Tarn belonged to the district of Le Toulousain, or the county of Toulouse, properly so called, in Languedoc.

These territories, upon the overthrow of the Roman empire, passed into the hands of the Visigoths, from whom they were afterwards wrested by the Franks. The county of Toulouse was annexed to the crown in the reign of Philippe III. le Hardi; the county of Armagnac first by Louis XI. and finally by Henri IV., and Rouergue finally by François I. Le Quercy and L'Agénois were for a long time part of the English possessions in France. The English were finally driven out in the middle of the fifteenth century.

TARNOPOL is a circle in the eastern part of Austrian Galicia, bordering on the Russian government of Podolia. The area is about 1400 square miles, and the population 212,500, of whom about 13,000 are Jews. The surface of the country is an undulating plain broken only by a few hills. The forests are very extensive, and the soil in general extremely fertile: it produces corn, flax, hemp, tobacco, garden vegetables, and fruits. 'The fine meadows,' says Hassel, 'would enable the inhabitants to breed great numbers of cattle, but it is only the breeding of horses that is more considerable than in the rest of Galicia; they are of the true Polish race. In 1817 there were 36,273 horses, 9412 oxen, 26,339 cows, and 59,282 sheep.' According to the very detailed statistical tables for 1830 (published in 1834, which are the latest that we have seen), there were 41,223 horses, 11,156 oxen, 26,065 cows, and 81,283 sheep. There is no large river in the circle; the Podhorze forms the eastern boundary towards Russia, and the interior is watered by the Sered, the Tryna, the Guila, and other small streams.

TARNOPOL, the capital of the above circle, is a considerable town, with 10,500 inhabitants, of whom nearly half are Jews. It is situated on the river Sered, which there passes through a lake. There are in the town a Roman Catholic and a Greek church, three synagogues, a Jesuits' college, a gymnasium, and a philosophical seminary. In the year 1820, 50 of the Jesuits expelled from Russia were allowed to settle in a Dominican convent at Tarnopol. The sum of 300 florins a year was assigned to each, with a moderate sum for the establishment of the gymnasium, it being intended that they be solely employed in the education of youth in and out of the town. The inhabitants have a pretty considerable trade, but have not made much progress in manufactures. The principal establishments are tanneries. As in most Polish towns, the houses are of wood, and the streets unpaved, where filth of all kinds is suffered to accumulate.

(Hassel; Stein; Cannabich; *Mission from the Church of Scotland to the Jews*, 1842.)

TARNOW, a circle of Austrian Galicia, is bounded on the north by the Vistula, which separates it from Poland, on the east by Rzeszow, on the south by Jaslo, on the south-east by Sanok, and on the west by Bochnia. The area is 2000 square miles, and the population at present must be at least 240,000; since, according to the statistical tables for 1830, it was 238,453, of whom 14,608 were Jews. The country is an extensive plain, with here and there an inconsiderable eminence. The soil is on the whole not very fertile, in many parts sandy, and ill-cultivated. The rivers are, the Vistula on the north, the Dunajec on the west, and the Wisloka, which flows through the middle of the circle. Though the chief occupation of the inhabitants is agriculture, its operations are performed in a very slovenly manner, and the breeding of cattle is by no means in proportion to the extent of the country: the forests however are very profitable, and there is no other circle in Galicia where the people make so many wooden wares of various kinds, pipe-staves, &c. There are no manufactories, properly speaking, except in the chief town and its neighbourhood, but the country-people manufacture a great quantity of linen.

TARNOW, the capital of the circle, is pleasantly situated on an eminence near the river Biala, over which there is a handsome wooden bridge of one arch of 180 feet span, which is entirely covered over. The population of the town, without the suburb, is 2250, of whom 1650 are Jews; with the suburb the population is 4800. The houses are for the most part well built of brick, two stories high. This town is the see of a Roman Catholic bishop, and the seat of the tribunal of the circle. It has a cathedral, a Franciscan convent, a synagogue, a gymnasium, a Jewish infirmary, a military hospital, erected in 1835, and several schools. The inhabitants manufacture linen, damask,

wooden-ware, and cabinet-work. They traffic in silks, and carry on a brisk trade. They call the monuments of the princes Janusz von the counts of Tarnow-Tarnowski: two of them are 70 feet high, and reach to the roof of the tower; the two monuments are very highly spoken of.

TARPEIAN ROCK. [ROME.]

TARPORLEY. [CHESHIRE.]

TARQUINIUM (*Tapκviva*, or *Tapκviva*), a city of Etruria, on the southern bank of the river Arnolfo, empties itself into the sea a few miles below Corneto (Strabo (v. 2. p. 355, ed. Tauchnitz), the town was founded by Tarcon, one of the companions of Tyrreus, the Byzant., s. v. *Tapκviva*; Virgil, *Æn.*, viii. 111; Lucian, viii. 473; and, according to others, founded by the Thessalians and Spinambrians. In the time of the Marcius, Demaratus of Corinth is said to have been banished to his countrymen of Etruria, and favourably received by the Tarquinienses; describes him as the father of L. Tarquinius Superbus. [Whatever may be thought of this tradition, it seems clear that Etruria and Tarquinii in an early period considered themselves as a part of Greece. Tarquinii appears to have become a great and powerful city, as is clear from the fact that it carried on with Rome, and from the inscriptions which have recently been discovered; and doubt that it formed one of the twelve *æpαι* consisting of the city and an extensive territory. After the expulsion of Tarquinius Superbus, B.C. 509, the Tarquinienses were the most powerful of the Etruscans, and unsuccessfully endeavoured to recover their territory by force of arms. (Liv., ii. 6, &c.) About the year B.C. 480, the Tarquinienses again made war upon the Romans, and ravaged their territory, but they were defeated by M. C. C. Sulpicius and L. Julius. This however did not deter them from renewing their hostilities against Rome, and inroads upon her territory. It was on such an occasion, in the year B.C. 358, that a war broke out between the Romans and the Tarquinienses, which lasted for several years. The Roman general, M. C. C. Sulpicius, under the consul C. Fabius, won a decisive victory, and the Tarquinienses made 307 Roman soldiers all of whom were sacrificed to the gods. From that time carried on the war on the defensive, and acquired new allies, and invaded the Roman territory as far as the Salina, at the mouth of the Tiber. However, in 356 B.C., they were defeated by M. C. C. Sulpicius, and the year after they were obliged to lay down their arms. The Roman general exacted a cruel revenge for the outrage which had been committed upon their prisoners. The common Tarquinii into the hands of the Romans were all made slaves, and the nobles were sent to Rome, where they were lodged in the forum. (Liv., vii. 12-19.) Shortly after the Tarquinienses sued for a truce, which was granted for a year. Tarquinii, like the rest of the Etruscan towns, remained neutral in the wars of Rome with the other Etruscans, and remained in almost perfect independence until after the expiration of the truce the Tarquinienses sued for a peace of the same duration. At a later period the Tarquinienses became a Roman Municipium (Cicero, *pro* Cluentio).

The site of the ancient Tarquinii is clearly to be seen in the ruins still extant on the hill of Corneto, a modern town of Corneto. The place has acquired a peculiar interest through the discovery of the art which have been discovered in the tombs. The first of these were opened in 1764, and was found in them was described by Buonarroti. Discoveries have frequently been made there since, and the most important are the paintings with which the walls of the catacombs are decorated; but besides these, several works of art, are found there. Respecting the art which have been discovered in the tombs, see Wilcox and Morton, *Account of some Apartments with Etruscan Inscriptions*, &c., in the *Philosophical Transactions for 1764*; Von Stackelberg, *Älteste Denkmäler oder Wandgemälde aus den Hypogäen v. 1827*, with numerous plates.

TARQUINIUS. According to early Roman tradition, the family of the Tarquinii gave two kings and a republic to Rome. Its origin was traced to the town of Corneto in Etruria, and thence to Greece. Modern

ver have shown that the Tarquini did not come from it, but must originally have belonged to Latium, and from the earliest times there existed at Rome a gens *tarquinia*. (Niebuhr, *Hist. of Rome*, i., p. 373, &c.) We sub- list of those members of the house of the Tarquins lay a prominent part in the early history of Rome. **TARQUINIUS PRISCUS.** The old story concerning th and his arrival in Rome ran thus:—During the y of Cypselus at Corinth, Demaratus, a wealthy ant who belonged to the noble family of the Bac- s, was obliged by the tyrant to quit his native city. iled to Etruria, which he had often visited before on ercantile voyages, and took up his residence at Tar- . Here he married a woman of noble rank, who im two sons, Lucumo and Aruns. (Dionys., iii. 46; i. 34; Polyb., vi. 2.) As an aspiring foreigner could hope to satisfy his ambition in Etruria, Lucumo, the death of his father and brother, resolved to ate with his wife Tanaquil and a numerous band of is to Rome, where several strangers had already obl- the highest honours. He was confirmed in his tations by a miraculous occurrence which happened hen he was approaching the city, and by the inter- tion of it by his wife, who was well skilled in augury. ome Lucumo was favourably received by King Ancus us, and lands were assigned to him. To omit nothing art which might characterize him as a complete e adopted the name of Lucius Tarquinius, to ubssequently the name Priscus was added to distin- uim from other members of his house. His wealth ence induced King Ancus to allow Tarquin to ert in all the affairs of state, and in his will he made e guardian of his children, who were yet under age. us MARCIUS.] Tarquin himself aspired to become of Rome. Accordingly, on the death of Ancus, he sent oung princes out hunting, and during their absence d the comitia for electing a successor to Ancus, and ed in persuading the people to elect him, to the sion of the sons of Ancus, 616 B.C. is is the common story of the descent of the fifth king ome, of the manner in which he came to Rome, and raised to the throne. How much there may be his- al in the tradition cannot be ascertained. Thus 1 however appears certain, that the arrival of Dema- in Etruria cannot have been contemporaneous with ranny of Cypselus, and that, as stated above, Tar- us was not a foreigner, but belonged to a Latin gens *tarquinia*. (Niebuhr, *Hist. of Rome*, i., p. 373, &c.) Tarquinius Priscus distinguished himself during his no less in war than in the peaceful administration e state. His first war was against the Latins, from u he took great spoil. With equal success he car- on war with the Sabines, whom he defeated in two t battles, and from whom he took the town of Colla- with its territory. After this he again made war on Latins, and after he had subdued them and made elf master of many of their towns, he concluded a e with them. During the intervals between these e introduced various improvements into the consti- of the state, which are mentioned in the articles t, p. 104, and SENATUS, and which were intended ganize the body of the plebeians, and perhaps to them on an equality with the patricians. But he only partially carry his schemes into effect, as he was ted by the augur Attus Navius, who probably acted stigiation of the patricians. After his first Latin arquin built the Circus Maximus for the exhibition e public spectacles, and is said to have been the er of the Roman or great games (Ludi Magni) or He also assigned the ground round the forum e individuals, that they might there build porticoes or transacting business; and lastly he is said e rounded the plan of enclosing the city by a stone hich he was prevented from accomplishing by the of the Sabine war. After the second war against e, he recurred to his plan, and is said to have made e preparations for building the wall; but the comple- it was reserved for his successor Servius Tullius. eatest work at Rome, which owes its origin to Tar- hich has survived all the vicissitudes of the e gigantic sewers (cloacae) in the lower districts [CLOACA.]

Ancus Marcius, who had been deprived of

the throne by their guardian Tarquin, never forgot the injury, and when they discovered that it was his and Tanaquil's intention to secure the succession to Servius Tullius, they formed the design of murdering Tarquin. [SERVIUS TULLIUS.] For this purpose they hired two sturdy shepherds, who went to the king's palace, and there conducted themselves as if they were engaged in a violent quarrel. At last the king himself appeared to settle their dispute, but while he was listening to one of them, the other split the king's head with an axe. Thus died L. Tarquinius Priscus, after a reign of thirty-eight years, in B.C. 578. The queen kept his death secret until the succession was secured to Servius Tullius. The assassins were seized, and the sons of Ancus fled to Suessa Pometia. (Livy, i. 34-42; Dionysius, iii. 46-73.) Tarquinius Priscus left two sons, Lucius and Aruns Tarquinius.

During the reign of this king Rome appears as a powerful state in comparison with what it is said to have been before him. According to the historians this greatness was not the result of his reign, but is supposed to have existed before it, and to have enabled him to do what he did, so that this increase of the power and dominion of Rome must have taken place previous to his reign, although we do not know how it was effected. Some traditions mentioned (Tacitus, *Annal.*, iv. 65) that under Tarquinius Priscus an Etruscan of the name of Caeles Vibenna came with a colony to Rome and settled on the Caelian hill, which derived its name from him.

LUCIUS TARQUINIUS SUPERBUS, the seventh and last king of Rome, was the son of Tarquinius Priscus, and brother of Aruns. Tullia, a daughter of Servius Tullius, was married to the gentle Aruns, and her sister to L. Tarquinius. In concert with Lucius, Tullia murdered her own husband Aruns and her sister, and then married L. Tarquinius. Lucius placed himself at the head of a conspiracy, and murdered his own father-in-law, the aged Servius Tullius. Tarquinius, who received the surname of the Haughty or the Tyrant (Superbus), succeeded his father-in-law as king of Rome, 584 B.C., without either being elected by the people or confirmed by the senate.

There is no doubt that the hatred of the very name of king which prevailed at Rome during the republic, has greatly contributed to exaggerate the cruelty and tyranny of the last king, and thus to corrupt his history. But notwithstanding all this, it is clear that Tarquin by his talents, both as a general and a statesman, quickly raised Rome to a degree of power which it had never possessed before. The first act attributed to him after his accession is the death of all the senators who had supported the reforms of Servius Tullius, and in order to render his own person safe, he formed an armed body-guard which always accompanied him. He in fact undid all that Servius had done; he took on himself the administration of justice, put persons to death or sent them into exile according to his own pleasure, and kept the whole internal and external administration in his own hands, without either consulting the people or the senate. In order that the senate might sink into insignificance, he never filled up the vacancies which so frequently occurred through his executions, banishments, or through the natural death of senators. To secure himself still more, he formed a close connection with the Latins, to one of whom, Octavius Mamilius of Tusculum, he gave his own daughter in marriage. The influence which he thus gained among the Latins was most visible in their assemblies on the Alban Mount by the temple of Jupiter Latiaris, in which Rome also had a vote. Tarquinius, by cunning and fraud, or, according to others, by force of arms, subdued the towns of Latium and placed Rome at the head of the league (Livy, i. 50, &c.; Dionysius, iv. 45, &c.; Cicero, *De Re Publ.*, ii. 24), which was now also joined by the Hernicans and the Volscian towns of Ecetra and Antium. The wealthy town of Suessa Pometia was besieged and taken, perhaps because it had refused to join the league. The Latin town of Gabii experienced a similar fate. Sextus, the king's youngest son, went thither under the pretext of being a deserter, and contrived to put himself at the head of the Gabian army. After having put to death or sent into exile the most distinguished citizens of Gabii by the advice of his father, he treacherously surrendered the town to him. The whole account of the war with Gabii bears the character of a fable, and resembles in many respects other fabulous stories of early Grecian history. The treaty which was formed

with Gabii after its surrender, was engraved on a wooden shield, and preserved in the temple of Jupiter Fidius to the time of Dionysius of Halicarnassus. Tarquin founded in the conquered territory of the Volscians the two colonies of Signia and Circeii, by which he extended and strengthened the power of Rome.

Tarquin is said to have been fond of splendour and magnificence. He built the capitol, with the threefold temple of Jupiter, Juno, and Minerva, and adorned it with brazen statues of the gods and of the early kings. (Livy, i. 53; Dionysius, iv. 59; Pliny, *Hist. Nat.*, xxxiii. 4; xxxiv. 13.) Here he also deposited the oracular books which he had purchased from a Sibyl. [SIBYL.] After the establishment of the colonies of Signia and Circeii, a fearful omen was seen, which seemed to bode ruin to his family; and in order to ascertain its import he sent his two sons, Sextus and Aruns, accompanied by his nephew, L. Junius Brutus, to Delphi. To the question as to which of the three ambassadors was to reign at Rome, the Pythia answered: he who should first kiss his mother. Brutus, who had always assumed the appearance of an idiot, understood the oracle, and on landing in Italy, fell down and kissed the earth, the mother of all. Tarquin's coffers were now exhausted by the great works that he had undertaken, and he was tempted to make himself master of Ardea, a wealthy town of the Rutuli. As however he did not succeed in his first attack, he laid siege to the town. While this was going on, a dispute arose between the sons of Tarquin and their cousin, C. Tarquinius Collatinus, respecting the virtue of their wives. This led to the violation of the chaste Lucretia, the wife of Collatinus, who lived at Collatia, by Sextus, the king's eldest son. As the highest pride of a Roman woman at this time was her virtue, Lucretia sent for her husband, father, and Brutus, and killed herself in their presence, after having cursed the family of the king, and implored her friends to avenge the injury which she had suffered. Brutus immediately marched with an armed force from Collatia to Rome, and roused the people to avenge the indignity and throw off the yoke of their tyrant. The citizens were easily persuaded; they deprived the king, who was yet in the camp of Ardea, of his imperium, and banished him with his wife and children from Rome, 510 B.C. After these occurrences Tarquin hastened to Rome, but finding the gates of the city shut upon him, and learning that he was declared an exile, he retired to Caere, whither he was followed by his son Aruns. His other son Sextus sought a refuge at Gabii, but the citizens, remembering his former treachery, put him to death. The simple fact of the banishment of King Tarquin, which was commemorated at Rome every year by a festival called 'The King's Flight' (*Regifugium* or *Fugalia*), is beyond all doubt historical; but what is described as its immediate cause, and its accompanying circumstances, may be poetical inventions.

Tarquin however did not give up the hope of recovering what he had lost. He first sent ambassadors to Rome to demand the surrender of his moveable property. During their stay in the city the ambassadors formed a conspiracy, in which young patricians chiefly are said to have joined them. The conspirators were discovered and put to death, and the moveable property of the royal family was given up to the people, in order to render reconciliation impossible. The king is said to have found favour and protection with the inhabitants of Caere and Tarquinii, and with the Veientes, and to have led the united forces of these people against the Romans, who however defeated their enemies near the forest of Arsia. Brutus fell in this battle in single combat with Aruns. Tarquin now sought and found assistance at Clusium, which was then governed by the mighty Lar Porsenna. [PORSENNA.] During the war of this chieftain with Rome Tarquin is entirely lost sight of in the narrative of the historians; but after its conclusion we find him supported by the Latins, and waging a fresh war against Rome under the Latin dictator Octavius Mamilius of Tusculum. The battle near lake Regillus (496 B.C.), in which the king lost his only surviving son, decided the whole contest. The account of the detail of this battle is as fabulous as any part of the early history of Rome, and formed, as Niebuhr supposes, the concluding part of the 'Lay of the Tarquins.' The aged king, now deprived of all his hopes, retired to Cumae, which was then governed by the tyrant Aristodemus, where he died the year following, 495 B.C.

(Livy, ii. 19, &c.; Dionysius, vi. 2, &c.; Niebuhr of Rome, i., p. 555, &c.)

LUCIUS TARQUINIUS COLLATINUS, the son of E and the husband of Lucretia. After the banish the king he was elected consul together with L. Brutus. But the people beginning to suspect th might perhaps be tempted to follow the example kinsman, and endanger the freedom of the young re he was compelled to abdicate, and to submit to th tence of exile, which was now pronounced upon the family of the Tarquini. (Livy, i. 57, 60; ii. 2.)

TARRAGONA, a province of Spain, bordering north on Catalonia, on the south on Valencia, and west on Aragon. The capital, Tarragona, is situa the coast of the Mediterranean, on the declivity of a tain rising to 760 feet above the level of the sea, an the mouth of the river Francoli, 41° 7' N. lat. and E. long. Tarragona, the Roman Tarraco, is one most antient cities of Spain; as it is supposed to hav founded by the Phœnicians. During the second War it became a Roman colony (Plin., *Hist. Nat.*, and, subsequently under Augustus, the capital o pania Citerior, or Tarraconensis, which comprised lonia, Aragon, Navarre, Biscay, the Asturias, Gal portion of Leon, and the Balearic Islands. Tarraco w the chief city of one of the seven conventus, or divis the province for purposes of administration, and his justice. In A.D. 467 it was taken by Euric, king of Goths, and levelled with the earth. The Arabs redt in 710, like most cities on that coast, and it remain their hands until Raymond IV., count of Barcelona it from them, about the close of the eleventh ce The city being found in a very ruinous and dilap state, Don Bernardo, archbishop of Toledo, under rebuild it on condition that the pope would absolv of an oath he had taken, and not fulfilled, of repai the Holy Land. The absolution having been grante archbishop of Toledo destined the greatest por

revenues of his see to the rebuilding of Tarragona. a the War of Succession, the English took possession city, which they intended to keep and began to f Some of the outworks and redoubts thrown up by the still visible. In 1810 the French, under Marshal S laid siege to it, and took it by storm on the 29th of 1811, after a siege of several months. The conduct French commander on this occasion is greatly to l he not only justified, but even encouraged, the pe tion of all kinds of atrocities, on the ground that he by one dreadful example to terrify the people and p all further resistance. An attempt to retake the city, in June, 1813, by the allied forces under General S Murray, failed completely; for at the approach of S who was advancing from Valencia, that officer rais siege and re-embarked his troops with such precip that he left all his artillery and stores behind.

Tarragona is tolerably well built, and the Rom mams render it interesting. Besides the circus, wh now almost entirely built upon, it has a very fine a theatre, in a good state of preservation, and a large F building, probably a temple, which the inhabitants ca palace of Augustus. The remains of a splendid aqua which once supplied Tarragona with water, whic brought from a distance of 16 miles, afford lil a proof of the importance of the city under the R About three miles east of the city there is a ver mausoleum, which the vulgar call 'El Sepulcro de Scipiones' (the tomb of the Scipios), from a belie Cneus and Publius Scipio are buried under it. C Moorish domination there remain no other traces t large building close to the sea, which is believed to been their arsenal. The cathedral is by far the mo: resting building in the city, and is well deserving of tion for its vast dimensions and the elegance and pu its Gothic architecture. It was erected in the year but has since been greatly added to. The chapel of Thecla, which is entirely built of rich marbles and ja is one of the richest and most tastefully decorated i church. The great altarpiece too is much admir its exquisite carvings, executed by a native artist: Tarragona is the see of an archbishop, who once ds: with that of Toledo the primacy of Spain. Durin Moorish domination, several provincial and general cils were held there. At the first, which took place ir

ordained that the Sabbath should commence on night. The immediate neighbourhood of Tarrawell cultivated, and yields corn, wine, oil, and great abundance. The principal manufactures are coarse cotton-goods, hats, and cutlery, which are sent to all parts of Spain, and to the island of Cuba.

TARSHISH (תַּרְשִׁישׁ) is a place mentioned in the Old Testament, particularly in connection with the commerce of the Hebrews and Phœnicians. In *Gen.*, x. 4, the sons among the sons of Javan, who are supposed to have peopled the southern parts of Europe. (Compare *Isaiah*, i. 10; *Isaiah*, lvi. 19.) In other passages it is mentioned as sending to Tyre silver, iron, tin, and lead (xxvii. 12; *Jerem.*, x. 9); and from *Isaiah*, xxiii. 1, it is inferred that it was subject to the Phœnicians. The prophet Jonah, attempting to avoid his pursuers, fled from Joppa in a ship bound to Tarshish. (*Jonah*, i. 3; iv. 2.) In several passages of the Bible the 'ships of Tarshish' are spoken of, especially in connection with Tyre; and it is pretty generally agreed that the word only describes a species of large ship, such as was used in the trade with Tarshish, just as we speak of the 'galleons' of the present day.

In a comparison of the above passages, the majority of writers have concluded that Tarshish must be sought for in the eastern part of the Mediterranean, or even outside its limits; and it has been generally identified with the ancient emporium of Tartessus in Spain, a place which undoubtedly furnished the products said to have been imported from Tarshish. The Phœnician name 'Tarshish' has been generally identified with the Greek *Ταρτησοδος*; in fact the pronunciation of 'Tarshish' would be 'Tarthesh.' There are abundant proofs that the Phœnicians had established an extensive commercial intercourse with Spain in an early period.

There is a considerable difficulty about the position of Tarshish. The ancient geographers place it, some say on the river Baetis (Guadalquivir), the most famous of which river they state to have been also the source of the Nile; while others identify it with the city of Calpe, near Mount Calpe, the rock of Gibraltar. (*Strabo*, iv. 132; *Strabo*, p. 140, 148-151; *Mela*, iii. 6; *Pausan.*, vi. 19; *Steph. Byzant.*, v. *Ταρτησοδος*.) The best way to explain and reconcile these statements is to take the latter as the name of the place, and with the biblical accounts respecting Tarshish, to identify it with the name of the rock of Gibraltar. In this district there may have been one city bearing a name like Tartessus, which survives in various forms in the names of the neighbouring city Calpe, Carpe, or Carthage (as it is written in all these ways), and of the Phœnicians. This statement will be more clearly confirmed after a reference to the articles on the letters T and S. In confirmation of this view, *Strabo* states that the country in the neighbourhood of Calpe was called Tartessus. In confirmation of this view, *Strabo* states that the country in the neighbourhood of Calpe was called Tartessus. In confirmation of this view, *Strabo* states that the country in the neighbourhood of Calpe was called Tartessus.

TARSUS. Storr's name for a genus of QUADRUMANA. *Specific Character.*—Head rounded; muzzle short; eyes large; posterior limbs very much elongated; tarsus thrice as long as the metatarsus. Tail

Formula:—incisors $\frac{4}{2}$; canines $\frac{1-1}{1-1}$; molars $\frac{6-6}{6-6}$

Species. *Tarsius Bancanus.*

Description.—Dr. Horsfield remarks, that although the *Tarsius Bancanus* agrees in the essential points with the species of this singular genus which have hitherto been described, it has no intermediate front teeth, and the anterior tooth on each side is, compared with the species, very minute. Counting (with Desmarest) the anterior tooth on each side, above and beneath, it has, according to Dr. Horsfield, only five grinders in each jaw. The head, continues Dr. Horsfield, 'in proportion to the size of the body, is large; the arch of the forehead is high, and the occiput is regularly spheroidal. The disposition and excessive size of the eyes is characteristic in this as in other species. The

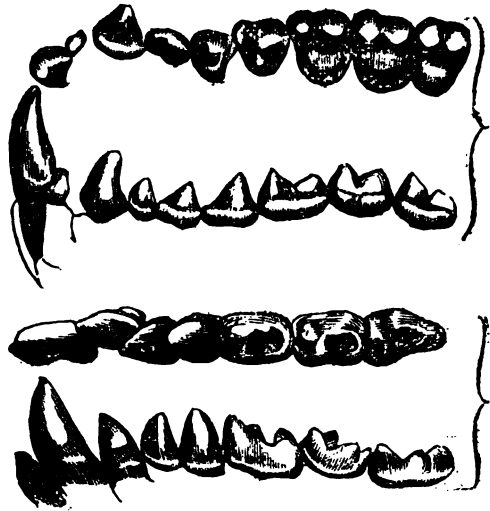

Teeth of *Tarsius*, much larger than the nat. size. (F. Cuv.)

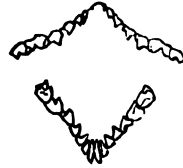

Front view of the teeth of *Tarsius Bancanus*. (Horsf.)

rostrum, or extremity of the face, is short and obtuse; the nose is slightly rounded, almost flat above; and the nostrils, as usual in this genus, are pierced laterally. The ears, which from their erect position and their projection beyond the cranium give a peculiar distinctive character and appearance to the other species, in our animal are disposed horizontally, and instead of rising up towards the crown of the head, incline backwards and extend but little from its sides; the lobes, as usual, are very thin, membranous, semitransparent, thinly beset with delicate hairs; several tufts of longer hairs arise from the base, where the interior membranaceous lobules are discovered, but in our specimen too much contracted to admit of a detailed description. The neck is very short, and the anterior extremities have the same proportion to the body as in the other species. The hands are externally covered with a very soft down; internally they are naked, and provided with several rather prominent protuberances, which, according to the opinion of Mr. Fischer, are calculated to assist the animal in climbing. The fingers are deeply divided and very delicate; those of the hands have the same proportion, one to the other, as they have in man; on the feet they are more lengthened and slender; the third finger is longer than the middle finger, and the thumb is proportionally short. In all the third phalanx is somewhat thickened, and surrounded by a projecting orbicular border, which, in the thumb particularly, constitutes a delicate ball, supporting the nail. The nails of all the fingers of the hand, as well as of the thumb and the third and fourth finger of the feet, are triangular, and represent a delicate compressed scale: on the index and middle finger of the feet they are erect, sharp, compressed, slightly curved, and not inaptly compared by Mr. Fischer to the thorns of a rose-bush, constituting one of the essential characters of this genus. The body is handsomely formed, and, as in the other species, somewhat contracted towards the pelvis; the lower extremities also have in general a similar character, but the tarsus has less of the extravagant length which is common to the other *Tarsii*.

The tail has nearly the length of the body and head taken together; it is somewhat thicker at the base, nearly naked two-thirds of its length, but covered towards the extremity with a soft down, which forms, near the tip, a very obscure tuft. The fur is remarkably soft to the touch; it is composed of a thick and very delicate wool, which envelops the body, head, and extremities, forming a coat of an unequal surface, from which irregular straggling hairs project; at the root of the tail, and at the hands of both extremities, it terminates abruptly in the form of a ring. The general colour is brown, inclining to grey; on the breast, abdomen, and interior of the extremities it is grey, inclining to whitish: a rufous tint is sparingly dispersed over the upper parts, which shows itself most on the head and extremities: the naked parts of the tail near the root are considerably darker than the extremity. (*Zoological Researches in Java.*)

Locality.—Dr. Horsfield obtained this animal in Banca, near Jeboos, one of the mining districts, where, he says, it inhabits the extensive forests in the vicinity.



Tarsius Bancanus. (Horsf.)

M. F. Cuvier remarks that the dentition of the *Tarsier* approximates the animal more to the *Galeopithecus*, and even to the bats, than to the *Quadrupana*. The bones of this genus are well represented in the excellent *Osteographie* of M. de Blainville.

TARSUS, now TERSOOS, a town on the Cydnus, situated in Itshili, a division of Caraman, and formerly one of the chief towns of Cilicia. It is about twelve miles distant from the sea, and is in 37° N. lat. and 34° 50' E. long. The traditions about its origin are various. It has been supposed to be the Tarshish of Scripture, but neither Bochart nor Vincent (*Commerce of the Ancients*) countenances this conjecture. Stephanus Byzantinus (v. *Tapóς*) says it was founded by Sardanapalus (see the inscription on the tomb of that monarch, Strabo, 672, ed. Casaub.). Ammianus, l. xiv., c. 28, and Solinus, *Polyhist.*, c. xli., assert that Perseus was the founder (Lucan, iii. 225), and the name Tarsus has been derived from the fable that his horse Pegasus lost a hoof (*Tapóς*) there. (Dionys. Perieget., 868, et seq., and for other fanciful derivations see Stephanus Byz.) Strabo relates that it was a settlement made by those who accompanied Triptolemus from Argos in his quest of Io (p. 750, ed. Casaub.). The first historical notice of Tarsus after this is in Xenophon, *Anab.*, i. 2), who describes Tarsus as a great and flourishing city when it was taken and plundered by the younger Cyrus, who afterwards concluded a treaty with Syennesis, king of Cilicia, who had his palace there.

We learn from Curtius (iii. 4), that Alexander the Great

arrived at Tarsus just in time to save it from the Persians. In later times the inhabitants, a party of Julius Cæsar, in honour of whom they name Juliopolis; they were in consequence seized by Cassius, and rewarded afterwards by who made Tarsus a free city. (Dion, 47, 342 Hamb., 1750.) Tarsus enjoyed the favour of whose tutor Athenodorus, a Stoic, was a native place, and persuaded the emperor to release his men from all taxation. (Lucian, *Macro.*, 21, 1839.) Athenodorus, returning to his native place, expelled a troublesome faction, at the which was Boethus, an unprincipled demagogue modelled the constitution. (See Strabo, p. 674, some curious details.) He was succeeded in his government by Nestor, an Academician.

Tarsus continued to flourish under the emperors whom it assumed the several titles—Hadriana, Antinopolis, Macriniana, Alexandriana, Drinopolis, and finally, in the time of Valerian, Severiana, Antoniniana. (Eckhel, *Doct. Vet.*, I sus.) The Tarsians, according to Strabo, for quickness of repartee and every kind of ready their schools of philosophy were not less celebrated those of Athens and Alexandria. The chief Stoics were the two Athenodori; among the Epicureans, Nestor. Athenæus (v., 215, ed. Casaub.) Lysias, an Epicurean, who was tyrant of Tarsus time. The coins of this city inform us of its relation to Cilicia and the adjacent provinces. The inscription ΚΟΙΝΟΣ ΚΙΑΙΚΙΑΣ, on a decastyle temple; ΚΟΙΝΟΝ ΕΠΑΡΧΙΟΝ, referring to the games common to three provinces of Isauria, Caria, and Lycaonia, found in Mionnet, *Recueil des Médailles*, iii. 1, a metropolis appears from an inscription on a coin ΤΡΟΠΟΛΕΩΣ ΤΥΧΗ, and from the testimony of Appian's statement that it was a free city is confirmed by the title ΕΑΙΥΟΕΡΑ. St. Paul was a native (Acts, xvi. 37; and xxii. 25-28.) Other inscriptions occur on the coins of Tarsus, of Septimius Severus there is ΣΕΒΗΡΕΙΑ ΟΑΝΕΙΚΙΑ, recording his victory over Pescennius Cilicia. Jupiter Nicephorus, Apollo, Hercules, and several of his labours, Perseus with the harp, are types, and confirm the testimony of Dion Chrysostom (Orat., 33, 20), who mentions these among the ornaments of the place.

The figure of Triptolemus, the reputed founder of the city, occurs; and the name ΒΟΗΘΟΥ, referring perhaps to a demagogue of that name. The imperial series extends as low as Gallienus, and contains some silver coins of the great wealth and importance of Tarsus. Synecdemus of Hierocles, Tarsus is placed in the Cilicia Prima, and styled Metropolis; Constantine Phrygennetus (lib. ii., *Them.* 13) places it in the Cilicia Prima, and adds, that it was an important city of the Arabs. It had been seized by them during the times of their empire, and had been strongly fortified by Harun al Rashid, whose son and successor Al Mansur was buried there, A.D. 833. It was recovered by Leo Phocas, the successor of Constantine Porphyrogenitus, after a great resistance. (Leo Diacon., iv. 3.) Haukal, an Oriental geographer, who wrote in the 10th century, thus describes it:—'Tarsus is a city, with a double wall of stone. The inhabitants are valiant men, horsemen, and fond of warlike achievements. It is a strong and pleasant place. From it to the city of Roum are many hills and mountains of difficult ascent. They say that in Tarsus there are above a thousand men; and in all the chief cities of Islam, such as Bagdad, Kirman, and Pars, and Khuzistan, and Irak, and Egypt, there are inns, or public places, appointed for the people of this town.' (Ouseley's Translation.)

Tarsus was afterwards retaken by the Arabs, but was wrested from them by the Crusaders, under the command of Tancred, the nephew of Boemond, who resisted the conquest to Baldwin, afterwards count of Edessa. (de Noyet, *Histoire de la Première Croisade*, Guizot, *Mém. relat. à l'Hist. de France*, ix.) W. Tyre describes it at this time as a metropolis of Cilicia, with suffragan towns, and a population of Greek Armenians, much oppressed by the Arabs. Al-Belkhi says that it was populous, and well fortified.

century Benjamin of Tudela speaks of it as the the Greek empire (i. 58, Asher's transl.); and in tenth, during the caliphate of Mostazem, the Arabs ed to recover Tarsus, but failed. (Abulpharagius, ed. Pococke, Oxon., 1673.) It was finally taken ummed II., in 1458. (Von Hammer's *Geschichte nischen Reiches*, ii. 35.)

ew remains of the antient city of Tarsus exist: at 1-west end of the antient town is part of an old and near it a very large mound, apparently arth a flat top, from which is an extensive view djacent plain: on an eminence to the south-west uins of a spacious circular edifice, probably the m. Lucas, who visited it in 1704, only noticed rription, which he gives (i. 271-2, Amster., 1714). probable situation of the tomb of Julian, see *Western Asia*, 88, &c. On a rock three or four from Tarsus is a fortress, called the Castle of Kazalu, the port of Tarsus, is now about twelve tant, and is closed up by a sand-bar. (Beaufort's *Caramania*, 276.) The population of Tarsus is 100, chiefly Greeks and Armenian Christians, by a Moosellim: its site is unhealthy. For nformation, see Michaud and Poujoulat's *Corre-e d'Orient*, vii., 146.

A'GLIA, NICHOLAS, a learned Italian mathe-who was born at Brescia about the beginning of nth century. When he was six years of age his ho followed the humble occupation of a messen-rier, died, leaving him in indigent circumstances, out education. Even his family name is unknown, which he bore (designating one who stammers) n him in derision by his young companions in nce of an impediment in his speech arising from which he received on his lips from a soldier, e French army under Gaston de Foix relieved a 1512.

count has been transmitted of the means by which obtained a knowledge of the rudiments of science, probable that he owed but little to a preceptor. exertions, aided only by a mind endowed with r of readily comprehending the processes of ma- al investigation, enabled him at length to attain st rank among the geometers of his time. Having veral years as a teacher at Verona and Vicenza, ppointed professor of mathematics at Brescia, and e removed to Venice, where he held the like is death, which took place in 1557.

ia wrote on military engineering and on natural y, but it is on his talents as an algebraist that his cipally rests. In that age it was the custom for cians to send difficult propositions to each other n, as trials of skill; and in the work entitled d *Inventioni Diverse*, which Tartaglia published here are contained some interesting accounts of nstances connected with the algebraic questions had received and answered. Among these are gations relating to equations of the third degree; olutions of two cases, in which both the second powers of the unknown quantity are involved, i to have been discovered in 1530, on the occa- sion proposed by a person who kept a school. : Tartaglia states also that, in the year 1535, he the solutions of two equations, in which the first powers of the unknown quantity enter without d, while preparing himself for a public contest nia Maria Fiore, who then resided at Venice, had challenged him to a competition, in which to solve as many as he could of thirty questions posed by the other. It is added that Tartaglia, urs, answered all those of his opponent without one solution from the latter in return.

Cardan, who had been informed of the disco- artaglia, applied to the latter for the solution of uestions which he proposed, in the hope of ob- om him a knowledge of the processes which he in obtaining the roots of equations of the kind oned. The application was made at first through er, and afterwards by letter; but Tartaglia, who, ssession of his secret, enjoyed great advantages ther mathematicians of the time in resolving the which were proposed to him, declined making ication by which his method might become

publicly known. Though disappointed in these attempts, Cardan soon afterwards succeeded, by a promise of intro- ducing him to an Italian nobleman, who had the reputa- tion of being a great patron of learned men, in inducing Tartaglia to make a visit to himself at Milan: the latter, while there, yielded to the entreaties of his host, and hav- ing exacted a promise of inviolable secrecy, gave him a key to the rule which he had discovered. Cardan imme- diately found himself embarrassed with what is called the

irreducible case, in which the expression $\frac{1}{4}Q^2 - \frac{1}{27}P^3$ [Ir-

REDUCIBLE CASE], entering into the value of the unknown quantity under the sign of the square root, is negative, and he applied to Tartaglia on the subject: the latter however declined giving a direct answer to his inquiry, being himself unable to conquer the difficulty; in fact the solution of the equation in this case is even now usually obtained by the aid of trigonometrical functions.

In the work of Tartaglia above mentioned there is an account given of a dialogue which took place in 1541 between himself and a Mr. Richard Wentworth, who then resided at Venice, and to whom it appears that Tartaglia had given lessons in mathematics. On being pressed by that gentleman to give him the rules for the solution of equations containing the second and third powers of the unknown quantity, the Italian mathematician declined doing so, on the plea that he was about to compose a work on arithmetic and algebra, in which the rules, he said, were to appear.

In 1545 Cardan published his work entitled '*Ars Magna*,' and, in direct violation of his solemn promise, gave in it the rule for the solution of the cubic equation containing the first and third powers of the unknown quantity. He does not assert that he is the discoverer of the rule, but observes that it was first found out about 30 years previously by Scipio Ferreus, of Bologna; and adds that it had since that time been independently discovered by Tartaglia. The publication of this work produced, as might be expected, the most animated remonstrances from the man who thus felt himself seriously injured and aggrieved: Tartaglia however revenged himself in no other way than by sending challenges to Cardan and his disciple Lewis Ferrari, to hold with him a disputation on mathematical subjects, by which the public might be judges of their several merits. The discussion actually took place in 1549, in the church of Santa Maria, in Milan, between Tartaglia and Ferrari; but during the sitting, on the former pointing out an error which had been committed by Cardan in the solution of a problem, the people, who appear to have taken the side of their townsman, excited a tumult, and the assembly broke up without coming to a decision. Tartaglia has received no more justice from posterity than he experienced from his cotemporaries, and the formula for the value of the unknown quantity in such equations is still designated Cardan's rule. It must be admitted however that Cardan was the first who published its demonstration.

The works of Tartaglia, all of which were published at Venice, are—'*Nuova Scienza*; cioè *Invenzione nuovamente trovata, utile per ciascuno speculativo Matematico Bombardiero*,' &c., 1537: this is a treatise on the theory and practice of gunnery, and it was translated into English in 1588. '*Euclide, diligentemente rassettato*,' &c., 1543: this is said to be the first Italian translation of Euclid. '*Archimedes Opera emendata*,' &c., 1543. '*Quesiti ed Inventioni Diverse*,' 1550: this is the work above mentioned, and it is dedicated to Henry VIII. of England: it contains the answers to questions which had been proposed to Tartaglia concerning mechanics and hydrostatics; and to one of the books there is a supplement concerning the art of fortifying places. '*La Travagliata Invenzionc, ossia, Regola per sollevare ogni affondata Nave*,' &c., 1551; '*Ragionamenti sopra la Travagliata Invenzione*,' 1551; '*General Trattato de' Numeri e Misure*,' 1556-1560; '*Trattato di Aritmetica*,' 1556; '*Descrizione dell' Artifiziosa Macchina fatta per cavare il Galeone*,' 1560; '*Archimedis de Insidentibus Aquæ Libri duo*,' 1565; '*Jordani Opusculum de Ponderositate*,' 1565. A collection of his principal works was published in 1606.

TARTAN. [WEAVING.]

TARTAR. [POTASSIUM.]

TARTARIC ACID. This acid was first obtained in a separate state by Scheele; it exists in several vegetable

products, but principally in bi-tartrate of potash, which is usually called *cream of tartar*, a salt which is deposited from wine.

The tartaric acid of this salt is obtained first by converting the excess of it, one half of it, into tartrate of lime by the addition of chalk, and the other half into the same salt by means of chloride of calcium; the resulting tartrate of lime is decomposed by sulphuric acid, by which sulphate of lime is precipitated, and the solution of tartaric acid thus obtained by single elective affinity and decomposition is evaporated, and crystals of the acid are deposited on cooling.

The properties of tartaric acid are, that it is colourless, inodorous, and very sour to the taste; it occurs in crystals of a considerable size, the primary form of which is an oblique rhombic prism; it suffers no change by exposure to the air; water at 60° dissolves about one fifth of its weight, and at 212° twice its weight; the solution acts strongly on vegetable blue colours, turning them red, and it becomes mouldy and decomposes when long kept; alcohol dissolves it, but more sparingly than water. The crystals, when heated a little above the boiling-point of water, melt into a liquid, which boils at 250°, leaving on cooling a semi-transparent mass, which is rather deliquescent; if it be more strongly heated in a retort, tartaric acid is decomposed, and converted into pyrotartaric acid, accompanied with some other products. When very strongly heated in the air, a coaly mass is procured, which is eventually dissipated. Sulphuric acid acts upon and decomposes tartaric acid, with the production of acetic acid; by means of nitric acid it also suffers decomposition, and a portion of its carbon, by acquiring oxygen from the decomposed nitric acid, is converted into oxalic acid.

Solution of tartaric acid acts with facility upon those metals which decompose water, as iron and zinc; it combines readily with alkalis, earths, and metallic oxides; and these salts are called *tartrates*. For an account of the more important of these we refer to the respective bases. Tartaric acid has a remarkable disposition to form double salts, one of the most distinct and remarkable of which is the tartrate of potash and soda, which has long been employed in medicine under the name of Rochelle Salts.

Tartaric acid free from water, in which state it may be obtained by exposure to a heat of 302° in an oil-bath for some time, consists of

Two equivalents of hydrogen	2	or	3
Four equivalents of carbon	24	„	36.4
Five equivalents of oxygen	40	„	60.6
	—		—
Equivalent	66		100

It is insoluble in cold water.

In the crystallized state it consists of—

One equivalent of anhydrous acid	66	or	88
One equivalent of water	9	„	12
	—		—
Equivalent	75		100

By the action of heat, so as partially to decompose it, tartaric acid is converted into tartrelic acid and tartrallic acid, which are not of sufficient importance to require description.

Tartaric acid is largely employed as a discharge in calico-printing, and for making what are called sodaic powders, which are extemporaneous imitations of soda-water.

TARTARIC ACID is entirely confined to the vegetable kingdom, and is found free or uncombined in tamarinds, in the unripe grape, and in pepper; and in combination in tamarinds, ripe grapes, gooseberries, mulberries, squill, dandelion, chenopodium vulvaria, in various species of pines, and as tartrate of lime in the fruit of the *Rhus typhina*. For medical purposes it should be remarkably pure, when it is without odour, but makes a powerful acid impression on the organs of taste. In small doses, properly diluted, it acts as a refrigerant, and is of much value in fevers, particularly mucous, and in biliary remittents. It excites the appetite of persons in whom the stomach is in a healthy condition; and those who, by long indulgence in stimulating food and drinks, experience loss of appetite, painful digestion, constipation, with a yellow and altered countenance, and diminished muscular power, find in tartaric acid a remedy of singular power. For this state of system a few crystals should be dissolved in two small tumblers, and drank in the morning fasting, an hour intervening be-

tween the tumblers. A few grains are sufficient to excite the tumbler, as when made too strong it excites the system in a distressing way, so that patients should not continue its use. This plan has in many cases been claimed by individuals addicted to habitual intemperance, which they have recourse to relieve a pain in the stomach, which is sinking and craving of the stomach, which is removed by the acid draught. This is also an attack of *delirium tremens*.

Tartaric acid enters the circulation, and is excreted through the whole body, and may be recouped in the urine, generally in combination, often with lime. Tartaric acid is much used to decompose alkaline calicoes, form effervescing draughts, the employment of which requires caution. [ANTACIDS.]

TARTARS, or, more correctly, **TATARS** (Kiptshak). The name Tatars once designates a great number of different nations in Middle Asia and Northern Europe, which, according to general opinion, have a common origin. Careful research however in history, language, and ethnographical relations shows that the name of Tatars never designated a single race, although it was at first restricted to a certain one among which there was no difference of race. It has ever gradually become a collective name, and has comprehended different nations of Mongol, Chinese, and even Finnish origin. The numerous errors and contradictions in the earlier historians who have written on this subject can only be cleared up by going to the historical origin of the name of Tatars.

As early as the beginning of the ninth century the Chinese knew a people called *Tata*, who lived in the north and south-east of the lake of Baikal, toward the part of the river Amur. They were also called *Tatars* by the Chinese pronunciation of Tatar, and they were identical with the *Taidjod* of the Mongol history, and the *Setsen*. In the middle of the tenth century they divided into three tribes, the *White*, the *Wild*, and the *Water Tatars*, the last of which lived about the mouth of the Amur, and were subject to the *White Tatars* (*Yessugay*), the father of Genghis Khan, a *Water Tatar*, subdued the *White Tatars*, in the twelfth century. He then united the *Wild* and other tribes of his race; and his son Genghis Khan united these warlike nations, the general name of which has been *Bede*, the name of *Köke-Mongol*, or *Blue Bold*, or the *Celestial Mongols*. A circumstance made the change of their name to *Tatars* in his subjects. The word *Tatar* signifies in Chinese language 'a tributary people,' and, in consequence, not being agreeable to nations which had not to be tributary, but boasted of the noble title (*Sánang Setsen*, *History of the Eastern Mongols*, Schmidt, p. 71, and notes 21 and 22; *Pallas Historischer Nachrichten über die Mongolischen Völker*, vol. ii., p. 429; Schmidt, *Forschungen über die Völker Mittel Asiens*, p. 59.)

When Genghis Khan sent his son *Tushi Khan* to the west, all the Turkish nations which were situated in Middle Asia, from the sources of the Amur to the Caspian, were subjugated, and thus became Tatars, the subjects of the Mongol empire. Eastern Europe was not bitten by other Turks and numerous nations of the same race, shared their fate; the tributary nations were obliged to fight under a Mongol chief; and the latter soon gained the ascendancy, because the great majority of Mongol subjects. In the thirteenth century the Mongols made their first invasion of Russia, which they generally called *Tatars*; and when *Batu Khan*, the grandson of Genghis Khan, after having laid waste Russia, appeared on the frontier of Germany, the emperor *Ricard II.* summoned the princes to rise against him. The battle of *Wahlstatt*, or *Liegnitz*, was fought on the 9th of April, 1241, in which the Mongols, a defeated and feeble army of Poles and Germans, were struck with the heroic resistance of the Teutons, that they did not advance any farther. This battle was some time generally called the *Tatar Battle*; and the names of the Russian nobles who survived that day had and have in their armorial bearings; and another name, *Tatar*, knight, whose descendants are still living, has

commemoration of the day; but his new name is not Tader. A further proof of the great preponderance of the tributary nations over the Russians, that an army of 660,000 men, with which Batu crossed the Ural country, contained 500,000 Mongols; while 500,000 belonged to the Finnish, and Slavonic nations. (Hammer, *Ueber die Goldenen Horde in Kiptschak*, p. 114, *Arabsin*, iii., p. 275.)

Well-known facts, which might easily be augmented, sufficient to prove that the name of Tatars in Europe in its etymological signification; a political signification, and was applied to them were not of Mongol origin; and that it had its ethnographical signification even before it was used in the West. Tatars became a general name for any and all barbarous hordes which invaded Europe from Asia, and thus it appears why in Sweden they were once known under the name of Tattars, and in the duchy of Holstein they are still called either Tattars or by that of Tatars. (Benzelius, *Commentariorum Moysis Armeni*, Stockholm, 1689.)

The correct orthography Tartars occurs as early as the time of the Mongols in Europe, and was probably introduced by superstitious monks and writers, who, struck by the analogy between Tatar and Tartarus, believed to have come from the infernal regions. This is more probable than the opinion that the name was introduced by Saint Louis, who, in a letter to the king of France, about the approaching danger of the Tartars of them in the following terms:—'This diction will always exalt our souls, that in the name of the Tartars either we shall push them into Tartarus whence they are come, or they will be taken into heaven.' (Klaproth, *Asia Polyglotta*, p. 189.) These words rather prove that in King Louis's time the name and its origin were known.

The empire of Genghis Khan had lasted longer, the Mongols would certainly have prevailed over that of the other tributary nations, in the same way as that of the Romans, who planted the names of the Gauls, the Romans, and the Burgundians. But the name of Mongols was not in Europe, and was no longer heard of except in the deserts of eastern Asia. The old name of Tatars was used as a designation of the different inhabitants of the empire of Kiptschak, which was founded by the descendants of Genghis Khan on the frontiers of Asia and here the princes only and part of the nobles were called so by those who were able to perceive the ethnographical difference among the inhabitants of Kiptschak (*Treaties of the Golden Horde*, cited below), but the population was composed of Turkish and Slavonic, of which the former were the more numerous.

Who were under the dominion of the Mongols in the thirteenth century, knew the Finnish tribes by the name and their application of the name of Tatars extended to the Turks of Kiptschak gave rise to the present use of the name. The other nations of Europe were unable to make such distinctions. Thus, for instance, the secretary to the duke of Holstein's embassy to Persia, says, in his 'Travels,' that Moruma (the Oka) was 'the first town of Tartary on the coast of the Caspian Sea, and that at Wasiligröd, at the entrance into the Wolga, began the country of those who are called Tcheremisses.' But Murom is situated at the entrance of the country of the Mordwins, the oldest Finnish tribes known to history, and the name is likewise of Finnish origin. Nevertheless, it is not them Tatars. He observes however that they had a particular character, and resembled the Turks of Kiptschak, nor the Tatar language, an observation which shows that Tatar has here two meanings: it first signifies the inhabitants of the conquered territory of Tartary, and then in a narrower sense the inhabitants of that country.

The name of Tatar is still given to the Turkish tribes of the southern and eastern Russia, and as their name is well known, there is no more reason for dropping it than that of Turks, than there is for refusing to give them their name, and calling them Gauls. It is an important fact that the Tatars call themselves

themselves Turks, and feel highly offended by being called Tatars, a name which in their idiom signifies 'robbers.' This fact refutes the hypothesis of Klaproth, who believes that the subjects of the Mongol empire adopted the name of Tatars as a title of honour, on account of its being the ancient name of the chief tribe of the ruling nation. Klaproth's opinion becomes also entirely untenable if put in connexion with a fact stated by Sherefeddin and Arabshah, who tell us that Timur, who, as a descendant of Genghis Khan, undoubtedly belonged to the Mongol race, in a letter to Báyazid, calls himself a Turk, upbraiding this sultan of the Osmanlis with being a vulgar Turkoman. Can we believe that the subdued nations should have distinguished themselves by an ignoble name of their masters, while these, at the same time, made a boast of that of their Turkish subjects! It must be repeated that the tributary nations were called Tatars by the Mongols and by foreigners, and disliked the name on account of its meaning; and that the ethnographical signification of it was supplanted by the general and glorious name of Mongols. [Turks.]

This account of the origin and the gradual diffusion of the name Tatar is more or less different from those given by Klaproth, Abel Rémusat, and Schmidt, but it is founded entirely on facts the knowledge of which we owe to these authors, and especially to Julius von Klaproth. Besides the above-cited works, the reader may consult Schmidt, in Hammer, *Fundgruben des Orients*, vol. vi., heft 3; Klaproth, *Beleuchtung und Widerlegung der Forschungen des Herrn Schmidt*; Abel Rémusat, *Recherches sur les Langues Tartares*; Abulghasi Bayadurkhan, *Histoire Géographique des Tartars*, Leyden, 1726, 8vo.; Ahmedis Arabsiadae, *Vita et Res gestae Timuri*, ed. Manger, ii., cap. 19; Sherefeddin Ali, *Hist. de Timour Bey*, trad. par Pétis de la Croix, l. v., c. 14.)

The above-mentioned Turkish nations were known in history long before they were called Tatars. Part of them founded the empire of Khazaria, between the Dniepr and the Yaik.

The Khazars, the Ghysser or Ghazar of Moses of Khorene, inhabited in the time of this Armenian author, in the fifth century A.D., the country north of the Caspian Sea; and in the sixth century they penetrated into the countries north of the Kuban and the Black Sea, where they founded a powerful empire. Among the Byzantine historians, Theophanes is the first who mentions them. As early as A.D. 625 they allied themselves with the emperor Heraclius, and in conjunction with him attacked Anushirwan, the king of Persia, and from that time were in continual political intercourse with the Byzantine emperors; who were always anxious to maintain peaceful relations with this people. Contemporary historians state that the Khazars consisted of two principal races: one of them was little, ugly, with black hair, and probably of Finnish origin; the other was tall and handsome, and spoke a Turkish dialect: many other races however were mixed up with them, so that Leo Diaconus justly calls them a 'colluvies gentium.'

(Ouseley, *Oriental Geography of Ibn Haukal*, pp. 185-190; Frähn, *Veteres Memoriae Chazarorum ex Ibn Tostalano, &c.*; *Mémoires de l'Académie de St. Pétersbourg*, vol. viii.; Theophanes, iii. 28; vi. 9.)

Their kings were called Chagan, or more correctly Khaghan, which was the name of the old Mongol kings a thousand years before the appearance of the Khazars. In the time of the emperor Constantinus Porphyrogenitus the Khazarian empire extended in the south to the Black Sea, and contained the northern part of the Crimea, which preserved the name of Khazaria until the thirteenth century, and the island of Taman, then inhabited by Goths; on the Caucasian isthmus it was separated from the Alans by the present river of Manytsh. The western coast of the Caspian Sea belonged to it as far as Derbent in the present country of Daghestan, where they were contiguous to the Arabs. The eastern boundaries of it were probably the river of Yaik or Ural. On the north it extended even beyond Kasan, and on the west it was bounded by the Dniepr. In the eighth century the Khazars made the Russians of Kiev for some time tributary, as well as the Sewerians, the Radiwitshes, the Viatitshes, and other Slavonic nations. Constantinus Porphyrogenitus recommends his son to maintain an alliance with the mighty Khazars, but he severely blames his predecessor Leo, who had assumed the imperial dignity

against the will of the patriarch, and who had crowned his disobedience against the ecclesiastical authority by marrying the daughter of the Khaghan. 'For,' adds this historian, 'the Khazars, far from being orthodox Christians, are no Christians at all, but impious heathens; and Leo was punished for his crime by a carbuncle in his face, of which he died young, after severe sufferings.*' Christianity indeed, although some feeble traces of it appear in Khazaria as early as 740, was not adopted by the majority of the Khazars. On the contrary, their kings were Jews, and many Jews had founded great families in that country.

However strange this circumstance may appear, it is an undoubted fact. According to Frähn, one of the best writers on the Khazars, the religion of Moses was propagated among this people by the Jews, who were expelled from the Byzantine empire at the end of the eighth century. The princes, states Ibn Haukal, were obliged to be Jews, but the nine ministers of the Khaghan might be Jews, Christians, Mohammedans, or heathens, a fact from which we must conclude that there was great toleration in Khazaria. In the subsequent centuries we meet with some Christian princes, such as Georges Tzuda, in 1016, but the Khaghan Cosro (Khosrew), who reigned about 1140, was a Jew who had been converted to the religion of Moses by the rabbi Isaak Sangarus, as is stated by the rabbi Jehudah, in his work cited below, which is dedicated to that king.

(Ibn Haukal; Massudi, in Silvestre de Sacy, *Chrest. Arabe*; Hebelot, *Bibliothèque Orientale*, sub voce 'Khozar'; Frähn; Lehrberg, *Untersuchungen zur älteren Geschichte Russlands*; Karamsin and Bulgarin, *Hist. of Russia*; Müller, *Der Ugrische Volksstamm*; Joh. Buxtorfius, fil., *Liber Cosri*, Basileæ, 1660, 4to. This last book was originally written in Arabic, by Jehudah Levita, and was translated into Hebrew by Jehudah Abn Tybbon, both Spanish rabbis.)

The Khazars were very different from those barbarous Mongol tribes which afterwards invaded Europe. Although many of them led a nomadic life, they were generally settled in villages and towns, which they embellished with magnificent buildings erected by Arabian and Byzantine architects, and the ruins of which still attest their former splendour. Ignorant historians have asserted that neither navigation nor commerce flourished among them, but there are numerous facts which prove the contrary. In the first place, the number of Jews and the toleration that existed in Khazaria may be considered as certain indications of the flourishing state of its commerce. The Khazars were renowned for their fine carpets, which were principally manufactured in their capital, Itel, the present Astrakhan, which was also called Biländsher and Nihilje, Semend, with the surname of Seraï Bann, or 'the palace of the lady,' now Tarku, Old Kasan, and Sarkel, a fortress on the Don, were also commercial towns. Honey, skins, leather, furs, fish, salt, copper of the Ural, were the goods they exchanged in the southern countries for silk, wines, spices, jewellery, which they carried to the inhabitants of the north. Gold and silver vessels, which were fabricated in India in ancient times, have been found in our own days at Perm on the Kama, in the north-eastern corner of Russia. The Wolga with its tributary rivers and the Dwina were the commercial roads by which they communicated with the kingdom of Perm, the Biarmia of the old Scandinavian and Anglo-Saxon writers, and with the Norwegians, who, after having doubled North Cape, anchored in the mouth of the Dwina. This route ceased to be used when the Tatars of Kiptshak stopped all intercourse across eastern Russia, and was not re-opened before the end of the sixteenth century, when Jenkinson, an Englishman, discovered it again. Another road followed the Dniepr as far as Orkha, and, reaching the Duna in the west and the Wolkhow in the north, brought them into communication with the Baltic, and with Julin, the famous city of the Wendes. The Arabs took a considerable part in this commerce, and their presence in these northern regions is attested not only by their geographers, such as Ibn Foslan, Massudi, Shemseddin, and Yakut, but also by numerous Kuffic coins which have been found in Scandinavia, and in

the vast country between the Baltic and the B Caspian seas. In short, in the period from the eleventh century, the Khazars and the A certain commercial routes in Russia, the stages of which were so obvious, that the emperor Porphyrogenitus, overlooking entirely between the upper part of the Dniepr and the the Lovat, believed that the Russians of Ner present Novgorod on the Wolkhow, sailed directly to Kiew on the Dniepr. *De Abn. I.* The present canal system of Russia, which regarded as the realization of an idea of Pet and field-marshal Münnich, is founded on the commercial intercourse which had been carried by the Khazars a thousand years before.

The power of the Khazars in Europe was by Russians in 1016, who made their Khaghan G a prisoner; but in Asia it continued for tw longer, until it gradually sank under the repe of the Pechenegues, the Uzes, the Bulgars, th the Yasses, and their very name had disappe in the beginning of the thirteenth century, cas was overwhelmed by the greatest of all conq ghis Khan. Constantinus Porphyrogenitus, *I trando Imperio*; Nestor; Frähn; Lehrberg; *Acad. Petropolitaneæ*, vol. iii., p. 46; *Mémoir dénie de St. Pétersbourg*, vol. i., p. 527 p. 297; vol. iii., p. 73; vol. viii., p. 377; *Hü schichte des Byzantinischen Handels*; *Moderat ion Économique du Gouvernement de Perm: of Perm*, in Hermann, *Statistische Annalen: the Commerce of Russia*, in Storch, *Gemäde schen Reiches*, vol. iv.; Krestinin, *Geschicht Archangel*; Lelewel, *Nomismatique*, sect. 'Pol way, *Historical Account of the British Tra Caspian Sea*; Hakluyt, *Navigations*, with regi kinson and Chancellor.

Tatars of the Golden Horde, or of Kiptshak. Genghis Khan was carrying his arms into India Batu, his grandson, invaded the west as far as t of Germany, conquered the easternmost part which was inhabited by Slavonic, Turkish, s nations, and compelled the princes of Russia his vassals. One of Genghis Khan's last acts to bestow upon Batu the dignity of a Khan o the western conquests, which formed one of t afterwards five, uluses, or under-kingdoms, int Mongol empire was divided. The new vict, his vast dominions the name of Kiptshak, no Kiptshak, or 'the hollow tree,' which was the warlike Turkish people who lived in the flat, tween the Wolga and the Don, the name of Deshti Kiptshak, or 'the steppe of the hollow narrower signification of this name, which still a district near the mouth of the Terek, most t be confounded with its larger meaning as th pire the frontier of which varied according to success of its inhabitants. A second nam kingdom was that of the Golden Horde, or th Golden Camp, *orbu*, the camp, having been with *ordu*, the horde. In his golden tent, w Great Seraï on the Akhtala, a branch of the t the Wolga, Batu received the Russian princes vassals: Saython, king of Armenia; and Plano Ruybroek (Rubriquis), the ambassadors of king of France, who, while fighting against t medans in Egypt as enemies of Christ, courted ship of heathen Tatars as useful in his rebel Germany. Batu founded the town of Gre capital; Seraï, called afterwards Bag'jis, Crimea; and New Kasan at a short distanc Kasan. He died in 1255.

After the short reign of Sertak and Ulaghj and the youngest sons of Batu, the throne w by their paternal uncle Berke, who seized th in spite of the right of the second and the t his late brother. Berke was the first klan who was converted to the Mohammedan relig showed him self so zealous that he ordered a b be put to death who refused to follow the K happened before 1258, and thus the Islam: the banks of the Wolga and in the snowy des ria. In 1260 Berke sent Noghaï, his great

* Constantinus confounds two of his predecessors. The emperor Flavius Constantius, a great heretic, married Irene, the daughter of the Khaghan, and died in 753; his son Flavius Leo, surnamed Chazarus, on account of his maternal origin, was a still greater heretic, and died in 760, of carbuncles in his face in his thirtieth year. (Bandurius, *Com. in cap. 13. De Arabibus*. Top: Du Camp, *Hist. Byzant. P. I. Familiae ac Stemmata*, p. 124-126.)

ru, the Mongol governor of Persia, who pence, but was defeated on the 19th of in a bloody battle on the banks of the a considerable part of his army drowned in ss the frozen river. It was in the same year olo came to the Golden Camp, where he hole year. Berke, who is generally repre- nce of great merit, and whose influence in s sensibly felt by the Byzantine emperors, and was succeeded by Mengku Timur, a atu. This prince ceded to the Genoese imea, a town which was then one of the here the Tatars used to sell the immense oners that they made in Russia and Poland, e southern nations, and especially to the pt, who there recruited the body of the sent commissioners into all the subject who sold as slaves all who did not pay the imposed upon them by the Tatars. This used such great mischief to the com- Novgorod, that the Germans of Lübeck eatic towns, in order to save their stores, rs with rich presents to Mengku Timur, e Golden Camp in 1269. Mengku Timur ut 1283. His successors, Tuday Mengku , ravaged Hungary and Poland, threatened kept up diplomatic relations with France. , *Mémoires de l'Acad. des Inscript. et B. L.*,

g khan was Toktay, whose reign is im- y respects. Under him, paper-money, an afterwards imitated in Persia, was introduced under the name of Jaw, many years before was known in Europe. (J. von Klapproth, *er Money*; Von Hammer, p. 222.) Toktay ion to the throne to Noghai, above men- ful under-khan of the southern Turks of belonged to the house of Genghis Khan, and ed to Euphrosyna, a natural daughter of the el Palaeologus. The power and the in- hai were so great, that he would perhaps self master of Kiptshak, if jealousy had not his sons and led to a civil war, in which a active part. After a struggle of seven as defeated, and died of a wound in 1295, name to his tribes, who from that time day have been, and are still known e of Tatars Noghais, or Nogay Tartars. who died in the year 1313, abandoned adored idols and the stars, but he never intolerant to other believers. He was atural daughter of his ally the emperor o followed the policy of some other By- ns, who gave their legitimate princesses to es, while they abandoned their natural urks and Tatars, who did not set much ference between legitimate and illegitimate

ccessor of Toktay, a boy thirteen years of Russian princes disobedient: they delayed h of vassalage until the young khan per- red the first of them, Michael, grand-duke appear in the Golden Camp. Michael im- justified himself, and was dismissed with- , but Usbeg seized him some years later, ng punished him for some months, or- e put to death. This happened (in 1319) r after the pope had written a letter to he thanked him for the kind protection ranted to his Christian subjects. (*Mo- tar. Eccles., Append.*, p. 130.) In 1327, rison of Twer having been surprised and y the Russian inhabitants, who were ex- t of national vengeance by their prince liewicz, Usbeg Khan invaded the coun- the inhabitants, expelled Alexander, and arosawicz, prince of Riäsan, to be exe- er also and his two sons were beheaded in death was preceded or followed by the princes more, among whom was Juri Dani- uke of Moscow. Many common people e, and for forty years after this bloody re- as never again disturbed in Russia by any

rebellion against the authority of the Tatars. By a treaty of the 7th August, 1333, the first which was made between the Tatars and European states, Usbeg granted considerable commercial advantages to the Venetians of Azof or Tana. (The treaty is contained in Hammer, *Geschichte des Osmanischen Reiches*, vol. iii., p. 665.) Usbeg's court was brilliant. Although as a Mohammedan he had several wives, he was far from keeping them in that close confinement to which the women of the Oriental nations have always been subjected. Sitting on a silver throne under a golden canopy, and surrounded by his royal children and the nobles of his court, the gallant khan rose when one of his women entered the room, and stepping forwards, took the hand of the unveiled lady and led her to a seat by his side. (Hammer.) One of his daughters was married to Kusun, sultan of Egypt, a native of Kiptshak. Usbeg died in 1340, and his descendants became khans of some Turkish tribes to the east of the Caspian Sea, which are still known by the name of Usbecks.

One of Usbeg's successors, Berdibeg (1359), murdered his old father, strangled his twelve brothers, and assumed the title of 'king of the just, the sublime support of the world and of religion.' He himself was murdered three years later, and with his death the house of Batu became extinct. The reign of all the following khans was short and bloody. Civil wars shook the empire, and Kiptshak was divided for some time into several khanats, the most powerful of which were those of Kasan, of Astrakhan, of the Crimea, and of the Yaïk, each of which claimed the supremacy. At last Mamay was successful in reuniting them for a short time. He made an alliance with Jaghello, the grand-duke of Lithuania, for the purpose of subjugating the different Russian princes, who had become less dependent on Kiptshak in proportion as its strength was undermined by war and rebellion. Dmitri, the grand-duke of Moscow, had just assembled his troops, when, on the 8th of September, 1380, he was attacked in the plain of Kúlikow, by 700,000 (?) Tatars and Lithuanians. (Karamsin, v., p. 31; and all the other Russian historians.) The Tatars were defeated with dreadful slaughter; 200,000 (?) of them were left on the field, and Mamay fled to Kaffa in the Crimea, where he was treacherously murdered. For the first time during a hundred and forty years, a hope of national independence consoled the Russians.

Toktamish Khan, the son of Urus Kkan, who was the founder of the dynasty of the White Horde, avenged the defeat of Kúlikow. In 1382 he took Moscow by storm, burnt the town, and ravaged Russia. He renewed the treaties with the Venetians and the Genoese, and Kiptshak was in a fair way to recover from all its calamities, when Timur, or Tamerlane, the conqueror of Asia, appeared on the banks of the Yaïk. Toktamish was twice defeated by Timur, and in a third battle on the banks of the Kama, north of the mouth of the Bielaya, which happened on the 18th of June, 1391, his whole army was slaughtered. The khan of Kiptshak, however, did not despair: he appeared in the field with a new army, and advanced to meet Timur. The encounter took place near the mouth of the Terek, on the 15th of April, 1395; but notwithstanding their heroic resistance, the Tatars were again defeated, and Timur's host overwhelmed Russia. Seraï and Astrakhan were destroyed, Moscow was threatened, and saved by the interposition of the Holy Virgin, who appeared on the walls (26th of August, 1395), and Toktamish fled to Witold, grand-duke of Lithuania. Meanwhile Timur had left Kiptshak, and his beys, unable to maintain themselves in the hostile country, were driven out in 1399 by some enterprising Tatar chiefs. One of them, Kostlogh Timur, became khan of Kasan, and the others maintained themselves in the Crimea, on the Yaïk, and at Great Seraï, the khan of which assumed the name of khan of the Golden Horde, without having much authority over the others. Encouraged by the divisions among their masters, the Russian princes paid their tribute very irregularly, and ceased to appear in the Golden Camp and to take the oath of vassalage. In 1450 Haji Ghiray was almost independent in the Crimea. From 1462 there were constant wars between the khan of Kasan and Ivan Wassiliewicz, grand-duke of Moscow, who at last conquered the whole khanat, and took the capital, Kasan, in the autumn of 1468. During this time, Casimir, king of Poland, defeated the Southern Tatars, and when the Great Khan of Seraï was bold enough to send ambassadors to Ivan to claim the

tribute which was due, the grand-duke refused it haughtily, cut off the noses of the ambassadors, and sent them back in this state to the Golden Camp. He then allied himself with Mengli, khan of the Crimea, and attacked the great khan, who was defeated, in 1490, at the Oka, and near Azof on the Don. This was the last war between Russia and the Golden Horde. Russia, free from the yoke of foreigners, was master of Kasan; Mengli became an independent khan in the Crimea, and Yaghmurji in Astrakhan. The khanat of Astrakhan was conquered by the Russians in 1544. The khanat of the Crimea, although it became a vassal state of Turkey, existed for three centuries, when it was conquered by Potemkin, under Catherine the Great. Thus the powerful kingdom of Kiptshak, the creation of Genghis Khan, became a province of Russia.

In this long struggle with the Tatars, the Russians were taught to bear chains, and to forge them for other nations. From 1240 to 1440, two hundred and fifty Russian princes went to the Golden Camp and humbly knelt before the majesty of a Tatar king; twelve of them were beheaded. One hundred and thirty noble families of Russia and many of the common people are descended from the Tatars. Many words in the Russian language, several legal customs, various social usages, and articles of dress, several names of weights, measures, and coins, ceremonies at the emperor's court, the knout itself, are of Tatar origin. The influence of the Tatars upon the Russians has never been better characterized than by that bon-mot of Napoleon: 'Scrub a Russian, and you will find a Tatar.' [ASTRAKHAN; CASAN; CRIMEA; TURKEY; TURKS.]

(Hammer, *Geschichte der Goldenen Horde in Kiptshak*; Mohammed Riza, *Asseb u's Seyiâr* (the Seven Planets); *Histoire des Khans de la Crimée*, traduite du Turk par Mirza-Kasem-Bey, 1832, in 4to.; Abulghazi; D'Obsson Krestinin, *Geschichte der Kasanischen Zure*, Petersburg, 1791; Fischer, *Sibirische Geschichte*, Petersburg, 1768; Deguignes, *Histoire des Huns*.)

TARTARUS (*Tárapoc*) was, according to the notions of the Greeks and Romans, a part of the lower world, and was inaccessible to the light of the sun and to the winds. Homer describes it as being as far below Hades as heaven is above the earth, and as being provided with brazen gates at its entrance. (*Iliad*, viii. 13, &c., 481.) He further regards it chiefly as the place in which the gods were punished. Hesiod entertains on the whole the same idea, but he adds that Tartarus is surrounded by a brazen wall and triple night; the roots of the earth and the sea hang down into it. It is the prison of the Titans. (Hesiod, *Theog.*, 720, &c.) In later times Tartarus designated that part of the lower world in which the shades of the wicked were punished (Plato, *De Re Publ.*, p. 616; Virgil, *Æn.*, vi. 543), and the ideas then formed of it were more awful than in earlier times. According to Virgil's description, which we may take as an example of the later ideas, the road into the lower world was divided at a certain point into two roads, the left of which led into Tartarus, which was surrounded by a triple wall and the fiery river Phlegethon, and was closed with an adamant gate. At its outer side Tisiphone kept watch, and at the inner side the fifty-headed hydra. Rhadamanthys was the judge in Tartarus, and at his command the Furies scourged the shades of the wicked. Tartarus was twice as far below the earth as heaven above it.

Tartarus was also the name of a small river in Gallia Transpadana, which is now called Tartaro. It was connected with the Padus and Athesis by the Fossae Philistinæ.

TARTARY, or more correctly TATARY. This name was in former times given by the European nations to the country of Kaptshak or Kiptshak [TARTARS], or the three Khanats of Astrakhan, Kasan, and the Crimea [ASTRAKHAN; CASAN; CRIMEA], the last of which had the special name of Little Tatar. [TURKEY.] Great Tatar, on the contrary, designated the vast country between the Caspian Sea on the west, the desert of Gobi on the east, Siberia on the north, and Persia, Afghanistan, and Tibet on the south. The greater part of it has now the more convenient name of Turkistan. [TURKISTAN.] The name of Tatar has entirely disappeared from geography, but it occurs frequently in the history of those regions.

(Ritter, *Asien*.)

TARTESSUS. [TARSHISH.]

TARTINI, GIUSEPPE, a name celebrated in the annals

of music, was born at Pisano, on the coast of Istria, in 1692, and educated at the university of Padua, for the profession of jurisprudence; but his love of music triumphed over his graver pursuit, and after some struggles he devoted himself to several adventures of rather a romantic kind, — in which the fighting of many duels, the marrying of a rich man's niece against her uncle's and his father's consent, and his consequent flight to a monastery, where, to the effects of his eminency's resentment, he remained during two years sequestered, may be thus slightly mentioned. He became a professed violinist, and the founder of a school which in after-times boasted of a Nardini, a Vivaldi, a Viotti, and a Baillot among its disciples.

Tartini was also a composer, and his production much extolled by a very competent judge, M. Baillet-Latour, eminent French violinist and good critic: but he is generally known by his writings on the art, among his *Trattato di Musica secondo la vera Scienza di armonia* (1754), a strictly scientific work, is still read with interest and is freely and ably translated and explained in 1774 by Edward Stillingfleet, under the title of 'Principles and Powers of Harmony,' who cleared it of many of its obscurities which D'Alembert justly complained of by his additions and illustrations rendered it enterprising as well as instructive. This Treatise is partly founded on the author's theory of a *Third Sound*, a subject which so long engaged the attention of all writers on acoustics and on which most of Tartini's work is built, that we give an explanation of it nearly in the words of the named translator, or, rather, commentator.

'Two sounds being given on musical instruments, and admit of the tones being held out and strengthened by pleasure, as violins, oboes, horns, &c., a third sound may be heard. On the violin let the intervals *c, c♯, d, d♯, e*, be sounded with a strong bow, and the sounds, represented by the black notes in the following example, will be heard:—

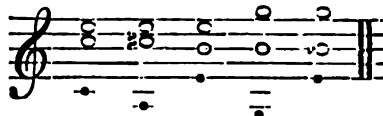

'A similar result will occur if the same intervals be sounded by two players on the violin, distant from each other about 29 or 30 feet; always using a strong bow, and holding out the notes. The auditor will hear the sound much better if stationed exactly between the two instruments. Two oboes will produce the same result placed at a much greater distance.'

'This discovery of the *Grave Harmonics*, as these sounds are called, was made so nearly at the same time by Tartini and Romieu, that both seem to have an undivided claim to be considered as discoverers. M. Romieu, a member of the Royal Society of Sciences of Marseilles, in a memoir which he read before the society in 1774, says: "A New Discovery of Grave Harmonic Sounds, which are very sensibly produced from the union of Wind Instruments."

Tartini died at Padua in 1770. To the *Dictionary of Musicians* we are indebted for what relates to his early life, which work also furnished M. Prony with material for an interesting memoir in the *Biographie Universelle*. In the *Encyclopédie* is an *éloge* by M. Ginguené on the merits of Tartini, in which they are most industriously compared with those of Corelli.

TARTRATES. [TARTARIC ACID.]

TARUDANT. [MAROCCO.]

TASHKEND. [TURKISTAN.]

TASMAN, ABEL JANSSEN, one of the great navigators of the seventeenth century, whose fame is equalled by his merits, owing to his countrymen, though having neglected to make known the important discoveries which he rendered to geography. In the service of the Dutch East India Company he gave such proof of enterprise and ability as to induce Anthony Van Diemen, the most distinguished governor-general who had presided over the affairs of that company, to commission him in 1642, to proceed on a voyage, the object of which was to ascertain the extent of the Australian continent, and the western coast of which discoveries had been made by the various Dutch navigators.

On the 14th August, 1642, Tasman sailed for

nd of two vessels, the Heemskirk and the directing his course first towards the Isle of ere he put in for provisions and water. From France he set sail on the 3rd October, and proth to about 41° S. lat., afterwards to the south-out 50° S. lat., and then due east. Having E. long., he sailed to the north and east, and November discovered, at 10 miles distance, a ich he gave the name of Van Diemen. He ain here long, nor did he meet with any of the t he continued on his voyage, sailing to the and doubled what he conceived to be the xtremity of the Australian continent, or New t that in fact was the southern extremity of Tasmania, or Van Diemen's Land. He made ssful attempt to anchor in a bay, to which he ame of the Bay of Tempests—Storm Bay—on astern coast of Van Diemen's Land; and then orth, where he found secure anchorage in y, to which he gave the name of Frederik y, 42° 52' S. lat., 147° 57' E. long. On the shore a standard, to which he attached the colours of East India Company, and on the 5th set sail favourable winds prevented his surveying, as he d, the north coast, and he therefore bore oposing to visit the Solomon's Islands, of which nt had been given by previous navigators. But , being in about 42° 10' S. lat. and 170° E. and himself in view of a high and mountainous ich he named Staaten Land—land of estates— as New Zealand. Tasman supposed this land f the continent of Australia. He sailed along wards the north-east, and on the 17th anchored ce of what he concluded to be a great bay. from the shore approached in their canoes, nained at a distance, and refused to come on r of Tasman's vessels, although every amicable on was exhibited by the crews. Gathering con- ver, they afterwards came in large numbers, el ensuing between them and the Dutch, three l murdered. The bay in which this happened e name of Mordenaars' Bay, or Murderers' Bay at., 173° E. long.). Tasman did not revenge the en, but, availing himself of a favourable wind, ing followed however by two and twenty canoes s armed, he fired among them, killed one or , and drove the rest on shore. He did not make s owing to the variableness of the weather, and to anchor again in a bay to the east of Mas- rderers' Bay which yet preserves his name— ay (about 41° S. lat., 173° 30' E. long.). When resume the voyage, he continued his course east, bearing northwards, until, on the 4th 43, he found himself in a situation in which the e current bearing to the west, and the swell- vaves, which bore to the north-west, led him to at the sea in that part afforded a free passage. he perceived a group of small islands which he Three Kings (in about 34° 3' S. lat., 172° . . . Those islands were inhabited, but the vio- e waves prevented all intercourse with the asman now resolved to sail to the east, and to the north as far as 17° S. lat., and then : towards the isles of Cocos (15° 50' S. lat., 7. long.), and of Hoorn (14° S. lat., 178° 20' with a view of obtaining some fresh pro- me of these islands. On the 6th January he nd to the south at three miles distance, but given to it. On the 8th, being, as he represents, and 174° E. long., the force of the waves which i the south-east suggested to him that he to look for land in that direction; he there- d his course to the north, and on the 19th an island which he called Pyllstaart (22° 22' ° W. long.). On the following day he saw islands, and on the 21st approached the more hich he named Amsterdam, the native name ra Taboo (21° 30' S. lat., 175° 20' W. long.); Middelburg, the native name being Eoa, the of Cook (21° 24' S. lat., 175° W. long.). ers brought various fruits in their canoes, and s described them as uniting courage with While here he discovered some other isles,

before one of which he anchored, naming it Rotterdam, the native name being Ana Moka (or Annamooka, 20° 15' S. lat., 174° 31' W. long. Captain Cook, when he visited these islands about a hundred and fifty years afterwards, found the tradition of Tasman's visit preserved among the natives.

On the 1st of February Tasman discovered the islands of Prince William, but his provisions being nearly exhausted, he could not stay to visit them. For several days subsequently the sky was so cloudy as to prevent his ascertaining the situation of his vessel, and when fine weather partially returned, he judged it best to sail towards 5° S. lat., and then to bear towards New Guinea, apprehending the return of unfavourable weather, in which he might be cast upon an unknown coast. By the 22nd of March he was in 5° 2' S. lat., and having the advantage of clear weather and the east trade-winds, he soon came in sight of a cluster of islands which had been visited by two navigators, Schouten and Le Maire, and by them named Ontong Java. On the 29th he sailed past the Green Islands (4° 53' S. lat., 154° 50' E. long.), and on the 30th the Isle of St. John (3° 50' S. lat., 153° 50' E. long.). This island, he says, appeared to be well cultivated, to abound in flesh, fowl, fish, and fruit, and to have a numerous population. Schouten having before sustained some injury from the natives, Tasman did not attempt to land. On the 1st of April he was in sight of what he supposed to be New Guinea, but in fact of New Britain, and shortly after he doubled the cape to which Spanish navigators had before given the name of Cabo Santa Maria—Cape St. George of Dampier (5° S. lat., 152° 15' E. long.). The crew were suddenly awoke on the night of the 12th by what resembled the shock of an earthquake: the situation of the vessel at the time, as Tasman states, being 3° 45' S. lat. They sounded, supposing that the ship had struck, but could find no bottom. Several shocks, each less violent, succeeded. On the 20th they were near to Brandande Yland, or Burning Island, which had been mentioned before by Schouten: on the 27th they were in sight of another island, which he calls Jama, a little to the east of Moa (8° 21' S. lat., 127° 45' E. long.), where they obtained cocoa-nuts and other fruits. Tasman has described the inhabitants as absolutely black, and speaking a copious language, in which the frequent repetition of the letter *r* is noticed. He anchored on the following day at the Isle of Moa, where he was detained for eight days by unfavourable weather. The Dutch carried on an interchange of knives for cocoa-nuts and Indian figs with the natives. On the 12th of May he coasted the island to which Schouten had before given his name (50° S. lat., 136° 20' E. long.), and which is described as fertile and populous: the natives gave proof of their commerce with different Spanish vessels by the production of various articles which they had received in barter. Having now fulfilled his instructions, Tasman directed his course back to Batavia, where he arrived on the 15th June. A map of his discoveries was sent to the Stadt House at Amsterdam.

The success of this voyage induced Van Diemen to commit to Tasman the command of a second expedition, the objects of which are set forth in the instructions given by the governor-general on the occasion. These instructions are printed in the introduction to Flinders' Voyages. After quitting Point Turc, or False Cape, situated in 8° S. lat., on the south coast of New Guinea, he was to continue eastward along the coast to 9° S. lat., carefully crossing the cove at that place, looking about the high islands or Speults River with the yachts for a harbour, despatching the tender De Braak for two or three days into the cove, in order to discover whether within the great inlet there might not be found an entrance to the South Sea.* From this place he was to coast along the west coast of New Guinea (Carpentaria) to the farthest discoveries in 17° S. lat., following the coast farther, as it might run westward or southward. It was feared that he would meet in those parts with the south-east trade-winds; from

* The great inlet or cove where the passage was to be sought, is the north-west part of Torres Straits. It is evident that a suspicion was entertained in 1641 of such a strait; but that the Dutch were ignorant of its having been passed. The 'high islands' are those which lie in 10° S. lat. on the west side of the straits. Speults river appears to be the opening between the Prince of Wales Island and Cape York; through which Cook afterwards passed, and named Endeavour Strait. (Flinders' Voyages, 'Introduction.')

which it would be difficult to keep the coast on board, if he stretched to the south-east; but notwithstanding he was by all means to endeavour to proceed, that it might be ascertained whether the land was divided from the great known South Continent or not. These instructions were signed in 1644, 29th January, by the governor-general, and two vessels—the Zeehaan and the Braak—were placed at Tasman's disposal. But of the results of this second voyage absolutely nothing is known with certainty; nothing was ever published. 'It seems to have been the general opinion,' says Flinders, 'that Tasman sailed round the Gulf of Carpentaria, and then westward along Arnhem, and the northern coast of Van Diemen's Land; and the form of those coasts in Thérénot's charts of 1663, and in those of most succeeding geographers, even up to the end of the eighteenth century, is supposed to have resulted from this voyage. This opinion is strengthened by finding the names of Tasman, and of the governor-general, and of two of the council, who signed his instructions, applied to places at the head of the gulf; as is also that of Maria, the daughter of the governor, to whom Tasman is said to have been attached. In the notes also of Burgomaster Witsen, concerning the inhabitants of New Guinea and Hollandia Nova, as extracted by Mr. Dalrymple (*Collection of Voyages*), Tasman is mentioned as among those from whom his information was drawn.' Of the private life of Tasman nothing is known, neither when nor where he was born or died.

An account of Tasman's first voyage is given in the *Collection de Thérénot*, partie iv.; in Harris's *Navigantium atque Itinerantium Bibliotheca*, 1741, fol.; at the end of the *Voyages de Corréa*, tome ii., Paris; in *Terra Australis Cognita, or Voyages to the Terra Australis during the Sixteenth, Seventeenth, and Eighteenth Centuries*, by Calander, Edin., 1766. From these sources, and from the *Biographia Universelle*, tome 45, the substance of this article has been collected. Tasman is not even named in Chalmers, nor in many other universal biographies in the English language.

TASMANIA, more generally known by the name of Van Diemen's Land, is an island and British colony situated in the southern hemisphere, south of Australia. It lies between 40° 45' and 43° 45' S. lat., and between 144° 45' and 148° 30' E. long. It is separated from Australia by Bass's Strait, which washes its northern shore. On the west of the island is the Indian Ocean, and on the east the Pacific. On the south it is washed by that portion of the ocean which connects the two first-named oceans, and extends southward to the shores of the newly-discovered antarctic continent. [SOUTH POLAR COUNTRIES.] From Cape Grim, its north-western extremity, it extends south-south-east to South Cape, a distance of about 230 miles, and this is its greatest length. Its greatest width occurs near 41° 20' S. lat., between Ordnance Point on the west and St. Helen's Point on the east, which are about 100 miles distant from one another. According to a rough estimate, the surface is 24,000 square miles, or about 4000 square miles less than the extent of Ireland.

Coast-line and Islands.—The western coast, beginning on the north at Cape Grim, and extending to South-West Cape, is about 240 miles long. It is less accessible than the other shores of the island, as in general it runs in a continuous line, being only broken by large inlets at two places. The shores are steep, exposed to the prevailing south-western winds, to a strong swell and surf, and without anchorage and shelter. This coast is therefore rarely visited by vessels, and no settlements have been established on it, except at Macquarrie Harbour and Port Davey, where a few convicts are kept to cut wood. The northern parts of this coast, and as far south as Macquarrie Harbour, are in general low, but south of Macquarrie Harbour they are high. South of Cape Grim, which consists of steep rocks of moderate elevation, the coast is formed by low black rocks, which towards West Point sink down to the level of the sea, and in this part there are a few shallow creeks. From West Point, which is formed by a short, low, and sandy projection, to the mouth of the river Arthur, the beach is low and sandy, and behind it extends a swampy level tract, covered with tea-trees to the distance of three or four miles, where the country rises into low hills. At a few places the low beach is interrupted by rocky cliffs. This low coast continues to Ordnance Point, near which is

Jacob's Harbour, which is accessible to boats. At Ordnance Point the coast rises to a moderate elevation, but it is frequently interrupted by low and sandy tracts. The shores are overgrown with low bushes. A bay of moderate extent occurs between the mouth of the river Pedder and Sandy Cape, but it is shallow and useless. That part of the coast which extends from Sandy Cape to Macquarrie Harbour is almost unknown, except that it chiefly consists of sandy low shores, without a beach, at the back of which there are hills, some of which attain a considerable elevation. Macquarrie Harbour is a fine sheet of water, extending nearly 25 miles south-south-east, and terminating with two fine basins, Birch's Inlet and Kelly's Basin. It is on an average five miles wide, and affords good anchorage and complete shelter; but near its entrance is a bar, which has only nine feet of water. The harbour is surrounded by wooded hills. Cape Sorell, forming the western side of the entrance of Macquarrie Harbour, is a steep and rocky promontory, and farther south the coastline is high and rocky, and here and there a few rocks project into the sea, but the small bays thus formed do not afford shelter against the swell of the sea, and not even a safe landing-place. At the back of the beach there are steep and lofty hills. Cape Hibbs is formed by a mountain-mass projecting three or four miles into the sea. South of it the coast rises still higher, and between that cape and Rocky Point two hills, which project about two miles from the shores, constitute a harbour, in which small vessels may anchor, but it is open to the west. The high shores continue to Port Davey and to South-West Cape. Port Davey is the best harbour on this coast. At the entrance it is about four miles wide, and it continues at that width about 6 miles inland, when it divides into two branches. That branch which runs northward is called Cockburn, and is about two miles wide and six long; the southern, which runs eastward, does not much exceed a mile in width, but extends more than 10 miles inland, turning at its eastern extremity to the south. These two branches have good anchorage, and afford safe shelter, being surrounded by high hills; but the wide bay, of which they are branches, is open to the westerly winds and the swell of the sea: the anchorage however is good.

The southern coast, between South-West Cape and Whale Head, is about 50 miles long, and runs in a serpentine line, forming several bays, of which a few have good anchorage, as Cox Bight, east of South-West Cape, and the nameless wide bay which lies west of South Cape, and at whose innermost recess is a harbour about five miles long and a mile wide, which has a good entrance, and affords anchorage and shelter, but it has not been regularly surveyed. This harbour is separated from the wide bay by a tongue of land of moderate elevation, on which the sea breaks with a heavy surf. The shores of this coast are in general rocky and high, and constitute the lower declivity of the mountain-masses which extend over this part of the country. Several small islands opposite this coast break the swell of the sea, and as most of them are elevated, they serve as beacons.

The south-eastern coast extends from Whale Head, the most south-eastern promontory of Tasmania, to Cape Frederick Hendrik, about 60 miles in a straight line, but, measured along the shores, it is probably double that extent. It contains a greater number of safe anchorages than probably any other country of the same extent on the globe. There is hardly a mile along this coast-line which does not offer a safe refuge to vessels. This great advantage is owing partly to the size and form of the island of Bruny, which extends along the coast, and partly to two far-projecting promontories, called Ralph's Peninsula and Tasman's Peninsula. The island of Bruny extends about 30 miles nearly due south and north, but it varies greatly in width, as the isthmus of St. Aignan is only a few hundred paces across, whilst the mountain tract south of it is more than eight miles wide. It consists of three isolated tracts of high hills, connected by isthmuses: the most southern of these tracts has the form of a hook, and is connected with the central mountain-tract by a low isthmus about a mile wide and two miles long, which separates Taylor's Bay from Bad Bay. The central mountain-tract, constituting the main body of the island, is about 15 miles long from south to north, and more than eight miles wide in the broadest part. It is connected with the northern mountain-tract by the isthmus of

an, which is five miles long, and only a few hundred feet wide. It is low and sandy, and separates Isthmus the west from Adventure Bay on the east. The mountain-tract is about 12 miles long, and is indented on the western shore that its average width does not exceed three miles, though in some places it is less across. The mountains of this island do not exceed 1200 feet in elevation: they are covered with wood, and supply numerous streams. Along the side of the island are five harbours, which, from north to south, are called Great Cove or Taylor's Bay, Isthmus Bay, Great Bay, and Burnes Bay. They all have excellent anchorage and shelter, except North Bay, which is rather too large, and exposed to the wind which comes down from the mountains on the island. On the eastern side of Bruni Island are Adventure Bay, Bad Bay, Adventure Bay, and Trumpeter Bay. North Bay is useless, being open to the southern winds, and subject to a very heavy swell, which causes such a treacherous surf at the foot of the rocks which surround the bay that landing is almost impossible. Adventure Bay is to the east, but is so far protected by Tasman's Peninsula, that the inconveniences of this harbour during storms are reduced to a difficult landing. Before the foundation of the colony it was frequently visited by the Dutch.

Trumpeter Bay is of moderate extent. A strait which divides Bruni Island from the mainland is called D'Entrecasteaux Channel, or Storm Bay, and extends 45 miles in a straight line from the head to Pilot Strait, or the narrow arm that divides the northern extremity of Bruni Island from Tasmania. Its entrance between Whale Head and Bruni Head is open to the south and west; but on the western side there are two excellent harbours, Recherche Bay and Mussel Bay. North of Mussel Bay the channel begins, and is 30 miles long, and varies in width from one to three miles. In all its extent it has excellent anchorage and sufficient depth; even opposite Isthmus Bay, where it is narrowest, it is 40 feet deep. Being mostly surrounded by high hills, which shelter it on all sides, it is, properly speaking, an immense harbour, the only inconveniences of which are that it is subject to gusts of wind, and that the bottom consists of an earth somewhat too tenacious. On the shores of the channel, besides several smaller harbours, there are three, or rather four, large and excellent bays: Esperance Bay or Adamson's Harbour; Huon Bay, the extensive estuary of the river of that name, which extends nearly 20 miles inland, and has sufficient depth for large vessels; Port Cygnet, or Swan Port, near the mouth of the Huon estuary; and North-West Bay, which constitutes the most northern extremity of the D'Entrecasteaux Channel, and resembles the harbour of North-West Bay. North-West Bay is two miles wide at its entrance, and extends nearly six miles inland. The low country surrounding this excellent basin is the fertile district of Tasmania in which cultivation has made any progress. The strait leading from it to the Derwent estuary of the river is only one mile wide, and is called Pilot Strait.

North-West Bay, and between it and Tasman's Peninsula is Storm Bay, extending about fifteen miles from north to south, and as much from west to east. It has good anchorage-ground, and is almost entirely open towards the south, though protected on the other sides by high hills. Storm Bay however has two extensive arms of the sea, which open to the north and south, and are respectively called the estuary of the Derwent and Frederick Henry Bay. These two arms of the sea are separated by Ralph's Peninsula, which extends about five miles from north to south; and this distance may be considered as the length of the two arms of the sea, the Derwent advancing a few miles farther into the interior of the estuary is a small rocky point, on which a lighthouse has been erected. The estuary is Ralph's Bay, on the east. This bay is a low sandy spit of land which projects from the side of Ralph's Peninsula, and surrounds the bay from north and west; and by another spit of land which projects to the south. The entrance of Ralph's Bay is a narrow channel, nearly two miles wide, which leads to a bay about eight miles long and three wide, with excellent anchorage and sheltered on all sides. Ralph's Peninsula

consists of two mountainous tracts united by a low isthmus. This isthmus is only half a mile wide, and is the place where Ralph's Bay approaches nearest to Frederick Henry Bay. This last-mentioned bay, which has also the name of North Bay (Baï du Nord) is united to Storm Bay by a channel situated between Ralph's Peninsula and Tasman's Peninsula, which is five miles long and five miles wide. The bay itself consists of three basins, North Bay, Pitt Water, and Norfolk Bay. North Bay, which occupies the centre, is a basin about eight miles long from south to north, and six from west to east. It has good anchorage, with sufficient depth of water, and is generally well sheltered. Along its northern shores there is a low and sandy tongue of land, with an opening at its eastern extremity, which leads to Pitt Water, an arm of the sea extending from east-south-east to west-north-west about eight miles, with an average width of two miles, which branches out into numerous small coves and inlets affording safe anchorage for small vessels, but the entrance has only sufficient depth for them. Norfolk Bay lies to the east of North Bay, with which it is connected by a channel about three miles wide. This bay is surrounded on three sides by Tasman's Peninsula, and constitutes one of the finest harbours on the island: it has excellent anchorage, with a convenient depth of water, and is sheltered by high hills. It is eight miles long, and the width varies from three to five miles. It is free from all danger, and branches out into numerous coves.

Tasman's Peninsula extends about 25 miles from south to north: it consists of two larger peninsulas, of which the southern is properly called Tasman's, and the northern Forestier's Peninsula. Tasman's Peninsula surrounds Norfolk Bay on the south and west: it extends west and east about 15 miles, with an average width of eight miles. The surface of this tract is covered with mountains, which rise with a steep ascent from the water's edge, and are mostly composed of basalt columns, especially between Maingon Bay and Fortesque Bay. On the west side of the peninsula, on the east shores of Storm Bay, is Wedge Bay, which has tolerably good anchorage. Maingon Bay, on the south coast of the peninsula, is quite open, but on the north it leads into a safe harbour, Port Arthur, which runs more than six miles inland, and is more than a mile wide. The high rocky isthmus which divides its northern extremity from Norfolk Bay is only three miles wide. On the eastern shores of Tasman's Peninsula is Fortesque Bay, which is large, and has excellent anchorage, but it is open to the east. Pirates Bay, farther north, is still more open: it is separated from Norfolk Bay by an isthmus called Eagle Hawk Neck, which is only 600 feet wide and 700 feet long, and which connects Tasman's Peninsula with Forestier's Peninsula. It is low and sandy. Forestier's Peninsula extends 10 miles from south to north, with an average width of seven miles: it is a roundish mass of high rocky mountains, scantily covered with low trees, and it has a sterile soil. The high rocky masses along its eastern shores run in a continuous line. On the north side of the peninsula is Frederick Hendrik Harbour, in which Tasman anchored in 1642: it has good depth, but is open, and along the southern side it is lined with shoals and rocks. The isthmus which joins Forestier's Peninsula to the mainland of Tasmania is called East Bay Neck, and the northern portion of Norfolk Bay is also known by the name of East Bay: it is about two miles long, and half a mile wide in the narrowest part: it is low and sandy. The bay which extends between this neck and the most northern portion of Forestier's Peninsula, and is called Blackman's Bay, is spacious and well sheltered, but beset with shoals and rocks, especially along the southern shores and its entrance, so as to admit only small vessels.

The eastern coast of Tasmania extends from the northern extremity of Forestier's Peninsula to Cape Portland on Bass's Strait, more than 150 miles in a straight line. The southern part, or that south of 42° S. lat., resembles in some degree the south-eastern coast: it contains many places of refuge for vessels, though in general they are much less numerous than on the south-east coast, and not quite so safe and commodious. The wide bay on the north of Forestier's Peninsula, from which a channel leads to Blackman's Bay, has a flat sandy shore, no which the sea breaks with a heavy surf, so as to render it inaccessible, but towards the north are several small coves for boats. Cape Bernier is formed by a high conical hill: between it and

Prosser's Bay the coast is high and rocky, except at Sand-spit, where it is low, and forms a shallow cove. Prosser's Bay is of good size, being three miles wide at its entrance, and extending in two arms five miles inland. There are several shoals in it, but it has good anchorage, especially in the northern arm. Between Prosser's Bay and Cape Bailly the coast is high, rocky, and well wooded. At Cape Bailly begins Oyster Bay, the largest of the bays of Tasmania: it is 18 miles long from south to north, and 15 miles wide at the entrance, but it narrows gradually towards the north, being at its northern recess 10 miles across. It contains good anchoring-ground, and is tolerably safe, for though it is open towards the south, the island of Maria and several smaller islands in that direction break the swell of the sea. The surrounding country is hilly and well wooded. Near Cape Bailly is Little Swan Port, a moderately extensive basin with a shallow entrance. It admits only boats. The western shores of Oyster Bay are high and steep, and may be approached with safety. On the northern side of the bay is a tongue of land less than a mile wide. It consists of low sand-hills, and terminates on the east at a narrow and shallow channel, which leads northward to an arm of the sea, which winds through a low country for more than 10 miles. This arm of the sea is shallow, and called Moulting Lagoon. The eastern side of Oyster Bay is formed by Vanderlin's Peninsula and Schouten's Island. Vanderlin's Peninsula is nearly 12 miles long, and consists of two masses of rocky mountains, united by a low sandy neck, about one mile and a half long and one mile and a half wide, on which is a small fresh-water lake. To the west of this neck is Refuge Bay, and to the east Thouin Bay. The first is a safe harbour, but the second is open and rather shallow. Another low and sandy neck about three miles long and a mile wide connects Vanderlin's Peninsula with the main body of Tasmania. The mountains of the southern mass of Vanderlin's Peninsula are the highest in the peninsula. Schouten's Island is separated from that peninsula by Geographe Strait, which is nearly three miles long and about one mile and a half wide on an average: there is good anchorage in the strait. Schouten's Island has nearly the form of a square, and extends about four miles in every direction. On its southern side, in Faure Bay, there is anchoring-ground. The island consists of a mass of rock, descending on the east with a steep declivity to the water's edge, but on the west with a gentle well-wooded slope.

South of Oyster Bay is the island of Maria, which is about 12 miles long, and consists of two large masses of rocks connected by a neck of land. The northern mass extends 7 miles from east to west, and consists of elevated mountains, the highest part of which, called the Bishop and Clerk, is about 3500 feet above the sea-level. The declivity of the mountains towards the east is very steep and terminates on the beach; but the slope is gentle towards the west, where it leaves a broad level tract along the sea, which is sandy and scantily wooded. The low sandy neck south of it is only 300 paces across, and about two miles long. On the west of it is Oyster Bay, which is well sheltered and has good anchorage, but is shallow near the land; and on the east of the neck is Reidle Bay, which is deeper, but has a rocky bottom, and is exposed to the easterly and southerly winds. The southern peninsula of Maria Island is one mass of rocks, rather well wooded, which descends towards the east in precipices and towards the west with a gentle slope. The strait which divides Maria Island from the mainland is about five miles wide on an average, and is nearly equal to D'Entrecasteaux Channel in the advantages which it affords to navigation, having good anchorage-ground, and being generally well protected against the winds and swell of the sea. North of Maria Island, towards the entrance of Oyster Bay, is a small island, White Rock, to which seals resort in great numbers.

The remainder of the eastern coast, beginning at Cape Tourville on the south, is as difficult of access as the western coast of Tasmania. In an extent of more than 100 miles not one harbour occurs which can be entered by vessels of moderate size, and even small craft find only three or four places where they can anchor with safety. The coast between Cape Tourville and Eddystone Point is elevated and rocky, and always beaten by a heavy surf. South of Cape Lodi the hills are barren and generally destitute of trees. Farther north however they are still

more elevated, but tolerably well wooded. Between Eddystone Point and Cape Portland the shores consist of a low tract of considerable width: the soil is sandy and of indifferent fertility. The woods which cover it consist of short, crooked trees. This part of the coast is beset with shoals, and cannot be approached with safety.

The northern coast of Tasmania extends from Cape Portland on the east to Cape Grim on the west, and is about 160 miles long in a straight line, but following the coast it measures more than 220 miles. North of this coast is Bass's Strait, at the eastern entrance of which is the group of the Furneaux Islands, which consist of two larger islands, four of moderate size, and many smaller islands. The larger, Great Island, extends 40 miles nearly due south and north, and is on an average nine miles long, so that its surface may be estimated at 360 square miles, or somewhat more than that of the Scotch island of Islay. The interior of the island is mountainous, and the mountains advance on the west side close to the sea, but leave a tract of low ground along the eastern shore, which is sandy and in some parts swampy. South of Great Island is Cape Barren Island, which extends from east to west about 20 miles, with an average width of about five miles. It consists of several isolated masses of rocks connected by low grounds. These islands, as well as the smaller islands, are generally mountainous and rather high; they contain many low tracts of considerable extent, but the soil is sandy, swampy, and in general of indifferent quality. Trees are not abundant, and only of stunted growth. The surface is chiefly covered with thick bushes, coarse wire-grass, and a kind of Chenopodium, the ashes of which may be used in the manufacture of soap. Fresh water is scarce. These islands are always surrounded by great numbers of seals, and are resorted to by many vessels from Sydney and other places. The strait which divides Furneaux Islands from Tasmania is called Banks's Strait. It is 10 miles wide, and contains no hidden dangers, but as the current sets through it with great rapidity from east to west, it is not much used: the vessels that sail to and from Sidney generally pass through Kent Strait, or the middle strait of the three which constitute the eastern entrance of Bass's Strait. This strait is 24 miles wide between Great Island and Kent Group, and is general free from dangers. The western current which runs through it is moderate.

The coast from Cape Portland on the east to Port Dalrymple at the mouth of the river Tamar is low and sandy, with the exception of some sandy hills at and between East and West Double Sandy Points, and the high cape of Stony Head, which consists of elevated rocky masses or grown with grass. The shores are either entirely bare, or covered with short bushes. In a few places there are swamps, and in others some flat and low rocks of stony extent. The bays have in general sufficient depth of water and good anchorage-ground, but being wide and open, they do not afford security against winds and the swell of the sea. The largest is Ringarooma Bay, west of Cape Portland.

Port Dalrymple is the best harbour on the northern shores, though it cannot be compared with the harbours on the south-eastern coast. Before its entrance on the west is the dangerous reef called Hebes Reef, and even in the sea-reach, which is two miles wide and six long, there are some shoals. The navigation is tedious and difficult, but the Tamar is deep enough for large vessels as far as Launceston, 30 miles from Port Dalrymple in a straight line. West of Port Dalrymple the coast is high, being formed by elevated and wooded hills, the highest of which are called the Asbestos Hills. To the west of these hills is Port Sorell, which is rather spacious and has good anchorage, but is difficult of access. Between Port Sorell and Port Frederick the shores are low, and about half a mile from the sea is a narrow lagoon, which occupies more than half of the space between the two harbours. Port Frederick, or the estuary of the river Mersey, resembles Port Sorell. From this harbour to Penguin Point, west of the mouth of Leven river, the coast is generally rocky and high, but intersected by the mouths of several rivers, which however do not admit even boats, except the Leven, which may be ascended by boats to the distance of six miles from the sea. From Penguin Point to Circular Head the coast presents an alternation of high and low shores. The low shores are sandy or swampy, and generally covered with

s, and the high shores present in many places of basalt, the tops of which are covered with a good soil, and overgrown with trees. There is no port for ships on the coast, except at the mouth of the Derwent, where small vessels find good anchorage in the bay. Boats may enter Parish's Harbour, not far from the mouth of the Derwent, to the west, and Pebbly Bay, west of the Derwent, a rather elevated rocky mass projecting into

the sea. The head is a tongue of land projecting into the sea for a distance of about seven miles from the mainland. The northern portion is an undulating table-land resting on a base of basalt, whose surface is covered with bushes and grass, and affords good pasture-ground. The highest point is 450 feet above the sea-level. This table-land is about 10 miles long from north to south, and somewhat more than two miles across in the widest part. It is united to the mainland by a low sandy isthmus nearly three miles long and about one mile wide. On each side of the isthmus is a narrow strip of land, which advances four or five miles into the sea, forming two harbours, called East and West Bay, which have sufficient depth for small vessels. The advanced portion of these two harbours, and the pasture-ground between them, have induced the Van Diemen's Company to fix their chief establishment here. The northern portion of the Circular Head is low and sandy. The southern portion is a swampy tract overgrown with tea-trees, and is intersected by numerous shoals, and though there are several fine embouchures of the rivers, none of them has sufficient depth of water for a boat.

Along this coast-line are the Hunter Islands, a group of three larger and several smaller islands. The largest island, the nearest to the mainland, is divided from the mainland by a narrow strait, Robbin Channel, which is full of rocks, but has good anchoring-ground near the eastern end.

The island is about 7 miles long from east to west, and 5 miles wide on an average. The eastern portion, which is about two-thirds of the whole, is low, and has a soil covered with bushes and small trees: it has a good anchorage. The western district is a rocky ridge, with heath. Three-Hummock Island is about 1 mile long, but it is hilly, and chiefly covered with ferns, or grass. On its eastern side is a cove, which affords a safe anchorage. West of Three-Hummock Island is Barren Island, which is the largest of the group, being 10 miles long, and on an average 4 miles wide. It is very rocky in its whole extent, but less elevated than Three-Hummock Island: in fertility it seems to be very rich. On the western shores are numerous small islands, which render the access to the island difficult and dangerous.

Towards the southern end of that part of the coast where there is a cove, which is accessible to boats, is the group between Barren Island and Three-Hummock Island, called the Derwent Channel: it is well protected by the surrounding islands, and has good anchorage at several places. The entrance of Bass Strait. The basin, surrounded by the large islands of this group, is called Boulanger Bay, and is well protected, but very dangerous, being full of rocks and small low islands, especially towards the southern end.

Climate and Soil.—As the first European settlement on the island was established only forty years ago, it can be said with certainty that the country is imperfectly explored. Nearly one-half of the island is almost unknown, and only two-thirds of that portion which is south of the Derwent, and one-third of that which is north of that part

of the island explored. The *Mountain-Region*, south of 42°, occupies the southern and western districts of the island, and extends from north-east to the banks of the river Derwent, and from its source in Lake St. Clair to its mouth, and covers the well-known part of the island from that part of the coast which is entirely unknown except the coasts and the districts in the immediate vicinity of the river. These districts are separated by an apparently continuous mountain-range, which extends along the river at a short distance from its mouth, and in some places sends off branches which advance to the river. This range is sometimes called the *Derwent Mountains* by the settlers, but has not yet any other name. It begins on the eastern shore of the Derwent, opposite the entrance of Ralph's Bay, with the Derwent, which is considered to be about 1000 feet C., No. 1498.

above the sea. Hence it extends north-west to Mount Wellington, which is a few miles west of Hobart Town, and rises, according to Darwin, 3100 feet above the sea. Farther on, the range, which occupies a width of perhaps 20 miles, does not seem to contain many summits which rise much above the general level of the range, which level probably is never less than 2000 feet above the sea. The summits, which have been noticed, are—Mount Field (near 42° 40'), which is estimated at 3000 feet; and Wyld's Craig, or Peak of Teneriffe, about 4500 feet above the sea. The latter is covered with snow for nine months. It is stated that in several places plains of considerable extent occur on the top of the range; but as the whole of it is covered with an impenetrable forest, it has hitherto been impossible to ascertain this fact. The mountains which surround Lake St. Clair, the source of the river Derwent, appear to be connected with this range, and to constitute its northern extremity. At the southern extremity of the range is a large peninsula, formed by D'Entrecasteaux Channel and the estuary of the river Huon, the whole of which is covered with high hills, clothed with dense forests to their summits, and broken only in a few places by valleys, which exhibit a great degree of fertility, but in which no settlements have yet been made.

The remainder of this region is only known so far as it has been observed from the sea and a few places from the coast. The most striking feature of this district is a mountain-range which rises a few miles from the southern coast, and appears to extend, without interruption, from the eastern part of Port Davey, called Bathurst Harbour, to the vicinity of Port Refuge, at the entrance of D'Entrecasteaux Channel. Its lower parts are covered with thick forests, but the higher are without wood. Some parts of them appear white, which has suggested the opinion that they are always covered with snow; but this fact is questioned. The higher parts however are considered to rise to an elevation of 5000 feet above the sea-level. North of this range there are two elevated mountain-masses, a few miles south of 43° S. lat., which are called Harz Mountain and Arthur's Range. The latter is visible from Mount Wellington, though more than 50 miles distant. At the back of these masses, north of 43° S. lat., open plains are stated to extend from the banks of the river Huon to the mountains which line the western shores. A few open plains of moderate extent are also found near the banks of the Huon, where the river runs eastward; but farther down the whole country is covered with impenetrable forests. From this river to 42° S. lat. the country is entirely unknown. Several summits have been seen from considerable distances. The most elevated appears to be Frenchman's Cap, east of Macquarie Harbour, which is covered with snow nearly the whole year: its base is said to be surrounded by woodless, open, and grassy plains of considerable extent. The forests, which cover this region almost without interruption, consist chiefly of different kinds of Eucalyptus, especially *Eucalyptus globulus*, and different kinds of pines, among which Tasmania and many tree-like ferns are frequently met with.

The *Valley of the Lower Derwent* extends from Mount Nelson upwards to the confluence of the Derwent with the Ouse (near 42° 35' S. lat.), and is rather more than 50 miles long, measured along the banks of the river. The Derwent runs close to the range of high mountains which extend along its western banks; and the space between the banks of the river and the base of the steep rocky masses hardly ever exceeds a mile in width, and is frequently not half so much. The soil of this narrow and comparatively level tract is of great fertility, and a large part of it is under cultivation. On the east of the river the valley extends to the distance of about five miles, where it meets the higher hills that enclose the valleys which lie farther east and north. The surface of this part of the valley is level near the banks of the river, and subject to inundations; but at a short distance from them the ground rises in gentle undulations, on which some low and isolated hills are met with. The soil of this tract appears to be generally of first-rate quality: it produces rich crops of wheat, and is well adapted to orchards. Cultivation is rapidly spreading over this tract.

A *Hilly Region* extends east of the Lower Valley of the Derwent. It extends eastward to the shores of the Pacific, and northward nearly to 42° 35' S. lat. The surface of this tract is a continuous succession of hill and dale. The tra-

veller no sooner arrives at the bottom of one hill than he has to ascend another, often three or four times in the space of a mile. In some places the land swells into greater heights, which have several miles of ascent. Except the valleys, which constitute the bottoms of the numerous rivers which traverse this region from north to south, and which are generally of moderate width, the level tracts, either marshes or plains, are comparatively few. The most elevated part of this region appears to be a ridge of high ground which begins on the north at Table Mountain, a summit standing near the south-eastern extremity of Lake Sorell, whose elevation is estimated at 3800 feet. The ridge branching off from it towards the south is of moderate elevation, but considerable width, occupying the greater part of the tract between the rivers Clyde and Jordan. It terminates about five miles from the banks of the Derwent in Mount Dromedary, the summit of which is 1800 feet above the sea-level. In general the hills sink lower as we proceed south, and the surface of Ralph's Peninsula, and of the country enclosing Pitt's Water and North Bay, is only undulating. Cultivation in this region is almost exclusively limited to the bottoms of the rivers, where there is a strong soil, which produces plentiful crops of wheat and other grain. The declivity of the hills is sometimes too steep for cultivation, and they are generally covered with thick woods. But even where the declivities are gentle, which is most frequently the case, the soil is too dry. These declivities, and also the upper parts of the hills, where small levels frequently occur, are overgrown with open forests without underwood, under the shade of which there is grass nearly all the year round. These hills afford excellent pasture for sheep and cattle. This description applies to the whole region, except that portion which is north of Norfolk Bay, and which appears not to have been explored. That part of it which lies along the Pacific consists only of rocky masses, frequently destitute of woods and bushes, and in other places overgrown with crooked and stunted trees.

The *Elevated Plains* are north of the Hilly Region, and extend from 42° 35' to about 41° 50'. They are separated from the Pacific by a higher tract, called Eastern Tier. This tract begins on the south near 42° 35', where it is about 10 miles wide, and extends northward to the valley of the South Esk, to which it descends with a steep declivity. It increases in width as it proceeds farther north, and on the banks of the South Esk it is more than 30 miles from east to west. This region also is entirely unknown, and is a blank on our maps. We can find no information respecting its character and capabilities. The heights which extend along the sea are very scantily wooded, and do not present a promising aspect. The plains themselves are divided into the southern and northern plains by a somewhat hilly and wooded tract, which crosses them in a diagonal direction from south-east to north-west, beginning on the Eastern Tier with the Blue Hills, south-east of Oatlands, and passing east of that township to Table Mount, and the other heights surrounding Lake Sorell, and hence to the range of mountains called the Western Tier or Western Mountains, from the southern extremity of which it is divided by the upper valley of Lake River. Farther west the Western Tier constitutes the northern boundary of the southern plains. These southern plains are distinguished by many large lakes. The most western of these lakes is that of St. Clair, the source of the Derwent river. It is about ten miles long and three miles wide on an average, and differs from the lakes farther east in having more of the shape of an alpine lake and being surrounded by mountains. The country east of the lake St. Clair is not included in the plains, being very mountainous, and containing several high summits between the Derwent on the west and the Nive river on the east. Even to the east of the last-mentioned river that part of the country which lies near the Derwent is extremely uneven and hilly, but farther north the southern plains begin with the tract that surrounds Lake Echo. This lake is of a round form, but only three miles in diameter. The shape of this, like all those farther east, shows that they are not enclosed by mountains, but spread out in plains. North of Lake Echo is Great Lake, the source of the Shannon, one of the largest tributaries of the Derwent. It is said that this lake is 20 miles long, 10 wide, and, owing to its numerous branches, 75 miles in circuit; but our maps give it hardly half these dimensions. East of Great Lake are the three Arthur

lakes, the largest of which has a circuit of 130 miles. Lake Sorell, which is farther to the east, is of a very irregular form, and hardly inferior to the Great Lake. Smaller lakes are numerous, and the wooded tract which separates the southern from the northern plains. There are fewer lakes in the northern plains, and they are all small, with the exception of the Western Lagoon, a cluster of lakes situated at the termination of the Western Tier, the largest of which is five miles long and half a mile wide. The tract separating the plains has a hilly surface, and is generally from five to ten miles wide where it is crossed by the road from Hobart Town to Launceston. In the plains there are short ridges of low hills, which rise above the general level with very long slopes, and are covered with forests. At other places there are single hills of a conical form, hence called sugar-loaves: these are frequent in the district which approaches the coast. In other respects the surface of the plains is generally level or slightly undulating. In the northern plains are generally destitute of trees, but in the southern plains, especially where the surface is undulating, trees grow in clumps. The climate is much colder than in the northern plains, near the coast, as the snow sometimes covers the ground for several weeks, and thus the soil is unfavourable to maintain a vigorous growth of grass all the year round. The pastures thus produced are not so rich as those of the agricultural wealth of this region, as the soil is not so fertile as to be suitable for the growth of grain. The pastures are better adapted for sheep than for cattle, and the wool exported from Tasmania is brought from this region. Among these plains the Salt-Pan Plain requires notice. It lies between the Derwent and Tamar, between the Macquarrie river, which runs to the north of the Derwent, and the Jordan, which falls into the Derwent. It consists of three ponds, or, rather, hollow depressions, filled with water during the rainy season, but which, when the rains are over, and the soil is then so saturated with salt that a considerable quantity of salt is obtained every season for domestic purposes.

The region hitherto described is watered by numerous streams, most of which join the Derwent. The river Derwent originates, as already observed, in Lake St. Clair, which is about 60 miles measured in a straight line, to the east of the tide-water, and its general course is southward from the lake, it traverses for several miles a narrow valley bounded by mountains; it is then joined from the north by the Nive, and from the south by the Florentine river, the course of which is hardly known. It leaves the mountains in the northern part of the province, where it forms two currents from one another, of which the uppermost is the most rapid. It then flows along the foot of the western mountains, forming a rapid current, and is not navigated, except by small boats. The numerous rocks along its banks, but also the small volume of water is subject to great changes, and rapids occur at New Norfolk, up to which water comes. During the summer months the river is brackish, and unfit for drinking; but when it is swollen by rains, it is navigable for ships. At a distance of two or three miles below the town of New Norfolk is here a quarter of a mile wide, and navigable for ships. A few miles lower down the river is again narrowed to three-quarters of a mile, which width increases to two miles. Below Hobart Town the river is between two and four miles, and is deep enough for vessels, and free from shoals, which are not so numerous above that town. The tide ascends 30 miles up the Derwent Bay. None of the tributaries which enter from the south, after it has emerged from the mountains, are above the size of a mountain-torrent: several rivers from the north which flow into the Derwent, as the Dee, the Ouse, the Clyde, &c. Some of them form cataracts and rapids, and are not navigable.

The river Huon, which drains the great mountain-region west of the Derwent, has a length of 80 miles; but this river lies without the settlement of the colony, and its course has only been explored in a few years. No account of it exists. Its mouth is situated, like the Derwent, which opens into the Derwent Bay. Coal River drains the undulating

ent, and falls into Pitt's Water: its course is miles.

to the description of the northern part of Tasm^a (north of 41° 50'). The watershed of the eastern part of this country lies close to the Pacific, as the recesses of the South Esk are only from four to five miles from its shores. The Upper Valley of the South Esk contains two large mountain-masses, but the Lower constitutes a part of the Basin of Lincoln. The valley extends from the sources of the river westward to the vicinity of Ben Lomond Rivulet, where another Ben Lomond comes close to the river, whilst to the south the most north-western branch of the Eastern Tier approaches very near, so that there is a narrow valley by which the Upper Valley of the South Esk is joined to the St. Paul's River, but nearly 50 miles from the Break-o'-Day River. The mountains which extend along the shores of the Pacific, and connect the Eastern Tier with the range of the Western Tier, have not been explored. When seen from the sea they constitute a high range, overtopped by several summits, the highest of which is Tasman's Peak and Mount Chamth-west of Cape St. Helen's: the last mentioned summit rises about 3000 feet above the sea. It has been ascertained where and how this maritime range is connected with Ben Lomond. Ben Lomond appears to be the highest ground in this part of Tasmania, and is situated to rise 4200 feet, or about 1200 feet higher than the mountain in Scotland whose name has been given to it. The mountain-mass, of which it forms the elevated portion, extends to a considerable distance south-west, where, as already observed, it descends to the banks of the South Esk, near the place where it is joined by Ben Lomond Rivulet, and it is probably advanced still farther to the north-east, in which direction this region has not been explored. It is certain that the maritime range and that of Ben Lomond meet at an acute angle, leaving between them a narrow valley of a basin-like shape, which may be called the Basin of Lincoln, from a township of that name situated near the mouth of the South Esk and the Break-o'-Day River.

The existence of this basin has only been discovered within the last ten years, and our information of it is scanty; but as the settlements begin to be made, and as it has been divided into hundreds, we may be assured that the soil of this tract is good. The basin extends from north to south about 15 miles, and from east to west. Its southern boundary is defined by the Break-o'-Day River, which, running eastward, meets the South Esk, which originates in the Ben Lomond range, and waters the northern districts of the Western Tier.

The South Esk, having a south-west course, enters a narrow valley, about 10 miles long, and afterwards descends to the plain, where it is met by the St. Paul's River. The valley through which the last-mentioned branch of the South Esk descends from its source in the maritime range, is a considerable part of its course so wide, that it is named the St. Paul's Plains, which are an undulating country, in some parts overgrown with open forests, and in others without trees, but generally producing rich pasture. Between the St. Paul's River and the Basin of Lincoln is a mountain range, which is connected on the east with the maritime range, and whose western extremity is marked by a summit, to which the name of St. Paul's Dome has been given. It is considered to rise 2800 feet above the sea. After the confluence of the two principal branches of the South Esk turns westward, and flows along the Eastern Tier, so that between the river and the Western Tier there is only a narrow strip, with a hilly or hilly surface, which however has a good soil. The valley of the river extends to the base of the Ben Lomond range, a distance of five or six miles: the soil is generally better adapted for pasture than for agriculture, and is partly covered with thin forests. Thus the valley of the gorge above the mouth of Ben Lomond

is probably occupied by mountains; but the interior of it has not been explored, and only the outskirts of it are known. The country along the Bay of Fires, between Cape St. Helen's and Eddystone Point, is of considerable elevation, but partly well wooded and partly covered with a fine growth of grass. This tract is supposed to be fit for pastoral settlements. North of Eddystone Point the mountains are several miles from the shore: they have only been seen from a distance, and appear to constitute one continuous mass, broken in a few places by ravines, by which small rivers issue from them. There are no striking summits, except Mount Cameron, between Eddystone Point and Ringarooma Bay, but its elevation is not known. The mountains are generally wooded. The flat country between these mountains and the sea, from Eddystone Point to the mouth of the Tamar, is watered by numerous small streams, but the soil is generally dry and sandy, in some places overgrown with bushes or short, crooked trees, and in others covered with swamps, in which only tea-bushes are found. There are a few tracts which have a better soil, and might be cultivated, as on the banks of Piper's River. The best portion of this region is the valley of the North Esk, which opens to the west, and stretches eastward into the mountains on the north of the Ben Lomond range. This valley however is narrow, and contains very few tracts adapted for agricultural purposes, and the number of settlements is small, though the proximity of the town of Launceston affords a ready sale for their produce. A ridge of sterile but wooded hills runs along the southern side of the river, and continues to the banks of the South Esk, where that river, about a mile above Launceston, runs in a narrow valley for a mile, and at the point where it leaves that valley forms a cataract about 40 feet high.

The gorge through which the South Esk flows above Launceston separates the valley of the Tamar, which lies north of it, from the Basin of Lincoln, which extends south of it. The Tamar is only a deep inlet of the sea, which begins at the town of Launceston, and where the two Esks fall into it. Its length to Port Dalrymple in a straight line is about 30 miles, but measured along its numerous bends it is 43 miles. The tides come up to Launceston, at which place the inlet is only 60 yards wide, yet vessels of 150 tons may ascend to the town. The width of the navigable channel is 20 yards, nor does it widen for two miles below the town, and it is very narrow 10 or 12 miles farther, though the inlet itself widens to three-quarters of a mile. Ten or twelve miles below Launceston the inlet alternately expands to a breadth of three miles, and contracts to a mile, so as to appear like several small lakes connected by short channels. In this part are several shoals and sand-banks, and they only disappear about 15 miles from the sea. It is a great obstacle to the navigation of the river that the wind always blows either directly up or down it, so that a vessel is often obliged to depend upon the tide, and it sometimes happens that a passage from Port Dalrymple to Launceston occupies two or three weeks. The valley of the Tamar, measured between the summits on the two sides of the river, is about eight miles wide, but two or three of them are occupied by the declivities, though these declivities are rather steep. Thus the cultivable ground, if the extent of the inlet itself is subtracted, varies between three and six miles. Near the town of Launceston, and to a distance of about 11 miles north of it, the country on both sides of the river possesses a considerable degree of fertility, and is well settled; but farther down the eastern banks have a dry sandy or stony soil of very inferior quality, which is still uninhabited. On the left bank of the river the soil is much better, and there the settlements are numerous, though not so numerous as near Launceston.

The Basin of Lincoln, so called from the hundred of Lincoln, which occupies the centre of it, is the most fertile portion of Tasmania. It includes on the east the lower valley of the South Esk, extending to the western base of Ben Lomond, and on the west reaches the eastern base of the Western Tier. It is separated from the Northern Elevated Plains by the hilly and woody tract called Epping Forest. On the north it is bounded by the ridge of hills south of Launceston, and the mountains which line the northern banks of the Mæander as far as the mouth of Quamby's Brook. It extends from south-east to north-west about 25 miles, and as much from north-east to south-west. This gives an area of 600 square miles. This basin is watered by several large rivers, which unite, and ultimately

ent, and falls into Pitt's Water: its course is miles.

The gorge through which the South Esk flows above Launceston separates the valley of the Tamar, which lies north of it, from the Basin of Lincoln, which extends south of it. The Tamar is only a deep inlet of the sea, which begins at the town of Launceston, and where the two Esks fall into it. Its length to Port Dalrymple in a straight line is about 30 miles, but measured along its numerous bends it is 43 miles. The tides come up to Launceston, at which place the inlet is only 60 yards wide, yet vessels of 150 tons may ascend to the town. The width of the navigable channel is 20 yards, nor does it widen for two miles below the town, and it is very narrow 10 or 12 miles farther, though the inlet itself widens to three-quarters of a mile. Ten or twelve miles below Launceston the inlet alternately expands to a breadth of three miles, and contracts to a mile, so as to appear like several small lakes connected by short channels. In this part are several shoals and sand-banks, and they only disappear about 15 miles from the sea. It is a great obstacle to the navigation of the river that the wind always blows either directly up or down it, so that a vessel is often obliged to depend upon the tide, and it sometimes happens that a passage from Port Dalrymple to Launceston occupies two or three weeks. The valley of the Tamar, measured between the summits on the two sides of the river, is about eight miles wide, but two or three of them are occupied by the declivities, though these declivities are rather steep. Thus the cultivable ground, if the extent of the inlet itself is subtracted, varies between three and six miles. Near the town of Launceston, and to a distance of about 11 miles north of it, the country on both sides of the river possesses a considerable degree of fertility, and is well settled; but farther down the eastern banks have a dry sandy or stony soil of very inferior quality, which is still uninhabited. On the left bank of the river the soil is much better, and there the settlements are numerous, though not so numerous as near Launceston.

The Basin of Lincoln, so called from the hundred of Lincoln, which occupies the centre of it, is the most fertile portion of Tasmania. It includes on the east the lower valley of the South Esk, extending to the western base of Ben Lomond, and on the west reaches the eastern base of the Western Tier. It is separated from the Northern Elevated Plains by the hilly and woody tract called Epping Forest. On the north it is bounded by the ridge of hills south of Launceston, and the mountains which line the northern banks of the Mæander as far as the mouth of Quamby's Brook. It extends from south-east to north-west about 25 miles, and as much from north-east to south-west. This gives an area of 600 square miles. This basin is watered by several large rivers, which unite, and ultimately

mately fall into the South Esk before it enters the above-mentioned gorge. These rivers are, from east to west—Elizabeth River, Macquarrie River, Lake River, Pennyroyal River, and Mæander or Western River. The surface and the soil of the Basin are not uniform. East of the South Esk the higher country chiefly consists of plains, either destitute of wood or thinly wooded, and well adapted for sheep: the wide bottom of the rivers yields rich crops. The country between the South Esk and Lake River consists of wide valleys along the courses of the rivers, and narrow ridges of hills between them, which however in some places attain a considerable elevation above their bases. These hills are generally wooded, and though the soil on their declivities is good, they are at present only used as pasture-ground: the wide level tracts along the watercourses have a very fertile soil, most of which is under cultivation. The most level portion of the basin is that which is west of Lake River, for in this district the uplands do not rise much above the bottom of the valleys, extend with an undulating surface, and are seldom interrupted by high hills. Like the bottoms, they were formerly clothed with trees, except on the very margins of the rivers, but nearly the whole of the region has been cleared and converted into fields. The soil of the bottoms is very rich, but they are subject to inundations, which however are of short duration. From the Basin of Lincoln all the corn is brought to Launceston, which is exported from that place, and which is the principal support of the population in the country round Sydney, whenever Australia experiences a dearth.

To the west of this basin is the *Western Tier*, or *Western Mountains*, which extend from the banks of the Lake River a few miles below the place where that river issues from the Arthur Lakes, in a west-north-west direction to the sources of the river Mersey, a distance of about 50 miles. The range lies between the southern plains and the Basin of Lincoln, but we have very little information respecting this region. A few summits have been noticed, as the Quamby Bluff, near the north-western extremity of the Basin of Lincoln, which is stated to be 3500 feet high, and the Extreme Western Bluff, at the west end of the region. It appears that the upper part of the range constitutes a tolerable level, on which only a few peaks attain 500 feet, and which is covered with small lakes, grass, and an alpine vegetation. Some low rocky ridges which run across it are covered with crooked eucalyptus and bushes. The width of this elevated tract does not exceed a few miles, but its elevation must be considerable, which may be inferred from the circumstance that even in January, which corresponds to our July, a heavy fall of snow was experienced, which covered the ground some inches deep. The whole vegetation, especially the frequent occurrence of lichens and mosses, proves its great elevation, which probably is not much less than 4000 feet above the sea-level.

At its northern extremity the *Western Tier* is of considerable width, extending from Quamby's Bluff to Extreme Western Bluff, a distance of about 25 miles. At its northern declivity extends a depression or valley, from east to west, which may be called the *Valley of the Mæander*, as that river drains the greater part of it. Though a cart-road has been made through it, we are not acquainted with its extent from south to north, but we are informed that it extends westward to the vicinity of the Mersey where this river turns westward, being here divided from the valley of the last-mentioned river by a narrow offset of the *Western Tier*. This tract consists of level plains, which are generally without trees, but in several places there are small clumps of them, and they are occasionally intersected by narrow belts of forest, extending from the mountains to the banks of the rivers. Numerous rivers water this country, the soil of which is stated to be of good quality, and equally adapted to cultivation and the rearing of cattle.

Proceeding westward from the banks of the Mersey, two high and steep mountain-ridges must be passed before that region is reached which is called the *Surrey Hills*, and which constitutes one of the most remarkable features of Tasmania. It occupies the country for about 20 miles on each side of 146° E. long. and an equal extent on both sides of 41° 30' S. lat., but properly speaking, its extent towards the south is not known, and it is even probable that it reaches the foot of the Eldon range, a chain of mountains which has been seen from a distance, and which

probably is about 41° 55' S. lat. This region gives to a great number of rivers, which run off in all directions. With the exception of a few rivulets originating on the coast, all the rivers which fall into the sea west of 146° E. long. and north of 42° S. lat. rise in the Surrey they must therefore constitute the highest ground part of Tasmania. It is remarkable that the high of the region lies on its outer edges, for the region rounded on the east, and still more on the north as by hills which rise considerably above the general level have extremely steep declivities, and narrow level tracts on their tops, but are otherwise covered with dense forest frequently matted together by underwood. Among the summits are the St. Valentine's Peak, near the northern edge, which is 3000 feet above the sea, and the I Mount, which is said to be 300 feet higher. The surface of the region is very different. Its surface is for the most part a succession of low hills, which rise with so gentle a declivity that it may be considered a plain, and it is intersected by small brooks, the sides of which are adorned with belts of beautiful shrubs and trees. Whenever a declivity rises to a higher elevation, its declivity consists of regular terraces, as if laid out by art, and the summits are crowned with stately peppermint-trees. There are open plains of several square miles in extent, and a few trees. In general there are not more than ten trees to an acre. The hills are covered with a vigorous grass. The soil is a dark vegetable mould upon brown loam. The substratum appears to be granite, which renders these hills perfectly dry, and fit for sheep-which purpose they now are used by the settlers. Some of the hills have been formed on them by the Van Diemen's Company. This country extends north of St. Valentine's Peak on both sides of the Emu river, where it appears more park-like than farther south, being less densely clumped with trees. This tract is called the *I Hills*. The elevation of the Surrey Hills above the level renders the climate much colder than on the coast. Snow covers the ground for several weeks, which must be considered as an advantage in a country where the soil inclines to dryness. It has also the benefit of abundant rains during autumn (March and April).

Between the valley of the Mæander and the Surrey Hills on the south, and Bass's Strait on the north, is the region of Devonshire. The mountains which extend from the gorge of the South Esk to the west of the Tasmanian coast, north-west, and terminate on the sea with Point Grim, appear to constitute a continuous range of moderate elevation. They are partly wooded and partly destitute of trees, and in some places covered with a very scanty vegetation of shrubs or grass. Farther west this region is not known, except that the spaces between the rivers up with mountains and high hills, and that they come close to the shores of the sea. Few, if any, settlements have been formed on it. This region extends westward to the banks of the Emu River.

West of the Emu River begins the *Great Plain* of Tasmania: it occupies the north-western portion of the island, extending along the northern coast from the I Mount to Point Grim, and along the western coast to the Ararat. The narrowest portion of this plain appears to be between the Emu and Detention Rivers, where its width does not exceed 12 miles, and it terminates on the southern coast at the Hampshire Hills. Farther west a continuous range of hills, called the Campbell Range, forms its boundary, and terminates near the source of the Detention River at Dip Hill, a mountain of moderate elevation. The surface of this portion of the plain is strongly undulating, and in many parts even hilly. Near the shores it is covered with dense forests, which are made nearly impenetrable by the underwood, bushes, and ferns. But about 10 miles or somewhat more from the sea the forests are interrupted by a succession of small plains covered with grass, and destitute of trees. They have a light dry soil, are well watered by springs and streams, and surrounded by excellent pastures. The grass is coarse but plentiful: there are some tracts fit for cultivation. West of Detention River the plain grows wider. From Dip Hill, at the source of the river, Hellyer distinguished the high grounds of Point Grim and West Point, though they are of very low elevation. The plain, west of Detention River, extends 15 miles in width. This large tract however is ill adapted for colonization. The surface is generally

water not being carried off, the country has been ed into an immense swamp. A portion of the swamp rown by low tea-trees, and the remainder is covered of eucalyptus and underwood. The higher which generally occur nearer the shores, have a nd covered with heath or stunted trees. The only iche seems to be applicable to useful purposes is e sea from Cape Grim to the River Arthur: its ear the cape is several miles, but farther south it uch narrower: the surface is hilly and partly stony. has generally a tendency to sand, but it is thickly with kangaroo grass, and makes good pasture- for sheep, and in some places for cattle. Trees at considerable distances from each other. It ue that the plain continues south of Arthur River, it is of less extent there, as low hills have been a short distance from the sea, which are dry and vered with bushes, but behind them the hills rise igher. These parts have never been visited.

Arthur, whose mouth is near $41^{\circ} 10'$ S. lat., is a considerable size, and brings down a large volume . There is a bar across its mouth, on which the s with a heavy surf. Its middle course is not it is supposed that the chief supply of its waters from the Surrey Hills, and that two large rivers, here, and are respectively called Hellyer River and River, unite in the country between the Surrey d the western coast; and that by their confluence ur is formed.

Other known rivers of the northern part of Tasmania portant, with the exception of the Emu, which is le for boats for a few miles. With respect to the sk, which probably has a course of 100 miles, two ceipal branches, the Macquarrie and the Lake River, he southern elevated plains, and the upper branches rivers interlock with rivers which flow southward berwent. As other branches of the South Esk rise : eastern coast, and others far to the west, it is proat the area of the country which is drained by it North Esk does not fall short of 4000 square miles. ar certainly receives the drainage of a much larger if country than any other river of Tasmania.

As no meteorological observations have been d on the climate of Tasmania, we only know its ities by comparisons which have been made be- and that of England and Sydney. There is a con- : difference between the climate of Hobart Town uthern, and of Launceston on the northern coast. ate of Hobart Town seems to be greatly in- : by the range of mountains west of the town and ity of the open ocean. The vague statement of that the mean temperature in summer is 70° , and r between 40° and 48° , is apparently not derived ervations, and is not much to be relied on. The of Hobart Town is extremely changeable. Heat, n, and sunshine succeed each other with a rapidity rarely observed in any other part of the globe. The s not more constant than the summer: the same ons, with the addition of hail and snow, follow each quick succession; but the snow never remains on nd beyond a few hours, whilst at Launceston it falls r quantity, and covers the ground for many days . This statement does not agree with another, ac- to which the average number of days on which rain falls does not exceed fifty or sixty in the year, and ept on these days, the sky is clear, the sun brilliant, sphere dry, pure, and elastic. Hot winds

occur, which occasionally raise the thermometer . They blow from north and north-west, and rarely ng time; but during their prevalence vegetation is njured. However warm the middle of the day may invariably attended by a morning and evening so completely to brace the body, and to counteract any ng effects of the climate. Thunder-storms are less : than in Australia, but violent gusts of wind some- cur, which cause great destruction in the forests, coasts are visited by much boisterous weather. he western coast strong south-westerly winds pre- rly all the year round, and render this tract almost ible on account of the want of harbours. During ions of the year westerly gales continue for many : Bass's Strait, so that vessels sailing from Sydney Atlantic find that they save time and labour by

going round the island. The climate is very healthy: no epidemic or contagious diseases have been observed, and acute diseases are generally mild and of short duration, and yield more easily to the usual remedies than in any other country.

Productions.—The mineral wealth of the island is not known. The existence of gold and silver rests on state- ments which cannot be relied on; but that of copper is certain, and this metal is rather abundant in some of the hills on the north coast. Iron-ore is abundant, but not yet turned to account. Some ore which was subjected to a trial yielded 80 per cent. of metal. There are also indications of lead, zinc, and manganese; and those of coal have been found all across the island. Roofing-slate of good quality abounds in many parts: on the Arthur such extensive layers were discovered by Hellyer, that in his opinion the whole globe might be supplied with them. Salt is obtained from the salt lakes of Salt-Pan Plain, and is also got from sea-water on Bruni Island, but not in sufficient quantity to supply the consumption. Salt is imported from England. Excellent sandstone for building is found in all parts of the island, and marble is met with at various places. Basalt rocks are frequent along the coast and in many places in the interior.

No tropical grains or plants are cultivated, but all grains cultivated in England succeed well. Wheat is of excel- lent quality, weighing generally from 62 to 64 pounds the bushel: considerable quantities are exported. Barley and oats will only thrive in a good soil. Vegetables of all kinds are most plentiful, even those of Southern Europe, the production of which requires in England much care and expense. The apple-orchards are of great extent, and the making of cider is attended to. Peaches, apricots, and nectarines grow very abundantly. Damsons, plums, cherries, pears, and quinces are also grown; but the fruit is of inferior quality, for want of care. Grapes are of good quality, but no good wine has yet been made. Rasp- berries, gooseberries, and currants are abundant and of good quality: strawberries are also good. All these fruits have been introduced by the settlers.

The domestic animals of Europe have been transplanted to Tasmania, and thrive very well. Sheep are most nu- merous. Wool and live stock are exported to a great extent. Black cattle are also numerous, and many head are annually exported; and also some horses. Fowls are extremely numerous, but geese and ducks are not much kept.

The spermaceti-whale is very abundant in Bass's Strait, and many of them are annually taken, but more by the inhabitants of Australia than by those of Tasmania. Black whales abound in all the seas round the island, and a very lucrative fishery is carried on along the southern coast. Whalebone and train-oil are important articles of export. A small quantity of spermaceti-oil is also exported. Seals are found on most of the smaller islands, and especially on the eastern coast: their skins constitute an article of export. Some of the animals of the forests are common to Australia and Tasmania. The native tiger (*Hyena opossum*) and the native devil (*Dasyurus ursinus*) are pe- culiar to Tasmania, and perhaps also the wild cat. These are the only carnivorous animals in Tasmania, with the exception of some species of weasel. There are three or four species of kangaroos, two kinds of opossum, the bandicoot, the native porcupine or echidna, the wombat, the opossum-mouse, and the ornithorhynchus paradoxus. All the wild animals of Tasmania, with the exception of the native devil, are very easily tamed and domesticated. The birds are numerous: these are emus, black and white cockatoos, parrots, two kinds of magpies, the laughing jackass, hawks, eagles, the carrion crow, pelican, black swan, ducks, teal, widgeons, quails, snipes, and bronze-winged pigeons: the last-named are considered the most beautiful birds in the island. There are likewise several varieties of snakes, two or three of which are venomous; also centipedes, scorpions, and large ants. Fish are said to be more numerous than on the coast of Australia, but they have not been further noticed. The river-fish are small.

None of the forest-trees or shrubs yield an edible fruit. They are all evergreens, and have that sombre olive hue which prevails in Australia, without a single lively tint, except that of the native cherry, to break this monotony. The most numerous are the eucalyptus, which attains an

immense size. From one of its species a manna is obtained, which tastes like some kind of sugar-plum: it forms concretions on the leaves and smaller branches; but is found in such trifling quantities, that it would never repay the trouble of collecting it. The most useful tree is the stringy bark, which is used for building and fencing; and the blue gum, of which most of the boats in the colony are built. The smaller trees are used for masts for small vessels. The peppermint, so called from the taste of the leaves, is a large tree, but of very little use. The Huon pine is the most beautiful wood in the island: it is very superior both in colour and substance to the Norway deal, but is scarce and difficult to be had. The Adventure pine, so called from the bay of that name, is a species of pine adapted for house-work and furniture; but it is not common. The black and silver wattle (*mimosa*) are used in house-work and furniture, but they are of diminutive size. The bark of the black wattle is exported to England in large quantities. The tea-tree is a shrub which grows in wet situations: an infusion of its leaves makes a pleasant beverage, and, with a little sugar, forms an excellent substitute for tea.

(*Flinders's Voyage to Terra Australis*; *Rossel's Voyage d'Entrecasteur*, &c.; *Evans's Geographical, Historical, and Topographical Description of Van Diemen's Land*; *Widowson's Present State of Agriculture*, &c., in *Van Diemen's Land*; *Bischoff's Sketch of the History of Van Diemen's Land*, &c.; and *Breton's Excursions in New South Wales*, &c.)

History.—In 1803 Lieutenant Bowen, commissioned by the government of New South Wales, landed on the east bank of the Derwent, and formally took possession of Van Diemen's Land as a place of settlement. In the following year Colonel Collins, the first lieutenant-governor, arrived, and established the seat of government on the west bank of the Derwent: he gave to the spot the name of Hobart Town, in compliment to Lord Hobart, then secretary of state for the colonies. Colonel Patterson arrived in the same year in the Tamar, and formed an establishment on its west bank. Colonel Davey succeeded to the government in 1813, and under his administration the ports of the colony were first opened to commerce, only transport vessels from New South Wales having previously been admitted. Colonel Sorell was appointed lieutenant-governor in 1817, and in 1819 the immigration of free settlers from England commenced, the colony having been previously exclusively formed of criminals sent from New South Wales for crimes repeated there, and of the civil and military officers charged with their superintendence. Till the year 1824 the government was subject to that of New South Wales, and the chief civil and criminal questions arising in Van Diemen's Land were decided in Sydney. The only courts in the island were those of police magistrates, who had cognizance of petty crimes, and a court for the settlement of questions of value not exceeding 50*l.*, in which a military officer presided. Great inconvenience and mischief resulted from this state of things. Civil cases were mostly settled by compromise; and in criminal cases, the most dangerous offenders were allowed to escape.

The most important steps in the progress of the colony were made between the years 1824 and 1836, during the administration of Colonel Arthur:—

In 1824, the population was 12,643; in 1835 it was 40,283		
Number of vessels		
which arrived	33;	234
Sailed outwards	35;	225
Acres in crop	34,033;	87,243
Pounds of wool exported	130,000;	1,942,800
Number of manuf- factories	22;	133
Banks	1;	6
Revenue	£16,866;	£106,639
Expenditure	£32,126;	£103,029
Value of Imports	£62,000;	£583,646
Exports	£14,500;	£320,679

(*Statistical Returns of Van Diemen's Land, compiled by the Colonial Secretary, Hobart Town, dated 10th Oct., 1836.*)

Roads were formed and bridges constructed in different parts of the island; wholesome laws were introduced; the

tone of public opinion was improved, and the fruits of enterprise and industry were secured by an improved police system.

That which chiefly contributed to the progress of the settlement was extraordinary encouragements held out to emigrants. Grants of land were made to them proportioned in extent to the capital which the colonist was prepared to invest in stock and in agricultural improvements. The labour of convicts was not only liberally provided, but the colonist was rewarded for employing it by allowances of rations for himself and the convicts in his employ for some time after his arrival; and at a later period, when this remuneration, or, to speak more correctly, this additional bonus, was withdrawn altogether, labour was obtained on the easy conditions of the settler providing clothes, food, and lodging to the convicts assigned to him. There were other advantages likewise incident to the penal purposes for which the colony was founded, which assisted its progress. The character and condition of the majority of the population required that a civil and military force should be established on the island, which, being maintained by the British government, introduced so much capital annually. From the magnitude of their crimes or their dangerous character, it was not deemed safe to remove from under the immediate coercion of government a large number, amounting latterly to some thousands of the convicts, and their punishment was made to consist of hard labour at works of public utility, such as the making and repairing of roads and bridges. While the expense of maintaining these convicts was defrayed by the British government, the settlers contracted to supply the various articles which made up that expense. They were thus in a twofold manner benefited: they had labourers employed for their advantage at the cost of a third party, and they were enabled to derive a profit from the payment of that labour. With such circumstances in its favour, with a healthy climate, and a soil of average capabilities, it was impossible that Tasmania should not advance. Its progress has accordingly been steady, scarcely subject to any of those variations to which young colonies are exposed;—to none indeed but such as may be strictly referred to that gambling spirit of speculation which the occasional great profits of an imperfectly established market are apt to engender.

In 1831 the system of colonization by free grants of land was abolished, and since then land has been sold by auction, first at the upset price of five shillings per acre; subsequently at twelve shillings; and latterly at twenty, at which it remains. The system of assignment of convict labour is at present only partially in force, and it is intended to discontinue it. The colony has probably advanced to that state in which the advantages advantages not without some drawbacks even in the best case, of compulsory labour have ceased, and in which the minute care, the good will, the steady subordination of the servant are requisite to the success of industrial operations.

Trade and Commerce.—The staple article of production in Tasmania is wool, the amount of which exported in the year ending December, 1838, exceeded 2,400,000 lbs. (*Parliamentary Report on Wool and Woollen Manufacture*, April 29, 1839.) The value of this wool in the English market has, according to the Statistical Report of the secretary to the government of Van Diemen's Land, quoted above, ranged from 1*s.* 6*d.* to 2*s.* 6*d.* per lb. A considerable trade has during the last five years been carried on with the new colonies of Australia, South Australia, and Port Phillip, in sheep, the prices of which have varied in that time so much as from seven shillings to sixty shillings per head.

Owing to the smallness of the demand for grain, and the great outlay required in the clearing of land, agricultural operations have been slow in Tasmania. This has likewise been accounted for by the circumstance that few practical farmers emigrated to the colony. The earlier settlers were chiefly artisans of intemperate habits, unacquainted with husbandry, and disinclined to attain a knowledge of it. Still (says the writer from whose account we quote, himself for ten years a colonist of Van Diemen's Land) they obtained and located themselves on grants of land: turned up the soil, and threw grain into it; and it being gratuitous, repaid their rude essays with bountiful harvests. Thus was sufficient. When one piece of land was exhausted, another was broken up, and so on in constant succession. Fresh

tinued to arrive, and obtained land too; and as not agriculturists either, they had to copy their rs. Such was the progress of agriculture in Van Land; and such is its condition at the present 8). The diversity of the climate in the different still overlooked; the seasons are scarcely ascerl the proper times for sowing remain doubtful, opted irregularly.' (*The Condition and Capa- Van Diemen's Land*, by John Dixon, 1839.) en's Land however produces not only a sufficient grain for domestic consumption, but has con- several years to supply the deficiency in New es; and in the opinion of local writers there is a of its being the granary of the southern hemi- 'en are generally used, instead of horses, in and the implements of husbandry are those in land.

stitutes the second great article of export from

Whales of the black species were at one time eat abundance in the bays on the coast of the t we find that Mr. Dixon confirms the appre- xpressed by an earlier writer on the colony ns on *New South Wales and Van Diemen's* ohn Henderson, Calcutta, 1832) of their being y by an injudicious prosecution of the fishery at of the year. Sperm oil, as well as that of the e, is exported. The returns derived from this still considerable.

the miscellaneous exports are bark, kangaroo e-bone, and potatoes (to Sydney); but the ag- the returns from these articles is trifling.

re about eight banking establishments, with e the chief towns. They are all joint-stock, the s being responsible to the full extent of their [They circulate notes of one pound and upwards. est at a recent date was ten per cent., and at the hich this article is written it cannot be affirmed lence whether it is lowered. There are also panies for the insurance of life and property.

s of the Island.—Originally Tasmania was o two counties, but it has since been subdivided : districts, and more recently into thirty-six We are not aware however that any map em- county divisions has been published, and in the etails we adhere to the divisions into districts. t of Hobart Town is bounded on the east by the ent, and on the south and west by the river Huon, h by New Norfolk and Richmond districts. It an area of about 400 square miles, or 250,000 hich not more than about 4000 are yet in cul- Richmond is bounded on the south and east by the north by Oatlands, and on the west by New ts towns are Richmond, Sorell, and Brighton; ch it includes several large agricultural esta- : it contains about 1050 square miles, or 672,000 hich about 22,000 are estimated to be under cul- ew Norfolk is bounded on three sides by Hobart, Richmond districts, and on the west and south- located lands. The towns are New Norfolk and and it comprises about 1500 square miles, or s, a great portion of which is barren and rocky: acres are in cultivation. Clyde is bounded on y unlocated lands, and on the other three sides Plains, Campbell Town, and Oatlands districts: wn is Bothwell. This district comprises 1700 es, or 1,088,000 acres, about 5000 of which are in

Oatlands, bounded on the south by Richmond, ster Bay, west by the Clyde district, and north ll Town, contains 900 square miles, or about es. Oatlands and Jericho are its towns. Up- 000 acres are in cultivation. Campbell Town, y the south by Oatlands, east by unlocated lan- ts to the sea, west by the Clyde and Norfolk Plains, y Launceston district, comprises about 1200 es, or 850,000 acres. Its towns are Campbell Ross. The land is rich and fertile, having 8000 es in cultivation. Norfolk Plains are bounded on y the Clyde, east by Campbell Town and Laun- ricts, and by the territories of the Van Diemen's pany, and north by Bass's Straits. This district 2250 square miles, or rather more than 1,500,000 ngford and Westbury are the townships. About of land are supposed to be in cultivation. Laun-

ceston district is bounded on the south by Campbell Town, on the west by Norfolk Plains districts, and on the north and east by the ocean. Besides the town of Launceston it has Perth and George Town. The district covers 3800 square miles, or about 2,352,000 acres; not more than 10,000 or 11,000 of which are in cultivation. Oyster Bay is bounded on the south by Richmond, west and north by Oatlands and Campbell Town districts, and east by the ocean. It contains about 900 square miles, or 576,000 acres, of which between 2000 and 3000 are estimated to be in cultivation. (*Martin's Van Diemen's Land; Hobart Town Annual*.)

The other divisions of the island are—the Van Diemen's Land Company's territories, comprising nearly half a million of acres on the north-west corner of the island, bounded on two sides by the sea, on the others by crown lands not yet located, and by the settled districts of the Norfolk Plains; and Tasman's Peninsula. Of the purposes to which Tasman's Peninsula is applied, an account is given in the article TRANSPORTATION.

Towns.—Of the towns mentioned in the preceding out- line of the territorial divisions of Tasmania, only two or three are worthy of notice, the others being little more than villages or sites laid out for towns on which a few straggling houses are built. 'Hobart Town is built upon an undulating surface, receding from a cove on the left of the Derwent. Seen from the water, it seems to run up before you on a variety of ascents, and to spread itself abroad upon the hills in the distance. Mount Wellington, a great mountain, which during nine months in the year is capped with snow, and which rises four thousand feet above the level of the sea, stands at the back, in darkness and sublimity, and overlooks the surrounding scenery. The town is laid out with judgment. There are about twenty streets, all wide, and dividing or intersecting one another at right angles. A narrow and shallow rivulet, which takes its rise from Mount Wellington, flows through the town, and affords the inhabitants their only supply of fresh water. All the streets are macadamized, and none are flagged. . . . The houses bear no common aspect. Some are of brick, others of stone; but all, instead of being slated, are roofed with shingles. As every proprietor has been guided by his own taste in the structure of his house, few are built alike or upon the same plan; and as he was not restrained by the government to a settled line, they are often planted in a zigzag position. The town covers a great deal of ground, but little of it after all is built upon. A tree is seen sometimes standing in the midst of houses, and a house often in the midst of trees. Dwellings have been erected long before the streets were made, and the town being upon a very irregular surface, some of the buildings in consequence now occupy very awkward situations. On one side of a street they are often elevated much above the level; while, on the other they are sunk considerably beneath it. Shops are scattered all over Hobart Town; but the business thoroughfare is confined to two streets. Some of the shops are showy and respect- able, even tasteful and elegant; displaying an appearance equal to that of many in London. The householder is as particular in decorating the interior of his house as he would be were he in England, and hence his furniture is not inferior to that of those of his own rank in the mother coun- try.' (*Dixon's Account*.) In 1839 there were upwards of fifteen hundred houses in Hobart Town. Among the public buildings may be named three handsome Episcopalian churches, and one Presbyterian, one superior edifice be- longing to the Wesleyans, besides several of inferior descrip- tion, the property of the same body, two Independent chapels, and a Roman Catholic church, by this time proba- bly completed. The Government House is an irregular struc- ture, made up of continual additions to an originally small building, and is shortly to give place to another house in- tended for the residence of the lieutenant-governor, of which the foundation has been laid. There are custom- houses, a handsome theatre, a court-house, and police- office, and an exchange has been set on foot. There are many benevolent and religious institutions and societies established, and two or three of a literary character. Seven papers are published, most of which are weekly, besides an official gazette and two gratuitous advertising sheets. The population of Hobart Town, including the convicts and militia as well as the free inhabitants, in the town and its immediate precincts, is not less than ten thousand. The

following returns exhibit the amount of the Hobart Town imports and exports, with the places from which received, and to which sent, for the year ending December, 1837:—

Imports.	
Great Britain	£230,950
New South Wales	95,865
Mauritius	8,147
Calcutta	4,397
Canton	1,541
Manilla	380
Singapore	1,876
Cape of Good Hope	3,620
United States	490
Hamburg	860
	£348,126
Exports.	
Great Britain	£166,585
New South Wales	53,980
Swan River	95
South Australia	11,414
New Zealand	1,699
Mauritius	858
Calcutta	590
Canton	15
Valparaiso	60
	£235,266

In a comparison of these returns it is pointed out by the editor of the 'Van Diemen's Land Annual,' from which publication they are taken, that the apparent balance exhibited against Hobart Town is diminished when it is considered that a great portion of this balance consists of property imported by individuals who have settled in the colony. We have not been able to procure authentic returns of a later date than those quoted; but it may be concluded that the value both of the exports and imports of Hobart Town has greatly increased since.

Launceston, the second town of the colony, is situated at the confluence of the North and South Esk, which there form the Tamar, flowing about forty-five miles, when it disembogues into the ocean at Bass's Straits. It is 124 miles from the capital of the colony. Launceston is situated in a marshy spot, and is neither in beauty nor in the promise of health to be compared to Hobart Town. The enterprise of its inhabitants, aided by the vicinity of the richest settlements in the island, is however great, and it is not improbable that this town will outstrip its southern competitor in commerce. The imports in the year 1837 were 191,843*l.* in value; the exports being 264,599*l.*, upwards of twenty-nine thousand pounds above those of Hobart Town; and in subsequent years it is believed that the difference is much greater in amount. Launceston contains many churches, the property of different religious denominations, and the private and public buildings are not destitute of architectural beauty.

The highway between the northern and southern capitals of Tasmania is for the most part well laid out; there are inns along this road at short distances from one another, the accommodation in which is not far from equalling the same on the roads of England. Passing from the highway into what were not long since unpeopled woods, the fashionable vehicle as well as the rustic waggon of the settler is to be seen driven along cross roads which are everywhere in process of formation; and here and there, only partially obscured from a distance by the thick and sombre Australian foliage, are to be seen mansions almost baronial, superseding the rude shelter of the aborigine, and the hut, almost as rude, in which the colonist first lodged.

Population.—In 1838 a census of the free inhabitants of Van Diemen's Land was made with a reference to the religious denominations to which they belonged, which exhibited the following summary:—

Church of England	16,094
Church of Scotland	2,551
Church of Rome	2,298
Wesleyans	1,299
Baptists	175
Independents	635
Quakers	80
Jews	132
	23,244

The accuracy of this return, in so far as it referred to relative numbers belonging to different religious denominations, was generally questioned; but the accurate presentation of the amount of population, we believe, admitted. No great increase by immigration has taken place since, and the new colony of Port Phillip has many from Tasmania. The return of the number of male and female convicts for the same year gives:—

Male convicts	16,129
Female convicts	2,139

An account of the convict system of Van Diemen's Land is reserved for the article TRANSPORTATION; but following returns are introduced here, as they bear upon the general social condition of the island:—

Return showing the Disposal of the Convicts in

Sentence of transportation expired	
Free and conditional pardons	
Transported to New South Wales	1,306
Transported to Port Arthur	225
Absconded in 1837	167
Died	4
Executed	69
Confined in gaols	82
Sick in hospitals	125
Invalid establishments	537
Employed in chain gangs	2,583
Employed in public works	262
Artificers on loan to settlers	6,023
Assigned to settlers	3,900
'Tickets of leave,' or conditionally free	395
Constables and field police	39
Missing	16,959*

Female Convicts.

Sentence of transportation expired	163
Conditional pardons	52
Died	16
Sent to New South Wales	1
Total number remaining	2,086
	2,318*

State of Crime.—If Van Diemen's Land has benefited in an economical sense by being a settler colony, it has undoubtedly suffered from this in a moral sense. A paragraph will not suffice to give a curate idea of the general moral condition of the colony. Referring therefore to the *Transportation of 1838*, and to a volume entitled 'Australiana,' by Maconochie, R.N., K.H. (Parker, Strand, 1839), we introduce here only a few details and accompanying explanations taken from the last of these authorities. Withstanding the strictness and vigilance of the colony, notwithstanding the length of time which the prisoners have for the most part been to its minute supervision, notwithstanding the tendency of the age to moral improvement, and notwithstanding the great influx of free settlers into the colony within the last ten years and the high personal stability of most of them, the proportion of crime to the entire population is not only very large, but appears in many particulars even to be on the increase. From No. 33 of the *Statistical Papers* drawn up by the colonial secretary, it appears that convictions for crime were, in 1824, as 34 to 100 of the whole population, and in 1832 as 92. Convictions under penal law free persons in 1824 were as 5 to 100, and in 1832 as 7 to 100; and general misdemeanors by convicts in 1824 as 11 to 100, and in 1832 as 43. As the numbers are differently made, and the several classes are multiplied; yet, with few exceptions, the fact is evident. Thus drunkenness among the convicts in 1833-34-35 was as 4 to 100, 4 to 100, respectively. The tendency, as is well known, in English society, in peculiar circumstances, has been rather steadily, during the last ten or twelve years, towards so many persons disposed of summarily were in like manner, in 1833, 4 to 100, 3 to 100; among free persons, 3 to 100; and what are called various crimes, included under previous heads, as 1 to 100, 3 to 100.

* We have not introduced the returns of convicts arriving from the various colonies which explain the difference between these totals and those given.

Maconochie quotes returns of the convictions before supreme court and quarter-sessions, on which he remarks: 1st, that the ratios throughout to the whole population are enormous, convictions in England being scarcely 1000 inhabitants, and in Scotland only 1 to 1300, for Van Diemen's Land being, in 1835, 1 to 105; 2d, the extreme vigilance of Van Diemen's Land police is to prevent the commission of great crimes, while latitude given to its summary jurisdiction makes it necessary to bring medium offences under the cognizance of the higher courts; 3rd, the pecuniary prosperity of Van Diemen's Land is advancing, which shows that idleness, not distress, leads there to crime. Comparing the amount of petty crime in the colony to that in London, that in Van Diemen's Land, for drunkenness convictions among the free population are 1 1/2 per cent.; whereas in London, for every description of petty offence, they are little more than 5 per cent.; Captain Maconochie remarks that the returns in Van Diemen's Land refer to a mixed population of agricultural as well as town residents, which makes the comparison still more disadvantageous. As general character, he mentions dissension, bitterness of feeling, violence, and a reliance upon authority, instead of influence, in the relations of master and servant. He remarks also that there is a low standard of moral principle, a characteristic which, though not so obviously more detrimental than great occasional vices, which it is more difficult to correct. But as he truly points out in his interesting work, and as there is necessity of remarking here, in strictness a social character scarcely can be predicated yet in reference to the population of Van Diemen's Land; the colony is not old enough to have moulded the character of its inhabitants; and much that is painful in the aspect of society, is also much of an opposite character—individual violence and public spirit.

Government.—Van Diemen's Land is administered by a lieutenant-governor, who is assisted by two councils. The lieutenant-governor has the initiative of all laws. The councils are called the Executive and the Legislative. The former is composed of official members, and the latter of non-official: all are appointed by the crown, and are revocable at the governor's pleasure, with the sanction of the crown. If two-thirds of the legislative council are opposed to any act proposed, it cannot pass: the resolution is not entered. Practically however this provision is of no value, for half of the council are salaried officers of the local government. Laws passed by the lieutenant-governor must, within seven days, be enrolled in the Supreme Court; and fourteen days from such enrolment, unless the judges declare them to be repugnant to British law, or the charter, or letters patent of the colony, they go into operation. In case of objection being made, the lieutenant-governor and council re-consider the act. The laws are so far as they can be applied, are recognised, and enforced in local enactments.

The judicial system consists of a supreme court, having two divisions of courts of quarter-sessions, and courts of requests, and there are sometimes called courts of conscience, and courts of appeal in matters to the extent of ten pounds. Criminal offences are tried in the Supreme Court by seven judges, or by a jury; civil cases, by a judge and two assessors, or by a jury; magistrates of the colony appointed by the lieutenant-governor, and who are open to challenge by the parties, the number being determined by the judge: if the assessors are appointed, the judge has a casting vote. The Supreme Court has jurisdiction on the application of either party in an action, and may also try it. This court declares insolvencies and has effects: it likewise possesses equitable and ecclesiastical jurisdiction. The total estimated expenditure of the judicial establishment for the year 1839 was 7s. 6d.

The most populous districts of the island there are Hobart Town, Launceston, and the two chief towns, who sit daily for the trial of petty offences, and whose decisions are subject to the approval of the lieutenant-governor, who is advised by the chief police magistrate. A constabulary force is maintained, composed chiefly of British soldiers. The total police estimates of Van Diemen's Land for 1839 exceeded 26,000*l.*

The ecclesiastical provision is of the most liberal character. Three religious denominations, the Episcopalians, the Roman Catholics, and the Roman Catholic, receive allowances of 1000*l.* P. C., No. 1496.

from the state. They are equally provided for in proportion to the respective number of their bodies, and the clergy of each have the same political status. In the towns the subscription of two hundred adults (three children or persons under a specified age being considered equal to one adult) to a paper, intimating their connection with one of the denominations named, desiring to have a church erected for the use of such denomination, and the contribution of at least 300*l.* towards its erection, are the conditions on which the government erects such church and provides for the maintenance of worship in it. In the rural districts the fulfilment of these conditions by eighty adults, residing within a radius of ten miles, is required. The sum expended by the government on the erection of a church is equal to that raised by private contribution. The stipend allowed to the clergy in the towns is 250*l.* annually, and to those in the rural districts 200*l.* A glebe and ten acres of land are also allowed, and in certain cases a further sum of money for the feed of a horse. The Wesleyans have an annual grant of 400*l.* voted in their favour by the legislative council.

The Church Act has stimulated the erection of churches in the colony, so that there is now no deficiency, comparatively speaking, except in the districts in which there is a very limited population. The estimated expenses of the ecclesiastical establishment for the year 1839 amounted to 7055*l.* 14s. 11d.; but the Church Act had not, at the period at which that estimate was made, exerted so much influence as it has since done, and at present it is certain that the ecclesiastical outlay is considerably above the sum stated. Numerous places of worship have been erected throughout the settled districts of the island by Protestant denominations, not embraced in the government scheme of support. The government assists in the maintenance of Sabbath schools in connection with the different churches.

Liberal provision is made for juvenile education, on the principles chiefly of the British and Foreign School Society; and, besides a collegiate institution, founded and maintained by the government, one has been projected by the colonists, for which subscriptions have been raised. The site of the first is at New Norfolk; the second is to be established at Campbell Town. These institutions are to be in the first instance superior grammar-schools; and gradually, as professors can be obtained, and there is a demand for the higher branches of learning, they are to receive the character of colleges.

In the estimates of the expenditure of Van Diemen's Land for the year 1839, a sum of 4000*l.* is put down for schools; and an additional sum of 2751*l.* for the 'Orphan Schools,' in which the offspring of convicts are educated and maintained. The expense of the collegiate institution is not included in the sum of 4000*l.*: its foundation had not been laid at the date of that estimate.

The revenue of the colony is derived from duties on spirits—10s. per gallon on brandy; 7s. 6d. on hollands or geneva, West India Rum, or British gin; 1s. 6d. per pound on tobacco: from licences—25*l.* per annum for licence to sell spirits; 3*l.* 3s. for auctioneer's, and 4*l.* 4s. for marriage licences: from the fees of public offices, fines, &c. It has increased progressively for many years. In 1826 it amounted to 34,655*l.* 0s. 1*l.* 4d.; in 1830 it was 62,018*l.* 7s. 8*l.* 4d.; in 1835 it was 91,320*l.* 19s. 9*l.* 3d. (*Statistical Report of the Colonial Secretary.*) With the addition of the revenue derived from the sale of land in these years, it amounted to 65,178*l.* 17s. 0*l.* 4d. in 1830; to 106,640*l.* 8s. 2d. in 1835; in 1840, the revenue, it was estimated, would amount to 200,000*l.* Part of this revenue is appropriated to the immigration of labourers, and the rest to the civil, judicial, ecclesiastical, and miscellaneous expenses of the colony, which are not borne by the British government. The expenditure of the year 1837 amounted to 136,856*l.* 1s. 6d.; for 1838 the estimated total was 124,143*l.* 14s. 4d.; for 1839, 111,770*l.* (*Abstract*, dated July 5th, 1838, Colonial Secretary's Office, Hobart Town.)

Natives.—The aborigines of Van Diemen's Land so closely resemble in physical character those of Australia, as to leave no doubt of their origin being the same. [AUSTRALIA.] M. Péron says that the Tasmanian has a large head, especially remarkable for the great length of the line from the chin to the sinicput, and that the head of the New Hollander is less bulky, and is compressed in the back part, while that of the Tasmanian is elongated in

the same direction. The great difference consists in the hair, which is straight or curled in the New Hollander, and woolly in the Tasmanian. (*Papers on New South Wales*, by Baron Field, Esq.) In language and customs the resemblance is equally apparent. Tasman, in the brief account of his voyage, published in 'Harris's Collection of Voyages' (vol. i., p. 325), mentions his observing on the shores of Van Diemen's Land trees which had 'a kind of steps cut in the bark, in order to climb up to the birds' nests: these steps, he says, were the distance of five feet from each other, so that we must conclude, that either these people are of a prodigious size, or that they have some way of climbing trees that we are not used to.' The difficulty here suggested by Tasman has been since resolved: 'The natives of Australia climb trees by cutting notches in the bark, by means of a small stone hatchet, and with each hand alternately. By long acquired habit a native can support himself with his toes on very small notches, not only in climbing, but while he cuts other notches for his further ascent with one hand, the other arm embracing the tree.' (Major Mitchell's *Travels in Australia*, vol. ii., p. 338.) In this singular custom the natives of Van Diemen's Land and of Eastern Australia agree. The corroboreé dance [SWAN RIVER] is common to both, and the offensive weapons of both people are precisely the same. Major Mitchell expresses a decided opinion that the natives of both countries are derived from a common stock (*Travels*, vol. ii., p. 341), in which other travellers have concurred. The natives of Tasmania, according to the accounts of early colonists, and of Cook and D'Entrecasteaux, appear to have been more intelligent and friendly than those of New Holland when first approached. M. Labillardière, the historian and naturalist of the expedition of Admiral D'Entrecasteaux, speaks of their music, their knowledge of plants, and their general acuteness, in terms by no means contemptuous; while he highly praises the humane and confiding disposition which they evinced towards their French visitors. Dr. Ross, the Editor of the 'Van Diemen's Land Annual,' to whom we are indebted for the best records of the early history of the colony, after many years' opportunities of intercourse with the aborigines, thus refers to them: 'During all the intercourse I have had with this interesting people, I not only found no want of sense or judgment among them, but, on the contrary, much to admire in them as thinking men, as endued not only with much ingenuity and penetration, but with the tenderest sympathies of the heart, and all the nobler passions that elevate man in the scale of being.'

Original harmlessness of character has not however preserved the Tasmanians from the usual consequences of European contact—expatriation or extinction. The history of the events which have nearly extinguished this race is briefly as follows:—Van Diemen's Land was colonized in the first instance by the most abandoned criminals. These men had no wives; no regular system of discipline was adopted in reference to them, but they were dispersed in small bodies over the territory, while others, escaping from control, pursued a predatory life. The wives of the natives were seduced by criminals, which excited the animosity of the men, and during several years indiscriminate warfare subsisted between the aboriginal and the colonizing population. At length, in 1830, the local government systematically interfered, and the free and convict inhabitants of the colony were enrolled for the purpose of killing or capturing the aborigines. Very limited success attended this mode of proceeding after it had been in operation for a considerable period, when Mr. Robinson, an individual of remarkable courage and self-possession volunteered, with the assistance of some friendly natives, to bring the rest to terms of pacification. By fair promises to the natives he accomplished a victory which could not be obtained by an expenditure of upwards of 30,000*l.* (*Van Diemen's Land Annual for 1838*) differently directed, and the natives put themselves in the power of the government. This triumph, obtained by moral influence, and which might have been made subservient to the good of both races consistently with the aborigines remaining on their native soil, was converted to their ruin. They were transported to an unfavourable spot (Flinders' Island, in Bass's Straits), where a miserable remnant of about eighty individuals were all that survived in 1836 of a population of three or four thousands, the estimated abori-

ginal population of Van Diemen's Land when colonization began there. (*Van Diemen's Land Annual for 18 127-8*.) The courage which faced the aborigines in a time of warfare, was no evidence that the man who dared to do this possessed the qualities essential to the successful treatment of an uncivilized race with to its improvement. However that courage was rewarded by the appointment of Mr. Robinson to the office of 'civilizing' the Tasmanians at Flinders' Island. It would be tedious to detail the features of the 'civilizing' pursued there: it is sufficient to mention that every amusement peculiar to the aborigines has been discouraged; the cumbrous and uncivilized forms of advanced civilization have been introduced into every-day life; the native language has been as far as possible suppressed; native names have been yielded to those of the Cæsars, the Hannibals, the Scipios; a disposition to indulge in the pleasures of chance has been recorded as a delinquency; and the repetition of the Commandments and the Catechism is held as the evidence of religious progress, and a confession of all disbelief as to the capacity of uncivilized to appreciate the doctrines of Christianity. (*Report of the Commandant of Flinders' Island: Parliamentary, 1839*.)

An intelligent witness of the experiment carried out at Flinders' Island has thus reported upon it: 'The commandant has an establishment of thirty-two convicts, who wait on the aborigines, and supply the deficiencies of their own labour, and is rewarded by a great deal of writing, singing, rehearsal of the catechism, tallow mission, attachment, decorum, tranquillity, everything, in short, which gratifies superficial examination; and he persuades himself that he is eminently successful in his management of them: but they have no free agency, and are mere slaves at school, and they cannot escape from their prison. They cannot subsist at a distance from it, they must not break its rules, it must be a place of excessive punishment, to the moral agents they are lower now than when savages they die the faster, I fear, for much of this kindness the commandant imputes the mortality among them to the situation and climate, and wishes to transport them to the south coast of New Holland; but in six months I persuaded they would be, on this plan, happy savages bush.' (*MS. Letter*.)

TASSIE, JAMES, was born of humble parents about the year 1735, in the neighbourhood of Glasgow, and was brought up as a country stone-mason. Going to Glasgow on a fair-day to enjoy himself with his boys, he visited the collection of paintings exhibited by the brothers Foulis, who were then endeavouring to form an academy for the fine arts in that city. (*Fergusson's History of Glasgow*, p. 383.) Feeling a strong desire to become an artist, Tassie removed to Glasgow, and studied drawing in the academy, but continued to practise his business. He was poor, he was frugal, industrious, and persevering, hoping at least to become a statuary, if not a painter. In 1763, he went to Dublin, where he was employed some time as a sculptor and modeller. There he was acquainted with Dr. Quin, who was making eye in the beautiful art of imitating engraved gems by the use of coloured glass, or pastes, and who engaged Tassie as his confidential assistant. Having succeeded in making great improvements in the art by their joint efforts, Tassie was encouraged by his patron to remove to London, and to follow it as a profession. He reached London in 1766; and although, owing to his poverty and modesty, he had to struggle with many difficulties, he gradually emerged from obscurity, and attained a comfortable competence, and established such a reputation that the principal cabinets of Europe were thrown open to him. Among his earliest patrons in the metropolis was the Society of Arts, who, in 1767, awarded him the sum of ten guineas for imitations of antique onyx. In 1775 he then resided in Compton Street, Soho, and published a catalogue of the antique and modern gems in his collection, of which he sold pastes or sulphur impressions at moderate prices. The collection then amounted to more than three thousand articles; but it was subsequently much extended, and in 1791 appeared a new catalogue containing fifteen thousand eight hundred articles, forming two quarto volumes. This work, which was confined to a dry description of the gems, but a

seful information on that department of antient art, compiled by Mr. R. E. Raspe, who prefixed to the work an introduction on the utility of such a collection of works of art, and on the history of engraving upon stones, and the imitation of gems by artificial pastes. The work contains also a frontispiece and fifty-seven plates etched by David Allan. From Raspe's introduction it appears that the demand for Tassie's pastes was early, in the first instance, by the jewellers, who introduced them into fashion by setting them in rings, brooches, and other trinkets. He was very careful of his reputation, and would not issue imperfect impressions; the celebrity of his casts induced other and less skillful artists to sell their works under his name. About 1787 Tassie received an order from the empress of Russia for a complete set of his gems, which he executed in a satisfactory manner, in a beautiful white enamel ground, so hard as to strike fire with steel, and of texture as to take a fine polish, and to show every effect of the artist with the greatest accuracy. Wherever possible to do so, he coloured these in exact imitation of the originals; and in other cases such colours were used as might display the work to advantage. Tassie's art was continued by his nephew, William, on his removal to Leicester-square; and he added to the collection of casts of coins, from the museum of the late William Hunter, of which he made a set by order of the emperor Alexander, to add to the gems executed by his uncle, who died in 1799. Besides his art of art for which he is principally celebrated, Tassie displayed considerable talent in modelling small wax, from which he frequently made pastes. He was respected in private life for his piety, simplicity, and benevolence.

See Catalogue of Tassie's Gems, &c.; Dr. Gleig's Supplement to the third edition of the Encyclopædia Britannica (1801.)

TASSIE, DAN. [BOOTAN.]

TASSIE, BERNARDO, born at Bergamo in 1493, lost his father when a boy, and was brought up under the care of uncle Luigi Tasso, bishop of Recanati, who was also of Bergamo. The bishop being murdered by a rival in 1520, Tasso left his native town, and lived several years at Padua and Venice, and other towns in Italy, where he displayed his talent for poetical composition. In 1525 he engaged himself as secretary to Rangone, who was general of the Papal troops in Italy. In 1529 he went to the court of Ferrara, where he remained a short time. A volume of Italian poetry which he published at Venice in 1531 made him known to Ferrante Sanseverino, prince of Salerno, one of the Neapolitan barons, who kept a princely court in the feudal fashion of the times. The prince invited Tasso to Naples, granted him a handsome allowance, and liberty of withdrawing himself from time to time to apply to his poetical studies in rural retirement. Tasso accompanied the prince of Salerno in the expedition which Charles V. undertook against Tunis, and he was afterwards sent to Spain, in 1537, on a mission, and on his return he spent some time at Naples, where he became acquainted with the celebrated 'Aragona, the illegitimate daughter of a cardinal of the house of Aragon, who was herself a poetess, and led a very free life. Bernardo Tasso wrote verses in honour of her.

Having at last disentangled himself from this attachment, he returned to Naples, where he soon after married a young lady of Sorrento called Porzia de Rossi, with whom he had a son, Torquato. In 1547 an insurrection broke out at Naples against the Spanish viceroy Don Pedro Toledo, who, in concert with Pope Paul III., sought to establish the Inquisition in Naples after the manner of Spain. The people elected a sort of council of nobles and citizens, under the name of 'Union for the service of God, the emperor, and the city,' to govern temporarily the affairs of the country. This council appointed the prince of Sanseverino and the prince of Salerno its deputies to proceed to Germany and lay down their names before Charles V. Bernardo Tasso, against the advice of others, advised the prince to accept this office. The severino found the emperor highly incensed at the conduct of the Neapolitans, and fearing for himself, he went to Rome and entered the service of Henry II., for which he was declared a rebel by Charles V., and his property

was confiscated. Bernardo Tasso followed his patron to France, where, after a time, he found himself in great pecuniary distress. He then returned to Italy, and went to the court of Guidobaldo, duke of Urbino, from whence he passed to that of the duke Gonzaga of Mantua, who made him governor of Ostiglia, in which place he died in 1569.

Bernardo Tasso wrote a romantic poem in ottava rima, entitled 'Amadigi,' the subject of which is taken from a Spanish romance. [AMADIS DE GAULA.] The plot or plots of Tasso's poem are deficient in interest, but the style is good, and the poet excels in his descriptions and comparisons, but he indulges at times in licentious strains. After writing his poem, he detached one of the episodes and swelled it into a separate poem, entitled 'Floridante,' which was published after his death by his son. He also wrote five books of 'rime,' eclogues, hymns, odes, sonnets, and other lyrics, some of which are admired for their imagery and smoothness of versification. He introduced into the Italian language that species of poetry which is called 'pescatoria' and 'marinara,' being descriptive of the habits and occupations of fishermen and mariners. His letters have been published in three volumes.

(Corniani, *Secoli della Letteratura Italiana*; Tiraboschi, *Storia della Letteratura Italiana*; Panizzi, *Introductory Essay on the Romantic Narrative Poetry of the Italians*, prefixed to his edition of 'Bojardo.')

TASSO, TORQUATO, son of Bernardo, was born at Sorrento, in 1544. At the age of ten he was sent for by his father, then an exile, and after some time spent with him in several towns of north Italy, he went to the university of Padua to study law, for which however he had little inclination. At the age of eighteen he composed his first poem, 'Rinaldo,' in twelve cantos. The subject is romantic, and is taken from the old chivalric legends concerning Charlemagne and his wars with the Moors. Bernardo was at first angry with his son for neglecting his more serious studies, but at last he relented, and gave his consent to the publication of the poem, which Torquato dedicated to the Cardinal Luigi d'Este, brother of Alfonso II., duke of Ferrara. In 1566 the cardinal took him into his service as a gentleman attendant, and introduced him to his brother the duke, and to his two unmarried sisters Lucrezia and Eleonora. He was well received by all, and admitted into their familiar society. Tasso was young and amorous; he had been for some time passionately in love with Laura Peperara, a lady of Mantua, to whom he addressed many sonnets and other verses after the manner of Petrarch, styling her his Laura. This lady, with whom he had probably become acquainted during a visit which he paid to his father at Mantua in 1564, came some years after to Ferrara as a lady of honour of the duchess, and was married to Count Turchi of Ferrara. But in the mean time Tasso appears to have been struck with the personal attractions and mental accomplishments of the princess Eleonora, the duke's sister, and already in 1568 there is a sonnet by him, beginning 'Nel tuo petto real da voci sparte,' which is evidently addressed to a princess of a sovereign house. From that time he continued to write amatory verses evidently addressed to the same person, whom he styles his 'donna,' or mistress. In some of them he mentions the name of Eleonora, but as there were several ladies of that name at different times at the court of Ferrara, this has given rise to various surmises about the person meant. At last Tasso avowed in several ways his love for the princess, though, from the then existing usages of society, it was impossible that he could ever have obtained her hand. Most of the sonnets and other lyrics, which are evidently intended for this object of his second love, are conceived in a respectful and somewhat melancholy strain, as if the writer felt the hopelessness of his passion. The disparity of rank was in those times an insurmountable obstacle to any legitimate result of such an attachment, and the house of Este was one of the proudest in Italy. Like Petrarch, Tasso seems to have obtained friendship only in return for his love. But there are some of Tasso's compositions written between 1567 and 1570, in which he assumes the tone of a favoured lover. Such are the two sonnets 'Donna di me doppia vittoria avete' and 'Prima colla beltà voi mi vinceste,' the dialogue between love and a lover, beginning 'Tu ch' i più chiusi affetti,' and the madrigal which begins 'Soavissimo bacio.' From the context, although no name is mentioned, they all evidently allude to the same object as the

other amatory verses addressed to his 'donna.' There are also some autograph lines of Tasso discovered by Mai among the Falconieri MSS., and published by Betti at Rome (*Giornale Arcadico*, October, 1827), in which Eleonora is mentioned by name:

'Quando sarà che d'Eleonora mia
Posso godermi in libertade amore?
Ah, pietoso il destin tanto mi dia!
Addio cetra, addio lauri, addio rosore.'

It would appear that these verses, having been abstracted from Tasso's papers by some enemy, and shown to Duke Alfonso, first roused his suspicions.

Professor Rosini, in his able essay upon the 'Love of Tasso and the Causes of his Imprisonment,' Pisa, 1832, proves, in opposition to the assertion of Serassi and others, that Eleonora d'Este was the object of the above compositions, as well as of all the others addressed to his 'donna.' It is the four compositions last alluded to that constitute the real guilt of Tasso: they boast in prurient language of favours received, which, according to the best circumstantial evidence, were never granted, and which, if even granted, ought not to have been mentioned. And Tasso himself must have felt this, for when he set out for France at the beginning of 1571, to accompany Cardinal Luigi d'Este on a mission to Charles IX., he left his MSS. in charge of his friend Rondinelli, with directions to publish them in case he should die abroad, 'except those which he had written to oblige some friend, and which must be buried with him.'

This was a subterfuge to conceal the object of the above-mentioned compositions, and to make them appear as if written at the request of others, which in itself would have been no very creditable employment for a man of genius. However, before the end of the year 1571, Tasso took his leave of the cardinal in France. It would appear that while in that country, where he was introduced at the court of king Charles IX., and became acquainted with the French poet Ronsard, Tasso applied himself to study the points of controversy then debated between the Roman Catholic and the Reformed churches, and that his investigations of those delicate matters displeased the cardinal, who spoke to him strongly on the subject. But Tasso had other and secret reasons for wishing to return to Italy. Having returned to Ferrara, he entered the service of Duke Alfonso himself, by whom he was most graciously treated. 'The duke extolled his poetical talent; he often listened to the recital of his verses (Tasso was then engaged about his 'Gerusalemme,' which he intended to dedicate to the duke); he admitted him to his own table, and to his own familiar society; and he refused him no favour that he chose to ask.' (Serassi, *Vita del Tasso*; Rosini, *Saggio sugli Amori di Tasso*.) Such was the conduct of Duke Alfonso towards the poet, until he discovered, years after, his guilty compositions. Whilst Tasso was thus a favoured guest, rather than a dependant of Duke Alfonso, he wrote his pastoral drama, the 'Aminta,' in which he portrays with exquisite skill the pangs and the delirium of love deemed hopeless for a long season, but in the end requited. The drama was performed at the court of duke Alfonso, and its fame soon spread about Italy. Lucrezia, Eleonora's sister, who had married Francesco Maria, duke of Urbino, wishing to hear the 'Aminta,' invited Tasso to her court, where he remained several months. This was in 1573. While Tasso was absent from Ferrara, envy was busy at work against him to lower his credit with Duke Alfonso. At the same time Guarino, the poet, who was also at the court of Ferrara, strove to ingratiate himself with the princess Eleonora, and this excited the jealousy of Tasso. It appears that Tasso had been in the habit of writing to the princess, and sending her some of his poetical compositions; but now he wrote none for several months. At last he wrote her a letter, dated September, 1573, which was first published by his biographer Serassi, in which, after apologizing for his long silence, he sends her a sonnet, 'which,' he says, 'is not like those fine ones which I suppose your grace is now wont to hear very often,' alluding to those of his rival Guarino. And he goes on to say, that his sonnet is poor both in the conception and the style, as the author is poor of luck. This last expression cannot be understood as referring to his circumstances, for he was still in favour with both the courts of Ferrara and Urbino, and was receiving at the time presents from the duchess Lucrezia of Urbino. But still he sends to the princess Eleonora

the sonnet, 'hoping that, whether good or bad, it will produce the effect that he wishes.' This sonnet, which 'Sdegno, debil guerrier, champion audace,' is that of a sponding lover who asks for mercy. Tasso concluded his letter with the usual subterfuge, that 'the sonnet written on his own account, but at the request of a lover, who having been for a time angry with his is now no longer able to stand out, and surrenders and asks for mercy.' This and other passages of his verses, referred to by Professor Rosini in the above-quoted essay, prove that the princess Eleonora has long been aware of Tasso's passion, and felt flattered by probably looked upon it as a poetical feeling, for she gave him her friendship. He himself acknowledges in several places; and yet this same man had already in the recess of his study, the guilty compositions have been mentioned above.

Towards the end of 1573 Tasso returned to Ferrara where he applied himself to finish his great epic poem 'Gerusalemme.' The touching episode of Olinda and Sofronia, in the second canto, was meant to portray a situation with regard to the princess Eleonora; a sonnet which he wrote to that lady he evidently intended to use as the character of Sofronia as meant to represent her.

Parts of the 'Gerusalemme' began to circulate in MS., and the author was assailed by numerous critics. He thought that the duke and his sister Eleonora did not take up his defence with sufficient zeal; a slight sank deep into the poet's heart. Towards the end of 1576 a false friend, who was in the secret of his love for the princess, disclosed some particulars of it to others. Having heard of this, and meeting him in the court ducal palace, required him to deny what he had said; upon the other's refusal, gave him a blow in the face, which led to a duel; the treacherous friend came escorted by his relatives, who also drew their swords against the poet. Tasso, who was a good swordsman, succeeded in repelling their blows, and came away in triumph. Not long after this a quarrel happened after this until June of the following year, 1577, when Tasso, on the evening of the 17th of June, being in the apartments of the duchess of Urbino, Duke Alfonso's palace at Ferrara, fell into a violent fit of some impertinence real or supposed of a domestic, which he himself so far as to throw a knife after him. He was immediately arrested by order of duke Alfonso, and carried to a room which looked on the court of the palace. It appears that between these two incidents his own papers had been tampered with in order to give up his own papers. Tasso got information of this, and looked for a trusty servant from Urbino, and wrote on the 18th of June to Guido Baldo, marquis del Monte, and his letter is preserved by his biographer Serassi. He had also felt some scruples about matters of faith: he mentions in the course of Scipione Gonzaga, that he had doubts concerning many points of religion; he had even applied to the inquisitor of Bologna, who had granted him absolution, but still he thought himself under the censures of the church. All these things added to the anguish of his mind. From the place of his imprisonment Tasso wrote a submissive letter to the duke, begging his pardon, and the duke appearing to forgive him, released him after a few days, and took him with him to his country-seat at Riguardo about the end of June. What happened between the duke and Tasso is not ascertained, but from some expressions of the poet it appears that he was closely and sternly examined by the duke, who probably by this time in his possession Tasso's papers, 'in order to get from him an acknowledgment of what, if true, would incense him against him.' (Tasso's Sonnet, beginning 'Alma grande d'Alcide,' addressed to the duke Hercules, father of Alfonso.) On the 11th of July the duke sent Tasso back to Ferrara under an escort, and shut him up in the convent of St. Francis, his sister having written to the monks that he was mad, and to be treated as a madman.

Tasso's love adventures, his real or pretended madness, and the causes of his long imprisonment, made much noise about Italy at the time; and they have been much discussed and commented upon since, and have acquired an historical importance, especially as they serve to illustrate the manners of the times. Duke Alfonso has been much abused, and, we think, with discrimination, for his treatment of the poet. Th

ystery about the whole story resembling that which hangs over Ovid's banishment. Professor Rosini has collected with the greatest patience and care the discordant opinions, as well as the evidence resulting from Tasso's own writings, published and unpublished, and from those of his contemporaries; and the conclusion which he arrives at by the help of sound criticism is, that the Duke, acting in his hands the loose compositions of Tasso already mentioned, which joined to his other compositions addressed to the same person, and his other sayings and doings, furnished full evidence that Eleonora was the person alluded to in them, naturally enough incensed against the poet, and that the only reparation that he could make to his injured honour was to make it be supposed that Tasso died. This gives the clue to his subsequent treatment of the poet. He must also have been confident his sister was guiltless, otherwise, as Rosini observes, he would have taken a different sort of vengeance, according to the manners of the age. From the convent of Francia, Tasso wrote to the duke, saying, 'that the mercy of his highness had forgiven him his faults, and that he would do as he should do, if he spoke to any one, he should acknowledge all that which he clearly knew, that he was a man who needed a sanitary treatment.' He adds, that he had received, when the treatment was over, to turn monk; and in a postscript he says, that he earnestly wishes that the duke may know all the truth, that he may not think him a madman than he is. In a long letter which he afterwards wrote to the Duke of Urbino, he says, that 'in order to please Duke Alfonso, he thought it no disgrace to imitate the example of Brutus and Solon.' Both those examples, according to Livy and Plutarch, feigned madness. Receiving no answer from either Duke Alfonso or Duke of Urbino, Tasso, about the 20th of July, ran away from the convent, quitted Ferrara, and made his way alone and mostly on foot to Naples, and thence to Sorrento, where his sister was married. Having by kind treatment recovered his health and his spirits, he went to Rome, where he applied through some agent of the Duke to be allowed to return to Ferrara. Duke Alfonso wrote reply, that he was willing to receive Tasso again into his service, if he would allow himself to be treated by the physicians; but that if he continued his subterfuges, and talk as he had done before, he would immediately turn him out of his territories, and never allow him to return. Tasso, upon this, returned to Ferrara in the spring of 1578, in the habit of the Cavaliere Gualengo. He was civilly but coldly received by the Duke, who gave him to understand that he ought now to try to compose himself and to lead a quiet life, and to avoid all excitement. He attempted to have an interview with the Princess Eleonora and the Duke of Urbino, but was prevented. Tasso, tired of his life, having lost the favour which he used to enjoy at court, ran away again from Ferrara in the spring of 1578, wandered to Mantua, Padua, and Venice, and then went to Urbino, where he wrote to the duke of Urbino, who appears to have been then on bad terms with his wife and with the court of Ferrara, entreating him to make the truth known, and to contradict the reports maliciously 'circulated of his madness,' saying that he had submitted to it in obedience to Duke Alfonso's wishes, and that he could not consent any longer to lead an idle life, far from literature and from the Muses. He wrote in similar terms to his friend Scipione Gonzaga at Sorrento, to his own sister at Sorrento, and to the Arciprete of Urbino, to whom he sent a sonnet, beginning 'Falso è il nome che suona.' In October, 1578, he left Urbino, and went to Piedmont under an assumed name; but he was soon known, and his fame as a poet secured him a favourable reception from Charles Emmanuel, Prince of Piedmont, who offered to take him into his service upon terms as the Duke of Ferrara. But poor Tasso, with his eyes and his heart fixed upon Ferrara, and in obedience to the advice of his friends at Turin, and, among others, of the Marquis Filippo d'Este, Alfonso's relative, determined to go to Ferrara. He was encouraged to do so by letters from the Cardinal Albano, who it appears had been commissioned by the duke to induce him to do so, promising him a kind reception. He arrived at Ferrara on the 21st February, 1579, on the eve of the marriage of Margarita Gonzaga, the new bride of Duke Alfonso. The court was busy about the preparations

to receive the duchess. The duke refused to see Tasso, the princesses also denied themselves, his old apartments in the palace were closed to him, and the courtiers and court attendants treated him with rudeness and contempt. Tasso now became furious, and he uttered impertinent words against the duke and the whole house of Este, which being reported to Alfonso, he gave orders to arrest him and confine him in the hospital of St. Anna as a declared madman.

Tasso remained a prisoner in the hospital full seven years, till July, 1586. From some obscure passages of his own letters he appears to have been treated very harshly at first by the attendants of the hospital. He wrote to the duke, and to the princesses, but in vain. At last he grew more calm, and was treated with greater leniency. The wretched hole which is shown at Ferrara as having been his prison is no longer believed by competent judges to be the identical place of his confinement. (Valéry, *Voyages Littéraires en Italie*, book vii., ch. 14.) Political party-feeling in our age has contributed to exaggerate the hardships of Tasso's confinement, as religious party-feeling has exaggerated the sufferings of Galileo in a similar condition. There was hardship no doubt in both instances, and the hardship in Tasso's case was aggravated by the state of his own sore and unsettled mind. When Cardinal Scipione Gonzaga visited Tasso at St. Anna, in the spring of 1580, he was lodged in a large and commodious apartment, where he could write and correct his compositions. In November of the same year he was visited by Montaigne, who speaks of him as a man whose reason was overcome by the vivacity of his imagination. In July, 1581, the Lady Marfisa d'Este obtained leave of Alfonso to take Tasso with her for a few days to her country-house, where he had a philosophical discussion with her and her two ladies of honour, Tarquinia Molza, a learned woman, and Ginevra Marzia, upon the nature of love. From the recollection of this conversation, Tasso afterwards composed his dialogue, which he entitled 'La Molza, ovvero dell' Amore.' In September, 1582, Tasso received at St. Anna the visit of Aldo the younger, who brought him copies of some of the finest editions which had come out of his press, and they spent two days together in speaking of their respective studies. Tasso in the meantime was busy writing, or correcting his various poetical compositions which were printed at Venice, but very inaccurately, to his great annoyance. He wrote in his confinement several philosophical discourses or treatises, such as 'Il Gonzaga, ossia del Piacere Onesto,' 'Il Padre di Famiglia,' the discourse 'Della Virtù Eroica e della Carità,' the dialogue 'Della Nobiltà,' and others. His discourse to Gonzaga he says that it was wished that he should become insane, and that the cause, or at least one of the causes, of this persecution was some lascivious verses of his.

In 1583 Tasso grew seriously ill, he complained of his head, of his digestion, of singing in his ears, and other symptoms of a like nature. He consulted his friend Mercuriale, a physician of Padua, but Tasso was not a very docile patient; he wished for none but pleasant medications, and he would not submit to a total abstinence from wine. One of his vagaries was that he had a familiar spirit who appeared to him to comfort him. In 1584 he was allowed to be out at large during the Carnival season, and he wrote a curious dialogue on that circumstance entitled 'Il Gianluca, o della Maschere.' He enjoyed the society of Tarquinia Molza, of Count Girolamo Pepoli, and other noblemen and ladies of the court of Ferrara. He wrote about that time the dialogues 'Il Beltramo, ovvero della Cortesia;' 'Il Malpiglio, ovvero della Corte;' 'Il Ghirlinsono, ovvero dell' Epitaffio;' 'La Cavalletta, ovvero della Poesia Toscana;' and 'Il Rangone, ovvero della Pace,' which last, addressed to Bianca Capello, grand-duchess of Tuscany, is dated from his apartments of St. Anna, 'Dalle sue stanze in St. Anna.' He was now tolerably composed and reconciled, and could hardly be called a prisoner. In one of his autograph letters, written to the Marquis Buoncompagni, in April, 1585, and which is in the library of Ferrara, there is a passage copied by Valéry, in which he says that 'the duke does not keep me in prison, but in the hospital of St. Anna, where priests and monks can visit me at their pleasure, and no one prevents them from doing me good.' In several of his unpublished letters he gives directions about some articles for his wardrobe or his table, and shows a refined taste in both. But

in that same year, 1585, a fresh source of vexations opened upon him. His great epic poem, 'La Gerusalemme Liberata,' had been published complete at Parma in 1581, and afterwards at Mantua in 1584. A host of critics fell upon it, and by their strictures strove to obscure all the merits of the poem. At the head of them stood Salviati, of the Crusca Academy. Tasso's language, his poetical style, his imagery, the plot of his poem, his episodes, everything was made a subject of censure. Tasso, already weakened by mental and bodily suffering, felt these attacks bitterly. He however took up his pen and wrote in a measured and dignified tone a defence of his poem. He was at the same time writing letters to all his friends to obtain his final liberty from the duke. He wrote to the city of Bergamo, to the duke of Mantua, to the grand-duke of Tuscany, to the pope, to the emperor, who all employed their good offices on his behalf with Duke Alfonso, who hesitated a long time before he consented to his release. At last Vincenzo Gonzaga, son of the duke of Mantua, obtained, in July, 1586, permission for Tasso to accompany him to Mantua. His reception at that court was like a triumph. In order to make some return for the kindness which he experienced from the house of Gonzaga, he completed his tragedy of 'Torrismondo,' which he dedicated to his liberator Vincenzo, on his accession to the ducal throne of Mantua in 1587. The subject of the 'Torrismondo' is a supposed Scandinavian legend. Some of the descriptions have been admired. After some time spent at Mantua and in his paternal town of Bergamo, Tasso, depressed by a settled melancholy, took leave of Duke Vincenzo, and repaired to Rome in the latter part of 1587, and thence to Naples in the following year. The poet appeared delighted with the beauties of his native country. At Naples he began a lawsuit to recover his paternal property, which had been seized when his father Bernardo became an exile. The Neapolitan courts of law have been at all times proverbially known for their dilatoriness, and justice was wretchedly administered under the Spanish viceregal administration. Tasso made little progress in his suit. But he found a sincere friend in the Marquis Gio. Batista Manso, who took him in the autumn to his estate of Bisaccio, where they spent the time in sporting, listening to the rustic improvisatori, and conversing in the evening upon various topics, especially about Tasso's pretended familiar. It was at the request of Manso's mother that Tasso undertook his 'Sette Giornate del Mondo Creato,' which is a poetical paraphrase of the narrative of the creation of the world in the first two chapters of Genesis. In 1589, Tasso, always restless, repaired to Rome; but finding himself in great pecuniary distress, he accepted an invitation of the grand-duke Ferdinand de' Medici to go to Florence in the spring of 1590, where he was received with great honour by the court and other persons of distinction, as if to make amends for the annoyance given to him by Salviati and his compeers.

Towards the end of the same year however he went to Rome, and in 1591 he returned to Naples, and then applied himself to re-write his epic poem, under the title of 'Gerusalemme Conquistata,' in order to satisfy the critics. However the first version of his poem is in the hands of all, whilst few ever read his 'Gerusalemme Conquistata.' Tasso intended to end his days at Naples; but in 1592, Cardinal Aldobrandini having been made pope by the name of Clement VIII., his nephew, Cinzio Aldobrandini, afterwards cardinal, who was well acquainted with Tasso, invited him in the most pressing manner to Rome, where he came about middle of that year. He was stopped several days at Mola di Gaeta, the road being blocked up by the bands of the famous robber chief Marco Sciarra, who was scouring the country with perfect impunity. Sciarra, who was a man of birth and education, having heard that Tasso was detained at Mola, sent him a message to entreat him to proceed on his journey, assuring him of perfect safety from his men, and offering him an escort, which however Tasso declined; upon which Sciarra withdrew his men from the mountains of Itri, so as to leave the passage open for Tasso. Having arrived safely at Rome, he completed his 'Gerusalemme Conquistata,' which he dedicated to Cardinal Cinzio Aldobrandini. In the summer of 1594 he returned to Naples, and lodged first in the Benedictine monastery of San Severino, and afterwards went to a country-seat of his friend Manso. Meantime Cardinal Cinzio, out of affection and gratitude

towards Tasso, prevailed on Pope Clement to grant the poet the honour of being solemnly crowned with the laurel-crown in the Capitol, as Petrarch and others had been. This being agreed upon, Cardinal Cinzio hastened to announce the news to Tasso, urging him to repair to Rome as soon as possible. Tasso did not seem at all elated: he observed to Manso that he thought it more glorious to deserve honours than to receive them. He however assented, and took an affectionate leave of his kind friend Manso, with a foreboding that it would be the last. He spent the Christmas festivities at the monastery of Monte Casino, and arrived at Rome in the beginning of 1595. He was met outside of the gates by many gentlemen and attendants of the Papal court, by whom he was led in a kind of triumph to the Vatican palace, where he was introduced to the pope, who told him that he had awarded him the laurel-crown, in order that it might be as much honoured by him, as in former times it had served to honour others.' Tasso was lodged in the Papal palace, and treated with the greatest regard. While the day of the coronation was anxiously expected, Cardinal Cinzio fell ill; and Lent coming on, the pageant was postponed, and then Tasso himself fell seriously ill. He felt from the first a conviction that this illness would be his last; and wishing to compose himself in retirement for his last moments, he expressed a wish to be taken to the monastery of St. Onofrio, on Mount Janiculum. Having been carried thither in one of Cardinal Cinzio's carriages, he said to the prior and his monks who came to receive him at the gate, 'I am come to die amongst you.' He was led into a comfortable apartment, where he devoted his remaining days entirely to religious practices, and seemed totally weaned from worldly feelings and cares. When the pope's physician announced to him his approaching death, he embraced him, thanking him for the happy tidings. To Cardinal Cinzio, who came to take leave of him, he expressed his gratitude for all his kindness; and as the cardinal and those present could not refrain from tears, he said to them, 'You think that you are leaving me, but I shall go before you.' He expired on the 25th of April, 1595, after fifteen days' illness, being fifty-one years of age. He was buried, according to his desire, in the church of St. Onofrio, with a plain slab over his tomb, upon which the monks engraved the simple inscription, 'Torquasi Tassi ossa hic jacent.'

The lasting fame of Tasso as a great poet rests upon his 'Gerusalemme Liberata,' or 'Il Goffredo,' as it is sometimes called, one of the few great epic poems of which the world can boast. The action is complete: it relates the events of the great crusade, and ends with the ostensible object of that expedition, the deliverance of Jerusalem from the hands of the Moslems. The beauties, as well as the faults of the composition, have been the theme of many disquisitions. Among foreign critics, Blair, Voltaire, D'Alembert, La Harpe, and Chateaubriand have been loud in its praise. The poem has a peculiarity that distinguishes it from most other epics: it is essentially a Christian poem; and breathes throughout the feelings, the faith, and the hopes of a Christian. Tasso, as he says in his invocation,

'O Miam, tu che di caduchi allori
Non circondi la fronte lu illeona,
Ma su nel Cielo intra i beati cori
Hai di stelle immortali aurea Corona.'—(c. 1., st. 2.)

had drawn his inspiration from a sacred source, and has thus afforded a refutation to those who pretend that the Christian religion is not so favourable to poetical imagery as the splendid fictions of mythology. A melancholy tinge pervades the poem; but it is a melancholy lighted up by cheering and constant hope. With the single exception of the episode of the gardens of Armida, the language of the 'Gerusalemme' is eminently chaste, and the morality of its sentiments is pure and elevated, which renders it fit for the perusal of youth. Among its beauties of detail we will only instance the episode of Olindo and Sofronia, in the 2nd canto; the council of the demons in the 4th; the flight of Erminia, and her meeting with the old shepherd on the banks of the Jordan, in the 7th; the introduction of the Turk Solyman into the besieged city, in the 10th; the death of Clorinda, in the 12th; and the last fight of Argante with Tancred, in the 19th canto. The other poems of Tasso have been mentioned in the course of this article. His lyrical compositions are very

and many of them exquisite both in language and content. Besides those which are upon amorous subjects, some refer to contemporary events, or are in contemporary notices; others are upon religious subjects and others refer to his own misfortunes. The Tasso's poetical works have been published in 8vo. vol. of nearly 1000 pages, in double columns, 1833. Prefixed to it is the biography of the poet by his friend the Marquis Manso.

His prose works consist of dialogues and dissertations of which have been already noticed; of a Roman epic poetry, dedicated to Cardinal Pietro Ottoboni; discourses upon the poetical art, dedicated to the Duke of Gonzaga; and of numerous letters, some of which have remained unpublished till lately, 'Lettere inedite,' Pisa, 1827. Professor Rosini has edited a new edition of all the works of Tasso, begun at Pisa in 1820.

'Gerusalemme Liberata' has been translated into several European languages. There are English translations by Hoole, Broadhead, Hunt, and Wiffen. It has been paraphrased into several Italian dialects, Neapolitan, Calabrian, &c. The Life of Tasso has been written by Manso, Serassi, and others, and has been translated into English by Tiraboschi, Muratori, Zeno, and other Italian philologists.

TAZZI, ALESSANDRO, born of a noble family at Modena in 1565, was educated first in his native town, and then at Bologna and Ferrara, where he studied the law. In 1597 he went to Rome, when he entered the service of the Duke of Ascanio Colonna, whom he accompanied to the battle of Agnadino in 1600. In 1603 the cardinal, having been raised to the throne of Spain, sent Tassoni to Rome to take the administration of his property in Italy.

While in Spain Tassoni had opportunities of observing the state of that kingdom, which, after a long period of the preceding century by its ambition and the extent of its conquests, was now fast sinking into a state of weakness and decay under the weak reign of Philip III. At Rome he published his 'Considerazioni sopra il Petrarca,' published in which he commented very severely upon numerous errors and supposed, which he pointed out in the person of that generally admired poet. Endowed with a quick but somewhat captious mind, Tassoni aimed at opposing received opinions, and he employed sarcasm and ridicule for the purpose.

He took up the defence of Petrarch in his 'Risposte' to the criticisms of others, and this led to a controversy in the literary circles of Italian literary polemics. In 1612 he published his 'Pensieri Diversi' in ten books, being a collection of remarks on various subjects of science and which he had been in the habit for years of writing in his memorandum-book. Among other subjects he treated the Physics of Aristotle, although he does not seem to have had himself very correct notions of physical science. This work led to another controversy between Tassoni and several of his contemporaries.

Meantime the Duke of Modena had died, and Tassoni, being now without a patron, applied to Charles Emmanuel I., duke of Savoy, who promised him the post of secretary to his son, the Duke of Savoy. But partly through court intrigues, and partly on account of Tassoni's known aversion to the Duke of Savoy, with which the Duke of Saxony wished to form an alliance, he was kept waiting for years before he obtained possession of his office at the court of the Duke of Savoy then residing at Rome.

Certain committees were then formed, in which the court of Spain was handled, as well as another pamphlet entitled 'Della Monarchia di Spagna,' which appeared in the latter part of the period, were generally attributed to Tassoni. He thinks that the first two of the 'Filippiche' are his, and that the other five are by another pen. His work are very scarce. In 1623 Tassoni left the court of Savoy in disgust, and retired to a country-house in the suburb of Transtevere, where he employed study and rural occupations. About this time a portrait was taken with the rind of a fig in his hand, and a following distich written underneath:—

Dextera cur ficum queris mea gestet inanem?

Longi operis merces hæc fuit: aula dedit.

Cardinal Ludovisi, nephew of Pope Gregory XIII., introduced Tassoni into his service, and gave him an apartment in the Vatican palace, with a handsome stipend. After the death of Ludovisi, in 1632, Tassoni repaired to Modena,

when he was made councillor to his sovereign Duke Francis I. of Este, for the remainder of his life. He died at Modena in 1635.

Besides the works already mentioned, Tassoni made an abridgment in Italian of the 'Annals' of Baronius, and some 'Annotazioni,' or corrections and additions to the Italian vocabulary of La Crusca. But the work for which he is best known is his mock-heroic poem, 'La Secchia Rapita,' or the 'Rape of a Bucket.' He is considered as having first introduced this kind of composition in the Italian language, as he had finished, though not published in print, his poem years before his contemporary Bracciolini published, in 1618, his 'Scherno degli Dei,' in which he turns into ridicule the gods of the ancient mythology. Tassoni's poem was published in a printed form in 1622, but MS. copies had been in circulation long before. The subject is taken from the annals of his country under the year 1249, when a war having broken out between the two neighbouring cities of Modena and Bologna, the Modenese carried off in triumph a wooden bucket from within one of the gates of Bologna, which bucket is still seen suspended by a chain in the cathedral of Modena. The 'Secchia Rapita' has been generally admired by Italian as well as foreign critics. Voltaire speaks of it disparagingly, although he has borrowed from it (Valéry, *Voyages Littéraires*), but Perrault and other French critics have done Tassoni full justice. The humour of the poem is peculiarly Italian, and the admixture of the serious and heroic with the burlesque is happily combined. Some of the descriptive passages are exquisitely soft and true to nature, such as the song in canto viii. which begins: 'Dormiva Endimion tra l'erbe e i fiori,' and the beautiful episode in canto x. of the voyage of Venus from the mouth of the Arno to Naples for the purpose of engaging Manfred, son of Frederick II., to assist the Guibelines of North Italy. The 'Secchia Rapita' has gone through numerous editions: that of Barotti, Modena, 1744, is most splendid. Gironi has collected various judgments and comments upon this poem in his biography of Tassoni. Muratori has also written the Life of Tassoni.

(Tiraboschi, *Storia della Letteratura Italiana*; Corniani, *Secoli della Letteratura Italiana*; Zeno, *Note al Fontanini*.)

TASTE. The organs of this special sense are certain parts within the cavity of the mouth, obviously so disposed as to take early cognizance of matters about to be swallowed, and to act as sentinels for the remainder of the alimentary canal, at the entrance of which they are situated. Their special endowment, aided by an exquisite development of common sensibility, enables them to give timely notice of any acrid, caustic, or nauseous quality, of any undue temperature, of any inconvenient hardness, irregularity, size, or sharpness in the material submitted to them, and thus to protect the stomach against the intrusion of many hurtful agents. These organs moreover establish for our appetites a scale of liking and disliking: they superadd a discriminative pleasure to the enforced assuaging of hunger: they modify that merely quantitative ingestion, which is an absolute and daily need of the organism, with a qualitative choice, and so give a motive to those variations in diet which experience proves to be beneficial or necessary.

Common language (as in the word 'palatable') seems to attribute the sense exclusively to a part, which is by no means the only or chief seat of it. In order to give a more correct notion of its extent, we shall first briefly sketch the arrangement of the membrane which lines the cavity of the mouth. It is a continuation (a tubular folding in, as it were, through the aperture of the lips) of the general integument, the skin; and although somewhat changed in its grosser characters, it yet preserves, under the name of mucous membrane, a close resemblance to the parent tissue. It lines the inside of the cheeks, invests the alveoli, or gums, giving to these parts their polished smoothness of surface, is reflected from the lower alveolar arches to the tongue, from the upper alveolar arches to the palate, and from both these organs prolonged backward into the throat. In its palatine portion, the membrane covers the horizontal processes of the upper jaw, which divide the cavity of the mouth from that of the nose, and, while spread on this solid frame-work, is said to belong to the hard palate; and it likewise extends backward, beyond the limits of this bony partition, to form a pendulous flap, called the soft

palate; which, with the nipple-like uvula, that hangs from its extreme edge, may readily be seen when the mouth is opened. In extending to the tongue, the membrane is so arranged as to leave the tip and sides of that organ prominent and free; and is remarkably developed into a vast number of minute eminences called *papillæ*, which cover the borders and surface of the tongue, are largely supplied with nerves and blood-vessels, and variously concerned in the functions of the part. [TONGUE; PALATE.]

Very careful experiments on the sense of taste have been made by MM. Guyot and Admyrauld (*Mémoire sur le Siège du Goût chez l'Homme*, Paris, 1830), from which the following results are obtained:—A small portion of the soft palate, just above the base of the uvula, the remotest part of the back of the tongue, where it corresponds to the isthmus of the palate, and the entire circumference of the tongue, are so endowed; while the internal surface of the cheeks, the hard palate, the gum, the remaining parts of the soft palate and of the tongue are entirely destitute. Thus, those parts of the tongue with which, in sipping or in masticating, the food would have contact (its borders, and, most eminently, its tip), are gustative; and the property is shared, though in a less degree, by the lingual and palatine surfaces of the isthmus through which the food enters the sphere of involuntary actions.

The nerve, specially endowed with the sense of taste, is a branch of the third part of the fifth cerebral nerve, called, from its function, gustatory; but it seems possible to some physiologists that the glosso-pharyngeal nerve shares this property. The gustatory nerve is distributed to the papillary surface of the tongue, especially along its borders and tip; the lingual part of the glosso-pharyngeal nerve is restricted in its distribution to the posterior part of the tongue, where it supplies the mucous surface exclusively.

For the sensation of taste, moisture must be present; all are familiar with a temporary impairment of the sense, under the influence of unusual dryness of the surface of its organs; the parched tongue of fever is notoriously indifferent to all savours. Matters are only capable of being tasted when they exist in a fluid form: an insoluble body is insipid; a solid body provokes an immediate flow of saliva, and its sapid qualities are perceived in proportion only as it dissolves: certain gases are alleged to excite sensations of taste; but it is only by such as are soluble in the saliva (sulphurous acid, for instance), and only in proportion as they are dissolved that these impressions are produced.

“The sensation of taste undoubtedly admits of an immense variety of modifications which no language can express. If a man were to examine five hundred different wines, he would hardly find two of them that had precisely the same taste: the same thing holds in cheese, and in many other things. Yet of five hundred different tastes in cheese or wine, we can hardly describe twenty, so as to give a distinct notion of them to one who had not tasted them.” The vague, or not-to-be-described, nature of gustatory impressions, as here expressed by Dr. Reid, receives some additional obscurity from the circumstance that taste and smell are often simultaneously affected in a manner which renders it difficult to abstract either. Various substances, after exciting the sense of touch on the fauces, and that of taste on the tongue, are capable of producing a third impression, which is popularly referred to the palate, but is really felt upon the sentient membrane of the nostrils: the fume of certain kinds of food ascends into the cavities of the nose, and produces this third and distinct sensation: in administering medicine to children, it is well known that the greater part of what is disagreeable in its flavour may be avoided by closing the nostrils when the draught is swallowed; and by repeating this experiment upon various articles of food, it is easy to ascertain how much of their flavour depends upon one sense, and how much is appreciated by the other.’ Mr. Mayo, from whom this paragraph is quoted, goes on to classify the impressions produced by substances taken into the fauces:—

1. Where sensations of *touch* alone are produced, as by rock-crystal, sapphire, or ice.
2. Where, in addition to being felt upon the tongue, the substance excites *sensation in the nostrils*, as for instance tin and other odorous metals.
3. Where, besides being felt upon the tongue, it produces sensations of *taste*, as, for instance, sugar and salt.
4. Where the substance is felt on the tongue and tasted

by it, and in addition excites a sense of flavour in the nostrils, as, for instance, bread, manna, and other substances. (*Outlines of Physiology*, p. 314.)

Flavour, then (in distinction from *taste*), can in correctness be attributed only to bodies possessed of some or volatility; and, by alternately smelling and tasting and by contrasting their impression with that produced by a simply sapid substance (mustard and salt can illustrate the two cases), it will be noticed that flavour is distinguished from odour, which, from its affecting a comparatively tised part of the olfactory apparatus, is at first imperceptible and obscurely recognised.

Such are the chief relations of the sense of taste in and in the animals which most nearly resemble human structure. As the sense is a provision for the service of the digestive organs, we may on sound physiological grounds anticipate its existence, under a more or less modified form, in every animal possessing a digestive system. No special organ for its exercise (with very doubtful exceptions) can be traced in the invertebrata; nor can we assume to infer in them the presence of taste, as an obscure sense determining their choice of food: to this extent it undoubtedly exists in the lowest to the bottom of the scale—to the infusory animal which Ehrenberg has witnessed its exercise. In the invertebrata, mollusks possess the most highly developed alimentary organs, and it seems probable that in the guiding sense of those organs has a corresponding development.

Through the subregnum of vertebrata it advances with maturation: in the lower classes, fishes and reptiles, the organs are present, but seem rather to be adapted to the movements of prehension and of deglutition, to the sense of taste: in birds too the organs are developed, and the sense seemingly imperfect: in the class of mammalia it is gradually augmented in perfection; but although in certain orders of them, or in particular individuals, the sense appears sharp and delicate, in some it is fastidious, it is probably in man alone that the sense and their function are completely matured.

TASTE, according to the definition of Sir John Millar, ‘is that act of the mind by which we like or dislike whatever be the subject.’ (*Discourses before the Society*; Discourse vii.)

Taste is frequently spoken of as a gift, as somewhat dependent of rules, a kind of instinct, bestowed liberally in degree upon some men than upon others. It has been treated by some writers as the result of chance, as having no uniform or permanent principles, the ground of its decisions. Others have resolved it into different complex elements, whose joint development determined by certain principles of beauty or sublimity, things external.

Lord Bacon has been quoted as apparently sanctioning the idea of taste being a kind of gift or instinct. ‘I cannot tell,’ he says, ‘whether Apelles or Albert Dürer were more the trifier; whereof one would make a page of geometrical proportions; the other by taking the best parts out of divers faces to make one excellent painter must do it by a kind of felicity, and not by Sir Joshua Reynolds has overthrown this position: ‘Every object which pleases must give us pleasure upon some certain principles.’ These principles are unquestionably so intelligible that they may be expressed in the form of words, and may be drawn out into a course. Burke, towards the end of his essay on Taste (introduced to the Sublime and Beautiful), has likewise adopted this position, which will come under notice again in the course of this article.

The hypothesis which refers our emotion of taste to the influence of fashion, or temporary and varying causes, has been maintained in the *Inquiry into the Principles of Taste*, by Mr. Payne Knight. According to Mr. Knight, there is scarcely any subject upon which men differ more than concerning the objects of their pleasures and amusements; and this difference subsists not only among individuals, but among ages and nations; almost every generation accusing that which preceded it of bad taste in building, furniture, and dress; and almost every nation having its own peculiar modes and ideas of excellence in these matters, to which it pertinaciously adheres, until one particular people has acquired such an ascendancy in power and reputation as to set what is called the fashion, when this

On is indiscriminately adopted upon the blind principle of imitation, and without any consideration of the forces of climate, constitution, or habits of life, and one who presumes to deviate from it is thought an mortal, a humorist void of all just feeling, taste, or ce. The fashion continues in the full exercise of its way for a few years or months, when another, perhaps more whimsical and unmeaning, starts into being and ses it; all are then instantly astonished that they could have been pleased even for a moment with anything steless, barbarous, and absurd. The revolutions in dress not to mention those in building, furnishing, garden- &c., which have taken place within the last two cen- afford ample illustration. . . . 'Let no one imagine,' Mr. Knight, 'that he solves the question by saying there have been errors in taste, as there have been in and philosophy; for the cases are totally different: and philosophy being matter of belief, reason, and n; but taste being a matter of feeling, so that what- was really and considerably thought to be ornamental have been previously felt to be so; and though ons may by argument or demonstration be proved rong, how shall an individual pretend to prove the igs of a whole age or nation wrong, when the only riterion he can apply to ascertain the rectitude of his is their congruity with those of the generality of his t.' (c. i., p. 1.)

Argument is founded on an exaggeration of a fact ence to the philosophy of taste admitted by those contend that taste is determined by some definite and able principles: the fact may be described under eneral head of the influence of association on our ions of this order. Mr. Dugald Stewart has observed e exaggeration in question, that the association of can never account for the origin of a new notion, or pleasure essentially different from all the others which ow. It may indeed enable us to conceive how a indifferent in itself may become a source of pleasure ing connected in the mind with something else which turally agreeable; but it presupposes in every in- e existence of those notions and those feelings it is its province to combine: inasmuch that it will and wherever association produces a change in our ents in matters of taste, it does so by cooperating some natural principle of the mind, and implies the nce of certain original sources of pleasure and un-

This suggests a distinction in the circumstances, e please in the objects of taste, between those which e in consequence of casual associations and those e are fitted to please by nature. The perfection of in reference to the last depends upon the degree in e the mind is free from casual associations; in re- e to the first it depends upon the facility with which associations are formed. (*Elements of the Philosophy Human Mind*, c. v., p. ii., p. 364, 4to.)

Two different modes in which association operates have e illustrated with much elegance, and their true place e philosophy of taste distinguished, by Mr. Alison: ion,' he remarks, 'may be considered in general as m of the great. It is the dress, the furniture, the e, the manners of the great world, which constitute e called the fashion in each of these articles, and e the rest of mankind are in such haste to adopt after e example. Whatever the real beauty or propriety of e articles may be, it is not in this light that we con- e them. They are the signs of that elegance and taste e splendour which is so liberally attributed to elevated e they are associated with the consequence which such e bestow; and they establish a kind of distinction e his envied station and those humble and mor- e conditions of life to which no man is willing to

It is in the light therefore of this connection only e are disposed to consider them; and they accord- e affect us with the same emotion of delight which we e from the consideration of taste or elegance in more e instances.' (*Essays on Taste*, Essay i.)

Association then can only modify, it cannot wholly ac- e our emotion of taste, and it cannot even modify e by operating in a manner which implies certain ori- e ces of pleasure and uneasiness in the objects of e ion. In some cases association heightens the e or disagreeable effect of objects; in others all e or disgust which we experience can be resolved e. C., No. 1500.

into the influence of association. The distinction implies the fact insisted on. What constitutes the distinction, or where are we to find its explanation? We may with propriety employ our reason in reducing particular phenomena to general principles; but we must in the end arrive at principles of which there is no other account to be given than that such is the will of the author of our nature. We cannot explain why such forms please or displease; we must stop short at the discovery of the respects in which they please or displease. (Stewart.)

Sir Joshua Reynolds has referred the idea of beauty to some 'central form' in the objects of our perception. 'All the objects which are exhibited to our view by nature, upon close examination, will be found,' he says, 'to have their blemishes and defects. The most beautiful forms have something about them like weakness, minuteness, or imperfection: but it is not every eye that perceives these blemishes; it must be an eye long used to the contemplation and comparison of these forms; and which, by a long habit of observing what any set of objects of the same kind have in common, has acquired the power of discerning what each wants in particular. This long laborious comparison should be the first study of the painter who aims at the greatest style. By this means he acquires a just idea of beautiful forms; he corrects nature by herself, her imperfect state by her more perfect. His eye being enabled to distinguish the accidental deficiencies, excrescences, and deformities of things from their general figures, he makes out an abstract idea of their forms more perfect than any one original; and, what may seem a paradox, he learns to design naturally by drawing his figures unlike to any one object. (*Discourse III.*) He observes in explanation in another part of the same discourse: 'To the principle I have laid down, that the idea of beauty in each species of beings is an invariable one, it may be objected, that in every particular species there are various central forms which are separate and distinct from each other, and yet are undeniably beautiful; that in the human figure, for instance, the beauty of Hercules is one; of the Gladiator another; of Apollo another; which makes so many different ideas of beauty. It is true indeed that these figures are each perfect in their kind, though of different characters and proportions; but still none of them is the representation of an individual, but of a class: and as there is one general form which, as I have said, belongs to the human kind at large, so in each of these classes there is one common idea and central form, which is the abstract of the various individual forms belonging to that class. Thus, though the forms of childhood and age differ exceedingly, there is a common form in childhood and a common form in age, which is the more perfect as it is more remote from all peculiarities. But . . . though the most perfect forms of each of the general divisions of the human figure are ideal, and superior to any individual form of that class, yet the highest perfection of the human figure is not to be found in any one of them. It is not in the Hercules, nor in the Gladiator, nor in the Apollo, but in that form which is taken from all, and which partakes equally of the activity of the Gladiator, of the delicacy of the Apollo, and of the muscular strength of the Hercules. For perfect beauty in any species must combine all the characters which are beautiful in that species. It cannot consist in any one to the exclusion of the rest; no one therefore must be predominant, that no one may be deficient. . . . There is likewise a kind of symmetry or proportion which may properly be said to belong to deformity. A figure lean or corpulent, tall or short, though deviating from beauty, may still have a certain union of the various parts, which may contribute to make them on the whole not displeasing.'

This theory (the principle of which extends to other objects of taste besides those contemplated by Sir Joshua Reynolds) reconciles the apparent inconsistency, insisted on by Mr. Payne Knight and by other writers of the same school, between the decisions of taste in one country and in another, as tending to show that the standard of taste is wholly arbitrary. The ideal beauty of the African is the result of the process which has been described applied to the coloured inhabitants of Africa, as the ideal beauty of the European is the result of the same process applied to the inhabitants of Europe. To institute a comparison between the beauty of the European and that of the African, and to conclude that taste has no invariable

principle: as its foundation, from the opposite decisions on such a comparison, involves the same description of error as it would be to arrive at the same conclusion from the opposite decisions in a comparison between the beauty of two distinct species of animals, the one biped and the other quadruped. There is a 'central form' of beauty proper to the different races of mankind; to the two sexes of the different races; to different ages; and so on in reference to inferior animals and objects of inanimate nature. We trespass beyond the province of mere taste when we compare objects in respect to which the principles of beauty are altogether distinct.

Much obscurity has arisen in discussions on the subject of taste from the twofold sense in which the word taste has been employed, as expressive of an emotion, and of something objective in which there exists an aptitude to produce emotion. The term taste strictly applies to the emotion only; the theory of the different causes by which the emotion is produced belongs to the subject of beauty. We have been obliged to refer to the theory of beauty in the preceding part of this article in establishing the reality of certain principles determining our emotions of taste: in what follows we shall confine ourselves to the explanation of taste in its restricted or proper sense.

When any object either of sublimity or beauty is presented to the mind, we are conscious of a train of thought being immediately awakened analogous to the character or expression of the original object. The landscapes of Claude, the music of Handel, the poetry of Milton, excite feeble emotions in our minds when our attention is confined to the qualities they present to our senses, or when it is to such qualities of their composition that we turn our regard. It is then only we feel the sublimity or beauty of their productions, when our imaginations are kindled by their power, when we lose ourselves amid the number of images that pass before our minds, or when we waken at last from the play of fancy as from the charm of a romantic dream. (Alison, c. i., sect. 1.)

The trains of thought which are thus suggested are distinguished in the nature of the ideas or conceptions which compose them, and in the nature or law of their succession. In the case of those trains of thought which are suggested by objects either of sublimity or beauty, they are in all cases composed of ideas capable of exciting some affection or emotion. Mr. Alison has supposed that not only the whole succession is accompanied with that peculiar emotion which we call the emotion of beauty or sublimity, but that every individual idea of such a succession is in itself productive of some simple emotion or other. But to this it has been objected, and we think truly, that such a train of images passing before the mind, and images accompanied with lively emotion, could scarcely fail to be remembered by us; or, at least, if they are not remembered by us, there is no reason, *a priori*, to suppose the existence of them. (Brown, *Lectures on the Philosophy of the Human Mind*, lecture lvii.)

There is this distinction between the emotions of taste and all our different emotions of simple pleasure, that in the case of these last emotions no additional train of thought is necessary. The pleasurable feeling follows immediately the presence of the object or quality, and has no dependence upon anything for its perfection but the sound state of the sense by which it is received. The emotions of envy, pity, benevolence, gratitude, utility, propriety, novelty, &c. might undoubtedly be felt, although we had no such power of mind as that by which we follow out a train of ideas, and certainly are felt in a thousand cases when this faculty is unemployable. In the case of the emotion of taste, on the other hand, it seems evident that this process of mind is necessary, and that unless it is produced these emotions are unfelt. Whatever may be the nature of that simple emotion which any object is fitted to excite, whether that of gaiety, tranquillity, melancholy, &c., if it produce not a train of kindred thought in our minds, we are conscious only of that simple emotion. Whenever, on the contrary, the train of thought which has been mentioned is produced, we are conscious of a higher and more pleasing emotion; and which, though it is impossible to describe in language, we yet distinguish by the name of the emotion of taste. The emotions of taste may therefore be considered as distinguished from the emotions of simple pleasure, by their being dependent upon the exercise of our

imagination; and though founded in all cases upon a simple emotion, as yet further requiring the employment of this faculty for their existence (*Essay* i., conclusion, s. u., Alison); or, rather than the *employment* a word which seems to intimate a deliberate intended act, in the process of imagination), as Dr. Brown would say, the operation of the common laws of suggestion in the mode to which we apply the word imagination.

The suggestion of trains of kindred or harmonising images which has been pointed out as distinguishing the emotion of taste, accounts for the more enlarged susceptibility in some than in others of this emotion. The more our ideas are increased or our conceptions extended upon any subject, the greater the number of associations we connect with it, the stronger is the emotion of sublimity or beauty we receive from it. 'What is it' says Mr. Alison 'that constitutes that emotion of sublime delight, which every man of common sensibility feels upon the first prospect of Rome? It is not the scene of destruction which is before him. It is not the Tiber, diminished in his imagination to a paltry stream, and stagnating amid the ruins of that magnificence which it once adorned. It is not the triumph of superstition over the wreck of human greatness, and its monuments erected upon the very spot where the first honours of humanity have been gained. It is antient Rome which fills his imagination. It is the country of Cæsar, and Cicero, and Virgil, which is before him. It is the mistress of the world which he sees, and who seems to him to rise again from her tomb, to give laws to the universe. All that the labours of his youth or the studies of his maturer age have acquired, with regard to the history of this great people, open at once before his imagination, and present him with a field of high and solemn imagery, which can never be exhausted.'

'The beauty of a theory or of a relic of antiquity is unintelligible to a peasant. The charms of the country are altogether lost upon a citizen who has passed his life in town.' It is on the principle in question that Burke remarks that the excellence and force of a composition must always be imperfectly estimated from its effect on the minds of any, except we know the temper and character of those minds. (*Introduction to the Sublime and Beautiful*.)

The rules by which taste is determined vary with the objects to which its decisions refer: but in respect to all, this general principle holds, that a composition is to be judged by its fitness to produce the end designed by it. If to please, to instruct, to move, to create laughter, be its design, its merits are to be determined by its aptitude to produce any of these effects. If its objects be to please, &c. only a particular people or class, it is to be estimated under the given circumstances. If its object be to give pleasure or instruction to all ages and conditions of society, it is to be estimated by its correspondence with those universal principles of human nature which it contemplates. That composition is the highest which is of the last description. (Hume's *Essay on the Standard of Taste*.)

The reader who may desire to see this subject further discussed is referred to the article BEAUTY: to Mr. Alison's *Essays*; to Brown's *Lectures on the Philosophy of the Human Mind*, lecture lvii.; Hume's *Essay on the Standard of Taste*.

TATARS. [TARTARS.]

TATE, NAHUM, was born in Dublin in the year 1652. His father was Dr. Faithful Tate, a clergyman in Ireland. He was educated at Trinity College, Dublin, whence he removed to London. On the death of Shadwell in 1690, the interest of Tate's friends procured him the situation of poet-laureate, which he held till his death. He seems to have been an improvident man, and somewhat addicted to intemperance. In the latter part of his life he resided in the precincts of the Mint, in Southwark, where he died, August 12, 1715. The Mint was then considered a privileged place, where debtors were not liable to arrest. This supposed privilege however was put down by statute 9 Geo. I.

Tate wrote 'Memorials for the Learned, collected out of eminent Authors in History,' 8vo., 1696; 'Characters of Virtue and Vice described and attempted in Verse, from a Treatise of Joseph Hall, Bishop of Exon,' Lond., 1691; 'Miscellanea Sacra, or Poems on Divine and Moral Subjects,' Lond., 1698, 8vo.; 'Panacea, a Poem on Tea,

1700; besides Birth-Day Odes, and an Elegy on the death of Queen Mary. He was also the author of ten dramatic pieces, tragedy, comedy, and opera, among an alteration of Shakspeare's 'Lear,' which kept for many years, but has for some time been superseded by the original.

It is chiefly known now by his metrical version of the Psalms, which he executed in conjunction with Dr. N. Brady [BRADY], and which is now commonly added to the Book of Common Prayer of the Church of England. This version, though not of high merit, has long taken the place of the former version by Sternhold and Hopkins. [STERNHOLD.] The first publication of an 'Essay of a New Version of the Psalms of David, consisting of the first Twenty, by N. Brady and N. Tate,' Lond., 1695, 8vo.; this was followed by 'A New Version of the Psalms of David, fitted to the Tunes used in the Church of England, by N. Tate and N. Brady,' Lond., 1698, with a Supplement of Church Hymns, Lond., 1700, 8vo. See also Reed's *Biographia Dramatica*, by Reed and Jones; *Bibliotheca Britannica*.)

TATIANUS, of Assyria, was a pupil of Justin Martyr, whose death he wrote an apology for Christianity, in the title of 'A Discourse to the Heathen' (*Λόγος Ἀπὸ τῶν Ἑθνικῶν*). In this work he gives some account of his own life. He was brought up in heathenism, the different forms of which became known to him by his many travels, and all those forms appeared to him unsatisfactory. He turned his attention to the Old Testament, and he thought he saw the impress of truth. Arriving in Antioch, where he practised as a rhetorician, he met with Justin Martyr, by whom he was converted to Christianity. After the death of Justin he embraced some heretical opinions, the germs of which may be seen in his 'Discourse to the Heathen.' The chief of his heresies were the Gnostic doctrines of the two principles of good and evil, the evil of matter [MARCIONITES], and the Valentinian doctrine concerning Æons. His followers were howbeit remarkable for the practical application they gave to their Marcionite opinions by lives of the strictest asceticism. They lived in celibacy, refused all luxuries, and abstained from the use of wine even at the Lord's Supper. They were called Encratites (*Ἐγκρατῖται*), Apotactites (*Ἀποτακτικοί*), and Hydroparastatae (*ὕδρον παραστάται*). It must be observed that these terms were often applied to all ascetics. The Tatianists were Encratites, but not all Encratites were not Tatianists. The date of his heresy is placed by Eusebius in the year A.D. 172.

His most works the chief were a treatise on 'Perfection, the Pattern of the Saviour' (*περὶ τοῦ κατὰ τὸν ἀριστοῦ*), and a 'Harmony of the Four Gospels' (*ὁμοίωσις τῶν τεσσάρων*). The latter work is particularly valued by Theodoret, who found 200 copies of it in the churches, which he took away from the people on account of the heresies contained in the book. For this chiefly, Neander supposes that the Harmony of the Gospels was not simply compiled from the narratives of the Evangelists, but contained also many things out of the apocryphal Gospels. Some writers, among whom is Neander, think that Tatian's 'Harmony' is still extant in an MS. in the Vatican Library.

An apology is usually printed with the works of Justin Martyr. There are separate editions of it by Gesner, 1546, fol.; and by Worth, Oxon., 1700, 8vo.

See Hieronymus, *De Vir. Ill.* 29; Clemens Alexand., *Strom.*, iii. 12; Lardner's *Crit. Hist.*, pt. ii., c. xliii., &c.; xxxvi., sec. 2; Neander's *Der Christ. Relig. und Kirche*, i., p. 762, and

TATIANUS, ACHILLES. [ACHILLES TATIUS.]

TATIANUS, A. [HINDUSTAN, XII., 221.]

TATTON. [LINCOLNSHIRE.]

TATTOOING is the name usually given to the custom, among many uncivilized tribes, of marking the skin with punctures or incisions, and introducing into them fluids, so as to produce an indelible stain. It is first mentioned in Captain Cook's account of the South Sea Islands under the name *tattouing*; and, with trifling differences in the orthography, the same name is applied by writers to similar practices among other people. The word 'tattoo' appears to be formed by a reduplication of the Sanskrit verb 'ta,' meaning to strike, and therefore to denote the method of performing the operation, and, if

this supposition be correct, it has a curious resemblance to the English word tattoo, meaning a particular beat of the drum.

From a passage in the book of *Leviticus*, chap. xix., v. 28, in which the Israelites are forbidden to make any cuttings in their flesh for the dead, or to *print any marks* upon their bodies, it has been supposed that some custom resembling tattooing was practised in the time of Moses. A note upon this passage in the 'Pictorial Bible' states, that although tattooing seems to have been commonly practised in England rather as a custom of savage islanders than anything more, it is also an Oriental custom, and that too among people whose proximity to the Hebrews affords a reason for the prohibition contained in the text referred to. 'The Bedouin Arabs, and those inhabitants of towns who are in any way allied to them,' observes the author of this note, 'are scarcely less fond of such decorations than any islanders of the Pacific Ocean. This is particularly the case among the females, who, in general, have their legs and arms, their front from the neck to the waist, and even their chins, lips, and other prominent parts of the face marked with blue stains in the form of flowers, circles, bands, stars, and various fanciful figures. They have no figures of living objects, such being forbidden by their religion; neither do they associate any superstitions with them, so far as we are able to ascertain. They probably did both before the Mohammedan æra, as their descendants in the island of Malta do at present. The men there generally go about without their jackets, and with their sleeves tucked up above their elbows, and we scarcely recollect ever to have seen an arm, thus bare, which was not covered with religious emblems and figures of the Virgin, or of some saint under whose immediate protection the person thus marked conceived himself to be.' 'Thus also,' proceeds the author, 'persons who visit the holy sepulchre and other sacred places in Palestine have commonly a mark impressed on the arm in testimony of their meritorious pilgrimage.' The works of ancient writers contain many notices of the practice of tattooing, as practised by several barbarous races. As to the Britons, Cæsar merely describes their custom of staining their bodies with vitrum, or woad; but Solinus represents the process as a laborious and painful one, but permanent in its effect; and speaks of the painting as consisting chiefly of the figures of animals, that grew with the growth of the body. Herodotus says they punctured their bodies with the figures of all sorts of animals. Isidore is still more explicit; for, in speaking of the Picts, whose name he derives from their coloured skins, he tells us that the painting was done by squeezing out the juice of certain herbs upon the body, and puncturing the figures with a needle.' (*Pictorial History of England*, vol. i., p. 129.) Cæsar supposed that this practice was adopted for the purpose of terrifying their enemies; but probably this kind of skin-painting was the national dress, and if so, it may have existed in its highest state of perfection at a period anterior to the Roman invasion. Tattooing may also have been practised by our ancestors as a means of distinction, as well as from the love of ornament. Thus Herodotus, who describes the habits of the Thracians, says that to be tattooed or marked (*τοριξθαι*) was an emblem of rank, and the want of it indicated meanness of descent (v. 6). The extended use of clothing at a later period rendered such ornaments superfluous, and led to the decline and subsequent abandonment of the practice. 'It is therefore,' says the 'Pictorial History of England,' 'that we hear no more of this tattooing in the south (of Britain) after it was subdued and civilised into a Roman province, though it still continued among the rude tribes of the north, where it lingered until it was banished thence also by the full attire of civilization.' In a subsequent part of the same volume (p. 329) it is stated that the custom of tattooing, or puncturing the skin, was practised by the Anglo-Saxons as well as by the Britons, and that a law was passed against it in the year 785. It was nevertheless continued during the whole of the Anglo-Saxon period, and is among the English vices reprobated by William of Malmesbury after the Norman conquest. Several other ancient notices on the subject are collected by Lafitau, in his 'Mœurs des Sauvages Américaines,' which work is cited in the volume on the 'New Zealanders' in the 'Library of Entertaining Knowledge,' where much information respecting tattooing is given.

In modern times the custom of tattooing has been found in most of the islands of the Pacific Ocean, and among many of the aboriginal tribes of Africa and America, as well as, on a limited scale, as before stated, in the East. Much curious information on the various kinds of tattooing is collected in the volume on the 'New Zealanders,' previously cited. From this work we condense the following account of the process of tattooing, as performed in New Zealand upon an English sailor, named John Rutherford, who was captured by the natives in 1816, and resided among them for nearly ten years, and upon some companions who were taken with him:—The natives having seated themselves on the ground in a ring, the Englishmen were placed in the middle, stripped of their clothes, laid down on their backs, and held by five or six men each, while two others commenced the operation of tattooing. Having taken a piece of charcoal, and rubbed it upon a stone with a little water, so as to produce a thick liquid, they dipped into it an instrument made of bone, with a sharp edge like a chisel, and shaped in the fashion of a garden-hoe. They then applied the instrument to the skin, and struck it twice or thrice with a piece of wood, thereby making it cut into the flesh as a knife would have done, and causing a great deal of blood to flow, which they kept wiping off with the side of the hand, in order to see whether the impression was made sufficiently clear. If not, they applied the cutting-instrument again to the same place. Various instruments were however employed in the course of the operation, one sort being made of a shark's tooth, and another having a serrated edge; and they were used of different sizes, to suit the different parts of the work. Rutherford states that the pain was most acute, and that, although the operators were very quick and dexterous, he was four hours under their hands; and he was completely blinded for a time by the operation. In three days the swelling occasioned by it had greatly subsided, and he began to recover his sight; but six weeks elapsed before he was completely well. Rutherford's account agrees with those of other observers, excepting in the circumstance of the whole operation being performed at once, while both Captain Cruise and Mr. Marsden state that it required several months, and sometimes several years, to complete the tattooing of a chief, owing to the necessity of allowing one part of the face or body to heal before commencing the decoration of another part; but, besides the probability that this might apply only to the more intricate patterns, or to cases in which the tattooing extended over a larger portion of the person than in the case of Rutherford, it is possible that the natives may have designed to put his powers of endurance to a severer test than would be required of a native. Captain Cruise states that the New Zealanders occasionally renew their tattooing, as the lines grow faint by lapse of time; and from various accounts it would appear that the tincture introduced into the wound (on the edge of the cutting-instrument) is sometimes obtained from the juice of a tree; and that, before the cutting is commenced, the intended figure is traced upon the skin with a burnt stick, or a piece of red earth. The age for performing the operation appears to vary from eight or ten years up to about twenty; and the females are not required to submit to anything beyond a slight tattooing of the face. Those among whom Rutherford lived had the inside of their lips tattooed,* as well as having marks on the chin, forehead, and sides of the nose and mouth; while the men were commonly tattooed on the face, hips, and body, and some as low as the knee. The most complicated patterns are found upon chiefs of the highest order; and their peculiar devices, or, as they are called, *amocos*, form distinctions which, in some cases, take the place of the sign-manual of the individuals to whom they belong. An instance is related in the 'Missionary Register' for 1816, in which a chief in the Bay of Islands, on making a grant or conveyance of a piece of land to some missionaries, had a drawing of the tattooing of his face affixed in lieu of a signature; while an attesting witness added, in like manner, a copy of the pattern on one of his cheeks. Of the character of these patterns a better idea will be conveyed by the annexed bust of Shungie, copied from an engraving in the 'Missionary

Register' for 1816, than by the most lengthened description. After it is inserted a copy of a drawing, executed by Tupai Cupa, a New Zealand chief, without the aid of a pencil, his own amoco, or tattooed pattern. This individual also drew from memory, while in the presence of the missionaries, the force of association in his mind, that, on finishing the latter, he held it up, gazed at it with a murmur of rapturous delight, kissed it repeatedly, and finally burst into tears.



Head of Shungie, from a carving by himself.

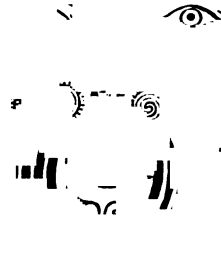

Tattooing on the face of Tupai Cupa, from a drawing by himself.

The process of tattooing as practised, or rather as formerly practised, in other islands of the South Sea, was less painful than that followed in New Zealand according to the account of Captain Cook, in some of the punctures could hardly be said to draw blood. The instruments used were edged with small teeth, some resembling those of a fine comb; and, as in the case of New Zealand, the colouring tincture was introduced into the same operation as that by which the skin was punctured; the substance employed in some places being of a kind of lamp-black. On the brown skins of the natives the marks made with this substance appear black, while on the skin of a European they are of a fine blue colour. Lafitau speaks of powdered charcoal as the colouring matter commonly used by the American Indians, and states that it was introduced by a process subsequent to that of cutting or puncturing the skin. This insertion of the colour appears to have been the most painful part of the operation of tattooing as practised among them.

* According to the narrative of the voyage of H. M. S. Blonde to the Sandwich Islands, the ladies of Hawaii (the Owyhee of Captain Cook) follow the singular practice of tattooing the tips of their tongues, in memory of their departed friends.

* Rutherford states that the tattooing on the inside of the lips of the New Zealand women appears of a blue colour.

ition to the other reasons which have been al- for the general adoption of the practice of among savage tribes, it is likely that it may led as an important part of the initiation of a of whose passive courage it is a severe test. serves the author of the 'New Zealanders,' 'in nt which Rochefort, in his 'History of the An- 108), gives of the initiation of a warrior among e of those islands, it is stated that the father of ; man, after a very rude flagellation of his son, proceed to scarify (as he expresses it) his whole i the tooth of the animal called the *acouti*; and rder to heal the gashes thus made, he rubbed 1 an infusion of pimento, which occasioned an pain to the poor patient; but it was indispens- he should endure the whole, adds our author, he least contortion of countenance or other evi- suffering.'

ial Bible, note on Levit. xix., 28; *Pictorial His- England*, vol. i., pp. 129 and 329; *New Zea- Lib. of Ent. Knowledge*, chapters vi. and xiv.) MANN, FRIEDRICH, was born at Wonsees, euth, on the 16th of May, 1565, where his father maker. His father died very early; and his arried a tailor, who wished to bring up his step- igh to his own business; but as the boy showed igh, he was sent, in 1577, to school at Culm- re he was obliged to gain his livelihood by sing- egging. In 1582 he went to the gymnasium of , where his Latin verses and the wit displayed ere so much admired, that he was crowned by issus as poet-laureate. Ten years later he went iversity of Wittenberg, where he distinguished nd, in 1595, was appointed professor of poetry ence, to which afterwards the honour of court- dded. He died at Wittenberg, on the 24th of 13.

an was conscientious in the discharge of his s, and he was a witty and humorous man. ifetime he had the reputation of being the of the age, and persons of the highest rank , society. From all that can be learned about lear that he did not, like many others in similar forget his own dignity as a man: he never acted n or flatterer, but always manifested a straight- igh character. In his time philology very rapidly in Saxony, all attention being v theological controversies and sophistries, and was one of the very few who, both in earnest ss, impressed upon his contemporaries the ne- resuming a thorough study of the antient lan- the only means of raising theological studies to er position. This he did more especially in his tatio de Lingua Latina,' the last edition of ed at Wittenberg, 1614. With the same ted himself in his lectures, and in his editions (Wittenberg, 1621, 4to.) and of Virgil (Witten- 3, 4to.), in which he made his countrymen ac- the labours of foreign scholars. His poetical ough very popular in his time, have no great hey appeared in several collections, under the Columbae Poeticae,' 'Melodaesia,' 'Schedias- ica,' and others. After Taubmann's death, the aubmanniana was applied to all kinds of witty d anecdotes.

Schmidii *Oratio in Taubmanni Memoriam*, g, 1613, 8vo.; *Taubmanniana, oder Fr. Taub- eben, Anekdoten, witzige Einfälle und Sitten-* on Simon von Cyrene, Leipzig, 1797, 8vo.; *Fr. eben und Tod Frid. Taubmanni*, Copenhagen, : the best work however is by Ebert, *Leben und e Fr. Taubmanns*, Eisenberg, 1814, 8vo.)

ER, or THAULER, JOHANN, the most cele- n divine of the fourteenth century. He was ss, as some writers say, at Cologne, but accord- ers at Strassburg. Respecting his life very little

He entered the order of the Dominicans at an and was held in the highest esteem on account owledge of philosophy and mystic theology, as r his pious and unblemished conduct, although sly attacked the vices and follies of his fellow- The latter part of his life he spent in the convent ominicans at Strassburg, where he died on the

16th of June, 1361, as is attested by his tomb-stone, which still exists in that city.

Tauler was a man of extraordinary piety and devotion, a zealous teacher, and a great promoter of mystic theology in Germany, which must regard him not only as the founder of that school of divinity, but at the same time as one of the greatest men that have ever sprung from it. His sermons, as well as his other religious and ascetic works, show a glowing imagination and deep feeling: they are less addressed to the understanding than to the heart. But although this leaning and his love of the mysterious frequently led him to religious sentimentality and absurdities, yet he never sinks down to the level of some modern mystic divines. Tauler was deeply read in scholastic philosophy, and although in his sermons he endeavours to steer clear of it, yet they are not quite free from sophistic subtleties, and there are passages which must have puzzled more than enlightened his audience. In his love of truth, and the earnestness with which he devoted himself to the instruction of the people, he was a worthy predecessor of Luther. Tauler's influence upon the German language and literature has acquired for him as distinguished a place in the history of German literature as that which he occupies among divines. In his time German prose scarcely existed, and the standard of sermon-writing was very low. The creation of a prose literature belongs almost exclusively to him: his style seldom aims at oratorical beauty, his sentences are short and abrupt, but always full of meaning. His language, which is the dialect of the Upper Rhine, is as pure as can be expected. It appears that Tauler did not himself write his sermons, but they were taken down as they were preached, by many of his hearers. We must therefore suppose that in the editions which were published shortly after his death, the form has been somewhat altered by the editors. The first edition of his sermons appeared at Leipzig, 1498, in 4to., under the following title: 'Sermon des grossgelarten in gnaden erleuchteten Doctoris Johannis Tauleri predigerr ordens, weisende auff den nehesten waren wegk, yn geiste czu wannern durch uberschwebenden syn, unvoracht von geistes ynnige vorwandelt i deutsch manchen menschen zu selikeit.' This edition was followed by another at Augsburg, 1508, fol., and a more complete one at Basel, 1521, fol. A translation of these sermons into the dialect of Lower Germany was published at Halberstadt, in 1523, fol., and another into High German by P. J. Spener, at Nürnberg, 1688, 4to. A new edition in modern High German was published at Frankfurt-on-the-Main, in 3 vols. 8vo., 1825, &c. The most interesting among his other religious works is that on the imitation of the life of Christ, 'Nachfolgung des armen Lebens Christi,' which was first printed at Frankfurt in 1621. The most recent edition is that by Schlosser, Frankf., 1833. A collection of all the treatises of Tauler was commenced in 1823, at Luzern, by N. Casseder, but only two volumes have appeared.

Most of the works of Tauler were translated into Latin by Laurentius Surius, Cologne, 1548, fol.: this collection has been reprinted at Macerata and Paris. There are also one Italian and three Dutch translations: the best of the Dutch translations is that of Antwerp, 1685, fol.

A list of the works of Tauler, together with the whole literature on the subject, is given in Jörden's *Lexicon Deutscher Dichter und Prosaisten*, vol. v., p. 1-9.

TAUNTON, an antient town in the south-western part of Somersetshire, situated in a fertile vale called Taunton Dean, and distant 141 miles from London, 44 from Bristol, and 33 from Exeter. Roman coins and other antiquities have been found, from which it has been inferred that there was a Roman station here. Taunton was certainly a place of considerable importance in the Anglo-Saxon period; and in the eighth century a castle was built here by Ina, king of the West Saxons, in which he held his first great council. The building was destroyed by his queen in expelling one of the kings of the South Saxons. An other castle was built after the Conquest by one of the bishops of Winchester, to whom the town and manor were granted; and the present remains are believed to be those of a still more recent edifice. Perkin Warbeck held possession of the castle and town for a short time; and in the civil wars the town sustained a long siege under Colonel (afterwards Admiral) Blake, against 10,000 royalist troops, until relieved by Fairfax.

The town is about a mile long; the principal streets are

wel paved, and lighted with gas; and the houses of brick, of respectable appearance. Apart from the main thoroughfares are some very poor streets, which, before the enlargement of the borough, were inhabited by persons desirous of profiting by the parliamentary franchise. The woollen manufacture was established at Taunton in the fourteenth century, but has long since decayed; and at present the silk manufacture is carried on, though not to any great extent. The river Tone flows on the north-western side of the town, and is crossed by a stone bridge of two arches; but the river is only partially navigable, and in 1811 a canal was projected between Taunton and Bridgewater, a distance of 12½ miles. This canal is of great importance to the prosperity of the town and district, by enabling it to export agricultural and other produce to Bristol and other places, from which it receives groceries, coal, and other commodities in return: there is a branch from this canal to Chard. In July, 1842, the railway from Bristol to Exeter was opened as far as Taunton, so that there is now a railway communication with the metropolis. The markets, held twice a week, are very abundantly supplied with fish, fruit, and every kind of provisions. The market-house stands in a spacious open area called the Parade, and is a brick building of considerable size: the upper part comprises the guildhall and an assembly-room, and the lower part consists of an arcade on each side, in one of which the corn-market is held. On market-days the Parade, which is enclosed by iron posts and chains, is occupied by butchers' stalls. On the west side of the Parade there is a handsome building of the Ionic order, erected in 1821, the upper part of which is appropriated as a library, museum, and reading-room; and underneath, and in the rear, are the markets for fish, poultry, dairy produce, &c. The Taunton and Somerset Institution, established in 1823, contains a good though not extensive library, and a large public reading and news room. The theatre is a small neat building. Two weekly newspapers are published at Taunton. There are three churches. The church of St. Mary Magdalen is a spacious and very handsome edifice in the florid Gothic style. The quadrangular tower at the west end, 153 feet high, is much enriched, and is a work of great beauty. The value of the living, which is a vicarage, is not given in the Reports of the Ecclesiastical Commissioners. St. James's church is a plain edifice, with an ancient square tower formerly belonging to the conventual church of the priory. The living is a perpetual curacy, of the annual value of 255*l*. Trinity church was consecrated 18th June, 1842. It is in the Gothic style, built of white lias stone, with dressings of Bath stone, and contains sittings for above one thousand persons. It stands on elevated ground, about half a mile from the parish church, in a poor and populous part of the town. There are two chapels belonging to the Wesleyan Methodists, one erected in 1778 under the direction of Wesley. The Roman Catholics, Independents, Baptists, Quakers, and Unitarians have chapels. The free grammar-school was founded by Fox, bishop of Winchester, in 1522. The premises are situated within the castle-gate, and consist of a large and ancient school-room, and under the same roof is the dwelling-house of the master. The endowment is worth about 36*l*. a year. The number of infant, Sunday, and daily schools at Taunton was stated in 1833 to be very inadequate, and a large number of poor children were at that time receiving no education. There are various almshouses and other charities, all of which are noticed in the Report of the Charity Commissioners vol. v., p. 484-542. The Taunton and Somerset hospital was opened in 1812: and there are other medical charities.

Charles I. granted the burgesses a charter of incorporation. In the reign of Charles II. they were deprived of this charter, in consequence of the town having displayed so much zeal for the parliament, but it was restored, and in 1792 became forfeited by the corporate body having neglected to fill up vacancies. The town then came under the jurisdiction of the county magistrates, and is still without a municipal government. The bailiffs and constables, as the principal officers of the town, take a prominent part in all public proceedings. Taunton has returned members to parliament since 1255—23 Henry I. Before the Reform Act the right of election was in the potwallers who had been six months resident and were not in the receipt of charitable relief. The town having outgrown the ancient limits of the borough, which was

wholly within the parish of St. Mary Magdalen boundary was adopted, so as to comprise the following parishes:—St. Mary Magdalen on James's on the north, Bishop's Hill on Wilton on the south. By this extension of the borough was increased from 5584 to 12,1 to the census of 1831. In 1826 the number of was 739; in 1840 the number on the register 1010, including 216 of the old potwallers. are returned to parliament. The Lent and Michaelmas quarter-sessions are held at Taunton is a court for debts under forty shillings, the which extends over the hundred. There is a lock-up or place of temporary confinement county courts and officers are within an irregular consisting of the remains of the castle.

(Toulmin's *Hist. of Taunton*, 1791; and no Savage, 1822.)

TAUNUS. [GERMANY.]

TAURELIUS, L. [TORELLI.]

TAURICA CHERSONESUS was the name of the peninsula which juts out southwards of Sarmatia, between the Pontus Euxinus and the Palus Maeotis (Sea of Azof): it is in Crimea. It is called Chersonesus Trachea, who compares it to the promontory of Sicily. Its form, size, and physical features under CRIMEA. The isthmus which connects the mainland was called Taphros or Ταψάρρα, and there appears to have been the same name upon the isthmus.* (Strabo, Pliny, iv. 26; Mela, ii. 1.) On the west was the Sinus Carcinites (Κόλπος ὁ Καρκινίος Gulf of Perekop; and on the east the shallow sea now, called the Putrid Sea or Lake (ή Palus Putris). The south-western point of was the promontory Parthenion (τὸ Παρθένιον either the modern Cape Chersonese, or another farther south, in the neighbourhood of the Tcheorghli. The southern promontory was Metopon (Κρυσσομίτιον), and either the so the eastern point of the island was called Cάκρον). On the east the peninsula is divided coast of Asia by the Cimmerian Bosphorus Βόσπορος), now the Strait of Kertch or Yeni south-western side of the peninsula is terminated by Cape Chersonese, and on the north by the Gulf of Achtiar, the ancient (Κρενοῦς), and on the south by the Gulf of ancient Portus Symboloum (Συμβόλων λιμὴν peninsula, at the distance of 100 stadia from the Parthenion (Strabo), stood the city of Χιέρρωνησος) or Cherrone (Mela), the full name was Chersonesus Hæraclæotica. It was a city in Pontus. The peninsula itself was called Chersonesus, and the Chersonesus Taurica was called the Great Chersonesus, to distinguish it from the other important towns on the isthmus, Taphros (ή Τάψαρρα), now Perekop coast Eupatoria (Εὐπατορία), now Eupatoria built by Mithridates Eupator; on the caucasia (ή Θεοδοσία, or ή Θεοδοσία), now Kertch a colony of the Milesians; at the eastern end on the Bosphorus, Panticapæum or Bosphorus now Kertch. There were several towns in it the only one worth mentioning is Cι Eski-Krim, that is, Old Krim.

The earliest inhabitants of the peninsula have been the Cimmerians, some of whom remain the great body of the nation had been driven seats round the Palus Maeotis by the Scythians iv. 1, 11, 12. Clear traces of this people, names of Cimmerion, the Cimmerian Bosphorus merian Chersonesus (as the peninsula was called), and in its modern names of Cι Tartary. In the earliest notices of the Greek writers, we find the mountainous south and south-east inhabited by a piratical

* This name was probably derived from a ditch which runs across the isthmus, and which appears to have been the same as the one mentioned by Herodotus, iv. 3. This ditch must not be confounded with that mentioned by Herodotus, which appears to have been in the peninsula itself, and at it. (Niebuhr's *Historische Nachrichten*, i. p. 15; Bähr's *antiquitates Herodotus*, iv. 3.)

in whom the Chersonesus was called Taurica, the name remains in that of the modern Russian Taurida, in which the Crimea is included. Tauri were is a question of some difficulty. Herodotus calls them a Scythian people, but Herodotus clearly distinguishes the Tauri from the Scythians, being a different nation. The inhabitants of a part of the peninsula are not unfrequently called Tauri or Tauroscythae. Judging from this and from the testimony of Herodotus to the effect that the Tauri were a different people from the Scythians did not drive out all the Scythians from the peninsula, and, lastly, from several passages,* it seems most probable that the Tauri are the descendants of the old Cimmerian inhabitants, who had themselves in the mountains against the Scythians. The name 'Tauri' is supposed to be an old root 'Tau,' meaning a mountain. They were reputed by the Greeks to be inhospitable to strangers: they were said to offer sacrifices, especially of shipwrecked mariners, to a goddess, whom, according to Herodotus, the Tauri identified with Iphigeneia, the daughter of Agamemnon, and whose temple stood on the promontory of the Tauri. (Herodot., iv. 103; Strabo, p. 308; Mela, Sic., iv. 44.) This legend enters into the plot of the 'Iphigeneia in Tauris' of Euripides, and is sometimes referred to by the Roman poets. At the sixth century before Christ downwards, Greek colonies were planted on the Chersonesus, and these gradually formed into two states, that of the Tauri, comprehending the smaller peninsula on the north, and the kingdom of Bosphorus on the south; two states were united under Mithridates.

Information respecting the geography and hispania peninsula and of the adjoining delta of the river under CRIMEA and TAMAN.

TAURIDA, one of the governments of South Russia, called the government of Simferopol, situated on the Black Sea, consists of—1st, the Crimea or peninsula; 2nd, the Nogay Steppe, with the island [TAMAN]; 3rd, the country of the Tschernomorsk Cossacks. It is bounded on the north-west by the country of the Don Cossacks, on the north-east by the country of the Don Cossacks, on the south-east by the country of the Nogay Steppe, on the south by the Black Sea. The Crimea principal towns are described under the respective names: [BAKTSCHISARAI; CRIMEA; KAFFA; SEBASTOPOL.] The area of the whole is 35,000 square miles, with 520,000 inhabitants of many different nations, Cossacks, Russians, Jews, Gypsies, German, and other foreign colonists, &c. It lies between 47° 50' N. lat., and between 31° 25' and 40° 25' E. long. The Nogay Steppe includes the whole of the country from the Dnieper and its limans to the east, a dry elevated steppe on a basis of granite. The soil has precisely the character of a Russian steppe: soil is dry, poor, in part sandy, and saltish, and is covered with a black mould, which produces the finest grass. The climate is extremely mild, and differs little from that of the Crimea peninsula. The winter, though short, is severe. The rivers are those which form the boundaries: the Dnieper on the north-west, the Kanski Wodi on the north, the Sea of Azof on the east. On the south-east is the Sea of Azof, and on the west the Black Sea.

On the north-west the Tschernomorsk Cossacks including the peninsula of Taman, is bounded on the north by the country of the Don Cossacks, on the east by the country of the Don Cossacks, on the south by the river Kuban, and on the north by the Sea of Azof, and is separated from the Crimea by the strait of Yenikale, which connects the Sea of Azof with the Euxine. The coast is sandy, flat, and forms several bays or inlets, called by the Russians the Tschernomorsk, most considerable of which is the Besugakoi, in the middle of the country. It is an immense plain, with a few hills in the south, belonging to the Cau-

casian system, consisting in general of very fertile lowlands, which are well adapted for agriculture, but are for the most part used as pasture for cattle: the remainder consists of a poor saline soil; and there are some small lakes with salt water: the climate is very mild. The principal rivers are the Kuban, on the south, which separates it from Circassia, and discharges itself on the south of Taman by a very broad liman, and the Lega, on the north frontier next the country of the Don Cossacks, which is joined by several small streams, and empties itself by a considerable liman into the Sea of Azof. The small streams in the interior fall into the Sea of Azof, one of which, the Besuga, forms at its mouth the liman Besugakoi.

The countries forming the government of Taurida were inhabited in ancient times by the Scythians and by Greek colonists. Since the time of Herodotus, in the fifth century B.C., they have been successively conquered and ravaged by many different nations. They have been subject to the kings of the Bosphorus, the Romans, the Sarmatians, then to the Greek emperors, and at the end of the twelfth century partly to the Genoese; they were conquered in the thirteenth century by the Tartars, and at the end of the fifteenth by the Turks. Mohammed II. made himself master of Taurida in 1475, and expelled the Genoese and the Venetians, the former of whom possessed Kaffa and Kherson, and the latter had the colony of Tana. Subsequently to 1698 the Russian armies repeatedly penetrated into the Crimea, the inhabitants of which often made predatory incursions into the neighbouring countries. It was not however till 1771 that the country was really conquered by Dolgorucky, and the Porte compelled, in 1774, at the peace of Kutschuk-Kainardji, to recognise the Crimea as an independent country, to be governed by a khan chosen by the nation, and to recognise the sultan as their head in religious matters only. The khan Sahen Ghierai, whose election had been supported by the Russians, being pressed by the Turkish party, was at length induced to seek refuge in St. Petersburg. Russia now declared the Crimea to be her property, and the Porte, to avoid a new war, ceded it wholly to Russia, in January, 1784. The khan received a pension from Russia, and in the sequel retired to Turkey, but in 1787 was beheaded in the Isle of Rhodes by the sultan's order. Sultan Kalli Ghierai is his lineal descendant, who lives (or at least did live some years ago) in Simferopol, is a Christian, and is married to a Scotchwoman. The Crimea and the provinces dependent on it were formed into a government in 1784, by the name of Taurida, and incorporated with the Russian empire. The empress Catherine II. added to the imperial titles that of Czar of the Tauric Chersonesus, and conferred on Prince Potemkin, who had been instrumental in bringing about, not without violence, the submission of the Tartar inhabitants, the surname of the Taurian. The Porte indeed appointed a new khan in 1786, and demanded that the Crimea should be replaced on the footing stipulated in the last peace; but it was obliged to cede it for ever to Russia in the peace of 1792. Taurida was at first a province of the government of Ekaterinoslav; in 1797 it was incorporated with the government of New Russia; and in 1802 it was made a distinct government by the emperor Alexander.

Among the numerous authorities that might be quoted, besides those already cited under the heads of the CRIMEA, ODESSA, &c., we may mention Muraview Apostol, *Reise durch Taurien*, 1820; Eichwald, *Alle Geographie des Kaspischen Meeres des Kaukasus, und des südlichen Russlands*, 1838; and for the Nogay Tartars, Daniel Schlatter, of St. Gallen, *Bruckstücke aus eigenen Reisen nach dem südlichen Russland in den Jahren 1822-1828*.

TAURINE, a peculiar crystallizable substance contained in the bile. Its properties are, that it has the form of a six-sided prism terminated by pyramids of four or six faces; the crystals are gritty between the teeth, and have a sharpish taste, which is neither sweet nor saline: they undergo no alteration by exposure to the air even at 212°, and have neither an acid nor an alkaline reaction. When heated in the naked fire, this substance becomes brown, fuses into a thick liquid, swells up, exhales a sweetish empyreumatic odour resembling that of burning indigo, and leaves a charcoal, which is readily burnt: when submitted to dry distillation, it yields much thick brown oil, and a little yellow acidulous water, which holds

le, in our own island the very same thing has happened to a one think (on account of their name) to be a branch of this family, the Cymry, who, in the mountains of Wales, succeeded the Saxon and Norman invaders.

an ammoniacal salt in solution, and reddens a solution of perchloride of iron; one part requires 15½ parts of water at 54° for solution; it is much more soluble in boiling water, and the excess crystallizes on cooling; it is but little soluble even in boiling alcohol of sp. gr. 0.835, and is nearly insoluble in absolute alcohol. Concentrated sulphuric acid dissolves and forms a light brown solution with taurine; nitric acid readily dissolves it, and when the acid is evaporated, it is left unaltered.

TAURIS. [TAHRIZ.]

TAUROME'NIUM, now TAORMI'NA, a town in the northern part of the east coast of Sicily. The ancient name, Tauromenium (Ταυρομίνιον), like that of the river Tauromenius (the modern Alcantara), at the mouth of which the town was situated, was derived from Mount Taurus, on which the town was built. Diodorus Siculus gives two apparently contradictory accounts of its foundation, though both agree in the main point, that Tauromenium was founded by the inhabitants of the ancient town of Naxos, which lay a few miles south of Tauromenium. In one passage (xiv. 59) he states that during the war of Dionysius the Tyrant with Himilco, the latter induced the Siculi, who had previously received from Dionysius the town of Naxos and its territory, to occupy Mount Taurus, and to fortify themselves there; and after the termination of the war in favour of the Carthaginians, the Siculi, about 392 B.C., formed a permanent settlement on Mount Taurus, which they called Tauromenium. The other account (Diodor. Sic., xvi. 7) places the building of the town somewhat later, inasmuch as it states that it was founded by Andromachus, the father of Timæus the historian, in conjunction with the inhabitants of the destroyed town of Naxos; but in this account Andromachus himself is called a Tauromenian, which implies the previous existence of Tauromenium. Consequently Diodorus can only have meant to say that Andromachus assigned to the homeless Naxians habitations in the already existing town of Tauromenium, and that he agreed with them in the name of Tauromenium being preserved. (Wesseling ad Diodor. Sic., vol. vi., p. 552, ed. Bipont.) Strabo (vi., p. 27, ed. Tauchnitz) calls Tauromenium a colony of the Zanclæans of Hybla. Soon after its foundation the new town appears to have become very wealthy and powerful. Agathocles, the tyrant of Syracuse, put to death a great number of the inhabitants who had opposed his usurpation. (Diodor. Sic., xix. 102.) In the time of Pyrrhus the town was governed by a tyrant, Tyn-darion, who supported the king on his landing in Sicily. After the subjugation of Sicily by the Romans, Tauromenium became a 'civitas foederata,' and being thus under the immediate protection of Rome, it enjoyed a long peace, during which its prosperity increased. (Cicero, *In Verrem*, ii., 66.) In the time of Verres the town contained many statues of this propraetor, all of which, after his departure, were destroyed, except the pedestal of one which stood in the market-place, which was left standing to mark the disgrace of the Roman governor. In the war of Cæsar with Pompey, Tauromenium was in the possession of the Pompeian party; but when Cæsar made himself master of it, he expelled the inhabitants, and established a Roman colony there. (Appian, *De Bello Civili*, v. 103, 105, 109; Pliny, *Hist. Nat.*, iii. 14; Velleius Paternus, ii., 79.)

Taormina at present contains about 6000 inhabitants: its situation on a steep rock on the sea-coast is magnificent. It contains considerable ruins of ancient buildings, especially a theatre of gigantic dimensions, the seats of which are cut in the rock, which projects into the sea. This theatre and the aqueduct, or, as it is generally called, a naumachia, of which there are remains, were not constructed till the time of the empire. On the hills which rise above Taormina there are ruins of several castles, and among them one is very remarkable, which is called Mola, and was built in the ninth century of our æra by the Saracens, who took the town by storm after a long and brave resistance by the inhabitants.

The principal deity worshipped by the ancient Tauromenians was Apollo, which confirms the statement that the town was a settlement of the Naxians, among whom Apollo was the national divinity. An Apollo, with a wreath of laurel round his head, occurs on many coins found at Tauromenium, with the inscription ΑΡΧΑΪΕΤΑ,

or ΑΡΧΑΪΕΤΑΣ; and the reverse shows a tripod, which probably indicates that Naxos was founded under the sanction of the Delphic god. Other coins show the head of Dionysius or of Athena. There is one coin, one side of which represents a head of Jupiter, and the other an eagle with the thunderbolts. The name of the town is expressed on the coins by Ταυρο, Ταυρομ., Ταυρομην., or Ταυρομηνίαν. (Eckhel, *Doctrina Num.*, i., part 1, p. 247, &c.; Mionnet, i., p. 321, &c.; *Suppl.*, i., p. 424, &c.)

TAURUS, MOUNT (ὁ Ταῦρος), in the opinion of the later Greek geographers, was a great chain of mountains which extended nearly due east and west from the shores of the Ægean to those of the supposed Eastern Ocean, and divided Asia into two parts, Asia within the Taurus (ἐντὸς τοῦ Ταύρου), and Asia without the Taurus (ἐκτὸς τοῦ Ταύρου). Their notions respecting this chain were by no means accurate, and indeed only a small part of it ever really bore the name.

The chain of Taurus, properly so called, commences at the south-western point of Asia Minor, and proceeding eastward parallel and near to the Mediterranean, it encloses between itself and the coast the narrow strip of land which formed Pamphylia and Cilicia. At the river Pyramus the chain divides into two, that of Amanus, which proceeds to the east, dividing Syria from Asia Minor [AMANUS], and the continuation of Taurus, which runs north-east, along the south-east side of Cappadocia, across the Euphrates into the northern part of Armenia, where it joins Mount Masius. This chain now bears the name of Enamas, Ramadan, and Gourin.

In Cappadocia the Taurus throws off a great branch which was called the Anti-Taurus (ὁ Ἀντιταῦρος), which passes through the middle of Cappadocia, north-east to the sources of the Halys, and thence east to Euphrates. Its modern name is Alidagh. At (Siwas) this chain joins that of the Paryadres (Χιζικόν), which extends north-east as far as the mountains of Ararat. In modern geography the whole chain from the west of Asia Minor to Ararat bears the name of Taurus. The name itself is probably merely a form of a root which occurs in several Oriental languages, meaning

(Rennell's *Geography of Herodotus*, i. 228, &c.; J. J. G. Litz's *Alte Geographie*.) [ANATOLIA.]

TAURUS (the Bull), the second constellation of the ZODIAC. Its position in the heavens, surrounded by Arcturus, Eridanus, Orion, and Perseus, is easily obtained by a manner in which its bright star ALDEBARAN is connected with the belt of Orion. In all speculations upon the constellations of the zodiac, Taurus must be an important object of consideration, since, at the earliest date which prudent speculation can consider it advisable to begin from, Aldebaran must have been at no great distance from the vernal equinox. Referring this point however to the article on the zodiac, we shall merely notice that the Greeks usually attribute but a paltry mythological origin to this striking constellation; the fables of Europa and Io being the only ones alluded to in statements of its mythological meaning.

The figure is only a part of a bull, the head, shoulder, and fore legs. Aldebaran and the Hyades form the forehead and eye, and the Pleiades are in the shoulder. But Aratus must have drawn the figure differently, for he puts the Pleiades in the knees.

The Hyades form a group, of which five (some of the ancients said seven) are distinctly visible to the naked eye, α, θ, γ, δ, and ε of the constellation: there are many more in the cluster. These stars are arranged in the form of a V, α and ε being the extremes, and γ at the angular point. The star α is Aldebaran. The name seems to be derived from ἔβου, to rain. The Latins called them *sucule* (little pigs, no doubt meaning Aldebaran for the sow, and the others for her offspring), a name which Cicero and others state to have arisen from supposing the Greek word to have been from βίς (pigs), and not from ἔβου. We think however it may be possible that they were right in their idea of the Greek word: the large star and the cluster of small ones might very easily suggest the notion of a sow and her litter.

The Pleiades are so close a group of stars that it is very difficult to say how many are seen by the naked eye. 'They are called seven,' says Higinius, 'but no one can see

six: and six seems to be the number generally found there are many more in the cluster. These 7, 19, 20, 23, 25, and 26 of Flamsteed. There is a supposition that some one star, once visible, changed its magnitude, or disappeared altogether. has been derived from $\pi\lambda\upsilon\upsilon$, to sail. One of the old stories makes these stars the daughters of Atlas.

Principal stars of Taurus are as follows: (*g*), (*b*), (*m*), (*f*), (*h*) are not Bayer's letters, but Flamsteed's, the distinguished stars in the Pleiades.

No. in Flamsteed's Catalogue of	Magnitude	Character, () not in Bayer.	No. in Catalogue of		Magnitude	Character, () not in Bayer.	No. in Catalogue of		Magnitude
			Flamsteed's (Piazzi.) [Bradley]	Astron. Society.			Flamsteed's (Piazzi.) [Bradley]	Astron. Society.	
372	4	δ^2	64	492	4		121	671	6
375	4	κ^1	65	496	5		122	683	7
378	6	r	66	494	5	ζ	123	684	3
379	5	κ^2	67	498	5		125	688	5½
381	6	δ^3	68	499	4½		126	696	6
383	6	v^1	69	502	5	(M)	128	703	6
387	6		70	501	7		129	704	6
388	4½		71	503	7	(N)	130	706	6
392	6	v^2	72	505	6	(O)	131	707	6
395	6	π	73	504	5	(B)	132	709	5½
398	6	ϵ	74	507	3½		133	708	6
401	6		75	508	7	(P)	134	716	6
402	7		76	509	7		135	719	6
403	5	θ^1	77	510	5	(C)	136	722	5
404	7	θ^2	78	511	5	(D)	137	723	5
405	5	b	79	512	5		139	737	6
409	6		80	515	7	(Q ^a)	141	745	6
410	5		81	517	7		(6)	463	7
414	3		83	518	7		(32)	359	5½
418	6		84	519	7		(37)	624	7
419	7½		85	520	7		(43)	627	7
422	6	ρ	86	523	5		(45)	481	6½
427	5	a	87	528	1		(53)	486	7
435	6	d	88	529	5		(60)	374	7
436	7	c^1	89	531	7		(69)	497	6½
437	6	c^2	90	533	5		(99)	516	5½
442	7	σ^1	91	536	6		(103)	390	7
443	4	σ^2	92	537	6		(111)	522	7
447	7	τ	93	540	6		(125)	666	6½
448	5		94	543	5		(145)	678	7
446	4		95	544	6½		(148)	541	6½
449	6	(K)	96	555	6		(151)	413	7
451	6	i	97	559	6		(166)	422	7
453	5	k	98	575	6		(169)	547	6
457	6		101	581	6		(170)	423	6½
459	6	l	102	585	4		(179)	550	6
461	7	m	104	592	6		(187)	429	7
465	7		105	595	6		(215)	441	6½
466	5½	p	106	593	6		(236)	717	7
468	7	l^1	107	602	8		(242)	720	7
469	5½		108	615	7		(243)	572	6½
471	6	n	109	623	6		(244)	721	7
473	7		110	638	7	(I)	(246)	573	6½
475	5	β	111	640	6½		(249)	454	6
475	7		112	642	2		(254)	458	6½
478	3		113	649	6		(257)	578	7
476	7	o	114	652	5		(282)	587	7
479	6½		115	651	6		(295)	594	6
480	7		116	654	6½		(298)	596	7
484	5		117	655	7		(338)	759	6½
487	7		118	657	6		[522]	416	7
488	4		119	663	6		[774]	656	7
491	7		120	667	7		[823]	701	7
490	6								

honour of the reigning king of Poland, and adopted in the French (Fortin's) edition of Flamsteed's maps (or rather added to the plates). Poczobut, in 1778, proposed this constellation to the French and other academies, by whom it was received. Bode conjectures that a resemblance of certain very small stars in it to the figure of the Hyades was the reason for the first word of the name. It is situated between Aquila and Ophiuchus, and the Astronomical Society's Catalogue mentions one star of it, of the sixth magnitude, being 2070 of that catalogue, and (328) of Piazzi.

TAUSAN, TAUSSEN, or TAGESEN, JOHN, the first Danish theologian who made his countrymen acquainted with the principles of the Lutheran reformation. He was born in 1494, at Birkinde, a village in the island of Fünen. After he had received his early education in the convent of Antworskow, he wished to continue his studies at some university, and the abbot of the convent fixed upon Cologne. Here he became accidentally acquainted with some of the earliest works of Luther, which excited in him such a desire to study under the reformer, that he defied the opposition of his superiors, and went to Wittenberg. After having spent some time here he went to Rostock, where he took his degree of M.A., and thence proceeded to Copenhagen, to undertake the office of teacher in one of the public schools, 1521. This sphere of action however did not satisfy him: his wish was to proclaim the new doctrines, which he thought he could do more effectually if he withdrew to his former convent of Antworskow. Here he gained great reputation as a preacher, and at first endeavoured privately to make his brother monks acquainted with the reformed doctrines; but in 1524, on the occasion of the abbot being absent, Tausan delivered a sermon, which produced such an effect on his hearers, that most of the monks declared themselves ready to abandon their old belief. The excitement and disturbance arising from such proceedings led to Tausan being transferred to another convent at Wiborg, where however he persevered in his exertions, and again gained a considerable number of followers. King Frederic I. of Denmark, who was favourably disposed towards the doctrines of the German reformers, and wished to favour Tausan, sent him, in 1526, a letter of protection, gave him the title of court preacher, and assigned to him a church at Wiborg, where he might preach without molestation. The bishop of this place opposed him in everything; but his attempts were fruitless, as Tausan was supported by the sympathy of the people. The disputes between the two religious parties now became more vehement every day; and at last the king, in order to save Tausan, invited him, in 1529, to Copenhagen, where he was appointed preacher to the church of St. Nicolas. The reformation in Denmark, the seeds of which had thus been sown, made gradual and steady progress; and in order to settle the question permanently, the king issued a command that deputies of the Roman Catholics and Protestants should appear on the 8th of September, 1530, before the assembly of the states, and explain their creeds and points of dispute. Tausan and the principal men of his party were present, and it was finally settled that the Protestants should preach and propagate their doctrines. The tranquillity thus restored was interrupted by the king's death in 1533, when the Roman Catholic party, and more especially the bishop of Roeskilde, again began to trouble Tausan, who was on the point of being driven out of his country. For a time he absented himself from Copenhagen; but Protestantism in the meanwhile made such progress, that the opposition to it in a short time either ceased or became very weak. In 1537, in which year John Bugenhagen was sent by Luther to Denmark to assist in arranging the ecclesiastical affairs of the country, Tausan was appointed preacher and lecturer on theology at Roeskilde; and four years later he was made bishop of Ripen, an office which he held until his death, on the 9th of November, 1561.

IS PONIATOWSKI, a constellation formed by Poczobut, a Polish astronomer (born in 1728: we know the year of his death; but Lalande mentions he used his observations at Wilna in 1802), in

stead has its only existence in a mistaken entry; and at the same time. Herschel says this star is lost; and M. Lalande says that it is not lost, but is however still in its place. Probably it is a variable star.

Tausan wrote a considerable number of theological works in Danish: some of them are controversial, others exegetical, and a third class consists of translations of portions of the Scripture and of original hymns. His works, as well as the history of his life, show that he was a simple and straightforward man; but in talent he was far inferior to the great reformers who were his contemporaries. (L. Holberg, *Dänemærkische, Norwegische Staats-* Vol. XXIV.—P

und Reichs-Historie, p. 124, &c.; compare Jöcher, *Allgem. Gelehrten-Lexicon*, iv., p. 1030, &c.

TAUTOCHIRON. [TIME OF DESCENT.]

TAUTOLITE, a mineral which occurs crystallized. Primary form a right rhombic prism. Fracture conchoidal, uneven. Hardness 6.5 to 7. Very brittle. Colour velvet black; streak grey. Lustre vitreous. Opaque. Specific gravity 3.865.

Before the blow-pipe on charcoal, melts into a blackish scoria, which is attracted by the magnet: with borax it forms a clear green glass.

It does not appear to have been accurately analyzed, but is stated to be probably silicate of protoxide of iron, and silicate of magnesia. It is found in the volcanic rocks of the Lake of Laach, near Bonn, on the Rhine.

TAVERNIER, JEAN BAPTISTE, BARON D'AUBONNE, the son of an Antwerp engraver who had settled at Paris and dealt in maps, was born in 1605. He was a traveller from his boyhood. The sight of the maps with which he was surrounded and the conversation of the geographers who frequented his father's shop inspired him with a passion for seeing foreign countries, which he soon contrived to gratify, it does not very clearly appear by what means or in what capacity.

Between 1620 and the close of 1630 he visited most of the countries of Europe: this may be considered as his apprenticeship to the profession of a traveller. Between 1630 and 1669 he made six journeys to the East: this was the portion of his life devoted to productive toil. The story of the remainder of his life, from 1670 to 1680, impresses us with the idea of an elastic and untired spirit, which, stimulated in part by his dilapidated fortune, but still more by an incapacity of repose, sunk in an attempt to re-enter that world of active exertion in which his place had been occupied by younger men. To appreciate Tavernier, it is necessary to examine his character as it displayed itself in each of these three periods.

He appears to have left his paternal home before he had completed his fifteenth year; for he tells us that after visiting England, Antwerp, Amsterdam, Frankfort-on-the-Main, Augsburg, and Nürnberg, he was induced, by what he heard at the last-mentioned place of the mustering of armies in Bohemia, to repair to the theatre of war. About a day's journey from Nürnberg, he met Colonel Brener, son of the governor of Vienna, who took him into his service. Tavernier was present at the battle of Prague, 8th November, 1620. Some years later, he followed his master to Vienna, and was presented by him to his uncle, the governor of Raab, at that time viceroy of Hungary, who received the young Frenchman into his family in the capacity of a page. With this nobleman Tavernier remained four years and a half, and ultimately obtained his dismissal with a view to entering the service of the Prince of Mantua. Something appears to have made him change this determination, for after a brief stay in Mantua he left it, about Christmas, 1629; and after making a short tour in Italy, and visiting his friends at Paris, returned to Germany. During the summer of 1629 he made an excursion into Poland; on his return from which he attached himself for a short time to the family of Colonel Butler, who afterwards killed Wallenstein. Hearing a report that the son of the emperor Ferdinand II. (afterwards emperor himself, with the title Ferdinand III.) was to be crowned king of the Romans in Regensburg, Tavernier who had been present at that prince's election as king of Hungary (1625) and his coronation as king of Bohemia (1627), wished to be present at this third solemnity also, and with this view threw up his appointment (whatever it was) in Butler's household.

Tavernier has nowhere explicitly stated what were his rank and occupations while he led this unsettled life. No expression escapes him to intimate that he at any time found himself at a loss for money. The appointment of page in the family of a nobleman holding the high office of viceroy of Hungary was generally the first step to the command of a troop. Yet there is a vagueness in the language of Tavernier while speaking of this part of his history, which leads us to suspect that his station was more of a menial character. His lively and enterprising disposition seems however to have made him a general favourite, and his power of expressing himself—not very elegantly, if we are to judge from his French, yet intelligibly—in several European languages, rendered him an eligible at-

tendant. His position was most probably that of the ready-handed, quick-witted, not over-sensitive attendant, with whom men of high rank in that age it necessary to surround themselves. From him in different parts of his travels, it is highly probable he had picked up some money in the wars; he required some knowledge of the military art: he knew something of watch-making and jewellery: and, as he had learned to shift for himself. Beyond such acquaintance with maps and geography as he picked up in his father's shop, he possessed no literary attainments: and his tastes and habits were not those of young rufflers of his age. A naturally frank, though somewhat boisterous temper had done but to neutralize the worst impressions of the lax school in which he had been educated.

After such preliminary training, and with a thus far developed, Tavernier commenced his travels to the East. He had already been turning his eyes in that direction, and making interest to be received into the suite of a new ambassador the emperor was about to dispatch to the grand seignior, when the confidence of Richelieu, Father Joseph, who had known him long, proposed that he should accompany two young noblemen who were travelling to Palestine by way of Constantinople. Tavernier closed with the offer, and his company with his employers reached that city in the winter of 1630-31. A recent biographer has said that he began his first journey in 1636: the origin of this take is as apparent as that it is a mistake. Tavernier's account of the ceremony of the coronation was finished in the reign of Ferdinand III. was not crowned king of the Romans until December, 1636. Tavernier gives no dates in the first volume of his first journey; but we know that he entered Marseille for his second in September, 1638: we know that he arrived at Rome on his return from his first voyage on the day of Easter. He was detained in Constantinople waiting for a caravan for seven weeks by a severe attack of sickness at Antwerp. If we assume he set out from Regensburg in the summer of 1636, we have only three months left for the journey from Regensburg to Dresden, Vienna, Constantinople, Erzurum, Tabriz, Ispahan, Bagdad, A Scanderoon, and the voyage from Scanderoon to the East. It is impossible that Tavernier's first journey could have been subsequent to Ferdinand's coronation as king of the Romans. But a strong effort was made by the emperor's father to have him crowned at the close of the year at Regensburg in 1630; and Tavernier, writing some forty years later, may have imagined that the circumstances he witnessed at that time were in his mind the coronation which was expected to take place. In his first volume of his Travels, he mentions two passages in his Travels seem to place it beyond doubt that the visit to Regensburg which led to his first journey took place in 1630. In his first volume of his Travels, the Paris edition of 1776, the expression is used: "I travelled on the road from Ispahan to Bagdad, in 1632, that road once, and that was on his return from his first expedition into Persia. It would be useless to dispute upon the evidence of a figure in a book not yet printed: but in the account of his first journey, he mentions having seen at Tebat the vizir, who was executed a few days later, after being obliged to surrender the siege of Bagdad. This can only refer to the execution of the vizir at the end of April, 1632.

This date being ascertained, the chronology of Tavernier's life may be given with tolerable accuracy. He began his travels to the East from Regensburg, in December, 1630, penetrated by way of Constantinople and Tabriz to Ispahan, and returned by Bagdad and Aleppo to France in the summer of 1633. From this date till the commencement of his second voyage his history is complete blank, had he not told in a postscript that he was appointed comptroller in the household of the Duke of Orleans, who gave him leave to make his first journey to the East. On the 13th of July, 1633, he embarked at Marseille in a Dutch vessel, proceeded by way of Aleppo and Scanderoon, to the Desert west of the Euphrates to Basia. The vessel embarked in a vessel sailing to Ormuz, and thence to Bushire, proceeded through Shiraz to Ispahan. On his stay in that capital, he travelled by Shiraz and

oon, where he embarked for Surat. He visited on this occasion; but here again we are at a loss for to enable us to trace his routes. We only know he passed through Burhampore on his return from Surat in 1641; that he visited Goa and returned to the land about the end of that year; and that he was at Madabad, either going to or returning from Agra, in 1642. That he had revisited Ispahan in the interval is not probable, since he says that 'for six journeys which I made between Paris and Ispahan, I have made twice only from Ispahan to Agra and other parts of the Mogul's dominions.' He was at Ispahan towards the end of the year 1642; and probably soon after returned to France. On his third voyage he took with him the vessel already alluded to, and left Paris on the 6th of October, 1643. This time, after visiting Ispahan as he embarked at Gombroon for India. In January, 1644, he left Surat on an excursion to the diamond-mines of Golconda. In January, 1648, he made a voyage by sea to Europe; and in April of the same year he embarked at Batavia for Europe; whence he returned to Europe in the next fleet in 1649. Tavernier's fourth journey occurred from the 18th of June, 1651, when he set out for Paris, till 1655. On this occasion he proceeded from Paris to Masulipatan, in May, 1652; he revisited the diamond-mines near Golconda in 1653, and in 1654 he travelled from Ormuz to Kerman, and after spending three months there, took the route of Yezd to Ispahan, and returned to Europe by Smyrna. His fifth journey was begun in January, 1656. He was at Agra in 1659, but we are not sure of other dates in this journey. The sixth and last expedition that Tavernier made to the East was begun in Paris, in 1663, and was terminated in 1669. The most important novelty of this journey was his tour to the province of Bengal as far as Dacca, which he returned from him from November, 1665, till July or August, 1667. He was at Ispahan in July, 1667, and on his return to Europe visited Constantinople for the second time.

The very unsatisfactory arrangement adopted in the publication of Tavernier's journeys has rendered it advisable to extract from it the preceding incomplete chronology of his travels.

His first publication was an account of the incidents of the seraglio at Constantinople (*Nouvelle Relation Véritable du Sérail*), published at Paris, in a thin 4to volume, in 1675. This was followed by an account of his travels (*Six Voyages en Turquie, en Perse, et aux Indes*), published at Paris, in two quarto volumes, in 1676. A third volume was added in 1679, containing an account of the origin of the persecution of the Christians in the East Indies; an account of the proceedings of the East India Company from the king and the French company of the East Indies; observations on the commerce of the East Indies; account of the kingdom of Persia; account of the conduct of the Dutch in Asia. In the first volume of his Travels, Tavernier employed Chappuzeau, a French and unintelligent writer: the memoirs contained in the second volume were prepared by Lachapelle, secretary to the president Lamaignon. The account of the seraglio, and the contents of the third volume of the travels, are not only more full expositions of topics touched upon in the first volume, but they are also more interesting.

It is to the first two volumes of Tavernier's Travels that we must look for such information of the countries he visited, the time he spent in them, and the persons he encountered, as is necessary to enable us to know what he witnessed himself, what he learned by report of others, how far his informants were to be relied upon, and how far he was qualified to understand their communications. But the arrangement of the two volumes is the very worst that could be conceived for supplying satisfactory information upon these points.

The first volume professes to give an account of the principal routes by which the Parisian traveller can go to Constantinople, Ispahan, and the Persian Gulf. It is intended as a *route*; the result of all Tavernier's observations upon each line of road is given at once, and it is from incidental remarks that we learn when and in what direction he travelled it. His remarks upon the government, and commerce of the different countries are thrown into intercalary chapters. A similar arrangement is adopted in his second volume, which contains the fruits of his observations in the south of India, in

the region between Surat and Delhi, in Bengal, and in the Dutch possessions in the Eastern Archipelago. The work is neither a systematic account of the geography and statistics of the countries in which Tavernier travelled, nor is it a personal narrative of the traveller. It is an indigested and unsatisfactory attempt to combine both.

Yet are the four volumes we have mentioned full of available matter, both for the historian and the geographer. The former will find in it the fruits of the forty years' experience and observation of a European merchant in Turkey, Persia, India, and the Indian Archipelago, in the seventeenth century. Tavernier did not possess either the intellect or the education of Thévenot and Bernier, but his opportunities of observation were more varied and protracted. He was a part of that commercial enterprise and rivalry of which they were only spectators. He is himself a specimen of the kind of adventurers who at that time managed the commerce of Europe with the East. His unconscious revelations of his own character may be relied upon, and the naïveté with which they are made encourages us to believe what he tells us of others. His statements have not passed unchallenged: they wounded the national pride of the Dutch too sore to be left without a reply, and the partisan feelings of the Protestant literati of Europe induced them to embrace the cause of Holland, in opposition to the *protégé* of Louis XIV. Even the Catholic literati took little interest in a writer who frankly confessed that he saw nothing interesting or valuable in the plain of Troy or the ruins of Persepolis. And yet notwithstanding the violent attacks of the Dutch and Calvinist writers, the silence of others, and even of himself (for Tavernier did not engage in a controversy), not one material assertion he made has been disproved. Unfriendly criticism has been confined to the remark that many of his statements regarding the Dutch are trivial, and betray a littleness of mind: this may be, but they are not the less characteristic for that reason. Tavernier's accounts of the principal objects of Oriental commerce in his day, of the leading markets and routes of trade, of the money of the different countries, and the state of the exchanges, are more full and intelligible than those we find in any other cotemporary writer. His success in trade affords a guarantee of the correctness of the opinions he states. We have collated his routes, whenever this was possible, with those of recent travellers, and have found them in general so accurate, that they may be relied upon for the purposes of comparative geography, and in one or two instances as affording information regarding tracts which have not been visited since his time. Tavernier's notices of the route from Casvin to India by Candahar, and of the provinces to the north of Erivan, leave a favourable impression of his talent for extracting information from the native authorities. He has been accused of plagiarism, principally because of the striking coincidence between his account of the Guebres of Kerman, published in 1676, and that which Louis Moreri published in 1671 from the papers of Father Gabriel de Chinon. It deserves to be noticed that Moreri's publication is lucidly arranged and neatly expressed, while the account contained in Tavernier's travels is confused and miserable in point of diction. Had it been taken from Moreri, it is scarcely possible that the latter could have been so wretchedly composed. Add to this that the information found in the papers of Father Gabriel is not said to have been the fruit of personal observation; that Tavernier resided three months among the Guebres at Kirman, and had frequent dealings with them in India and elsewhere; that he and Father Gabriel repeatedly met in Persia; and it must be allowed that the priest is quite as likely to have derived his information from the merchant as otherwise. In judging of the statements made by Tavernier, the school in which he was trained, and his personal character as it appears from his own story, must always be kept in view. He had no knowledge of or taste for science and literature, for art, or antiquarian research. He acted upon impulse, and his instincts were love of travelling, and desire to acquire money for the sake of spending it in feasting and personal display. A diamond was a more interesting object to him than the mysterious remains of Tcheminar. He had no very nice or refined sense of honour, but he was frank and veracious, and little inclined to deck himself with stolen feathers of literature; possibly because he could not appreciate their value.

In this review we have been obliged to anticipate that part of the history of the third period of Tavernier's life, which relates to what may be called his literary labours. We are thus enabled to abridge the sequel of our narrative. On Tavernier's return from his sixth journey he was presented with *lettres de noblesse*, by Louis XIV., and purchased about the same time the barony of Aubonne in the Pais de Vaud. When his travels were published, they were, as has been intimated above, fiercely attacked; in particular, most virulently by Jurieu, in his 'Esprit de M. Arnauld' (December, 1684); more temperately and with a greater parade of evidence by Henrick van Quellenburgh, in 'Vindiciæ Bataviæ' (Amsterdam, 1684). Tavernier made no reply. Bayle has given a characteristic account of his conduct relative to the publication of Jurieu, which was rather a libel than a criticism. 'He made a noise in the taverns and streets, he threatened and even named the day and hour when he would apply to the Walloon consistory of Rotterdam to demand execution of the canonical laws against the minister who had dishonoured him: but his threatenings came to nothing, he retired very peaceably, and never commenced any persecution at all.' The misconduct of a nephew, to whom he had intrusted the management of his affairs in the Levant, obliged him to sell, some time previous to 1688, his hotel in Paris and his estate of Aubonne. He retired first into Switzerland, and subsequently to Berlin, where he was nominated by the elector of Brandenburg director of a projected East India Company. From the time of his first journey he had regretted being prevented from carrying into execution a design which he then entertained of returning from Persia through the Russian dominions. His new appointment afforded him an excuse and opportunity for making that journey, and he set out to travel to the East Indies across Russia in 1688. He was taken ill at Moscow, and died there in the month of July, 1689. The equivocal conclusion of Boileau's inscription on Tavernier's portrait contains a fair enough estimate of his character:—

'En tous lieux sa vertu fut son plus sûr appui;
Et bien qu'en nos climats de retour aujourd'hui
En foule à nos yeux il présente
Les plus rares trésors que le soleil enfante;
Il n'a rien rapporté de si rare que lui.'

(*Les six Voyages de Jean Baptiste Tavernier, Ecuyer Baron d'Aubonne, en Turquie, en Perse, et aux Indes*, à Paris, 1676-9, 4to.; *L'Esprit de M. Arnauld, tiré des écrits de lui et de ses disciples*, Deventer, 1684, 12mo.; Henrick van Quellenburgh's *Vindiciæ Bataviæ, ost: Refutatio van het Tractuet van J. B. Tavernier, Chevalier, Baron d'Aubonne*, Amsterdam, 1684, 4to.; Bayle, *v. 'Tavernier'*; *Biographie Universelle, v. 'Tavernier, Jean Baptiste'*, par Weiss.)

TAVISTOCK, a parliamentary borough and market-town, on the south-western border of Devonshire, 207 miles from London, 34 from Exeter, and 11 from Plymouth. The parish extends between the western extremity of Dartmoor and the river Tamar, and, according to a survey made in 1781, comprises 13,987 acres, or nearly 22 square miles; but it is probable that this survey included lands within the boundary of the borough which are not in the parish: in the census of 1831 the area of the parish is stated to be 11,660 acres. The surface of the parish is diversified by hills from 300 to 600 feet in height, which rise in continued succession and are separated by valleys often deep and narrow, the general direction of which is from north-east to south-west. The higher ground towards Dartmoor is of granitic formation, and the neighbourhood of the town consists of schistose rock. The town is situated nearly in the centre of the parish, on the north-west bank of the Tavy, which here flows rapidly through a narrow valley, from which the ground rises steeply on both sides to the height of several hundred feet. The river is crossed by two bridges within the town. A narrow valley, or gully, from the north, is also covered by houses. The climate is variable, and the average quantity of rain falling in the year is 45 inches.

In 961 an abbey was founded at Tavistock, which was burnt by the Danes, and afterwards rebuilt on a larger scale. Henry I. (1100-1135) granted to the abbot a weekly market and a fair. In 1513 the thirty-fifth abbot was called to the House of Peers, but in 1530 his successor surrendered to the king, when the revenue of the abbey was estimated at 902*l*. A printing-press was established in the abbey soon after the introduction of the art

into England. Fragments of the abbey still remaining are chiefly incorporated with other buildings; and the factory is used as an assembly-room. John, Lord ancestor of the Duke of Bedford, obtained a great abbey lands. An antient lazaret-house once stood on of the workhouse. The parish church is a spacious with a tower at the west end supported on arches; interior consists of four aisles and a chancel, and some good monuments. The living is a vicarage at 302*l*. per annum. The Independents, Unitarians, Quakers, and Wesleyan Methodists have places of worship. The date of the foundation of the grammar-school is not known, but in 1649 Sir John Gianville left an endowment for the education of one boy, which yields about 20*l*. per annum; and the Duke of Bedford, in whom the school is vested, allows the master the use of a house besides other advantages, and 20*l*. a-year for the education of eight boys. There is a Lancasterian school supported by subscription, which in 1833 was attended by 135 boys and 88 girls. At the same period seven other schools were attended by 203 boys and 224 girls; there were five Sunday-schools, in which 381 boys and 333 girls were instructed. There are two almshouses for four poor widows, who each receive 2*l*. a-year; another for fifteen persons, nominated by the Duke of Bedford, who receive 3*l*. a-year each. A sum of 100*l*. is applicable to the apprenticing of poor children.

Tavistock returned two members to parliament at the passing of the Reform Act, a privilege which it enjoyed since 1295 (23 Hen. I.). The right of election was in the resident freeholders. The Tavy forms the boundary of the borough on one side, and on the other the limits were defined by an artificial line. Under the Reform Act the borough was made co-extensive with the limits of the parish, the manor of Cudliptown was incorporated, and it still returns two members. The number on the register, in 1840, was 347. Tavistock is a borough incorporated. The portreeve, who is elected annually, is the chief officer of the lord of the manor, is the chief magistrate, and makes the return of the elections. It is one of the polling-places for the county.

The parish registers of Tavistock from 1617 to 1811 have been made the subject of a more careful and accurate examination than those of any other place in Devonshire. This task was undertaken by Dr. Barham, and the results are given in a series of tables which are printed in vol. ix. of the 'Tables' published by the Board of Trade. An abstract of them is given in vol. iv., part ii., of the 'Journal of the London Statistical Society.' The population of the parish, in 1781, was 3117; in 1811, 3483; in 1821, 5483; in 1831, 5602. The increase between 1811 and 1821 is attributed to the extension of manufactures in the neighbourhood. There are some small manufacturing establishments. Tavistock is one of the 1500 poorest towns in the county. In 1817 a canal was opened, which, after a course of 5 miles, 2 of which were under a tunnel, enters the Tamar at Morwell Hill. The head of the canal is connected with the quays at Tavistock by an inclined plane 240 feet high. This canal connects Tavistock with Plymouth. Sir Francis Drake was a native of Tavistock.

TAWI-TAWI. [SOOLOO ARCHIPELAGO.]

TAX, TAXATION. A tax is a portion of the labour and industry of a country placed at the disposal of the government.

Taxation is the general charging and levying of particular taxes by the government upon the community.

OBJECTS OF TAXATION.

In a free state it is assumed that all taxation is levied for the public good; if it is not necessary, the tax should no longer exist. The amount of expenditure that should be determined by the magnitude of the public debt, and by the number and importance of its political obligations; yet the prudence with which its affairs are conducted will affect the demands of the government upon the people, nearly as much as its necessities. The expenditure of a private person must be regulated by his income; in a state, the expenditure that is needed is the measure of the public income that must be obtained to meet the demands of a civilized community requires not only protection against foreign enemies and the means of internal security, but also the various institutions of civil government conducive to the welfare, and which its wealth enables it to maintain.

injurious pressure upon its resources. It is the duty of a government to provide these, when proved to be necessary, in the best manner and at the least expense with their efficiency.

The Select Committee of the House of Commons on public income and expenditure in 1828 'unanimously declared their full assent to the principle, that no tax is justified in taking even the smallest sum of money from the people, unless a case can be clearly established that it will be productive of some essential benefit to them, and of one that cannot be obtained by any other means.' The committee truly added to the effect of this just principle, that 'nothing requires more wisdom and prudence than to fix the public expenditure at an amount that the real wants of the people can be made to give way to any imaginary wants of the latter arise from so many sources, that it is very difficult to prevent the operation of an excess.' (*Second Report*, p. 4.) One of the first duties of representatives of the people is to watch with care the expenditure of the public money. Every tax is viewed as the purchase-money paid for equities and advantages given in return. This principle assumes the necessity of moderation in levying taxes, and will be denied by any one when stated in that form; it is uncommon to hear it argued that so long as a tax is levied in the country, the amount is not of consequence; the money is returned through various channels to the people from whom it was derived. The principle laid down at once exposes the fallacy of this argument by reducing it to a simple question between creditor and debtor. For example, by paying a million of money every year, the people obtain the services of an army; we will suppose to be an equivalent, and we assume that the food and clothing of the soldiers is paid for out of the entire pay of the men is spent in the country. The whole of the money will thus be returned to the people. Not as a free gift, not as the repayment of a loan, but in the purchase of articles equal in value to the whole sum. The only benefit obtained by this is the convenience of trade; for the community has already its money, and then out of its own capital and labour produces what is equal to it in value, and this is the state, receiving as payment the very sum it has contributed as a tax.

Every new tax may be expended, they must be as injurious to the community. 'Every new tax, says Ricardo, 'becomes a new charge on production, which raises the natural price. A portion of the labour which was before at the disposal of the consumer is placed at the disposal of the state, therefore he is employed productively.' (*Political Economy*, p. 206.)

GENERAL PRINCIPLES OF TAXATION.

It is settled that taxation should be generally and in the light as possible, it must be determined upon principles and in what manner taxes may best be levied. Other branches of legislation is perhaps so important as the wise application of just principles in the taxation. The wealth, happiness, and even the lives of the people are dependent upon the financial policy of their government.

The following lays down four general maxims, which we will cite not only as being perfectly true in themselves, but as proceeding from an authority that not to notice them might be accounted a neglect.

1. Every subject of every state ought to contribute to the support of the government as nearly as possible in proportion to their respective abilities; that is, in proportion to the revenue which they respectively enjoy under the laws of the state.

2. Every tax which each individual is bound to pay should be certain, and not arbitrary. The time of payment, the quantity to be paid, should be clear and plain to the contributor, and to the person.

3. Every tax ought to be levied at the time or in the manner most likely to be convenient for the contributor.

4. Every tax ought to be so contrived as both to take

out and keep out of the pockets of the people as little as possible over and above what it brings into the public treasury of the state.

In discussing the merits of particular taxes and classes of taxes, we shall have to consider with some minuteness the application of Adam Smith's first maxim. Its justice requires no enforcement or illustration, although unhappily the object is most difficult of attainment. The second maxim is of great importance, and the necessity of adhering to it must be universally acknowledged. Uncertainty gives rise to frauds and extortion on the part of the tax-gatherer, and to ill-will and suspicion on that of the contributor, while it offers a most injurious impediment to all the operations of trade. Notwithstanding the many evils of uncertainty, it is by no means an uncommon fault even in modern systems of taxation. We would pass over the practices of Eastern despotisms, where uncertainty and caprice prevail instead of fixed rules, but that the vices of their taxation are so exaggerated as to show the evils of a departure from just principles in the broadest light. All taxation is forbidden by the Koran, and although the prohibition has been evaded and broken through by the Turkish government in particular instances, it has always been an obstruction to any general system of imposts. In the absence of regular taxes, partial and irregular exactions are resorted to for supplying the wants of the sultan. Plunder becomes the business of every governor of a province, and thus the Koran, instead of defending Moslems from tax-gatherers, gives them up to public robbers. 'No man is secure in his property for an instant; all are compelled carefully to conceal their possessions, lest they should lose their liberty or possibly their lives and their property too. Industry is thus not merely cramped, but almost prevented or extirpated, by men being deprived of all confidence in their enjoyment of its rewards. The country, fertile in its resources of all kinds, is left waste, or only cultivated as far as the absolute necessities of providing sustenance may require. The nearer you approach the seat of government, this is more the case; and the neighbourhood of the capital, which in other countries is naturally the scene of extended labour, thick population, and great cultivation, is in Turkey marked by barrenness and neglect. Constantinople can only be approached on the land side by travelling through extensive wastes without either man or beast or tillage.' (*Political Philosophy*, ch. 3.)

In Persia the same uncertain and oppressive mode of exacting money for the use of the sovereign is resorted to, and is followed by similar results.

Under the more constitutional governments of Europe the people do not indeed suffer from violent exactions, but industry, production, and commerce are too often restrained by irregular and ill-defined taxes. Spain unhappily affords many examples of misgovernment, and the injurious character of its taxation is shown in reference to this as well as other principles. To select one instance of uncertainty: 'Every landowner is liable to have his property taken in execution for government taxes, if he is not prepared to pay a half-year or more in advance, according to the difficulties of the Exchequer; consequently he is often compelled to make great sacrifices in order to meet such exigencies.' (*Madrid in 1835*, vol. ii., p. 107.)

Perhaps there is no better example of the evils of uncertainty than that of the State duties levied by the king of Hanover upon all ships passing up the Elbe from the sea, and upon their cargoes. The tariff taxes 2368 articles of commerce, and lays several duties upon the same articles, so that the whole number of duties is 6688. 'There are 35 different duties upon iron; 32 duties upon yarn or twist; 18 duties upon sugar; 42 upon leather; 36 upon oil; 126 upon wood, and so on with respect to other important articles of trade.' The tariff also 'recourse to all modes and devices of taxation, by weight, by measure, by number, by value; and what is worse, it vests in the custom-house officers the sole discretion of determining by what standard they will charge the duty. The collector imposes that kind of duty which will produce the most money in the particular case. The consequence of this to the merchant is most serious. He cannot calculate or inform himself beforehand how much his goods will have to pay at Brunshausen.' (*Edinburgh Review*, No. cl., p. 361; *Hutt's State Duties*.) There are also arbitrary fines for trivial informalities in the ship's papers, and which are said to rest practically with the subordinate officers, who

likewise harass the merchants with a multitude of petty exactions for their own advantage. Such a system, it need scarcely be said, is most discouraging and injurious to commerce. British merchants have been loud in their complaints, and the governments of this country and of Hanover have recently engaged in negotiations, which, it may be hoped, will settle these obnoxious duties upon more sound and equitable principles.

To levy a tax 'at the time and in the manner most likely to be convenient for the contributor to pay it' is always a wise policy on the part of the state. The time or manner of payment may often be more vexatious than the amount of the tax itself, and thus have the evil effects of high taxation, while it produces no revenue to the state. Suppose, for example, that a merchant imports goods and is required to pay a duty upon them immediately and before he has found a market for them:—he must either advance the money himself or borrow it from others, and in either case he will be obliged to charge the purchaser of the goods with the interest; or he must sell the goods at once, not on account of any commercial occasion for the sale, but in order to avoid prepayment of the tax. If he pays the tax and holds the goods the consumer will have to repay not only the tax but the interest; and if he parts with them at a loss or inconvenience, trade is injured, and the general wealth and consequent productiveness of taxation proportionately diminished. To prevent these evils the *bonding* or *warehousing* system was established, which affords the most liberal convenience to the merchant and a general facility to the trade of a country. Certain warehouses are appointed under the charge of officers of the customs, in which goods may be deposited without being chargeable with duty until they are cleared for consumption, and thus the tax is only paid just when the article is wanted, and when it is least inconvenient to pay it. [WAREHOUSING SYSTEM.]

Similar accommodation is granted on their own premises to the manufacturers of articles liable to excise duties. At present the customs bonding-warehouses are confined to the ports. An extension of them to inland towns would be sound in principle, very convenient to trade, and unattended by any serious risk to the revenue or difficulty of management and supervision.

The evils resulting from inconvenient modes of assessing and collecting taxes have been very seriously felt in this country under the operation of the excise laws. When any manufacture is subject to excise duties, the officers of the revenue have cognizance of every part of the process, inspect and control the premises and machinery of the manufacturer, and often even prescribe the mode of conducting and the times of commencing and completing each process; while the observance of numberless minute regulations is enforced by severe penalties. The manufacturer is put to great inconvenience and expense, and his ingenuity and resources are constantly interfered with in such a manner as to impede inventions and improvement, and to diminish his profits. Some manufactures have been entirely destroyed by oppressive regulations. The making of lenses of telescopes was at one time a flourishing trade. England had the supply of the whole of Europe, but within the last few years the manufacture has been transferred to France and Italy, entirely in consequence of the prohibition of the excise laws against conducting the necessary series of preliminary experiments. (*Digest of Reports of Commissioners of Excise Inquiry*, p. 13.) Trades less unfortunate than that just referred to are nevertheless very severe sufferers. A London distiller stated to the Commissioners of Excise Inquiry, that assuming that the duties on spirits distilled by him should be fully secured to the revenue, 'it would be well worth his while to pay 3000*l.* a year for the privilege of exemption from excise interference.' (*Ibid.*, p. 15.)

Any injury done to trade is injurious to the state by diminishing the national wealth and the employment of labour. It has the same effect also upon the revenue as excessive taxation. The high price of the article limits the consumption and consequently the revenue arising from it. The injurious effects of the excise restrictions 'must be felt in an accumulated degree by the public who are the consumers, against whom the tax operates by the addition made to the price of the commodity, not only by its direct amount, but by the necessity of compensating the manufacturer for his advance of capital in defraying

it, and also by the increased cost of production.' (*Part*, p. 15.) In the case of a heavy tax, which also diminishes consumption, the state, at least, derives some benefit; but in the case of onerous restrictions and impediments to trade caused by the mode of collecting a tax, the state gains nothing whatever, and the manufacturers and the consumer are seriously injured, without an equivalent to any party. If the consumer must suffer, it should, at least, be for the benefit of the revenue, for then his contributions may be diminished in some other direction. Great attention has been paid, of late years, to the improvement of the excise regulations, especially by the Commissioners of Inquiry, under the able direction of Sir Henry Parnell. Various restrictions have been removed, and it is to be hoped that the excise revenue may be found capable of being collected without inflicting greater injuries upon trade than other branches of taxation.

The net produce of a tax is all that the state is interested in, and therefore any violation of the fourth maxim of Adam Smith is liable to the same objections as those already stated in reference to the third. Such violation increases the amount of the tax directly, as the former was shown to increase it indirectly, without any advantage to the state. Facility of collection is a great recommendation to any tax, and, on the contrary, a disproportion between the cost of collecting and the amount ultimately secured is a good ground for removing a tax, though founded, in other respects, upon just principles. On this account alone, as well as for the general convenience of trade, it is worthy of serious attention, whether the customs duties upon a great number of articles of import should not be altogether repealed. Although great alterations have recently been made in our tariff, the number of articles remains the same. In 1839 there were 349 distinct articles, each producing less than 100*l.* a year, and in the aggregate only 8050*l.* There are also 132 articles producing from 100*l.* to 500*l.* each, and altogether 31,629*l.*, while 46 articles produced 98 per cent. of the whole customs revenue. (*Import Duties Report*, 1840, p. 4.) It is obvious that the examination of every description of merchandize and package, and the assessment of nearly 1200 different rates of duty, must greatly increase the establishment required for collecting this branch of the revenue. The cost of collecting the duties upon the larger and more productive articles of import could bear but a small proportion to the amount of the tax.

The following table may be interesting as showing the rate at which the whole revenue is collected in the United Kingdom:—

Table showing the Cost of Collecting the Revenue of the United Kingdom of Great Britain and Ireland for Ten Years, from 1832 to 1841 inclusive (compiled from the Annual Finance Accounts).

	Gross Receipt of Revenue.			Charges of Collection.			Rate per cent. for which the gross receipt was collected.		
	£	s.	d.	£	s.	d.	£	s.	d.
1832	49,571,459	17	8	3,064,702	13	11	6	3	7½
1833	52,571,116	14	11	3,560,693	4	4	6	15	5½
1834	52,753,246	17	11	3,582,635	4	4	6	15	9½
1835	52,589,992	4	6	3,560,238	18	11	6	15	4½
1836	54,973,677	0	6	3,493,641	17	1	6	7	1½
1837	52,287,737	14	0	3,430,679	6	6	6	11	2
1838	52,979,236	13	10	3,450,940	12	4	6	10	3
1839	53,345,498	14	7	3,483,533	4	9	6	10	7
1840	52,916,049	8	3	3,549,009	15	5	6	14	1½
1841	53,596,250	14	4	3,582,639	7	11	6	13	8½

There is little variation from year to year on the gross charges of collection, but there is a considerable disproportion in the cost of collecting different branches of the revenue. In 1841 the excise cost 6*l.* 7*s.* 8*d.* per cent. in the collection; the assessed taxes 4*l.* 2*s.* 9*d.*; and the revenue arising from stamps only 2*l.* 3*s.* 4*d.*

The French revenue is collected at a much greater cost. For some years past the average revenue of that country has been 1,020,000,000 francs, or 40,000,000*l.*, and the expenses of managing and collecting that sum have amounted to 150,000,000 francs, or 6,000,000*l.*, being no less than 15 per cent. (*Commercial Tariffs, Part IV., France, 1842, p. 11.*) It is very probable that many items may be included in

such calculation of the expenses of collection which is stated in the English accounts; but making liberal allowance on that account, a great disproportion remains in the cost of collecting the revenue in the two countries. It may perhaps be fairly estimated that the cost of France costs twice as much in the collection as England. The expenses of collecting a revenue high without any reference to the mode of taxation, an efficient tax may be collected in a bad manner, either by employing numerous idle and highly paid officers, or by issuing regulations and checks, which may cost the government much and protect the revenue very little. Of no causes of expense it is difficult to pronounce the most injurious to a country. The former will probably be found to form part of a general system of ill-directed expenditure; the latter may arise from unwisdom for the security of the revenue. In France the great number of official persons is notorious, and in that country we must seek for the main cause of the enormous expense of collecting the revenue.

DIFFERENT CLASSES OF TAXES.

In selecting one or more classes of taxes for raising the revenue of a state, the principles already discussed should be observed as far as possible; but these do not point out any particular mode of taxation as preferable to others. Every mode of raising the necessary funds may be pressed most equally upon different members of the community, to be least liable to objections of uncertainty, inconvenience in the mode or times of payment, or to be added with the least expense, is fairly open to the consideration of a statesman; unless objections of some other kind can be proved to outweigh these recommendations.

Two great divisions under which most taxes may be arranged are *direct* and *indirect*.

I. Direct Taxes.

Taxes ought to be paid from the income of the community. To derive revenue from capital is to act the part of a landlord; and such a practice, as in private life, is condemned. If the taxes of any country should be so disproportioned to its income, that in order to meet its continual inroads must be made upon its capital, resources would fail, employment of labour would be diminished, and the revenue must necessarily be reduced by general impoverishment of the tax-payers. Such a system could not long continue as regards all capital, but might affect particular branches of capital, or all capital in particular conditions. In whatever degree it is permitted to be levied it is injurious. A tax upon legacies is a wrongful deduction from capital; and on that account objectionable, although it is profitable to the treasury and easily collected. In this country legacies left to persons are charged with a stamp duty of 10 per cent., when left to relatives the scale of duties is sufficiently high to cause a serious diminution of the capital. A duty is charged on proving a will, called *probate duty*, which is perhaps more frequently paid out of the income than the capital. The same observations will apply to duties charged upon succession to the property of intestates.

These exceptions it has been the object of the legislature to derive all taxes from income, either by assessment or by means of the voluntary expenditure of the people upon taxed commodities. Direct taxes upon the land have been universally resorted to by all nations. Such taxes are obvious, and require little refinement to devise; and in countries where commerce, land is the only source from which a revenue can be derived. In most of the Eastern countries the greater part of the revenue has usually been derived by heavy taxes upon the soil. The tangible nature and of its produce offers great temptations to immobility of taxation. In Spain, at the present time, the taxes upon the soil are most oppressive and injurious. The tax upon corn-fields is so heavy, that farmers in general are more to their interest not to till their lands at all, but to run the risk of losing their costs and charges, and labour to boot, by the exorbitancy of the intendiente's price, which they would have to meet. They have therefore the plan therefore of sowing no more wheat than is necessary for the sustenance of their own families. It is a sad and indeed to all who are conversant with the state

of agriculture in Spain, that unless a complete change takes place in the system of taxation, so as greatly to reduce the burthens upon the land, there will not only be a stagnation in rural industry, but eventually the country will cease to produce a sufficient quantity for its own consumption of that superior wheat on which Spaniards pride themselves, and which was formerly and might still be grown in sufficient quantities to supply all the markets in Europe. (*Madrid in 1835*, vol. ii., p. 109.)

The land-tax in England is one of considerable antiquity. We find that under the Saxon kings a tax of this description was in use. When the invasions of the Danes became frequent, it was customary to purchase their forbearance by large sums of money; and as the ordinary revenues of the crown were not sufficient, a tax was imposed on every hide of land in the kingdom. This tax seems to have been first imposed A.D. 991, and was called *Danegeld*, or Danish tax or tribute. (*Saxon Chronicle*, by Ingram, p. 168.) It was originally one shilling for each hide of land, but afterwards rose so high as seven: it then fell to four shillings, at which rate it remained till it was abolished about seventy years after the Norman conquest. (*Henry, Hist.*, vol. iii., p. 308.) A revenue still continued to be derived under different names from assessments upon all persons holding lands, which however became merged in the general subsidies introduced in the reigns of Richard II. and Henry IV. During the troubles in the reign of Charles I. and the Commonwealth, the practice of laying weekly and monthly assessments of specific sums upon the several counties was resorted to, and was found so profitable, that after the Restoration the ancient mode of granting subsidies was renewed on two occasions only. (*Report of House of Commons on Land Tax as affecting Catholics*, 1828.) In 1692 a new valuation of estates was made, and certain payments were apportioned to each county and hundred or other division. These payments have varied in amount from 1s. in the pound to 4s. on the assessed annual value, according to the annual Land Tax Acts, but whatever may have been the variations in the rate levied, the valuation has been the same; and the proportion chargeable to each district has continued the same as it was in the time of king William III., as regulated by the Act of 1692. That assessment is said not to have been accurate even at that time, and of course improved cultivation and the application of capital during the last 140 years have completely changed the relative value of different portions of the soil. On account of the generally increased productiveness of land, the tax bears upon the whole but a trifling proportion to the rent, yet its inequality is very great. For instance, in Bedfordshire it amounts to 2s. 1d. in the pound; in Surrey, to 1s. 1d.; in Durham, to 3d.; in Lancashire, to 2d.; and in Scotland, to 2½d. (*Appendix to Third Report on Agricultural Distress*, 1836, p. 545.) Adam Smith imagined that this tax was borne entirely by the landlords, but this opinion has been proved to be erroneous by modern political economists, who hold that the tax increases the price of the produce of the land, and is therefore paid by the consumers. Of that we entertain no doubt; but we are unable to agree with Mr. Ricardo, that the English land-tax is not objectionable as regards Adam Smith's first principle, viz. on the ground of inequality. (*Political Economy*, chap. xiii.) He assumes that inferior land would not be cultivated until the price of produce had become so high as to remunerate the grower after payment of the tax; and that the owners of the soil therefore would not suffer, but only the consumer. But land is often cultivated for pleasure, for scientific experiment, and for speculative purposes, while in this country the exclusion of foreign supply at a time when population was rapidly increasing has forced inferior soils into cultivation. Then admitting that the consumer pays the tax, the owners of land appear to us to be in the same relation to each other as merchants would be who should be charged unequal rates of duty upon articles in which they deal. In that case the consumer would ultimately pay the tax, but no one will deny that the seller who pays the highest tax in the first instance meets his competitor at a disadvantage in the market. He must wait for very high prices, or must sell at lower profits. Such is actually the case where articles imported from different countries bear unequal rates of duty; and such, we apprehend, must be the case where the land is unequally assessed according to its value. [LAND-TAX.]

A tax upon the gross rent of land would fall upon the landlord, and would be in fact a tax upon his annual income, and as such would fall with undue severity upon him, unless other classes of the community should be liable to a proportionate deduction from their respective incomes for the benefit of the state. This brings us to consider the expediency of a general tax upon all incomes.

As the object of taxation should be to obtain from each individual in a state a contribution to the expenses of government in proportion to his means; and as, in whatever form the tax may be levied, the contribution should be paid in every case from income, and not from capital, the simplest and most equitable mode of taxation would appear to be that which, after assessing the annual income of each person arising from all sources, should take from him, directly, a certain proportion of his income as his share of the general contribution. Such a tax, equitably levied, would appear to agree in theory with all the four maxims of Adam Smith; but practically, every tax upon income must abound in inequalities, in uncertainty, and in great personal hardships and inconvenience.

In order to make such a tax fall equally upon all, in the first place, the assessment must be equal. But how is this to be effected? By the voluntary statement of each person, or by investigation and proof? If by the former means, the equality of the tax would depend upon the honesty of parties placed under a temptation to be dishonest: the least scrupulous part of the community would be taxed lightly, and the conscientious would bear the main burthen of the tax. If by the latter means, viz., by investigation and proof, the dishonest still have an advantage over the conscientious: because income arising from some sources, being capable of direct assessment, cannot be concealed; while other descriptions of income are often known only to the possessor, upon whose declaration alone, in such cases, reliance must be placed.

But supposing that either by declaration or by proof, or by both combined, the actual income of each individual could be ascertained, the mere income of persons is a most fallacious test of their means or ability to bear taxation. One man has a fee-simple estate in land, or money in the funds, producing an income of 1000*l.* a year, which will descend to his children after his death; another, by a laborious and uncertain profession, also obtains an annual income of 1000*l.*, dependent not only upon his life, but upon his health and a thousand accidents. The annual incomes of these two men are the same, but their circumstances are most dissimilar. Before the latter could be placed in the same position as the former, he must have an income large enough to enable him to insure his life for a sum of which the interest would be 1000*l.* a year, and still have 1000*l.* left to spend annually, after the payment of the premium. But even then, if he should lose his health, his present income would fail him, he would not be able to continue the insurance, and his position therefore would still be more precarious than that of the proprietor of land or funded property. Yet these two men, with means so unequal, would be assessed alike, and charged with equal contributions. But suppose that, instead of insuring his life, the professional man should save half his income every year, he would still be charged upon the whole, and thus his *capital* as well as his income would be taxed.

The case of annuitants also may be instanced as one, amongst numerous others, of peculiar inequality. One person invests his money in permanent securities, and retains his capital, but derives a small income, and therefore contributes a proportionally small rate of tax: another purchases an annuity, and parts with his capital; but as his income is much larger than that of the capitalist, he pays a higher tax. At first sight this may appear a just arrangement; but in fact not only the income of the annuitant is taxed, but also his capital; for that which is taxed as his income is derived partly from the interest of his purchase-money, and partly from an annual repayment of a portion of his principal.

These and many other evident cases of inequality can scarcely be questioned; but it is alleged that other taxes press with as much inequality upon different classes of persons, and that no attempts are made to equalize their pressure, as the causes exist in the circumstances of the people, and not in the nature of the taxes. (Pitt's *Speeches*, vol. iii., p. 9.) It is said that the assessed taxes affect the professional man to the same extent as the man

of property. There is however this essential difference between taxes upon income and taxes upon property: the former are compulsory, the latter are voluntarily paid or avoided at the option of each individual. In the case of a tax upon income, an income-tax seizes upon the individual's capital: a tax upon expenditure is levied upon the individual's income only which he thinks it prudent to spend.

To smooth in some degree the inequalities of a tax, 1st, the annual premiums on policies of insurance should not be reckoned as income in the assessment, being clearly capital, and the payments being optional, as the insurance could not be avoided without loss; this provision was made by Mr. Pitt's 1799 Act. 2ndly, incomes arising from realized property should be taxed at a higher rate than the profits of professions: 3rdly, annuitants should be rated in the same manner as to avoid the assessment of any portion of their capital as part of their income: 4thly, all persons should be liable to the tax, whatever may be the amount of their incomes.

In addition to the unequal pressure of an income-tax which cannot be altogether corrected by any other means, there is much uncertainty in the assessment of different classes of persons. The vicissitudes of trade or deferred payments, render the incomes of merchants and professional men very uncertain; and non-residents, therefore, which afterwards cannot be readily charged with the tax.

But the last and strongest of the objections to an income-tax is the inquisitorial nature of it, which brings into the affairs of all men, which is necessary for the statement of their incomes. This objection is treated lightly by some; but by the mass of mankind it is considered, beyond all question, as an inconvenient and unseasonable quality of an assessment. Even if the exposure of a man's affairs could be considered a possible injury, yet as an offence to his feelings, and as a hardship which is not involved in the payment of other taxes. How many persons are obliged to conceal the amount of their wealth? It may be said that they certainly must have strong motives for doing so; but they certainly must have strong motives for doing so, who cannot sympathise with the feelings of an individual who conceals the extent of his poverty, and, by a display of hard economy, is still enabled to bear up against adversity? It is in vain to deny, what all men will admit, that the appearance of poverty does degrade a man in the estimation of others; and the feelings of good men ought to be affected by it. But apart from matters of feeling, injury of a man's credit is also inflicted upon individuals by an exposure of their means and sources of income. Mercantile men, who are in dread of competition, take pains to conceal their capital, the rate of profit realized, their commercial credit, all of which must be disclosed, if they are charged with their serious injury, when there is an investigation of their profits.

For these reasons, the mode of collecting an income-tax certainly cannot be approved of as being the most convenient to the contributor. Its general objection when in operation is the best proof of its inconvenience. Upon the whole, a tax upon income is so difficult to adjust equitably to the means of the individual, and the mode of collection is necessarily liable to so strong objection, that, if resorted to at all, it should be reserved for extraordinary occasions of state emergency, when ordinary sources of revenue cannot be relied on.

The English assessed taxes have as few objections in principle as most modes of direct taxation. In the case of equitable assessment and special exemption cases, they are capable of being made to bear a just proportion to the incomes of the individuals who pay them. They share, however, in the general objection of all direct taxes, and it cannot be denied that they press unequally upon particular persons. The windows in a house is a very imperfect criterion of annual value, and in our opinion the house-tax as it has been removed was far preferable, in principle, to the present duty, which is still retained. The inequalities of the assessments were undeniable; but these might have been corrected by careful valuation. Under ordinary circumstances, a tax upon houses will fall upon the

ended to pay it; but if a very heavy tax were imposed, it would discourage the occupation of houses, diminish the demand for them, and thereby diminish the value of the landlord, or, in other words, transfer the amount to him. (Adam Smith, book 5, chap. ii.; *Political Economy*, chap. xiv.) Such a tax attended with very bad consequences; it would induce persons to live in inferior houses or in lodgings, thus diminish their comforts and deteriorate the quality of life; and by reducing the demand for houses would limit the employment of capital and labour in building. The direct taxes upon horses, carriages, powder, armorial bearings &c., being paid by the rich to gratify their own taste for display, are not likely to meet with many objections. The use of such articles generally indicates the wealth enjoyed by the contributor, and the tax is not likely to discourage expenditure or to make any sensation from his means. The principle of levying a direct tax is exhibited in the assessment of property in every parish in England to the poor rates. Local knowledge renders correct valuation possible, and every person occupying land, houses, or other property in a parish, is assessed so much in the pound upon the value thereof, to raise the necessary funds for the use of the poor.

The abuses of direct taxation are too numerous, especially as many of them involve the principles of political economy which would be beyond our limits. For arguments and illustrations concerning the incidence of tithes, of taxes upon wages, and other descriptions of direct impositions, to the able works of Adam Smith, Ricardo, and other eminent writers upon political

II. Indirect Taxes.

Imposing one tax to another, a statesman may be influenced by political considerations as well as by strict financial expediency, and nothing is more likely to be his choice than the probability of a cheerful acquiescence on the part of the people. All taxes are disliked the more directly and distinctly they are received, the more hateful they become. On other grounds, 'indirect taxes,' or taxes upon the consumption of various articles of merchandize, are in a high favour with most governments. 'Taxes are not to be despised,' says Montesquieu, 'are felt the least, because no formal demand is made upon the consumer; they can be so wisely contrived, that the people are ignorant that they pay them. For this end it is necessary that the seller shall pay the tax, and not the buyer; that he does not pay it for himself; and who pays it in the end, confounds it with the price of the article. This indirect tax is apt to be undervalued by writers upon political economy; but it is undoubtedly a great merit in a system of taxation (which is but a part of general management) that it should be popular and not give rise to discontent. A tax that is positively injurious to the parties who pay it without thought, is, certainly, to be defended merely on the ground that no other is made of it; but it may be safely admitted, that of two taxes equally good in other respects, the best which is most acceptable to the people is the very facility, however, with which indirect taxes are levied, makes it necessary to consider the indirect effects of them with peculiar caution. There is no warning, as in the case of direct taxes, to be given, or caused by an impost which is productive of every one seems willing to pay. When any industry is visibly declining, and its failure can be traced to no other cause than the discouraging pressure of a tax, the necessity of relief is felt at once; but if trade and manufactures are flourishing, and the country advancing in prosperity, it is difficult to detect the latent in-justice in restraining that progress, which but for the tax would have been greater; and still more difficult to imagine the new sources of wealth which might have been laid open if such taxes had not existed, or had been levied, or had been collected at different times and in different ways.

Edinburgh, No. 1502.

The government is directly interested in the increase of national wealth, and taxes upon commodities should be allowed to interfere with it as little as possible. On this account duties upon raw materials are very objectionable. They increase the price of such materials, and thus limit the power of the manufacturer to purchase them, and to employ labour in increasing their value, and in adding to the production and capital of the country. They discourage foreign commerce and the employment of shipping; for as the power of buying is restrained, so also is that of selling, and the interchange of merchandize between different countries is checked. Moreover, by increasing the price of the exported manufactures, they limit the demand for them abroad and subject them to dangerous competition.

Similar objections may be urged against taxes upon domestic manufactures, since by increasing the price they diminish consumption, and consequently discourage the manufactures, which if left to themselves would have given employment to more capital and labour, and would have added greatly to the amount of national wealth and prosperity. The object of a government should always be to collect its revenue from the results of the successful employment of capital and industry, and not to press upon any intermediate stage of production.

Adopting this view of the objects of taxation, the British legislature has of late years very wisely repealed or reduced various duties upon raw materials and upon manufactures. Of the former we may instance the customs' duties on barilla; on raw, waste, or thrown silk; on cotton-wool and sheep's wool, unwrought-iron, hemp, and flax; which have been from time to time very much reduced. Of the latter, the taxes on printed goods, on candles, and on tiles, have been altogether removed; and those on plate and flint glass, on malt, and on soap, have been partially remitted. There are still many similar taxes which need revision. Of these perhaps the most injurious are the heavy duties upon foreign timber, which we shall show other reasons for condemning, in treating of protective duties; but in this place they must be particularly censured, as offering a serious obstruction to ship-building (one of the most important branches of national industry in a maritime country), and to the construction of buildings for the convenience of trade and manufactures. The amended tariff of 1842, which for many reasons is a most important change in the financial policy of this country, has reduced the duty on colonial timber to a rate perhaps unnecessarily low; that on foreign timber, though much reduced, is still too high.

One of the chief recommendations of indirect taxes is, that, when placed upon the proper description of articles, the payment of them by the consumer is optional. If charged upon what may be strictly called the necessaries of life, their payment becomes compulsory, and falls with unequal weight upon labour. Competition generally reduces a large proportion of the working classes to a state which allows them but little if anything beyond the necessaries; consequently a duty upon these, as it will have no effect in diminishing the competition of labour and in raising wages, must reduce the comforts and stint the subsistence of labouring men.

That class of articles commonly called luxuries, of which the consumption is optional, is a very fair subject of taxation. In principle there is no objection to such taxes: they do not interfere with industry or production, but are paid out of the incomes of the contributors, and paid willingly, and for the most part without undue pressure upon their means. But in laying on taxes upon particular articles of this description care must be taken to proportion the charge to the value of the article. Excessive duties fail in the very object they have in view, by rendering the revenue less productive than moderate duties; while the causes of their failure are injurious to the wealth of the country by discouraging consumption, and to its morals by offering an inducement to smuggling. It is only by experience that the precise point can be found at which the revenue is most productive, consistently with an unchecked consumption and an absence of smuggling; but it may be assumed as certain that whenever a tax adds very greatly to the price of an article of general consumption, it puts it out of the reach of many who are anxious to purchase it, and tempts smugglers, by the chance of a large profit, to evade the payment of the duty. On the contrary, when a duty is moderate, it adds so little

Vol. XXIV.—Q

to the price of an article, that it will scarcely affect its consumption; and the profit arising from evasion of the duty is so small as not to cover the risk and penalties of detection. In proof of these facts there has been ample experience in the taxation of this country, and a few instances may serve as instructive illustrations.

In 1823 the excise duties upon Scotch and Irish spirits were reduced from 5s. 6d. to 2s. per gallon, and the immediate effect produced upon the apparent consumption and upon the revenue will appear by the following statement for the two years preceding and following the reduction.

Quantities of spirits made in Ireland and Scotland which paid duty for home consumption, stating the rate of duty paid, and the net revenue:—

IRELAND.			
	Gallons.	Rate of Duty.	Net Revenue.
1821	2,649,170	5s. 6d. per Irish gallon	£912,238
1822	2,328,397		
1823	3,348,505	2s. per English Wine Gallon from 10th October	634,460
1824	6,690,315	Ditto	771,690
1825	9,262,744	Ditto	1,084,191
SCOTLAND.			
	Gallons.	Rate of Duty.	Net Revenue.
1821	2,229,435	5s. 6d. per English Wine Gallon	£727,650
1822	2,079,556	Ditto	691,136
1823	2,232,728	2s. from 10th October	536,654
1824	4,350,301	Ditto	520,624
1825	5,981,550	Ditto	682,848

In 1826 6d. was added to the duty, and again in 1830 a similar addition was made, the effect of which is shown by a continuation of the statement:—

IRELAND.			
	Gallons.	Rate of Duty.	Net Revenue.
1826	6,837,408	2s. 10d. per Imperial gallon	£964,509
1827	8,260,910		
1828	9,937,903		
1829	9,212,223		
1830	9,004,539	2s. 10d., 3s., & 3s. 4d.	1,409,128
1831	8,710,672	3s. 4d.	1,451,580
1832	8,657,756	Ditto	1,442,845
1833	8,168,596	Ditto	1,360,769
SCOTLAND.			
	Gallons.	Rate of Duty.	Net Revenue.
1826	3,988,788	2s. 10d. per Imperial gallon	£563,263
1827	4,752,199	Ditto	672,441
1828	5,716,180	Ditto	809,559
1829	5,777,280	Ditto	818,448
1830	6,007,631	2s. 10d., 3s., & 3s. 4d.	989,258
1831	5,700,689	3s. 4d.	950,041
1832	5,407,097	Ditto	901,182
1833	5,988,556	Ditto	998,051

These tables show the effects of taxation in encouraging or repressing smuggling, rather than its influence upon consumption. Taking the case of Ireland, it would be impossible to believe that the actual drinking of spirits could have been increased more than threefold in a few years, even if there had been no evidence of illicit distillation; but before the reduction of duty in 1823, an enormous amount of smuggling had been detected, and there were other means of estimating the extent of frauds practised upon the revenue. For instance, in 1811, the duty had been only 2s. 6d. a gallon, and in that year no less than 6,500,361 gallons had paid duty; while, in 1822, when the duty was 5s. 6d., only 2,328,397 gallons were brought to charge. The revenue commissioners, on whose recommendation the duty was reduced in 1823, then estimated the annual consumption of spirits in Ireland at ten millions of gallons, and the illicit supply at about seven millions. (*Fifth Report of Revenue Commissioners*, pp. 8, 19.)

In 1827 the duties on spirits made in England were reduced from 12s. 6d. to 7s. a gallon. The average consumption for three years to 1827 was 3,677,457 gallons, and the revenue 2,281,526*l.* In 1829 (only two years after

the reduction) the consumption was 7,700,766*g.*; the revenue 2,695,268*l.*, or 413,742*l.* more than duty had produced. (*Parnell's Financial Reform* p. 44.)

It has been a common opinion that spirits also treated merely as a source of revenue; but it is injurious to the morals of the people, the consumption should be repressed by heavy duties. It has long been the object of this and of other governments to limit the consumption of spirits, and at the same time to raise a large revenue from it. The object is not only a good one if it could be secured: but of numerous experiments has proved that taxation can be conducted with reference to the immediate obtaining a revenue in the best manner; and the interests of a country are promoted by following the principles of taxation, rather than by seeking to increase the revenue by a violation of those principles, to accomplish which, if attainable, can only be attained by other means. The signal failure of a measure in the last century, of encouraging the drinking of spirits, is a strong evidence of the futility of attempting to force a change in the habits of the people by a tax. In 1736 a tax of 20*s.* was imposed upon all spirits, with very heavy penalties for evasion of the duty. The tax was extremely unpopular, and was evaded to such an extent, that in two years less than 12,000 persons were convicted of offence against the law. Indeed the measure proved altogether and so impracticable, that it was abandoned after a few years of vexatious and unprofitable trial.

High duties upon foreign articles imported into a country are liable to all the objections which have been urged against applying to immoderate taxes upon consumption. They are chargeable with another,—they diminish the amount of commerce, and thereby restrict commercial intercourse and the demand for and exportation of domestic produce or manufactures.

The number of gallons of brandy and Geneva wine imported and retained for consumption, on an average of five years, to 1807, was 1,820,000. The duty was then 14*s.* and the revenue 1,370,000*l.* In 1814 the duty was 18*s.* 10*d.*, and on an average for the four succeeding years the number of gallons entered for home consumption was 742,000, and the revenue 825,000*l.* Thus a loss of 1,078,000 gallons a year was sustained by the revenue, the legitimate trade in brandy discouraged, and a rich premium offered to the smuggler. The present duty is 17*s.* 6*d.* a gallon, and in the year ended 5th January, 1842, only 1,180,500 gallons were entered for home consumption, the gross revenue which was 1,347,461*l.*, or 23,000*l.* less than in 1807, notwithstanding the great increase of wealth and population since that time. That French brandy is smuggled into this country in large quantities is notorious; and we may consider that the duty is estimated at 400 or 500 per cent on its original price abroad, the inducement to smuggle is so great, that we cannot be surprised if all the provisions of our customs establishment is rendered ineffectual, and the trade so regular and certain is the smuggling trade, which has made the subject of insurance, like other commodities, and it is even said at premiums of from 10 to 15 per cent which bear no proportion to the profits, if the measure should be successful.

The success of moderate duties upon articles of consumption, in encouraging the use of them, placed within the reach of a larger number of persons, at the same time augmenting the revenue, was never more shown than in the article of coffee. In 1824 the duty on British plantation coffee was 1*s.*, upon East India coffee and upon foreign coffee 2*s.* 6*d.* per lb. In 1825 the duties were reduced one-half, and the consequence has been a considerably more than a threefold increase in the consumption, while the revenue has been more than doubled. In the three years preceding the reduction, the consumption and revenue were as follows:—

	Quantities cleared for Consumption.	Net Revenue.
1822	7,669,351 lbs.	£387,342
1823	8,454,920	424,613
1824	8,262,943	420,988

In the three years following the reduction, the consumption greatly increased, but not sufficiently to increase the revenue:

	Quantities cleared for Consumption.	Net Revenue.
1826	13,203,323 lbs.	£336,570
1827	15,566,376	399,960
1828	17,127,633	440,245

the consumption has since been rapidly increasing, the last two years the consumption and revenue appear:—

	Quantities cleared for Consumption.	Net Revenue.
1840	28,708,033 lbs.	£921,550
1841	28,420,980	887,721

slight falling off in the last year may be accounted the general depression of trade, and perhaps in some also by the addition of 5 per cent. to the customs, which was then in operation.

1835 coffee, the produce of British possessions in was admitted at the same duty as plantation coffee, *l.* per lb., and the effect of the reduction, in encouragement the growth of the plant in India and the consumption of the berry in this country, has already been very and perhaps the coffee trade of the East may as yet be considered in its infancy. In 1834, the year before the year, 8,875,961 lbs. were imported from the East India Company's territories and Ceylon; and in 1840, 31 lbs., or nearly double. The new customs tariff is a further reduction of duty. That on foreign coffee is to be *8d.* a lb., and on coffee from the British possessions only *4d.* An increased consumption will doubtless be the effect of this measure, and the revenue will be improved.

reductions of existing duties are proved by these to increase the revenue; but whether the effect should be immediate or deferred must depend upon a variety of circumstances. If the reduction puts an end to smuggling, the revenue will derive immediate as both the demand and the supply of the article exist, and the reduced tax, without affecting production or consumption, acts as a police regulation, and protects the revenue from fraud. But where there is no smuggling, and the revenue can only be increased by means of additional consumption, the effect of reduced duties may be deferred and even remote. The revenue may be produced; capital, skill, labour, and land are required to provide it in sufficient quantities to meet the growing demands of the consumer; and even if the supply become abundant, the habits and tastes of the people cannot be changed on a sudden. The high price of an article may have placed it out of their reach, and they may have become attached to some substitute, or may be slow to spend their money on a commodity which they have learned to do without. and other causes may defer for a considerable time an increase of consumption as would make up for the rate of tax, especially when the reduction has been great as to require an extraordinary addition to the amount of consumption, before the sacrifice made to the revenue can be redeemed. But where the article which it is proposed to reduce a tax is already in unrequited demand, and the supply immediate and abundant, and the tax is so heavy as to restrain consumption, the loss need be apprehended from a remission of the tax, and a very speedy increase of revenue may be expected. Sugar is an article of this description. It is a necessary of life as well as a favourite commodity, there are scarcely any limits to the supply that can be raised, and the present duties add materially to the price and check consumption. As a proof of the success with which the consumption of foreign sugar has been expected to increase if the excessive duty were removed, we may refer to the effects of equalizing the duties on East and West India sugars in 1836. In that year the duty on East India sugar was reduced from 32s. *l.* to 24s. In 1835 the quantity imported had been 100 cwt.; and in 1837, one year only after the change, it had increased to 302,945 cwt.; in 1838, to 450 cwt.; and in 1839, to 587,142 cwt. As the tax was diminished only by one-fourth, and the consumption immediately more than doubled, the revenue at once increased considerably by the reduction of duty.

Every financial experiment will serve to show how much increased revenue can be depended upon as the result of an augmentation of taxes upon articles of consumption.

In 1840 an addition of 5 per cent. was made

to all the duties of customs and excise, and a proportionate increase of revenue was anticipated, but not realized. The net produce of the customs and excise in the year ending January 5th, 1840, amounted to 37,911,506*l.* The estimated produce for the year ending January 5th, 1842, was 39,807,081*l.*, 1,895,575*l.* being expected from the additional 5 per cent. The actual increase however was only 206,715*l.*, or little more than one-half per cent., instead of the 5 per cent. which had been expected. This result was undoubtedly in part caused by a general stagnation of trade, and by the consequent distress which prevailed in that year, but we notice it because the principle of an indiscriminate augmentation of existing taxes, without reference to their present amount, character, and circumstances, is very unwise. We have said that experience alone can show the precise rate of a particular tax which will not affect consumption and will at the same time discourage smuggling. It must be presumed that existing rates have been fixed in order to secure these results, and that they are justified by experience. To add to them therefore, not because they are insufficient for their immediate object, but because a general addition to the revenue is needed, is to neglect experience and to disturb the proper relations between the amount of tax and the value of particular articles. During the last century it was a common financial course to add a general per centage of increase upon all the customs duties whenever the revenue was found to be insufficient for immediate purposes. To this unwise policy must be attributed many of the strange anomalies which up to this time have existed in the British tariff. Any recurrence to so unscientific a mode of taxation should be avoided. The tax upon each article ought to be adjusted by itself upon sound principles, and then should not be changed merely to save the trouble or to avoid the unpopularity of selecting particular articles for increased taxation or of inventing new burthens.

Protective, Discriminating, and Prohibitory Duties.

The legitimate object of taxation is that of obtaining a revenue in the least injurious manner for the benefit of the community; but this object has constantly been overlooked for the sake of ends not fairly to be accomplished by taxation. It is natural for a legislature to endeavour by every means in its power to encourage agriculture, trade, and manufactures; and it would be culpable to neglect any proper means of encouragement, which are not only beneficial to particular interests, but add to the general prosperity. Unfortunately however the zeal of most legislatures upon this point has been misdirected. They have seized upon taxation as the instrument of protection and encouragement; and, using it as such, have injured the great mass of their own countrymen, and ultimately have failed in promoting the very interests they had intended to serve. All that we can hope in this and other European countries is a gradual adoption of sound principles, and the correction, at some distant period, of the mistakes which have been acted upon for centuries; but it is to be hoped that in the new countries of the world, where systems of revenue are not yet established, or are growing up with the progress of society, none of the errors of the Old World will be suffered to have a beginning. If once the system of protection has existed, severe injuries and even injustice are inflicted whenever an attempt is made to undo the mischief which has been done. Reason and experience unite in teaching the impolicy of protective taxes; and, in our own country, it is now so generally acknowledged, that nothing but the extreme difficulty of withdrawing the protection which has been given obstructs legislation upon sound principles.

The object of a protective duty is to raise artificially the price of the produce or manufactures of one country as compared with the produce or manufactures of another. A heavy tax easily effects this object, and thus prevents competition on the part of that country whose commodities are taxed, and establishes a monopoly in the supply of those commodities in favour of the parties for whose benefit the tax was imposed. The revenue, the avowed object of a tax, so far from being improved, is here actually sacrificed by the exclusion of merchandise, which at moderate duties would fill the coffers of the state. The state clearly is a loser; the foreigner, whose goods are denied a market, is a loser. Who then gains by these losses? Not the consumer; for the more abundant the supply, the better and

cheaper will he find the market; but the seller, who is enabled to obtain a high price for his wares because he has a monopoly in the sale of them, is the only party who gains. The community at large suffer doubly: first, by having to buy dear instead of cheap goods, or by being denied the use of them altogether; and secondly, by being obliged to pay other taxes which would not have been required, if the very articles which would have made their purchases cheaper had been charged with a moderate impost. Even the sellers, for whom all these sacrifices are made, do not derive the benefit which might be expected. In the goods which they sell themselves, indeed, they are gainers; but in purchasing of other monopolists they lose by an artificially high price, like the rest of the community. It constantly happens, too, that although the prices at which they sell are high, their profits are reduced, by the competition of others selling the same articles, to the general level of profits throughout the country. When this is the case, all parties, without exception, are losers—the state, the community, and the monopolists. The general injury done to trade by the protective system is too extensive a question to enter upon, but it is well illustrated in the ‘Report of the Committee of the House of Commons upon Import Duties’ in 1840.

Protection may be accomplished by actual prohibition of the import of particular articles, by exorbitant duties which amount to prohibition, or by such duties only as give the home producer an advantage. Duties may also discriminate between the produce of different countries, and give the preference to some, to the injury and exclusion of others.

In this country all these modes of protection have been resorted to. For the protection of agriculture, foreign cattle, sheep, swine, beef, mutton, pork, and other provisions have been entirely prohibited. High duties have been placed upon the importation of corn on a sliding-scale, so devised as to exclude it entirely, except in times of scarcity; and more moderate duties are payable upon various articles of agricultural produce. The prohibitions however have recently been removed, and moderate import duties substituted. The corn-laws, though the sliding-scale is still adhered to, have been considerably modified, and, it is hoped, will hereafter admit a larger amount of foreign grain, and enrich the revenue. The principle of a sliding-scale, we would here observe, apart from its general policy, is very injurious to the revenue. When the high part of the scale is in operation, it acts as a prohibition; and when the lower duties only are payable, they are comparatively unproductive. The loss sustained by the consumer on account of the protective duties on corn has been variously estimated at from 12,000,000*l.* to 50,000,000*l.* a year; and yet it is well known that money invested in the purchase of land produces a very low rate of interest, not exceeding 3 per cent., and that persons engaged in agriculture, for whom the protection is maintained, have been continually complaining to parliament of their distress.

Upon various articles of manufacture there have been prohibitory and highly protective duties. In 1825 the former were removed; and the latter have, in the present session of parliament (1842), been so modified as to be very fair taxes for the purposes of revenue.

Duties are called discriminating when they are not levied equally upon the produce or manufactures of different countries. The object of them is to give an advantage to the country on whose commodities the tax is lightest, as compared with others. To obtain such a preference has been the object of various negotiations and commercial treaties between different states, as it opens extensive markets to the industry of the favoured nation. By the present commercial policy of England, the principle of discrimination may be said to be confined to the protection of our colonies against the competition of foreign countries. As regards each other, all foreign countries enjoy equal commercial advantages in their intercourse with England. Our colonial policy is so wide a question, involving political and commercial considerations of high importance, that we can only touch upon it. It may be contended that colonies should form an integral part of the mother country, and that the commercial intercourse between the several parts of the British empire ought to be viewed as a vast coasting-trade. If this principle were acted upon, it would certainly present a grand fiscal union worthy of admiration; but the existing system does not

partake in any degree of the character of a trade. To put it upon such a footing, the colonial produce imported into the United Kingdom be little more than nominal, and we should reductive imposts upon foreign produce for our practice is the reverse of this. Where our crime, we derive our revenue from the produce; and we either exclude foreign produce, or limit its introduction so much as to prevent it tributing materially to the revenue. The duties upon the foreign produce, which would competition with the colonies, is not revenue, for the sake of creating a monopoly in the latter. This system we have already condemned when established for the protection of trade in the mother country; and upon fiscal grounds equally indefensible when applied to the colonies, quite as injurious to the community. There are articles of consumption, viz., sugar and tin, which the discriminating duties deserve especially. Sugar imported from the colonies pays a duty of 6*s.*; from foreign countries 6*s.* 6*d.* The duty is so great, that foreign sugar is comparatively excluded from the consumption of our people, who are entirely upon the colonies for the supply of that article. The population of the country has increased, and with it the demand for most articles of consumption. It is painful to see the supply of sugar forcibly restrained by our commercial policy. The consumption has not increased for ten years. 3,781,011 cwt. were retained for home consumption in 1840 only 3,594,832 cwt. So inadequate the colonies alone been to supply our wants, that they have actually been diminishing. In 1831 the West Indies exported to the United Kingdom 4,103,800 cwt.; the succeeding year has their export been so great, that in 1840 it had sunk so low as 2,217,764 cwt. In the period the consumption of coffee, cocoa, and tea, has considerably increased, and the people must be suffering a serious privation on account of the falling off of the supply of sugar. The community is plainly injured by the colonial monopoly; and the falling off of the supply of the West Indies, in spite of an increasing demand for their protection: meanwhile the revenue has been enriched by the exclusion of foreign sugar. If with moderate duties, might be imported at a price of 2*s.* 6*d.* in unlimited quantities.

The discriminating duties upon timber have been particularly injurious to this country, and it is extremely difficult to see whether they have conferred any benefit upon the colonies. They have acted as a bounty of 45 per cent. in favour of timber the growth of British possessions. The colonies have obliged the consumer either to pay a tax of 45 per cent. (not for purposes of revenue, but for the purpose of other interests), or to use an inferior article, which is less useful, and cheaper only by reason of the duties. The duties, if happily, about to take effect, in some measure, equalize the duties upon colonial timber. On the 10th October, 1842, the duty upon foreign timber will be reduced from 55*s.* to 30*s.*, and on the 10th October, 1843, to 25*s.* Colonial timber is, at the same time, to be reduced from 10*s.* to 1*s.* Eventually therefore the discrepancy will be only 24*s.* the load, instead of 45*s.*

Export Duties.

We have hitherto spoken of taxes upon such articles only as are consumed by the subjects of the country whose benefit they are imposed, and which are either produced within the country or imported into it. Duties levied upon goods exported to foreign countries are not equally paid by the foreign consumer, and the effect of making the subject of one state bear the burden of another. However desirable this may appear to the state, whose treasury is enriched at the expense of the foreigners, the expediency of such duties will depend upon peculiar circumstances, and great nicety is required in the regulation of them. If a country possesses a monopoly of some produce or manufacture much in request abroad, for the production of which it has peculiar advantages, a moderate export duty may be very desirable. In the manner Russia, which has almost a monopoly of tallow to the rest of Europe, derives a

able revenue from an export duty upon that article. Upon the same principle a duty upon machinery exported from Great Britain would have been politic. British machinists far excelled all others in skill and ingenuity, and foreign manufacturers were willing to pay almost any price for their machinery. Notwithstanding the prohibition, large quantities have been smuggled abroad at an enormous cost, but the difficulty and expense of evasion have been so great that foreigners have latterly almost confined their purchases, in this country, to models and drawings, and have made the machinery themselves, with the assistance of British artizans, whom they have enticed abroad by extravagant wages. (*Reports of Committees of the House of Commons on Artizans and Machinery, in 1824 and 1825, and On the Exportation of Machinery, 1841.*) If, instead of prohibiting the export, a duty of $7\frac{1}{2}$ or 10 per cent. *ad valorem* had been imposed, foreign manufacturers would have paid much less for the machinery purchased by them in England than they could have had it made for abroad; there would have been a large export trade from this country, and a considerable revenue. The partial relaxation of the prohibitory law in 1825, by granting licences to export certain kinds of machinery, has shown the extent to which the trade might have been carried under a more liberal policy. The official value of machinery exported under licence in 1840 was 593,064*l.*, in addition to various tools allowed by law to be exported, of which no account was taken. (*Sess. Paper, 1841, No. 201, p. 257.*)

On the same grounds a moderate duty on the export of coal, being a product peculiarly abundant and of good quality in this country, is a legitimate tax, which would be paid by the foreigner, and, if sufficiently moderate, would not be injurious to the coal trade.

But while moderate export duties upon articles of which a country has almost the exclusive supply may be advisable, heavy duties will check the demand abroad in the same manner as they have been shown to affect the consumption of commodities at home. In the same manner also they are injurious to trade and unprofitable to the revenue.

All duties whatever should be avoided upon the export of produce or manufactures which may be also sent from other countries to the same markets. They would discourage trade and offer a premium to foreign competition.

Although the temptation is great to shift taxes from one country to another by means of export duties, this temptation is equally great in all countries; and if their several governments should be actuated by the desire to make foreigners contribute to their revenue, their opportunities for carrying out such a system would probably be equal, and thus retaliations might be made upon each other, which, after all, would neutralize their efforts to tax foreigners, and leave them in the same position as if they had been contented to tax none but their own subjects. In this power of retaliation lies the antidote to the evil of one state being forced to bear the burthens of another as well as its own. Every state would naturally resist such an imposition upon its subjects, and export duties can therefore only be safely resorted to in such peculiar cases as we have noticed, where foreigners are willing to pay an increased price for commodities which they must have, and which they cannot obtain so good or so cheap from any other place.

[CUSTOMS; EXCISE; LAND TAX; POST-OFFICE; STAMPS; TAXES; TITHES; WAREHOUSING SYSTEM.]

TAXACEÆ, a natural order of plants belonging to the class Gymnospermæ:—This order possesses the following essential characters. The flowers are monœcious or diœcious, and are naked, or solitary surrounded by imbricated bracts, or in spikes surrounded by bracts. The male flowers have no calyx, and several stamens, mostly united at the base, with the anthers either combined or distinct. The female flowers are solitary and naked; the ovules are naked, with the foramen at the apex. The seeds are hard, and are sometimes surrounded by a succulent, coloured, cup-shaped pericarp: they possess fleshy albumen, and a straight dicotyledonous embryo. The plants of this order are trees or shrubs, having a woody tissue marked with circular disks, with evergreen and mostly narrow, rigid, entire, and veinless leaves.

This order is very characteristic of the class to which it belongs, in the absence of any regularly formed ovary, and the consequent exposed or naked state of the ovule

and seeds. In this respect it offers a lower state of organization than the Coniferæ, or Pine tribe, the ovules of which have a kind of protection in the hardened scale-like bracts which constitute the cones of that order. The foliage also of Taxaceæ differs from Coniferæ, in their possessing a greater tendency to expand and form veins within their tissue. In the few species of Taxaceæ that possess veins, they are not straight and parallel, as in Endogens, but are forked and of a uniform thickness, similar to those possessed by the higher forms of Cryptogamia, as the Ferns.

This order consists of plants that are but thinly distributed on the surface of the earth. They are mostly natives of temperate parts of Europe, Asia, Africa, and America. The order yields trees which are valued for their timber, and, like Coniferæ, possess resinous properties. The branches of the *Dacrydium taxifolium* are used in New Zealand for making spruce-beer. [TAXUS; SALISBURIA.]

TAXATIO ECCLESIASTICA, signifies the assessment and levy of taxes upon the property of the church and of the clergy. The pope once claimed in all countries the first year's whole profits and the tenth part of the whole annual profits of every ecclesiastical benefice. These were called 'First-Fruits and Tenths' [FIRST-FRUITS; TENTHS], and were, for the most part, paid willingly by the clergy to their ecclesiastical superior. The popes founded their claim upon scriptural precepts and practice. They referred to Abraham, a priest, paying tithes to Melchizedek, the high priest (*Gen.*, xiv. 20; and *Hebr.*, vii. 4); and to the Levites, in the Mosaic law, paying the second tithes, that is, the tithes of their tithes, to the priest: 'Thus shall you offer an heave-offering unto the Lord of all your tithes which ye receive of the children of Israel, and ye shall give thereof the Lord's heave-offering to Aaron the priest.' (*Numb.*, xviii. 28; Fuller's *Church History*, p. 226.)

The pope had his collectors in every diocese, who sometimes by bills of exchange, but generally in specie, yearly returned the tenths and first-fruits of the clergy to Rome.

But while the clergy were thus liable to taxation by their ecclesiastical head, it was maintained by the Roman Catholic church that their property enjoyed complete immunity against all claims of temporal powers, being set apart for the service of God, the support and dignity of the Christian church, and for works of charity. Upon this point frequent contests very naturally arose, and the vast possessions of the church tempted the pope and temporal princes by various modes to exact contributions from the clergy. The means resorted to by these respective powers to raise a revenue from the clergy, and the laws and customs that prevailed upon the matter, may be conveniently stated by dividing the subject into—

1. Taxation of the church or clergy by the pope for ecclesiastical purposes.

2. By temporal princes for the service of the state.

1. The pope was by no means satisfied with the regular contributions of the clergy, but continually applied to them for extraordinary funds for special purposes. In 1199 Pope Innocent III. issued a bull commanding the prelates and clergy of the Christian church to pay the 40th part of all their revenues to defray the expenses of a crusade. This is said to have been the first attempt to impose a tax on the clergy of all nations by the authority of the pope as head of the church. To enumerate only a small portion of the instances in which the pope afterwards exacted taxes from the clergy in the various countries of Europe would occupy much space; but a few examples from English history may be collected.

In 1225 the pope entertained a project by which the revenues of two prebends in every cathedral, and the portion of two monks in every monastery, in all the countries in communion with the church of Rome, were to have been granted to the pope for the better support of his dignity. When this project was laid before the parliament of England in 1226, they evaded a direct answer to the papal legate, by alleging 'that this affair concerned all Christendom; and that they would conform to the resolutions of other Christian countries.' (*Wilkin's Concilia*, vol. i., p. 620.)

Two years afterwards the king of England, Henry III., in order to induce the pope to interfere in a dispute concerning the appointment of an archbishop to the see of Canterbury, recently vacant by the death of Cardinal Lang-

ton, promised him a tenth of the moveables not only of the clergy, but of the laity. In this proceeding there appears to have been a twofold peculiarity. First, a temporal prince offered the pope a contribution from his clergy, which commonly originated with the pope; and secondly, a tax was to be levied upon the laity not for the service of the state, but for the benefit of a foreign ecclesiastic. The strangeness of the circumstances however did not prevent the pope from taking immediate advantage of the king's offer, and he accordingly sent a legate into England to collect the tenths. His demand met with some opposition, indeed, chiefly from the barons, but the pope and the king together were too powerful to be resisted. The legate, to shorten the work of collection, obliged the bishops to pay the tax for their inferior clergy; and when any of them complained that they had no ready money, he introduced them to certain Italian usurers whom he had brought with him for that purpose, who lent them the sums demanded at an exorbitant rate of interest. (Matthew Paris, p. 362.)

In the same reign the pope's legates were constantly demanding presents from the bishops, monasteries, and clergy, and convening assemblies of the church with no other object than to extort money. Their proceedings created such disgust that the great barons sent orders to the wardens of the seaports to stop all persons bringing any bulls or mandates from Rome, and at last succeeded in driving the legate himself out of the kingdom. (Matthew Paris, p. 659.) Little good however was effected by these measures, for we find that in 1216 the pope demanded the half of all the goods of the non-resident clergy and the third of those who resided. (Ibid., 708.) The resistance met with in this case deterred the pope from enforcing his demand; but the sums which he continued to draw from the clergy at that time appear to have been enormous, and the histories of that period are full of complaints and remonstrances against papal exactions. An act was passed by the parliament in 1307 (*Statute of Carlisle*, 35 Edward I.), to restrain, in some measure, the exactions of the see of Rome, but apparently with little good results; for seventy years afterwards we find the Commons in parliament still protesting against the extortions of the pope. In their remonstrance to the king upon that grievance they asserted, 'that the taxes paid to the pope yearly, out of England, amounted to five times as much as the taxes paid to the king.' (Cotton's *Abridgment*, p. 128.)

Although complaints continued long after this period, no measures were effectual in limiting the demands of the court of Rome until the pope's authority was altogether suppressed in England at the Reformation in the reign of Henry VIII.

2. The immunities claimed by the church were not effectual in protecting its revenues from being laid under contribution for the service of the state. The kings of England, sometimes by the pope's authority, sometimes by forced or voluntary compliance on the part of the church, and sometimes by their own direct power, obtained large sums from the clergy.

William the Conqueror found the church very wealthy, and subjected it to much spoliation. (Matthew Paris, p. 5.) A singular occasion for taxing the clergy arose in the reign of Henry I., A.D. 1129. An ecclesiastical council, assembled at London, denounced all married clergymen, and decreed that they should put away their wives. The council committed to the king the execution of their decrees, but he, instead of compelling the clergy to send away their wives, imposed a tax on those who chose to retain them, which is said to have been very productive.

The pope was not unwilling to assist in oppressing the clergy for the benefit of kings, when they were inclined to further his own objects, either by undertaking crusades, carrying on wars against his enemies, or making concessions to him. He could not suffer the immunities of the church to be infringed by the temporal power, but often placed at the disposal of princes the revenues of the church by his own authority. Thus the pope, by virtue of his apostolical power, granted King Henry III., by several bulls, the goods of all clergymen who died intestate, the revenues of all vacant benefices, and of all non-residents. In 1253 Pope Innocent XXII. gave the first-fruits and tenths of all ecclesiastical benefices to the king for three

years. This grant made a valuation or taxation of the benefices necessary, which was accordingly undertaken in the following year, and is sometimes called the 'Norwich Taxation,' and sometimes 'Pope Innocent's Valor.' The same prince, with the pope's concurrence, extorted large sums from the clergy in 1255 to carry on his wars with Sicily. Bills amounting on the whole to 150,540 marks were drawn upon all the bishops, abbots, and principal clergymen of the kingdom by Walleran, bishop of Hereford, who resided at Rome as an agent for the church of England: these bills were made over to Italian merchants, who, it was pretended, had already advanced the money for the Sicilian war. All resistance on the part of the church to these unjust demands of their own spiritual superior was unavailing, and after much remonstrance and opposition the money was paid. (Matthew Paris, pp. 615-619.)

In 1288 Pope Nicholas IV. granted the tenths to King Edward I. for six years, towards defraying the expenses of an expedition to the Holy Land; and in order to collect them at their full value, a taxation by the king's precept was begun in that year, and finished, as to the province of Canterbury, in 1291, and as to that of York in the following year, the whole being under the direction of the bishops of Winchester and Lincoln. This taxation is a most important record, because all the taxes of the church as well to the kings of England as to the pope, were afterwards regulated by it until the survey made by Henry VIII; and because the statutes of colleges which were founded before the Reformation are also interpreted by this criterion, according to which their benefices, under a certain value, are exempted from the restriction in the statute 21 Henry VIII. concerning pluralities. (*Preface to Taxatio Ecclesiastica*, P. Nich. IV., by the Record Commissioners.)

In 1295 Edward, notwithstanding the pope's grant, and numerous exactions from the clergy in the meantime, being still in great need of money to carry on his wars, summoned deputies from the inferior clergy for the first time to vote him supplies from their own body. In the preceding year he had, by threats and violence, exacted a tax of half the revenues of the clergy; but now he thought it prudent to obtain their consent to his demands in a more regular manner. The clergy however would not obey the king's writ of summons, lest they should appear to acknowledge the temporal power; and in order to overcome this objection, the king issued his writ to the archbishop, who, as their spiritual superior, summoned the clergy to meet in convocation. (Gilbert's *History of the Exchequer*, p. 51; *Hume*, vol. ii., pp. 278, 279.)

This was the commencement of the constitutional practice of the clergy meeting in Convocation at the same time as the Lay Parliament, and voting subsidies by its own voluntary act for the service of the state. It was not viewed without alarm by the pope and the high clerical dignitaries; and in order to put a stop to all such exactions of princes from the clergy, Pope Boniface VIII. issued a bull in 1296, which, after stating that temporal princes were in the habit of extorting heavy contributions from ecclesiastical persons, who, fearing to offend temporal power more than the eternal, had unwisely acquiesced in such extortions, proceeded to forbid churchmen of every degree to pay any tribute, subsidy, or gift to laymen, without authority from the see of Rome, and declared that if they should pay, or princes exact, or any one assist in levying such unauthorised taxes, all such persons respectively would incur the sentence of excommunication. (Rymer's *Fœdera*, vol. i., part 2, p. 836; Record Commissioners, ed. 1816.)

In the same year however Edward I. demanded of the clergy a fifth of their moveables, which they resisted, on the ground that they could not disobey the pope; but the king was not inclined to desist; and in order to force the acquiescence of the clergy, he put them out of the pale of the laws. Orders were issued to the judges to hear to cause brought before them by the clergy, but to decide all causes in which they were sued by others. The clergy were immediately exposed to violence and spoliation on all sides, in spite of a general sentence of excommunication pronounced by the archbishop against all persons who should attack the persons or property of ecclesiastics. The clergy could not long resist these oppressions; and although they were unwilling to disobey the Papal bull, they evaded it by voluntarily depositing a sum equivalent to the amount

demand of them in some church, whence it was taken by the king's officers. In this expedient the whole ecclesiastical body acquiesced, and thus yielded up their spiritual privileges, under coercion by the temporal power.

At the Reformation, the chief source of revenue to the pope, viz., first-fruits and tenths, was transferred to the king 'for more augmentation and maintenance of the royal state of his imperial crown and dignity of supreme head of the church of England.' (Stat. 26 Henry VIII., c. 3.) In order to collect this revenue a court of first-fruits was established, and the king ordered a valuation to be made of all the episcopal sees and benefices in England. The book which contains this valuation is called the 'Liber Regis,' and all the benefices which have not since been exempted still pay first-fruits and tenths according to this valuation. The first-fruits and tenths continued to form part of the royal revenue until Queen Anne, by the Act 2 & 3 of her reign, c. 11, gave up the proceeds thereof on part of herself and her successors, and assigned them ever to the augmentation of poor livings.

It now only remains to notice more particularly the practice of taxing the clergy in convocation, which continued full force till the reign of Charles II. It had afforded kings of England a lucrative revenue from the church. Their influence as heads of the church, and as having ecclesiastical preferments to bestow, was very great after the Reformation, and enabled them very commonly to obtain larger subsidies from the convocation than those that were voted by parliament. The church therefore was not unwilling to be deprived of the expensive privilege of voting separate subsidies; and acquiesced in an arrangement proposed in 1664-5, by which the Commons have ever since voted taxes upon the possessions of the church and of the clergy, in the same manner as upon the laity. As a boon for this submission of the church to temporal authority, two subsidies which the convocation had granted were remitted, and the parochial clergy were allowed to vote at elections. [GLASSGOW; CONVOCATION; TITHES.]

TAXES. The general objects, character, and principles of taxation, and of different classes of taxes, are treated of under the head of TAX, TAXATION. In this place it is proposed to give a short summary of the amount and description of taxes paid in this and some other countries, whether assessed directly upon property, or collected indirectly upon articles of consumption; including not only such taxes as are paid to the general government, but also all municipal and local assessments or contributions.

United Kingdom.

The chief sources of revenue are from indirect taxes, as will be seen by the following statement, made up to 5th January, 1842:—

	Gross Receipt. £	Rate per cent. at which collected. £ s. d.
Customs	23,821,486	5 6 4
Excise	15,477,674	6 7 8½
Stamps	7,494,239	2 3 4
Taxes (Assessed, &c.)	4,720,457	4 2 9
Post-Office	1,539,274	60 9 6½
Duties on Pensions and Salaries	5,752	1 17 6¼
Crown Lands	438,297	8 18 3½
Small branches of hereditary revenue	5,562	
Surplus fees of public offices	93,504	
Total ordinary revenues	53,596,250	6 13 8¼

To these parliamentary taxes may be added the following local assessments:—

Poor-rates	£6,351,828 (which includes county rates, 700,000 <i>l.</i>)
Church-rates	600,000 (in round numbers).
Highway-rates	1,312,812
Turnpike-tolls (England and Wales)	1,577,764
Grand-jury presentments (Ireland)	1,265,866

Total of local taxes. 11,108,270
(Parliamentary Papers, 1839 (562), 1841 (344) (421), 1842 (136) (235).)

These include all the local taxes of which any account can be given, but there are still many others, such as rates for paving, lighting, and watching particular cities and towns, and for other municipal purposes. It may also be added that the tithes of Great Britain and Ireland amount to 4,000,000*l.*

It is instructive to compare the present amount of taxes with that rendered necessary by a war expenditure. From 1805 to 1818 the payments into the British exchequer from taxes and loans in no one year amounted to less than 100,000,000*l.*, and in 1813 arose to the enormous and scarcely credible sum of 176,346,023*l.*

Denmark.

The total amount of all state and provincial or country commune taxes amounted in 1841 to 2,020,000*l.*, upon a population of 2,100,000.

Sweden.

The state taxes amount to	£753,404
Provincial	522,720
Municipal—Stockholm	28,035
All other towns	50,075
Total	£1,354,834

Kingdom of the Netherlands.

Total of government and provincial taxes £5,368,874

France.

Direct contributions for the state	£11,433,204
" " for the provinces	2,743,131
" " for the communes	337,018
Additional "	27,948
Total	£15,842,184

Indirect taxes for the state	£29,544,203
Miscellaneous items	453,738
Other sources of revenue	565,600
General total	£46,426,725

Saxony.

The state taxes are:—	
Direct	Prussian Dollars. 1,063,584
Indirect	1,709,610
Total	2,073,194 or £310,929

Wirttemberg.

State taxes	£534,445
Provincial and municipal	100,938
Total	£635,383

Baden.

State taxes:—	
Direct	£158,333
Indirect	344,000
Total	£502,333

Bavaria.

Direct state taxes	£511,407
Indirect	895,119
Which, with other sources of income, produce a revenue of	2,501,039

Sardinia.

State taxes:—	
Direct	£500,264
Indirect	1,090,000
Total	£1,590,264

Rome (Papal States).

State taxes:—	
Direct	£497,413
Indirect and Miscellaneous	1,261,989

Kingdom of Naples and Sicily.

Naples:—State taxes (exclusive of Sicily)	£3,994,957
Municipal taxes	155,267
Total	£4,150,224

Sicily:—Direct state taxes	£232,500
Indirect	630,639
Total	£862,865

Municipal taxes	£1,168,212
---------------------------	------------

Portugal.			
	£	s.	d.
Crown rents . . .	157,964	10	3
Direct taxes . . .	668,074	18	6
Indirect taxes . . .	1,070,780	4	9
Various rents . . .	434,046	7	3
Total . . .	£2,330,866	0	9

Further interesting particulars concerning the several taxes of European States will be found in the Parliamentary Paper, No. 227, of 1842, ordered by the House of Commons to be printed, 3rd May, 1842.

TAXODIUM, from *taxus*, the name of a genus of plants belonging to the natural order Coniferae. The plants of this genus are monœcious. The male flowers are arranged in catkins of a roundish form, disposed in racemose panicles; the pollen of each flower is contained in five cases, which are attached to the scale at its inner face. The female flowers are also arranged in small round catkins, two or three of which are attached near to the base of the spike of the catkins of male flowers. The ovules are two in each receptacle. The fruit is a globose strobule, with peltate angled scales; the seeds are angled with very thick integuments; the embryo, with from 5 to 9 cotyledons. The leaves are linear, disposed in two ranks, and are deciduous. This genus has been distinguished from Cupressus principally on account of the arrangement of its male catkins in racemose panicles, the small number of flowers in the female catkins, and the numbers of cotyledons possessed by the embryo.

This genus is well known through the *Taxodium distichum*, deciduous Cypress, a tree that was introduced into Europe from North America as early as 1640. This species is characterized by two-rowed, flat, deciduous leaves; leafless and panicle male flowers, and somewhat globose strobils. It is an elegant tree, and attains a height of 120 feet in its native soil. The first plant that is mentioned as existing in this country was grown in South Lambeth, and was raised from seeds brought from Virginia. Since then it has been introduced in various parts of Great Britain, and many fine specimens are now to be found. In its native districts in North America it is exceedingly abundant, and in many parts, as in Louisiana, it entirely occupies thousands of acres of the low grounds, which are thence called *cyprières*, or cypress swamps. It is found in Delaware, on the banks of the Indian River, in 38° 50' N. lat., which is its northern boundary, and, proceeding southward, it is abundant in the swamps of Virginia, the Carolinas, Georgia, and the Floridas.

In America, where the tree grows, its wood is used for all the purposes to which timber is applied. In 1819, according to Michaux, almost all the houses of New Orleans were constructed of the wood of this tree. It is considered very durable, and is employed where this quality is an object. In Louisiana it is used for making the masts and sides of vessels, and also canoes, which are fashioned out of a single trunk, and are said to be more durable than when made from any other wood. The bark of the tree exudes a resin of an agreeable odour and a red colour which is used by the negroes for dressing wounds, but it cannot be obtained in sufficient quantities to constitute an article of commerce. The roots of this tree are remarkable for the production of knobs or protuberances, which are sometimes five or six, and, according to some observers, many more feet in circumference. They have generally a conical form, and are hollow inside, with a covering of red bark, similar to that of the roots. In America, they are called 'cypress knees,' and are used by the negroes for bee-hives.

In the cultivation of the deciduous cypress, a rich moist soil must be selected in a low situation. It may be increased by seeds from the imported cones, or it may be propagated by cuttings, planted in autumn in a moist sand or heath soil, situated in a shady damp place. Layers also, when put down in moist soil, will root freely the first year.

During cultivation, this tree is exceedingly prone to sport, so that no two individuals have precisely the same appearance. On this account, a number of varieties have been named. The most common is the *T. d. nutans*, which has horizontal branches. Another, with pendulous branches, is known as *T. d. pendulum*; a third, with pendulous first-

year's shoots, as *T. d. nutans*. Other species of the genus have been described, but are not yet used or cultivated. For further information on this genus, see Loudon's 'Arb. et Frut. Brit.,' vol. iv.

TAXUS (*taxus*, Latin), the name of a genus of plants, the type of the natural order Taxaceæ. This genus is monœcious; the perianth of the barren flowers is single at the base; the stamens are numerous, with peltate anthers 6-8-celled, the cells opening beneath. The fertile flowers have a single, urceolate, scaly perianth: no style; and a fleshy drupaceous fruit, perforated at the extremity. The species of this genus are evergreen trees, with numerous, mostly linear, entire leaves. They are natives of Europe and North America.

T. baccata, Common Yew, has its leaves 2-ranked, crowded, linear, flat, with the flowers axillary, sessile; the receptacle of the barren flowers globular. The common yew is well known: it is indigenous to most parts of Europe, and is found in every part of Britain and Ireland. It is seldom seen growing in company with its own species, but alone, or with other species of plants.

The yew is a low tree, the trunk rising three or four feet from the ground, and then sending out numerous spreading branches, forming a head of dense foliage, which, when full grown, may be sometimes 30 or 40 feet high. It is of slow growth, attaining under favourable circumstances a height of 6 or 8 feet in ten years, and 15 feet in twenty years. The tallest yew in England is in churchyard at Harlington, near Hounslow, which is 100 feet high. A tree continues growing for about one hundred years; it mostly ceases to grow at that age, but live for many centuries. The yew-trees at present existing at Fountain's Abbey in Yorkshire are supposed to have attained their full growth when the abbey was erected in 1132.

The remarkable characters and properties of the yew have drawn towards it at all times much attention. Pliny, and Theophrastus mention its poisonous properties. Cæsar (*Bell. Gall.*, vi. 31) relates that Cæsar, king of the Eburones, committed suicide by swallowing the juice of the yew. Plutarch says that its fruit is poisonous, and that its shade is fatal to all who sleep under it. This is also stated by Pliny; but there must have been some mistake on some of these points, as it is now well known that the fruit of the yew may be eaten with impunity, and that its shade is not more deadly than that of cypress.

The yew appears to have been employed from the earliest times in the manufacture of bows, and was used for this purpose by the nations of antiquity. The bow used by the English previous to the introduction of gunpowder were made of yew, and there are many allusions amongst English poets to this use of its wood. The battles of Cressy and Poitiers were gained by the English yew-bows, and the same weapon was used in the wars of York and Lancaster. In the course of time the supply of yew was deficient, and other woods came to be used; but the introduction of gunpowder soon after put a stop to the use of the bow as a weapon of war altogether. Bows are now seldom made of the yew, various ornamental woods from South America being preferred. In Switzer-land the yew tree is called William's tree, because the bow of William Tell is said to have been made of that wood. The yew is a common ornament of the churchyard.

The origin of the practice of planting this tree in such situations is not at all clearly made out. Their dark foliage and supposed deadly shade may have pointed them out as the emblems of silence and death. Mr. Bowman (*Magaz. of Nat. Hist.*, vol. i.) observes that 'it seems most natural and most simple to believe, that being indisputably indigenous, and being, from its perennial verdure, its longevity, and the durability of its wood, at once an emblem and a specimen of immortality, its branches would be employed by our pagan ancestors, on their first arrival here, as the best substitute for the cypress to deck the graves of the dead, and for other sacred purposes.'

The yew used to be frequently planted in gardens as an ornament, on account of the facility with which it may be cut into various fantastic shapes. During the past century it was not uncommon to meet with these trees cut into the forms of balls, pyramids, beasts, birds, and men; but this practice having fallen under the well-merited censure of Pope and other writers, only a remnant of it here

seen at the present day. Although the fruit of is not poisonous, there are many well-authenticances of the leaves producing death. Deer and said to feed upon them with impunity, but to horses they prove an active poison. The yew been at any time used generally as a medicine, its effects on the system have been represented to those of digitalis, and as being more manageable less liable to accumulate in the system than iacine. Professor Wiborg of Copenhagen states leaves of the yew are only poisonous to animals y are eaten alone, but that if eaten with three or as the quantity of other food they are innocuous. are several remarkable specimens of old yews in this country. Those at Fountains Abbey are sheltered the monks whilst that magnificent erecting. The Tytherley, Fortingal, Arlington, 1-Lomond yews are remarkable for their size and any of them, if we estimate their age in the mode by De Candolle, must exceed considerably a years.

ood of the yew is used extensively in cabinet- It is very hard, compact, and of a fine close ich arises from the smallness of its annual layers, g sometimes found in a piece not more than 20 diameter. It is also much used by the turner g snuff-boxes, musical instruments, &c.

are several varieties of the common yew; the most le is the Irish yew, which Professor Lindley has istinct species, *Taxus fastigiata*. It is distin- by its upright mode of growth, and by its leaves g arranged in ranks, but scattered. It was first d at Florence Court, on the mountains of Fer- and has since been observed in other parts of

Other varieties are described, produced by dif- in cultivation, soil, &c. The Canada or North 1 yew is described as a species, *T. Canadensis*. es are narrower and smaller than those of the yew, and are revolute at the margin, and the wers are solitary in the axis of the leaves. It is e in Canada, and on the banks of a river

cultivation of the yew, a moist soil should always ed; but it thrives best on clays and loams, on d in shady places. It is best propagated by seeds, sown as soon as they are gathered in autumn, ed by the pulp of the fruit, will come up the next ing spring; but if dried, will not come up till the r. Where the object is to form a fence, cuttings employed. Before transplanting, whether they l from seeds or cuttings, the plants should be four feet high.

ther information concerning the yew, see Lou- voretum et Fruticetum Britannicum.)

River. [PERTHSHIRE.]

LOCH. [PERTHSHIRE.]

ETUS. [LACONIA.]

OR, ROWLAND, LL.D., was a clergyman emi- is learning and piety, who was burnt at the stake gn of Queen Mary. He is said by Bishop Heber been an ancestor of Jeremy Taylor. He was to Archbishop Cranmer, by whom he was ap- ector of Hadleigh, in Suffolk, where he went to

lor was summoned, in the year 1553, to appear 1 before Gardiner, bishop of Winchester, who was chancellor, for resisting the performance of mass h at Hadleigh. He was strongly persuaded to as refused, and presented himself before Gardiner, after a long conference, in which he defended with unshrinking firmness, he was committed to a Bench prison. There he remained till the 22nd 1555, when he and other prisoners were cited 1ner, and the bishops of London, Norwich, Salis- Durham, who were joint commissioners with the r. The chief offence of which Dr. Taylor was sed was his marriage; but he defended the right to marry with so much learning, that no sentence e was pronounced, though he was deprived of his

At the end of January the prisoners were again before the commissioners, by whom they were d to death. Dr. Taylor was committed to the Compter, where, on the 4th of February, he was . C., No. 1503.

visited by Bonner, bishop of London, who went there for the purpose of making him put on the dress of a Roman Catholic priest. Dr. Taylor resisted with his usual courage, and the dress was put upon him by force: he treated the whole proceeding with the utmost contempt, as a piece of mummery, and Bonner would have struck him with his crozier if he had not been restrained by his chaplain. On the following day the procession set forth which was to conduct him to the place of execution. In the course of the journey much persuasion was used by the sheriff and others to induce him to recant, but without making the smallest impression upon him. The procession passed through Hadleigh, where he was consoled and cheered by the blessings and prayers of his parishioners. The execution took place on the 8th of February, 1555, on Aldham Common, near Hadleigh. A stone, with the following inscription, perhaps still remains to mark the spot: - '1555. Dr. Taylor in defending that was gode at this plas left his blode.'

Bishop Heber, in his 'Life of Bishop Jeremy Taylor,' says, 'There is nothing indeed more beautiful in the whole beautiful Book of Martyrs than the account which Fox has given of Rowland Taylor, whether in the discharge of his duty as a parish priest or in the more arduous moments when he was called on to bear his cross in the cause of religion. His warmth of heart, his simplicity of manners, the total absence of the false stimulants of enthusiasm or pride, and the abundant overflow of better and holier feelings, are delineated, no less than his courage in death and the buoyant cheerfulness with which he encountered it, with a spirit only inferior to the eloquence and dignity of the "Phædon."'

(Fox's *Acts and Monuments*.)

TAYLOR JEREMY, was born at Cambridge in 1613, where he was baptized on the 15th August in that year. His ancestors had been wealthy and respectable, one of whom, Dr. Rowland Taylor, is mentioned in Fox's 'Book of Martyrs' as bringing upon himself the persecution of the popish party in the reign of Mary, not only by the popularity of his character and talents, but also his wealth. Taylor's father was a barber, a calling generally united in those days with surgery. At an early age Taylor was sent to Perse's grammar-school in Cambridge, and in his fourteenth year he was entered at Caius College as a sizar, an order of students which, Bishop Heber informs us, were then what the 'servitors' still continue to be in some colleges in Oxford, and what the 'lay brethren' are in the convents of the Romish church. At little more than twenty years of age, having taken the degree of master of arts, and been admitted to holy orders, he attracted the notice of Laud, then archbishop of Canterbury, before whom he was invited to preach at Lambeth. Laud appreciated his eloquence and his talents, which he encouraged in the most judicious manner by having him settled at Oxford, where he was admitted to the degree of master of arts, and by the powerful interposition of the archbishop, in 1636, nominated to a fellowship. Taylor does not appear to have remained long or uninterruptedly at Oxford. In 1637-8 he was presented by Juxon, bishop of London, to the rectory of Uppingham in Rutlandshire. About this time an acquaintance which, in common with Laud, he maintained with a learned Franciscan friar, Francis à Sancta Clara, exposed him to the suspicion of a concealed attachment to the Roman church—a suspicion to which the character of his mind, which tended to asceticism in religion, and to an extravagant veneration for antiquity, and which cherished a love of the gorgeous and imposing in the ceremonial of worship, gave some plausibility. At a later period in life however Taylor solemnly denied that there had ever been any solid ground for questioning the sincerity of his Protestantism.

In the civil wars he followed the fortunes of Charles, whose chaplain he was, and in 1642, when the king was at Oxford, he published there his 'Episcopacy asserted against the Acephali and Aerians New and Old,' in which he sought to maintain a cause that had then however, unfortunately, passed from the controversy of the pen to that of arms. Charles rewarded Taylor in the only way which it remained in his power to do, by commanding his admission to the degree of doctor of divinity. This honour was diminished by the indiscriminate manner in which it was conferred upon many other loyalists at the same time, so as to provoke an expression of dissatisfaction from the

heads of the University; and its advantages were overbalanced by the loss which Taylor encountered in the same year, in the sequestration of his rectory of Uppingham by the parliament. In 1647, when the crisis of the civil war impended, he published his discourse, 'The Liberty of Propheying.' After the defeat of the royalists Taylor was repeatedly imprisoned, but only for short periods. During the first years of the protectorate he supported himself by keeping a school, in Wales, in company with Nicholson, afterwards bishop of Gloucester, and Wyatt, afterwards prebendary of Lincoln, by his occasional writings, and by whatever contribution the friendship of the earl of Carbery, on whose estate he exercised his ministry, might afford to him. In the year 1658 he was encouraged by Lord Conway to settle in Ireland, where he divided his residence between Lisburn and Portmore, and he officiated in the ministry at both these places. The provision which he received was however so inadequate to his wants, that he was obliged to remain under obligations to his friend John Evelyn, who generously allowed him a yearly pension. In the obscurity of Portmore Taylor did not escape the unhappy persecutions of that period. He was charged by an informer with having used the sign of the cross in baptism, and dragged before the Irish privy council, from a distance and in the middle of a severe winter, to be examined. A fever was the consequence of his arrest, which probably induced the council to act leniently towards him.

In 1660 he travelled to London to prepare for publication his 'Ductor Dubitantium,' when he attached his signature to the declaration of the royalists, dated April 24th, in which they expressed the moderation of their views, and their confidence in the wisdom and justice of Monk. Taylor was thus favourably brought under the notice of Charles II., whose restoration took place this year, and to whom he dedicated the 'Ductor Dubitantium.' The king nominated him under the privy seal to the bishopric of Down and Connor, to which he was consecrated in January, 1661: in the following month he was made a member of the Irish privy council; and in the next, in addition to his original diocese, he was intrusted with the administration of the small adjacent one of Dromore, on account, in the words of the writ, 'of his virtue, his wisdom, and industry.' In the course of the same year he was elected vice-chancellor of the University of Dublin. Bishop Heber has deemed it necessary to account for Taylor's not having received an English bishopric. Besides his eminent abilities, and his faithful adherence to the cause of the church and the king, he had married the natural daughter of Charles I., who was his second wife, and then living. This last circumstance however, if pleaded with the king in favour of preferment for Taylor, as Bishop Heber thinks, may have contributed to determine the scene of his promotion: 'Charles may not have been unwilling to remove to a distance a person whose piety might have led him to reprove many parts of his conduct, and who would have a plausible pretence for speaking more freely than the rest of the dignified clergy.'

The new station which Taylor was called upon to fill had peculiar and great difficulties connected with it. In the revolution through which religion had passed, livings had been conferred on men whose feelings were at variance with episcopacy, and they had to be conciliated to a willing obedience, or, as time proved, to submit to the severest test of principle in the sacrifice of their emoluments. In Ireland there were additional circumstances to contend with. The Episcopal or Protestant church was unpopular; the preachers were almost exclusively English; the ritual was English, and to the mass of the natives unintelligible; there was no translation of the Scriptures, and yet attendance at the established churches was compulsory. Bishop Taylor laboured with much zeal and energy for the establishment of the Protestant religion; but with little effect. He was attacked by fever on the 3rd August, 1667, at Lisburn, and died in ten days, in the fifty-fifth year of his age, and the seventh of his episcopacy. The children of his first wife died before him; by his second, who survived him, he left three daughters.

The writings of Jeremy Taylor may be brought under four descriptions: practical, theological, casuistic, and devotional. The first comprises his 'Life of Christ,' which he published in 1653; 'Contemplations on the State of

Man,' a posthumous work; 'Holy Living and Holy Dying,' 1651; and his Sermons, which appeared at various periods. A work entitled 'Christian Consolations' has been referred to him, and published in the collection of his writings by Bishop Heber in 1820-2; but it has since been published in the name of Bishop Hallam, and appears to have been its true author. The series comprises his 'Episcopacy asserted against the Arians, Arians New and Old,' 1642; 'An Apology for Ancient and Set Forms of Liturgy,' 1644; his 'Discourse of Liberty of Propheying, with its just limits and showing the unreasonableness of prescribing to men's faith, and the iniquity of persecuting different opinions,' 1647; the 'Unum Necessarium: or the Doctrine and Practice of Repentance,' 1665; 'Deus Justus, or a Vindication of the Glory of the Divine Axiom in the question of Original Sin, against the Protestant way of understanding it,' 1656; 'The Real Presence of Christ in the Blessed Sacrament, against the Doctrine of Transubstantiation,' 1654; 'A Dissuasive from Popery,' 1664. The third includes his 'Discourse of the Nature, Offices, and Measures of Faith, with Rules of Conducting it,' 1657; and the 'Ductor Dubitantium, or Rule of Conscience in all Her general Cases,' 1660. The fourth comprises his 'Clerus, or a Discourse of the Divine Institution, Necessity, Credence, and Separation of the office Ministerial, with the Nature and Manner of its Power and Office,' 1651; 'The Golden Grove, or a Manual of Daily Prayers and Litanies, fitted to the Days of the Week,' 1654; 'The Psalter of David, with Titles or Collects, according to the Matter of each Psalm,' 1644; 'A Collection of several Forms of Prayer in cases ordinary and extraordinary taken out of the Scriptures, and the Ancient Liturgies of several Churches, especially the Greek,' 1658; 'Discourses for Various Occasions,' and 'The Worthy Communicant, or a Discourse of the Nature, Effects, and Duties consequent to the worthy receiving of the Lord's Supper, and of all the Duties required in order to a worthy preparation; together with the Cases of Conscience which are in the duty of him that ministers and of him that communicates,' 1660.

Mr. Hallam ranks the Sermons of Bishop Taylor above any that had preceded them in the Church of England. An imagination essentially poetical, and none of the decorations which by critical rules are almost peculiar to verse; a warm tone of piety, and charity; an accumulation of circumstantial stories whenever he reasons, or persuades, or describes; erudition pouring itself forth in quotation till his sermons become in some places almost a garland of flowers from other writers, and especially from those of classic antiquity, never before so redundantly scattered in the pulpit, distinguish Taylor from his contemporaries in degree, as they do from most of his successors by time. His sermons on the Marriage Ring, on the House of Sodom, on the Apples of Sodom, may be named with admiration to others, which perhaps ought to be in an equal place. But they are not without considerable faults, some of which have just been hinted. The eloquence of Taylor is great, but it is not eloquence of the highest; it is far too Asiatic, too much in the style of Chrysostom and other declaimers of the fourth century, by the imitation of whom he had probably vitiated his taste; his learning is ill-placed, and his arguments often much so; notwithstanding that he has the common defect of allegorizing his proofs; his vehemence loses its effect by the curbing of his pleonastic language; his sentences are of great length, and hence not only altogether unmusical, but always reducible to grammar. But he is still the ornament of the English pulpit up to the middle of the seventeenth century; and we have no reason to believe that he has rather much reason to disbelieve, that he has any rival in other languages. (Hallam's *Introduction to the Literature of Europe*, vol. iii., c. ii., p. 125-6.)

He has been accused of having copied a work of similar character by Ludolphus de Saxonia, a Catholic writer, in his 'Life of Christ'; but Bishop Hallam, who had examined both works, asserts that there is no resemblance between them, and none which entitles to the imputation of plagiarism.

'The Liberty of Propheying' (that is of interpreting the Scriptures) is the most popular in the second division of Taylor's

good sketch of it will be found in the third Hallam's 'Introduction to the Literature of more detailed one in the first volume of of Taylor's works. But the discourse itself will well repay the reading. It considers the admiration with which we are disposed to production of Taylor with the man, his times, when we take into account the motives vards assigned for its publication. 'In the ord Hatton of the collective edition of his ritings after the Restoration, he declares that ition did arise against the Church of Enged to make a reservation for his brethren pleading for a liberty to our consciences to at profession, which was warranted by all l and our superiors.' (Hallam, *Introduction ure of Europe*, vol. iii., p. 116.) Bishop cated Taylor from the charge of tergiversaot upon the above testimony which Taylor es, but upon the character of his proceedopacy was restored. If we must allow in s Sermon preached before the Irish Privy e obedience which he there insists upon is Heber suggests, that obedience to the laws l superiors which is paid by the members own communion; and that it is in fact no privilege (which every Christian society exert for its own preservation) to have the nistry supplied by such men as conform to imposed by the body at large on those to s are delegated; we ought to add that this t in much ambiguity; that principles are a much more general signification than a allows; and, in one word, upon ninety- undred readers the sermon before the Irish would produce impressions totally inconose derived from the 'Discourse on the hesying.' After expressing his sorrow at d mischiefs which come from rebellion and d his hopes of better things, the bishop of or proceeds in his sermon before the Privy hat he sees no objection 'against his hopes ight least of all in this case to be pretended: nsience against obedience, expressly against ne teaching us to obey for conscience sake; or conscience in a thing indifferent is never the books of our religion. It is very hard e is forced to say to his rebellious subjects, s stubborn people, 'Quid faciam tibi?' 'I e ways I can to bring thee home, and what into thee?' The subject should rather say, icere?' 'What wilt thou have me to do?' s the best end of disputations. 'Corrum- solvitur imperantis officium, si quis ad id sus est, non obsequio debito, sed consilio . respondeat,' said one in A. Gellius: When manded to obey, and he disputes, and says, other is better,' he is like a servant that necessary counsel when he requires of him dience. 'Utilius parere edicto quam efferre e had better obey than give counsel;' by better to be profitable than to be witty, to ess rather than full of talk and argument.' he same sermon, he distinguishes between ence,' which is such in reference to age or f 'new beginners,' and that which is the a boil; that is soreness indeed, rather than f the diseased, the abused, and the misper- first is to be dealt tenderly with. 'But for : of conscience which is the disease and nsience, it must be cured by anodynes and less they prove ineffective, and that the necessary.'

fers to the 'Ductor Dubitantium' as the most learned work on casuistry which has ap- English language. 'As its title shows, it five morality, or the guidance of the con- his cannot be much discussed without esta- principles of objective right and wrong, by which the conscience is to be ruled. asure and rule of conscience," according to law of God, or God's will signified to us by lation; and by the several manners and

times and parts of its communication it hath obtained se- veral names: the law of nature, the consent of nations, right reason, the Decalogue, the sermon of Christ, the canons of the apostles, the laws ecclesiastical and civil of princes and governors, expressed by proverbs and other instances and manners of public honesty. . . . These being the full measures of right and wrong, of lawful and unlawful, will be the rule of conscience and the subject of the present book." The heterogeneous combination of things so different in nature and authority, as if they were all expressions of the law of God, does not augur well for the distinctness of Taylor's moral philosophy, and would be disadvantageously compared with the Ecclesiastical Polity of Hooker. Nor are we deceived in the anticipations we might draw. With many of Taylor's excellencies, his vast fertility, and his frequent acuteness, the "Ductor Dubitantium" exhibits his characteristic defects: the waste of quotations is even greater than in his other writings, and his own exuberance of mind degenerates into an intolerable prolixity. His solution of moral difficulties is often unsatisfactory; after an accumulation of argument and authorities we have the disappointment to perceive that the knot is neither untied nor cut; there seems a want of close investigation of principles, a frequent confusion and obscurity, which Taylor's two chief faults, excessive display of erudition and redundancy of language, conspire to produce. . . . Taylor seems inclined to side with those who resolve all right and wrong into the positive will of God. The law of nature he defines to be "the universal law of the world or of mankind, to which we are inclined by nature, invited by consent, prompted by reason, but which is bound upon us only by the command of God." Though in the strict meaning of the word law, this may be truly said, it was surely required, considering the large sense which that word has obtained as coincident with moral right, that a fuller explanation should be given than Taylor has even intimated, lest the goodness of the Deity should seem something arbitrary and precarious. And, though in maintaining against most of the scholastic metaphysicians that God can dispense with the precepts of the Decalogue, he may be substantially right, yet his reasons seem by no means the clearest and most satisfactory that might be assigned. It may be added, that in his prolix rules concerning what he calls a probable conscience, he comes very near to the much-decried theories of the Jesuits. There was indeed a vein of subtlety in Taylor's understanding which was not always without influence on his candour.' (*Introduction to the Literature of Europe*, chap. iv., vol. iv.)

Bishop Heber has also remarked on some of Taylor's positions to the same effect; instancing his admission that private evil may be done by public men and for the public necessity; his justification on moral grounds of the supposed fraud of the children of Israel in borrowing jewels of the Egyptians without any intention of restoring them. 'In the first chapter of the third book, which treats of human laws and their obligations, a case occurs in illustration of Rule iv., that "a law founded on a false presumption does not bind the conscience," in which the Romish canonists seem to have given a more just decision than Taylor: Biretti, a Venetian gentleman, pretends a desire to marry Julia Medici, the daughter of a neighbour, with a purpose to seduce and desert her. A contract is made; but before its execution he gains his end, and leaving her, marries another. The canonists declare the former contract, followed by congress, to be a marriage, and that he is bound to return to Julia. "No," says Taylor, "if he did not lie with her, 'affectu maritali';" he was extremely impious and unjust; but he made no marriage; for without mutual consent marriages are not made." To these illustrations, adduced by Heber, may be added another, referred to elsewhere: Rule xi., 484, he maintains the right of using arguments and authorities in controversy which we do not believe to be valid; a rule of which he appears to have taken advantage; for, 'in the *Defence of Episcopacy*, published in 1642, he maintains the authenticity of the first fifty of the apostolic canons, all of which, in the "Liberty of Propheying," a very few years afterwards, he indiscriminately rejects.' (Hallam.)

On devotional subjects the character of Taylor's mind fitted him to write with most success. In these we find his most glowing language, his aptest illustrations; and

'whether he describes the duties, or dangers, or hopes of man, or the mercy, power, and justice of the Most High : whether he exhorts or instructs his brethren, or offers up his supplications in their behalf to the common Father of all, his conceptions and his expressions belong to the loftiest and most sacred description of poetry, of which they only want what they cannot be said to need, the name and the metrical arrangement.' (Heber, *Life and Works of Jeremy Taylor*, 15 vols., 1820-22.)

TAYLOR, JOHN, best known by the title, which he seems to have given to himself, of *The Water-Poet* ('The King's Majesty's Water-Poet'), was born in the city of Gloucester in the year 1580. His education was limited, for he himself informs us that he was 'gravelled' in his 'Accidence,' and could get no farther. He came to London, and was bound apprentice to a waterman, an occupation from which he derived his title of 'Water-Poet,' and which afforded him the means of subsistence during a great part of his life. He had however for fifteen or sixteen years some situation in the Tower of London; and he afterwards kept a public-house in Phoenix-Alley, Long Acre. Being an enthusiastic royalist, when Charles I. was beheaded he hung up the sign of the Mourning Crown, which however he was compelled to take down, and he then supplied its place by a portrait of himself, with the following couplet under it:—

'There's many a king's head hang'd up for a sign,
And many a saint's head too: then why not mine?'

Taylor was not satisfied with the distinction which his literary productions procured for him: he was fond of fixing public attention by other extraordinary performances. He once undertook to sail from London to Rochester in a boat made of paper, but the water found its way into his boat before he reached his destination, and he had some difficulty to get safe ashore. A journey which he performed by land is described in one of his tracts, entitled 'The Pennyless Pilgrimage, or the Moneyless Perambulation of John Taylor, alias the King's Majesty's Water-Poet; how he travelled on foot from London to Edinburgh in Scotland, not carrying any money to or fro, neither begging, borrowing, or asking meat, drink, or lodging.' He left 'the Bell Inn that's extra Aldersgate' on the 14th of July, 1618. A full account of this journey, abstracted from Taylor's pamphlet, is given in the 'Penny Magazine,' Nos. 622 and 623. He was attended by a servant with a horse, and they had a small stock of provisions and provender, which more than once relieved them when the occasional inhospitality which they met with had reduced them to the extremity of hunger. His course was through St. Albans, Stony Stratford, Coventry, Lichfield, Newcastle-under-Lyne, Manchester, Preston, Lancaster, Penrith, Carlisle, Edinburgh, Dunfermline, Stirling, Perth; and being then in the Highlands, he had an opportunity of seeing, at 'the Brae o' Mar,' one of those great deer-hunts which were then frequent in that part of Scotland, and of which he gives in his pamphlet an entertaining and picturesque description. The whole journey till his return to London occupied about three months. But a sort of voyage which he afterwards performed was apparently not less difficult. He published, as usual, an account of it himself, 'John Taylor's last Voyage and Adventure, performed from the 20th of July last, 1641, to the 10th of September following; in which time he passed with a sculler's boat from the citie of London to the cities and townes of Oxford, Gloucester, Shrewsbury, Bristol, Bathe, Monmouth, and Hereford.' From this title it might be supposed that he went all the way by water, a feat which, seeing the courses of the rivers, and the want of canals in those days, was an obvious impossibility; but the fact is, that when a river ceased to be navigable, or ran in a wrong direction, he shipped his boat and himself in a wain or waggon, and voyaged overland till he came to another river which suited his purpose: still a great part of the voyage was performed by water, and thus, to use his own words, 'in lesse than twenty days' labour, 120 miles were passed to and fro, in most hard, difficult, and many dangerous passages.'

Taylor died in 1654, in his 75th year, and was buried in the church-yard of Covent-Garden, London.

His publications, which amount to upwards of eighty, are some in prose, some in verse, and many both in prose and verse. As literary productions they are of little or no value, the verse mere doggrel, and the prose such as might

be expected from a writer not without obscure no great power of mind, and almost entire! Still they are by no means without their val of them being short occasional production the circumstances in which he was place many curious descriptions, as well as intere of the opinions and manners and general s of the times in which he lived. Sir Egert his 'Censura Litteraria,' has given a full l writings, and a tolerably copious one is also ; 'Bibliotheca Britannica.'

(Baker's *Biographia Dramatica*, by Reed which work he has obtained a place in c having written a pageant, 'Triumphs of F nour,' 4to., 1634.)

TAYLOR, SILAS, otherwise called Domville, by Antony Wood, was the son of Sy one of the commissioners during the civil ing those of the clergy called 'scandalous a ministers.' Silas Taylor was born at Harle Wenlock, in Shropshire, July 16, 1624, an educated at Shrewsbury and Westminster s a commoner of New Inn Hall at Oxford in taken thence by his father to join the parlia in which he had a captain's commission. he was appointed by the interest of his fath of the royalists in Herefordshire, in disch office he conducted himself with so much to conciliate the king's party. Part of the l at Hereford fell to his own share in the gene and he acquired considerable wealth, all of compelled to restore at the Restoration.

On that event he was treated by the royal lenity, and appointed commissary of annu Dunkirk, and about 1665 made keeper of th and storehouses for shipping at Harwich. vember 4, 1678, and was buried at Harwiel much interested in the antiquities of his coi enabled in the confusion of the civil wars i libraries of Hereford and Worcester cathedr course of these researches is said to have original charter in which King Edgar asser the sovereignty of the seas, which is print 'Mare Clausum,' lib. ii. He left material of Herefordshire, which afterwards came i of Sir Edward Harley of Brampton Brian i To this collection belong Nos. 4046, 417, 6856, and 6868 of the Harleian MSS., cont a general history with notes and special information under the several parishes. 'Domesday,' Leland, &c. From these pa liam Brome, a subsequent collector for the is said to have borrowed largely. Gough *Topographical Works*, 'Herefordshire.' MSS. is a paper of Taylor's on the mal (Ayscough's *Catalogue*, 'Taylor.'

His published works are, 'The History o with some observations and remarks upon occurrences of British and English histor added a short history of William the Con in Latin by an anonymous author in the tim London, 1663, 4to.

A History of Harwich was published from Samuel Dale, in 1730, and another editio with another title-page, London, 1732.

Wood *Athen. Oxon.* states, that Taylo pamphlets before the Restoration, but with that he was a good classical scholar and n and possessed of much general information an excellent musician, and that he con anthems, and edited 'Court Ayres,' &c., 1653 by John Playford.

TAYLOR, BROOK: TAYLOR'S TH referring all matters connected with algebr ment to TAYLOR'S THEOREM, we were jar the idea that so little was known of the coverer of that theorem, that the additional by our plan would not appear more than celebrity of the subject. We find ourselves much deceived in two points, since both Taylor himself, and that of his theorem, a can be, recovered from the neglect into wh fallen, at least in this country.

Nothing is said of Brook Taylor in the 'Biographia itannica,' or Martin's 'Biographia Philosophica,' and utton, &c., give nothing but the date of his birth and h. entrance into college and the Royal Society. The

'aphie Universelle' was the first work which gave y detail of his life, and this is due to the following circumstance:—In 1790, some members of the French Academy, struck with the scantiness of the existing information relative to so celebrated a man, requested Mr. William ward to make some inquiry on the subject in England. his gentleman applied to Sir William Young, Brook aylor's grandson, who accordingly drew up an account* his ancestor from family materials, and printed and culated it privately. It is from this work that the following account is taken, as to the facts of his private life:—

Brook Taylor was born at Edmonton, August 18, 1685, and was the son of John Taylor, of Bifrons House in Kent, r Olivia, daughter of Sir Nicholas Tempest, of Durham, aronet. John Taylor was the son of Nathaniel, who, to e a phrase of his own† diary, 'tugged and wrestled with e Lord in prayer, and was member (elected by Cromell's summons) for the county of Bedford in the (Bareones) parliament of 1653. Brook Taylor's father was

most despotic of parents: his son was educated at u , where, besides enough of the usual learning to uie him to begin residence at St. John's, Cambridge, 1701, he became excellent both in music and painting.

his numerous family were generally proficient in music, t the domestic hero of the art was the subject of this

ir. In a large family picture he is represented, at e age of thirteen, sitting in the centre of his brothers nd sisters, the two elder of whom crown him with laurel earing the insignia of harmony.' The paintings of the uture writer on perspective are represented as not needing he allowance always made for amateurs, but as capable f bearing the closest scrutiny of artists. At Cambridge

applied himself to mathematics, and acquired early the notice of Keil, Machin, and others. His first writing was on the centre of oscillation, in 1708, as appears by a letter to Keil (afterwards given in *Phil. Trans.*, 1713, No. 337). In 1709 he took the degree of LL.B., in 1714 that of LL.D.: in 1712 he was elected to the Royal Society. As yet he had published nothing: his letters to Machin (preserved in his family), from 1709 to 1712, treat of various subjects; and, in particular, contain a solution of Kepler's problem. We may conveniently put together a complete list of his works.

1. *the Philosophical Transactions*, 1712 (No. 336), On the ascent of water between two glass planes; 1713 (No. 337), On the centre of oscillation; also on the motion of a vibrating string: in the same year, a paper on Music, not printed. 1713 (No. 344), Account of experiment made with Hawksbee on the law of attraction of the

1717 (No. 352), Method of Approximation to roots of equations; (No. 353) Appendix to Monton on infinite series; (No. 354) Solution of a problem proposed by Leibnitz. 1719 (No. 360), Reply to the accusation of John Bernoulli. 1721 (No. 367), Propositions on the parabolic motion of projectiles; (No. 368) Experiments on magnetism. 1723 (No. 376), On the expansion of the thermometer. Besides these, the separate publications are:—

1. *Methodus incrementorum directa et inversa*. London, 1715.

2. *Linear perspective, or a new method of representing justly all manner of objects as they appear to the eye in all situations*. London, 1719.

3. *New principles of Linear perspective, or the art of representing on a plane the representations of all sorts of objects in a more general and simple method than has been done before*. London. A different work from the former: its second edition (called the third, by an obvious mistake) bears 'revised and corrected by John Colson, in 1749.' Joshua Kirby's well-known work, though

4. Brook Taylor's perspective, is not an edition of Taylor, but a new work founded on his methods.

* Not published. *Contemplatio Philosophica*, a posthumous work of the late Brook Taylor, LL.D., F.R.S., some time secretary of the Royal Society. To which is prefixed a Life of the author, by his grandson, Sir William Young, Bart., F.R.S., A.S.S., with an appendix, containing sundry original papers, &c. London, printed by W. Bulmer and Co., Shakespeare Printing-office, 1793. The account given by Prony in the 'Biographie Universelle' (1826) is, we are almost sure, one drawn up at the time from Sir W. Young's manuscript account forwarded to Paris; with parenthetical sentences inserted just before publication.

† His grandson's baptismal name was probably in memory of the noted politician, Lord Brook.

In January, 1714, he was chosen secretary of the Royal Society. In 1716 he visited his friends Montmort and Conti at Paris. He had just had a warm correspondence with the former on the Newtonian doctrine, and on the tenets of Malebranche.* His posthumous work, or rather tract, the '*Contemplatio Philosophica*,' seems to contain his latest thoughts on the opinions of Malebranche and Leibnitz. In France he formed the acquaintance of Bishop Bossuet and Lord and Lady Bolingbroke, with all of whom Sir W. Young has printed some of the correspondence. He returned to England in February, 1717; but his health was now impaired, and, throwing up the secretaryship in October, 1718, he retired to Aix-la-Chapelle. On returning to England early in 1719, he seems to have abandoned the mathematics almost entirely: among his papers of this period are essays on Jewish Sacrifices, and on the lawfulness of eating blood. At the end of 1720 he went to visit Lord Bolingbroke at La Source, near Orleans, and returned to England in 1721. After the middle of this year he wrote nothing for publication, nor could his grandson find anything of a mathematical character among his papers, with the exception of reference to a treatise on logarithms, which it seems he had placed in the hands of his friend Lord Paisley (afterwards Abercorn) to prepare for the press, but which was never printed.

At the end of 1721 he married a young lady of small fortune, a circumstance which occasioned a rupture with his father. Some months after his marriage, and when there appeared hope of issue, his wife was informed that the birth of a son would probably accomplish a reconciliation between her husband and his father. On this she fixed her mind with such earnestness, that on finding herself in due time actually delivered of a son, she 'literally died of joy:' the infant also perished. This melancholy event led to the reconciliation the hope of which had caused it, but not till the autumn of 1723. Dr. Taylor returned to his father's house, and in 1725, with his father's consent, married the daughter of a neighbouring proprietor. In 1729 he succeeded to the family estate by the death of his father, and in the following year his wife died in giving birth to a daughter, afterwards the mother of the writer of the memoir from which we cite. This blow was fatal; Lord Bolingbroke, now settled again in England, endeavoured to divert the thoughts of his friend by inducing him to pass some time in his house, but in about a year after the stroke, Dr. Taylor died of decline (in London, we suppose), December 29, 1731, and was buried in the churchyard of Saint Anne's, Soho. The family estate of Bifrons is still in the possession of the descendants of his brother Herbert.

We shall dismiss other points with brief notice, and as well known, in order to come to the history of the theorem: such are the celebrity of Taylor's solution of the problem of vibrating chords, the questions he proposed to the foreign mathematicians in the war of problems, his answer to those of Leibnitz, the accusation of plagiarism made against him by John Bernoulli, and his reply. With reference to the celebrated works on perspective, the first was mathematical, the second intended for artists who hardly knew anything of geometry. Bernoulli charged Taylor with having taken his method from another, and Prony states that it is in fact the one given by Guido Ubaldi, though he thinks Taylor could not have seen that method. The work referred to is '*Guidi Ubaldi Perspectivæ Libri Sex*,' Pisauri, 1600, at which we have looked in consequence. Nothing is more easy than assertion about old books: if Prony had really looked attentively at the works of Ubaldi and of Taylor together, he would have seen that whereas the former† only introduced the use of vanishing points as to lines which are horizontal (the picture being vertical), Taylor introduced the method of vanishing points for all lines whatsoever, and made them of universal application. We cannot think that he had never seen Ubaldi's work: a man of learning, an artist from early youth, was not likely to be ignorant of so celebrated a production. He must have seen, and generalized, the method given by Ubaldi. If indeed any one between the two is asserted to have a claim, that claim, when proposed, must be discussed: but a general charge of plagiarism from John Bernoulli is literally no more than a record of the fact that

* Fontenelle, in his *Eloge* of Malebranche, says that the '*Recherche de la Vérité*' was translated into English by a relative of Taylor of the same name. † The very title page of Ubaldi's work announces by a diagram that its distinctive feature is the use of vanishing points all at the height of the eye.

the party accused and John Bernoulli had had a quarrel, while what relates to Ubaldi is only so far true in that Ubaldi used the particular and Taylor the general method. It is not credible that Ubaldi was ignorant of the general proposition, or if he were so, Stevinus (whose *Sciographia* was published in 1608) was not;* but Stevinus did not use any vanishing points, except those of lines parallel to the ground, nor Ubaldi neither: while Taylor did use them, which is the distinctive feature of his system. Again, it is a strong presumption in favour of Taylor's originality in this point, that works published abroad shortly after his time do not contain it. For example, the 'Kurzgefasste Einleitung zur Perspectiv, von J. C. Bischoff, 1741,' a quarter of a century after the time of Taylor's publication, contains no use of vanishing points except at the height of the eye.

The *Methodus Incrementorum* is the first treatise in which what is at this day called the calculus of finite differences is proposed for consideration. Besides what are now the most common theorems in this subject, there are various purely fluxional or infinitesimal theories, such as the change of the independent variable, integrations, J. Bernoulli's series, &c., and various applications to interpolation, the vibrating chord, the catenary, dome, &c., centre of oscillation and percussion, law of density of the atmosphere, refraction of light. The first enunciation of the celebrated theorem is as follows:—

PROP. VII. THEOR. III.

Sint x et z quantitates duæ variables, quarum x uniformiter augetur per data incrementa z , et sit $nz = v$, $v - z = v$, $v - z = v$, et sic porro. Tum dico quod quo tempore x crescendo fit $x+r$, x item crescendo fiet

$$x + x \frac{v}{1z} + x \frac{r \cdot v}{1.2z^2} + x \frac{r \cdot v \cdot v}{1.2.3z^3} + \&c.$$

Corollary I. expresses the corresponding theorem for decrements.

COROLL. II.

Si pro Incrementis evanescentibus scribantur fluxiones ipsas proportionales, factis jam omnibus v , v , v , v , v , &c. æqualibus quo tempore x uniformiter fluendo fit $x+v$ fiet x ,

$$x + x \frac{v}{1z} + x \frac{v^2}{1.2z^2} + x \frac{v^3}{1.2.3z^3} + \&c.$$

vel mutato signo ipsius v , quo tempore x decrescendo fiet $x-v$, x decrescendo fiet

$$x - x \frac{v}{1z} + x \frac{v^2}{1.2z^2} - x \frac{v^3}{1.2.3z^3} + \&c.$$

Taylor does not make much use of his own theorem in the *Methodus Incrementorum*, but he shows his command over it in the paper above cited on the roots of equations, in which he extends Newton's method to other than algebraical equations.

One would have supposed that such a theorem as that of Taylor, the instant it was proposed, would have been hailed as the best and most useful of generalizations. Instead of this, it sunk, or rather never rose, till Lagrange pointed out its power. This is perhaps an assertion which some may doubt: we proceed to make it good. The first criticism upon the whole work (without a word about the theorem) was that of Leibnitz, in a letter to John Bernoulli (June, 1716, vol. ii., p. 380, of their correspondence), and it will show of what sort of view the neglect of this theorem was the consequence. The translation is as follows:—'I have received what Taylor calls his Method of Increments. It is an application of the differential and integral calculus to numbers, or rather to general magnitude. Thus the English have placed the horses, according to the proverb, behind the cart. I began the differential calculus from series of numbers . . . and so came naturally from the general calculus to the special geometrical or infinitesimal calculus. They proceed the other way, because they have not the true method of investigation. . . . It is written obscurely enough.' Bernoulli an-

swers (August, 1716, p. 389):—'I have at length received Taylor's book. What, in the name of God, does the man mean by the darkness in which he involves the clearest things! No doubt to conceal his habit of thieving: as far as I can make it out, I see nothing but what he has stolen from me, through his thick cloud of obscurity.' The notion of Leibnitz prevailed for a long time, and is not quite extinct in our own day, though rapidly expiring: the Differential Calculus was to be used only as the medium in which pure algebra was to be applied to geometry and physics, and even a generalization of existing theorems, expressed in the language of that Calculus, was a positively erroneous mode of proceeding.

In Britain, two really great disciples of Taylor soon appeared, STIRLING and MACLAURIN. The first (*Math. Dif.*, p. 102) repeated the theorem as given by Taylor himself, and adds that Herman had also given it in the Appendix to his *Phoronomia*; and as this last work was published in 1716, were Stirling's assertion true, Herman must probably be considered an independent inventor. But on examining the appendix to the *Phoronomia* (p. 393), to which Stirling refers, we find only the theorem in book v., lemma 3. of the Principia, and John Bernoulli's series for integration. Maclaurin (*Fluxions*, 1742, p. 610) proved Taylor's theorem again in the way which has since become common. But both Stirling and Maclaurin use only a particular case of Taylor's theorem, expanding not $\phi(x+z)$, but $\phi(0+z)$, or expanding ϕz in powers of z . Neither thought he was doing more than proving Taylor's theorem, and both attribute the result to Taylor. Nevertheless this particular case has been since called Maclaurin's theorem, though, if not Taylor's, it is Stirling's. Maclaurin's book was, no doubt, more read than either of the other two: it was the answer to Berkeley's metaphysical objections, and contained great power and vast store of instances; and this may have been the reason why a theorem which was best used in, and best known by, Maclaurin's book, should be called after his name. It is well that it should be so, or rather, it would be well that the development of $\phi(0+z)$ in powers of z should be called by the name of Stirling: for in truth the development of $\phi(a+b)$ in powers of b is one theorem or another in its uses, and in the consequences it suggests, according as a or b is looked at as the principal letter.

In the interval between Taylor's death and Lagrange's paper in the Berlin Memoirs for 1772, in which he first proposed to make Taylor's theorem the foundation of the Differential Calculus, the theorem was hardly known, and even when known, not known as Taylor's. We cannot find it in Hodgson's *Fluxions* (1736), in Maria Agnesi's *Institutiones* (1748), in Landen's *Residual Analysis* (1764), in Simpson's *Fluxions* (1737), in Emerson's *Increments* (1763), in Emerson's *Fluxions* (1743), in Stone's *Mathematical Dictionary* (1743), nor in the first edition of Montucla's *History* (1758). We have examined various other places in which it should be, without finding it anywhere, except in the great French Encyclopædia article 'Series', and there we certainly did find it, mentioned only incidentally, and attributed by no less a person than Condorcet to D'Alembert. The Abbé Bossut, who wrote the preliminary essay, knew nothing about the theorem at that time; though afterwards, when he published his history of mathematics, he was better informed. We found afterwards that Condorcet Lacroix, tom. iii., p. 396, was in the habit of assigning this theorem to D'Alembert: not of with any unfair intention, but in pure ignorance. The fact was that D'Alembert *Recherches sur différens points*, &c., vol. i., p. 50, according to Lacroix gave for the first time the theorem accompanied by a method of finding the remnant of Taylor's series after a certain number of terms have been taken; and Condorcet, who probably had never seen the theorem elsewhere, thought it was D'Alembert's. In fact, D'Alembert himself gave the theorem as if it were new, and without mentioning the name of any one, which Lacroix says is 'assez singulier,' an opinion in which we cannot agree. Unless D'Alembert read English, we cannot imagine how he should have known Taylor's theorem, nor even then, unless Taylor, Stirling, Maclaurin, or an old volume of the *Philosophical Transactions*, be supposed to have fallen in his way. We have no doubt that D'Alembert was a new discoverer of the theorem, and that Condorcet never saw it except in his writings. Our wonder rather is where Lagrange had found the name of Taylor in

* *Sciographia*, Prop. iii.: 'Si adumbrande parallele recte per extremum ipsa non parallelum componantur, illarum unum eo tunc concurrent in eodem puncto rectis adumbrandis rectis parallelis, et adumbrandis partibus parallelis una, punctum concensus eodem altitudine supra partem unam eorum concus.'

tion with it. For the use which Lagrange proposed of it, see DIFFERENTIAL CALCULUS, and FUNCTIONS, OF. From the time of the publication of the works the article last referred to, Taylor's theorem takes place which, if it had always occupied, we should not add to write any history of it. Full justice is done to the discoverer: it only remains to restore to Stirling the theorem which has hitherto been given to him.

Taylor's Theorem. We propose in this part of the work to give some account of the methods of algebraical development which are consequences of the celebrated theorem, the history of which is given in the last article. The simplest parts of the Differential and Integral Calculus are presumed known. It is not usual in works on that subject to bring together in one place the most conspicuous theorems which have arisen out of that of Taylor; which it is the more desirable that such a thing should be done as a work of reference. It is to be particularly remarked that we do not here profess to teach the subject of the differential calculus, but only to recall the steps of the several theorems to those who have already learnt them, and to present the theorems in a form which can be easily remembered.

In this notation, we shall frequently signify differentials by accents: thus $\phi''x$ is the second differential coefficient of ϕx with respect to x ; $(\phi x \psi x)'''$ is the third differential coefficient of the product of ϕx and ψx . And ϕx signifies the product $1 \times 2 \times 3 \times \dots \times (n-1) \times n$. When a series is written, three terms will be given, and the general term appended. Taylor's theorem is as follows:—

$$\phi(x+h) = \phi x + \phi'x \cdot h + \phi''x \frac{h^2}{2} + \dots + \left\{ \phi^{(n)} x \frac{h^n}{[n]} \right\}$$

This theorem is true whenever x has such a value that the series converges. 1. The value of x may be any one of the set $\phi x, \phi'x, \dots$ is infinite. 2. All the terms of the series do not vanish. Thus neither of the following could be treated by it when $x=a$:

$$\sqrt{x^2 - a^2} \cdot \log x \quad \text{and} \quad \epsilon^{-(x-a)^{-1}}$$

The first function, $\phi'x$, and all which follow, are infinite when $x=a$; in the second ϕx and all its differential coefficients vanish when $x=a$. The meaning of this theorem is as follows: the form of Taylor's theorem requires that $\phi(x+h)$ should be developed in integral powers of h ; consequently when such development is impossible, this theorem must show being inapplicable. Now, the first of these functions ($x=a$) can only have $\phi(a+h)$ expanded in fractional powers; and the second only in denumerable integer powers. Those who will only allow the converging series may require also that h should be such that the resulting series is convergent: but this restriction will afterwards be inapplicable, as will be

shown in all state five proofs of this theorem briefly, being the same as those given by Taylor, Maclaurin, D'Alembert, and Ampère.

First Proof.—Let $n\theta = h$, and form differences of ϕx : the series $\phi x, \phi(x+\theta), \phi(x+2\theta), \dots, \phi(x+n\theta)$. Hence we have [DIFFERENCE]

$$n\Delta x = \phi x + n\Delta\phi x + n \frac{n-1}{2} \Delta^2\phi x + \dots$$

$x = \theta$. Throw this into the form

$$h = \phi x + \frac{\Delta\phi x}{\Delta x} h + \frac{\Delta^2\phi x}{(\Delta x)^2} h^2 + \dots$$

Increase without limit, Δx at the same time diminishes so that $n\Delta x$ remains always $=h$. Then

$$\phi(x+h) = \phi x + \left(\text{Limit of } \frac{\Delta\phi x}{\Delta x} \right) h + \frac{1}{2} \left(\text{Limit of } \frac{\Delta^2\phi x}{(\Delta x)^2} \right) h^2 + \dots$$

Taylor's theorem is proved when we know that the limit of $\frac{\Delta\phi x}{\Delta x}$ is $\phi'x$.

The same as the limit of $\Delta^2\phi x : (\Delta x)^2$. This is the assumption* of Taylor's: but in the modern dif-

* *in incrementis evanescentibus scribantur fluxiones ipsas proportionales.* See the statement in TAYLOR, Broom.

ferential calculus it is a better plan to prove Taylor's theorem in another way, and then from the preceding follows the simplest manner of showing the identity of $\phi^{(n)}x$ and the limit of $\Delta^n\phi x : (\Delta x)^n$.

Maclaurin's Proof.—The method here given was first used by Maclaurin, and though it was only applied to develop $\phi(0+h)$, yet it will do equally well for $\phi(x+h)$; and Maclaurin himself saw no difference (as indeed there is none, ϕ being any function whatever) between the two cases. It turns upon $\phi(x+h)$ giving the same result, whether differentiated with respect to x or h , and assumes the form of the development, which is a radical defect. It is as follows: Let $\phi(x+h) = A + Bx + Cx^2 + \dots$; then $\phi'(x+h) = B + 2Cx + 3Dx^2 + \dots$, $\phi''(x+h) = 2C + 3.2Dx + \dots$, $\phi'''(x+h) = 3.2D + \dots$, which, when $h = 0$, give $\phi x = A$, $\phi'x = B$, $\phi''x = 2C$, $\phi'''x = 3.2D$, &c.; from which the theorem readily follows. The common proof, given in most elementary works on the differential calculus, is but a less commodious form of this.

D'Alembert's Proof.—The first principles of the Integral Calculus give

$$\phi(a+h) = \phi a + \int_a^{a+h} \phi'x dx.$$

$$\text{Let } x = a+h-z; \int_a^{a+h} \phi'x dx = - \int_h^0 \phi'(a+h-z) dz = \int_0^h \phi'(a+h-z) dz = \phi'a \cdot h + \int_0^h \phi''(a+h-z) \cdot z dz;$$

the last step being made by parts. Similarly

$$\int_0^h \phi''(a+h-z) z dz = \phi''a \frac{h^2}{2} + \int_0^h \phi'''(a+h-z) \frac{z^2 dz}{2}$$

$$\int_0^h \phi'''(a+h-z) \frac{z^2 dz}{2} = \phi'''a \frac{h^3}{2.3} + \int_0^h \phi^{(4)}(a+h-z) \frac{z^3 dz}{2.3}$$

and so on: whence it appears that if we go up to h^n in the series, the term involving h^n may be followed by another, expressed in the form of a definite integral, and which alone represents all the remnant of the series; as follows:—

$$\phi^{(n)} a \frac{h^n}{[n]} + \frac{1}{[n]} \int_0^h \phi^{(n+1)}(a+h-z) \cdot z^n dz.$$

The conditions of integration require that neither $\phi x, \phi'x, \dots, \phi^{(n+1)}x$ should be infinite from $x=a$ to $x=a+h$, both inclusive: this one condition being satisfied, the difficulty of divergent series disappears; for the theorem does not give an infinite series at all, but only any number we please of the terms of a series together with a concluding quantity which is finite both in form and reality. This integral might frequently be difficult to use, but limits for its value may be readily obtained. Let P and p be the greatest and least values of $\phi^{(n+1)}x$ from $x = a$ to $x = a+h$, both inclusive: then the concluding integral lies between

$$P \int_0^h z^n dz \quad \text{and} \quad p \int_0^h z^n dz \quad \text{or} \quad \frac{Ph^{n+1}}{n+1} \quad \text{and} \quad \frac{ph^{n+1}}{n+1}.$$

Now when a continuous function does not become infinite between two values of x , every quantity which lies between its greatest and least value is one of its intermediate values: or anything between P and p is a value of $\phi^{(n+1)}(a+\theta h)$, for some value of θ which is either 0 or 1, or between them. Hence the preceding expression may be written

$$\phi^{(n)} a \frac{h^n}{[n]} + \phi^{(n+1)}(a+\theta h) \frac{h^{n+1}}{[n+1]}.$$

The following form has been given by M. Cauchy. Let P and p represent the greatest and least values of $\phi^{(n+1)}(a+h-z) \cdot z^n$ from $z = 0$ to $z = h$, both inclusive: precisely similar reasoning will give for the last term chosen of Taylor's series, and the value of the remnant,

$$\phi^{(n)} a \frac{h^n}{[n]} + \phi^{(n+1)}(a+h-\theta h) \cdot \theta^n \frac{h^{n+1}}{[n]}$$

where θ is either 0 or 1, or between them.

We call the preceding D'Alembert's proof, but it is rather D'Alembert's result, and even that in a different form: his real process is as follows:—To take a case, integrate $\phi^{iv}(x+h)$ four times with respect to h , beginning at $h=0$: the results are $(x+h=X$ for abbreviation)

$$\begin{aligned} \phi^{iv}X - \phi'''x &= \int dh \cdot \phi^{iv}X \\ \phi''X - \phi''x - \phi'''x \cdot h &= \left(\int dh\right)^2 \phi^{iv}X \\ \phi'X - \phi'x - \phi''x \cdot h - \phi'''x \frac{h^2}{2} &= \left(\int dh\right)^3 \phi^{iv}X \\ \phi X - \phi x - \phi'x \cdot h - \phi''x \frac{h^2}{2} - \phi'''x \frac{h^3}{2.3} &= \left(\int dh\right)^4 \phi^{iv}X, \end{aligned}$$

and from this sort of process the result is

$$\begin{aligned} \phi(x+h) &= \phi x + \phi'x \cdot h + \phi''x \frac{h^2}{2} + \dots \\ &+ \phi^{(n)}x \frac{h^n}{[n]} + \left(\int_0^h dh\right)^n \phi^{(n)}(x+h), \end{aligned}$$

the two sides presenting the most identical forms which have yet occurred. The integral may easily be reduced to the form already given (Lacroix, vol. iii., p. 397). D'Alembert finished with the preceding form: it was Lagrange who first gave the limits which we have appended above.

Lagrange's Proof.—By this we do not mean the fallacious proof referred to in FUNCTIONS, THEORY OF, but that by which Lagrange established the limits of the value of the remnant, which, on the ordinary definition of a differential coefficient, is a proof, and a very satisfactory one, of the whole theorem. It rests upon the proposition that if a function of x have always one sign from $x = a$ to $x = a + h$, the integral of that function taken between those limits will have the same sign.

If then we wish to establish Taylor's theorem as far as, say, the term involving h^2 , and to give the limits of the remainder, let P and p be the greatest and least values of $\phi^{iv}(a+z)$ from $z = 0$ to $z = h$. Between those limits then $\phi^{iv}(a+z) - P$ is negative: integrate from $z=0$ to $z =$ any value not greater than h , and, by the preliminary theorem, $\phi'''(a+z) - \phi'''a - Pz$ is negative. Integrate successively under the same conditions, and we learn, step by step, that

$$\begin{aligned} \phi''(a+z) - \phi''a - \phi'''a \cdot z - P \frac{z^2}{2} \\ \phi'(a+z) - \phi'a - \phi''a \cdot z - \phi'''a \frac{z^2}{2} - P \frac{z^3}{2.3} \\ \phi(a+z) - \phi a - \phi'a \cdot z - \phi''a \frac{z^2}{2} - \phi'''a \frac{z^3}{2.3} - P \frac{z^4}{2.3.4} \end{aligned}$$

are severally negative. But $\phi^{iv}x - p$ is positive from $x = a$ to $x = a + h$; consequently, proceeding in the same manner, we find that, z being not greater than h ,

$$\phi(a+z) - \phi a - \phi'a \cdot z - \phi''a \frac{z^2}{2} - \phi'''a \frac{z^3}{2.3} - p \frac{z^4}{2.3.4}$$

is positive. If then we make $z = h$, we find that $\phi(a+h)$ lies between

$$\phi x + \phi'a \cdot h + \dots + P \frac{h^4}{2.3.4} \text{ and } \phi a + \phi'a \cdot h + \dots + p \frac{h^4}{2.3.4}$$

and the rest is as in the last proof.

There is a proof given by M. Cauchy which resembles the preceding in its principle, though of very different details, which may be seen in the *Lib. U. K.*, Differential Calculus, pp. 63, &c., 767. But this proof, though very well in a treatise on the subject, on account of the collateral uses of the preliminary theorems which it requires, is not so well suited to an isolated article on Taylor's theorem.

Ampère's Proof.—Let $\phi x = \phi a + P(x-a)$; differentiate successively with respect to a , and we have

$$\begin{aligned} 0 &= \phi'a + P'(x-a) - P \\ 0 &= \phi''a + P''(x-a) - 2P' \\ 0 &= \phi'''a + P'''(x-a) - 3P'', \text{ \&c.,} \end{aligned}$$

substitute for $P, P', \text{ \&c.}$ their values: that is, substitute for each equation to the preceding, and we have, $x = a + h$, Taylor's theorem with the following remnant following the term which has h^n in it

$$\frac{d^n}{dx^n} \left(\frac{\phi x - \phi a}{x-a} \right) \frac{h^{n+1}}{[n]},$$

making $x = a + h$ after differentiation.

It gives some trouble to show the limits of this series, for which we may refer to Ampère, 'Précis de Différentiel,' &c., Journ. Ec. Polytechn., cah. xiii.. This tract of Ampère is one of the purest deductions of the Differential Calculus from the theory of \int

In looking through all the proofs which give the remnant of the series, it will be seen that neither any differential coefficient employed can be made to become infinite between $x=a$ and $x=a+h$, such a circumstance does occur, the theorem relating the limits may cease to be true. For instance, $\phi = (x-m)^{-1}$, and stop the series after the first term gives

$$\frac{1}{a+h} - \frac{1}{m} = \frac{1}{a-m} - \frac{1}{(a+\theta h-m)^2} \cdot h$$

if $a+h$ and a be both greater or both less than m , of θ lying between 0 and 1 will be found to satisfy the equation, as it should do from the theorem. But if a be between $x=a$ and $x=a+h$, none but an imaginary value of θ will satisfy this equation.

Stirling's theorem, as it should be called, MacLaurin is called, is found simply by making $a=0$ in the development of $\phi(a+x)$. It gives

$$\begin{aligned} \phi x &= \phi 0 + \phi'0 \cdot x + \phi''0 \frac{x^2}{2} + \dots \\ &+ \phi^{(n)}0 \frac{x^n}{[n]} + \phi^{(n+1)}(\theta x) \frac{x^{n+1}}{[n+1]} \end{aligned}$$

θ being either 0 or 1, or between them. Here $\phi^{(n)}0$ that ϕx is to be differentiated n times, and $x = m$ after all the differentiations. This is the most useful of Taylor's theorem, with which it may be considered identical in one point of view, and of which it is a particular case in another: for $\psi(a+x)$ absolutely developed by Stirling's theorem is simply $\psi(a+x)$ developed by Taylor's theorem.

John Bernoulli's theorem, as given in the Leipzig for 1696, is as follows:—

$$\int_0^x \psi x dx = \psi x \cdot x - \psi'x \cdot \frac{x^2}{2} + \psi''x \cdot \frac{x^3}{2.3} - \dots$$

Here is an instance very much resembling the case of the BINOMIAL THEOREM (p. 412) with Wallis's investigations. If Wallis had looked at his own from a new point of view, he might not have left the theorem for Newton: if John Bernoulli had done the same, he might have given the law of development of $\phi(x+h)$. The preceding is a case of Taylor's theorem follows: by that theorem

$$\begin{aligned} \phi(x-x) &= \phi x - \phi'x \cdot x + \phi''x \frac{x^2}{2} - \dots \\ &\pm \phi^{(n)}x \frac{x^n}{[n]} \mp \phi^{(n+1)}(\theta x) \frac{x^{n+1}}{[n+1]} \end{aligned}$$

and $x - \theta x$ is the same in meaning as θx , an undetermined fractional part of x . Let $\phi x = \int_0^x \psi x dx$, then $\phi 0 = 0$; substitution and transposition give

$$\begin{aligned} \int_0^x \psi x dx &= \psi x \cdot x - \psi'x \frac{x^2}{2} + \psi''x \frac{x^3}{2.3} \\ &\pm \psi^{(n-1)}x \frac{x^n}{[n]} \mp \psi^{(n)}(\theta x) \frac{x^{n+1}}{[n+1]} \end{aligned}$$

This theorem is not of much use as a method of development, so that we need say no more of it in the present article.

Some views of Lambert on the reduction of the non-rational equations (*Acta Helvetica*, 1758) into series were realized by Lagrange (*Mém. Acad. Sci.*, 1768) into a generalized theorem of development bearing his name; this again was generalized in form by Laplace (*Mé.*

blem is as follows: given

$$y = F(z + x\phi y) \dots (A)$$

the expansion of ψy , when possible, in powers of x , if z be constant, and we differentiate with respect to x then make $x=0$, or $y=Fz$, we may use Stirling's

But this differentiation would be laborious and it was made more direct (by Laplace) in the following manner:—A constant may have any value given it may be made to vanish, either before or after differentiation with respect to a variable: if then we can differentiate with respect to x in terms of differentiations with respect to z only (in which x is constant), we are in our power to make x vanish before the differentiations, which will reduce the indirect or implicit to differentiation. This substitution of z -differentiation in place of those of x is done as follows:—Differentiate both with respect to x and z separately, and we

$$= F'(z + x\phi y) \left\{ \phi y + x\phi' y \frac{dy}{dz} \right\} \quad \text{whence}$$

$$= F'(z + x\phi y) \left\{ 1 + x\phi' y \frac{dy}{dz} \right\} \frac{dy}{dz} = \phi y \frac{dy}{dz}$$

be a function of y only, that is, not of x or z except these variables are contained in y : then

$$\frac{du}{dz} \frac{dy}{dz} = \phi y \frac{du}{dy} \frac{dy}{dz} \quad \text{or} \quad \frac{du}{dz} = \phi y \frac{du}{dy}$$

this equation only it may be shown (by INDUCTION)

$$\frac{d^n u}{dz^n} = \frac{d^{n-1}}{dz^{n-1}} \left(\phi y \frac{du}{dy} \right)$$

Assume the preceding to be true for one value of n , since $(\phi y)^n \times du : dy$ is a function of y only, let dv , v being another function of y .

$$\frac{d^n u}{dz^n} = \frac{d^{n-1}}{dz^{n-1}} \left(\frac{dv}{dy} \frac{dy}{dz} \right) = \frac{d^{n-1} v}{dz^{n-1}}$$

$$\frac{d^{n+1} u}{dz^{n+1}} = \frac{d^n}{dz^n} \left\{ \frac{dv}{dz}, \text{ or } \phi y \frac{dv}{dz}, \text{ or } \phi y \frac{dv}{dy} \frac{dy}{dz}, \text{ or} \right.$$

$$\left. \phi y (\phi y)^n \frac{du}{dy} \frac{dy}{dz}, \text{ or } (\phi y)^{n+1} \frac{du}{dz} \right\}$$

the theorem remains true after writing $n+1$ for n . It is true when $n=1$; therefore it is true for all values of n . If then we make $x=0$, or $y=Fz$, which may be done before the differentiations on the second side of the equation, we have (u being ψy)

$$\left\{ \frac{d^n \psi y}{dz^n} (x=0) \right\} = \frac{d^{n-1}}{dz^{n-1}} \left\{ (\phi Fz)^n \frac{d\psi Fz}{dz} \right\}$$

this to Stirling's Theorem, and we have Laplace's theorem, namely,

$$y = F(z + x\phi y) \text{ gives } \psi y = \left\{ (\phi Fz) \frac{d\psi Fz}{dz} \right\} x + \frac{d}{dz} \left\{ (\phi Fz)^2 \frac{d\psi Fz}{dz} \right\} \frac{x^2}{2} + \dots$$

the general term, $\frac{d^{n-1}}{dz^{n-1}} \left\{ (\phi Fz)^n \frac{d\psi Fz}{dz} \right\} \frac{x^n}{[n]}$

Lagrange's theorem, from which Laplace generalized, in which $Fz=x$; namely,

$$y = z + x\phi y \text{ gives } \psi y =$$

$$\psi z + (\phi z \psi' z) x + \frac{d}{dz} \left\{ (\phi z)^2 \psi' z \right\} \frac{x^2}{2} + \dots$$

the general term $\frac{d^{n-1}}{dz^{n-1}} \left\{ (\phi z)^n \psi' z \right\} \frac{x^n}{[n]}$

$$= \psi z + \phi z \cdot x + \frac{d(\phi z)^2}{dz} \frac{x^2}{2} + \frac{d^2(\phi z)^3}{dz^2} \frac{x^3}{2 \cdot 3} + \dots$$

Lagrange's theorem leads to *Burmans Theorem* (presented to the institute in 1796). The second is in fact the first, though very different in form, and arrived at independently. It is required, when possible, to expand $F. C., \text{ No. 1504.}$

ψx in powers of ϕx . This might be done indirectly, by expanding $\psi \phi^{-1} x$ in powers of x , and substituting ϕx for x in the result. The form in which Burmann obtained Lagrange's theorem avoids the indirect process. Let ϕx vanish when $x=a$, and let $\phi x = (x-a) : \chi x$, or $x = a + \phi x \cdot \chi x$. We can now employ Lagrange's theorem to expand ψx in powers of ϕx , and we have

$$\psi x = \psi a + \chi a \psi' a \cdot \phi x + \frac{d}{da} \left(\frac{-a^2}{\chi a^2} \psi' a \right) \frac{(\phi x)^2}{2} + \dots$$

Now the general term of this has for its co-efficient the value of

$$\frac{d^{n-1}}{dx^{n-1}} \left((\chi x)^n \psi' x \right) \text{ or } \frac{d^{n-1}}{dx^{n-1}} \left\{ \left(\frac{x-a}{\phi x} \right)^n \psi' x \right\}$$

when $x=a$: consequently ψx , expanded in powers of ϕx , is found by making $x=a$ in the co-efficients of the powers of ϕx in the following series:—

$$\phi a + \left\{ \frac{x-a}{\phi x} \cdot \psi' x \right\} \phi x + \left\{ \frac{d}{dx} \left(\left(\frac{x-a}{\phi x} \right)^2 \psi' x \right) \right\} \frac{(\phi x)^2}{2} + \dots$$

When in a function of any number of variables x_1, x_2, \dots , the variables are severally to receive increments h_1, h_2, \dots , &c., the law of the development is best seen by the calculus of operations. [OPERATION.] To change x into

$x+h$ is to perform the operation ϵ^{AD} , D being the symbol of differentiation with respect to x : the condensed form of the development now before us is

$$\epsilon^{h_1 D_1 + h_2 D_2 + \dots} \phi(x_1, x_2, \dots)$$

where D_1, D_2, \dots refer to x_1, x_2, \dots . The general term of the development is

$$\frac{(\epsilon^{h_1 D_1 + h_2 D_2 + \dots})^n}{[n]} \phi(x_1, x_2, \dots)$$

which must itself be developed. It is not worth while to pursue this case further; we shall only observe that when it is desired to stop, the remnant may be obtained by writing in the last term $x_1 + \theta h_1$, for x_1 , $x_2 + \theta h_2$, for x_2 , &c., where θ , the same in all, is either 0 or 1, or between them.

The value of x which makes $\phi x = 0$ is represented by

$$a - \frac{\phi}{\phi'} - \frac{\phi'' \phi^2}{2\phi'^2} - \frac{(3\phi''' - \phi' \phi'') \phi^3}{2 \cdot 3 \phi'^3} - \frac{(15\phi^{(4)} - 10\phi' \phi'' \phi' + \phi'^2 \phi^{(3)}) \phi^4}{2 \cdot 3 \cdot 4 \phi'^4}$$

$$+ \frac{\{105\phi^{(5)} - (10\phi'' \phi'' - \phi' \phi''') + 10\phi'^2 \phi^{(4)} + 15\phi' \phi' \phi^{(3)} - \phi'^2 \phi^{(4)}\} \phi^5}{2 \cdot 3 \cdot 4 \cdot 5 \phi'^5}$$

— &c.: where a is any assumed value (the nearer the root the better) and ϕ, ϕ', \dots represent $\phi a, \phi' a, \dots$. This series is obtained by common reversion from $\phi(u+h)=0$. For the forms which Paoli gave to this series, and also to Burmann's, see Lacroix, vol. i., pp. 306-308. The preceding series has been used, as far as three terms, in the article APPROXIMATION.

All that precedes is found in elementary treatises, with the exception of a few terms of the last series: we now come to matter which has been hitherto only the property of the well-read mathematician, but which well deserves to be made as common as Taylor's Theorem. We refer to ARBOGAST'S *method of derivations*. Few, even among mathematicians, are aware of the power of this process, which may perhaps arise from their taking Lacroix's account of it, instead of consulting the work of Arbogast himself: the former has only exhibited it to show that it may be reduced to processes of the differential calculus; and even the latter has so loaded his method with heavy applications, that he has concealed much of its beauty and simplicity.

The foundation of Arbogast's methods is a contrivance for expediting the expansion of $\phi(a+bx+cx^2+\dots)$ into a series of the form $A+Bx+Cx^2+\dots$. The process by which B is formed from A , C from B , &c. is uniform, and is called derivation; and A being ϕa , B may be called $D\phi a$, C may be called $DD\phi a$, or $D^2\phi a$, and so on. Hence b ought to be called Da , C ought to be D^2a , and so on. This notation is not precisely that of Arbogast, but will do for our purpose. For more detail, see the Differential Calculus (*Library of Useful Knowledge*), pp. 328-334.

* There is a great deal on the subject in the 'Mathematical Treatises' (posthumous) of the Rev. John West, published at Edinburgh in 1836. Mr. West

If, for a moment, we write the expansion thus—

$$\phi(a_0 + a_1x + a_2x^2 + \&c. = A_0 + A_1x + A_2x^2 + \&c. ;$$

and if we differentiate both sides with respect to a_m , x and all the other coefficients remaining constant, we have

$$\phi'(a_0 + a_1x + \&c.) \cdot x^m = \frac{dA_0}{da_m} + \frac{dA_1}{da_m} x + \&c.$$

which shows that a_m cannot enter any coefficient preceding A_m , or

$$\phi'(a_0 + a_1x + \&c.) = \frac{dA_m}{da_m} + \frac{dA_{m+1}}{da_m} x + \&c.$$

The first side of this is the same series, whatever letter a_m was made to vary; the second side is therefore always the same series; whence we collect that $dA_{m+1} : da_m$ does not alter with the value of m , being always the coefficient of x^m in the development of $\phi'(a_0 + a_1x + \&c.)$. It is enough to satisfy this condition for each letter and its preceding one; that is to say, each co-efficient differentiated with respect to any one letter, is to yield the same result as the directly preceding co-efficient differentiated with respect to the directly preceding letter. The following rules are found sufficient. To pass from any one derivative of ϕa to the next, arrange the letters $a, b, c, \&c.$, or $a_0, a_1, a_2, \&c.$, whichever may be used, in order, in every term: differentiate with respect to the last letter in each term, and multiply by the letter which comes next to it. And when the last but one immediately precedes the last in the alphabet or other consecutive system, do the same with the last but one, and divide by the exponent of the last letter, as it becomes after the increase which it receives from the process of the preceding letter; but in no case use any letters but the last or the last but one. For instance, beginning with ϕa , in which is only one letter, we have $\phi'a, b$, or

$$D\phi a = \phi'a, b;$$

in which are two letters, a and b , consecutive. Operate upon b , and we have $\phi'a, c$; operate on $\phi'a$, and we have again $\phi''a, b$, which, with the b which was in before, is $\phi''a, b^2$, which we divide by the new exponent of b , or by 2, whence

$$D^2\phi a = \phi'a, c + \frac{\phi''a}{2} b^2.$$

In forming $D^2\phi a$, we use only c in $\phi'a, c$, because a does not immediately precede c ; and we get (the succession being $a, b, c, e, f, g, h, k, \&c.$)

$$D^2\phi a = \phi'a, e + \frac{\phi''a}{2} \cdot 2bc + \frac{\phi'''a}{2.3} b^2;$$

and so on. As soon however as the law is established, it is best to form a table of the successive derivatives of the powers of b by this same law: we then have

$$D^n\phi a = \phi'a D^{n-1} b + \frac{\phi''a}{2} D^{n-2} b^2 + \frac{\phi'''a}{2.3} D^{n-3} b^3 + \&c.$$

$$\text{as far as } \frac{\phi^n a}{[n]} b^n;$$

in which $\phi'a, \phi''a, \&c.$ are to be taken from the function by common differentiation, and the derivatives of the powers of b from the table. This being done, we have

$$\phi(a + bx + cx^2 + ex^3 + fx^4 + gx^5 + \&c.) = \phi a + D\phi a \cdot x + D^2\phi a \cdot x^2 + D^3\phi a \cdot x^3 + \&c.;$$

and the process is shortened to its utmost extent; all that is not differentiation being merely reference to a table and writing the result.

We shall give materials for proceeding as far as the term $D^{12}\phi a \cdot x^{12}$, not that so much will often be necessary, but because it is desirable to show with how little trouble questions of enormous labour in the ordinary way, such, for instance, as that solved in REVERSION OF SERIES, may be looked at without dismay. We have to form every derivative of every power of b , $D^m b^n$, in which $m+n$ does not exceed 12.

has substituted a notation, for that of Arbogast, in which he will probably have few followers. The student who is not repelled by this, and cannot procure Arbogast's work, will find Weir's treatise abounding in derivations.

$$\begin{matrix} D^0 b = c & D^1 b = e & D^2 b = f & D^3 b = g \\ D^1 b = h & D^2 b = k & D^3 b = l & D^4 b = m \\ D^2 b = n & D^3 b = p & D^4 b = q & \end{matrix}$$

$$\begin{matrix} D^2 b^2 = 2bc \\ D^1 b^2 = 2be + c^2 \\ D^0 b^2 = 2bf + 2ce \\ D^3 b^2 = 2bg + 2f + e^2 \\ D^2 b^2 = 2bh + 2cg + 2ef \\ D^1 b^2 = 2bk + 2ch + 2eg + f^2 \\ D^0 b^2 = 2bl + 2ck + 2eh + 2fg \\ D^4 b^2 = 2bm + 2cl + 2ek + 2fh + g^2 \\ D^3 b^2 = 2bn + 2cm + 2dl + 2fk + 2gh \\ D^2 b^2 = 2bp + 2cn + 2em + 2fl + 2gk + h^2 \end{matrix}$$

$$\begin{matrix} D^3 b^3 = 3b^2 e \\ D^2 b^3 = 3b^2 f + 3bc^2 \\ D^1 b^3 = 3b^2 g + 6bcf + 3be^2 + 3c^2 e \\ D^0 b^3 = 3b^2 h + 6bcg + 6bcf + 3c^2 f + 3ce^2 \\ D^4 b^3 = 3b^2 k + 6bch + 6beg + 3bf^2 + 3c^2 g + 6cef + e^3 \\ D^3 b^3 = 3b^2 l + 6bck + 6beh + 6bfg + 3c^2 h + 6ceg + 3cf^2 \\ D^2 b^3 = 3b^2 m + 6bcl + 6bek + 6bfh + 3bg^2 + 3c^2 k + 6cfg + 3c^2 g + 3cf^2 \\ D^1 b^3 = 3b^2 n + 6bcm + 6bel + 6bfk + 6bgh + 3c^2 l + 6cfh + 3cg^2 + 3c^2 h + 6efg + f^3 \end{matrix}$$

$$\begin{matrix} D^4 b^4 = 4b^3 c \\ D^3 b^4 = 4b^3 e + 6b^2 c^2 \\ D^2 b^4 = 4b^3 f + 12b^2 ce + 4bc^3 \\ D^1 b^4 = 4b^3 g + 12b^2 cf + 6b^2 e^2 + 12bc^2 e + c^4 \\ D^0 b^4 = 4b^3 h + 12b^2 cg + 12b^2 ef + 12bc^2 f + 12ce^2 + 4c^4 \\ D^5 b^4 = 4b^3 k + 12b^2 ch + 12b^2 eg + 6b^2 f^2 + 12bc^2 g + 4b^2 e^3 + 4c^2 f + 6c^2 e^2 \\ D^4 b^4 = 4b^3 l + 12b^2 ck + 12b^2 eh + 12b^2 fg + 12bc^2 h + 12bc^2 f^2 + 12bc^2 e^2 + 4c^3 g + 12c^2 ef + 4c^3 e^2 \\ D^3 b^4 = 4b^3 m + 12b^2 cl + 12b^2 ek + 12b^2 fh + 6b^2 g^2 + 24b^2 ceh + 24bc^2 fg + 12b^2 eg + 12bc^2 f^2 + 4c^3 h + 12c^2 eg + 6c^2 f^2 + 12c^2 ef + c^4 \end{matrix}$$

$$\begin{matrix} D^5 b^5 = 5b^4 c \\ D^4 b^5 = 5b^4 e + 10b^3 c^2 \\ D^3 b^5 = 5b^4 f + 20b^3 ce + 10b^3 c^3 \\ D^2 b^5 = 5b^4 g + 20b^3 cf + 10b^3 e^2 + 30b^2 c^2 e + 5bc^4 \\ D^1 b^5 = 5b^4 h + 20b^3 cg + 20b^3 ef + 30b^2 c^2 f + 30b^2 c^2 e^2 + c^5 \\ D^0 b^5 = 5b^4 k + 20b^3 ch + 20b^3 eg + 10b^3 f^2 + 30b^2 c^2 g + 10b^2 e^3 + 20bc^3 f + 30bc^2 e^2 + 5c^4 e \\ D^6 b^5 = 5b^4 l + 20b^3 ck + 20b^3 eh + 20b^3 fg + 30b^2 c^2 h + 30b^2 c^2 f^2 + 30b^2 c^2 e^2 + 20b^2 c^3 g + 60bc^2 ef + 5c^4 f + 10c^4 e^2 \end{matrix}$$

$$\begin{matrix} D^6 b^6 = 6b^5 c \\ D^5 b^6 = 6b^5 e + 15b^4 c^2 \\ D^4 b^6 = 6b^5 f + 30b^4 ce + 20b^4 c^3 \\ D^3 b^6 = 6b^5 g + 30b^4 cf + 15b^4 e^2 + 60b^3 c^2 e + 15b^3 c^4 \\ D^2 b^6 = 6b^5 h + 30b^4 cg + 30b^4 ef + 60b^3 c^2 f + 60b^3 c^2 e^2 + 6bc^5 \\ D^1 b^6 = 6b^5 k + 30b^4 ch + 30b^4 eg + 15b^4 f^2 + 60b^3 c^2 g + 120b^3 c^2 e^2 + 20b^3 e^3 + 60b^2 c^3 f + 90b^2 c^3 e^2 + 30bc^4 e + c^6 \end{matrix}$$

$$\begin{matrix} D^6 b^7 = 7b^6 c \\ D^5 b^7 = 7b^6 e + 21b^5 c^2 \\ D^4 b^7 = 7b^6 f + 42b^5 ce + 35b^5 c^3 \\ D^3 b^7 = 7b^6 g + 42b^5 cf + 21b^5 e^2 + 105b^4 c^2 e + 35b^4 c^4 \\ D^2 b^7 = 7b^6 h + 42b^5 cg + 42b^5 ef + 105b^4 c^2 f + 105b^4 c^2 e^2 + 140b^3 c^3 e + 21b^3 c^5 \end{matrix}$$

$$\begin{matrix} D^6 b^8 = 8b^7 c \\ D^5 b^8 = 8b^7 e + 28b^6 c^2 \\ D^4 b^8 = 8b^7 f + 56b^6 ce + 56b^6 c^3 \\ D^3 b^8 = 8b^7 g + 56b^6 cf + 28b^6 e^2 + 168b^5 c^2 e + 70b^5 c^4 \\ D^2 b^8 = 9b^8 c \\ D^1 b^8 = 9b^8 e + 36b^7 c^2 \\ D^0 b^8 = 9b^8 f + 72b^7 ce + 84b^7 c^3 \end{matrix}$$

$$D^6 b^9 = 10b^8 c \quad D^5 b^9 = 10b^8 e + 45b^7 c^2$$

$$D^6 b^{11} = 11b^{10} c$$

By these results, observe that if we consider each of the first dimension, every term of $D^n b^r$ is of dimension; but if we consider each letter as of the following:—

<i>b</i>	<i>c</i>	<i>e</i>	<i>f</i>	<i>g</i>	<i>h</i>	<i>k</i>	<i>l</i>	<i>m</i>	<i>n</i>	<i>p</i>	<i>q</i>
1	2	3	4	5	6	7	8	9	10	11	12:

Every term of $D^n b^r$ is of the $(n+r)$ th dimension. To if all the proper terms be there, and with the exponents, write down the number of ways in which r can be made out of r numbers. Thus to this point for $D^7 b^8$, write down the ways in which 8 can be made out of three numbers, namely, 1, 7+2+1, 6+3+1, 6+2+2, 5+4+1, 5+3+2, 4+4+2, 4+3+3;

each letter answering to each number, in the above multiply the letters of each set together, which

$$b^8, bck, beh, c^3h, bfg, ceg, cf^2, e^2f,$$

where, coefficients excepted, the terms of $D^7 b^8$ in the To verify the coefficients separately, observe that coefficient of that term of $D^n b^r$ which contains the s th power, &c., is

$$\frac{1.2.3... (r-1)r}{1.2.3...s \times 1.2.3...t \times \dots}$$

in $D^7 b^8$, the term containing $b^2 c^2 e$ ought to be led by

$$\frac{1.2.3.4.5.6.7.8}{1.2.3.4.5 \times 1.2 \times 1} \text{ or } 168, \text{ as is the case.}$$

The best general mode of verification is derived e theorem

$$-1 = \frac{1}{r} \frac{dD^r b^r}{db}, \text{ or } D^{n+1} b^{r-1} = \frac{1}{r} D \left(\frac{dD^n b^r}{db} \right);$$

having a certain derivative of a certain power, the er derivative of the next lower power may be by differentiating with respect to b , dividing by exponent of the original power, and then performing ivation. Thus:

$$D^3 b^9 = 9b^8 f + 72b^7 c e + 84b^6 c^2,$$

iate with respect to b , and divide by 9, which

$$8b^7 f + 56b^6 c e + 56b^5 c^2.$$

derive, which gives

$$8b^7 g + 56b^6 c f + 28b^5 e^2 + 168b^4 c^2 e + 70b^3 c^3,$$

ie as is found in the table for $D^{3+1} b^{9-1}$. Here we he earlier result of the table from the later: to he later from the earlier, use the following:—

$$b^r = D^{n-1} c . r b^{r-1} + D^{n-2} c^2 . r(r-1) b^{r-2} + \&c.$$

$$\text{up to } c \frac{r(r-1)... (r-n+1)}{1.2 \dots n} b^{r-n},$$

h the derivatives of powers of c must be formed ie corresponding tabular ones of b , by changing iter into the next following. There are thus abunans of verification. We will mention yet one more. Only the last letter and the last but one (and ly when the two letters are consecutive) are used derivations. If we use any letter, no new term is ad, but only a repetition of those which other terms For instance, in $D^8 b^9$ is the term $60b^8 c e f$; and in to $D^7 b^8$, we derive from f because it is the last and from e because, being the last but one, it immed precedes f in the series. We do not here use b and c but if we did use them, we should only repeat terms will come into $D^7 b^8$ from other sources. Thus:— gives, from f , $60b^8 c e g$, which is set down in $D^7 b^8$: $60b^8 c f f - 2$, or $30b^8 c f^2$, which is also set down: if c had been used, we should have had $60b^8 e e f - 2$, $e^2 f$, which, on looking, we find set down, as arising he last letter of $10b^8 e^2$. From b , in $60b^8 c e f$, had it used, we should have got $120b^8 c c e f - 2$, or $60b^8 c^2 e f$, is also found, and arises from the last letter of . If then we ever find that derivation from one of used letters gives anything but what arises from if the letters which are used, it is a sign that some as been committed.

By help of the preceding method, expansions which analysts usually avoid as much as possible, at almost any expense of circumpoperation, are carried with the greatest facility even further than is necessary. The development of $\phi(a+bx+cx^2+\&c.)$, already given, is one instance; the process in REVERSION OF SERIES is another. This last is done* by expanding x in powers of $ax+bx^2+\&c.$, by Burmann's Theorem, and making the expansion of the negative powers of $(a+bx+cx^2+\&c.)$, which will be wanted, by the method of derivations. We shall state some further applications:—

$$(b+cx+ex^2+\&c.)^m = b^m + D b^m . x + D^2 b^m . x^2 + \&c.$$

When m is integer, these derivatives are in the table. When $b+cx+\&c.$ is a finite series, the whole result is brought out with great ease, compared with the trouble of the common algebraical operation: in this case the value of every letter after the last in the finite series is 0, or the last letter of that series is not to be employed in derivation. Let the reader try for himself $(b+cx+ex^2+f^3)^3$ by this mode and then in the common way, going only so far in the latter as to feel sure that the former is of no trouble

compared with it. Let $m, m \frac{m-1}{2}, \&c.$ be denoted by $m, m_1, \&c.$

$$(a+bx+cx^2+\&c.)^m = a^m + mba^{m-1}x$$

$$+ (mac + m_1 b^2) a^{m-2} x^2$$

$$+ (ma^2 e + m_2 a D b^2 + m_2 b^3) a^{m-3} x^3$$

$$+ (ma^3 f + m_3 a^2 D^2 b^2 + m_3 a D b^3 + m_3 b^4) a^{m-4} x^4$$

+, &c.; the law of which is evident, the only thing left being the substitution of the values in the tables instead of the derivatives of b . This form is convenient for fractional or negative powers. The following case is worth exhibiting separately:—

$$\frac{1}{a+bx+\&c.} = \frac{1}{a} - \frac{b}{a^2} x + \frac{b^2-ac}{a^3} x^2 - \frac{b^3-aDb^2+a^2e}{a^4} x^3 + \frac{b^4-aDb^3+a^2D^2b^2-a^2f}{a^5} x^4$$

-, &c. We have avoided the formality of writing $D b$ for c , $D^2 b$ for e , &c.

$$\frac{A+Bx+Cx^2+\&c.}{a+bx+cx^2+\&c.} = \frac{A}{a} - \frac{Ab-Ba}{a^2} x$$

$$+ \frac{A(b^2-ac)-Bab+Ca^2}{a^3} x^2$$

$$\frac{A(b^3-aDb^2+a^2e)-Ba(b^2-ac)+Ca^2b-Ea^3}{a^4} x^3 + \&c.$$

The law is here evident enough; the next numerator would be

$$A(b^4-aDb^3+a^2D^2b^2-a^2f)-Ba(b^3-aDb^2+a^2e)+Ca^2(b^2-ac)-Ea^3b+Fa^4$$

The derivatives of the general term b^m may be readily formed, but the particular cases are more useful; see the derivatives of a^m in the general form above given. We shall not overload this subject with further examples: enough have been given to show those who require developments of some extent how much labour they might save. It frequently happens that the form given is not

$$\phi(a+bx+cx^2+\&c.) \text{ but } \phi\left(a+bx+\frac{cx^2}{2}+\frac{ex^3}{2.3}+\&c.\right),$$

in which case the occurrence of the fractions in the denominator renders the process more complicated than it need

* M. Wronski has given elegant forms of transformation and development, which are most accessible in Monferrrier's 'Dictionnaire des Sciences Mathematiques,' Paris, 1832. The author of these developments has wrapped himself in a cloud of obscurity, and adopted the tone of an assulant, with not a little of the manner of a charlatan, which has hindered his really remarkable extensions from receiving the notice to which they are entitled, and himself from obtaining the character as a mathematician which no one who reads his works can for a moment deny him. We do not enter into his methods, because, though good in theory, they are not easily used, from their excessive generality. For instance, in the article on REVERSION OF SERIES, in the dictionary cited, the author of which is a partisan of M. Wronski, the results are carried on far on I. of our article on that subject, not by the vaulted methods, but by the old method of indeterminate coefficients, an immense labour, after which the name of the undertaker is very properly recorded. To repeat the same process and to carry it two terms further, by Arbogast's and Burmann's methods combined, did not take us three hours.

be. We put down tables for the development of this function, derived from the preceding tables, as far as the tenth power of x : to be used as follows:—

Let

$$\phi \left(a + bx + c \frac{x^2}{2} + e \frac{x^3}{2.3} + \&c. \right) = A_0 + A_1x + A_2 \frac{x^2}{2} + \&c.$$

Then $A_n = \phi'a \cdot D^{n-1}b + \phi''a \cdot D^{n-2}b^2 + \dots + \phi^{(n)} a \cdot b^n$

where the derivatives of the powers of b , which do not mean the same as hitherto, are to be taken from the following table:—

$D b = c$		
$D^2 b = e,$	$D b^2 = 3bc$	
$D^3 b = f,$	$D^2 b^2 = 4be + 3c^2,$	$D b^3 = 6b^2c$
$D^4 b = g,$	$D^3 b^2 = 5bf + 10ce,$	$D^2 b^3 = 10b^2e + 15bc^2,$
	$D b^4 = 10b^3c$	
$D^5 b = h,$	$D^4 b^2 = 6bg + 15cf + 10e^2,$	$D^3 b^3 = 15b^2f$
	$+ 60bce + 15c^3$	
$D^6 b = k,$	$D^5 b^2 = 7bh + 21cg + 35f^2$	
	$D^4 b^3 = 21b^2g + 105bcf + 70be^2 + 105c^2e$	
	$D^5 b^3 = 35b^2f + 210b^2ce + 105bc^2$	
	$D^6 b^3 = 35b^2e + 105b^2c^2,$	$D b^4 = 21b^3c$
$D^7 b = l,$	$D^6 b^2 = 8bk + 28ch + 56eg + 35f^3$	
	$D^5 b^3 = 28b^2h + 168bcg + 280bef + 210c^2f + 280ce^2$	
	$D^6 b^3 = 56b^2g + 420b^2cf + 280b^2e^2 + 840bc^2e + 105c^3$	
	$D^7 b^3 = 70b^2f + 560b^2ce + 420b^2c^2$	
	$D^8 b^3 = 56b^2e + 210b^2c^2,$	$D b^5 = 28b^4c$
$D^9 b = m,$	$D^8 b^2 = 9bl + 36ck + 84eh + 128fg$	
	$D^7 b^3 = 36b^2l + 252bck + 504beg + 315b^2f^2 + 378c^2g$	
	$+ 1280cef + 280e^3$	
	$D^8 b^3 = 84b^2h + 756b^2cg + 1260b^2cf + 1890bc^2f + 2520bce^2$	
	$+ 1280c^3e$	
	$D^9 b^3 = 126b^2g + 1260b^2cf + 840b^2e^2 + 3780b^2c^2e + 945bc^3$	
	$D^{10} b^3 = 126b^2f + 1260b^2ce + 1260b^2c^2$	
	$D^{11} b^3 = 84b^2e + 378b^2c^2,$	$D b^6 = 36b^5c$
$D^{12} b = n,$	$D^{11} b^2 = 10bm + 45cl + 120ek + 210/h + 128g^2$	
	$D^{10} b^3 = 45b^2l + 360bck + 840beh + 1260bfg + 630c^2h$	
	$+ 2520ceg + 1575cf^2 + 2100ef^2$	
	$D^{11} b^3 = 120b^2h + 1260b^2ch + 2520b^2eg + 1575b^2f^2$	
	$+ 3780bce^2g + 12600bc^2ef + 2800be^3 + 3150c^2f^2$	
	$+ 6300c^2e^2$	
	$D^{12} b^3 = 210b^2k + 2520b^2cg + 4200b^2ef + 9450b^2cf^2$	
	$+ 12600b^2ce^2 + 12600bc^2e + 945c^3$	
	$D^{13} b^3 = 252b^2g + 3150b^2cf + 2100b^2e^2 + 12600b^2c^2e$	
	$+ 4725b^2c^2$	
	$D^{14} b^3 = 210b^2f + 2520b^2ce + 3150b^2c^2$	
	$D^{15} b^3 = 120b^2e + 630b^2c^2,$	$D b^7 = 45b^6c.$

We shall conclude this article by recommending that the process of derivation should be introduced, without demonstration of course, into elementary books of algebra, as one of the best exercises of simple algebraical operation. We are firmly of opinion that the arithmetician and the analyst should be trained early in the performance of operations in which numerous details, each very simple in itself, follow one another in rapid succession with much sameness and some diversity. For this reason we should recommend, in arithmetic, Horner's process [INVOLUTION AND EVOLUTION]; and in algebra, Arbogast's derivation. We proceed accordingly to divest this method of the phraseology of the differential calculus, and to put it before the elementary student in algebra.

The name of the process is *derivation*; its primary object the raising of any power of an expression of the form $b + cx + ex^2 + fx^3 + \&c.$ immediately, that is to say, by writing down the result at once, without any but simple mental processes in passing from term to term. The rules are as follows:

1. Begin with that power of b which is to be raised.
2. To pass from the coefficient of one that of the next, multiply each letter by cx then diminish that exponent by a unit; then introduce the next letter. And if this last process increase an exponent owing to the letter newly introduced having been term before, divide by the increased exponent. *Remember never to operate on any letter except the term, or the last but one; upon the last always the last but one when it immediately precedes in the original series $b, c, e, f, \&c.$*

3. If $b + cx + \&c.$ be not an infinite series, but a number of terms, operate as if the succeeding letters severally equal to 0: for instance, if g be the drop every term in which h should appear, as arises.

For example, the fifth power of $b + cx + \dots$. Begin with b^5 , derive from it $5b^4c$, the two first $b^5 + 5b^4c \cdot x$.

To form the coefficient of x^2 , take $5b^4c$, and that b and c follow each other in the series, so next derivation there are two processes. First, take the last letter, which by the rule gives $1c^2e$ or e : as derivation applied to the first power of a letter merely a change of that letter into the next: hence gives $5b^4e$. But b^4 , which must also be used, and $5b^4c$ gives $5(4b^3c)$; so that c becomes c^2 , and therefore divide by the increased exponent 2, $10b^3c^2$. Hence the next term is

$$(5b^4e + 10b^3c^2)x^2.$$

In the next derivation $5b^4e$ gives only $5b^4f$, for b immediately preceding e in the series $b, c, e, \&c.$ is 1. But $10b^3c^2$ gives

$$10b^3(2ce) + \frac{10(3b^2c^2)e}{3}, \text{ or } 20b^3ce + 10b^2c^3.$$

Next term $(5b^4f + 20b^3ce + 10b^2c^3)x^2$.

In the next derivation $5b^4f$ must be neglected because f is the last letter, and b is not the immediately preceding. Also $20b^3ce$ gives $20b^3cf$ or $10b^2e^2$; while $10b^2c^3$ gives $30b^2c^2e$ and $2 \times 10b^2c^2e = 5bc^3$. The whole value of $(b + cx + ex^2 + fx^3)^5$ is as f and a little practice would enable any one to write at once, without any intermediate operations:

$$\begin{aligned} & b^5 + 5b^4cx + (5b^4e + 10b^3c^2)x^2 + (5b^4f + 20b^3ce + 10b^2c^3)x^3 \\ & + (20b^3cf + 10b^2e^2 + 30b^2c^2e + 5bc^3)x^4 \\ & + (20b^2ef + 30b^2cf^2 + 30b^2ce^2 + 20bc^2e + c^3)x^5 \\ & + (10b^2f^2 + 60b^2cef + 10b^2e^3 + 20bc^2f + 30bc^2e^2 + 5c^4) \\ & + (30b^2cf^2 + 30b^2ef^2 + 60bc^2ef + 20bc^2e^2 + 5c^4f + 30b^2ef^2 + 30bc^2f^2 + 60bc^2ef + 5bc^4 + 20c^4ef + 10b^2f^3 + 60bc^2ef^2 + 20bc^2e^2f + 10c^2f^2 + 30c^2ef^2 + 3cc^3) \\ & + (20bc^2f^2 + 30bc^2ef^2 + 30c^2ef^2 + 20c^2ef^2 + c^3)x^6 \\ & + (20bc^2f^2 + 10c^2f^3 + 30c^2ef^2 + 5c^4f)x^7 \\ & + (5b^4f^2 + 20c^2ef^2 + 10c^2f^3)x^8 + (5c^4f^2 + 10c^2f^3)x^9 \\ & + 5c^4f^2x^{10} + f^3x^{15} \end{aligned}$$

This process, so simple as compared with the performance of the four multiplications, has hitherto hid in works on the higher parts of the differential calculus: it in time it should take its place in every algebra which contains the binomial theorem, it is the legitimate extension.

TAYLOR, JOHN, LL.D., was born about the year 1703, at Shrewsbury, where his father, according to writers, was a poor shoemaker, or, according to another writer, a barber. He received his early education at the grammar school of his native place, and afterwards at the university of Cambridge, where he entered St. John's College, and became a fellow in 1730. The great reputation soon acquired as one of the best Greek scholars of the University, procured him the office of librarian in the university library, which however he afterwards resigned for that of registrar of the University. For the importance was his edition of the Greek Orations of Lysias, under the title *Lysiae Orationes et Fragmenta*, Latinè: ad fidem codicum MSS. interpretatione, caeteroque apparatus necesse est Joannes Taylor, London, 1739, 4to. The year after he published an octavo edition of the same for the use of students, with short notes and a useful glossary of the language. The study of the Attic orators led

idy of the Attic law, of which he probably possessed better knowledge than any man of his age. He was fond of the study of the Roman and English law, and resolved to devote himself to the legal profession. He was admitted an advocate in Doctors' Commons the year after he took his degree of doctor of law; on this occasion he published a Latin dissertation, *De Legem Decemviralem de Inope Debiles dissecando*, which is a very unsatisfactory specimen of this difficult subject. Soon after this he published an edition of two Greek orations, 'Orationes Demosthenis contra Midiam, altera Lycurgi pro Cicerone, Græcè et Latinè,' with notes and emendations, Cambridge, 1743, 8vo., and in the same year he published the 'Marmor Sandvicensæ, cum Commentario et Index,' Cambridge, 1743, 4to. This volume also contains a dissertation on this celebrated inscription, which was first brought from Athens to London by Lord Sandwich, in 1739. In 1744 Dr. Taylor was made chancellor of the University of Cambridge; and some years later he took holy orders, without abandoning the study of the law and of the writings of the ancients. He was now successively made archdeacon of Buckingham and rector of Lawford in Essex, in 1757, was added the lucrative place of canon of the Cathedral of St. Paul's. In 1755 he published at London, his 'Elements of Civil Law,' a second edition appeared in 1769. Dr. Taylor undertook this work at the suggestion of Lord Carteret, who had intrusted the education of his grandsons, whom he wished to instruct in the principles and history of the civil law; the work displays great learning and knowledge of the subject, but it is not well adapted for the use of beginners; an abridgement of it appeared in 1773, in London, under the title 'A Summary of the Roman Law.' During the latter period of his life, Dr. Taylor had made extensive translations for a new edition of the Greek orators. One of these (which is the third) appeared in 1748 at Cambridge, and at his death on the 4th of April, 1756, prevented him from completing the work, though all the volumes were ready for press. The second volume appeared at his death, in 1757. The work bears the title 'Demosthenis, Æschinis, Dinarchi, et Demædis Orationes Græcè et Latinè, cum notis edidit J. Taylor,' which were published at a later time, are incorporated in Reiske's 'Apparatus Criticus' to Demosthenes. The principal point of view the edition of Taylor is not of great worth, and its chief value consists in his notes and abridgement of the history of the orations and the Attic language. Taylor is said to have been a most amiable and disinterested man: he had considerable taste for poetry, and specimens of his muse are printed in the 'Gentleman's Magazine,' and in Nichols's 'Select Collection of

and Johnston's *General Biography*, vol. ix., p. 42; Reiske, *Praefatio ad Demosthenem*, p. 42.

TAYLOR, SIR ROBERT, born in 1714, was the son of a stone-mason, who was more prosperous than he; for he affected a style of living very unusual at that time among persons engaged in business: he kept a large house, and also his country-house in Essex. To his son, on the contrary, he appears to have been very liberal, as he bestowed on him only a common education, and then placed him under Sir Henry Sturt, a sculptor, whose chief work of note is the statue of George III. in the library of All Souls, Oxford. Taylor was furnished by his father with a liberal education, and money to proceed to Rome, where he was to have lived with the utmost frugality. His studies in Rome, however, of no long continuance, for he was obliged to return home by the intelligence of his father's death; he was seriously ill; upon which he hurried back to England with as much expedition as the state of the Continent would then permit, and was obliged to disguise himself as a Franciscan friar. On reaching home, he found his father dead, and that he had left nothing remaining entirely upon his own resources and ability, he remained for him as to set up business as a sculptor, and he first brought himself into notice by Cornish's monument. His principal other works in sculpture are the figure of Britannia at the Bank of England, and the relief in the pediment of the Mansion-house, Lon-

don. After this he abandoned sculpture for architecture, and one of his earliest productions in his new profession was the mansion erected by him for Mr. Gower, near the South Sea House. In 1756-58 he was employed in the alterations of old London Bridge in conjunction with Dance, and thenceforth upon a number of buildings both public and private; yet very few among which display much architectural taste, and least of all any of that richness in decoration and detail which might have been expected from one who had been brought up and had practised as a sculptor. The wings added by him to the Bank of England (afterwards swept away by his successor Soane) were at the time termed 'magnificent,' but then it could only be by comparison with the older building by Sampson, to which they were attached. This design itself was only borrowed from one of Bramante's [BRAMANTE], and was upon so small a scale as to look insignificant in such a situation. The 'Stone Buildings' at Lincoln's Inn are such a mere architectural blank, that the columns, instead of diminishing the poverty of its character, serve only to render it the more apparent. There is however some architectural character displayed in that which is called the 'Six Clerks' Office,' situated between the other building and Chancery Lane. The villa which he built for Sir Charles Asgill at Richmond is at least unexceptionable in taste, though it hardly deserves the admiration it has obtained. Among his other works, Lord Grimston's seat at Gorbury is one of the best. If not very great, he was eminently successful, in his profession, and obtained several lucrative appointments and surveyorships to the Admiralty, Foundling Hospital, Greenwich Hospital, and the Bank of England, for which he was well qualified, being a man of most business-like habits, and of most extraordinary diligence and assiduity. He was rarely in bed after four in the morning; was most abstemious in his diet, and drank no wine. Whether in consequence of taking warning from his father's example or not, he seems in almost all respects to have been the very reverse of him in his mode of living; and it is not surprising that his economy, together with the appointments which he held, should have enabled him to realize a fortune of 180,000*l.*, though, as he himself used to say, he began the world with hardly eighteen pence. He died at his own house in Spring Gardens, September 27, 1788, and was buried in St. Martin's church. He gave the whole of his property to his only son, the late Michael Angelo Taylor, M.P., with the exception of a sum to the university of Oxford, to accumulate for a certain term of years and then to be applied to found an institute for the study of modern languages. This bequest having been incorporated with a similar one by Dr. Randolph for a picture and statue gallery, a building was begun in 1841, under the name of the 'Taylor and Randolph Institute,' from the designs of C. R. Cockerell, Esq., professor of architecture at the Royal Academy. Taylor was knighted when sheriff of London in 1783.

(*Gentleman's Magazine*; *Cresy's Milizia*; *Dallaway's Arts in England*; *Companion to Almanac*, 1842.)

TAYLOR, THOMAS, was born in London on the 15th May, 1758: his parents were respectable in their calling, but not wealthy. At a very early age he was sent to St. Paul's school, and after remaining there about three years he was placed under the care of a relation who held a situation in the dockyard at Sheerness, with whom he resided several years. During this time he applied himself assiduously to the study of mathematics, and also obtained some knowledge of chemistry: he next became a pupil of the Rev. Mr. Worthington, a dissenting minister who possessed considerable classical acquirements, ultimately intending to complete his studies at Aberdeen with a view to the ministry. But a premature marriage and pecuniary difficulties compelled him to relinquish this plan, and to accept a junior clerkship in Messrs. Lubbock's banking-house. While in this employment he devoted his spare hours to the study of Plato and Aristotle and their commentators. At this time, and to the end of his life, Mr. Taylor always devoted at least six hours of every day to study, and when not engaged in business they were generally the first six. Poverty, and the difficulties attending it, were no obstacles to him, and he always hoped to emerge from the obscurity they placed him in. He first attracted public notice by an attempt to discover the secret of the perpetual lamp, upon which he gave a lecture and exhibited his experiments at the Freemasons'

Tavern. Though it was a failure, it was marked by some ingenuity and great and curious research: it made him some valuable acquaintances, who encouraged him in another undertaking, which was to deliver a course of lectures on the Platonic philosophy. Introducing himself by such means, he was enabled to procure pupils, to whom he taught the languages and mathematics, having also been appointed to the office of assistant-secretary to the Society for the Encouragement of Arts, Manufactures, and Commerce, which he held for several years: he of course gave up and was glad to be emancipated from the less interesting labours of the banking-house. It was in this situation that he made a more extensive acquaintance among learned and scientific men of all professions, and among men of various ranks who are promoters of arts and sciences, than usually falls to the lot of an obscure individual: but he made something more than mere acquaintance; he acquired many friends who were able and willing to assist him in all his undertakings, and with whose help he finally accomplished all that he had in view, which was to translate the works of all the untranslated ancient Greek philosophers. It was an arduous task for one man, and apparently a hopeless one, seeing that Sydenham, with the advantage of a more regular education, being a graduate of Oxford, and a known and acknowledged scholar, had not only failed in his desire to impart knowledge to his less learned countrymen by means of translations, but had been suffered to perish in the attempt for want of patronage, 'to the sorrow and shame (as his biographer says) of every friend of literature:' yet Sydenham was a good man, highly respected, and had many friends, or believed he had: he must have been a recluse, for the circumstances of his death seem to have caused surprise. Mr. Taylor was fond of society, and always in it: there was no appearance of abstraction about him; and a stranger would not have suspected him of being studious; he was always ready to join in conversation with any one who happened to be near him, and upon any subject: there were few subjects upon which he had not read, and he could always amuse or instruct if required. Being gifted with a very extraordinary memory, he not only retained the immense store of knowledge he had amassed, but he could bring it all into use at his will: he was deeply read in things that many like to hear of, though they are no longer studied, sorcery, witchcraft, alchemy, &c. and his fund of anecdote was quite inexhaustible: all this, joined to simple and unobtrusive manners, and irreproachable conduct, made him not only an agreeable companion to many, but to some he became almost a necessary one. Men whose occupations had prevented their reading, though they were desirous of knowledge, were particularly delighted with the company of Mr. Taylor, and such were his great supporters. It was by making friends chiefly that Mr. Taylor, who was as poor as Sydenham, contrived to print works that must have cost more than 10,000*l.*, that were not of the most saleable description, and that upon the whole produced no pecuniary profit. The duke of Norfolk printed Plato, and from some unaccountable whim locked up nearly the whole edition in his house, where it remained till long after his decease, but he was attached to Mr. Taylor, and frequently made him his companion at Arundel. Mr. Meredith, a wealthy tradesman retired from business, was a man possessed of sound mental faculties, with no aversion to exercise them. Having read Plato he wished also to read Aristotle in an English translation, and Mr. Taylor was ready to help him to it upon no other condition than his undertaking to print it, which he did: and though he made a losing speculation of it, by printing too few copies, he was so well satisfied with Mr. Taylor's exertions, that he not only assisted him in bringing out some of his minor publications, but settled a pension of 100*l.* a year upon him, which he enjoyed till his death: such munificence and friendship in a man who had earned his money, and knew the value of it, is truly honourable. Mr. Meredith, though not versed in the ancient languages, obtained a great knowledge of ancient literature: he was a man who thought for himself, and came to just conclusions upon most subjects. Among Mr. Taylor's minor works some will be found dedicated to persons who printed them upon similar terms, and in a few cases gave him the benefit of the whole edition. He never exacted payment for his labour, except in one or two cases with the booksellers,

and then he had little enough. But with such means I over all his difficulties, and he had some, for he was married and had several children; his income at that time was about 200*l.* a year. There are some persons who are not at all pleased with Mr. Taylor's attempt to correct certain ancient opinions: they neither wished to see of the works he has translated, nor his remarks upon them in English; but they are the very persons who brought writers into notice by constantly referring to their speaking of them in terms that are neither liberal nor fairly merited. These writers were the supporters of ancient opinions and establishments, the failure of which is now complete and past recovery: there can be little to object to in their writings, and so much that is good and worth preserving. For these reasons they found translators in every civilized country but England. It seems then that our professed scholars have done their duty to the public: if they had given us translations with their own annotations, the labour of Mr. Taylor would not have been called for, and the remarks he might have made elsewhere would have had little weight, and have been overlooked. There are many important works yet untranslated, and there are many translations which are disgraceful to the literary character of our country: it is time then that our scholars should attend to these matters, and see that things which must and be done are well done.

Mr. Taylor, during the last forty years of his life, resided in a small house at Walworth, leading a life of perfect uniformity, and dividing his time between his labours and his attentions to his friends and family. He died on the 1st of November, 1835, of a very painful disease in the bladder, which he bore with extraordinary fortitude without complaining. He was an Academician by profession and a Stoic in practice; a sincere friend and a delightful companion. His works and translations are 1. 'The Elements of a New Method of Reasoning in Geometry,' 4to., 1780, a juvenile performance lost in the press; 2. a Paraphrase of part of Ocellus in the *European Magazine*, 1782; a translation of the same work in 1831, 8vo.; 3. 'The Hymns of Orpheus,' 1787; second edition, 1824, augmented; 4. 'Plotinus the Beautiful,' 12mo., 1787; 5. 'A Dissertation on Eleusinian and Bacchic Mysteries,' 8vo., no date; 6. 'Rights of Brutes,' 12mo., 1792, in ridicule of the *Pantheist*; 7. 'Rights of Man,' 7. 'Salutary on the Gods and the Poets,' 8vo., 1793; 8. 'The Phædrus of Plato,' 4to., 1793; 9. 'The Cratylus, Phædon, Parmenides, and Timæus,' 8vo., 1793; 10. 'Proclus on Euclid,' 2 vols. 4to., 1793; 11. 'Two Orations of the Emperor Julian to the Seven Sun and to the Mother of the Gods,' 8vo., 1793; 12. 'Pausanias' Description of Greece,' 3 vols. 8vo., 1794: for the translation, made in such haste that Mr. Taylor nearly lost the use of his right hand from continued exertion, received 18*l.* The work was in such demand that it was sold for a high price, and a second edition was printed in 1801 without consulting the translator, who heard of it accidentally, when it was too late to correct it: a slight compensation was made to him, and he added some notes to this is an illustration of the remarks already made; as if like this should not have been left to a necessitous author; 13. Five books of Plotinus, 'On Felicity: on the Nature and Origin of Evil: on Providence: on Nature, Contemplation, and the One: on the Descent of the Soul,' 1794; 14. 'Cupid and Psyche,' from Apuleius, 8vo., 1794; 15. 'Metaphysics of Aristotle,' 4to., 1801; 16. 'Hedonæus' Greek Lexicon,' edited, 4to., 1803; 17. 'The Dissertations of Maximus Triarius,' 2 vols. 12mo., 1804; 18. Answer to Dr. Gillies' Supplement to his New Arrangement of the Works of Aristotle, 8vo., 1804; 19. 'The Works of Plato,' 5 vols. 4to., 1804: including reprints of parts previously translated, and many commentaries from MSS., some of which have since been printed in their original language; 20. 'The Pythagoric Sentences of Iamblichus,' these are printed with Mr. Bridgeman's translations, 8vo., 1804; 21. 'Miscellanies in Prose and Verse,' 12mo., 1805, 2nd ed. 1820; 22. 'Collectanea,' 8vo., 1805; 23. 'The Emperor Julian's Arguments taken from the *Clæm* with Extracts from his other Works relative to the *Clæm* trans,' 8vo., 1809; 24. 'The Works of Aristotle,' 9 vols. 4to., 1812, with copious extracts from the ancient commentators, to which are added a dissertation on the philosophy of Aristotle, and a treatise on the elements

ithmetic of infinites, both of which had a separate form; 25, 'The Six Books of Proclusology of Plato,' 2 vols. 4to., 1816; 26, 'Theometric,' 8vo., 1816, containing what had been this subject by Theon of Smyrna, Nicomachus, and Boethius; with remarks on amicable numbers, and a specimen of the manner in which oracles philosophised about numbers; 27, 'Seof Plotinus,' 8vo., 1817; 28, 'Life of Pythamblicus,' 8vo., 1818; 29, 'Iamblicus on the Egyptians, Chaldeans, and Assyrians,'; 30, 'The Commentaries of Proclus on the Plato,' 2 vols. 4to., 1820; 31, 'Political Pythaments and Ethical Fragments of Hierocles,'; 32, 'The Metamorphoses and Philosophical puleius,' 8vo., 1822; translated gratuitously at of a friend, but purchased by a publisher Mr. Taylor had a few copies for his benefit; Works of Porphyry,' 8vo., 1823; some Essays 35, 'All the Fragments that remain of the gs of Proclus,' 8vo., 1825; 36, 'Arguments of ive to the Christians, taken from Origen, with m other Writers,' 12mo., 1830; 37, 'Proclus on and Evil,' 8vo., 1833; 38, 'Plotinus on Sui-extracts from Olympiodorus, and two books on ing Being, &c., with Notes from Porphyry and vo., 1834. Besides these, there are many ten by Mr. Taylor in the 'Classical Journal' periodicals, amongst which may be specified a id valuable collection of the Chaldean oracles, by Mr. Cory.

US THEOREM. [TAYLOR, BROOK.]

N. [TAI-WAN.]

LAKE. [SODAN, p. 249.]

VIGOV. [CZERNIGOF.]

THEA.]

IRAGUAY, or MATE', is the produce of a ig to the family Aquifoliaceæ. It was for- sed to be the produce of the *Ilex vomitoria*, and in North America, in the Carolinas, and Flo- rom specimens sent from Brazil to Mr. Lambert, to be a distinct species, which he has named *uanensis*. It is a shrub attaining the size of tree; it is quite smooth, with bluntish wedge- tly serrated leaves, with umbelliferous flowers he axils of the leaves. It is the *Ilex Maté* of re, and grows wild in Paraguay and Brazil, d by the Spaniards *Yerva Mate*. The leaves of e are in great repute amongst the inhabitants of rica, and are used in infusion in a similar man- ea of China. Upwards of 5,000,000 lbs. of the is tree are annually collected in Paraguay, and Chili and the viceroyalty of Buenos Ayres. It vated, and merchants carry various articles of e interior, which they give the natives for their ollecting the leaves of the plant. After the re cut away, the ground is heated by means of e branches, being laid upon the heated ground, nd afterwards they are beaten and pressed into ich state it comes into the market. There are known in the market: the *Cua-cuys*, which is the leaf; the *Cua-mini*, the leaf torn from its veins without roasting; and the *Cua-guazu*, e *Palos* of the Spaniards, the whole leaf with the d small branches roasted. The first does not and is seldom seen. The plant when used is boiling water, to which a little sugar and some- juice is added. It is drunk out of a vessel t, which has a spout perforated with holes for of preventing the powdered herb from passing e fluid. The Creoles are passionately fond of n, and never partake of a meal without it. The of this plant are sedative and stimulant.

A species of *Ilex*, the *I. Gonghona*, found in applicable to the same purposes as the last; gh inferior in quality, was used extensively as a or the true Paraguay tea, when the export of the Paraguay was forbidden by the dictator Francia. *vomitoria* produces the *Cassena* of Florida and as, which is used for the purpose of correcting of water.

[TECTONA.]

Querquedula crecca, Steph.; *Anus crecca*, Linn.),

one of the smallest of the *Anatidæ*, and most beautiful of the Ducks, in which article will be found Mr. Swainson's observations on the subgenus denominated *Teals*, together with a description of the *Blue-winged Teal*.

Description of the *Common Teal*.—*Adult Male*.—Top of the head, cheeks, and neck of a deep chestnut; throat black; a broad band of fine glossy green passing from the eyes to the back of the neck, bordered by a pale margin inclining to yellowish; head and cheeks chestnut; back, scapulars, and flanks zigzagged with irregular alternate lines of black and white; breast and under parts yellowish-white, but the breast is spotted with blackish; wing-coverts brown; beauty-spot (speculum) rich glossy green, deepened at the sides into a velvety black; quills brownish-black; under tail-coverts buff, with a longitudinal black band; bill black; iris brown; legs blackish-brown.

This is the nuptial dress; but, in July and August, this brilliant livery is exchanged for the more sober hues of the *Female*.—Top of the head Sienna yellow, with dashes of deep brown; throat and cheeks dusky white, sprinkled with brown spots; plumage above tarnished or dull brown, each feather with a margin of a lighter colour; under parts yellowish-white; beauty-spot green.

This is the *Sarcelle*, *Petite Sarcelle*, *Cercelle*, *Cercerelle*, *Alebrande*, *Garsote*, and *Halebran* of the French; *Cercedula*, *Cercevolo*, *Scavolo*, *Sartella*, *Anitrellu*, and *Anitra d'Inverno* of the Italians; *Spiegel-Entlein* and *Krickente* of the Germans; *Winter Tuling* of the Netherlands; *Arta* and *Kræcha* of the Swedes; *Kestelort-And* of the Norwegians; *Krik-And* of the Danes; *Cor Hwyyad* and *Brach Hwyyad* of the antient British.

Habits, Geographical Distribution, &c.—Mr. Yarrell, in his 'British Birds,' now nearly complete, and forming a most valuable addition to British ornithology, thus sums up the information extant relative to the habits and locality of this pretty species, which he notices 'as an early and constant winter visitor, making its appearance by the end of September, sometimes sooner than that, and remaining with us till spring has made considerable progress; their numbers are constantly recruited through the winter months by additional arrivals from the northern parts of Europe, and our markets in consequence obtain a regular supply from the various decoys and other modes of capture. Although numbers in spring return again to more northern localities to breed, many remain in this country and pass the summer near fresh-water lakes. That some of them breed here also, in suitable localities, is proved by the fact that, in the summer of 1817, Mr. Youell of Yarmouth had four young birds of the Teal brought to him, which were hatched at Reedham in Norfolk. The authors of the Catalogue of Norfolk and Suffolk birds say also that very small ones have been obtained in company with their parents upon Ranworth Broad, by Mr. Kerrison of that place; and that they breed also on Scoulton Mere. The Rev. Richard Lubbock of Norfolk, in his note to me on this species, says, "the Teal must, in some years, either breed abundantly with us, or migrate hither very early: I have known sixty or seventy Teal come in small parties to the same splash of water at sun-down by the first week in August." The Teal bear confinement well; and at the gardens of the Zoological Society, though restricted to a very small pond, with a margin of thick and high grass, with some low shrubs, have bred regularly for the last five seasons' (Feb., 1842). The eggs are white, tinged with buff, measuring one inch three lines in length, by one inch four lines in breadth. The food of the Teal consists of seeds, grasses, water-plants, and insects in their various states. In confinement they require grain. Some Teal breed about the lakes of Wales, and a few in Romney Marsh. Mr. Selby, who has paid attention to the habits of this species in Northumberland, says, 'our indigenous broods, I am inclined to think, seldom quit the immediate neighbourhood of the place in which they were bred, as I have repeatedly observed them to haunt the same district from the time of their hatching, till they separated and paired on the approach of the following spring. The Teal breeds in the long rushy herbage about the edges of lakes, or in the boggy parts of the upland moors. Its nest is formed of a large mass of decayed vegetable matters, with a lining of down and feathers, upon which eight or ten eggs rest. Dr. Heysham, in his catalogue of Cumberland animals, says that a few Teal certainly breed in the mosses of that county every year.'

White, in a letter to the Hon. Daines Barrington, dated Selborne, July 8, 1773, says, 'Some young men went down lately to a pond on the verge of Walmer Forest to hunt flappers, or young wild ducks, many of which they caught, and, among the rest, some very minute, yet well-fledged wild fowls alive, which, upon examination, I found to be teals. I did not know till then that teals ever bred in the south of England, and was much pleased with the discovery: this I look upon as a great stroke in natural history.'

But to return to Mr. Yarrell, who thus proceeds: 'In Ireland the Teal is found in great numbers throughout the winter, and a few are resident there all the year. Sir Robert Sibbald, and other authorities since his time, notice the teal as inhabiting the edges of the Scottish lakes; Mr. Dunn however says that it is not numerous either in Orkney or Shetland, although the most so in winter; but that a few pairs occasionally remain during summer and breed. They prefer the inland lakes to the sea-shore. Richard Dunn, Esq., sent me word that this beautiful little duck is widely and numerous dispersed over the whole of Norway and Sweden, but is most plentiful in the north during the breeding season. It breeds all over Lapland, both western and eastern, and is very abundant in the Dofre Fiell, within the range of the birch-trees. The eggs vary in number from ten to fifteen. It breeds also in the cultivated districts in all the mosses and bogs. Mr. Proctor says the Teal is pretty common in Iceland. Eastward of Scandinavia it is found in Russia, and is abundant in Germany, Holland, France, Spain, and Italy; visits North Africa in winter, and has been noticed at Smyrna and Trebizond. The Teal was found in the vicinity of the Caucasian range, by Russian naturalists, and is included in catalogues of the birds of various parts of India, China, and Japan. The Teal of North America is distinct from the Teal of Europe and Asia.' (*British Birds.*)

Mr. Gould, in his great work, 'The Birds of Europe,' remarks that M. Temminck names Northern America as among the native localities of the Teal; but Mr. Gould says that he is inclined to dissent from this opinion, for the American examples may always be distinguished by a white crescent-shaped band on each side of the chest near the shoulders. This, together with the absence of the white tertial feather, will constitute, he thinks, fair grounds for a genuine specific distinction.

M. Temminck, in the fourth volume of his 'Manuel,' has himself corrected this error, acknowledging the difference, and referring to Dr. Richardson, 'Fauna Boreali-Americana,' vol. ii., p. 443.

The teal flies vigorously. Drayton, in the 'five and twentieth song' of his 'Polyolbion,' alludes to this power. After celebrating the Duck and Mallard, he continues:—

'And neere to them ye see the lesser dibbling Teale,
In bunches,* with the first that fly from mere to mere,
As they above the rest were lords of earth and ayre.'



Common Teal, *Querquedula crecca.*

Utility to Man.—This species is one of the most delicate of the ducks. Willughby remarks, that for the taste of its flesh, and the wholesome nourishment it affords the

* The word in Falconry for a company of Teale.

bo'y, it 'doth deservedly challenge the first place those of its kind.'

In the 'Portraits d'Oyseaux' (1557), the folio train celebrates its excellence and alludes to its

'Bien peu souvent se plonge la merueille
Entre deux eaux, de laquelle le chair
Est delicate: ainsi couste elle chier
Autant qu'oyseau, qui soit petit comme elle.'

Accordingly we see it holding a high place in feasts. We find it among the 'goodly provision' banquet given at the enthroning of George the bishop of York, in the reign of Edward IV.: 'and Teales, 4000.' The price, in the North Household Book, is 'Teylles, 1d.,' mallards but

In the provision for the marriage of Roger Elizabeth Nevile, 14th January, 17th Henry appear among the dishes for the first course 'Teals, 7 of a dish;' and in the account of the week for flesh and fish for the same mallards and Teal, 30 dozen, are charged '£3 11 in the charge of Sir John Nevile of Chete, the bride above mentioned, at Lammas assizes, in Henry VIII., he then being sheriff of Yorkshire 42 shillings charged for 'Mallards, Teal, and fowl.'

TEAM. Nothing is of greater importance in the management of a farm than the cattle which do the necessary work in ploughing and other operations on the soil, in drawing manure to the land and carrying produce to market. It is evident that the smaller the team which does the requisite work in the field, the greater the profit of the farmer, and every part of the expense of cultivation is so much to the clear gain. Wherever the land is only cultivated, and a portion of it remains in rough ground which costs little or nothing to the occupier, or where extensive open commons afford cheap food for the stock, and last are naturally employed in farm labour, oxen do only the work of two horses, they are maintained at much smaller expense, and, after working for a few years, their value is improved for the purpose of the butcher. The necessary gear is much less expensive, especially where the old yoke is still in use across the neck or the horns. In fact for a poor farmer who has only a few acres of land, and who is situated on a waste or common, oxen, and even cows and heifers, are by far the most economical team. Many writers on agriculture, who in general have more theoretical than practical knowledge of husbandry, have maintained the superiority of an ox team over that composed of horses, and have given calculations which appear clearly to establish their point. But, on the other side, it is to be served, that wherever arable land is the chief object of the farmer's attention, and the tillage of the soil to any degree of perfection, there oxen are never used, but have been invariably superseded by horses.

It has been urged that at Windsor Park, where it has been supposed that the farms in which George I. took much interest were conducted by the most experienced agriculturists, a considerable team of oxen was employed in most of the work, even the carrying of manure. This is a confirmation of what we have observed. The oxen feed on the grass of an extensive park, of which it is not brought to account. They are worked, and fatten well after two or three years, but if a rent had to be paid for their pasture, or if it had been calculated how many young oxen and heifers could have been kept on the pasture, and the profit of these were set against the cost of the work done, it would probably appear that the great economy in the ox-team compared with that of horses in Switzerland, which is tolerably advanced in agriculture, oxen are very generally used for the work on the farm; but there the system of stall-feeding is not used, and having a considerable portion of grass-land which can be irrigated by the streams from the mountain, the coarse long grass produced there for the use of oxen; and this food is more congenial to them than to horses, which do not thrive on coarse wheat and require hay and corn nearly all the year round where there is less grass-land and more artificial grass such as lucerne, sainfoin, and clover, which is the case

On farms, there horses are chiefly used, this food being to their constitution. Not to enter further into the relative advantage of oxen and horses, we shall turn attention to the most profitable management of the which now almost universally compose the farmer's

choice of the horses for a farm is of great import-

It may be very satisfactory to a rich farmer to see a large well-fed horse in his waggon, moving along as if followed a procession, with bright harness ornamented with shining brass. This is a luxury like that of a nobleman's coach-horses, and as such is very natural and innocent. It is the pride of many a wealthy yeoman, and he would not curtail his pleasure or despise his taste; but as a matter of profit or loss the case is very different: a horse does little work, no more than a fat coachman, and to be in working condition should be muscular and

The great heavy cart-horse may, for a moment, be capable of a greater exertion at a dead pull, his weight pressing him; but in a long day the thin active horse will bear the ease what would sicken, if not kill, his heavy companion. Horses about fifteen hands high, with short and broad chests, such as the Suffolk punches, which are as fast as an ordinary man, or the active Scotch horses which have more blood and will readily trot under a moderate load, are the most economical for farm-

A pair of such horses will draw a load in a cart four miles and return, or plough a Scotch acre of equal quality to one acre and a quarter imperial measure, in working hours, having a rest of two hours; while the slow South-country horses could not walk the distance the time without being over-driven. This is more the average work; but in the busy time of the year it is a great advantage to have horses which can, with good management, work longer and faster without suffering in their health. The carriers on the roads, who live entirely by the work of their horses, know how to choose them and to feed them to the greatest advantage, and, without overworking them, to make them do as much as is consistent with their health. If hard work is the cause of disease in horses, comparative indolence causes

Where horses are sluggish, the men soon become so likewise. To see a waggon with four strong horses returning empty, at the rate of two miles in the hour with two men, or at least a man and a boy, lying in it, is a sure sign that the work on the farm to which they belong is done at the same rate. A single horse, or a light spring waggon with two horses, driven by a man or boy with reins and a whip, and trotting at the rate of five miles an hour, is a perfect contrast to this, and the owner has his work done much more expeditiously, and consequently at a cheaper rate. The stage-proprietors have generally very light four-wheeled carriages to carry their corn from their chief stations to where they keep horses, and they often carry as heavy a load as a farmer's waggon does when carrying corn to the farm, yet the two horses in the light carriage trot with ease, and the three or four heavy horses of the farmer are at the rate of two miles and a half in the hour at the same going and returning. It is evident that there is a great saving of time and power here, which is so much lost

in the case of a horse bred between a cart-mare and a blood-horse, and used by some spirited farmers, and if they are more nervous and susceptible of cold than the common cart-horse they have many advantages: sometimes they inherit much courage and vigour from their sire, that they are valuable as carriage-horses or hunters, and well able to bear the expense incurred in rearing them; and at all times they are superior to any others for the work of the farm, and are in general docile and tractable. The only objection arises from their spirit. When any sudden excitement arises in ploughing, such as a considerable root or a large stone, they make violent exertions, and sometimes break the ploughs or other implements. In the case of oxen they are more phlegmatic, and stop when the driver presses on them; so that in breaking up rough corn or newly cleared woods oxen may be preferred, almost the only case where spirit and courage are advantages.

In respect to the food of farm-horses, as we observed in the case of a great saving may be effected by a judicious use of vegetables and roots which are easily raised on the farm. Various modes of preparing the food have been

been recommended, such as steeping corn till it sprouts, baking it into bread, or mixing it with boiled roots. All these may have their advantage where economy is the object; but, with the exception of baked bread made of rye, barley, and oats, and slightly leavened, which is perhaps the best food which can be given to slow-working horses, there is nothing so congenial to the healthy stomach of a horse as good hay and dry oats, or beans bruised in a mill and mixed with cut chaff. They require no cooking to be fully digested, and the digestive power of the horse will extract all the nourishment which they contain. But there are cheaper fodders than hay and corn, especially in summer, when they can be given fresh and green. Tares, clover, lucern, and sainfoin, cut as they are wanted, will keep a horse in health and working condition with little or no corn, and at a comparatively trifling expense; carrots are peculiarly relished by horses, and are very wholesome; and Swedish turnips, or ruta бага, given raw in moderate quantities make their skins shine, and thus prove that they tend to keep them in condition. Every prudent farmer takes care to have a sufficient supply of these cheaper substitutes for hay and corn, keeping these last as a reserve and auxiliary to the former. In a prize Essay of the Highland and Agricultural Society on the comparative advantages of raw and boiled grain as food for farm-horses, the author adduces some experiments, which lead to the conclusion that there is no advantage in boiling grain, but rather the contrary. The cost of keeping a horse per day on different food has been given as follows:—

10 lbs. of straw cut into chaff . . .	1d.
10 lbs. of oats, at 3s. per bushel . . .	9
16 lbs. of turnips, at 10s. per ton . . .	1
Expense of cutting . . .	1½
	<hr/>
	1 0½
or—16 lbs. of hay, at 3s. 6d. per cwt. . .	6d.
5 lbs. of oats, at 3s. per bushel . . .	4½
16 lbs. turnips, at 10s. per ton . . .	1
	<hr/>
	11½
or—28 lbs. of steamed turnips . . .	3½d.
7 lbs. of coals, at 1s. per bushel . . .	1
Expense of steaming . . .	½
16 lbs. of straw, at 1l. per ton . . .	1½
	<hr/>
	6½

This last appears the most economical food, but steamed turnips and straw only would probably not keep a horse in good working condition, and it is not said how long the experiment was continued, nor whether the horses thus fed lost weight. The food is also valued at a low rate.

It is evident that if farm-horses can be kept in condition for 6½d. a day, which is not 4s. a week, while on hay and oats, in the common mode of feeding, they will cost more than double that sum, the saving in a year would amount to nearly 10l. on each horse; and as every twenty-five acres of a farm of moderately light land will require one horse for its cultivation, there will be a saving of 8s. per acre, probably half the rent, and more than half the profit. However this may be, there is no doubt that it is of great importance to ascertain what is, on the whole, the best and cheapest mode of feeding farm-horses; and without entering into minute calculations, it will be found that various artificial grasses may be made to succeed each other, by successive sowings, so regularly, that the horses shall be kept for six months of the year entirely on succulent green food, which will enable them to do all the necessary work, and keep them in good health and condition. Thus with the help of carrots, potatoes, and ruta бага, a great saving of hay and oats may be effected in winter, and these crops will take up much less land for their production than hay and oats, and exhaust the soil less; if we except potatoes, which are more profitably used as human food or to fatten pigs.

The example of tradesmen and manufacturers who keep horses, and cut all the hay which they use into chaff, mixing it with oats, may be good for a farmer to follow, where hay is scarce and beans a good price: but otherwise it is fully as economical to give the hay in racks, provided no more be given at once than a horse will eat up entirely,

and a certain ration be allowed for each horse, which experience has shown to be sufficient. In the cavalry, where great attention is paid to economy, the horses have their rations of hay, oats, and straw according to the exercise they take, or the fatigue they are exposed to: so likewise it should be with a farmer's team. In the old mode of feeding horses with as much hay as they would eat, and two bushels of oats for each horse per week, during at least nine months in the year, and giving them tares or artificial grasses between spring sowing and harvest, when there was less to be done, the expense of a horse was much greater than most farmers could now afford: and more land was devoted to the keep of the team than was necessary. The following is the calculation of the cost of the keep of a horse in this way:—

	£	s.
32 weeks, at 2 bushels of oats per week, at 3s. 6d. per bushel	11	4
20 weeks, at 1 bushel of oats per week, at 3s. 6d. per bushel	3	10
Tares 20 weeks, at 6s. $\frac{1}{2}$ of an acre per week)	3	0
Hay 32 weeks, 1½ cwt. per week at 4s. per cwt.	9	12
Shoeing	0	15
Farrier	0	5
Total	£28	6

The hay and oats are at high prices, but at all events a horse cannot be kept in this way under 10s. per week. They are then however in excellent condition, and able to work ten hours per day in summer and eight in winter.

On poor land, where gorse or furze grow readily, a very cheap food is obtained by bruising or crushing the young shoots of the gorse to destroy the sharp spines which injure the mouths of the cattle. Horses reared in large commons are often seen beating the sharp spines with their feet, and then eating it greedily: instinct here teaches them to prepare their own food; and, if they have a sufficient quantity of it, they get fat and in good condition.

It is of great importance to a person about to hire a farm to know exactly what number of horses will be required for its proper cultivation, and this depends upon many circumstances which must all be taken into consideration, and which will make a very material difference, often as much as half the rent of the land. He is to consider the situation of the farm-buildings, especially the stalls and cattle-yards, where the manure is to be made, with respect to their distance from the fields; the state of the roads and the access to the fields; the distance of a good market-town, and whether the fields lie in a ring-fence or are scattered. A farm of good light loam will require one horse for every twenty-five acres for its cultivation, with an additional one for every 200 acres: that is, 9 horses for 200 acres. The additional horse should be lighter and more active than the rest, for the farmer to ride on and to drive in a light cart: yet it should be capable of supplying the place of any of the others in case of illness or accident, or when extra work is required, as in harvest or seed time. The larger the farm, or rather the fields, the fewer horses are required in proportion to its size, because much time is lost in turning the plough where the furrow is short; and ploughing is always the principal work of the team. If more than two horses are required to plough the ground, the soil must be very compact and heavy, and if this is not compensated by greater fertility, the expense of the horses will much reduce the profit of the farmer. It is the custom in some farms for each ploughman to have the charge of his own horses: but it is far better to make the feeding and cleaning of horses the business of regular servants, who should sleep in or near the stables, and rise very early, so that the horses may be fed and ready to go to work as soon as the ploughman comes. When a man has been eight or ten hours holding a plough, he is not so capable of cleaning and rubbing the horses as one who has only had light work in the day. The horse-keepers can prepare manure, make composts, cut hay and straw into chaff for the horses, mow tares or other green food, or hoe the crops in the season while the horses are at work, and the last thing before they lie down at night should be to give the horses their proper ration of hay and see that their beds are comfortable and everything in proper order in the stables: good grooming is of as great use

to a horse as good feeding, and without it they will not be in perfect working condition. The harness should always be cleaned and oiled, and hung up in a separate place, not, as is too commonly done, hung up behind the horses in the stables. There should be no unnecessary ornaments, but strength and simplicity should be studied. The weight and size of the collars is in many places about: they cannot be too light, provided they are of sufficient strength. The work in the field when the days are long should be divided so as to give the horses at least two hours rest, during which they should be fed with bread or corn. When the fields are near the stables the horses may be brought home, but a portable manger is easily carried into the field, such as is used at the inns on the roads where carriers stop to bait. In winter it may be as well to finish the day's work with only an interval of half an hour. The time in summer should be from 5 in the morning till 10, and from 2 till 7 if the weather is very warm, resting 4 hours: or from 6 till 11 and from 1 till 6, resting 2 hours. In winter the time is from 7 till 3, resting half an hour or an hour between 11 and 12. With good feeding and grooming this is by no means too hard work when the work requires to be carried on briskly. The heavier and lighter kind of work should be so arranged that when horses have worked hard for a day or two, they may have one or two days of lighter work. In most parts of England the pace of the horses and their daily work are much less than in Scotland: two horses should plough an acre a day or more, on an average, but few farmers can get much more accomplished than three-quarters of an acre, if they plough a good depth or break up clover or grass lays. In the light sands of Norfolk and Lincolnshire they go over much ground; but there the furrows are wide and shallow, and the horses might easily 1 with the plough if the ploughman could keep up with them. In Flanders such land is ploughed with one horse only; and the work is well done. There is yet much room for improvement in the use and management of the team on most farms in England.

TEANO. [LAVORO, TERRA DI.]

TEARS. [EYE, p. 142.]

TEAZLE (*Dipsacus Fullonum*) is a plant which is wild in the hedges, but an improved variety is carefully cultivated in those districts of England where cloth is manufactured. It is used for the purpose of forming a species of brush with which the finer hairs of the wool fabric are drawn to the surface, where they produce what is usually called the nap of the cloth. The teazle has a fine hooked awn, which very readily insinuates itself into the woollen web, and draws out with it some of the fine fibres of the wool; these are afterwards shorn smooth, and leave the cloth with the fine velvet-like nap which is its peculiar appearance. A further account of the operation of teasing, in the woollen manufacture, is given in Ure's 'Philosophy of Manufactures,' p. 192.

Teazles will grow in any soil; but they grow strongest and best in a stiff loam. They require the soil to be in good heart, and are supposed to exhaust it much; but no great portion of manure is required to obtain a good crop. Like all the tribe of thistles, they grow best on ground newly turned up from grass which has lain some time, and the same ground will not again produce them of so good a quality till after a considerable interval. The wild teazle which grows in hedges appears at first sight to be the same as the cultivated variety: but it is of no use to the cloth-worker from the weakness of the awns, which break off, instead of drawing the wool out of the surface of the web.

The growing of teazles is a peculiar trade, and a kind of speculation. The teazle-grower hires a piece of ground suited to his purpose from the farmer for two years, and pays a considerable rent. If the ground is broken up from grass, it is ploughed as deep as the staple of the soil permits, and as early as possible, if before winter so much the better: the ground is laid in narrow stitches, on which the seed is drilled in April, in rows from 12 to 15 inches apart: moisture is necessary to make the seed germinate. As soon as the plants appear, they are thinned out, and the intervals carefully hoed and weeded. During the summer, the ground is several times dug, or spaded, as it is called, to a considerable depth, with very narrow and long spades: this greatly invigorates the plants. In November, some plants may be transplanted from where

land too thick, to the places where they have failed. should stand about a foot apart in the rows. During sowing spring, the cultivation is repeated, and earth is thrown up to the plants, but without burying the stems.

They soon begin to push up their stems, and are cut in July, just when the blossom has fallen. They do not come to proper maturity at the same time, and successive gatherings are made. They are cut with a sharp knife about nine inches below the head, and are made up into small bundles or handfuls: thick gloves are very useful in this operation. They must be carried under cover before night, as the rains or heavy dews would injure them.

When the sun shines, they are exposed to dry in the same manner as is done with onion seed, and they are packed close until they are perfectly dry. When they are usually hung on poles; so that the air may circulate between the bundles. The bundles are afterwards opened, and the teazles sorted into kings, middlings and scrubs, according to their size; 9000 kings or middlings make a pack. The scrubs or refuse are of little value: sometimes the grower places a certain quantity in a flat bundle by means of cleft sticks, in which the teazles are held and the heads spread out like a fan. It is stated that they are not only more easily packed, but are more readily fixed to the circumference of the drum, on which they form a continuous card, which brushes the wool as it is drawn along while the drum revolves.

Teazles are a very precarious crop; sometimes they produce a very great profit, and at other times a serious loss. The cultivation lessens the chances of failure greatly: the price also fluctuates so much that it is an uncalculating speculation, resembling in this respect the cultivation of hops. Hence it is undertaken by men who are prepared for the event, and who make the profits of one year at the expense of another.

Several attempts have been made to substitute artificial teazles, formed of hooks of very fine and elastic steel wire; but one time there was so much appearance of success, that the cultivation of teazles was neglected: but soon after it was found that the wires tore the fine fibres of the wool, especially where there were knots in the thread, and the hooks of the teazles gave way, and either broke off before the fibre of the wool was injured. A card made of natural teazles was found far superior to artificial substitutes, and for a time the price of teazles rose to an extravagant height from their scarcity, while the price of wool fell before they were quite unsaleable. A quantity of teazles which was sold at one time in Berkshire for 5*l.*, was afterwards thought perfectly useless, was taken into Gloucestershire, and there produced the next year 150*l.* The grower of teazles had, and they were sold by his executors for what would fetch. This was exactly at a time when the price of wool cards were given up, and no teazles were to be had. A good crop of teazles is about 10 or 12 packs on an acre; this is sometimes exceeded, but more often it fails by one-half, and a total failure is not uncommon. The average yield may be six or seven pounds a pack, so that a crop is worth more than the land it grew on. The price of teazles, however, are great, and, taking all the chances, it is a speculation which, except in very particular situations and circumstances, is not suited to the regular farmer, who should speculate to any extent.

Teazles are said to exhaust the ground much, and in the continual stirring of the soil they render it very hard for other crops, provided a proper quantity of manure is used: thus very good crops of wheat have been raised after a crop of teazles.

A piece of fine broad-cloth requires from 1500 to 2000 teazles to bring out the proper nap, after which the teazles are useless, the hooks being mostly broken off or cut. This causes a considerable demand for them in the neighbourhood of cloth manufactories, as in Wilts, Wiltshire, and Somersetshire. In the new tariff the price is 3*l.* per thousand, whether from foreign countries or from the possessions.

TIBALDEO or **TIBALDE'O**, **ANTONIO**, born at Mantua about 1463, studied medicine, but afterwards devoted himself chiefly to literature and poetical composition in Italian and Latin. The first edition of his Italian works appeared at Modena in 1498, by his cousin Jacopo Tebaldeo, apparently unknown to the author, who was mistaken at it because he thought that his compositions required some final touches: 'Sonetti, Capitoli, e Rime,

chiamate Opere d'Amore,' 4to., Modena, 1498, afterwards reprinted several times at Milan, Venice, and other places. In 1519 appeared at Milan another small poem of Tebaldeo, with the title, 'Stanze nuove ad un Vecchio che non amando in gioventù fu costretto ad amare in vecchiezza.' A correct edition of Tebaldeo's works is however still wanted. A selection from his pastoral poems has been inserted in the collection entitled 'Poesie Pastorali e Rusticali, raccolte ed illustrate con note dal Dottore Giulio Ferrario,' Milan, 1808. Bembo and Giraldi, contemporaries of Tebaldeo, speak of his Italian poems with praise, but they regret that they were too hastily published. Tebaldeo afterwards applied himself to Latin poetry, in which he acquired great reputation. He was for a time at the court of Mantua, and afterwards settled at Rome, where he became a favourite of Leo X., who speaks very highly of him in some of his epistles, and is said to have made him very liberal presents. After Leo's death Tebaldeo fell into distress, and was obliged to borrow money of Bembo and others. He died at Rome in 1537. A few of his Latin epigrams and other small poems are in several collections.

(Tiraboschi, *Storia della Letteratura Italiana*; Zeno, *Note alla Biblioteca dell' Eloquenza Italiana del Fontanini*.)

TECTIBRANCHIATA, Cuvier's name for his fourth order of Gastropods, described by him as having the branchiæ attached along the right side, or on the back, in form of leaves (feuillettes) more or less divided, but non-symmetrical. The mantle covers them more or less, and contains nearly always in its thickness a small shell. The *Tectibranchiata* approach the *Pectinibranchiata* in the form of the organs of respiration, and live, like them, in the waters of the sea, but they are all hermaphrodites, like the *Nudibranchiata* and the *Pulmoniferous mollusks*.

The following genera are comprehended, by Cuvier, under this order:—*Pleurobranchus*, Cuv.; *Pleurobranchæa*, Meckel (*Pleurobranchidium*, Bl.); *Aplysia*, Linn.; *Dolabella*, Lam.; *Notarchus*, Cuv.; *Bursatella*, Bl.; *Akera*, Müll.; *Gastropteron*, Meckel; and *Umbrella*, Lam.

Of these *Pleurobranchus*, *Pleurobranchæa*, and *Umbrella* are treated of in the article *SEMIPHYLIDIAN*s; and *Akera* or *Acera*, and *Gastropteron* or *Gastroptera*, under the article *BULLADÆ*. *Aplysia* or *Laplysia* (for Linnaeus writes it both ways), *Dolabella*, and *Notarchus* therefore remain to be noticed here.

Aplysia.

M. de Blainville thus defines the *Aplysians* (*Aplysiaceæ*) the second family of his *MONOPLEUROBRANCHIATA*:—

Body not divided, or forming a single soft fleshy mass; four tentacular appendages always distinct, flattened, auriform; the mouth in the shape of a vertical slit, with two lateral subcorneous labial plates, and a cordiform tongue beset with denticles; eyes sessile between the two pairs of tentacles; the branchiæ covered by a sort of operculum; orifices of the generative apparatus more or less distant, and united together by an external furrow.

Shell null or incomplete, constantly internal.

M. Rang's definition is—

Animal not divided, furnished with four tentacles with eyes at their anterior base, and sometimes with membranes proper for swimming; the branchiæ in form of a plume, in a dorsal cavity, protected most frequently by a free operculum at the right side, or simply by the approximated edges of the mantle; organs of generation very distant.

Shell rudimentary or null.

The following is Cuvier's description of *Aplysia*:

Edges of the foot raised into flexible crests and surrounding the back on all sides, being capable even of being reflected upon it; head carried on a neck more or less long; two upper tentacles hollowed like the ears of a quadruped; two others flattened at the edge of the lower lip; eyes below the first. On the back are the branchiæ, in form of very complicated leaves (feuillettes), attached to a large membranous pedicle, and covered by a small pedicle equally membranous, which contains in its thickness a horny and flat shell. The anus is pierced behind the branchiæ, and is often hidden under the lateral crests. The vulva is in front on the right, and the penis comes out under the right tentacle. A furrow, which extends

from the vulva to the extremity of the penis, conducts the semen at the time of coition. An enormous membranous crop leads to a muscular gizzard, armed within with cartilaginous and pyramidal corpuscles, which accompany a third stomach beset with pointed hooks, and a fourth in form of a cæcum. The intestine is voluminous. These animals feed on sea-weed (*Fucus*). A particular gland pours out by an orifice situated near to the vulva a limpid humour, which is said to be very acrid in certain species; and from the borders of the mantle there oozes abundantly a deep purple liquor, with which the animal colours the sea for a considerable distance around when it perceives any danger. The eggs are disposed in long interlaced glairy filaments, delicate as packthread.

Cuvier instances as examples from the European seas, *Aplysia fasciata*, *punctata*, and *depilans*.

The acrid humour noticed above probably gave rise to the accounts of the poison of the *Lepus marinus* (an *Aplysia*, and most probably *Aplysia depilans*) among the ancients. See, for example, Pliny, *Nat. Hist.*, lib. xx., c. xxi.; lib. xxiii., c. vi., &c.

In the museum of the Royal College of Surgeons in London, No. 625 of the *Physiological Series*, is an *Aplysia alba*, in which the mantle has been laid open on the left side, and the peritoneal membrane dissected away, to show the intestinal canal winding among the lobes of the liver: the tunics of the intestine being thin and transparent, permit the contents of the canal to be distinctly seen; these consist of particles of sand with comminuted fragments of zoophytes and shells: so that it appears that their diet is not merely vegetable, as Cuvier seems to have thought. Bristles are inserted at the mouth and anus; the latter orifice is situated in the branchial cavity, below the gills. No. 626 is the intestinal canal of a larger species of *Aplysia*, distended with similar particles of earthy matter; and the author of the Catalogue remarks that this preparation affords a striking example of the powers of living organized matter, and cannot be contemplated without surprise, when we consider the force that must be exerted to propel a column of such heavy and rude materials along a tortuous canal provided with parietes apparently so inadequate to sustain the necessary pressure. No. 1011 is a small *Aplysia alba*, Cuv., with a portion of the mantle dissected away to expose the branchiæ of an arborescent structure, but more complex and better defended than in the *Doris*, the respiratory cavity being shielded by a thin horny plate or rudimentary shell. No. 1012 is a larger specimen of the same species of *Aplysia*, further dissected, so as to show, in addition to the branchiæ, the heart and pericardium, the mouth and masticatory organs, the stomach, nervous ganglia, and the penis on the right side of the neck. A portion of the shell is left to show how loosely it is lodged between the layers of membrane forming the roof of the branchial chamber; and No. 1013 exhibits another species (*Aplysia Camelus*, Cuv.), showing the branchiæ in their natural position, without dissection, by merely separating the dorsal lobes of the mantle and elevating the roof of the branchial chamber. (*Cat.*, vols. i. ii.)

M. de Blainville divides the genus *Aplysia* into the following sections:

A. Species whose lateral appendages are very wide, divided behind, and depressed.

Example, *Aplysia depilans*.

B. Species whose narrower appendages are united and elevated behind.

Example, *Aplysia vulgaris*.

C. Species whose appendages are very wide, and which have only two tentacles, behind which are the eyes. (Genus *Actæon*, Oken.)

Example, *Aplysia viridis*.

D. Elongated species with a subulate tail; the four tentacles long and slender; the branchial cavity subdorsal, without operculum or shell.

Example, *Aplysia Brongniartii*.

The other genera arranged by De Blainville under the Aplysians are *Dolabella*, *Bursatella*, *Notarchus*, and *ELYSIA*.

M. Rang divides Aplysians into two subgenera:

I. The Aplysians, properly so called (*Laplysia*, Linn.; *Dolabella*, Lam.; and *Actæon*, Oken).

This subgenus is thus characterized by M. Rang:—

Animal furnished with a dorsal slit, always median and

longitudinal; foot large, branchiæ enclosed in the border of a cavity, whence their length does not permit them to be protruded, and protected above by an operculum.

Shell rudimentary, calcareous, membranous, hiding the thickness of the operculum.

1st Group.

Body convex behind, an oblique posterior disk, border of the mantle closed on the back, and improper for swimming.

Shell triangular and very calcareous.

This group comprises the genus *Dolabella* of L.

Example, *Aplysia Rumphii*, &c.

2nd Group.

Body narrowed at the two extremities, no disk, border of the mantle very small and improper for swimming. Shell subquadrangular and calcareous.

This group, M. Rang observes, is composed of several species, with the exception of one, which was erroneously arranged among the *Dolabellæ*.

Example, *Aplysia dolabrifera*.

3rd Group.

Body narrowed at the two extremities; borders of the mantle dilated and proper for swimming.

Shell subrounded, membranous, and solidified by a calcareous stratum.

M. Rang remarks that this group has for its type the genus *Laplysia* of Linnæus, and he divides it into sections.

A. A tube at the membrane of the operculum.

Example, *Aplysia fasciata*.

B. An aperture at the membrane of the operculum.

II. Subgenus: *Notarchus*, Cuv.

The other genera arranged by M. Rang under the Aplysians are *Bursatella* and *Actæon*. (*Manuel*.)

Mr. J. E. Gray makes the *Aplysiadæ*, the 2nd order of his 3rd order (*Pleurobranchiata*), consist of the genera *Aplysia*, *Dolabella*, and *Notarchus*. The family is placed between the *Bullidæ* and the *Umbrellidæ*.

As an illustration of the genus *Aplysia*, we take *Aplysia depilans*.

Description.—Blackish, with large cloudy greyish or blotches, or of different shades of brown tinged blue or purple.

Locality and Habits.—European seas, where it adheres to rocks.

Aplysia depilans.

Dolabella.

Cuvier observes that this form only differs from *Aplysia* in having the branchiæ and that which surmounts them at the posterior extremity of the body, which resembles a truncated cone. Their lateral crest, which does not close on the branchial apparatus, leaving a narrow furrow, and their shell is calcareous.

Locality and Habits.—East Indian seas, and Mediterranean, where it has been found at a depth of six fathoms on sands.

The Laplysians of Lamarck consist of the genera *Aplysia* and *Dolabella* only; and M. Deshayes, in the last edition of the 'Animaux sans Vertèbres,' thus sums up the nomenclature on the subject. Lamarck, he observes, knew of the animals of this family, though he had indeed some species preserved in spirit of wine in the anatomical collection of the museum. Thus he only admitted the genera last above named into the family. Since the publication of Lamarck's work, M. de Blainville, in his nomenclature of the *Aplysians*, and, above all, M. Rang, in

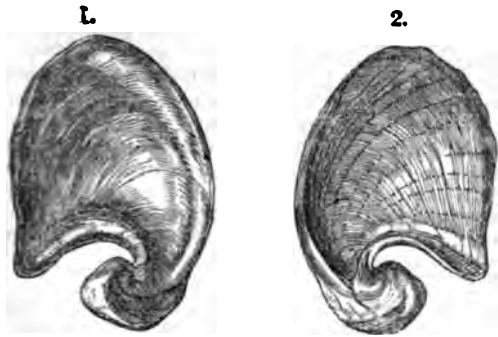

Shell of *Dolabella Ramphii*. 1, inside; 2, outside.

ral History of the Aplysians,' have, he remarks, many important observations on the animals of this up. M. Rang, in his work, having especially studied Aplysians, has, as we have above seen, proposed to into this family three genera only, *Aplysia*, *Bursatella*, and *Actæon*, and he divides the great genus *Aplysia* genera, among which is found the genus *Dolabella*. There too is to be found the genus *Notarchus*, Cuv. ast, observes M. Deshayes, has in fact much analogy Aplysians, but it preserves some peculiar characteristics of easy distinction; and he thinks that the t genus *Aplysia*, as considered by M. Rang, ought to adopted. Lamarck established his genus *Dolabella*, separated it from *Aplysia* because the shell is calcareous, and not entirely corneous, as in that genus. Lask, without doubt, continues M. Deshayes, would have eived the little value of this character if he had been to examine as many species as did M. Rang: he then d have seen the establishment by insensible gradations passage between *Dolabella* and *Aplysia*, not only reference to the form of their shells, but with regard ir consistence also. With regard to the posterior ation of the animal of *Dolabella*, that may be seen pear insensibly, so that there exist *Dolabellæ* with ureous shell, having entirely the external form of *Aplysia*. If, on the one hand, we see the *Aplysiæ* with ureous shells (*Dolabellæ*) pass into those with corneous s, we perceive on the other hand *Aplysiæ* with horny s pass into species which have no trace of such prong body. These remarkable species have the lobes less slit, more closed upon the back, and preserving the principal characters of the true *Aplysia*. M. Rang has established on these species his *Aclesia*, remarkable for the singular tentaculigerous appendages on the bodies of the species which form Next to *Aplysia* M. Rang places *Notarchus*, and the *Notarchi* are *Aplysiæ* which have only two tentacles, and se mantle is more closed on the back than it is in the eding genus; the foot is extremely narrow, it is terted anteriorly by a double lip, and resembles rather foot of the *Scyllææ* and other mollusks which creep he stems of sea-weeds, than that of the *Aplysiæ*. It be wished, adds M. Deshayes, that the *Notarchi* d be found in sufficient numbers for dissection, by h means all doubt with regard to them would vanish. r the genus *Aplysia*, M. Rang places *Bursatella*; M. Deshayes remarks that this genus has so great an ogy with *Notarchus*, that a new anatomy of the former uch to be desired. The animal seen by M. de Blainwas much contracted in the spirit, and its body was with a small number of tentacular appendages, approximate it to the subgenus *Aclesia*, whilst in it appears to come nearer to *Notarchus*. The last us, says M. Deshayes in conclusion, placed in the ly of Aplysians by M. Rang, is the *Actæon* of Oken, h is not sufficiently known to be definitively admitted the system; so that the family of Aplysians may be reduced to the genus *Aplysia*, as considered by Rang.

Notarchus.

imal furnished with a very small dorsal slit, which is nes oblique; foot elongated, and rather narrow; u often very long, and capable of being protruded cavity; operculum rudimentary or null. u null.

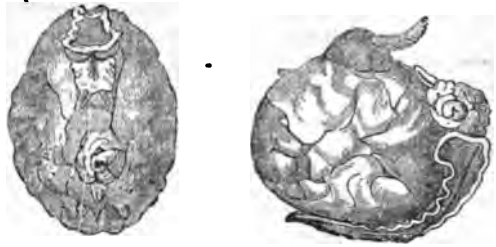

Notarchus Cuvieri.

TE'CTONA, a genus of the natural family of Verbenacæ, so named by Linnæus from the Indian name (*Tekka*) of the famous Teak-tree (called also *Sagoon*), which is a native of different parts of India, as well as of Burma, chiefly along the banks of the Irrawady, and of the islands from Ceylon to the Moluccas. The genus is characterised by having a 5-6-toothed calyx, which becomes inflated over the growing pericarp. Corol 1-petalled, 5-6-cleft. Stamens 5, but often 6. Germ superior, 4-celled, cells 1-seeded, attachment central. Drupe obtusely 4-sided, woolly, spongy, dry, hid in the calyx. Nut hard, 4-celled. Seed solitary. Embryo erect, without perisperm.

The teak-tree grows to an immense size, and is remarkable for its very large leaves, which are from 12 to 24 inches long and from 8 to 16 broad, and are compared by Oriental writers to the ears of the elephant. The petioles, as well as the young branches and flower-stalks, are all 4-sided and the sides channelled. The inflorescence is in very large terminal panicles, of which the divisions are first cross-armed and finally dichotomous, with a sessile fertile flower in each cleft, the whole covered with a hairy farinaceous substance. The flowers are small, white, and very numerous. As teak timber is so highly valued both for domestic purposes and for ship-building, it is desirable to notice its distribution a little more in detail. The best timber for ship-building was supplied to Bombay from the mountains of the Malabar Ghauts, where the tree is found rather in detached clumps, of some extent however, than in extended forests. It is also found on the mountainous parts of the Coromandel Coast, along the banks of the Godavery up to Poloonsha. It proceeds far into the interior of India, and may be seen in the mountains of Bundelcund, in the form however of only a moderate-sized shrub. Dr. Roxburgh introduced the teak into the low grounds of the Circars as early as 1790, and Lord Cornwallis and Colonel Kyd planted it in Bengal about the same time. The Calcutta Botanic Garden contains a number of these trees. From the Saharunpore Botanic Garden, in 30° 9' N. lat. (where, its buds being covered with scales, it is enabled to resist cold, besides its leaves falling and giving it a season of rest), the tree has been spread along the Doab Canal; the whole of the intermediate country is suited to its cultivation, and the East India Company have recently ordered the Malabar forests to be preserved. The most extensive forests are however those extending along the banks of the Irrawady, especially in Pegu. A considerable timber-trade has been established at Moulmein, whence Calcutta is supplied with some of the finest teak timber. So much straight timber is taken and the crooked left, that thousand of pieces called 'shin-logs,' and admirably adapted for ship-timbers, are left. The tree grows quickly, straight, and lofty, but requires from 60 to 80 years to attain the proper size and maturity for ship-building.

From extensive experience teak timber has been found the most valuable timber for ship-building, and has been called the oak of the East. The wood is light, brownish-coloured, easily worked, but at the same time strong and durable. It is soon seasoned, and, from containing a resinous oil, resists the action of water, as well as insects of all kinds. It does not injure iron, and shrinks but little in width. Some of the old trees have been found by Dr. Horsfield to have large and beautiful burrs like the *Kiabouca* wood of commerce. No other part of the tree is known to be converted to much use; but the leaves are said to dye cotton and silk of a purplish colour. They have lately been imported into the London docks carefully rolled up, but for what purpose is not known.

TECTUS. (Conchology.) [TROCHID.E.]

TEES. [DURHAM.]

TEETH. Since the article DENTITION was written, the teeth have been subjected to the most careful microscopic examination, and the result has been the acquisition of a great amount of knowledge in regard to both their structure and their mode of growth. Indeed there is probably no part of physiology in which more remarkable and important progress has been made during the last ten years than in this, to which the name of Odontography has been given. The chief discoveries were made coincidentally by Professor Purkinje of Breslau and Professor Retzius of Stockholm. The former published his observations in 1835, in the inaugural dissertation of Dr. Fraenkel (*De penitiori Dentium Structura*), and in that of Dr. Raschkow (*Meletemata circa Dentium Evolutionem*); and the latter communicated his descriptions to the Royal Academy of Sciences at Stockholm, in whose Transactions they were published in 1836. In 1839 Dr. Schwann published, in his 'Mikroskopische Untersuchungen,' an account of the modes in which the several constituent tissues of the teeth are developed; and in the same year Mr. Goodsir (*Edinburgh Medical and Surgical Journal*, vol. li.), carrying out the view before suggested by Professor Arnold, described that method of their early growth which is now generally received as the truth. Mr. Owen also, in his 'Odontography,' and in various papers, at the same time that he has confirmed and greatly added to the facts described by those already mentioned, has proved, by his investigations into their comparative anatomy, that the minute structure of the teeth may be taken as one of the most certain characters for the discrimination of the genera, and even of the species, of both existing and extinct animals; and he has already applied his knowledge of them to the determination of some of the most difficult questions of palæontology.

In the following account scarcely any of the discoveries will be detailed except such as relate to the structure and physiology of the human teeth; for, various as the structures are in the different classes of animals, yet there is so much analogy among them, that the description of the tooth of one will, in great measure, explain the general plan of structure in the rest. Besides, the lately published articles on comparative anatomy contain nearly all the important facts regarding the structure of the teeth in the animals of which they treat.

The best method of preparing teeth for microscopic examination is to immerse them in dilute hydrochloric acid, till their earthy matter is so far dissolved that thin transparent slices may be cut from them with a knife; or, without softening them in acid, to make thin sections, in the vertical and other directions, with a fine saw, and to reduce these to the necessary thinness and transparency by filing

Fig. 1.

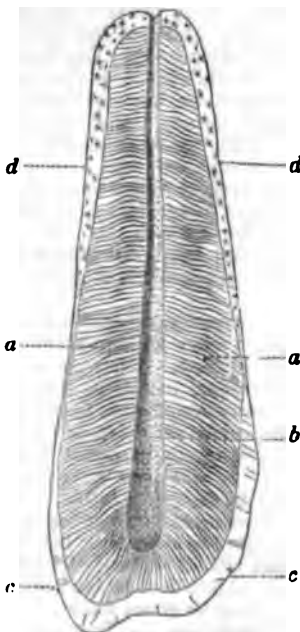

Magnified section of a bicuspid tooth.

them, and polishing them on a hard and smooth stone. For general examination, lenses magnifying 50 diameters are sufficient.

In such a vertical section of a tooth three distinct stances are seen; namely, the dentine or ivory (Fig. 1) which forms the greater mass, and, as it were, the core of the tooth, and which contains the pulp cavity (c); the enamel (cc), by which the crown or exposed part of the tooth is covered; and the bone, cement, or crusta (dd), which forms a thin layer around the fang, except that part at which the vessels enter the pulp, and continued in a finer and scarcely perceptible layer of enamel.

The bone, or cement, has in each animal a minute structure similar to that of which the bones of its skeleton are composed. In man it consists of a basis of homogeneous substance, a compound of cartilage and earthy matter, in which there are minute cavities (Fig. 2), with branched canals leading from one to the other. The walls of these canals and cells the earthy matter is deposited more thickly than in the intermediate spaces, when examined by transmitted light they appear dark grey. The cavities, or bone-corpuscles, in man are oval, and flattened; most of them are between $\frac{1}{1000}$ of an inch in length, about one-third as much in breadth, and one-sixth as much in thickness. They have somewhat jagged edges, from all parts of which there issue the fine branching canals, to which the name of canaliculi has been given, and which traverse the homogeneous basis of the bone, and communicate irregularly with another. The diameter of these canals, at their widest parts, is not more than $\frac{1}{10000}$ of an inch; that of the smaller branches is between $\frac{1}{20000}$ and $\frac{1}{30000}$. Their direction is towards the axis of the tooth, and around the corpuscles are arranged in concentric circles.

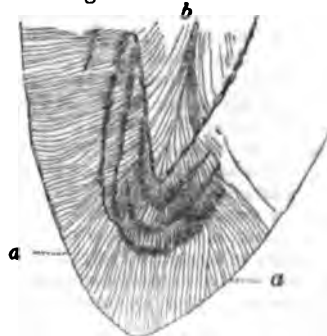

Fig. 2.

Microscopic view of bone-corpuscles and calciferous canals.

The enamel is composed of solid prisms, or fibres (Fig. 3), about $\frac{1}{200}$ of an inch thick, set side by side in a regular order upon the ivory of the crown of the tooth. The base of each prism is fixed in a little depression on the rough outer surface of the ivory; the other end, which is somewhat larger, is turned towards the masticatory surface of the tooth in the direction in which the external pressure is to be resisted. The course of the prisms is more or less wavy, their curves being, for the most part, parallel (Fig. 4), but sometimes opposed. Most of them extend from the ivory to the surface of the tooth, where they do not, small complementary prism-like wedges, the vacant spaces.

Fig. 3.



View of the arrangement of the enamel-fibres on the crown of an incisor tooth.

Fig. 4.



Small collecting enamel-fibres.

In the perfect state the enamel contains so little animal matter, that it cannot be demonstrated to the sight, and the prisms are inseparably consolidated; but in young teeth it is soft, and may be broken up

mentary parts. In the early state also it exhibits of a membranous animal substance, consisting of cells in which each of its prisms was formed; for, as is presently shown, the earthy matter is deposited in a series of moulds formed by the cells of the enamel membrane, and, as it accumulates, the membrane of the cell is so nearly removed, that in the perfect tooth no portion of it can be discerned. The former existence however seems to be indicated by a series of transverse striæ upon each prism of the

dentine, or ivory, is composed of a hard fibrous basis and an earthy substance, traversed by very fine, cylindrical tubules, which run in an undulating course from the pulp-cavity, on whose internal surface they are deposited (see Fig. 1, b) towards the adjacent part of the surface of the tooth. Each tubule in its course outward follows two or three chief curves ('primary curvatures,' and is besides bent at every part in minute and successive undulations, or secondary curvatures; but the chief of those tubules, which are adjacent to each other, are early parallel. It is from the parallelism of these primary curvatures of the tubules, that the appearance of the ivory were composed of concentric lamellæ around the pulp-cavity.

The chief branchings of the tubules of the dentine are numerous (Fig. 5); but they also frequently give off secondary branches, which again sending off smaller ones, fill the spaces between the trunks (Fig. 6). At the mouth of each tubule has an average diameter of about $\frac{1}{1000}$ of an inch, and the distance between each two tubules is equal to the width of three of them. Both the interior of the cavities of the tubules, as well as the substance between them, are filled by the earthy constituent of the dentine, which is deposited in fine granules. The intertubular substance seems to be composed of bundles of flat, pale, granular fibres, whose course is parallel to that of the tubules.



Fig. 6.

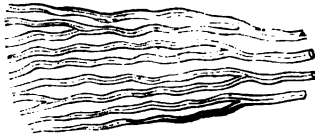

Fig. 5.

Views of the tubules of dentines.

A separate organ is provided for the formation of each of the three constituent parts of the tooth, though, when they are perfected, they contain no vascular tissue in the pulp within the pulp-cavity, and it is doubtful, in the human subject, fresh material is ever deposited from this after the tooth has once attained its development. The first appearance of the pulp of the tooth is in the form of a minute process or papilla from the bottom of a groove in the mucous membrane of the mouth behind the edge of the jaw. In course of time the borders of the groove grow around it, the process seems to sink into the mucous membrane; and it appears as if rising from the base of a follicle, or of a depression, in the edge of the jaw. And lastly, a membrane, or opercula, grow from the sides of the mouth of the follicle, and as they approach each other they adhere by their mutually opposed edges, they close it, and convert it into a capsule or sac, to the bottom of which the first-formed papilla is affixed. In the appearance of a tooth, the papillary state may be seen in the human embryo an inch in length: the capsular membrane completed at about the fifteenth week of embry-

onal development. The three stages of the formative organs of the tooth, the papillary, the follicular, and the capsular, completed, the substances of the tooth itself begin

to be produced. The dentine is developed from the papilla, which gradually assumes the form and relations of the proper tooth-pulp; the enamel, from a special organ developed at that part of the capsule which is opposite to the papilla; and the bone probably from the interior of the capsule itself.

The papilla and the sac both gradually increase in size, but the growth of the latter is at first more rapid than that of the former, and the space between them is thus enlarged. Within this space there is deposited from the wall of the sac a soft, granular, non-vascular substance, the enamel-organ, or, as Mr. Hunter (*Natural History of the Teeth*) termed it, the external pulp. And at the same time as this is being produced from the interior of the sac, there is formed on the surface of the papilla a peculiar structureless membrane, which has been called the *preformative membrane*, and which, when the papilla begins to ossify, presents numerous little elevations and depressions, on which the enamel fibres are afterwards fixed; for as the papilla enlarges, the preformative membrane comes in contact with the enamel-organ, and they are exactly moulded the one upon the other.

Both the papilla, or as it may now be called, the pulp, and the enamel, are composed of primary cells [Nutrition], and it is by the transformation of these that the tubules of the dentine and the fibres or prisms of the enamel are severally produced. The exact mode however in which the change is effected is not yet known. All that can be seen is that the superficial cells of the pulp, which are at first round or oval, and nucleated, assume the same diameter and direction as the trunks of the dentine tubules, and then have earthy matter deposited in and around them. And these changes go on gradually from without inwards: as fast as the elongated and branching cells of one layer are ossified, those of the layer beneath them become elongated in preparation for the same change; and so on, till a great part of the pulp is hardened. It is due to this gradual ossification of the pulp from without inwards, that in growing animals, to whom madder is alternately given and omitted in their food, the dentine is found to consist of alternate rings of red and white ivory; for while madder is being taken, all the earthy matter that is deposited in the most superficial layer of the unossified pulp-cells is dyed by its colouring principle, and when it is discontinued the same material is deposited uncoloured in the layer of cells which is subjacent to that already ossified and reddened. When nearly the whole of that part of the pulp which was formed in the original papilla is thus hardened by the deposition of earthy matter, its base begins to grow into one or more conical processes, and, by a hardening of these, through a process like that just described, the fangs are formed, and the tooth rises to the surface of the gum.

In the formation of the enamel, the primary nucleated cells on the inner surface of the enamel-organ become elongated and cylindrical, or prismatic; they assume a direction which is perpendicular to the surface of the hardening pulp; and then, their nuclei disappearing, they also are hardened by the deposition of earthy matter within them, which is continued till they are inseparably compacted, and their original membranous wall is not discernible. These changes also, like the preceding, make progress in layers; but the progress is here from within outwards, and it goes on till nothing is left but a thin external *enamel-membrane* on the surface of the crown of the tooth. As the enamel organ and the papilla, both growing and hardening, approach more nearly to each other, the preformative membrane also disappears.

By the transformation of this enamel-membrane, or of the superficial part of the capsule itself, that part of the bone is produced which envelopes the enamel; and by similar changes in that part of the capsule which has grown in company with the fang-processes of the pulp, that part of the bone is formed which invests the fangs. The changes in this part of the process are probably exactly similar to those through which new bone is produced between a periosteum and the old bone which it surrounds.

TEETH OF WHEELS. [WHEELS.]

TEFLIS. [TIFLIS.]

TEFZA. [MAROCCO.]

TE'GEA. [ARCADIA.]

TEGERNSEE, THE, is a lake in the circle of the Isar

in the kingdom of Bavaria, about thirty miles from Munich, at the foot of the Bavarian Alps. It is about four miles long, one mile and a quarter broad, and 300 feet deep. This lake gave its name to a Benedictine abbey, which was founded by the Agilolfingers, in the time of King Pepin, was destroyed by the Hungarians, restored in 979, and not abolished till some years after the beginning of this century. The abbots were princes, and had four hereditary offices in their household which were held by noblemen. The late king of Bavaria, Maximilian Joseph, had the abbey converted into a fine palace, which he presented to his consort the late Queen Caroline, with the lordship depending on it, which is about 60 square miles in extent, including the village of Tegernsee, with 300 inhabitants. This palace is situated in a beautiful country surrounded with lofty mountains, among which the Waldberg and the Setzberg are sometimes illuminated when there are royal visitors at the palace. The grounds are laid out with great taste, and the village church is very handsome, and contains some fine paintings. In the vicinity there are quarries of fine marble of various colours, and the mineral springs of Kreuth and Schwaighof. Kreuth is in a very romantic situation, at the foot of high mountains, and is much frequented for its sulphureous waters. Near Tegernsee naphtha is found, which is here called St. Quirinus oil, because it was formerly pretended that it issued from the corpse of St. Quirinus, to whom a chapel in the vicinity is dedicated.

(Hassel, *Geographie*; Stein, *Geographisches Lexicon*; Cannabich, *Lehrbuch der Geographie*; Hübner, *Zeitungs-Lexicon*.)

TEHERAN, or TEHRAN. [PERSIA.]

TEHUACAN. [MEXICAN STATES.]

TEHUANTEPEC. [MEXICAN STATES.]

TEIGNMOUTH. [DEVONSHIRE.]

TEIGNMOUTH, JOHN SHORE, LORD, was the eldest son of Thomas Shore, Esq., sometime of Melton in Suffolk, and of his wife Dorothy (other authorities say Deborah) Shepherd. The family was originally of Derbyshire, Lord Teignmouth's great-grandfather having been a Sir John Shore, of Derby, M.D., who was knighted in 1667. Lord Teignmouth was born, it is believed, in Devonshire, October 8, 1751: his father died in 1759, his mother in 1783, and his only brother, the Rev. Thomas William Shore, who was vicar of Sandal in Yorkshire, and of Otterton in Devonshire, in 1822.

Lord Teignmouth went to Bengal in 1769, as a cadet in the Company's civil service, and was first stationed at Moorsheadabad as an assistant under the council of revenue. In 1773 his knowledge of that language procured him the appointment of Persian translator and secretary to the Provincial Council of Moorsheadabad; and this was followed the next year by a seat at the Calcutta revenue board, which he retained till the dissolution of the board in 1781, when he was appointed second member of the general committee of revenue, established by the new charter granted that year. While holding this situation, Mr. Shore lived in terms of intimacy with Warren Hastings, the governor-general; and when Hastings came home in 1785 he accompanied his friend to England. During this visit to his native country he married Charlotte, only daughter of James Cornish, Esq., a medical practitioner at Teignmouth; and a few weeks after, in April, 1786, he set out again for Calcutta, having been appointed one of the members of the Supreme Council under the new governor-general Lord Cornwallis. To his activity and ascendancy in the council is mainly attributed the adoption of Cornwallis's great measure, the new settlement, in 1789, of landed property in the presidency of Bengal, by which the zemindars, hitherto only the revenue agents or tax-gatherers of the government, were made the hereditary proprietors of the estates which they farmed, and the ryots, or peasantry, who had till now a right of occupation so long as they paid their assessments, were declared the tenants of the zemindars, and made removable at the will of their landlords. The new judicial system which was introduced towards the close of Lord Cornwallis's government in 1793, also owed its establishment in a principal degree to Shore, who had been made a baronet the preceding year. On the retirement of Cornwallis, in August, 1793, Sir John Shore was appointed to succeed him as governor-general; and he held that high office till the close of the year 1797, when he resigned

it to the earl of Mornington, and was created an Irish peer by the title of Baron Teignmouth.

Upon the death of Sir William Jones, in April 1794, Sir John Shore was elected president of the Asiatic Society; and taking his seat in that capacity on the 15th of May, he delivered a discourse on the merits of the Society, which is printed in the fourth volume of the Society's 'Transactions.' After his return home Lord Teignmouth published, in 1804, a 4to. volume, 'Memoirs of the Life, Writings, and Correspondence of William Jones;' and in 1807 he produced an edition of 13 vols. 8vo., of Jones's Works, with this Life prefixed. Upon his leaving India Lord Teignmouth had been succeeded as president of the Asiatic Society by Sir James Chambers, in a discourse by whom, delivered at a meeting of the Society on the 18th of January, 1798, and in the sixth volume of their 'Transactions,' the sketch of the character and career of his predecessor, Lord Teignmouth was elected its first president, and this situation he retained till his death, though some years before that event he was obliged to devolve his duties upon his successor, Lord Bexley. In the proceedings of the Society he at all times took the liveliest interest.

On the 4th of April, 1807, Lord Teignmouth was appointed one of the commissioners for the affairs of the East India Company, in other words, a member of the Board of Control; on the 8th of the same month he was sworn of the Council. He retained his seat at the Board of Control for some years; and his death took place on the 14th of February, 1834.

Besides the publications already mentioned, Lord Teignmouth is the author of 'A Letter to the Reverend Thomas Wordsworth, D.D., on the subject of the Asiatic Society,' 8vo., London, 1810; and 'Considerations communicating to the Inhabitants of India the Knowledge of Christianity,' 8vo., London, 1811. (*Gent. Mag.* 1834, pt. i., p. 552.)

TEISSIER, ANTOINE, was born at Montpellier, January, 1632. His family, which was originally from Nîmes, was Protestant; and his father was receiver of the province of Languedoc, but he was deprived of that appointment, and also of whatever else he possessed, a few months after the birth of his son, for having joined the revolt of Henri, Duc de Montmorenci, at least given up to him the public money which was in his hands. Montmorenci was taken prisoner at the battle of Castelnaudari, on the 1st of September, 1622, and his insurrection was suppressed, and on the 30th of October he was beheaded. After the ruin of his father's fortune was determined that Antoine Teissier should be educated for the ministry of the Protestant church; with that view he studied theology for some time in the Protestant seminaries of Nîmes, Montauban, and Saumur. But in the end he made up his mind to adopt the profession of the law, induced, it is said, by the weak state of his health; and after having obtained a doctor's degree, he commenced practice as an advocate before the district court called the Presidial, at Montpellier. His bodily strength however proved to be no more sufficient for the bar than it had been thought to be for the pulpit; and after some time he gave up his practice and took to literature as a means of subsistence. In the revocation of the Edict of Nantes, in 1685, Teissier sought refuge in Switzerland, having, according to the 'Encyclopédie Universelle,' although in extreme distress, refused every tempting proposal which were made through the channel of the chancellor D'Aguesseau, to induce him to remain in France. But it would no doubt be made a condition of his staying that he should abjure Protestantism. He supported himself chiefly at first by publishing a French newspaper, and then by giving a course of public law at the University of Zürich; and the works he sent to the press from time to time also brought him something. At length he was invited by Frederic III., elector of Brandenburg (afterwards king Frederic I. of Prussia) to come to Berlin, and there he resided till his death, on the 7th of September, 1715. Immediately on his arrival he had been nominated a councillor of state, and appointed to the office of historiographer; and part of his time was also employed for some years in superintending or directing the education of the hereditary prince, afterwards Frederic

A complete list of Teissier's numerous publications is given in the 'Biographie Universelle.' The most celebrated among them is his 'Eloges des Hommes Savans, tirés de l'Histoire de M. de Thou,' first published at Lyon and at Geneva, in a 12mo. volume, in 1683; then at Utrecht, in 2 vols., in 1696; and again at Leyden, in 4 vols., in 1715. In the two latter editions the text of De Thou is accompanied by numerous annotations, which display much curious research. Teissier was an accurate inquirer; but there is no artistic quality or vital power in any of his books, and all of them, even including his 'Eloges,' may be said to be now superseded and nearly forgotten. One of the most creditable is a Catalogue, in Latin, of the authors who have written catalogues, indexes, &c., in two parts, 4to., Geneva, 1635 and 1705; some others relate to parts of the history of Prussia; and a great many are translations, which have the character of being generally faithful enough, but of little elegance of spirit, from St. Clement, St. Chrysostom, Calvin, Sleidan, and other Greek and Latin writers, the latter mostly, if not exclusively, moderns.

TEIXEIRA. [TEXEIRA.]

TEJEN. [PERSIA.]

TEJUCO. [BRAZIL, p. 368.]

TEJUS. [SAUVEGARDE.]

TELECLÈS. [SCULPTURE.]

TELEGRAPH (from τήλε, 'distant,' and γράφω, 'write'), a machine or contrivance for communicating intelligence to a distance, usually by means of preconcerted signals, to which some conventional meaning is attached. On this account telegraphic communications may be as remarkable for their impenetrable secrecy as for their utility. The name semaphore (from σήμα, 'a sign,' φέρω, 'bear'), is commonly applied to some of the lines used for effecting telegraphic communication; much, in an extended sense, may be considered to embrace every means of conveying intelligence by gestures and visible signals, as flags, lanterns, rockets, blue-lights, beacon-fires, &c., or by audible signals, as the firing of guns, the blowing of trumpets, the beating of drums or gongs, &c., as well as by the machines called telegraphs or semaphores.

Although telegraphic communication, as a means of conveying any required intelligence, is an invention of recent date, the use of signals for the speedy transmission of such brief messages as might be previously arranged between persons, is a practice derived from the most remote antiquity. The use of beacon-fires, for example, as a means of giving speedy warning of the approach of an enemy, is alluded to by the prophet Jeremiah, who wrote about six centuries before the Christian era, and who warns the Benjamites to 'set up a sign of fire in Beth-haccerem; for evil,' he adds, 'appeareth out of the north, and great destruction.' (*Jeremiah*, vi. 1.) The fine description given by Æschylus, in his 'Agamemnon,' of the application of a line of fire-signals to communicate the intelligence of the fall of Troy, is often referred to as an early instance of this kind of telegraphic despatch; but if the era of the writer, and not that of the event, is referred to, the passage above quoted affords an earlier illustration. This simple means of spreading an alarm, or communicating intelligence in time of war, is practised by many nations; and, to come nearer home, we may refer to the graphic stanzas of the 'Lay of the Last Minstrel' (canto iii., st. xxv.-xxix.), descriptive of the rapid communication of the approach of the English forces from the border stations, along 'height, and hill, and cliff;—

* Till high Dunedin the blazes saw,
From Soltra and Dumpender Law;
And Lothian heard the Regent's order,
That all should bounie them for the border.*

In a note illustrative of this description, Scott refers to an Act of the Scottish parliament in 1455, c. 48, which directs that one bale or faggot shall be warning of the approach of the English in any manner; two bales, that they are coming indeed; and four bales blazing beside each other, that the enemy are in great force. Such signals, though best adapted to give information by night, were also available in the daytime, when they appeared as columns of dense smoke. Torches held in the hand and moved in any particular manner, or alternately displayed and hidden behind a screen, were also used in ancient times as signals, as we learn from several early writers on

military subjects; but as they were merely arbitrary signals, which admitted of very little variation, such devices could only be rendered available by previous concert.

That some attempts were made by the ancients to improve upon such simple signals is evident from the tenth book of Polybius, in which allusion is made to a device of Æneas (Tacticus), who proposed to write several sentences, such as it might be desirable to communicate, upon two oblong boards, one of which should be kept by each of the parties. These boards were to be affixed to cork floats capable of rising and falling in cylindrical vessels of similar form and size, one of which was placed at each station. Matters being thus prepared, and the vessels filled with water, the person desiring to send intelligence allowed the water to escape from his vessel by a small opening until the suitable sentence on the inscribed board had sunk to a certain mark; making torch signals to indicate the moment of allowing the water to run out, and that at which the board sank to its proper level. The person at the distant station regulated the egress of water from his vessel by the torch signals, and was thus enabled to ascertain which of the sentences written on the board conveyed the required intelligence. Complicated as was this arrangement, it afforded very little more scope than the use of simple torches or fires. Polybius however describes a much more perfect method of telegraphic communication, which, he says, was invented either by Cleoxenus or Democlitus, but improved or perfected by himself. This method is capable of communicating any required intelligence with the greatest precision, the signals being made to represent the letters of the alphabet, and the message being displayed letter by letter. Instead of quoting the description of Polybius himself, which refers to the use of the Greek alphabet, we shall adopt that of Bishop Wilkins, who describes the plan as applied to the English alphabet. The alphabet must be divided for this purpose into five portions of five letters each (excepting the last, which has but four, *j* and *v* being omitted as unnecessary), and inscribed upon tablets, as in the following diagram:—

	I.	II.	III.	IV.	V.
1	a	f	l	q	w
2	b	g	m	r	x
3	c	h	n	s	y
4	d	i	o	t	z
5	e	k	p	u	

This being done, each of the corresponding parties is to be provided with a copy of the tablets, and also with ten torches, five of them on the right hand and five on the left. Any letter may then be expressed by first lifting up on the right hand so many torches as may indicate the number of the tablet in which it is contained, as I., II., III., &c., and then so many on the left as may show the number of the particular letter in the tablet, as 1, 2, 3, &c. Thus the word *hasten* would be expressed by displaying the torches six times, in the following order, in which the Roman letters indicate the number of torches raised on the right hand, and the Arabic numerals those on the left:—

Right hand.		Left hand.
II.	h	3.
I.	a	1.
IV.	s	3.
IV.	t	4.
I.	e	5.
III.	n	3.

Polybius observes that dioptrical instruments, framed with two holes or tubes, should be used to enable the observer to distinguish accurately the right and left hand lights; and that solid fences should be erected upon each side, behind which the torches might be concealed when out of use. Bishop Wilkins, in his curious work entitled 'Mercury; or the Secret and Swift Messenger,' after describing this telegraph of Polybius, mentions another which requires only three lights or torches. The twenty-

four necessary letters of the alphabet are, according to this plan, which he gives on the authority of Joachimus Fortius, to be divided into three classes of eight letters each. The first class is represented by one torch, the second by two, and the third by three; and the number of the letter by the number of times which the torches are elevated or discovered. Thus one torch raised once would represent *a*, or raised eight times, *h*; two torches raised once would indicate *i*, raised twice, *k*; or eight times, *q*; and three torches raised from once to eight times would give the remaining letters, from *r* to *z*. Similar to this, but still easier of application, is the night-telegraph contrived by the Rev. James Bremner, of the Shetland Islands, and rewarded by the Society of Arts in 1816. A single light constitutes the whole apparatus in this plan, and the whole operation consists in its alternate exhibition and concealment. The alphabet is divided into four classes or divisions, of six letters each; and the number of obscurations is to indicate, first, the number of the division, and secondly, the number of the letter in that division; a pause being made between the obscurations which indicate the number of the division and those which show the number of the letter in that division; and a longer pause between the double set of movements thus required for every letter. Two lights, one to represent the division, and the other the number of the letter, might in some cases be used; but Mr. Bremner conceives that, especially in long distances, one is preferable, as affording less risk of error. His plan had been found suitable for distances of twenty miles and upwards, and had been successfully put in operation between the lighthouse on Copeland Island and Port Patrick on the opposite side of the Irish Channel. Further particulars respecting this, and a description of another telegraph for day-service, by the same author, are given in the thirty-fourth volume of the Society's 'Transactions,' pp. 213-227. Tedious as Mr. Bremner's method may appear, it is stated that, supposing the whole alphabet to be used, sixty letters might easily be given in five minutes; while the communication might be effected more rapidly if, as in some telegraphic systems, only sixteen letters were used. In addition to the alphabetic systems which depend merely upon the number or alternate display and concealment of lights, Bishop Wilkins describes one which depends upon the relative positions of two lights attached to long poles, and which, he says, 'for its quickness and speed is much to be preferred before any of the rest.' It will thus be perceived that that ingenious writer came very near to the principle upon which many of the modern telegraphic systems depend. In suggesting the use of extended lines of telegraphic communication, he further hints at the application of the telescope (or, as he styles it, 'Galileus his perspective'), to the deciphering of distant signals.

Among the scientific writers who seem to have had some notion of the modern telegraph are Kircher, Schottus, and Kessler; the latter of whom proposed to cut out such characters as it was desired to show in the ends of a cask, which was to be elevated with a light enclosed in it. The Marquis of Worcester also, in his 'Century of Inventions,' 1663, announces, 'How at a window, as far as the eye can discover black from white, a man may hold discourse with his correspondent, without noise made or notice taken,' &c.; and again, 'A way to do it by night as well as by day, though as dark as pitch is black.' The earliest well-defined plan of telegraphic communication appears however to be that described in a paper addressed to the Royal Society in 1684, by Dr. Robert Hooke, and published in 1726 in Derham's collection of his 'Philosophical Experiments and Observations,' pp. 142-150, 'showing a way how to communicate one's mind at great distances.' Hooke states that he had discoursed on the subject some years before, but that the then recent siege of Vienna by the Turks had revived the matter in his mind. His scheme will be readily understood by the annexed cut, Fig. 1, which represents an elevated frame-work supporting a panel or screen, *a*, behind which were to be suspended a number of symbols or devices, formed of deal plank, of the various shapes represented by the small black figures. The first twenty-four of these, which consist entirely of straight lines, were to stand for alphabetic characters; and the six devices consisting of curved lines were to be used as arbitrary signals. Whenever it was desired to display any of these characters, they were to be drawn from be-

hind the screen by a rope *c*, passing over pulleys in the frame-work, and so rendered visible in the open space at *b*. These telegraphs were to be erected upon elevated

Fig. 1.

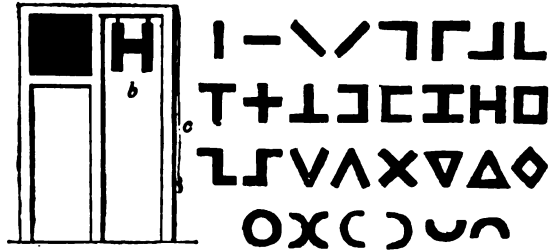

stations, so chosen that, if possible, there might be no refraction of the atmosphere to impede vision, and so that no intervening objects or disturbed background would interfere with the clearness of the prospect; and scopes were to be used by the observers. The order of connection between the signs employed and the letters of the alphabet might, it is explained, be infinitely varied for the sake of secrecy; and none of the parties employed, excepting those at the terminal stations, need have any knowledge of the message communicated. Hooke further proposed a scheme for night communication by means of lights disposed in a certain order. About twenty years after the date of Hooke's paper, Amontons brought forward a very similar plan in France, and made public of his contrivance before several persons of rank. 8 other individuals subsequently devised similar schemes, but nothing was effected in the practical application of telegraphic communication until the war of the French revolution. Macdonald states that, 'Following the principles laid down by Dr. Hooke, in 1684, Dupuis, in France, invented the French telegraph, which Don Guaultier, a monk of the order of Citeaux, in 1781, modified, and proposed to Condorcet, Milli, and Dr. Franklin, who recommended it to the French government.' The telegraph was brought into use in 1793 or 1794, by M. Chappe, and will be seen by Fig. 2, a very superior machine to that of Dr. Hooke.

Fig. 2.

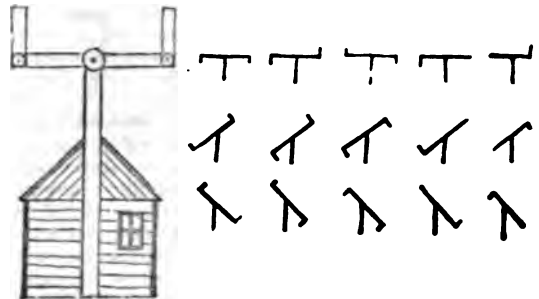

Chappe's telegraph, which, from its position with respect to the upright pole or post, at the top of which was pivoted, in its centre, a transverse beam, which, by means of ropes worked in the chamber below, that served also for an observatory, might be made to assume any required position with the post. Each end of this moveable beam was a short arm, that was capable of assuming any required angle with it; and these arms also were worked by ropes, which were conducted through the axis of the beam, in order that the necessary degree of tension might not be disturbed by the action of the machine. By this contrivance, without the use of any angles of less than 45° (which might be indistinct when viewed from a great distance, or under the influence of a refractive atmosphere), as many as 256 different signs might be made. A much smaller number was however sufficient, as M. Chappe communicated his intelligence letter by letter, and simplified the movements by using an alphabet of only sixteen letters. The small figures in the cut show some of the different positions assumed by the beam and arms; and, as the connection between these and the letters they were made to represent was quite arbitrary, their significance

ight be changed as often as was necessary for the e of secrecy ; it being only necessary that the key be known to the parties sending and receiving the e, although it might be transmitted through a great r of intermediate stations. Such telegraphs were ected on a line commencing at the Louvre, in und proceeding by Montmartre and other elevated to Lisle, in order to communicate between the Com- of Public Welfare and the combined armies in the ountries. Telescopes were used at each station, ; signals displayed at one station were immediately d at the next ; four seconds being found sufficient cting the required motions, and sixteen seconds the lowed for observing and noting down each signal, which the machine remained stationary. Barrère, uncing the invention of the telegraph to the Con- , on the 17th of August, 1794, stated that the news recapture of Lisle had, by means of this machine, l Paris in an hour after the troops of the republic ired that place. (*Annual Register*, 1794, p. 51.) dvantages of such extraordinary celerity of com- ion were so obvious that, in England and other es, many plans were immediately brought forward, f which differed materially from that which had ccessfully put in practice in France. Among these it contrived by Mr. R. L. Edgeworth, who states had made experiments as early as 1767, when he d to use the sails of a windmill as a means of con- intelligence by signals. The report of Chappe's h revived the matter with him, and late in 1794 ; some friends, tried experiments with a numerical h (or a telegraph expressing numbers, which num- to letters, words, or sentences, in a dictionary), on iple shown in the cut *Fig. 3*. An index, or pointer, orm of an isosceles triangle, was so mounted upon or on a portable triangular stand, that it might be

Fig. 3.

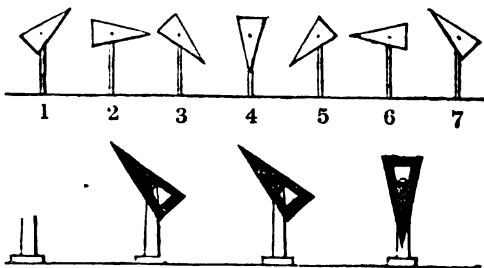

into any of the eight positions shown in the upper the cut ; these positions indicating, respectively, e numerals 1 to 7. Four such pointers, mounted side by side, as in the lower part of the figure, power for expressing any number from 1 to 7777, ng 8, 9, 18, 19, 28, 29, and all others in which the ls 8 and 9 are required : the first pointer represent- usands, the second hundreds, the third tens, and rth units. Thus the four black pointers in the being, respectively, in the positions indicating and 4, express, collectively, the number 2774. The al system affords at least equal facilities with the tic or lettering plan for secrecy in the communica- ince the connection between the numbers expressed sentences to which they refer may be changed at e, and none of the persons employed in transmit- : intelligence need to possess the dictionary, the being all that they require to know. In reference distinctive feature of his plan, Edgeworth observes hile 'telegraph' is a proper name for a machine escribes at a distance, *telegraph*, or, contractedly, *ph*, is a proper name for a machine which de- words at a distance ;' and therefore he uses the ern. In his 'Essay on the Art of Conveying and Swift Intelligence,' published in the sixth of the 'Transactions of the Royal Irish Academy,' h the details of his plan are fully given, Edgeworth the great advantages derivable from the applica- telegraphic communication to commercial and purposes, as, for instance, to the speedy announce- market-prices at a distance ; and even hints at the ity of a line of telegraphs between Europe and the

East Indies. He also published a pamphlet entitled ' A Letter to the Right Honourable the Earl of Charlemont on the Tellograph, and on the Defence of Ireland,' which was reprinted at London in 1797.

Another of the individuals whose attention was directed to this subject by Chappe's telegraph, was the Rev. J. Gamble, then chaplain to the Duke of York. He issued a thin quarto pamphlet, without date, entitled ' Observations on Telegraphic Experiments,' in which, after noticing several suggestions which had been made for effecting rapid communication, he propounds another, of which he believed himself to be the inventor. The apparatus which he proposed consisted of a frame-work containing five boards, or shutters, arranged vertically one above the other, and pivoted in such a way that any or all of them might be closed, so as to present their broad surfaces to the eye, or opened, so as to present merely a thin edge, which would be invisible at a distance. The various signals produced by closing one or more of these shutters may be applied either to a numerical or an alphabetical system. A similar plan submitted to the Admiralty in 1795, by Lord George Murray, was adopted in the first government line of telegraphs established in England, in 1796, between London and Dover. The ' Annual Register' for that year (p. 4 of the ' Chronicle') mentions the erection of the telegraph over the Admiralty on the 28th of January, and states that information had been conveyed from Dover to London in seven minutes. The action of this kind of telegraph, which was continued in use by the Admiralty until the year 1816, is illustrated by *Fig. 4*, in which A represents a square frame-work with six octagonal shutters, 1, 2, 3, 4, 5, and 6, arranged in two vertical columns, or

Fig. 4.

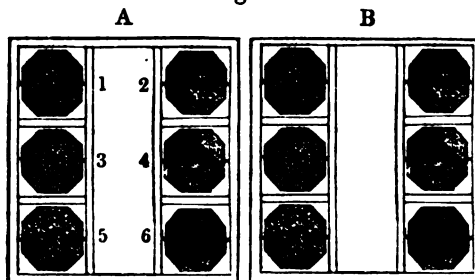

sets, and turned into a vertical position, so as to display their broad surfaces completely, and B represents the same apparatus with the boards or shutters placed horizon- tally, or turned one-quarter round upon their respective axes, so as to present nothing but their edges to the eye. The central space between the two columns of shutters serves to render them more distinct to a distant observer, and affords room for the ropes and pulleys by which the telegraph is worked, and which are managed by persons in the observatory below. As shown by the following table, the six-shutter telegraph is capable of expressing sixty-three different signals, by closing one, two, three, or more of the shutters, according to the Arabic numerals in the table, which refer to the numbers inserted in the cut *Fig. 4, A*. The position of the apparatus shown in *Fig. 4, B*, is not counted as a signal ; it being the position of rest.

Table of the Separate or Distinct Signals given by the Six-shutter Telegraph.

1	23	124	236	1245	3456
2	24	125	245	1246	12345
3	25	126	246	1256	12346
4	26	134	256	1345	12356
5	34	135	345	1346	12456
6	35	136	346	1356	13456
12	36	145	356	1456	23456
13	45	146	456	2345	123456
14	46	156	1234	2346	
15	56	234	1235	2356	
16	123	235	1236	2456	

These signals affords the means of expressing each letter of the alphabet, and each of the Arabic numerals, by a distinct and simple sign, and still leave several signs un- appropriated, which may be applied to words or sentences of common use, or to arbitrary signals ; and the connec-

tion between the signals given in the table and the letters or numerals they represent may be varied almost infinitely; so that if, in time of war, the key were to fall into the hands of the enemy, it might be immediately changed. In a modification of this kind of telegraph, intended for night as well as for day service, which was submitted to the Society of Arts, in 1805, by Mr. Joseph Davis, a seventh shutter or board is added, which, instead of being poised on an horizontal axis, is made to slide up and down in grooves in the centre of the framework; so that it may either range with the shutters 1 and 2, 3 and 4, or 5 and 6, or, if not required at all, may descend into a space provided for it in the roof of the observatory. By this simple device the power of the machine is quadrupled; it being rendered capable of making the sixty-three signals shown in the table without the sliding-shutter, and the like number with it in each of its three visible positions, or two hundred and fifty-two changes in the whole.

About the same time that shutter-telegraphs were being introduced in England, the Chevalier A. N. Edelcrantz, of Stockholm, was devising similar machinery for use in Sweden. In 1796 he published an account of his experiments and inventions in the Swedish language, which in 1801 was translated into French and published at Paris, and was noticed in Nicholson's 'Journal' in 1803. A few years later Edelcrantz communicated a model of his telegraph to the English Society of Arts, in whose 'Transactions' for 1808 (vol. xxvi., pp. 184-189), it is minutely described. He commenced his experiments in September, 1794, with a machine resembling that first employed in France; but he soon abandoned it, and adopted a shutter-telegraph with ten boards or vanes, arranged in three vertical ranks, of which the centre one has four, and the others three boards each. By this arrangement 1024 changes or signals may be clearly shown; and it would be possible, by observing the order in which the shutters are exhibited, to show 4,037,912 changes. The minute attention required in this case would, however, occasion some uncertainty; and it is not likely that any circumstances could render so many changes at all desirable. Edelcrantz recommends that the vanes or shutters, which are represented as of a square form, should be painted black, and the frames which support them either white or red; and he says that the intervals between the shutters should be greater than their diameters. The apparatus for working the telegraph is ingenious, but too complicated for description here. It is sufficient to state that, when out of use, the shutters are held open by weights, and that the leverage afforded by the apparatus for closing them is such as to enable one man to hold them all, if necessary, against a high wind, which, it is added, could not be done with the English six-shutter telegraph, notwithstanding the smaller number of vanes, without employing several men. This inconvenience led Mr. Henry Ward, who had observed the difficulty of working the telegraph at Blandford, in Dorsetshire, to contrive an ingenious apparatus which is described in pages 207-8 of the same volume of the 'Transactions' of the Society of Arts as that which contains the communication of the Chevalier Edelcrantz. In this apparatus the grooved wheel or pulley which is fixed upon the axis of the shutter, to receive the rope by which it is turned, has the grooved portion of its rim formed in two segments, which are so attached to the periphery of the wheel by steel springs that they fly off and remain at a little distance from it when there is no strain on the rope; although, so soon as the rope is pulled, its pressure forces the segments into close contact with the solid rim of the wheel. In the segments are formed two notches, which, when the shutter is in either of its required positions, engage with a fixed catch so soon as the strain on the rope is relaxed, and so hold the shutter steady without any aid from the attendant. The pulling of the rope, by drawing the segments close to the wheel, releases the catch, and consequently enables the attendant to return the shutter to its original position. The ten-shutter telegraph of Edelcrantz had, at the date of his letter to the Society of Arts, been in constant use for twelve years, on both sides of the Baltic, and in other places in Sweden; 'chiefly in facilitating the communication of posts between Russia and Finland on one side (of the Baltic), and Sweden and England on the other.' He states that one person was sufficient for working it and making the observations, espe-

cially at the terminal stations; and that six signals usually given in a minute.

Lieutenant-Colonel Macdonald, who greatly preferred numerical to the spelling or lettering system, recon- sidered a shutter-telegraph of still greater power, and consequently of greater complexity, than that of Edelcrantz. His terrestrial telegraph, the advantages of which he has stated at length in two treatises, published in 1808, consists of thirteen shutters, arranged, like those of Edelcrantz, in three vertical sets, which represent, respectively, hundreds, tens, and units. As three boards in each set would only afford seven combinations for each set, he uses four, which give fifteen combinations, which are used to express the numerals from 1 to 9, and the remaining five for abbreviations and arbitrary signals. The twelve ordinary boards are capable of producing 4095 distinct combinations, and the thirteen auxiliary board, which is mounted over the centre of the machine, doubles that number. A flag or vane is attached to the hundred side of the apparatus, to distinguish whatever direction it may be viewed, and a ball is suspended upon the staff which supports it affords the means of doubling the number; so that, in the whole, 16,128 distinct signals may be made with this machine. Macdonald recommends that the shutters be made about 1 foot square; in which case they may be seen with a telescope, in clear weather, at a distance of ten or twelve miles.

Although the shutter-telegraph was originally considered an improvement upon that of M. Chappin, it was so complex as to lead to considerable risk of error unless it were worked by a practised person, especially as he has established the superiority of telegraphs of other kinds with moveable arms; and these have been greatly simplified, so as to avoid the objection raised to the old telegraph. Among the schemes proposed soon after the first practical application of telegraphs, was one which consisted in dividing a large circle into twenty-four parts, the letters of the alphabet, and employing a triangular radius, or index, to point them out; wires being fixed before the object-glass of the telescope to enable the attendant observer to determine the position of the radius, which plan could only be applied to short distances, because the refraction might render it difficult to distinguish small positions so little varying from each other. The radiating principle was, however, adopted in some telegraphs of more practical character; among which the telegraph contrived by the Rev. J. Gamble, which was the original shutter-telegraph has been before mentioned, consisting of five beams or arms pivoted at the top of a vertical post upon one axis, and capable of producing many combinations without using angles of less than 45°. Similar principles were constructed the French cosine telegraphs adopted in 1803, to which the name of cosine telegraph was first applied, and from which it has been derived to other telegraphic machines, the action of which consisted in the motion of arms around pivots parallel to the vertical axis, or near their extremities. These French telegraphs as they were sometimes called, *signal-posts*, consisted of upright posts with two or three moveable arms, supported upon separate pivots, one above the other. They were much known in this country. Captain now General Pasley had been led to observe the inferiority of the common land-telegraph to that used at sea, which consisted of coloured flags, and by which three numbers rather than three numerals combined to form one signal might be readily expressed. To remedy this defect he devised what he termed a 'polygrammatic telegraph' which he published a description in the twenty-ninth volume of Tilloch's 'Philosophical Magazine.' This telegraph, which is represented in Fig. 5, consisted of four

Fig. 5.

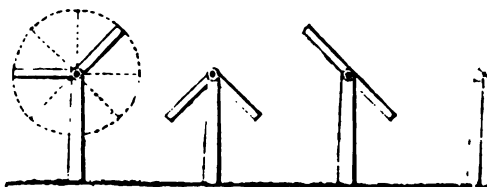

each of which was pivoted a pair of arms. Each arm was capable, by assuming the various positions indicated by the dotted lines added to the first pair, of more than a sufficient variety of distinct signs to express any of the numerals or the 0; and consequently the whole machine could represent any number composed of not more than four figures, besides several signals to spare. In 1809 Captain Pasley improved the French semaphore, which he described in the year, together with a modification of his own Atlantic telegraph, founded upon it, in the thirty-ninth volume of the periodical just mentioned. This telegraphic principle is represented in Fig. 6,

Fig. 6.

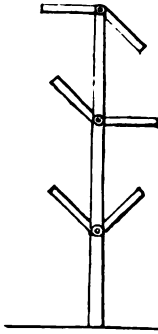

pairs of arms, representing hundreds, tens, and units, pivoted to different parts of the same vertical post. This contrivance is adopted by Lieutenant Macdonald, with very trifling variation, in his explanatory of a new System of Naval, Military, and Commercial Telegraphic Communication, published in 1810, in the addition of a ball and vane at the top of the post. It becomes a machine of the same power as the thirteen-shutter telegraph; as each pair of arms is capable of assuming fifteen distinct positions. Anaphore on the same principle was submitted to the Academy of Arts in 1821, by Lieutenant N. H. Nicolas, and published, together with a method of applying a key to telegraphic communications, for the purporting their secrecy, in the thirty-ninth volume of the Transactions; where, although allusion is made to the similar plan published by Colonel Macdonald, nothing is said of the earlier invention of the telegraph of Lieutenant Nicolas consists of a vertical post with four pairs of arms, one above another, each pair representing units. For each of the three pairs of arms nine positions are all that are required, indicated by both arms being closed into the post, or one concealed from sight; but the upper pair of arms is able to represent any number from 1 to 15, so that the range of the machine is from 1 to 15,999.* This is accomplished by making the right arm represent 1, 2, or 3, to its position as inclined upwards, extended horizontally, or inclined downwards; and assigning to the left arm the number 4 if inclined downwards, or 8 if extended horizontally. 5, 6, 7, and 9 are formed, respectively, by the combination of the signs for 4 and 1, 4 and 2, 4 and 3, and 4 and 4, and, in the case of the pair of arms which represent thousands, the left arm when inclined upwards represents 12; and 10, 11, 13, 14, and 15 are produced by 8 and 3, 12 and 1, 12 and 2, and 12 and 3, respectively.

The telegraphs upon the commercial line of communication recently established between London and the West Indies are constructed upon another modification of the telegraphic principle; four pairs of arms being emitted from a post mounted upon two posts instead of one, as in the machine last described, or four, as in the original machine of Captain Pasley.

It was determined to change the Admiralty telegraphs to semaphores constructed on the principle of the telegraph of France, with the improvements suggested by Sir Home Popham, who had previously done much for the improvement of naval signals. The action of Popham's telegraph is explained by Fig. 7, in which dotted

lines are added to show the various positions in which the arms may be placed, and numerals to show the numbers indicated by those positions. Only two arms are employed; but as they are mounted upon separate pivots,

Fig. 7.

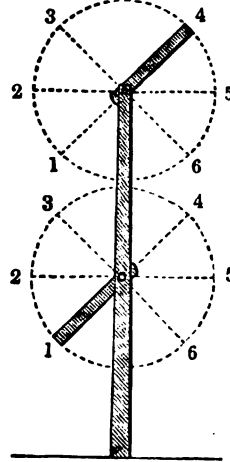

each of them can assume six different positions, and the two together are capable of affording forty-eight signals; which number, though less than that given by the six-shutter telegraph, is sufficient to express the letters of the alphabet and the Arabic numerals, and to leave thirteen signals unappropriated, for abbreviations and arbitrary signs. This kind of semaphore is still used at the government stations; and for the following table of its various changes or positions, and of the letters and numbers indicated by them, we are indebted to the article 'Telegraph,' in the seventh edition of the Encyclopædia Britannica, by Sir John Barrow, one of the secretaries to the Admiralty.

Table of the separate or distinct Signals given by the Admiralty Telegraph, with their respective Significations.

Signals by one and two arms.	Signification.	Signals by two arms.	Signification.	Signals by two arms.	Signification.
1	1	15	G	43	X
2	2	16	H	44	Y
3	3	21	I	45	Z
4	4	22	K	46	
5	5	23	L	51	
6	6	24	M	52	
1	A	25	N	53	
2	B	26	O	54	
3	C	31	P	55	
4	D	32	Q	56	
5	E	33	R	61	
6	F	34	S	62	
11	7	35	T	63	
12	8	36	U	64	
13	9	41	V	65	
14	0	42	W	66	

Sir Home Popham's telegraph, in addition to its superiority in the important quality of simplicity, was a great improvement upon those which preceded it in the details of mechanical construction and in the mode of effecting the required movements. These are minutely detailed and illustrated with engravings, in the thirty-fourth volume of the Transactions of the Society of Arts, in whose museum a model of the telegraph is deposited. The vertical post or beam is not a solid mass of timber, but a hollow hexagonal mast, which, turning on a pivot at its foot, and in a collar where it passes through the roof of the cabin used as an observatory, may be moved so as to display its signals in any direction. The moveable arms are provided with balance-weights in the form of masses of metal attached to their shorter ends, very near to the pivots upon which they turn, by which means they are enabled to move in any direction with the exertion of a very small force; and they

*The maximum number stated in the description of the machine; probably a misprint for 15,999, as no means is described for producing 16, although it is easy to conceive how it might be done.

re made, when out of use, to fall into grooves or recesses in the post, so as to become wholly invisible. The movements are effected by means of two winch-handles near the base of the mast, within the cabin, one for each arm. The winch-handles turn two small vertical bevil-wheels, which communicate motion by means of two horizontal bevil-wheels to long upright shafts or rods, which pass up the inside of the hollow post of the telegraph. At the upper ends of these rods, which are held steady by suitable bearings, are endless screws, which work into toothed wheels fixed upon the axes of the arms, and thereby communicate motion to them. In order that the person who works the machine may know precisely when the arms are brought to the required positions, similar endless screws are added near the lower ends of the vertical rods, to give motion by toothed wheels to indexes, which give a miniature representation of the motion of the arms. Excepting these indexes and the winch-handles, the whole apparatus is enclosed in the vertical shaft of the telegraph, on the outside of which small blocks may be added, to enable a person, with the assistance of a rope from the top of the post, to ascend the machine for the purpose of cleaning and oiling it.

About the same time Sir Home Popham proposed a modification of the semaphore for marine purposes, which, he conceived, would be found very advantageous for the merchant-service, by superseding the necessity for a costly set of signal-flags; the expense and wear and tear of which formed a serious objection to a system of general telegraphic communication at sea, excepting in the ships of the East India Company. His proposed sea-telegraph would not, it is stated, cost more than fifty shillings at first, and its wear and tear would not amount to five shillings a year. As the height of an apparatus resembling his land-telegraph would be objectionable for marine purposes, Popham proposed to use two posts twelve feet two inches high and six inches thick, each having a single arm six feet four inches long and ten inches broad, pivoted to the top, but not falling into a slot in the post, as in the last-described machine. In a small slot at the top of each post is a grooved pulley or sheave fixed upon the same axis as the arm; and at a convenient height from the bottom of each post another precisely similar pulley is mounted in like way, its axis passing through the post, and carrying a small wheel with four handles at right angles with each other, by which the machine is worked; the motion of the lower pulley being communicated to the upper one, and consequently to the arm, by an endless rope, which has two or three turns round each of the sheaves, and passes up by the sides of the post. When the telegraph is in use, the posts may be attached to the side of the vessel by stepping their lower ends into blocks fixed for the purpose, and lashing them to the bulwarks; or they may be mounted upon trucks, so as to be readily moved from one part of the ship to another. The description of this machine in Sir Home Popham's communication to the Society of Arts mentions but four positions for each arm, and states that when placed in the four positions diagonally to the post, one arm denotes 1, 2, 3, and 4, and the other 5, 6, 7, and 8. This arrangement gives twenty-four distinct signals, and avoids the possibility of mistaking the horizontal for an inclined position of either arm, of which there might, owing to the motion of the ship, be some risk.

Major-General Pasley, in a pamphlet published in 1823, entitled 'Description of the Universal Telegraph for Day and Night Signals,' states that, although he at one time considered Popham's arrangements to be judicious, he now deems the use of two separate pivots in the land-telegraph, and of two posts in that for marine use, unnecessary; and that, conceiving simplicity to be of more consequence than the power of making many changes or distinct signals, he has abandoned the polygrammatic principle, and adopted the simple form shown in the next cut, *Fig. 8*, which represents what he styles the 'universal telegraph,' as adapted for day-service. It consists of an upright post with two arms, both attached to one pivot at its upper extremity. Each arm is capable of assuming the seven positions indicated in the cut, besides what is called the stop, which is made when turned down and obscured by the post. Twenty-eight distinct signals may therefore be made by the apparatus, as shown in the subjoined table; these being more than sufficient for the letters of

Fig. 8.

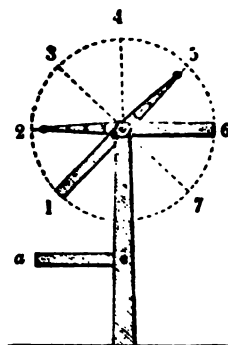

the alphabet, though not numerous enough to form a full alphabet and the numeral characters.

Table of the separate or distinct Signals given by the Universal Telegraph.

1	6	15	25	36
2	7	16	26	37
3	12	17	27	45
4	13	23	31	46
5	14	24	35	47

It had been found, in using Sir Home Popham's telegraphs, that inconvenience and uncertainty were occasioned by the signals being sometimes seen in which case one number or sign would be confused with another; and this circumstance having been mentioned to Pasley by an officer in the navy, he suggested against its occurrence with his universal telegraph the addition of the auxiliary arm, or indicator, marked 4, the cut, which, in whatever direction the arm may be viewed, distinguishes the side at which the signs commence. It serves also to prevent the arm marked 4 from being confounded with the stop, which might be if there were nothing to indicate that the telegraph is at work, and to enable the eye to judge of the height. The arms and indicator of this telegraph are framed and pannelled, for the sake of lightness, and the former move respectively before and behind the indicator only turning up, by means of a rope fixed into a cavity in the shaft, like the arms of Popham's telegraph. The counterbalance weights of the arm are fixed close to the pivot, but extend to some distance, in the form of a slender framework of iron, and at the outer extremity, their light appearance makes them almost invisible at a distance. The motion is effected by an endless chain or rope, with a counterweight for keeping it at the necessary degree of tension. This plan is quicker in action than that of Popham's telegraph; and he observes that if, as in a ship-telegraph, a rope were used instead of a chain, the index attached to the pulley must not be implicitly depended upon. In the subsequent part of his pamphlet he states that, in the case of a rope, it is best to have the pulley-groove of an angular form, or with notches of the same form projecting cleats fixed to their circumference, in order to prevent the turns of the rope round the pulleys from slipping. A friend who was well acquainted with the effects of the climate of India, recommended that no iron should be used in semaphores to be exposed to the sun, and no wood, excepting for the post, which should be made of teak, and for some additional parts required to convert the machine into a night-telegraph, for which bamboo might be used. The pannels of the arms should, in the case of a ship, be made of thin sheet-copper, and the other parts of the machine of brass or bronze. Pasley states that the telegraph should in general be painted black, and, if placed where they may be seen without any background, it should however be painted black, and, if placed where they may be seen without any background, it should be of such a colour as to contrast with it. In the case of a ship, where the appearance of the background may vary much at different periods of the day, it has been found useful to paint the arms white and black, in diagonal lines, each occupying half of the width and half the length of the arm.

The ingenious contrivances which have been suggested for effecting telegraphic communication are so numerous, that anything like an enumeration of

ossible in this place. Several depend upon the appli-
on of arms of various forms to a semaphoric telegraph.
vo-armed telegraph, of which the two arms are diffel-
y shaped, would be capable of making twice as many
als as a two-armed telegraph with both arms of the
orm; but, for ordinary purposes, such an arrange-
ment would have many disadvantages. A machine of this
acter, contrived by Mr. Alexander Law, for both land
sea service, is described in the thirty-third volume of
'Transactions' of the Society of Arts. Another class
elegraphic contrivances depend upon the exhibition of
ces or symbols, in a manner somewhat resembling the
inal contrivance of Dr. Hooke. Of this sort Mac-
l describes one under the name of the 'symbolic
ph,' in which symbols resembling those of Hooke,
representing numerals instead of alphabetic characters,
dropped from three boxes or screens into as many
spaces, which have the values of hundreds, tens, and
respectively. An auxiliary shutter, a ball, and a
or flag, as in his shutter-telegraph, serve to increase
powers of the machine at pleasure. Another contri-
e, which, like the last mentioned, is well adapted for
table telegraph for use in moderate distances, was
nted about the year 1817 by Mr. Conolly, and de-
d by him in a pamphlet published in that year, in
ish and French, entitled 'An Essay on universal
phic Communication,' and also in the thirty-sixth
of the 'Transactions' of the Society of Arts. Co-
nolly's 'Portable Telegraph' consists simply of three square
boards, each with simple devices in black and white, as
shown in *Fig. 9*, the colours on one side being the reverse
of those upon the other. The six figures in the upper row

Fig. 9.

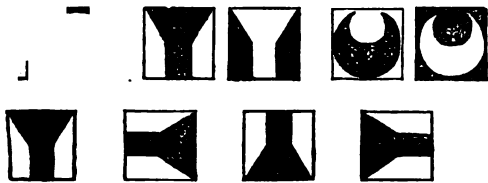

produced upon three boards, and each of these
boards is capable of producing four different signals,
each side of the board downwards in succession,
so that in the four devices at the lower part of the cut,
the three boards afford twenty-four distinct signals,
which is sufficient for alphabetic communication; and one
board is sufficient for making numerical communications,
with the assistance of a smaller paddle-shaped board, the
value of which, when it is used separately, denote affir-
mation or negation. In experiments made at Chatham,
with boards of eighteen inches square were found sufficient
for a distance of two miles, with a telescope with a magni-
fication of twenty-five; and Mr. Conolly had also, it
is said, exhibited these signals between Gros-nez and
Calais, at a distance of seventeen miles, with boards twelve
inches square. The day-telegraph of the Rev. James Brem-
ner, mentioned to in a previous column, consists of a frame-
work of two circular openings, in each of which a semi-
circular shutter revolving upon an axis in the
plane of the circle, is capable of assuming four different
positions. This machine expresses an alphabet of sixteen
characters, by dividing the letters into four classes or sets of
four, and making one shutter express the class, and
the number of the letter in that class. Major
General Hardy communicated to the Society of Arts, in
1808, a telegraphic scheme of very different character to
the one been proposed. His telegraph consists of a
framework with nine radiating bars, representing
the numbers from 1 to 9, and four sets of other bars in-
cluding 0, in such a manner as to form four con-
centric polygons (the whole apparatus having somewhat
the appearance of a spider's web), which polygons express
thousands, hundreds, tens, and thousands; and thousands
expressed by the innermost polygon. Attached to the
framework of the machine by pivots are four slender arms, car-
rying any square boards of sufficient size to be visible
at a distance; and the respective lengths of these arms being
such that the board of one may, during the revolution of
the arms, traverse the polygon which represents thousands,
the other the hundreds polygon, &c. The action of

the apparatus is as follows:—If it be desired to express the
number 9202, the shortest arm is placed in such a position
that its board may rest upon the radius 9, at the point
where it is intersected by the thousands or innermost
polygon; the next arm is turned to the radius 2, its board
covering the point of intersection between it and the
second, or hundreds polygon; the third arm and board is
not called into action at all; and the fourth is, like the
second, turned to the radius 2, the board covering the in-
tersection between it and the outermost or units polygon.
Thus far therefore the machine can express any number
from 1 to 9399; but its power is increased by the addition
of two other boards at the upper corners, one of which
denotes 10,000, and the other 20,000, or, when displayed
together, 30,000; so that the total range of the telegraph
is from 1 to 39,999.

Several modes of telegraphic communication without
machinery, or with nothing which cannot be conveniently
carried by hand, have been devised, especially for the
purpose of directing military operations, or of conveying
speedy intelligence in time of war, where no line of ordi-
nary telegraphs can be established. In 1808 such a plan,
under the name of an 'anthropo-telegraph,' was laid
before the Society of Arts by Mr. Knight Spencer, whose
communication was printed in the twenty-seventh volume
of their 'Transactions.' Mr. Spencer had observed, in the
volunteer service, the inconvenience and loss of time occa-
sioned in passing the orders of the commander-in-chief to
the officers commanding distant divisions, when a great
number of men were manœuvred together, and this led
him to devise the plan alluded to, which he put in practice
for the first time in 1805. His apparatus consisted simply
of two circular discs of wicker-work, about eighteen inches
in diameter, with handles six inches long, painted white, with
a black circle or ball in the centre. As these did not weigh
more than about a pound each, a man could easily hold
them, one in each hand, in any required position. Stand-
ing in the position of the first figure in the subjoined
cut, *Fig. 10*, with both discs held down and turned edge-
wise to the observer, the telegrapher indicated 'attention';
in the second position, he expressed a desire to convey in-
telligence to the correspondent at a distance; turning

Fig. 10.

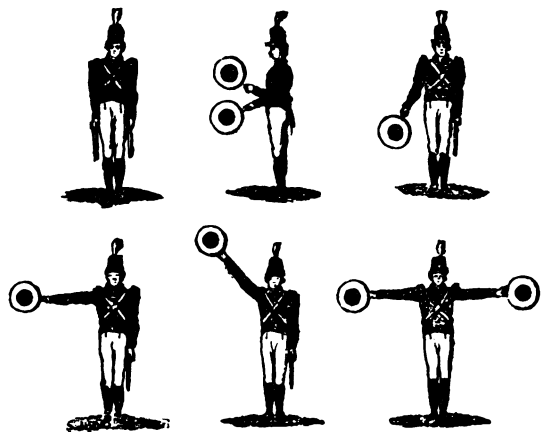

one-quarter round again, and displaying one disk as shown
by the third figure, he expressed the number 1; in the
next position, 2; in the fifth, 3; 4, 5, and 6 were expressed
by positions the reverse of 1, 2, and 3; the right-hand disk
being held edgewise, and the other displayed; 7 was
shown by displaying both discs in the lowest position;
8, as shown by the last figure in the cut, by both held out
at arm's length; and 9, by both elevated; 0 was given by
holding both discs above the head, one behind the other,
so as to appear but one; and the signal of 'point' or
'period,' used at the close of every number, by placing
the right hand disc in front of the breast, and the other
behind the back, so that, like all the other signals, it might
be seen both in front and rear. Another position, formed
by displaying the right hand disc in the position 1 and the
left hand disc in the position 6, formed a signal of 'error,'
to be used in case of any mistake which might require the
repetition of a signal. By this simple arrangement any

number might be readily expressed; and consequently it might be applied to any numerical dictionary whatever. Signals might also be made at night, by attaching reflector-lamps to the discs, in such a manner that they might hang vertically in every position of the discs, and strapping another lamp, glazed with green glass, upon the breast of the telegrapher. If intermediate stations be required, there must also be lamps upon the back of the man and of the discs. The difference of colour between the lamps upon the body of the telegrapher and those attached to the discs is essential to the distinct perception of some of the signals; and the difference between 'attention' and 'point' or 'period,' in nocturnal telegraphing, depends solely upon it. A letter from Admiral Hunter accompanies the description; in which, after expressing a very favourable opinion of the plan, he recommends enlarging the discs to two feet diameter, and painting one side as above described, and the other with a white centre and black rim, so that either might be used, according to the state of the weather.

In the volume from which the above details are taken, there is also an account of a yet simpler contrivance, invented by Lieutenant Spratt, for telegraphing by means of a white handkerchief, held in various positions to express the numeral characters and a few other convenient signs. The inventor employed this mode of communication some time before the battle of Trafalgar, as a means of carrying on conversation with a distant vessel; and he had used it successfully to converse between Spithead and the green ramparts at Portsmouth, &c. With a common telescope it may be used at a distance of four miles. Macdonald describes some more complicated contrivances of similar character, by the display of small flags, or of two white handkerchiefs and a black hat; by the latter of which plans between fifty and sixty distinct signals may be made. He also shows how signals may be made to any required extent by men changing their positions from sitting to standing, &c. Twelve men, arranged in three sets of four men each, may in this way be used instead of his large shutter-telegraph.

Some of the earliest methods of telegraphic communication which have been noticed above were essentially adapted for nocturnal use; but in modern times the use of night-signals has not been extensively required, although provision might have been made for their exhibition in connection with many day-telegraphs. Thus, for instance, it was proposed to add lamps to the moveable parts of Chappe's telegraph; and Edelcrantz suggested the application of lamps to his ten-shutter machine. In Davis's seven-shutter telegraph, previously described as applied to day-service, night-signals were to be given by a coloured lamp mounted in the centre of the seventh or sliding shutter, and six white lights attached to the outside of the frame, to produce, by their display or concealment by slides, the same signals as, under ordinary circumstances, are given by the opening and closing of the shutters. These sidelamps were to be secured to upright pieces of wood, sliding up and down in dovetailed grooves in the outside of the frame-work, so that they might be readily withdrawn when not in use. Provision is made for the adaptation of Pasley's universal telegraph to nocturnal communication by adding a central light at the top of the post, a lamp to the extremity of each arm, and an additional light as an indicator, suspended from a light derrick or crane projecting horizontally beyond the range of the arms, and on a level with the top of the post. Thus, the lamps themselves, and the additional counterweights required with them, should all be removed during the day. How little necessity there is, under ordinary circumstances, for the use of telegraphs by night, at any rate in connection with the navy, may be assumed from the statement of Sir John Barrow, that no attempt was ever made to add lamps to the six-shutter telegraphs formerly used by the Admiralty, notwithstanding the ease with which it might have been done. The semaphores now used by the Admiralty are also constructed without any provision for the display of night-signals. Macdonald's treatise (1817) contains several schemes for night-telegraphs, both for land and sea; one of which, consisting of three sets of four lights each, with an additional or director light to each set, has the same extensive powers as his favourite large shutter-telegraph.

Marine telegraphic communication is an object of even greater importance than that which has been principally treated of in this article, since there are many circum-

stances which render personal communication of vessels at sea impracticable, and that sometimes the greatest emergency. But, although navigation has, of necessity, long used, and flags of different colours have been extensively employed for the purpose of making them, it was not till within a very recent period that they were reduced to an efficient telegraphic system. Sir Isaac Newton states (*Ency. Brit.*, art. 'Navy') that 'The system of bearing the flags, and of assigning a certain number to each, in corresponding sentences to certain combinations of numbers, was reduced to something approaching a regular system in the fleet of Lord Howe; and that in 1798 a new signal-book was issued by the Admiralty, to which were made by a number of references to flags. This book contained about 1000 sentences, expressive of the most usual operations of the fleet; but it was so imperfect that, if any signal were transmitted which was not to be found in the book, it became necessary to make the signal for each ship;' an order which could not always be complied with. This inconvenience was remedied by a suggestion of Sir Home Popham, of making the flags represent the letters of the alphabet, as well as numbers, in connection with numbers. This was also printed, at Calcutta, a new code of naval signals, which was subsequently reprinted in England, and adopted for use in the navy. Among the improvements introduced by him is a new arrangement of the signal flags, so that, as he explained in his Report of Aids in 1816, 'the selvages of the bunting on the outer edges of the flags, and the white centre; by which means the outer edge is the least air of wind, and when the flag is hoisted the selvages assist in keeping it out; whereas the white centre, which rendered them liable to be moved without a fresh breeze, especially in rainy weather, as the hem then became the point of contact.' Besides, he adds, 'it is impossible, from the nature of the bunting, to sew a straight seam, for the seams will become in some degree curved.' (*Transactions of the Royal Society*, xxxiv., p. 174.) The only objection urged against the code of naval signals now in use is one which, in the code in question, amount to four different numbers, namely, the great number of flags, for making numerical signals to the extent of 10,000, which, in the code in question, amount to nine different numbers, namely, four, five, six, seven, eight, nine, ten, eleven, twelve, thirteen, fourteen, fifteen, sixteen, seventeen, eighteen, nineteen, twenty, twenty-one, twenty-two, twenty-three, twenty-four, twenty-five, twenty-six, twenty-seven, twenty-eight, twenty-nine, thirty, thirty-one, thirty-two, thirty-three, thirty-four, thirty-five, thirty-six, thirty-seven, thirty-eight, thirty-nine, forty, forty-one, forty-two, forty-three, forty-four, forty-five, forty-six, forty-seven, forty-eight, forty-nine, fifty, fifty-one, fifty-two, fifty-three, fifty-four, fifty-five, fifty-six, fifty-seven, fifty-eight, fifty-nine, sixty, sixty-one, sixty-two, sixty-three, sixty-four, sixty-five, sixty-six, sixty-seven, sixty-eight, sixty-nine, seventy, seventy-one, seventy-two, seventy-three, seventy-four, seventy-five, seventy-six, seventy-seven, seventy-eight, seventy-nine, eighty, eighty-one, eighty-two, eighty-three, eighty-four, eighty-five, eighty-six, eighty-seven, eighty-eight, eighty-nine, ninety, ninety-one, ninety-two, ninety-three, ninety-four, ninety-five, ninety-six, ninety-seven, ninety-eight, ninety-nine, one hundred. The number, he states, it is next to impossible, in a flag-telegraph, to make out the figure and colour of the flags when they are so when, though expanded by the wind, the observer causes them to present only an indistinct appearance to the eye. He conceives that Popham's sea-telegraph, as before described, is capable of entirely removing this difficulty; and that possibly Pasley's universal telegraph might be applied in like way with advantage.

The principle of the numerical system of flag-telegraphs in the navy is briefly explained by Macdonald. Nine different variegated flags are used to express the numerals 1 to 9, another for 0, called a *substitute*, to repeat any flag and to be hoisted, in case of the same numeral occurring more than once, the number to be expressed. A pendant flag is used in some cases as a substitute for the uppermost flag. Thus, by the use of eleven different flags, any number from 1 to 999 may be expressed by playing more than three flags, or two flags at once. In a telegraphic system devised by Pasley, and fully explained in the *Transactions of the Royal Society of Arts* for 1817 (vol. xxxv., pp. 205-208), flags are used to express numbers in a different manner. The basis of the system is an alphabetical list of the necessary English words, arranged in a table, the figures in the common multiplication table, the columns and horizontal lines being numbered from 1 to 999, ninety-nine of each; and consequently the total number of divisions is 9801. The number of flags is ever greater, because in some cases, where the number is likely to be occasioned by it, the number of flags is increased. Several of its modifications are placed in a separate division of the table. The signals consist of flags (ten for the numerals and 0, a substitute for a comparative signal), the same number of triangles

colours and devices, and a pendant; and any word used in the table may be expressed by one or two flags to indicate the number of the vertical column in which it occurs, and one or two triangular flags hoisted to them, to point out the horizontal column. In both the square and the triangular flag requiring doubled at once, instead of the two substitutes, the first is hoisted between them; and if it be necessary to any name or word not contained in the vocabulary, a fifth triangular flag (answering to the square previous signal) is hoisted to indicate that the twenty-flags are to be taken for the letters of the alphabet, being in a preconcerted order.

It should not quit the subject of marine telegraphs to advert to the very important advantages likely to accrue to the commercial shipping interest by the adoption of a simple and uniform code of communication between vessels at sea, and from them to coast towns, or *vice versa*. This desirable object is now being promoted by the commercial telegraphic association, superintended by Mr. B. L. Watson, whose signal are, in future, by the direction of the Lords of the Admiralty, to be supplied to all the government vessels, so that they may communicate with such merchant vessels using the code as they may meet with at sea. The code consists of thirteen flags, by which any message may be communicated from one vessel to another, or from a vessel at sea and any of the coast-stations established by the association at prominent points around the islands. In connection with these coast-stations there are lines of semaphores from the Downs to Dover; from Holyhead to Liverpool; and from the Downs to Hull; and from all of them communications are sent to a central office in London, and also to the agents or consignees of vessels entered in the telegraph for which privilege a subscription of twenty shillings annually is paid to the association for each vessel. In this manner any message from the owners of a vessel, or to change of destination, or otherwise, can be communicated from any station within sight of which she passes.

It is now noticed the principal varieties of telegraphs, and by displaying signals visible at a distance, whether used on land or at sea, it only remains, before we resort to contrivances of a different character, very briefly to mention upon a few points which bear upon telegraphic communications generally, but more especially upon land. The subject has been so ably treated by Sir John Barrow, in an article before alluded to, with the peculiar advantage derived from his connection with the Admiralty, that we cannot do better than condense some of his remarks on the comparative merits of different telegraphic systems. He observes that a telegraph employed for the purposes should be possessed of *power, certainty, simplicity, celerity, and secrecy*. It should have sufficient force to express, by distinct positions or combinations of parts, any possible order or information, either by words, or sentences. Its certainty will depend upon its parts being clearly defined, wholly within the field of the telescope, and so distinct that there shall be no risk of mistaking one signal for another; whence the simplicity of simplicity becomes obvious. Bearing these things in mind, Barrow conceives that the choice will be made between the six-shutter telegraph, Popham's telegraph, and Pasley's universal telegraph. Macdonald's telegraph the arms of the semaphore are not so distinct in clear weather, and not near so visible in foggy weather, as the boards of a shutter-telegraph; but some observations of Mr. Gamble, which tend to the contrary result; making it appear that, owing to the diffraction of light in the image on the retina, occasioned by the haze of the atmosphere, the property which he terms *distinctness* is generally more requisite than mere superficial distinctness, to give distinctness to a distant object. This is illustrated by supposing a person to look at the letter 'A' in the midst of a printed page, and to remove the paper from the eye until the image becomes indistinct and confused with the surrounding letters; and the letter 'A' much more distinct the image would appear if the letter were printed alone upon a sheet of white paper. This question however does not rest upon mere analogy; for it is stated that every officer upon the Admiralty line bears testimony to the superior distinctness of the semaphore at all times, and especially in cloudy weather. In order fully to decide the question, the shutter-telegraph at Nunhead, near New Cross, was left standing for some time on the same hill as the new semaphore; and the result of the trial for a whole winter was, 'that the semaphore was frequently distinctly visible when the boarded telegraph was so much enveloped in mist and fog that the particular boards shut or thrown open could not be distinguished;' and that the number of days in the course of the winter upon which the semaphore was visible exceeded those upon which the shutters could be seen by fully one-third. Even in the six-shutter telegraph one shutter was occasionally mistaken for another, and such accidents would doubtless have been more common had a more complicated shutter-telegraph, like that of Macdonald, been employed. The objection urged against the semaphore on the ground of the longer time taken to move the arms, because they describe arcs of larger circles than the boards of a shutter-telegraph, is hardly deserving of notice, as the difference (which may, Barrow says, amount to one second in each signal) is amply compensated by the greater facility of reading off. The semaphore has also the advantage in the greater simplicity of its machinery, which is much less liable to get out of order than that of the boarded telegraph.

As shown by the tables given in the previous descriptions of the three machines particularly noticed by Barrow, the shutter-telegraph has the power of making a greater number of combinations without the use of the stop-signal (or signal which separates one word or one sentence from another) than either of the others, and Pasley's universal telegraph has the least power; but this is of little consequence, if the lowest power prove sufficient. Although the primary signals of the universal telegraph are only 28 in number, they may be increased to 784 by the use of two changes with one stop-signal between them (making three signals in the whole), or, by making three changes (four signals, with the stop), to 21,952; a number considerably exceeding the words and sentences in Sir Home Popham's telegraphic dictionary, which do not exceed 13,000. As this dictionary has never, it is affirmed, been found materially deficient in any of its divisions of subjects, it is evident that even when applied to communication by words and sentences instead of by letters, Pasley's simple telegraph affords sufficient power for all useful purposes; and further, that those who have extended their telegraphic dictionaries to very high numbers (Pasley mentions one extended to 140,000), have impaired their usefulness, owing to the difficulty and loss of time in finding the required sentence among so many. 'We have actually seen in one telegraphic dictionary,' observes Sir John Barrow, '120 pages, of three columns in each page, and sixty sentences in each column, containing upwards of 20,000 sentences (about one-third of the number of sentences in Johnson's dictionary), and each of these sentences beginning with the personal pronoun "He;" 20 pages with "If," &c.' 'Compared with the use of such a dictionary,' he proceeds to say, 'spelling the sentences is infinitely preferable as to certainty, and in many cases as to celerity. Indeed we should say that the abbreviated nature of communications made by telegraphs renders spelling by far the most eligible mode. In clear weather the rapidity of working single signals, the short compass within which any message may be condensed, the impossibility of committing any mistake that cannot be immediately rectified, more than compensate for the difference of a few minutes which the use of sentences may probably save. In cloudy or foggy weather, the latter method will always be liable to mistake. If experience may be assumed as a guide, the practice at the Admiralty of spelling all sentences, for the last thirty years, must decide in favour of that system.' In making communications alphabetically, much time may be saved by omitting non-essential words and letters, especially vowels. For example, the meaning of the sentence 'Order the Agamemnon out of harbour, and direct her to proceed to Spithead,' may be sufficiently expressed by 'Agmemn. to Spthed.' It is also important to condense the substance of the communication as much as possible into the former part of the message, so that no serious mistake may arise if the communication should be interrupted by foggy weather. Barrow relates a circumstance which occurred during the Peninsular war, in which some anxiety was occasioned by

the non-observance of this principle: a despatch from Plymouth to convey intelligence of a British victory having been commenced by the words 'Wellington defeated,' and then broken off by fog, which prevented the whole meaning, 'Wellington defeated the French at,' &c., from being transmitted. Had the message run thus, 'French defeated at,' &c., the interruption of the despatch would have been of far less consequence.

Any means of telegraphic communication which depends upon the deciphering of signals exhibited at a distant station is necessarily dependent upon contingencies of weather; but many plans have been contrived for effecting the object in such a manner as to be independent both of light and of the state of the atmosphere. For communication between the different parts of a house this object may be effected by a mechanical connection, by chains or wires, between two dials with revolving indexes or pointers, in such a way that when one pointer is directed to a particular letter or word inscribed upon the dial to which it is attached, the other may exhibit a similar movement. The attention of the servant is engaged previously by ringing a bell; and when the required signal has been made, a spring returns both indexes to their original position. Such a plan, though very useful for domestic purposes, is not adapted for distant communication. Speaking-pipes, or tubes to convey the voice from one place to another, are also available for short distances, but their range is too limited for application on an extended scale. One of the early schemes of this character depends upon the principle of water always finding its level; but, independent of the difficulty which might arise from the friction of water in a very long pipe of small diameter, such as would be required to connect the vertical tubes in which the observations would be made, such a plan involves the necessity of having all the communicating stations at or near the same level. Other hydraulic telegraphs depend upon the incompressibility of water or other liquids; it being proposed to lay down small pipes of any required length, and to indicate different signals by pressing more or less upon the surface of the fluid contained in them, which would, it is supposed, transmit the motion to the opposite end of the pipe, where it might be pointed out upon a dial, or in any other convenient manner. Mr. Vallance described such a method of telegraphic communication in a pamphlet, published in 1825, of which Hebert gives some account (*Engineer's and Mechanic's Encyclopædia*, vol. ii., pp. 767-8); and some similar schemes have been more recently propounded. Air confined in small pipes has also been tried to a limited extent as a pneumatic telegraph: but in this, as well as in the hydraulic system, the risk of leakage is a serious disadvantage. The application of electricity to telegraphic communication is attended with fewer difficulties, and has recently been carried into effect on an important scale by Messrs. Wheatstone and Cooke. The possibility of so applying it was conceived by several persons long before it was attempted on a practical scale. Arthur Young, who visited France in 1787, 1788, and 1789, mentions, in his travels, the experiments of M. Lomond, who was able by means of electricity to convey messages from one room to another; and the Rev. Mr. Gamble, in his description of his original shutter-telegraph, alludes to the project of electrical communication. Mr. Francis Ronalds, in a pamphlet on this subject, published in 1823, states that Cavallo proposed to convey intelligence by passing given numbers of sparks through an insulated wire; and that, in 1816, he had himself tried experiments upon this principle, which he deemed more promising than the application of galvanic or voltaic electricity, which had been projected by some Germans and Americans. He succeeded perfectly in transmitting signals through a length of eight miles of insulated wire; and he describes minutely the contrivances necessary for adapting the principle to telegraphic communication.

It is however to the joint labours of Messrs. W. F. Cooke and Professor Wheatstone that electric telegraphs owe their practical application; and in a statement of the facts respecting their relative positions in connection with the invention, drawn up at their request by Sir M. I. Brunel and Professor Daniell, it is observed that 'Mr. Cooke is entitled to stand alone, as the gentleman to whom this country is indebted for having practically introduced and carried out the electric telegraph as a useful undertaking,

promising to be a work of national importance: Professor Wheatstone is acknowledged as the scientific whose profound and successful researches had already prepared the public to receive it as a project capable of practical application.' Their telegraph, which was put in 1837, acts upon principles founded on Oersted's celebrated discovery, that a magnetic or compass needle, through the agency of a voltaic current, be invested with an artificial polarity. [ELECTRO-MAGNETISM, vol. 342.] 'Thus,' explains Mr. Cooke (*Telegraphic ways*, p. 14), 'as a natural stream of electricity flows round the circumference of the earth causes magnetic needles in general to be deflected at right angles to its course, or towards the north and south poles, so an artificial stream of electricity of adequate strength will magnetic needles placed within its influence to be largely deflected at right angles to its course, whatever may be. If then a magnetic needle were placed near and near to any part of a conducting wire, which we suppose to be laid down between London and Bath, the transmission of an electric current from a voltaic battery would cause the needle to change its position to stand during the continuance of the current at right angles to the wire, being turned in one direction or other according to the course of the current. If the flexion of the needle were limited by two fixed stops placed respectively at the two sides of one of its poles, the motion of that pole to one stop might evidently convey one signal, and its motion to the other stop another. Such an apparatus is shown in Fig. 11, the dial upon which the signals are represented being removed. In this

Fig. 11.

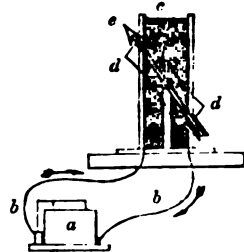

may be supposed to represent the battery, and *b b* the conducting wire, which is formed behind the dial into a coil: *d d* is the magnet, which is mounted upon an axis passing through the dial, and carrying upon its extremities an index or pointer *c*; arrows indicate the direction of the current required to deflect the magnet to the position indicated in the dial, and a current in the opposite direction would produce a deflexion towards the opposite side. While no current passes through the wire, the magnet and pointer stand vertical. The next cut (Fig. 12) represents three

Fig. 12.

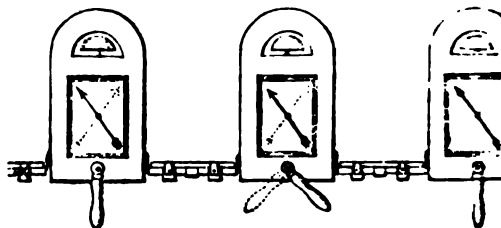

instruments complete, and connected together by wires enclosed in tubes, which may be of any required length. One of these may be supposed to be at the Minor station next at an intermediate station, and the third at Bath; and as each is provided with a battery, and a dial (beneath the dial) by which the conducting wire is connected with it at pleasure, the attendant at any station at which such an instrument is placed can simultaneously communicate the signal to 'stop' or to 'go' to all the other stations: attention being previously engaged by ringing a bell, placed above the dial, by the ingenious application of the voltaic current. By this wonderfully simple apparatus the peculiar method of working the trains upon the Blackwall railway [RAILWAY, vol.

is effected with the greatest ease, although it is vital that the attendants at each terminus should know when the train is ready to start from the opposite of the line, but also when the carriages at the five intermediate stations are ready. In stopping the trains the precise information is required; and it is of vital importance in case of any casualty to the rope or to any of the carriages. It is perhaps not too much to say that the mode of working adopted on this railway would be imitable without the aid of the electric telegraph. Telegraphs of more extensive powers than the above are in use on the Blackwall railway, as well as on the Great Western and Edinburgh and Glasgow lines. Fig. 13. which represents a dial like that on the Great Western railway, shows how, by the combination of four such dials and pointers as are described above, all the letters of the alphabet may be expressed, by pointing one or two

Fig. 13.

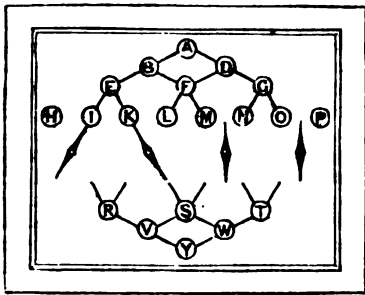

pointers towards them; and of course a larger or smaller number of signals might be made on the same principle if necessary. A telegraph with two pointers, showing eight letters, is considered by Mr. Cooke to be sufficient for all ordinary purposes. The wires, where several are used, are combined into a rope and enclosed in an iron tube, which may be either buried beneath the surface of the earth or supported above it; and they are insulated from each other by wrapping them round separately with a mixture of gutta serena and caoutchouc. For details of construction as applied to various purposes, and for an exposition of the advantages derivable from the use of the electro-magnetic telegraph, especially in connection with railways, we must refer to the publications of Mr. Cooke, the reports of the Select Committee of the House of Commons on 'Railway Communication' in 1840; and the 'Railway Telegraph' for June 12, 1841. The longest continuous line yet completed is that from Paddington to West Drayton, about 12 miles; but this has been so arranged for the purpose of experiment as to be equal to a stage of thirty-nine miles. It is reported (July, 1842) that an electric telegraph is about to be laid down along the South-Western railway, from London to Gosport.

See *Lampton's Polybius*; Bishop Wilkins's *Secret and Swift Messenger*; Derham's *Philosophical Experiments*; Macculloch's *Treatise on Telegraphic Communication*, 1817; and *Wheatstone's Description of the Universal Telegraph*, 1823; *Wheatstone's Descriptions of an Electrical Telegraph, &c.*, 1823; *Cooke's Telegraphic Railways*, 1842; *Transactions of the Society of Arts*; *Encyclopædia Britannica*.

TELEMACHUS (Τηλεμάχος), the son of Odysseus and Penelope. When his father joined the Greek expedition against Troy, Telemachus was a young man, but during his father's absence he grew up to manhood. When the gods had decreed that Odysseus should return home from the island of Ogygia, Athena appeared, assuming the appearance of Menelaus, and advised him to send his suitors of his mother; but if Penelope should refuse, he should try again, to send her to her father's house, where she might celebrate her nuptials there. She also advised him to sail to Pylos and Sparta, to see whether he could learn anything concerning his father, who, as she supposed, was probably still living in some island where he was detained; but if he should be dead, she enjoined him to raise a monument to his memory, and to drive away all the suitors of his mother either by stratagem or by force. Telemachus obeyed the commands of the gods, and visited Nestor at Pylos and Menelaus at

Sparta. Both of them received him hospitably, and Menelaus communicated to him the prophecy of Proteus about his father. In the meantime Odysseus arrived in Ithaca, and lodged with Eumæus, the swineherd, in the disguise of a beggar. In this condition he was found by Telemachus, who, by the advice of Athena, had also returned to Ithaca. The father made himself known to his son, and the two devised a plan for getting rid of the suitors. They went to the town, and Odysseus was admitted as a beggar to a feast of Telemachus and the suitors. When the suitors began to insult the poor man, a fight ensued, in which Odysseus and Telemachus killed the suitors. Telemachus then accompanied his father to the aged Laertius. Thus far the story is described in the *Odyssey*. Later writers mention other incidents connected with the story of Telemachus, especially relating to his marriage, which however is told in different ways. According to one tradition, he married Circe or her daughter Cassiphone, and he had a daughter Roma, whom he gave in marriage to Aeneas. Servius (*ad Aeneid.*, x. 167) calls him the founder of the town of Clusium in Etruria.

In modern times the name of Telemachus has acquired celebrity from the moral romance of Fénelon, which is based upon the story in the *Odyssey*. [FÉNELON.]

TELEMANN, GEORG PHILIPP, a name of no mean rank in musical history, therefore entitled to some notice here, was son of the minister of the Lutheran church at Magdeburg, and there had his birth, in 1681. Though educated with other views, his predilection for music was too strong to be combated, and it became his profession. He successively held many appointments in Germany, the chief of which was that of composer to the Lyric theatre at Hamburg, for which he produced no less than thirty-five operas. But these were only a small part of his labours: he is said to have exceeded the prolific Alessandro Scarlatti in the number of his works for the church and the chamber; and, in 1740, his overtures on the model of Lulli amounted, Doctor Burney tells us, to six hundred! Strange however as it may appear, yet it is most true that of this almost incredible number of compositions, only two or three fugues are now known, at least in England, and these only to a very few organists of patient and deep research.

Telemann was a fellow student of Handel, and attained considerable longevity, having died in 1767, at the age of 86. He was twice married, and each wife had ten children; and it is remarkable that not one of them manifested the slightest inclination for the art to which their father owed his fortune and repute.

TELEOSAURUS. Since the article *CROCODILE* was written, Professor Owen has published his valuable *Report on British Fossil Reptiles*, in which he notices, among others, a family of extinct crocodylians characterized by a combination of a bi-concave structure of the vertebrae with long, narrow jaws, armed with slender, conical, sharp-pointed, and equal teeth, adapted, like those of the existing Gavials, for the seizure and destruction of fishes. Professor Owen makes this family consist of two genera, whose characters mainly rest on the difference of position in the external nostril. In the first of these, *Teleosaurus*, the external nostril is terminal and placed at the extremity of the upper jaw; in the other, *Steneosaurus*, this aperture is a little behind and above the termination of the upper jaw.

Geological Distribution and Habits of the Family.—The *Teleosauri* and *Steneosauri* are confined to the oolitic division of the secondary rocks. At this period there were scarcely any mammals, but fishes were abundant, and Professor Owen refers to the just observation of Dr. Buckland in his *Bridgewater Treatise*, that it might, *a priori*, have been expected that if any crocodylian forms had then existed, they would most nearly have resembled the modern Gavial. Professor Owen goes on to remark that the modification in the structure of the vertebral column, and the complete mail of imbricated bony scutes, characteristic of the species, indicate that the habits of the ancient *Teleosauri* and *Steneosauri* were more strictly marine than those of the modern Gavials, and that their powers of swimming, of pursuing and overtaking their aquatic prey, were greater.

After noticing the papers of Messrs. Wooller and Chapman, in two separate communications in *Phil. Trans.*, vol. 50, 1758, and the figures of an incomplete skeleton

there given, as one of the earliest evidences of antient reptiles which is recorded in a scientific publication, and observing that, notwithstanding the remark of Captain Chapman, that 'it seems to have been an alligator,' and of Mr. Wooller, that 'it resembles in every respect the Gangetic Gavial,' Camper pronounced it to be a whale, meaning perhaps a dolphin; an opinion adopted by Faujas, who went a step further, and referred it to the genus *Physeter*. Professor Owen points out Cuvier's refutation of Faujas in the first edition of the *Ossemens Fossiles*, and his declaration in the same work that it was in truth a crocodile. The Professor adds, that Cuvier's subsequent analysis led him (in 1812) to the conclusion that it belonged to the genus of Crocodiles, and was most probably identical in species with the crocodile of Honfleur.

But although the opinions of Messrs. Wooller and Chapman came much nearer to the truth than those of Camper and Faujas, they were still distant from it; and Professor Owen proceeds to show that the fossil really differs more from the Gavial than the Gavial does from any other existing Crocodilian.

Pursuing his inquiry, Professor Owen remarks, that in 1836, when so many new and singular genera, allied to the Crocodilian family, had been added to the catalogues of palæontology, by the labours of English anatomists and geologists principally, Cuvier expresses his opinion with more caution. Cuvier then says, 'It now remains to be known whether it is a crocodile, or one of those new genera discovered in the same beds. The bones of the extremities are too incomplete, and the head is not represented with sufficient details, to decide the question; but the vertebræ appear to me to be longer, in relation to their diameter, than in the new genera, and, in this character, more like those of Crocodiles. Those alone who shall rediscover the original, if it still exists, will be able to inform us whether the other characters respond to those referred to.'

Professor Owen inquired at the British Museum, to which the collections formerly belonging to the Royal Society of London were transferred, but he states that no specimen corresponding with the account and figures given by Messrs. Wooller and Chapman exists in that museum.

But a second specimen of a Crocodilian with a long and slender nose was procured from the lias near Whitby (between Staiths and Runswick) in 1791, and a more perfect skeleton was obtained from the alum-shale of the lias formation at Saltwick, near Whitby, in 1824. Professor Owen states that both these specimens so closely resemble the older fossil in all the points in which a comparison can be established, as to dissipate the remaining doubts as to the nature and affinities of the specimen from the same locality described in *Phil. Trans.*, 1758. He then refers to the figures of the skeleton discovered in 1824, in Young and Bird's *Geological Survey of the Yorkshire Coast*, and in Dr. Buckland's *Bridgewater Treatise* [CROCODILE, vol. viii., p. 169], observing that it is now preserved in the museum at Whitby, where he closely examined it. 'In this specimen,' says the Professor, 'are preserved the cranium, wanting the snout, the whole vertebral column, the ribs, and the principal parts of the four extremities, together with the dorsal and part of the ventral series of dermal bones. The entire length of the skeleton, following the curvature of the spine, is fifteen feet six inches, to which may be added two feet six inches for the lost snout. The cranium posteriorly is broad, depressed, and square-shaped: it begins to contract anterior to the orbits, and gradually assumes the form of the narrow depressed snout; the converging sides of the maxillæ are concave outwardly. The zygomatic spaces are quadrilateral, longer in the axis of the skull than transversely; the orbits are subcircular; they look upwards and slightly outwards; their margins are not raised, and their interspace is slightly concave. The parietal bone is relatively longer than in the Gavial, and sends up a longitudinal median crest, from the posterior part of which a strong process extends on each side outwards, and curves slightly backwards parallel with the ex-occipitals, to join the mastoid and tympanic bones, the latter of which expands as it descends to form the joint for the lower jaw.'

Professor Owen then gives details of the dimensions, from which he calculates that the entire length of the skull must have exceeded 4 feet 6 inches. He states that

the cranium of one of the Caen Teleosauri measured 4 inches, whence Cuvier calculates the entire length of the animal at near 15 feet. Professor Owen refers the Whitby Teleosaur to the genus *Teleosaurus*, which differs from the Gavial in the following particulars: the anterior frontal bone is less extended upon the orbit; the lacrymal is much more extended, and is on the base; and the jugal bone is more slender. The frontal bone, which separates the temporal orbital cavities, is much longer and narrower. The frontal and occipital crests each form a thin trench, and are not flattened above. The mastoid is not uninterruptedly united with the back part of the malar process of the tympanic; it is separated from the malar by a large depression, which is overarched by a trench belonging to the ex-occipital. The mastoid is not united with the malar by a concavity at its descending part, of which there is no trace in the Gavial. The indentation between the malar process of the tympanic and the tuberosity of the basi-occipital is much smaller than in the Gavial; the basilar tuberosity projects downwards in a level with the pterygoid ala is not expanded externally as in crocodiles, but is contracted by a large fossa at its part where it is going to unite itself to the orbital margin of the malar is not raised, and leaves behind it a deep fissure, as in the Gavial; the malar does not rise to join the posterior frontal bone; on the contrary, the frontal descends to join the external margin of the orbit. The vacuity between the orbit and the anterior part of the tympanic is elongated in the fossil, and occupies four-fifths of the temporal fossa; the anterior part of this fossa is deep and acute. The columella, or ossicle of the ear, is much larger in proportion than in a crocodile or other reptile.

Cuvier calculates the number of teeth in *Teleosaurus Cadomensis* to be 180, viz. $\frac{45-45}{45-15}$. The *Teleosaurus Chapmani* has at least 140 teeth. The *Teleosaurus* of Whitby has 112, or $\frac{28-28}{28-28}$. The teeth of the Whitby *Teleosaurus* as slender and sharp-pointed, but not so compressed as those of the Gavial; they correspond with those of the *Teleosaurus*, and equally illustrate the dental character attributed to the present extinct genus.

Professor Owen then shows that the Whitby *Teleosaurus* differs from the Caen *Teleosaurus*, as does the *Monheim Teleosaurus* (*Crocodylus prisceus*, Soemmering) in having the upper temporal fossa longer in proportion to the lower, and that it also differs from the *Teleosaurus* of Caen and Monheim in the more equal size of the teeth, and from that of Monheim in the greater number of

Teleosaurus prisceus having at most $\frac{27-27}{26-26} = 10$ points out other differences.

In treating of the vertebral column, the author states that the number of vertebræ in the true crocodilian present period rarely exceeds sixty, the number in the *Teleosaurus* by Ælian to the crocodile of the Nile. Cuvier observes, generally found 7 cervical, 12 dorsal, 5 sacral, and 34 caudal vertebræ. In the *Crocodylus* he remarks, a thirteenth pair of ribs is occasionally developed, and, according to Plumier, the last species has two additional caudal vertebræ; the *Alligator Lucius* [CROCODILE, vol. viii., p. 16] has the additional ones being in the caudal region. The Gavial has 67 vertebræ, viz. 7 cervical, 13 lumbar, 2 sacral, and 41 caudal.

The very perfect specimen in the Whitby Museum, says Professor Owen, 'displays the number of vertebræ through the whole spinal column, and exhibits another difference between the *Teleosaurus* and the *Gavial*, the former having a number of vertebræ intermediate between the Crocodiles and Gavials, viz. 64, with a peculiarity in the excess of costal vertebræ, as the following formula indicates, viz., 7 cervical, 16 dorsal, 2 sacral, 36 caudal. In all subgenera of existing crocodiles, as in the extinct tertiary species, the hind part of the vertebra is convex, the fore surface concave in the atlas and two sacral vertebræ. Cuvier had the opportunity of seeing only the annular (neurapophyses) of the cervical vertebræ of the

regrets his inability to state whether either of the extremities of the centrum were convex, or hemispherical. The Whitby Teleosaurus decides this question, showing that both articular extremities of the vertebrae are slightly concave in the cervical as in the rest of the vertebral series. The atlas in the Teleosaurus corresponds essentially with that of the crocodiles, as is shown by the main component parts of this bone, from a Teleosaurus in Lord Enniskillen's collection. The centrum is a transverse quadrilateral piece, flattened above, and convex below, narrowing like an inverted cone, with articular facets, viz.: a concavity in the occipital condyle; a flat rougher surface on the upper part for the attachment of the neural spine; a posterior facet for the anterior part of the dentoid element of the axis; and the small smooth lateral posterior and inferior angle, for the ribs. The neurapophyses are pyramidal, projecting from their apices curved towards each other; they are very smaller in proportion to the centrum than in the crocodile. The general anterior concavity for the occipital tubercle is formed at its centre by the centrum and neurapophyses of the vertebrae at its middle by the anterior detached odontoid of the axis, which is here evidently the analogue of the atlas in the *Ichthyosaurus*, the true body of the atlas in the Teleosaurus representing the first indigo-shaped bone in the *Ichthyosaurus*. The atlas in the Teleosaurus is a large oblong piece articulated with the neurapophyses of the atlas, and partly overlapping the axis.

Owen then describes in detail the cervical vertebrae, in which it appears that the same mechanism of strengthening the neck, as is found in crocodiles, exists in the ancient marine crocodiles; the ribs of the dorsal region, with 16 pairs of ribs, a number than occurs in any existing Crocodylian; the ribs of the dorsal or lumbar vertebra, which faintly indicate the most striking characters of the vertebral series, STREPTOSPOONDYLUS; and the caudal vertebrae, which progressively diminish in every diameter, save in the middle to near the end of the tail, the caudal vertebrae being shorter than the rest. The sternal ribs, he remarks, closely agree with the crocodylian type. He had not seen a specimen of the sphenoidal sternal ribs.

Owen then notices the structure of the *Pectoral Extremities*, as compared with those of the crocodiles, and the *Dermal armour*, the bony plates of which are regularly disposed in the Teleosaurus as in them; but the scutes of *Teleosaurus Chapmani*; *Teleosaurus* observes, differ as much from those of the crocodiles and Crocodyles, as those of *Teleosaurus* do. The following are the species recorded by Owen:—*Teleosaurus Chapmani*; *Teleosaurus*; *Teleosaurus Cadomensis*, var.; and *Teleosaurus iodeirus*, Owen. [STENEOSAURUS; CROCODYLE, p. 168.]

TELESCOPE (from the Greek *telēskopos*, *τηλεσκόπος*, *tele*, distant, *skopos*, to look at), an optical instrument consisting of a tube which contains a system of glass lenses having all their optical axes in one common axis, or a tube containing a medium in combination with such lenses: by means of which distant objects are caused to appear enlarged, and more distinct than when viewed by the eye. Those which are constructed with glass lenses are called dioptric, or refracting, and the others which are constructed with reflecting surfaces are called reflecting telescopes. In the former kind the pencils of light which come from every part of the object viewed are, by the first lens on which they impinge, made to converge so as to form an image at the focal distance of the lens. In some cases the rays in each pencil are intercepted by a second lens, and, by its refraction, are made to enter the eye in parallel directions. In other cases, the rays, after having crossed each other at the place where the image is formed, fall in a state upon a second lens, and by it are refracted so as to emerge from it in parallel directions. Frequently the parallelism of the rays is effected by two or three lenses in addition to that, called the object-glass, by which the image was formed. In reflecting telescopes an image is formed by the reflection of the rays in the pencils coming from the object, after having impinged

upon the concave surface of the speculum: in some cases this image is viewed through one glass lens or more, but frequently the rays, before or after forming the image, are reflected from a second mirror, and are subsequently transmitted to the eye through lenses.

By these instruments objects even in the remotest depths of space are rendered accessible to human vision; and terrestrial objects faintly visible in the distance are brought, as it were, close to the eye. In the hands of astronomers they were the means, almost immediately on being invented, of making more discoveries in the heavens than had been made during 5000 years previously; they form a valuable addition to the instruments employed by the mariner and the surveyor, and they will ever constitute the most agreeable companion of the traveller, by enabling him to distinguish, in every direction from him, objects which it might be difficult or impossible for him to approach.

In exhibiting the principles on which a telescope is constructed, it will be proper to commence with an explanation of the means by which the image of an object is formed at the focus of a lens or of a reflecting mirror. With respect to a lens, if it be of the kind called convex [LENS], the rays in the pencils of light which proceed from every part of an object, as APB, in passing through the lens, supposing the latter to have a proper degree of curvature, are made to converge by the refracting power

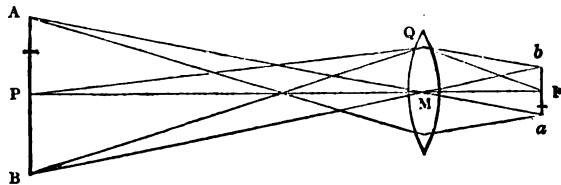

of the glass at points, as *a*, *F*, and *b*, and the assemblage of such points constitutes an image of the object: if a screen were placed at *F* perpendicularly to the axis *PF*, the object would be represented on it, in an inverted position.

If the lens were of a concave form, the rays in the several pencils, after passing through it, would be made to diverge from one another, and consequently no image could be formed: yet if the directions of the rays, after refraction, were produced backwards, they would unite between the lens and the object, in points corresponding to those which constitute the image formed by the convex lens.

If the rays in the pencils of light proceeding from different points, *A*, *P*, *B*, in an object are reflected from the surface of a concave mirror, supposing the latter to have a

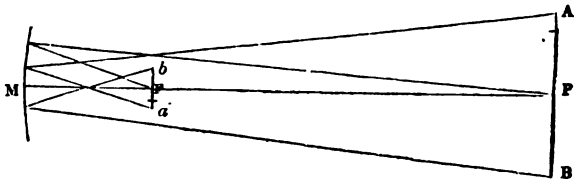

certain degree of curvature, those rays will unite in as many points, *a*, *F*, and *b*, and form an image of the object. If a screen were placed at *F* the object would be represented on it, in an inverted position. The rays in each pencil reflected from the surface of a convex mirror are made to diverge from each other; and in that case no image is formed.

Now, if the object *AB* be so remote that, in each pencil, the rays incident upon a lens may be considered as parallel to one another, the point *F* is called the principal focus; and in the article LENS (p. 421, col. 2) there will be found a collection of formulæ for the reciprocals of the focal lengths of lenses of all the different kinds; it being understood that the diameter of the lens is small, which is generally the case with telescopes, and that the light is homogeneous. But, since all light is not of one kind, and a lens acts like a prism in causing, in each pencil, the rays of the differently coloured light to diverge from one another: it follows that each of the coloured lights will form its own image at its proper focus; and the image formed by light of one kind being seen by the eye along with the images formed by light of the other kinds, the representation of an object when formed by a single lens

appears to be indistinct and surrounded by a coloured fringe. [ACHROMATICS; DISPERSION.] It may be observed that the principal focus of any lens, with respect to each colour, may be obtained from the formulæ in LENS by substituting in them the value of μ (the index of refraction) for the given kind of light.

Thus, in an optical instrument, in addition to the distortion of the image arising from the sphericity of the lens, there is an indistinctness caused by the dispersion of the different colour-making rays; and, in a good telescope, it is requisite that both of these imperfections should as far as possible be removed. The chromatic aberration, as the dispersion of the colour is called, constitutes by far the greater evil of the two, for Newton has shown that it exceeds the former nearly in the ratio of 549 to 1; but fortunately it is that which, to an extent sufficient for practical purposes, admits of being easily corrected.

Since different kinds of glass have different degrees of dispersive power, it is evident that the chromatic aberration may be diminished, if not wholly removed, by causing the light to pass through two lenses of different kinds of glass, and of such forms that they may refract the rays in each pencil in opposite directions. The object-glass of a telescope when so formed is said to be *achromatic*, and the manner in which the effect is produced may be understood from the following description. Let PQ be the direction of a pencil of compound light incident on the

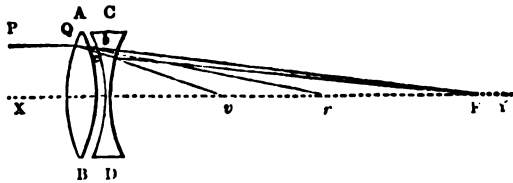

first surface of the convex lens AB, in a direction parallel to the common axis, XY, of the two lenses. By the refractive power of this lens (crown glass) the red rays in the pencil would, if no object were interposed, proceed in the direction Qb, meeting XY in r, and the violet ray in the pencil would proceed in the direction Qc, meeting the axis in v. But the refractive power of the concave lens CD (flint glass) acts, from its form, in a direction contrary to that of the convex lens, causing the rays either to diverge from the axis XY, or to meet it in points beyond v and r, towards Y: suppose the curvature of this lens to be such that the red rays in the pencil PQ would, after refraction in both lenses, meet the axis in F (the ray Qbr taking the direction bF); then the dispersive power of this kind of glass exceeding that of the other kind, the violet rays in the refracted pencil will tend farther away from the axis than the red rays do, and thus will tend towards the latter; the ray Qcv, for example, taking the direction cF. It is conceivable, therefore, that the curvatures of the surfaces of the lenses may be such that, in each incident pencil, the red and violet rays (the extreme rays of the spectrum) shall after refraction unite at the place of the image; and thus the fringe due to these two colours may be destroyed.

If the two kinds of glass dispersed the different colour-making rays in the same proportions, their contrary refractions would cause all the colours to be united on the image formed at F: no two kinds of glass have however been as yet discovered which possess this property; and therefore the red and violet images only are united: fortunately in uniting the extreme rays of the spectrum, the others are brought so near together, that for ordinary purposes the image is as free from colour as can be desired.

From the description just given it will be evident that the place F, of an image in which the dispersion of the red and violet rays is corrected, may be determined on obtaining, from the common theorems of optics, algebraic expressions for the focal lengths of the compound lens for each of those kinds of light, and making the expressions equal to one another. Thus, supposing R and S to be the radii of the curve surfaces of a double convex lens of crown glass, and μ the index of refraction for light of one kind (red, for example); supposing again that the rays in the pencils of incident light are parallel to one another and pass through the lens very near the axis; then, by a fundamental theorem in optics we have, F being the distance

from the focus to the lens, which is moreover w thickness,

$$F = \frac{R \cdot S}{R + S} \cdot \frac{1}{\mu - 1}$$

but since, in the present case, the lens may be sup to be isosceles ($R=S$), we have $F = \frac{R}{2\mu - 1}$.

In like manner the focal length F' , of a double c lens of flint glass, R' being the radius of each μ' and μ' the index of refraction for red rays, is eq $\frac{R'}{2(\mu' - 1)}$, the rays being incident near the axis.

Hence, by a fundamental theorem in optics, $\frac{R'}{\mu' - 1} - \frac{R}{\mu - 1} : \frac{R'}{\mu' - 1} :: \frac{R}{\mu - 1} : \frac{R R'}{2(R'(\mu - 1) - R \mu)}$ and this last term is the focal length of the com

lens for red rays. Its reciprocal is equal to $\frac{2\mu}{R(2(\mu' - 1) - \mu)}$, which, in the algebraic sense, is the sum reciprocals of the focal lengths of the separate len

On writing $\mu + \delta\mu$, and $\mu' + \delta\mu'$ in place of μ and the last expression, we have for the reciprocal of th length of the compound lens for violet rays,

$$\frac{2(\mu + \delta\mu - 1)}{R} - \frac{2(\mu' + \delta\mu' - 1)}{R'}$$

In an achromatic telescope the focal lengths compound lens for red and violet rays are to be eq one another; and it is evident that this condition

fulfilled when $\frac{\delta\mu}{R} - \frac{\delta\mu'}{R'} = 0$. From this equation w

$R : R' :: \delta\mu : \delta\mu'$; then, dividing the antecedents and the consequents by $\mu' - 1$, we have [DISPER ratio of the focal lengths of the two lenses equal to the dispersive powers of the two kinds of glass; and the focal length of the compound lens being a pleasure, those of the separate lenses, consequ radii of their surfaces, may be obtained.

In order to diminish the spherical aberration, the glasses of achromatic telescopes frequently consist lenses, of which the first and third are of the kind double convex, and are formed of crown glass, second is double concave, and made of flint glass. case, since the index of refraction is the same for lens as for the first, if the radius of each surface of lens be R'' , the reciprocal of the principal focal le the separate lenses for red rays will be

$$\frac{2(\mu - 1)}{R}, - \frac{2(\mu' - 1)}{R'}, \text{ and } \frac{2(\mu - 1)}{R''};$$

these being added together, their sum will be th prical of the focal length of the compound lens f kind of light. On substituting in the above term, for μ , and $\mu' + \delta\mu'$ for μ' , in order to obtain the recipr the focal length for violet rays, we shall have, wh chromatic aberration is corrected,

$$\frac{\delta\mu}{R} - \frac{\delta\mu'}{R'} + \frac{\delta\mu}{R''} = 0, \text{ or } R' \left(\frac{1}{R} + \frac{1}{R''} \right) = \frac{\delta\mu'}{\delta\mu}$$

But $\frac{\delta\mu'}{\delta\mu}$ is known from tables of the refractive indi

different kinds of glass: therefore if any conveni lation between the radii of two of the lenses be a the values of all the radii, and consequently the lengths of the several lenses, may be found.

The investigation of formulæ for the correction spherical aberration is a process of some labour, scarcely a fit subject except for a mathematical w, is treated with great perspicuity in Robison's chanical Philosophy, vol. iii., from which the sub theorem is borrowed, the notation only being chang that which has been adopted above; and also in t ticles LENS and SPECULUM. If a compound objec consists of one double convex lens of crown glass double concave lens of flint glass, and a ray of light incident upon the anterior surface of the former in a tion parallel to the axis, at a distance from thence,

sed by e ; the distance from the lens, of the point the ray after refraction will meet the axis, is f' , where f is the focus for parallel rays in near the axis, and may be found as above, and e is the aberration. Here, neglecting the thickness of the lenses and the interval between them,

$$\frac{1}{f} \left\{ \frac{\mu^3}{n^3} - \frac{2\mu^2 + \mu}{R'n^2} + \frac{\mu + 2}{R'n} \right\} \frac{e^2}{2}, \text{ and } n = \frac{RS}{R+S};$$

being the radii of the two surfaces of the convex lens

$$\frac{\mu' - 1}{\mu'} \left\{ \frac{\mu'^3}{n'^3} - \frac{2\mu'^2 + \mu'}{R'n'^2} + \frac{\mu' + 2}{R'n'} + \frac{3\mu'^2 + \mu'}{F.R'n'^2} - \frac{4(\mu' + 1)}{F.R'n'} \right\} \frac{e^2}{2};$$

is the principal focus of the convex lens, and $R'S'$ (R' and S' being the radii of the surfaces of the concave lens.)

ident that, in order to correct the spherical aberration values of the radii of the surfaces must be determined from the equation $q + q' = 0$. This equation is indeterminate, because it contains several unquantities; but it may be made subject to certain is by which there will remain only one: for example different radii of the lenses may be made to given relation to one another, so that the values of any one, may be substituted for them. values of q and q' the terms represented by n and n' respectively equal to half the radii of equivalent isosceles; and it has been shown, in the investigation of the chromatic aberration, that these are to one

as $\delta\mu$ to $\delta\mu'$; consequently $n' = n \frac{\delta\mu'}{\delta\mu}$, and therefore in terms of n . If again it be supposed that the nearest surfaces of the convex and concave have equal curvatures, the value of R may be determined from the equation $q + q' = 0$, in terms of n , by a cubic equation.

Dr Herschel, in a paper on the aberration of compound and object-glasses (*Phil. Trans.*, 1821), has derived formulæ for the values of the chromatic and spherical aberrations; and M. Littrow, of Vienna, proceeding with Euler's formula for spherical aberration (*ca.*, tom. iii., 1769), and introducing in it the focal lengths of two lenses so that the former may be corrected, has obtained two equations which the radii of the four surfaces may be determined under such conditions as may be thought convenient. (*Mem. of the Astron. Soc.*, vol. iii., part 2.) In solving the problem relating to the determination of the four radii, Dr Littrow uses a method which possesses some advantages for computation, and on that account it has been followed in the following process.

Let the radii of the surfaces of the first lens be determined on the supposition that the whole refraction of light passing through the lens is a minimum; that is, that the incident and emergent rays make equal angles with the axis, or with those radii. Thus let a ray PQ be incident on the first surface in a direction parallel to the axis of the lens, and infinitely near it; and RQT being

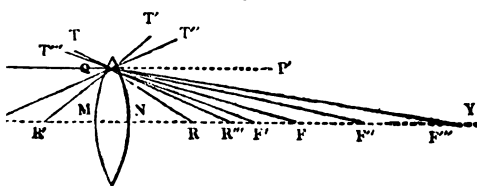

is produced, of that surface let the angle of incidence be represented by a ; then $\mu : 1 :: a : \frac{a}{\mu}$, the angle of refraction at that surface). But if S be the radius (=S) produced, of the second surface; the triangle R'QR, neglecting the thickness of the lens, and substituting arcs for their sines, $S : R :: a : \frac{R}{S}a$;

and $\frac{R}{S}a + a - \frac{a}{\mu}$ (=T'QF) is the angle of incidence on the second surface: and, by optics, 1 is to μ as this last angle is to $\frac{a\mu R}{S} + a(\mu - 1)$, the angle of refraction (=T'QF') at the second surface. But by hypothesis, this angle is to be equal to a ; therefore $\frac{R}{S} = \frac{2-\mu}{\mu}$. Again, by optics

$\frac{RS}{R+S} \cdot \frac{1}{\mu-1}$ is equal to the focal length of the lens; and supposing this to be equal to unity, we obtain $\frac{R}{S} = \frac{R-\mu+1}{\mu-1}$; equating this last term with $\frac{2-\mu}{\mu}$ above, we get

$$R = \frac{2(\mu-1)}{\mu}; \text{ whence } S = \frac{2(\mu-1)}{2-\mu}.$$

Therefore the two radii are found on the supposition that the focal distance of the lens is unity.

Now PQT being the angle of incidence as above, and QF the direction of the ray after one refraction, we have

by optics, $\sin. RQF = \frac{\sin. PQT}{\mu}$; and by trigonometry, in the triangle RQF,

$$RF = R \frac{\sin. RQF}{\sin. P'Q'F'}, \text{ and } MF = R \left(\frac{\sin. RQF}{\sin. P'Q'F'} + 1 \right);$$

also, representing the thickness MN of the lens by t ,

$$R'F = R \left(\frac{\sin. RQF}{\sin. P'Q'F'} + 1 \right) + S - t.$$

Then, by trigonometry, in the triangle R'QF,

$$\text{we get } \frac{SF+S-t}{S} \sin. P'Q'F = \sin. T'QF;$$

consequently by optics, $\frac{SF+S-t}{S} \mu \sin. P'Q'F = \sin. T'QF'$

or the sine of the angle of refraction at the second surface.

Now T'QF' - T'QF + P'QF = QF'M, or the angle which the second refracted ray makes with the axis of the lens; but by trigonometry, in the triangle R'QF', we have

$$R'F' = S \frac{\sin. T'QF'}{\sin. P'Q'F'}; \text{ whence } NF' = S \left(\frac{\sin. T'QF'}{\sin. P'Q'F'} - 1 \right).$$

Suppose next a double concave lens, the centres of whose surfaces are at R'' and R''', and whose radii are R'' and S'', to be applied to the convex lens on the side N: then, neglecting the thickness of the concave lens and the distance between the two, and supposing QF'', QF''' to be the directions of the ray of light after the third and fourth refractions respectively, we have in the triangle R''QF'', by trigonometry,

$$\frac{R''+S''F''}{R''} \sin. P'Q'F' = \sin. T''QF'',$$

or the sine of incidence on the first surface of the second lens; and by optics,

$$\frac{R''+S''F''}{R''\mu'} \sin. P'Q'F' = \sin. T''QF''.$$

But P'Q'F' - (T''QF' - T''QF'') = P'Q'F''; and in the triangle R''Q'F'', by trigonometry, we have

$$R''F'' = R'' \frac{\sin. T''QF''}{\sin. P'Q'F''};$$

wherefore $NF'' = R'' \left(\frac{\sin. T''QF''}{\sin. P'Q'F''} - 1 \right)$; and considering NR''' to be equal to S'', R'''F''' will be equal to $NF'' - S''$.

Again, in the triangle R'''Q'F''', we have by trigonometry,

$$\sin. R'''Q'F''' = \frac{NF'' - S''}{S''} \sin. QF''N$$

for the sine of incidence on the fourth surface; therefore, by optics,

$$\frac{NF'' - S''}{S''\mu'} \sin. QF''N = \sin. R'''Q'F''',$$

the sine of refraction at the fourth surface: then $QF''N - (T'''Q'F''' - T'''Q'F'') = P'Q'F'''$, or = QF'''N;

and by trigonometry, in the triangle QF'''R''', we have

$$R'''F''' = S' \frac{\sin. R'''QF'''}{\sin. QF'''N}, \text{ and } NF''' =$$

$$S' \left(\frac{\sin. R'''QF'''}{\sin. QF'''N} + 1 \right),$$

the focal distance of the compound lens.

These values being reduced to what they become when the incident ray PQ is infinitely near the axis of the lenses; that is, when the angles are substituted for their sines, there may be obtained

$$\frac{R}{MF} = \frac{\mu-1}{\mu}, \quad \frac{S}{NF'} = \frac{\mu S}{MF-t} + \mu-1,$$

$$\frac{R'}{NF''} = \frac{R'}{NF'\mu'} + \frac{\mu'-1}{\mu'}, \text{ and } \frac{S'}{NF'''} = \frac{S'\mu'}{NF''} + \mu'-1.$$

By means of these equations, eliminating the quantities MF, NF', and NF'', and neglecting powers of t above the

first, there may be obtained a value of $\frac{1}{NF''}$: then differentiating this value with respect to $\mu, \mu',$ and NF''' , and making the resulting value of the differential of NF''' equal to zero (which is a condition necessary in order that the chromatic dispersion may be corrected for rays near

the axis), there may be obtained a value of $\frac{1}{R'} + \frac{1}{S'}$. Again

on substituting $\frac{2(\mu-1)}{\mu}$ for R, and $\frac{2(\mu-1)}{2-\mu}$ for S, as above found, there will result

$$\frac{1}{NF''} = 1 - \frac{\mu'-1}{\mu-1} \left\{ 1 + \frac{1}{2}(\mu+1)t \right\} \frac{d\mu}{d\mu'} + \frac{1}{2}\mu t, \text{ and}$$

$$\frac{1}{R'} + \frac{1}{S'} = - \frac{1}{\mu-1} \left\{ 1 + \frac{1}{2}(\mu+1)t \right\} \frac{d\mu}{d\mu'}$$

Now the value of NF''' may be directly computed from the formulæ first investigated; afterwards assuming different values of R' , and substituting them in the last equation, let the corresponding values of S' be found. With these values of S' find corresponding values of

$$S' \left(\frac{\sin. R'''QF'''}{\sin. QF'''N} + 1 \right); \text{ that is, of } NF''', \text{ and proceeding}$$

according to the usual methods of trial and error, there will at length be found a value of NF''' agreeing with that which was computed by the direct process: the four radii will then, consequently, be determined.

Investigations relating to the dispersion of light, and rules for computing the radii of curvature for achromatic object-glasses, will also be found in an essay by Mr. P. Barlow of Woolwich, printed in the 'Philosophical Transactions' for 1827.

Though on thus uniting the red and violet light by lenses of crown and flint glass the chromatic dispersion is in a great measure corrected, yet when the image is examined, it is found to be surrounded by a green-coloured fringe. The difficulty of procuring flint glass of sufficient purity is also a serious impediment to the perfection of achromatic lenses for telescopes; and though great rewards have been offered for glass which shall be free from defects, the exertions of artists have hitherto been almost without success. Occasionally however flint glass is obtained nearly homogeneous, and the opticians of Germany appear, in this respect, to have been more fortunate than those of England.

The late Dr. Ritchie obtained a disc of flint glass which was, by Mr. Dollond, formed into an object-glass nearly 7½ inches in diameter. It was applied to a telescope 12 feet long, and bore a magnifying power equal to 700 times: it is said to have had scarcely any spherical aberration, and to have been very free from colour. (*Mem. Astr. Soc.*, 1840.)

In the 'Transactions' of the Royal Society of Edinburgh, 1791, there is given an account of some experiments made by Dr. Blair, from which he was led to the discovery of a fluid medium, which, being applied between lenses of crown glass, renders the compound lens completely achromatic. By adding liquid muriatic acid to chloride of antimony, or sal ammoniac to chloride of mercury, he succeeded in obtaining a spectrum in which the coloured rays in each pencil followed the same law of dispersion as takes place in crown glass. Therefore, confining a small

quantity of either of these liquids between the surfaces of two plano-convex lenses, or between the a plano and a convex meniscus lens, of crown glass Blair obtained an object-glass in which the chromatic aberration was entirely destroyed; and he is said to thus constructed one of 9 inches focal length, and as as 3 inches in diameter or aperture. Object-glass made were for some years on sale in London: but from the crystallization of the fluids, or the neglect of the artists in compounding them, the telescopes were imperfect, and gradually fell into disuse.

Dr. (Sir David) Brewster, in his 'Treatise on New Philosophical Instruments,' recommends the employment of sulphuric acid and oil of cassia for the composition of fluid lenses, by which the secondary spectrum is destroyed; the acid being, of all known substances which exerts the greatest, and the oil that which exerts the least action on the green coloured rays. The correction of the chromatic dispersion by means of fluid lenses also recently been attempted by Mr. Barlow, who, in combination with a convex lens of crown glass, used a concave lens, consisting of sulphuret of carbon between two glass lenses (like that of a watch), of each of which the two faces of equal curvature: this fluid has nearly the same refractive index as flint glass, and its dispersive power is than double that of the latter material. The crown lens and the fluid lens, instead of being close together were placed at a considerable distance from one another by which disposition an increased magnifying power have been obtained without increasing the length of the telescope. Probably from imperfections in the construction of the glasses, the images of objects were found to be not well defined; and the construction, in consequence, was not been adopted.

The image formed by the great speculum of a reflecting telescope is free from the inconveniences attending chromatic aberration of light; for the angles of incidence being equal to that of reflection, in any pencil of rays from a point in an object, all the rays will converge to one point at the place where the image is formed. The surface of the speculum were that which is formed by the revolution of a parabola about its axis, then all the rays of any pencil proceeding from a very remote object, and being incident on the surface of the speculum in a direction parallel to the axis, would, by the nature of the parabola, converge accurately in the focus of the curve; and on this account, an effort is always made to give to the reflecting surface of the speculum a paraboloidal figure. The advantage does not however hold with the pencils which fall on the mirror in directions oblique to the axis; and therefore that figure is of importance, when the telescope is to be used for viewing terrestrial objects, than when it is to be employed for astronomical purposes; for then, on account of the great distance of the objects, the several pencils of light fall on the mirror with a very small obliquity to its axis.

The telescope invented by Galileo consisted of an objective lens AB, and of a concave lens CD; the distance between them being equal to the difference between the focal lengths of the two lenses. In this instrument,

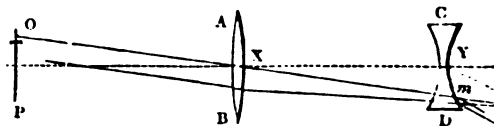

object OP were so remote that the rays in each pencil might be considered as parallel to one another, they would be formed at its principal focus an inverted image of that object by the union of the rays in each pencil in one point; then the concave lens being placed between the objective and that image, in such a situation that its principal focus may coincide with the place of that image, then in each pencil will, by the refracting power of the objective lens, be made to emerge parallel to one another; and in this case, by the optical properties of the eye, distinct images are obtained.

The line OXo is the axis of the pencil of light from the object, and, as this passes through the centre X of the objective lens without refraction, the angle ZXo is equal to the angle under which OP would be observed by an eye

o telescope is interposed, while (m parallel to Yo the direction of a ray in that axis after refraction in Yo is half the angle under which OP is seen in the eye: the ratio between these angles is therefore the magnifying power of the telescope; and the angles are to one another as YZ is to XZ , nearly,

as that $\frac{XZ}{YZ}$ nearly expresses the magnifying power.

is the construction of what is called an *opera glass*; the Galilean telescope is now used chiefly for viewing within a theatre, or an apartment, since if considering magnifying power were given to it the extent of the view would be very small.

iple telescope may also be constructed by means of convex lenses, which are placed at a distance from other equal to the sum of their focal lengths. For the image being formed at the focus Z , of the lens AB , is nearest to the object, as in the Galilean telescope,

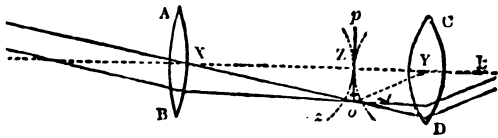

ng supposed to be a plane surface, the light also supposed to be homogeneous; the rays of each after crossing at the focus and proceeding from in a divergent state, on being allowed to fall upon ace of the second lens CD , may be refracted in the as to pass out from thence in parallel directions; sequently distinct vision of the object may be ob- y an eye situated so as to receive the pencils.

be the direction of the axis of a pencil of light from O , one extremity of the object OP , which is d to be so remote that all the rays in each pencil considered as parallel to one another; then the ZXo is half the angle under which the object OP be seen by an eye at X without a telescope, while s of that pencil entering the eye at E in the direc- l, which is parallel to oY , the angle ZYo is half le under which the same object is seen when through the telescope. Now these angles are to

other nearly as ZY to ZX ; therefore $\frac{ZX}{ZY}$ will ex-

actly the magnifying power of the instrument. As cils of light from O and P cross the axis of the eye fore they are united on the retina, the image of the OP is formed in the eye in a position contrary to ick is formed when the object is viewed without scope; therefore, on looking through the latter, the OP appears to be inverted.

he image formed at op , instead of being a plane, is on a portion of a spherical surface whose centre is and, on the other hand, in order that the rays in ncil may after refraction in CD be parallel to one ; they ought to diverge from a point nearly in the of a sphere whose centre is at Y , the two spherical s being in contact at Z : consequently when the e between the lenses is such that the crossing of s in a pencil parallel to the axis takes place exactly e crossing z in one of the oblique pencils will be tain distance from the point z' , at which it ought o permit the rays in it to go out of CD parallel to oter; the rays of the pencils which proceed from rgin of the object will not then emerge parallel to oter, and consequently that margin will not be ly seen. Moreover from the unequal refrangibility fferent kinds of light, the rays in each pencil will mposed in passing through the lens CD , so that the chromatic aberration were perfectly corrected image at po , it would exist in the image which is in the eye by the rays emerging from CD .

spherical aberration can only be diminished by hing the inclination at which the rays in the m pencils fall upon the surface of the lens after having at the focus of the object-glass; that is, by using f less convexity or of greater focal length; adding

eye-glass in order finally to render the rays in ncil parallel to one another. Thus, if it be required erve the same magnifying power and field of view P. C. No. 1508.

as might be obtained with any single eye-glass; let, as before, X be the place of the object-glass, op the image formed by it, and let CD be the place of the single eye-glass: then draw a line oQ so as to bisect the angle DoY

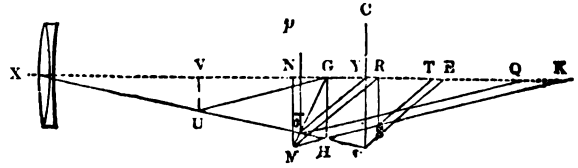

which may be considered as the whole refraction produced by the lens CD : let G , on the right or left of op , be the assumed place of what is called the field-glass, and draw GH perpendicular to XY , the axis of the telescope, meeting XD in H ; also through II draw MHK parallel to oQ , cutting Go , or Go produced, in M : again draw MN perpendicular to the axis of the telescope, and MR parallel to oY ; also draw RS perpendicular to the axis. Lastly, draw GU parallel to oQ to meet Xo in U , and UV perpendicular to the axis. Then, from the principles of optics, if a lens be placed at G , having its focal length equal to GV , and another at R , whose focal length is RN ; the ray XoH will by refraction in the first lens take the direction HS , and by refraction in the second lens it will take the direction ST parallel to oY or DE : thus the present visual angle STR will be equal to DEY , which was obtained with the single eye-glass.

This is called the Huygenian eye-piece, and it is that which is generally used for astronomical telescopes: the object seen through it is inverted, as in the last-mentioned telescope.

If the places G and R of the two eye-glasses are given (GH being very near op ; its focal length being also known), and it be required to find the focal length of RS so that the red and violet rays in each pencil may emerge from it parallel to one another, that length might be determined in the following manner. In a pencil of rays crossing each other at H , let Hm be the direction of a mean ray, and Hr , Hv those of a red and a violet ray; these last will make with one another an angle equal to

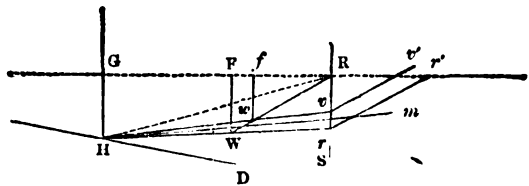

about $\frac{1}{2}$ of the angle DHm , which may be supposed to be known. Now, by optical principles, if these rays are to emerge from RS in directions parallel to one another, the focal lengths of the lens for red and violet rays, viz. Rf and Rf' must be to one another as 28 to 27 , and the foci F and f' must be in places determined by perpendiculars drawn to the axis from points W and w , in which the line RW supposed to be drawn parallel to rr' or vv' , meets Hr and Hv ; that is, by finding the position of a line to be drawn from R to cut the given lines Hr , Hv , so that RW may be to Rv as 28 to 27 . For this purpose, having drawn the straight line HR , the angles RHW , RHw will be known; let them be represented by a and b ; also let the angle HRW be represented by θ : then by trigonometry we shall have, after a few reductions, $27 \cotan. a = 28 \cotan. b = \cotan. \theta$.

In order to afford a view of objects in the same position as they appear to have when seen by the naked eye, a telescope may be formed with three lenses besides the object-glass. In the construction of this instrument, if attention is paid only to the rays which suffer a mean refraction, the first eye-glass, or that which is nearest to the object-end of the telescope, may be placed between the image formed by the object lens and the eye, with the foci of the two lenses in coincidence; by this means the rays in each pencil will emerge from the first eye-glass in directions parallel to one another, those of the pencils which are oblique to the axis of the telescope crossing each other at some point in the latter axis. A second eye-glass is then placed at any convenient distance from the former, beyond the place where the oblique pencils cross each other; and by this lens a second image is

formed in a position contrary to that which is formed by the object lens. Lastly, the third lens being placed between this image and the eye at a distance from the former equal to its focal length, the rays in the several pencils will emerge parallel to one another, and an erect image of the object will thus be formed in the eye.

The ratio between the angles under which an object would be seen by the naked eye, and that by which it is seen in the telescope, is compounded of the ratios of the focal lengths of the several lenses: thus, if F be the focal length of the object-lens, f' , f'' , f''' those of the eye-lenses, reckoned in order towards the eye, the expression $\frac{F \cdot f''}{f' \cdot f'''}$ will denote the magnifying power.

But both the spherical aberration and the chromatic dispersion in such a telescope are very considerable; and before the invention of the achromatic object-glass, Mr. Dollond endeavoured to diminish the former by an eye-tube consisting of five lenses disposed so as to divide the bendings of the pencils nearly equally between them. Such telescopes are not now used; and Mr. Dollond succeeded at length in constructing telescopes with four eye-glasses, from which both distortion and colour are removed as much perhaps as a removal is possible.

This is accomplished by placing the first eye-glass beyond the image formed by the object-glass, and at a distance from it less than the focal length of that eye-glass; by this disposition the rays of mean refrangibility in each pencil which diverges from the image are not, after refraction, parallel to one another, but go on with diminished divergency. A little way beyond the place where the axes of the oblique pencils cross the axis of the telescope there is placed the second eye-glass, which is of such focal length that the mean refrangible rays in each pencil, after passing through it, meet in a point, and thus a second image of the object is formed near the eye: the use of these two lenses, therefore, is to cause the second image to be formed by a gradual convergence of the rays in each pencil. But the several pencils of rays are intercepted by the third eye-glass (commonly called the field-glass), and the second image is thereby formed rather nearer to the first than it would be without such field-lens: from this image the rays in each pencil diverge, and by the refractive power of the fourth eye-glass they are made to enter the eye in parallel directions: thus distinct vision of the external object is obtained. The field-glass might have been placed between the eye and the second image, as in the Huygenian eye-piece before described; but the aberration arising from the spherical form of the glasses is a little less by the construction just mentioned.

Now, in each pencil, the red and violet rays which had been united at the image formed by the object-glass, and which there crossed each other, go on from thence diverging from each other till, on the opposite side of the axis of the telescope, they fall upon the surface of the second eye-glass: after passing through this lens, the violet ray, which is always more refracted than the red ray, gradually converges towards the latter, and at length meets it in some place short of that at which the rays of mean refraction unite to form the second image. The practice is to fix the third or field-glass exactly or nearly at the place where the red and violet rays so unite in all the pencils: for the different coloured rays crossing each other in that place, they are finally, by the refractive power of the fourth eye-glass, made to enter the eye in parallel directions, and thus afford a view of the object nearly or wholly free from colour.

In forming the eye-glasses of telescopes it may be observed that they should be such as will allow the incident and emergent pencils of rays to be nearly equally inclined to their surfaces: on this account the first and fourth eye-glasses are of the plano-convex form: the flat side of that which is nearest to the object-glass being towards the latter, and that of the other towards the eye.

It has been said above that, in reflecting telescopes, a speculum at one extremity of the tube serves the purpose of the object-glass in refracting telescopes by forming an image at its focus: and the manner in which, in the former instruments, the image is transmitted to the eye remains now to be explained.

The following diagram represents a longitudinal section through the axis XY of the instrument, which is supposed

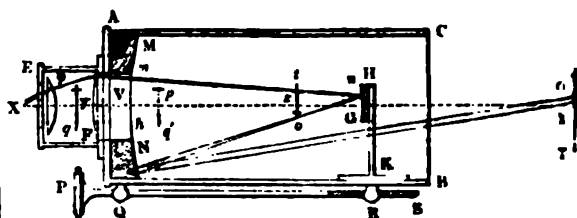

to be of the Gregorian kind. AB is the tube which contains the specula, and is open at the end B : and at the extremity nearest to the eye of the observer is a tube EF containing two lenses. MN is the anterior surface of the great speculum, which has a circular perforation mn at its centre: G is a small speculum, concave like the former, its surface being either spherical or parabolical. It is connected with the side of the tube AB by the arm HK , and is capable of being moved in the direction of the axis XY by means of the rod PS : the latter passes through a knob Q , which is fixed to the side of the tube, and works in the knob R , which passes through an oblong perforation in the side of the tube, and is attached to the part n of the arm HK . This movement is given to the small mirror in order that its focus may be made to coincide with place of the image formed by the great speculum: the image being at different distances from the latter according to the distance of the object from the observer.

Let O be the upper part of an object, and let ON be the direction of the rays in a pencil of light diverging from O : the rays of this pencil will, after being reflected at N , converge to o , which will be the lower part of the image o . From o the rays in the pencil diverge, and having fallen upon the small mirror at n , they are reflected from thence towards the eye-piece EF : having passed through orifice mn , they fall on the lens at F , by which they are made to unite at p , where an image, pp' , of the object is formed. From p the rays in the same pencil diverge, and, falling on the lens at E , they are made to emerge in parallel directions, so that the eye is enabled to obtain distinct vision of the object in the same position if the latter were viewed by the naked eye. The rays, after being reflected at n , might with a due concavity of the smaller mirror have united, as at p' , in front of the great mirror, and the second image might have been formed at $p'q'$: in this case the rays in each pencil, crossing one another, would have fallen in a divergent state on the lens at F , and then, by the refractive power of both lenses, they would have entered the eye in parallel directions as before. The positions of the lenses at E and F , and the curvatures of their surfaces, are determined according to the method of Huygens: and the construction differs in no respect from that which has been described speaking of the eye-pieces of dioptric telescopes.

The magnifying power of a reflecting telescope of this kind is expressed by the formula $\frac{Vz \cdot Gy}{Xy \cdot Gz}$; in which Vz

is the focal length of the great speculum, Gy is the distance of the small speculum from the image pp' , Xy is the focal length of the second eye-glass, and Gz is the focal length of the small speculum for parallel rays.

In the Cassegrainian telescope the small mirror G is made convex, and it is placed so as to intercept the rays from the great speculum MN before the image o is formed: the rays of each pencil consequently fall in a convergent state on the small mirror, and, after reflection from thence, unite to form the image either at $p'q'$ or after refraction in the first eye-glass F . It is obvious that these telescopes, with equal magnifying power, will be shorter than the Gregorian telescopes by more than twice the focal length of the small speculum: and it may be added that, in some degree, the spherical aberration is corrected by the contrary curvatures of the two mirrors.

The Newtonian reflecting telescopes have one concave speculum at the bottom of the tube; and, in each pencil of light, the rays reflected from it fall in a convergent state upon a small plane mirror placed so as to make an angle of 45° with the axis XY of the telescope: after the second reflection the rays unite and form an image which is viewed through a Huygenian eye-piece fixed in the side of the tube AB , opposite the plane mirror; that is near the open end of the tube.

The great telescope constructed by Herschel differs from the Newtonian telescope only in having no small mirror. The surface of the great speculum, which is 4 feet in diameter, has a small obliquity to the axis XY, so that the image formed by reflection from it falls near the lower side of the tube at its open end: at this place there is a sliding apparatus which carries a tube containing the eye-glasses. The observer in viewing, is situated at the open end of the tube, with his back to the object, and he looks directly towards the centre of the speculum, the magnitude of which is such that the rays intercepted by his head, in coming from the object, do not in any sensible degree diminish the brightness of the image.

Formerly the great speculum of a reflecting telescope was pressed into its cell by means of springs attached to the interior side of the brass plate at A; but the vibration of the springs were found to cause tremulous motion in the image at the focus of the mirror; and this motion was so great as to render reflecting telescopes inferior to those of the dioptric kind. The Reverend Mr. Dawkins, who detected the cause of the tremors, at once removed it by taking away the springs (*Naut. Alm.*, 1787); and the same gentleman further improved the distinctness of the image by enlarging the aperture to which the eye is applied. It has been observed also that when the great speculum is nearly in a vertical position, and consequently rests on its lower extremity, its weight bends it, and thus causes a change in the figure of its polished surface: on this account it is recommended that the speculum should be made to rest on two small wedges, placed on each side, at about 45 degrees from the lowest part.

It is the power of magnifying objects, that of affording distinct vision with given quantities of light is often an essential requisite in a telescope, particularly to naval officers, who have occasion during the obscurity of the night to keep in view a ship of which they may be in chase. This subject was investigated by the late Sir William Herschel, and an account of his researches on what he calls the 'space-penetrating power of telescopes' was printed in the *Philosophical Transactions* for 1800.

Herschel states that he was aware of this property of telescopes as early as the year 1777, when he had constructed a Newtonian telescope with a speculum whose length was 20 feet: for, on directing the instrument to a church-steeple at a considerable distance, he could distinguish the hour by the clock, though with the naked eye he could not see the steeple itself. In order to obtain a formula for the space-penetrating power, he observes that the quantity of light received by the natural eye varies directly with the aperture of the pupil, or with the square of its radius, and inversely with the square of the distance to the object: also that the quantity of light transmitted by a telescope, supposing none to be lost in the reflections in the mirrors, or in refraction through the lenses, will directly with the square of the radius of the aperture and inversely with the square of the distance of the object. From experiments on the measure of light, it appears that the whole quantity incident upon a plate of glass is the quantity transmitted through it as 1 is to .9381, or the quantity lost as 1 is to .0619; and from this, the whole quantity of incident light being unity, an estimate may be made of the quantity of light transmitted through all the lenses of a telescope: with respect to the quantity lost in reflection from mirrors Sir W. Herschel found that out of 1000000 incident rays, only 45,242 reached the eye after two reflections.

Let the quantity of incident light be to that which arrives at the eye as 1 to m ; then r being the radius of

the pupil, and R that of the aperture of a telescope, $\frac{R^2 m}{r^2}$

will express the ratio between the quantity of light transmitted to the naked eye, and through a dioptric telescope: therefore the space-penetrating power varying with the

square root of the quantity of light, $\frac{R}{r} \sqrt{m}$ expresses the

penetrating power. With respect to reflecting telescopes, if R' be the radius of the small speculum, the penetrating

power will be expressed by $\frac{1}{r} \sqrt{m(R^2 - R'^2)}$. It is necessary to observe that, in these expressions, it is supposed

that the pencil of light transmitted by the telescope is not greater than the pupil of the eye.

TELESCOPE, HISTORY OF THE. It has been the fate of almost every instrument by which science has been extended, or the well-being of man promoted, that the precise epoch of its invention, and even the name of the individual to whom the world is indebted for it, are alike unknown. This is particularly the case with the telescope, of which the earliest notices are that it existed in England and in Holland near the end of the sixteenth or in the beginning of the seventeenth century.

There is in Strabo a passage (iii., p. 180, Falconer's ed.; p. 138, Casaub.) in which, speaking of the enlargement of the sun's disk at his rising and setting in the sea, it is stated that the rays (of light) in passing through the vapours which rise from the water, as through tubes, are dilated, and thus cause the apparent to be greater than the real magnitude (of the object); and from this it has been inferred (Dutens, *Recherches*, &c.), though the inference is probably without foundation, that there then existed tubes furnished with lenses for magnifying objects by refracting the light. It would be needless to make any observations on an inference founded upon an hypothesis so obscurely expressed: the words in Strabo probably signify only that the rays of light might become divergent in passing along the intervals between the particles of vapour.

Omitting then all notice of this, and of the ill understood passages in Aristophanes ('Clouds') and Pliny (lib. xxxvi., c. 67) concerning transparent spheres, or lenses for concentrating the rays of light, it must be acknowledged that before the end of the thirteenth century lenses of glass were in constant use for the purpose of assisting the eye in obtaining distinctness of vision. Vitello, a native of Poland, in that century, gave some obscure indications of the apparent magnitudes of objects when viewed through a segment of a sphere of glass; and Roger Bacon, in his 'Opus Majus,' both mentions the like fact, and expresses himself in such a manner as to indicate that in his time (he died in 1292) spectacles were already in use. He may not have actually made combinations of lenses in one instrument, but there is no doubt of his being aware of the fact that lenses might be arranged so that objects seen through them would appear to be magnified. [BACON, ROGER; SPECTACLES.]

The idea being known to the learned, it is scarcely possible to doubt that the combination of two lenses, or of a concave or convex mirror and a lens, must have been often made during the three centuries which elapsed between the time of Bacon and that which is generally considered as the epoch of the invention of telescopes. Dr. Dee, in his preface to Euclid's 'Elements' (1570), having mentioned that some skill is required to ascertain the numerical strength of an enemy's force when at a distance, observes that the 'captain, or whosoever is careful to come near the truth herein, besides the judgment of his eye, the help of his geometrical instrument, ring, or staffe astronomical (probably for determining the measure of distances), may wonderfully help himself by perspective glasses: these last can only signify some kind of telescope, which therefore must have been then in general use. And in the 'Pantometria' of Digges (1571) it is stated that 'by concave and convex mirrors of circular (spherical) and parabolic forms, or by frames of them placed at due angles, and using the aid of transparent glasses which may break, or unite, the images produced by the reflections of the mirrors, there may be represented a whole region: also any part of it may be augmented, so that a small object may be discerned as plainly as if it were close to the observer, though it may be as far distant as the eye can describe.' In the preface to the second edition (1591) the editor, who was the author's son, affirms that 'by proportional mirrors placed at convenient angles, his father could discover things far off; that he could know a man at the distance of three miles, and could read the superscriptions on coins deposited in the open fields.' There is probably some exaggeration in this account, but it is sufficiently manifest from it that reflecting telescopes, or optical instruments containing combinations of mirrors and lenses, were known in England before the end of the sixteenth century. The claim of Baptista Porta (between 1545 and 1615) to the invention of the telescope appears to have no other foundation than the circumstance that

ne perceived a small object to be magnified when viewed through a convex lens.

It is highly probable that the telescope had been invented long before the value of such an instrument was duly appreciated; and it may have been owing to the very gradual discovery of its importance that the name of the inventor sunk into oblivion: about the middle of the seventeenth century, however, an effort was made to discover the traces of the invention, and Peter Borellus, in his work entitled 'De vero Telescopii Inventore,' which was published in 1655 at the Hague, has given testimonials in favour of two persons; the first of these is Zachariah Jans, or Jansen, and the other, Hans Lapprey, or Lipperseheim, both of whom are said to have been opticians, or spectacle-makers, residing at Middleburgh: in a letter written by a son of Jans, it is stated that the epoch of the discovery is the year 1590; but by another account, the year 1610. The same author has also given a letter from M. William Boreel (envoy from the States of Holland to the British Court) which seems to throw some light on the facts. The writer of the letter asserts that he was acquainted with the younger Zachariah Jans, when both of them were children, and had often heard that the elder was the inventor of the *microscope*: he adds that, about the year 1610, the two opticians Jans and Lapprey first constructed telescopes, and that they presented one to Prince Maurice of Nassau, who desired that the invention might be kept secret as (the United Provinces being then at war with France) he expected to obtain in the field, by means of the instrument, some advantages over the enemy. The writer further states that the invention became known, and that soon afterwards Adrian Metius and Cornelius Drebbel went to Middleburgh and purchased telescopes at the house of Jans. This account differs from that which is given by Descartes ('Dioptries,' cap. 1), who, writing in Holland, states that about thirty years previously, Metius (who was, he observes, a native of Alkmaer), having always taken pleasure in forming burning-mirrors and lenses of glass and of ice, by chance placed at the extremities of a tube two lenses, one thicker in the middle, and the other thinner, than about the edge (convex and concave); and thus, he adds, was formed the instrument which is called a telescope. The 'Dioptries' was published at Leyden in 1637, and therefore the time of the supposed invention by Metius is nearly coincident with that at which, according to Borellus, it was made by Jans. From the papers of Harriot, it appears that this mathematician observed spots on the sun, in 1610, with telescopes magnifying from 10 to 30 times; but it is uncertain whether he got them from Holland, or whether they were made in this country; and the only conclusions at which it is possible now to arrive, are, that telescopes were known in England and Holland about the end of the sixteenth century, and that in both countries they were then in a form which rendered them practically useful.

The two Jansens, father and son, appear to have used their telescopes in observing the heavens; and the latter is said to have remarked four small stars near Jupiter: it has been concluded from thence, that he was the first discoverer of the satellites of that planet; but though this may be, he probably did not continue his observations long enough to enable him to determine their distances from it, or the times of their revolutions.

The use of the telescope, and, probably, even the knowledge of the fact that it had been invented, must have been for many years confined to the north of Europe: for it appears that it was not till the year 1609 that Galileo, who then happened to be at Venice, heard from a German a rumour of the discovery which was said to have been made in Holland. The Italian philosopher states, in the 'Sidereus Nuncius,' that he had then no knowledge of the nature of the instrument, and that he requested a friend at Paris to send him some information concerning it. On being informed, merely, that it was a tube containing glass lenses, his acquaintance with the nature of the refraction of light enabled him, it is said, to discover that one of the lenses must have been convex and the other concave, and also to determine the distance at which they should be placed from one another in order that the objects seen through them might appear magnified and distinct. Without however supposing that Galileo was here guided by theoretical considerations merely, it is easy to conceive that, as lenses of different

forms were then in use for spectacles, he might have obtained from an optician some which were of various degrees of convexity and concavity; and after he must have found such as would constitute an instrument possessing magnifying power.

The telescopes which he constructed consisted of a convex object-glass and one concave eye-glass: the first were placed at the extremities of a leaden tube: the first of them magnified the heights and breadths of objects three times only. Soon afterwards he made telescopes which magnified eight times; and subsequently he succeeded in forming a telescope with a magnifying power of 30: caused objects to appear about thirty times as large as they are to the unassisted eye.

The knowledge which man had acquired of the heavens received many important accessions to the telescope. Except the sun and moon, no celestial bodies had hitherto been observed in any visible form or magnitude, and it was to the telescope alone that those appeared to be anything but mere points: the fixed stars and the planets were only as luminous and ill-defined points; but through a telescope, the planets were found to have certain magnitudes, and some of them to under-stand the form; while the fixed stars appeared only as points, divested of the radiance with which they were surrounded when seen by the naked eye: it became obvious that the former must constitute a group of bodies infinitely nearer the earth than the sun, from the spots observed on his surface to revolve on its axis, and consequently was to be globular; and the light and dark spots on the moon were distinctly perceived to be mountains, nearly resembling those features on the earth. Galileo relates, in the work above mentioned, that in the year 1610 he discovered the four satellites of Jupiter, and observed that they revolved about that planet: our moon revolves about the earth. Nearly at the same time he observed that Saturn presented a ring-like appearance: at first he thought it was accompanied by smaller planets; but on using a telescope of greater magnifying power, these were found to be a vast annulus which surrounds Saturn with its surface; and soon afterwards he ascertained that Venus exhibited phases similar to those of our moon.

The species of telescope which was used continued for several years unchanged; but it was extremely defective, on account of the small extent of field of view which it affords when its magnifying power is considerable; and the Batavian or Galilean telescope, as it was called, is now chiefly used to distinguish objects in a theatre. It is due to the memory of Kepler that he pointed out in his 'Dioptries' the method of forming telescopes with two lenses, both of which were convex; but he did not reduce his ideas to practice: the construction of such an instrument, and the first having been the first to do so is to be attributed to the Jesuit Scheiner, who, in his 'Rosa Ursina,' gave a description of telescopes with one convex and one concave lens. He observes that they cause the images to appear in inverted positions; and adds, that previously he had used such a telescope in the Archduke Maximilian.

Telescopes with a single convex eye-glass since designated astronomical, from the circumstance that they were long employed for celestial observations, and a greater extent of their field of view having been obtained notwithstanding the inversion of the image, were for that purpose the telescopes of Galileo. It has been remarked however that telescopes with two lenses, both of which were convex, by which the object might be seen in a direct position, it appears to the naked eye, were described and constructed by Scheiner; but as they caused the object to appear much distorted and coloured at the margin of the field, they were not esteemed. Rheita, about the same time, constructed a telescope of eye-tubes containing three lenses, which was found to afford a better image than those with two: it is said that he was the inventor of what is called a biconvex telescope, that is, an instrument which consists of two lenses having equal magnifying powers, and

er in such positions that an object might be with both eyes at the same time. Attempts since made to revive this invention; but the as, if any there be, are more than compensated able of directing the two tubes to the object.

gnifying power of a dioptrical telescope increasing ratio which the focal length of the object-glass that of the eye-glass, and since, by increasing length of the former without increasing its the coloured border round the image is diminished that vision is rendered more distinct, the op- the seventeenth century were induced to form, t-glasses, lenses which were segments of very eras, that is, lenses of great focal lengths. Cam- blogna, by order of Louis XIV., made telescopes object-glasses whose focal lengths were as great et, and with such, Cassini, in 1671, discovered tes of Saturn. [CAMPANI.] M. Auzout is said ade a lens of 600 feet focal length, but it does r that he was able to use it as a telescope.

is, who was an ingenious mechanic as well as a opher, contrived to use an object-glass of long astronomical purposes without placing the sys- ses in a tube. On the top of a long pole which led vertically in the ground, he mounted the ss, having fixed it in a frame with joints so that ould be moved in any direction by means of a ch was held in the hand of the observer; and eing in a line passing through the celestial body, e containing the eye-glasses was fixed to a stand round with its axis in the same direction. An t of this kind having an object-glass of 123 feet th, was made by Huygens and presented to the iety; and with it Dr. Bradley made some of his cal observations. It is described by Huygens in scopia Compendiaria, which was printed at the 1684. But the chief merit of Huygens as an of astronomical telescopes consists in his con- of an eye-piece with two lenses so combined as nlarge the field of view and diminish the aberrat- luced by their spherical forms.

is some probability that the elder Digges had an instrument which constituted a species of , or reflecting, telescope; but, on account of the manner in which the instrument is described, it rarely necessary to notice further his claim to the f the invention. It appears that Père Mersenne, correspondence with Descartes, and in his 'Catop- 51), suggested the idea of a concave spherical be used, like the principal lens of a dioptric , for forming in its focus an image of an object; this image being viewed through a convex eye- proper curvature, the original object would ap- be magnified. Descartes, in his reply to Mer- nich is said to have been written in 1639, makes jections to the scheme, and no effort was then put it in practice. But the great length of the telescopes which were then in use rendering the at of them very inconvenient, ingenious men eed to attempt a construction in which with gnifying power much smaller dimensions might yed. Mr. James Gregory of Edinburgh, in his 'omota' (1663) published a suggestion for form- scope by means of the image at the focus of a peculum. The mirror was to be of polished h a paraboloidal surface, which by the proper- it curve would cause all rays incident upon it in parallel to the axis to converge accurately at .

It is uncertain whether Gregory had any : of Mersenne's treatise, or whether the idea of himself; but this is of little consequence, eing able to find an artist who could execute culum, though he came to London for the pur- suggestion was abandoned, and men of science to direct their inquiries to the means of im- optric telescopes.

however, Newton had discovered the unequal ity of light, and had ascertained that the aber- ded by this cause about the focus of a lens hundred times greater than that which was the spherical form of the glass, he gave up the being able to construct refracting telescopes ould be free from this defect, and applied him-

self to the formation of specula for those of the catoptric kind: the image formed by reflection from a mirror being free from what is called the chromatic aberration, and consequently incomparably more distinct than one which is formed by the refraction of light in a lens of any transparent medium.

In the beginning of 1669, Newton having obtained a composition of metals which appeared likely to serve for a mirror, began with his own hands, to grind its surface to a spherical form; and early in the year 1672 he completed two telescopes: of the construction and performance of these instruments he sent to the Royal Society an account which was read in the January of that year. The radius of the concave metal in one of them was 13 inches, and the telescope magnified about 38 times. The rays, before forming an image in the focus of the speculum, were intercepted by a glass prism, or a plane mirror, and the image formed after this second reflection was viewed by a convex eye-glass which was fixed for the purpose in the side of the tube. In the telescope proposed by Gregory, the rays in each pencil of light, after crossing at the focus of the great speculum, were to fall upon the surface of a small concave mirror; and by this being again reflected, they were to form a second image near the anterior surface of the first speculum: through a perforation in the latter the image was to be viewed; a convex lens being interposed between the image and the eye of the observer. This has been always called the Gregorian telescope; and in 1672, the year in which Newton completed his reflecting telescopes, M. Cassegrain, in France, proposed one which differed from that of Gregory only in the rays reflected from the great speculum being intercepted by a small convex mirror: from this the rays of each pencil were again reflected, and they were made to form an image near the anterior surface of the great speculum: this image was to be viewed through a convex lens behind an aperture in the latter speculum, as in the telescope of Gregory. It does not appear that M. Cassegrain constructed such a telescope, but it may be observed that the image formed after reflection from the convex speculum would be more free from the aberration caused by the surfaces of the mirrors, and would also be rather greater, than that which is obtained from the concave speculum of Gregory or the plane one which was used by Newton.

The first reflecting telescope, in which the great speculum was perforated so that objects could be viewed by looking directly at them, was executed by Dr. Hooke, and produced before the Royal Society in February, 1674. But the difficulty of obtaining metal proper for the purpose, and of giving it a perfectly spherical form, for a long time prevented reflecting telescopes from attaining the desired degree of perfection. In 1718 Mr. Hadley succeeded in executing two telescopes, each about five feet long, which were considered good; and he gave, in the 'Philosophical Transactions' (1723), a description of the methods employed in their construction. By his advice Dr. Bradley, who was then professor of astronomy at Oxford, in conjunction with Mr. Molyneux at Kew, applied themselves to the construction of these instruments: having executed one which was satisfactory, they in 1738 instructed Scarlet and Hearne, two London opticians, in the processes which they used, and these artists presently succeeded in making good reflecting telescopes for general sale. Mr. James Short, of Edinburgh, also soon afterwards distinguished himself by his skill in forming such telescopes: he attempted at first to make the principal speculum of glass, but finding that this material had not sufficient steadiness to preserve the form of its surface, he devoted himself to the improvement of metallic specula, and succeeded in giving them, it is supposed, a correct parabolic figure, by which means his telescopes admitted of larger apertures than any that had before been made.

The processes adopted by Mr. Mudge in grinding and polishing the mirrors for reflecting telescopes, and in giving them the parabolic figure, may be seen in the 'Philosophical Transactions' for 1777. See also SPECULUM METAL.

But the reflecting telescope was destined to receive the highest power of which perhaps it is susceptible from the hands of Dr. (afterwards Sir William) Herschel: this distinguished astronomer, while residing at Bath, employed his leisure hours in grinding and polishing specula, with

which he formed telescopes, both of the Newtonian and Gregorian kinds; and about the end of 1783, that is, subsequently to the discovery of the planet which is called by his name, being aided by the liberality of the king (George III.), he began the formation of a speculum four feet in diameter and forty feet in focal length: the telescope to which it appertains is of the Newtonian kind, the observer being placed in a seat near the open end of the tube, and viewing the image through a system of eye-glasses. With this telescope, which was completed in 1789, objects are magnified about 6500 times; and on the night after it was finished, Dr. Herschel discovered the sixth satellite of Saturn. An attempt is even now being made to form a reflecting telescope possessing a higher degree of perfection than that of Herschel; but though the expectation should be fulfilled, telescopes of great magnitude must always be inconvenient in the management; and, from the expense of their construction, they will ever be confined to a few persons. It is right to observe moreover that the greatest discoveries of which astronomy can boast have been made with telescopes whose magnifying power did not exceed 700 times.

While the improvement of reflecting telescopes was in progress, the efforts to combine glass lenses in order to diminish the coloured fringes by which the images in dioptrical telescopes are surrounded were not entirely neglected; and as early as 1729, a private gentleman, Mr. Chester More Hall, of Essex, influenced, it appears, by an opinion that the humours of the eye are combined so as to correct the dispersions which each alone would produce in the different kinds of light, contrived to combine two lenses of different kinds of glass in such a way as to form an image which was free from colours: it is added that telescopes with such object-glasses were in the possession of several individuals many years afterwards. (*Genl. Mag.*, October, 1790; *Phil. Mag.*, November, 1798.)

In 1747 Euler, guided also by the constitution of the eye, conceived the possibility of forming a lens compounded of two hollow spherical segments of glass, inclosing water between their concave sides, which should be free from the chromatical and spherical aberrations; and in investigating the curvatures he assumed that the logarithms of the terms expressing the ratio of the refraction of a mean ray in passing from air into glass, and from air into water, were proportional to the logarithms of the terms expressing the ratio of the refractions of red rays in the same media. He was not able to obtain from any artist a lens of this nature, in which the proposed end was accomplished, and Mr. Dollond [DOLLOND], in a short paper which is printed in the 'Philosophical Transactions' (1752), contested the justness of Euler's principle on the ground that it was contrary to one which he conceived to be founded on the experiments of Newton.

But M. Klingenstierna, a Swedish mathematician, having soon afterwards, in a Mémoire which was sent to the Académie des Sciences, pointed out that the principle which had been adopted by Dollond was not conformable to the acknowledged laws of refraction, the latter determined immediately on having recourse to experiment. Either guided by the object-glasses constructed under the direction of Mr. Hall, or from a series of experiments made by himself on the refraction of light in wedges of crown and flint glass, he discovered that by employing a convex lens of the former, in combination with a concave lens of the latter kind, the rays of the different colours in each pencil of light, after refraction through both, might be made to unite at the focus, and thus produce an image of the object nearly free from colour. For this important discovery Mr. Dollond received from the Royal Society the Copleian medal. In 1765 his son, Mr. Peter Dollond, diminished the aberration of light on account of the spherical forms of the lenses by combining together two convex lenses of crown glass with a concave lens of flint glass between them: this construction is particularly advantageous, by the increased aperture which it allows when the focal length of the compound lens is short.

For several years after the telescopes thus improved by Dollond had been in general use, Euler continued to believe that all kinds of glass differed but little from each other with respect to their dispersive power, and he ascribed the success of the English artist merely to a fortunate determination of the curvature of his lenses; but having, in the year 1764, received information that, by

the addition of lead, glass had been obtained whose dispersive power was four times as great as that of the common kind, he immediately renounced his former opinion, and from that time the merit of the achromatic glasses, as they were called, has been firmly established. The most eminent mathematicians, both in this country and in this country, have subsequently investigated the scientific principles, the curvatures which should be given to the surfaces of lenses, so that, the focal length of a compound lens being assumed, the chromatical aberrations may be corrected.

The arrangement of lenses for the eye-piece of a telescope is of no less importance than the form of the object-glass; and Huygens proposed *Dioptres* in order to diminish the refraction of light at the object-glass, to substitute for the single eye-glass of the common telescope two convex lenses, of such a curvature that the whole refraction, or the angle between the incident and emergent ray in the former construction, should be divided between the two lenses.

One mode of effecting this purpose is to place the eye-glass, or that which is nearest to the eye, so that it intercept the pencils coming from the object; the rays are united, and thus the image is formed by the refraction of the light in this lens; the second eye-glass is then placed so that the rays falling on it, after having been crossed at the place of the image, are made to emerge parallel to one another. A micrometer is applied to such an eye-piece, since any change of the curvature of the lens which is nearest to the eye would alter the adjustment: these eye-pieces can however be made achromatic, and they have the greatest possible field of view; they have therefore been constructed in preference to those of merely viewing the celestial bodies. Ramsden, and Fraunhofer. Mr. Ramsden, who constructed eye-pieces with two lenses, capable of being used with a micrometer: this is effected by placing the tube containing these lenses so that the rays in the pencils, after crossing at the object-glass, fell in a diverging state upon the second eye-glass, and, after refraction in both, entered the eye in parallel directions.

With both these kinds of eye-pieces the object is to be inverted; but eye-pieces with three lenses have been proposed by Rheita: these being improved upon by Mr. Dollond endeavoured to improve upon them by dividing the refraction at the first and second eye-glasses between two lenses, according to the method recommended by Huygens, and thus he formed eye-pieces with five lenses. But some light is always lost when it falls upon glass; and, in order to do away this evil, Dollond subsequently, retaining the Huygensian construction in the two lenses nearest to the eye, added a third lens to perform the office of the second and third eye-piece with five glasses, in rendering the first eye-piece convergent after the first had diminished the spherical aberration caused by the crossing at the focus of the object-glass: he thus succeeded in producing an eye-piece with four lenses which was nearly achromatic, or free from the chromatical and spherical aberrations: and these telescopes now in common use for viewing objects.

The chief improvements, if they may be so called, which have since been made in dioptrical telescopes, are those means which have been adopted to remove the chromatical aberrations more completely; and the nature of the media which have been used for this purpose. Sir David Brewster, and Mr. Barlow, have been particularly successful in this respect. (See the article TELESCOPE.)

Attempts have been made by M. Chevalier to diminish the aberrations by means of two achromatic object-glasses placed at a certain distance from each other; and by Mr. Rogers of Leith, by a single eye-piece of plate glass, in combination with a double achromatic eye-piece, the convex lens being of plate-glass, and the concave lens of flint-glass. This last gentleman proposed the red and violet rays at the image of the object to be separated by the proper distance between the single and the double eye-piece, and to correct the spherical aberration either by giving the proper curvatures to the surfaces of the compound lens, or by placing the two lenses at a small distance from each other. (*Memoirs of the Astron. Soc.*, vol. iii., p. 100.)

is suggested (*Treatise on New Phil. Inst.*,

it may be possible to remove, or at least very wish, the uncorrected colour in the image by wo lenses of the same kind of glass with the fferent dispersive powers. He proposes that lens should have the meniscus form, the concing outwards; in order, from the obliquity cut rays to the surface, that the dispersion proat lens may increase in a higher ratio than its o that the dispersion produced by the other e corrected; while in each pencil the rays, ion through both, may be convergent.

be improper to omit here to mention that M. Iolena, some years since, invented a species of telescope by a combination of four prisms, all kind of glass: the refracting edges of one pair ms were parallel to one another, and those of air were also parallel to one another, but per- to the edges of the first pair; and each pair achromatic combination. By the refraction in ir the breadth of the object is magnified, and the second pair the length is magnified in the : thus the result is an image undistorted and

Sir John Herschel states that, in 1826, he bands of its inventor one of these telescopes, nified about four times.

OPHIUM (the Telescope), a constellation of the southern hemisphere, surrounded by Ara, tains, and Ophiuchus. Its principal stars are

Character.	No. in Catalogue of		Magnitude.
	(Piazzi.) Lacaille, C.	A-tron. See.	
β	(17)	2101	4
α	(50)	2115	4½
γ	(229)	2043	4
ϵ	(361)	2086	5
ζ	1517 C	2120	5

OPHIUM. De Montfort's name for the *Ceriscopium* of authors. [ENTOMOSTOMATA, vol. ix.,

RD, THOMAS. In the life of this eminent as been observed in a brief notice of the fathers ience of which he was so distinguished an orna- te preface to the 'Transactions' of the Institiv- il Engineers, 'another striking instance is hose on record of men who have, by the force alent, unaided save by uprightness and perse- ustry, raised themselves from the low estate in were born, to take their stand among the master- eir age.' Telford's father was a shepherd in the strict of Eskdale in Dumfriesshire, where, in the Vesterkirk, his only son was born, on the 9th of 37. His father dying while he was yet an infant, (Telford's early years devolved upon his mother, kson, for whom he cherished an affectionate fil her death in 1794; he having been in the rding to Mr. Rickman, of writing letters to her characters, that she might be able to read them sistance. He received the rudiments of educa- patish school of Westerkirk; and, while engaged e summer season as a shepherd boy in assisting he made diligent use of his leisure in studying furnished by his village friends. At the age of he was apprenticed to a stone-mason in the ing town of Langholm; and for several years he yed, chiefly in his native district, in the various usually performed by a country mason in a dis- e there is little occasion for the higher depart- his art. The construction of plain bridges, of lings, and of simple village churches and manses, owever good opportunities for obtaining prac- tledge. Telford himself has expressed his sense ue of this humble training, observing, that convenience and usefulness only are studied in ions, yet peculiar advantages are offered to the ctitioner; 'for,' to adopt his own words, 'as there ient employment to produce a division of labour

in building, he is under the necessity of making himself acquainted with every detail in procuring, preparing, and employing every kind of material, whether it be the produce of the forest, the quarry, or the forge; and this necessity, although unfavourable to the dexterity of the individual workman who earns his livelihood by expertness in one operation, is of singular advantage to the future architect or engineer, whose professional excellence must rest on the adaptation of materials and a confirmed habit of discrimination and judicious superintendence.' Chambers states that during this period of his life Telford was remarkable for the neatness with which he cut letters upon gravestones. In 1780, being then about twenty-three, and considering himself master of his art, he visited Edinburgh, apparently with a view to obtaining employment. The splendid improvements then in progress in that city enlarged his field of observation, and enabled him to contemplate architecture as applied to the object of magnificence as well as utility; and he seems at this time to have devoted much attention both to architecture and drawing. After remaining there about two years, he removed to London, where he obtained employment upon the quadrangle of Somerset House, then erecting by Sir William Chambers, an engagement in which, according to his own account, he obtained much practical information. About 1784 he was engaged to superintend the erection of a house for the resident commissioner in Portsmouth dockyard, from the design of Mr. S. Wyat. Telford's good character and promising talent had secured for him the friendship of two families resident in his native district, the Pasleys and the Johnstones, and to their influence his early employment on important works is, in some measure, to be attributed. He was engaged upon various buildings at the Portsmouth dockyard for three years, during which time he became well acquainted with the construction of graving-docks, wharf-walls, and similar engineering works; and in 1787, having completed his engagements there, he was invited by the late Sir William Pulteney (a member of the Johnstone family) to take the superintendence of some alterations at Shrewsbury Castle. He therefore removed to Shrewsbury, where he was also employed to erect a new gaol, which was completed in 1793, and was subsequently appointed county surveyor, in which office (retained by him until death) he had to furnish plans for, and oversee the construction of, bridges and similar works. The first bridge which he designed and built was that over the Severn, at Montford, about four miles west of Shrewsbury, consisting of three elliptical stone arches, one of fifty-eight, and the others of fifty-five feet span. His next was the iron bridge over the Severn, at Buildwas, consisting of a very flat iron arch of a hundred and thirty feet span, constructed upon very superior principles to that erected a few years previously at Coalbrook Dale: Telford's object was rather to introduce the trussing principle of a timber construction than that of a stone arch. This bridge was built in the years 1795 and 1796. Forty smaller bridges were erected in Shropshire under Telford's direction.

The Ellesmere Canal, a series of navigations intended to unite the Severn, the Dee, and the Mersey, and extending altogether to a length of about one hundred and three miles, was the first great work upon which Telford was engaged, his satisfactory execution of the county works intrusted to him having led its projectors to select him as their engineer; and from this engagement, which commenced about 1793, in which year the act of parliament was obtained for the scheme, his attention was directed almost solely to civil engineering. The uneven character of the country occasioned many serious difficulties in the construction of this canal, and rendered necessary the execution of some works of astonishing magnitude, especially in crossing the valleys of the Ceriog, or Chirk, and of the Dee. In the former the canal crosses the river at an elevation of seventy feet by an aqueduct-bridge of ten arches, each of which is of forty feet span, in the construction of which some important deviations were made from the previous practice of engineers. It had been usual in such structures to form the bed for the canal of puddled clay confined in masonry, a practice which involved great expense, and some danger in time of frost, from the expansion of the moist puddle. The great elevation of the Chirk aqueduct would have increased the difficulty, but Telford abandoned the puddling system, and formed the

oed of the canal of flanged cast-iron plates resting upon walls built on the piers, and constructed the sides of masonry. This work was executed between 1796 and 1801, at a cost of 20,898*l*. The aqueduct-bridge over the valley of the Dee, called the Pont-y-Cysyllte, is still more remarkable: it consists simply of a trough of cast-iron plates, securely flanged together, and supported by eighteen piers or pillars of masonry, the elevation of which is a hundred and twenty-one feet above low-water. These piers are solid to the height of seventy feet, above which they are hollow, with interior walls. The water-way in the cast-iron trough is eleven feet ten inches wide, of which four feet eight inches is covered by the towing-path, supported upon cast-iron pillars, so as to allow the water free play beneath it. The length of the aqueduct is about one thousand feet, and the height of the canal one hundred and twenty-seven feet above the Dee; and at one end of the aqueduct bridge is a great embankment, fifteen hundred feet long, rising in parts to a height of seventy-five feet above the natural surface. These gigantic works were executed between 1795 and 1805, at a cost of 47,018*l*. In the locks of this canal Telford introduced cast-iron framing in lieu of timber; and in one instance, where the lock was formed in a quicksand, he made every part of that material.

The Caledonian Canal is another of Telford's principal works. In 1773 the commissioners of the forfeited estates in Scotland had engaged Watt to report on the practicability of a ship-canal along the valley called the Glen of Scotland, to be formed by connecting the lakes which form a series of navigable waters extending a great part of the distance; but although the report was favourable, it was not acted upon, and the scheme was deferred for some years by the restoration of the forfeited estates, through which the line would pass, in 1784. In 1801 however Telford was deputed by government to make a survey of the coasts and of the interior of Scotland, and to report generally upon desirable public works for the improvement of the country. In consequence of his reports Commissions were formed to carry out the proposed canal, and other improvements classed under the general title of Highland Roads and Bridges; and the services of Telford were engaged by both boards. The Caledonian Canal was opened throughout in 1823. Its construction was delayed by many untoward circumstances; and unfortunately its utility has not hitherto answered the expectations of its projectors. It forms however a noble monument of the skill of the engineer. The locks are stated by Telford to be the largest ever constructed at that time, being forty feet wide, and from one hundred and seventy to one hundred and eighty feet long; and one of them, at Clachnacarry, near Inverness, was made under circumstances of especial difficulty, the earth being a soft mud, into which an iron rod might easily be thrust to a depth of fifty-five feet. The means adopted for conquering this difficulty are fully detailed in the engineer's own narrative.

Of other canals constructed wholly or partially under Telford's superintendence it is sufficient to mention the Glasgow, Paisley, and Ardrossan (which was never completed to the length originally intended); the Macclesfield; the Birmingham and Liverpool Junction; the Gloucester and Berkeley (completed under his direction); the Birmingham, which was completely remodelled and adapted to the conduct of a very extensive traffic, by him; and the Weaver navigation, in Cheshire. He also constructed a new tunnel, 2926 yards long, 16 feet high, and 14 feet wide, at Harecastle, on the Trent and Mersey Canal, the original tunnel of Brindley having been found too small [TUNNEL]; and he executed many important works connected with the drainage of the fen country, especially of Bedford Level. On the Continent likewise he superintended the construction of the Gotha canal, in Sweden, a navigation of about one hundred and twenty English miles, of which fifty-five are artificial canal. This navigation rises one hundred and sixty-two feet from the Lake Wenern, at one extremity, to the summit-level, and falls three hundred and seven feet to the Baltic, at the other: the rise and fall are effected by fifty-six locks. The canal is forty-two feet wide at the bottom, and ten feet deep. Telford visited Sweden in 1808 to make the surveys and preliminary arrangements, and again in 1813, taking with him, under the sanction of the British government, several experienced workmen to instruct the natives in the works then in progress. Upon

the completion of the canal a Swedish order of and other honours were conferred upon Telford.

The works executed by Telford under the Commission of Highland Roads and Bridges are of great magnitude. His survey was delivered to the Lords of the Council in 1802, and in the following year the Commission was appointed. Of the works committed to their superintendence Telford observes that 'the whole of Scotland from the southern boundary, near Carlisle, to the northern of Caithness, and from Aberdeenshire on the east to the Argyleshire islands on the west, has been improved by roads; its largest rivers, and even inferior streams, have been crossed by bridges; and all this in the space of twenty years under the same board, and (with some few exceptions) by the same individual Commissioners; and all this was done under the direction of Telford alone. The operations embraced about 1000 miles of new road, with twelve hundred bridges, in a mountainous and stormy region, of which five only were not Telford's narrative, have required to be explained that the operations of the Commission were not confined to the objects defined in the Act, but embraced also the Glasgow and Carlisle roads; the improvement of several harbours; the principal are those of Peterhead, Banff, Fortrose, Cullen, and Kirkwall; and the erecting of Highland churches and manses under a patent grant of 1823. Nor were these Highland manses the only buildings in which Telford acted as architect; he had, many years previously, erected the Bridgenorth, from his own design.

In the improvements of the great road from Holyhead, under another parliamentary Commission pointed in 1815, Telford had a further opportunity of carrying into effect his system of road-making. An account is given under ROAD, vol. xx., p. 13, of the road, and the works connected with it, is the most perfect specimen of Telford's skill as an engineer, and appears to have been regarded by him with satisfaction. The Menai suspension-bridge is a noble example of his boldness in design and his skill in executing a work of novel and difficult character: it is described under MENAI BRIDGE, and SUSPENSION-BRIDGE, vol. xiii., pp. 314-5. Among the other works of Telford are many of considerable size, in which he adopted the principle of making the spandrels hollow, and so roadway upon slabs laid upon longitudinal beams, of filling up the haunches with a mass of brickwork which may press very injuriously upon the arch, and so improves of serious inconvenience when the bridge needs any repair. He employed this principle in a large arch, of 112 feet span, near the Dee, near Kirkeudbright, in 1805 and many subsequent bridges. In his 'Life' we find particulars of the ingenious alteration of the Menai bridge, by the addition of a projecting footway of iron on each side, so as to leave the whole stone structure for carriages; and of the bridge designed by him for crossing the Clyde at Glasgow, commenced in 1833; of the light and elegant bridge at Edinburgh; Path-head bridge, of five arches and span, over a ravine about eleven miles south of Morpeth bridge; Tewkesbury bridge, erected 1823 and 1826, with a light iron arch of 170 feet span, only 17 feet rise; the Over bridge at Gloucester, of the same span, but of only 13 feet rise; the others. The last-mentioned bridge has an arch of the same form, previously employed by Perronet in the bridge of Lyons. The general body of the arch is a curve of 150 feet span and 35 feet rise, but the stones at the sides of the bridge form segments of a circle of the same span, but of only 13 feet rise: they are coincident at the crown, and are connected by a vaulted form on the haunches of the bridge. 'The simple form,' observes Telford, 'converts each vault of the arch into the shape of the entrance to suit the contracted passage of a fluid, and the flat surface opposed to the current of the water, whether the tide or upland flood rises above the middle of the ellipse, that being at low-water; a precaution rendered necessary by the liability of the bridge to floods.'

Telford executed some important harbour-works at Aberdeen and Dundee; but his most striking performance in his class is the St. Katherine Docks, London. Owing to the very limited space which could be obtained, it was necessary to construct these docks of irregular forms, and to make special arrangements respecting the warehouses; these arrangements, combined with the admirable machinery employed, have reduced the time requisite for loading a vessel in an astonishing degree.* There are two docks communicating with the river by a tide-lock 180 feet long and 45 feet wide, with three pair of gates, so that one or two very large or two smaller vessels may pass the lock at one time; and steam-engines are provided, capable of filling the locks in a few minutes by pumping water from the middle of the river, so that vessels are enabled to enter and out of the docks with great rapidity so long as there is a sufficient depth of water to receive them outside the lock. The cast-iron turn-bridge over this lock is an excellent specimen of that kind of machinery, being easily worked by two persons at each end, although it supports a roadway 24 feet wide. These docks were constructed more quickly than is usual for works of such magnitude, although he admitted the urgency of the case as a justification of a course against which he could not but enter his protest. One of the very latest engagements of Telford was the survey of Dover harbour, undertaken, in January, 1820, at the request of the duke of Wellington, as warden of the Cinque Ports, with a view to the adoption of measures to check the accumulation of shingle at the mouth.

In addition to the works which he executed himself, Telford was frequently applied to for his judgment upon various engineering schemes, and in this way he made many reports and recommendations. For many years he was employed to report upon all public works of engineering character for which loans were required of the Exchequer Loan Commissioners. Among his reports are several of considerable importance, especially upon proposed canals between London and Birmingham, and between the English and Bristol Channels, and on the supply of water to the metropolis, and on the last objects to which he devoted his attention.

For some years before his death he had gradually been forming new engagements, and he made preparations for the publication of such a collection from his papers as might leave on record a permanent account of the important works in which he was more than half a century he had been engaged. He made arrangements with his executors for the publication of his work in case he should not live to finish it, and about it with ardour, and had many of the plates engraved, the manuscript in a very forward state, and the arrangements made respecting the paper, type, &c. before his death. The book was not published until 1838, chiefly on account of the illness and death of Mr. Turrell, the engraver, and the difficulty of getting the plates completed. It is a thick 4to. volume, entitled 'Life of Thomas Telford, Civil Engineer, written by himself; containing a descriptive Narrative of his Professional Labours; and it contains a preface and supplement, by the editor, Mr. Telford, and a very copious appendix of illustrative remarks on other documents. The plates, eighty-three in number, constitute a companion volume, in large folio, to the first, and are prefixed a fine portrait of Telford, engraved by G. P. from a picture by S. Lane. From this work Telford has derived the preceding notice of his principal works, and from the supplementary notice, by Mr. Telford, and some other sources, are collected the additional biographical particulars.

After leaving his native district, Telford acquired some reputation as a poet. He wrote in the homely style of Burns, and Fergusson, and contributed small pieces to the 'Weekly Magazine,' under the signature of 'The Poet of Tam.' He wrote a short poem, entitled 'Eskdale,' descriptive of the scenes of his early years, which was first published in a provincial miscellany, subsequently reprinted at Shrewsbury, at the request of his publisher, and afterwards inserted in the appendix to his Life. A fragment of his composition is given at the beginning of the first volume of Dr. Currie's 'Life and Works of Thomas Telford,' published at Liverpool in 1800: it is an extract

from a poetical epistle sent by Telford, when at Shrewsbury, to the Ayrshire poet, recommending him to take up other subjects of a serious nature, similar to the 'Cottar's Saturday Night.' He taught himself Latin, French, Italian, and German, so as to read them all with facility, and to converse readily in French; and he has left valuable contributions to engineering literature, in the articles Architecture, Bridge, Civil Architecture, and Inland Navigation, in Brewster's 'Edinburgh Encyclopædia,' in which work Mr. Rickman says he was a shareholder. He was well acquainted with algebra, but he held mathematical investigation in rather low estimation. In his early years he appears to have been tinctured with democratic opinions; but after seeing the excesses of the French revolution, he always studiously avoided conversing on political subjects. In all the relations of life he commanded respect and esteem; and he was particularly remarkable for his facility of access to the deserving, and especially for his ready communication of professional information to foreigners; a circumstance which, added to his connection with the Gotha canal and some other continental works, procured for him the highest respect on the continent of Europe. The Russian government frequently applied to him for advice respecting the construction of roads and canals; and the sixty-seventh plate in his atlas represents the details of a road designed by him from Warsaw to the Russian frontier. The emperor Alexander of Russia acknowledged his sense of his services on one occasion, in 1808, by sending him a diamond ring with a suitable inscription. Although he was not connected with the Institution of Civil Engineers at its formation, he accepted their invitation in 1820, and became their president; and from that time he was unremitting in his attention to the duties of the office, having become, by his partial retirement from business, a pretty regular resident in the metropolis. He ardently loved his profession, and was, observes Mr. Rickman, so energetic in any task before him, that all other motives became subordinate to it. He never married, and hardly had a fixed habitation until a late period of life. He was of athletic form, and reached the age of seventy without any serious illness; but in 1827 he was afflicted with a severe and painful disorder, after which he became subject to bilious attacks, under one of which he died, on the 2nd of September, 1834, at his residence in Abingdon Street, Westminster, at the age of seventy-seven. He was buried in Westminster Abbey. The acquisition of property was always a secondary consideration with Telford; and in certain cases, especially of abortive speculations, he was ingenious in finding arguments for giving his assistance gratuitously. Even in increasing his charges as his reputation and experience increased the value of his services, he seems to have been actuated chiefly by a sense of what was due to others in his profession, whose remuneration was in some degree dependent upon his own. After his mother's death he had few family connections to provide for, and he had a great objection to raising any individual above his station in life, which is stated by his biographer as his reason for not leaving his property to relations. His will, printed in the appendix to his 'Life,' provides for the payment of handsome legacies to many personal friends; of 2000*l.* to provide annual premiums to be given by the Institution of Civil Engineers; and of 1000*l.* each in trust to the ministers of Westerkirk and Langholm, for the purchase of books for the parish libraries. His scientific books, prints, drawings, &c. are bequeathed to the Institution of Civil Engineers. Telford became a fellow of the Royal Society of Edinburgh in 1803, and of that of England in 1827.

(*Life*, edited by Rickman; Chambers's *Scottish Biographical Dictionary*; *Annual Biography*, vol. xix.)

TELINGA or TELUGU LANGUAGE. [HINDUSTAN, p. 229.]

TELL, WILLIAM, a simple countryman of the village of Bürglen near Altorf in Switzerland, who lived towards the end of the thirteenth and during the first half of the fourteenth century. His early life is unknown, and his name would probably never have been heard of in history, if the tyranny of the Austrians had not called him from his obscurity. At the beginning of the fourteenth century, when Albert I. of Austria was endeavouring to suppress the spirit of freedom and independence in the three Waldstädte, Uri, Schwyz, and Unterwalden, and was using every means to add them to his family estates, he sent bailiffs (Landvögte)

*For an illustration of this point, a paper on 'The Docks,' forming vol. v. of 'London,' vol. iii., pp. 74-76.

into these cantons, who perpetrated the most flagrant acts of tyranny, and treated the people like a conquered nation. The principal men of the three Waldstädte, in 1307, formed a league, which was headed by Walter Fürst, Arnold von Melchthal, and Werner Stauffacher. William Tell, who had married a daughter of Walter Fürst, also belonged to the league, though without taking any prominent part in it. The object of these men was gradually and secretly to increase their numbers, and to seize on any favourable opportunity for delivering their country from its oppressors, and if possible without bloodshed. While the confederates were daily gaining new strength, Hermann Gessler of Brunegg, one of the bailiffs of Albert I., who had taken up his residence in the canton of Uri, after various other vexatious acts, caused the ducal hat of Austria to be raised on a pole in the market-place of Altorf, and commanded that every one who passed the pole should uncover his head as a token of respect for the house of Austria. William Tell with his little boy happened one day to pass the pole without paying any regard to the orders of the bailiff; and he was immediately seized and taken before Gessler. Tell had the reputation of being an excellent bowman, and Gessler devised a mode of punishment which should put his skill to a severe test. He ordered Tell's boy to be placed at a considerable distance from his father, and an apple to be fixed on his head. A crossbow and arrows were handed to Tell, who, without being observed, contrived to get two arrows, and he was ordered to shoot the apple from his own child's head. The tyrant added, that if he missed the apple, he should die. Tell succeeded in hitting the apple. Gessler had expected that Tell would kill or hurt his child, and in his disappointment he tried to find out some pretext for punishing the presumptuous peasant: he asked him why he had taken a second arrow? Tell boldly replied: 'It was intended for thee, if the first had hit my child.' The bailiff, delighted with this opportunity of satisfying his vengeance, ordered Tell to be bound and to be conveyed in a boat across the lake of Waldstädten to the castle at Küsnacht, the residence of Gessler, who himself accompanied his prisoner. When the boat was on the lake, a storm arose, which became so violent, that the rowers were unable to manage the boat, and proposed to Gessler to unfetter Tell and allow him to assist them, as he was known to be an experienced boatman and well acquainted with every part of the lake. Tell was freed from his fetters, and taking the rudder in his hand, he steered the boat towards a part of the rocky shore, where a flat shelf jutted out into the lake. When he was near this spot, he seized his bow, jumped upon the projecting rock, and with his foot pushed the boat back into the waters. The storm however was abating, and Gessler and his men were safely landed. Tell knew the road by which the bailiff had to pass to Küsnacht, and lay in wait for him in a narrow defile. When Gessler came, Tell shot him through the heart. This happened towards the end of the year 1307. The event was followed by a series of wars between the Swiss and the Austrians, which did not terminate till the year 1499.

The conduct of Tell was highly disapproved of by his friends, as they wished to avoid bloodshed, and were not yet prepared to carry their plans into execution. After this adventure Tell sinks again into his former obscurity, though he is said to have taken part in the battle of Morgarten, and to have perished, in 1350, in the river Schächen during a great flood.

Tell has been represented as a hero and a champion of liberty, by historians as well as by poets, but his conduct, if looked into more closely, will appear in a different light. His refusal to pay homage to the ducal hat of Austria was indeed owing to a noble independence of spirit; but his obeying the inhuman command of Gessler to shoot the apple from his child's head is repugnant to all paternal feelings, and a true hero would have aimed at the tyrant himself. He shot his enemy from an ambush, which, although in a measure an act of self-defence under the circumstances, yet in the manner of the execution was little better than murder.

But the truth of the story of Tell, notwithstanding its being commemorated down to this day by chapels and other public monuments, has been doubted by several modern historians; while others, and among them Johann von Müller, regard it as a genuine history. The doubts

about its truth have arisen from the fact that the story is told in the Wilkina Saga, and by Ivar the Frenzied, of a Danish king Harold and one Toke, a story is also told of one William Tell and a dorf who had extensive possessions in Uri, who lived early in the twelfth century. Another circumstance is that in the documents relating to the Swiss confederacies, and published by Kofler in 1835 ('Urkunden zur Geschichte der Schweizer Bünde') there is no mention of a Gessler who resided in the castle of Küsnacht. For other reasons, Grimm and Ideler (*Die Sage des Tell*, Berlin, 1826) consider the whole as fabulous. There are however facts which firm the historical truth of at least the greater part of the story. It was not many years after the death of Tell it became customary for annual processions to be held at the spot where Tell had escaped from the hands of the canton of Uri built the celebrated chapel at the same spot, and it is stated that among the persons who that year there were one hundred and four known Tell himself. His adventure is mentioned in the same effect by all the chroniclers who wrote after the alleged time of the occurrence.

TELLER, WILHELM ABRAHAM. He was born in Teller, minister of St. Thomas's church in Halle, born in that city, 9th January, 1734. So early as the age of twenty-two he attracted the attention of the literary world by a Latin translation of Keil's Hebrew Text; and after being for a year at the Nicolai church, very unexpectedly appointed professor of theology at the Duke of Brunswick, in 1761. On entering a new office, he published as an inaugural dissertation, 'Topice Scripturæ,' which was considered by August Bahrdt so heterodox in its opinions, that with some difficulty he could be prevailed upon not to accept of Teller's appointment. Not deterred by this from expressing his own convictions, Teller long afterwards his 'Lehrbuch des Christlichen Theologie' production that caused no little noise at the time, and violent disapprobation in some quarters, but not among his friends in others. Just before this he had been invited to accept the professorship at Halle, then vacant by the death of Baur, but he declined it out of regard towards his patron, and the persecution he continued to experience, whom his opinions had rendered him unpopular at his residence at Helmstädt so disagreeable without the least reluctance he exchanged his residence there, 1767, for Berlin, with the title of 'Oberconsistorial-Rath' and Dean of Coln. He removed him from their immediate attacks, and thus conferred upon him also in some measure the respect of his opponents; and at the same time he himself entered into intercourse with some of the most distinguished characters belonging to the reign of Frederick the Great. He was so far however from neglecting his professional duties or relaxing his zeal, that he continued to apply to his theological studies with the same assiduity as before, and was instrumental in promoting various plans connected with church matters and the improvement of public schools. The vast number of sermons and theological writings published by him, attest his industry, but his earnestness in the cause of religion, although his rejection of the dogmas of natural theology afforded his enemies and those who looked upon speculative points than upon religious feeling an opportunity to decry him as very heterodox, and unsound. 'Equally remote from the one hand, and from dry metaphysical philosophy on the other, Teller,' says Küttner, 'addresses the reason and the heart, and while he touches the heart carries conviction to the former.' Others speak of him in very high terms, not only as a teacher of religion, but as a man—one more distinguished in private life than in his public capacity, and more true to himself that conduct which he so often carried out upon others.

Besides his German writings, Teller published several theological and critical dissertations in Latin, and continued to employ his pen almost up to the time of his death; for though he was greatly worn

inued active to the last. He died at Berlin, 1804. (Jörden's *Lexicon*.)

OF THE EXCHEQUER were the holders of office in the Exchequer. They were four in their duties were to receive money payable into the Exchequer on behalf of the king, to give the clerk of the Exchequer (ins or rolls of parchment) a bill of receipt for the money, and to pay all money according to the warrant of the Exchequer; *Com. Dig.*, tit. 'Court,' D. 4, 14, 15.) The office was abolished by act of parliament (4 & 5 Wm. IV., c. 15.)

BALTHEZAR, a native of Lisbon, was born in 1610. In the eulogy of Dom Francisco Manoel, prefixed to Tellez's *Ethiopia*, he is said (at least this seems to be the meaning, which his affected style renders obscure) to have studied ten years, and taught forty; to have attracted attention to literature during the whole ten years of his career as student, but devoted two of them to philosophy, and four of them to lecturing upon *belles lettres* for twenty years in succession the most advanced literary Society's colleges at Braga, Evora, Lisbon, &c. He lectured two years on philosophy, but does not mention in what seminary. Lastly, Tellez was provincial professor of theology in the college of Lisbon. At a later period he was appointed house of the professed Jesuits in Lisbon, and provincial of the order in Portugal. He died in the 70th year, on the 19th of April, 1675.

His works of Tellez are:—1, *A compendium of the Summa Universae Philosophiae, cum quaeris inter Philosophos agitantur*, published in Lisbon, in 1642; at Paris, in two quarto volumes; and at Lisbon, in four octavo volumes, in the *Chronica da Companhia de Jesus da Provincia de Portugal*, in two volumes, the first published in 1645, the second in 1648, both at Lisbon: 3, *Historia geral da Alta*, in one folio volume, at Coimbra, in 1648, also said to have left in MS. a history of the Jesuits in the East. The historical works of Tellez are of more value than his philosophical treatise. The history of the Jesuits in Portugal is a valuable contribution to the history of that accomplished and energetic Society. The *History of Ethiopia*, or, more properly, the *History of the Jesuit-Missions in Ethiopia*, is indispensable to those who wish to study the history or comparative geography of Abyssinia. The first book contains the geography of Abyssinia, of its political government, and statistics, as they existed from the time of the Jesuit missionaries first entered the country, to their expulsion under Facilidas. The remaining books are chiefly occupied with the narrative of the missions, but contain important contributions to the general accuracy of which has, on the whole, been confirmed by the testimony of later travellers. Tellez gives an account of the authorities who have compiled his book, Manoel d'Almeyda, Jeronymo Lobo, and Pero Pays; and he himself of their information both with taste and accuracy.

Authorities for the statements in this sketch are the *Ethiopia*, with the preface by Tellez himself, the *Ethiopia* of Francisco Manoel prefixed to it; the *Bibliotheca Scripturarum* of Nicolao Antonio, in the *Dictionnaire de Louis Moreri*, and in the *Biographie Uni-*

ERRY. [HINDUSTAN, p. 207; MALABAR, p.

A. [CONCHACEA, vol. vii., pp. 428, 429.]

IDES. [CONCHACEA, vol. vii., p. 428.]

JUM, a metal which was discovered in 1782 at Reichenstein, but its properties were more fully examined by Klaproth sixteen years afterwards,

and he gave it the name it now bears. It is a scarce metal. Its properties are the following:—its colour is silver-white, and it is very brilliant: it is crystalline and brittle, of a lamellar fracture, easily pulverized, and a worse conductor of electricity than antimony or bismuth. Its specific gravity, according to Klaproth, is 6.115, while Magnus makes it 6.1379. It is nearly as fusible as antimony, and at a high temperature it boils, and may be distilled. When strongly heated in contact with air, it burns with a lively blue flame, green at the borders, and forms a white vapour, which has an acid odour.

The principal ores of tellurium are the following:—

Native Tellurium.—It is found crystallized and massive. Primary form a rhomboid; occurs in minute six-sided prisms, the terminal edges of which are usually replaced. Cleavage parallel to the faces of the prism. Fracture indistinct. Hardness: scratches sulphate of lime, and is scratched by the carbonate. Easily frangible. Colour tin-white or steel-grey. Lustre metallic. Specific gravity 5.7 to 6.115.

Before the blowpipe very fusible, burns with a greenish flame, and is volatilized in a white vapour. It is soluble in hydrochloric acid.

Massive Variety.—Granular. Colour splendid tin-white. Lustre metallic. Opaque. Specific gravity 6.115. It occurs in Transylvania.

Klaproth's analysis gives,—

Tellurium . . .	92.55
Iron . . .	7.20
Gold . . .	0.25

100.

Graphic Tellurium. Auro-argentiferous Tellurium.—Occurs crystallized. Primary form a right rhombic prism; occurs in attached flattened crystals, which are generally minute. Fracture uneven. Hardness: scratches talc, and is scratched by calcareous spar. It is brittle. Colour steel-grey. Lustre metallic. Opaque. Specific gravity 5.723.

Before the blowpipe it readily fuses into a globule, and is reduced to a metallic button of a bright yellow colour. Soluble in nitric acid, except a yellow metallic residue.

It occurs accompanying gold in narrow veins traversing porphyry at Offenbanya, and also at Nagyag, in Transylvania.

Analysis by

	Klaproth.	Berzelius.
Tellurium	60	62.
Gold	30	24.
Silver	10	11.3
Lead	1.5
	100	98.8

Berzelius found also a little sulphur, arsenic, antimony, iron, and copper.

Yellow Tellurium.—Occurs in imbedded crystalline laminae. Primary form a right rhombic prism. Traces of cleavage. Fracture uneven. Hardness: scratches gypsum, and is scratched by calcareous spar. Rather brittle. Colour silvery-white, inclining to brass-yellow. Lustre metallic. Opaque. Specific gravity 10.678.

By the blowpipe melts into a metallic globule. Partly soluble in nitric acid.

It occurs at Nagyag in Transylvania, and in the Altai Mountains in Siberia.

Analysis by Klaproth:—

Tellurium	44.75
Gold	26.75
Lead	19.50
Silver	8.50
Sulphur	0.50

100.

Black Tellurium.—Occurs crystallized, and in imbedded foliated masses. Primary form a square prism. Cleavage parallel to the terminal plane, in thin flexible laminae. Fracture indistinct. Hardness: scratches talc, and is scratched by gypsum. Colour dark lead-grey. Lustre metallic. Opaque. Specific gravity 7.065.

Before the blowpipe is fusible on charcoal, and covers it with oxide of lead; reducible into a grey metallic globule, which eventually leaves a button of gold.

It is found at Nagyag and Offenbanya in Transylvania.

Analysis of the ore from Nagyag, by Klapproth:—

Tellurium	32.2
Lead	54.0
Gold	9.0
Silver	0.5
Copper	1.3
Sulphur	3.0

100.

Brandes and Berthier have also analyzed this ore from Nagyag: their results differ considerably from the above, and also from each other.

Bismuthic Tellurium. Telluret of Bismuth.—Occurs crystallized in small six-sided prisms. Cleavage parallel to the base of the prism. Fracture indistinct. Hardness: scratches calcareous spar, and is scratched by fluor-spar. Colour steel-grey or zinc-white. Lustre metallic. Specific gravity 7.82.

Fusible by the blowpipe, and disengages the odour of selenium. Acted on by nitric acid, and the solution is precipitated by water.

It is found in Norway.

Analysis of Wehrle:—

Tellurium	31.6
Bismuth	60.0
Sulphur and traces of selenium	4.8

99.4

We shall now describe the more important binary compounds of tellurium, beginning with

Oxygen and Tellurium.—It has been already mentioned that when tellurium is heated in contact with air, it burns, and a white vapour is formed: this is oxide of tellurium, or tellurous acid. It may also be obtained by the action of nitric acid on the metal; by adding water to the solution, part of the oxide is precipitated, and the remainder is obtained by evaporation to dryness. The properties of this substance are, that it is a white granular anhydrous powder, which slowly reddens moist litmus-paper, and is insoluble in water and acids. It is dissolved by a solution of potash or soda, and by fusing with their carbonates crystallizable salts are formed: when these are decomposed by acids, hydrated tellurous acid is precipitated, which, if washed with very cold water, and dried at a temperature not above 53°, may be preserved without suffering change, and is soluble in water, acids, ammonia, and the alkaline carbonates, which last it decomposes: the aqueous solution reddens litmus-paper: when zinc, tin, and some other metals are left in a solution of this acid, they deoxidize it, and metallic tellurium is precipitated in the state of a black powder. Its salts are called tellurites.

It is composed of—

One equivalent of oxygen	8
One equivalent of tellurium	32

Equivalent 40

Sequioxide of Tellurium, or Telluric Acid.—This is obtained by fusing tellurous acid with nitrate of potash: by this it is oxidized completely, and the result is tellurate of potash: when chloride of barium is added to it, tellurate of barytes is precipitated, which, being decomposed by sulphuric acid, yields a solution of telluric acid; this yields hexagonal crystals of the acid: it acts but feebly as an acid, the dilute solution reddening litmus-paper with difficulty, and its taste is rather metallic than sour: the crystals contain water, two-thirds of which they lose at about 212°, and the remainder below a red heat becomes a mass of a fine orange colour, which is completely insoluble in water, either cold or boiling, or hot hydrochloric or nitric acids, or solution of potash. It is decomposed at a high temperature, and converted into a white powder, which is tellurous acid. Its salts are called tellurates.

It consists of

One and a half equivalent of oxygen	12
One equivalent of tellurium	32

Equivalent 44

Hydrogen and Tellurium.—When tellurium is alloyed by fusion with tin or zinc, and the compound is acted upon by hydrochloric acid, the hydrogen of the decomposed acid dissolves tellurium, and telluretted hydrogen gas is obtained. This gas has a smell somewhat resembling that

of hydrosulphuric acid: it is soluble in water. A claret-coloured solution; and, as it possesses metallic properties, though feebly, it has been called hydrotelluric. It decomposes many metallic salts, yielding metallic tellurium with the other metal. Chlorine, nitric acid, and the oxygen of the air, all take the hydrogen from tellurium.

It consists of

One equivalent of hydrogen	1
One equivalent of tellurium	32

Equivalent 33

Chlorine and Tellurium form two compounds: a feeble current of chlorine gas is passed over tellurium at a high temperature, the dichloride formed passes off as a violet-coloured vapour, which condenses at first into a black liquid, and eventually into a solid of the same colour. It is decomposed by the action of water into tellurium, which is precipitated, and chloride of chlorine remains in solution.

It is comprised of

One equivalent of chlorine	35.5
Two equivalents of tellurium	64

Equivalent 99.5

The **Chloride of Tellurium** is obtained, as above, by the action of water on the dichloride, but is purified by passing a larger quantity of chlorine gas over tellurium at a lower temperature than in forming the dichloride. It is volatile, and any excess of chlorine is removed by agitation with mercury and rectification. A crystalline solid is obtained, which is composed of

One equivalent of chlorine	35.5
One equivalent of tellurium	32

Equivalent 67.5

Sulphur and Tellurium combine in two proportions: a sulphuret is obtained when hydrosulphuric acid is passed through a solution of chloride of tellurium, or of a soluble tellurite. It is of a dark brown colour, and is soluble in a solution of potash. It is formed by

One equivalent of sulphur	16
One equivalent of tellurium	32

Equivalent 48

Persulphuret of Tellurium is obtained by the action of a solution of persulphuret of potassium with one of telluric acid. It is of a deep yellow colour; a very unstable compound, for it speedily becomes a sulphuret, and is converted into protosulphuret.

TELOPHONUS, Mr. Swainson's name for a species of *Laniæ* [SHRIKES, vol. xxi., p. 416], which he characterises:—

Bill more lengthened (than in *Lanius*), slightly the tooth smaller. Wings very short and roundly lengthened, graduated. Lateral toes free; the inner slightly shorter than the outer.

Example, *Telophonus leucogrammicus*.



Bill of *Telophonus leucogrammicus*. (Sw., *Classification of Birds*, p. 229.)

TEMANZA, TOMMASO, an architect who is known by his writings relative to his art than by his works which he executed, was the son of an architect, the nephew of another architect, Giovanni Scalfarini, was born at Venice in 1705. Having finished his mathematical studies in the school of Padre Niccolò and the eminent Marchese Poleni, he was appointed, although then only twenty-two—one of the members of the Commission of Engineers, and in 1742 he became chief of that body on the resignation of Bernardino, a few years before the latter's death. His share in the hydraulic commission caused him to be involved in literary disputes, he having offered to the people of Padua by a publication entitled 'Di Corso de' Fiumi in Padova e suoi Contorni,' which asserts that their ancestors had attempted to

the Brenta. As an architect he had not many ties afforded him, for the period of Venetian art and enterprise in art had passed away. He was employed to execute one of the very few public any kind erected at Venice in the last century, church of La Maddelena, a structure of the r, and which, though it may be said to be com- pure, is also somewhat feeble and insipid in his other principal architectural works are—the Santa Margherita, at Padua; the Rotunda at built at the expense of the Contarini family; ridge over the Brenta at Dolo. It is as a writer anza is chiefly known, more especially by his id *Eccellenti Architetti e Scultori Veneziani*, 4to., 3; which is one of the most copious as well as an works of the kind, not on account of the of lives it contains, it being in that respect at for the unusual extent at which they are a fact several of them, Palladio, Sansovino, &c., ously been published separately. Besides this reduction—an important contribution to archi- iography,—he published the *Antichità di Rio- io*, 1741; and left behind him another work, *chi e delle Volte, e delle Regole generali dell' ira Civile*, which was first edited in 1811. There se a great many letters by him on architectural Ticozzi's edition of Bottari's *Raccolta di Lettere ira*, &c.

za died at Venice, June 14, 1789, and was buried church of La Maddelena. There is a portrait of Jamba's *Galleria d'Uomini Illustri*, to which l to Comolli's *Bibliografia Storia Critica dell' ira Civile*, we are indebted for some of the par- ere given.

[SHROPSHIRE.]

SWAR, THE BANAT OF, is one of the finest remarkable portions of Hungary, comprehending ies of Torontal, Temes, and Krassova, and the and Wallacho-Illyrian districts. These two dis- sometimes not considered as part of the Banat. of the whole is 11,340 square miles, and the popu- l to be above a million; but there is no part of ad empire the population of which it is so dif- ascertain as that of Hungary. It is bounded on by the Maros, separating it from the counties of ongrad, and Csanad; on the west it is separated er Theiss from the counties of Csongrad and Bacs, zaisk district, and by the Danube from Slavonia; uth by the Danube from Servia; and on the east serna, and the offsets of the Carpathians, extend- Transylvania, from Little Wallachia, and Tran-

The Magyars comprehended it in the mili- ct of Kant. It was a frontier province against achians, the Bulgarians, and the Turks. The wever got possession of it in 1552, and retained it ; when, in consequence of the victories of Prince it was restored to Austria by the treaty of Passa- 1718. Under the disorderly rule of the Turks, try was overrun with banditti, so that many parts rly uninhabited and desert. Field-Marshal Count Mercy d'Argenteau, who was appointed governor, d in 1734, and Baron Engelshofen, his successor, themselves to improve it by inviting numerous s from Germany, Italy, and France, building towns ges, establishing manufactories, and erecting forts. Turkish war being renewed in 1737, many of these ments were ruined, and a great number of the colonists quitted the country. When peace was l numbers of Servians, Rascians, Macedonians, rians, came from the Turkish provinces, bringing erty with them. In 1752 the government was d from the military to the civil form, and, with the on of a temporary check during the Seven Years' : progress of improvement in this province has been

at is remarkable for the great varieties of cli- many parts the snow on the high mountains the deep ravines never melts, and in other parts only in severe winters. A third part of the country tainous, and almost everywhere well watered. The which has been gained by draining the morasses banks of the Theiss and the Danube, and in the levated tracts by clearing the old forests, is ex-

tremely fruitful. In the middle of the two military fron- tier districts lies the most extensive sandy tract in the whole Austrian empire, in which there are however many oases. The principal points of the high mountains are Sarko, Gugu, Muraru, and Godjan; on the lower moun- tains there are vast forests and fine pastures. The prin- cipal rivers are the Danube, Theiss, Maros, Körös, Neray, Temes, and Bega. In 1748 and the following years canals were made in order to drain the marshes: the principal of these is the Bega canal, 75 miles in length, which traverses the whole of the counties of Temes and Torontal, and is conducted into the Theiss. By the draining of the marshes, tracts which in the latter half of the last century were stagnant pools, the source of pestilential exhalations, are now covered with the finest corn-fields, or, where they have been imperfectly reclaimed, with crops of rice, and the salubrity of the country has been greatly improved. The protection which the moun- tains give against the east and north-east winds, and the mitigation which the north winds experience in traversing the great plain, raise the temperature to that of a southern country, and the rich soil yields abundant crops. The wheat and maize of the Banat are of the finest quality. Rice is extensively cultivated. Successful attempts have been made to cultivate cotton and silk, and in some parts a sweet wine is produced. There is no part of Hungary in which colonization has been attended with such favour- able results by the settlement of industrious foreigners as the Banat, where there is still so much uncultivated land, and where, with the exception of some marshy tracts, the climate is very healthy. Mineral springs are frequent, but little use is made of them. Only those of Me- hadia, which were known to the Romans by the name of *Thermæ Herculis*, are still much resorted to, especially by the Wallachian and Moldavian nobles. About this place, as well as in other parts of the Banat, Roman antiquities are frequently found. The population of the Banat, which is continually increasing by the accession of foreign set- tlers, consists chiefly of Wallachians, Rascians, Bulgarians, gypsies, Germans, Jews, French, Italians, and other foreign settlers: among whom, in the mountainous districts, the Wallachian language is prevalent; in the towns and colonised plains, the German; and in the districts of the military frontier, the Illyrian. The natural productions are horses, horned cattle, swine, wheat, maize, rice, flax, hemp, tobacco, fruit, wine, woad, madder, saffron, silk, timber, honey: game of all kinds and fish abound. The minerals are gold, silver, copper, zinc, and some iron. The gold is obtained by the gypsies, by washing the sand of the rivers. Between 4000 and 5000 workmen, chiefly Wallachians, are employed in the mines. The chief occu- pations of the inhabitants are agriculture and the breeding of cattle. There are no manufactures. The county of Temeswar, as has been stated, is one of the three included in the Banat, and needs no separate description. A circle of the county bears the same name.

TEMESWAR, the capital of the Banat and of the county, is a royal free city, situated in 45° 45' N. lat. and 21° 10' E. long., at the confluence of the Temes and the Bega, and on the Bega canal, in a part of the country which is rendered unhealthy by the stagnant waters in the vicinity. It is one of the strongest fortresses and one of the handsomest and most regular towns in the whole Austrian empire. While the town was in the possession of the Turks it consisted of only a few houses and an old castle, which is still habitable. When Prince Eugene made himself master of it in 1718, the strong fortifications were erected as a bulwark against the Turks, and the town was built in the modern style. The inner town, or fortress, is surrounded with triple walls and moats, and consists of large uniform stone houses, in straight, broad, well-paved streets. There are three gates, the Vienna, Peterwardien, and Transylvania gates, which are defended by strong blockhouses. The casemates are capable of containing 3000 men. Temeswar is the seat of the Roman Catholic bishop of Csanad, with his chapter and seminary, and of the schismatic Greek bishop of Temeswar: here too are the court of justice for the three counties, the offices of the governor of the fortress and of the commander of the Banat military frontier, a military academy, a great arsenal, and many other offices connected with the military and civil ad- ministration. The most remarkable buildings are—1, the old strong castle of John Hunyady, built of freestone, the

only relic of the antient Temes; 2, the churches, viz. the fine Gothic cathedral of St. George, belonging to the bishopric of Csanad, the cathedral of the schismatic Greeks, the Roman Catholic parish church, the churches of the Piarists, and of the seminary; 3, the elegant residence of the bishop of Csanad, the remarkably fine building in which the chapter resides, the house of the commander of the military frontier on the parade, the large and handsome county hall in the great square, the barracks, the military and civil hospitals, the synagogue, the Rascian town-hall, which contains the theatre and the assembly-rooms. Some of the churches were formerly Turkish mosques.

Temeswar has three suburbs, one before each gate, at the distance of 300 paces, with fine avenues of trees leading to them. Before the Vienna gate is the suburb Michala, inhabited by Wallachians, who have their own churches, and whose occupations are agriculture and the breeding of cattle. Before the Peterwardien gate is Josephstadt, an extremely pleasant suburb, with very broad straight streets, and trees planted in front of the houses. Many wealthy families reside here in the summer to enjoy the country, and formerly to avoid the fevers that usually prevailed in the town, but which have greatly abated since the surrounding marshes have been drained. The inhabitants of this suburb are Germans. The fine Bega canal passes through the middle of this suburb, and communicates with the Danube. Before the Transylvania gate lies the manufacturing suburb (*Fabriken Vorstadt*), so called from the great manufactories that were formerly established here, but most of which were broken up in 1738, when a Turkish war was apprehended; the suburb however retains its name. The Turkish merchants have their warehouses here. In this suburb there is a curious hydraulic engine, by means of which water is conveyed in iron pipes underground into the fortress: the inhabitants are chiefly Rascians. There is a considerable trade at Temeswar in the productions of the country, and some manufactures of cloth, paper, iron-wire, and silk. The population of the fortress is about 3000; and that of the whole town, including the suburbs, 13,000, besides the garrison.

(Brockhaus, *Conversations Lexicon*; Jenny, *Handbuch für Reisende in dem Oesterreichischen Kaiserstaate*; Thiele, *Das Königreich Ungarn*; *Die Oesterreichische National Encyclopädie*; Rohrer, *Statistik des Oesterreichischen Kaiserthums*; *Neueste Beschreibung von Ungarn, &c.*; Joseph von Hammer, *Geschichte des Osmanischen Reiches*; *Historisch-Statistischer Umriss von der Oesterreichischen Monarchie*. These two last works are anonymous. Hassel; Stein; Blumenbach; Hörschelmann; and Canabich.)

TEMIA, Le Vaillant's name for a genus of INSESSORES, or perching birds, which, Cuvier observes, M. Vieillot has changed into *Crypsirina*, and Dr. Horsfield into *Phrenotrix*, whilst M. Temminck arranges them under *Glaucopsis*.

Cuvier remarks, that these birds have the carriage and tail of the magpies, an elevated bill with the upper mandible convex, and the base furnished with velvety feathers, nearly as in the BIRDS OF PARADISE. The species most antiently known is, he observes, the *Corvus varians* of Latham, which is of a bronzed green colour, and found in India and Africa. Cuvier places the genus between *Caryocatactes* [NUTCRACKER] and *Glaucopsis*.

Mr. Swainson arranges *Crypsirina* in the subfamily *Glaucopinæ*, or Wattle-Crows, in his *Classification of Birds*; but in *Fauna Boreali Americana* he had made *Crypsirina* a subfamily. In the *Classification*, the genus is situated at the head of the *Glaucopinæ*, and is immediately succeeded by *Ptilostomus*, Sw.

Mr. Swainson thus characterises *Crypsirina* :—

Bill shorter than the head, much compressed; the culmen considerably arched, and curved from the base. Nostrils small, basal, concealed by incumbent feathers, which are either soft or setaceous. Wings short, much rounded; the primaries hardly longer than the secondaries. Tail feathers broad and obtuse. Feet moderate, arboreal. The middle toe and claw short, but as long as the tarsus;



Bill of *Crypsirina*. (Sw.)

lateral toes unequal; hind toe and claw shorter than the tarsus. India.'

Crypsirina vagabonda (vagabunda) and *Temia* among the species given as examples.

The first of these is the *Pica vagabunda* of *Century of Birds from the Himalaya Mountains*, thus described by him :—

'The specific denomination of this bird is based upon it in consequence of its peculiar habit of life. *Pica vagabonda*, or Wandering Pie, unlike the pies, who remain constantly stationary in one neighbourhood, seeking for their food in its vicinity, wanders from place to place, travelling over a large extent of country, and not evincing a partiality for any particular spot. The shorter tarsus of this bird, indeed, the shorter tail, are indicative of trees being its usual resort, where fruits and berries offer a more abundant food; whereas in the more typical *Pica*, the longer and more elongated beak fit them for the ground, in which they almost solely seek for their food. This species is more widely distributed than the congeners, being found in considerable abundance throughout India.'

'The head, neck, and crest are of a smoke colour, blackish-grey; the back light cinnamon; the wings grey; the quills black; tail grey; each being tipped largely with black; the under surface tawny; the beak and tarsi black. Length 16½; beak 1½; tarsi 1½; tail 10 inches.'



Pica Vagabunda. (Gould.)

Dr. Horsfield, who gives *Corvus varians* as one of his *Phrenotrix Temia* (the *Chakitut* or *new Javanese*), states that although not a rare bird in Java, *Phrenotrix* is by no means familiar, and never approaches the villages and habitations like many others. It is only to be observed near solitary hamlets situated in recently cleared land for cultivation, where its food is abundantly supplied by the insects contained in the mud and by the wild fruit-trees about the skirts. In consequence of the shortness of the wings, its flight is slow: it is chiefly seen about noon sailing heavily over the air in a right line towards the trees and the openings in the forest. The strength of the claws shows its adaptation to feed by pulling down insects.' (*Zoological Researches in Java*.)



Phthorula Temia. (Hort.)

TEMNU'RUS. [TROGONIDÆ.]

TEMPE Τίμπε, called also Thessala or Themalica or Phthiotica Tempe) was the ancient name of a beautiful valley in Thessaly, lying between Mount Olympus on the north and Mount Ossa on the south, near the mouth of the river Peneus, which runs through it. It is a narrow glen, not quite five miles long, opening on the east into a wide plain which extends to the Thermaic gulf. It forms the only break in the great chain of mountains by which Thessaly is enclosed on all sides. Ancient traditions asserted that the great plain of Thessaly was at one time covered with water, which was at length discharged by the vale of Tempe, which was opened by a stroke of Neptune's trident, or according to another legend by the strength of Hercules. The appearance of the country has led modern travellers to accept the mythical story as meaning that the pass was opened at some period by a great convulsion of nature. The rocks which enclose it rise in precipices from the bed of the Peneus, and at the narrowest point these precipices approach so near each other that the road is cut in the face of them.

The Greeks revered Tempe as the place from which Apollo transplanted to Delphi his sacred laurel, and admired it as the most beautiful spot in their country. The most vivid description of it is that of Aelian (*Var. Hist.*, iii. 1). See also Ovid, *Metamorph.*, i. 569, &c.; Livius, xlv. 6; Plin., *Hist. Nat.*, iv. 8; Cramer's *Greece*, i., p. 379; the Tours of Clarke, Holland, Dodwell, and Gell; and Thirlwall's *Hist. of Greece*, i., p. 5.

TEMPERAMENT *temperamentum*, εἶδος is a vague and unsatisfactory term, but still it is one which, as Dr. Mayo observes, *Pathology of the Human Mind*, London, 12mo., 1838, Append., p. 162, 'has for many centuries been found a convenient generalization; and, unless we propose to sacrifice knowledge at the altar of logic, we must still be contented to use this or some other equally indefinite term.' The word means literally a *tempering*, or *mixing together*, and may be defined to be a peculiar state of the system common to several individuals, which results from the various proportions in which the elementary parts of the human body are *mixed up together*, and which gives rise to a tendency to certain phenomena. There is besides in each individual a further peculiarity of combination, which serves to distinguish his temperament from that of any other person, to whom however he may in other respects bear a great resemblance. This individual temperament is called an *idiosyncrasy* (i.e. a *peculiar mixing together*), and, as the two words are sometimes confounded, it may be useful to have pointed out the distinction between them. All the different systems of organs in the human frame are accurately adjusted to each other, so as to produce one harmonious whole. If the disproportion be too great, disease ensues; but here are many gradations, compatible with health, where yet this disproportion is very observable. The predominance of any particular system of organs modifies the whole economy, impresses striking differences on the results of the organization, and has perhaps almost as great an influence on the moral and intellectual as on the physical faculties. Thus predominance establishes the temperament: it is the cause of it, and constitutes its essence. The ancients paid considerable attention to the

subject of temperaments, and pointed out various peculiarities in the constitution and actions of the human body, which have been seen so far to coincide with general observation, that their nomenclature has continued in very general use even to the present day, although the hypothesis on which it was founded is universally discarded. They described four temperaments corresponding to the four qualities of Hippocrates—hot, cold, moist, and dry. It was supposed that there were four corresponding primary components of the human body, namely, blood (αἷμα), phlegm or pituita (φλίγμα), and the two kinds of bile (αἰ εἰς χολαί), yellow bile (ξανθὴ χολή), and black bile or atrabillis (μύλαινα χολή); and the preponderance of one or other of these components in different persons produced the different temperaments. These four primary principles of living bodies were supposed to be compounded of the simple elements or qualities of nature thus: hot and moist produce blood; cold and moist, phlegm or pituita; hot and dry, yellow bile; and cold and dry, black bile. Bodies in which blood superabounds are of the sanguine temperament; if phlegm is in excess, the phlegmatic temperament is developed; if yellow bile, the choleric; and if black bile, the melancholic or atrabillious temperament.

The following is the description of the different temperaments given by Paulus Aegineta (*De Re Medica*, lib. i., cap. 61), in Mr. Adam's Translation (London, 1834, 8vo.):— 'Those bodies which are of a hotter temperament than the moderate will have their teeth earlier than usual, and will grow in like manner. They feel warmer to the touch, and have less fat; they are of a ruddy colour, and have their hair black and moderately thick, and their veins are large. But if such a one be also fat and brawny, and have large veins, he is fat from habit, and not from nature. The following are the symptoms of a cold temperament: such bodies appear cold to the touch, are without hair, and are fat; their complexion, like their hair, being tawny. But when the coldness is great, they are pale, leaden-coloured, and have small veins; and if lean, this does not proceed from nature, but habit. The dry is harder and more slender than the temperate, the hardness indeed being inseparable from the dry temperament; but leanness not only follows the connate temperaments, but also those which are acquired by long habit. It is peculiar to the humid temperament that the body is oppressed by things of a moist nature. The warm and dry temperament, in other words, the *choleric*, is extremely shaggy, having the hair of the head in early age of rapid growth, black, and thick; but in after-life baldness follows. The veins are large, as are likewise the arteries, which beat strongly. The whole body is firm, well articulated, muscular, and without obesity; and the skin hard and dark. When the temperament is cold and humid, or *phlegmatic*, the chest is narrow, and, like the rest of the body, without hairs; the skin is soft and white, and its hairs somewhat tawny, especially in youth; and such persons do not get bald when they grow old: they are timid, spiritless, and inactive; their veins are invisible; they are gross and fat; their muscles and legs are feeble, and their joints ill-formed; and they are bandy-legged. But should the humidity and coldness increase, the colour of their skin and hair becomes tawny, or, if they increase still more, pale. The hot and humid, or *sanguine*, temperament is softer and more fleshy than the proper, and, when it increases much, is subject to putrid disorders; but if it be only a little more humid and much hotter than the moderate, the bodies of such persons are only a little more soft and fleshy than the moderate, but they are much more hairy and hotter to the touch. But if the cold and dry grow equally together, and form the *melancholic* temperament, such persons have naturally their bodies hard, slender, and white, with fine muscles, small joints, and little hair; and they are cold to the touch. Although slender, fat is mixed with their flesh. The colour of their hair is correspondent to the degree of constitutional coldness. As to disposition of mind, they are spiritless, timid, and desponding. To say all in a word, with regard to the compound temperaments, they are always to be distinguished by the marks of the prevailing quality.'

The due admixture of these different qualities was supposed to constitute the best form of temperament or constitution (*σιεπασία*), of which the following is Paulus Aegineta's description (*Ibid.*, i. 60):— 'That man is in the best temperament of body when it is in a medium between all extremes, of leanness and obesity, of softness and hard-

ness, of heat and cold, of moisture and dryness; and, in a word, who has all the natural and vital energies in a faultless state. His hair also should be neither thick nor thin, neither black nor white. When a boy, his locks should be rather tawny than black, but when an adult, the contrarywise.

Further information respecting the opinions of the ancients on the subject of the temperaments may be found in the treatise of Hippocrates, *De Natura Hominis*, tom. i., ed. Kühn; in Galen's works, *De Elementis ex Hippocrate*, tom. i., *De Temperamentis*, tom. i., *De Optima Corporis nostri Constitutione*, tom. iv., *De Sanitate Tuenda*, lib. v., tom. vi., and his *Ars Medica*, tom. i.; Oribasius, *Synopsis*, lib. v., cap. 43, sq.; Aëtius, *Libri Medicinales*, lib. iv., cap. 53, sq.; Haly Abbas, *Theor.*, lib. i.; Averroes, *Collig.*, lib. vi.; Alsaheavius, *Theor.*, tract. vi.; and Avicenna, *Cantica*.

After the revival of letters, this fourfold division was adopted in its most essential parts by all the most eminent physiologists. Stahl ingeniously adapted it to the modern doctrines of the humoral pathology; and even Boerhaave, although he increased the number of the temperaments to eight, and relinquished the erroneous opinions of Hippocrates and Galen respecting the constitution of the blood, yet he still derived the characters of his temperaments from the principles of the humoral pathology, and supposed them to be formed merely by different combinations of the four cardinal qualities. Many late physiologists have been inclined to doubt whether the external characters associated with the four temperaments are real and constant signs of diversity in bodily structure, and enable us to distinguish the principal varieties of constitution which exist. Several attempts have accordingly been made to define in a more satisfactory manner the peculiarities of organization and the resulting varieties of predisposition, which are chiefly interesting with regard to pathology. Hoffmann and Cullen have indeed retained the old division, supposing that the theory of the ancients as to the peculiarities of constitution was founded originally upon facts, though subsequently combined with an erroneous theory. Haller seems to have been the first who decidedly opposed the ancient doctrine, not only by showing that there was no foundation for the varieties of the temperaments in the peculiar nature of the fluids, but by substituting in their place the vital actions of the system. Darwin proceeded upon the principle of Haller; and, in conformity with the hypothesis which he adopted of reducing these actions to the four heads of irritation, sensation, volition, and association, he formed four temperaments in which these qualities were supposed respectively to prevail. The only attempt however to improve upon the Hippocratic theory and division which has been attended with any degree of success is that by Dr. Gregory, who to the four temperaments of the ancients added a fifth, which he called the *nervous*, and bestowed upon three of the others the new appellations of the *tonic*, the *relaxed*, and *muscular* temperaments. Dr. Prichard however restricts the number to four, and designates them by their original names; remarking that only four strongly marked diversities of external character present themselves to observation; that the nervous temperament is not so distinguished; and that therefore, as this is an essential part of the original scheme for the distribution of temperaments, the improvement proposed by Dr. Gregory is lame and defective. These four varieties then of external character really indicate, more or less constantly, well marked differences of constitution, and likewise of morbid predisposition. There is no doubt that persons having the complexion and other signs of the sanguine temperament are more liable to certain classes of disorders than the phlegmatic or melancholic, while the latter have their own peculiar tendencies. The sanguine, having a fully developed vascular structure, and therefore a vigorous circulation of blood, a warm skin, and a high degree of organic sensibility, are more liable to sudden and powerful impressions from external agents than those of more languid vital functions. They are subject in a greater degree to severe inflammatory disorders, and disorders of this class are in them more acute: they bear however, better than persons of more languid habit, evacuations of blood and the other measures which are found to be the proper remedies for these diseases. The greater fulness of blood-vessels, of those at least which are near the surface, the greater warmth of the skin, and the florid complexion of

the sanguine, afford reason to believe that the designation given to this temperament is not wholly unfounded. We likewise find that sanguine persons are more subject to hemorrhages (to those at least which are termed arterial) as arising from excess in the force of circulation through the arteries. Individuals of the phlegmatic temperament are predisposed to disorders arising from, or connected with, a low degree of vital energy. Local congestions of blood arising independently of general excitement come under this category. Glandular and tubercular diseases take place in bodies weak; in the structures connected with the vital functions, and are perhaps more frequent in the phlegmatic than in other temperaments. Inflammatory complaints, when they attack the phlegmatic, are less acute and more disposed to terminate in chronic diseases than are those of the sanguine constitution, when at least the latter have been treated by appropriate remedies. The relations of the choleric to the melancholic temperament are similar to the relations which the phlegmatic bears to the sanguine; the former displays greater vigour both in health and disease, than the latter. The choleric and sanguine, when affected by diseases of the nervous system, have complaints of greater violence and acuteness; mania or raving madness belongs particularly according to the observations of M. Esquirol and many others) to these constitutions. The melancholic temperament is most prone to monomania, attended with depression and melancholy illusions. Hypochondriasis more frequently affects the phlegmatic and melancholic, though it is occasionally observed in persons who have some of the external characters of the sanguine temperament. The most severe cases of hypochondriasis, says Dr. Prichard, and those which approached most nearly to the character of melancholia, have certainly occurred in individuals of a dark leaden complexion, fixed and stolid aspect, and lank coal-black hair.

But it is not merely on the body, both in its healthy and morbid state, that the temperament exerts an important influence; the relation of the different forms of physical organization to the intellectual, and even to the moral, faculties is equally marked and apparent. The relation of mental peculiarities to the structure of the body has been observed by medical authors of every age, and has been stated and explained in different ways. Hippocrates said that 'the soul is the same in all men, but that the body is different in different individuals. The soul never like itself both in greater and in less, for it undergoes change neither by nature nor by necessity; but the body is subject to continual alterations.—The affections of the mind depend upon the body; there are many states of the latter which shapen, and many which obtund it.' (*Hipp. De Victus Ratione*, lib. i., § 21, tom. i., p. 650.) Democritus, in a letter said to have been addressed by him to Hippocrates, asserted that 'the intelligence of the mind depends greatly on the body, the diseases of which obscure the mental faculties, and draw the latter into concealment.' (*Hipp., Epist.*, tom. iii., p. 824.) Among the writings of Galen there is a treatise entitled *Quod Animi Mores Corporis Temperamenta sequantur* (tom. iv., ed. Kühn), written expressly to establish the connection between the passions and desires of the mind and the temperaments, wherein he has handled the subject very ingeniously and has delivered many profound views of the animal economy. But it is in the works of modern writers that we find this doctrine most fully developed, and made a foundation for a division of human characters. According to Hoffmann, the choleric temperament by peculiarity of organization disposes men to precipitate and impetuous conduct, to anger, audacity, impatience, temerity, quarrels, sedition, and the like. On the other hand the slow progress of the blood through the vessels of the meninges, which is the result of its crassitude in melancholics, renders such persons timid, slow in business, anxious, suspicious, with difficulty of forming or uttering opinions. The sanguine by a happier temperament are rendered cheerful and free from care. A too abundant serosity causes the phlegmatic to be lazy, somnolent, and torpid. Certain temperaments qualify men for particular situations in life. Melancholic men, says Hoffmann, should be the king's ministers and counsellors; choleric persons should be appointed generals, foreign ambassadors, orators, and conductors of all business requiring energy and dispatch; and it was with some such impression concerning the peculiar qualities of this temperament that Napoleon, after com-

of its inconvenient effects in deranging his temper said by M. Ségur to have added, 'Cependant sans laudite bile on ne gagne pas de grandes batailles.' ne men, continues the writer above mentioned, are courtiers; but individuals who have the misfortune of the phlegmatic temperament, being quite incommo- to any elevated condition, must be made common or labourers, and condemned to the lowest em- nts. (*De Temperamento Fundamento Morborum*, uoted by Dr. Prichard.) It is extremely improba- it an opinion should have held its ground for so ages among men of observation, especially on a requiring no abstruse research, without some found- at least in fact. The doctrine of temperaments is a certain extent, and has ever been confirmed by al to experience. States of the mind are so con- h affections of the body, that it is impossible for who considers all the physiological facts that themselves in connection with this subject to t with each temperament particular mental must be associated, although it is manifest that vi rs have indulged their fancy on this subject, ive gone into more full and minute details than nce will establish. The same may be said of phre- with which science the doctrine of the tempera- s in this point of view closely connected, as modin s : degree the intellectual and moral qualities ou the organization of the brain. This very subject is discussed at some length in Dr. u's article on 'Temperament' in the *Cyclopædia of al Medicine*, from which most of the preceding obser- are taken. See also Bostock, Richerand, and Müll- orks on Physiology, and other writers there quoted.

TEMPERAMENT. [TUNING.]
TEMPERATURE. [ATMOSPHERE; CLIMATE; ISO-
AL LINES.]
TEMPERATURE OF THE EARTH. [GEOLOGY, p.

TEMPERATURE. It is intended under this head to the law of the variations of temperature on the so far only as to indicate its analogy with that of variations of terrestrial magnetism; the formulæ ex- the mean temperatures at different places being, far from affording satisfactory results, and ob- ons being too few to serve as a basis for correct : In CLIMATE there are given some general ob- ns cerning the distribution of heat at the sur- earth, and under ISOTHERMAL LINES there will the estimated values of the mean temperatures quator and at the geographical north pole. With to the former, it may be said to have been tolerably eter d, and to be nearly uniform quite round the l: mean temperature at the pole can only be from the uncertain evidence afforded by an ap- of the formula of temperature which has been old good in the north of Europe, and a correc- on an estimated amount of the frigorific in- uice: even the determination thus obtained is d still further uncertain by the fact that the de- f temperature in proceeding from the equator is different on meridians which differ con- ou longitude. this difference of temperature on the same of latitude in the old and new continents was or rewarded, a simple formula was thought suffi- e the temperature at any parallel of terres- e. The celebrated Tobias Mayer, from such rates as had in his time been observed, the temperature t (on Fahrenheit's scale) at t be represented by $T - 52^{\circ} \sin.^2 L$, where T rature at the equator, and L the geo- ue of the place; and in 1819 M. Daubuisson e crys sie) proposed the more accurate formula $52^{\circ} \cos.^2 L$ (centigrade scale); which being adapted to s scale, considering the mean temperature at or to be 81° , becomes $32^{\circ} + 49^{\circ} \cos.^2 L$. This as been found to serve for temperatures in as far north as the latitude of 60° ; but beyond that it is useless, and it supposes the temperature at the al pole to be 32° , which is much too high. above 4000 observations which were made by Sir y, it is found that in Winter Harbour, in 74° and in long. 250° (110° W. long.), the mean l. c., No. 1510.

temperature is as low as $1^{\circ}33'$; and from above 600 ob- servations at Spitzbergen (78° N. lat.) Mr. Scoresby found the mean temperature to be $16^{\circ}99'$: a mean temperature of 17° is also found on the American continent, in 65° N. lat.; and hence it may be inferred that, between the parallels of 65° and 78° , and near the meridian of Winter Island, there exists a pole of minimum temperature. The mean temperatures of places in the eastern parts of Asia have not been well ascertained; but since at North Cape in Lapland the mean temperature is that of freezing water, and in Siberia, as low as the parallel of 60° N. lat., the surface of the ground is constantly frozen, it is evi- dent that the isothermal line of 32° must form a curve about some point as a focus in the northern part of the Asiatic continent: hence, for determining the mean temperature of any place, no formula which does not involve the posi- tion of the place with respect to the two foci of coldness can be expected to satisfy the phenomena.

This circumstance has suggested to Sir David Brewster the formula $T = (t - \tau) \sin.^n \delta \sin.^n \delta' + \tau$ for the mean temperature at any place: T being that temperature, t the mean temperature at the equator, τ the temperature at each of the foci of coldness, and δ, δ' , the distances in de- grees between the given place and those foci. A corre- sponding expression will serve to determine the number of vibrations which would be performed by a magnetized needle in a given time if t and τ be made to represent the numbers performed, in an equal time, at the magnetic equator and at either of the poles of magnetic intensity: the exponent n , both for temperature and intensity, is to be determined by means of observations, and Brewster considers that the fraction $\frac{1}{2}$ may be the value of it in the formula for temperature.

The similarity of character which is presented by the isothermal lines and those of magnetic dip and intensity, with respect to two polar points in one hemisphere of the earth, and the fact that the poles of temperature and mag- netism lie nearly in the same parts of the world, cannot fail to suggest the idea that there may be a connection between the temperature and magnetism of the earth. It is generally believed, also, that the temperature of the western parts of Europe is now higher than it was nearly two thousand years since; and it has, hence, been inferred that the poles of minimum temperature perform revolu- tions about the geographical pole of the earth, so that the terrestrial meridian on which the greatest cold prevails gradually changes its position. If this opinion be well founded, the circumstance will afford another argument in favour of the hypothesis which assigns to the tempera- ture and magnetism of the earth an intimate connection with each other, by its correspondence to those motions of the poles of magnetic dip which have been adduced from observations by M. Hansteen. [TERRESTRIAL MAGNETISM.]

As the mean temperature at the surface of the earth is an element of great importance in the present state of physical science, it has been strongly recommended to travellers and persons making distant voyages, if they are to remain only a few days at any place, that they should, on arriving, lose no time in burying in the earth, to the depth of from three to twelve feet, according to the power of penetrating into the soil, bottles filled with water, or with spirits, if there should be any danger of water freezing. These bottles should be packed in boxes stuffed with woollen cloths, pounded charcoal, or any other non- conducting material, and should be allowed to remain underground till the time of departure, in order that they may acquire, as accurately as possible, the temperature of the ground. On being taken up, the temperature of the liquid should be ascertained by a good thermometer in- serted in the bottle.

TEMPERATURE OF PLANTS. The living processes by which heat is so evidently developed in animals go on, though much less actively, in plants, and give to them a peculiar temperature, independent of the air in which they live. The periods at which an increase in the temperature of plants has been most evidently observed are those of germination, flowering, and impregnation; but it is only because those chemical changes which produce heat are more active during the performance of those functions that the heat becomes more evident. The great cause of the development of heat in animals is the union or com- bustion of carbon with oxygen, which is constantly taking place during the process of nutrition in the various tissues of

the animal body. The same thing occurs during the general growth of the plant: a certain quantity of carbonaceous matter is contained in the sap of the plant, which, coming in contact with oxygen in the tissues of the plant, unites with it, forms carbonic acid, and heat is developed.

That a development of heat took place during the growth of plants was proved by Hunter, who placed a thermometer within the stems of several trees, and found that their temperature was always above that of the atmosphere. These experiments were followed up by Salomé, Hermstadt, and others, who confirmed the experiments of Hunter. De Candolle however supposed that this increase of temperature depended on the sap which was pumped up from the soil; but this theory will not explain the phenomena of heat observed during the growth of plants, nor is it at all applicable to its occurrence during germination, which is evidently an analogous process.

Schubler, Neuffer, Nau, and Goepfert have conducted a variety of experiments on the temperature of plants. They found that in winter the parts that were not frozen had a higher temperature than the surrounding air: this was much more remarkably the case in spring; but in summer the temperature of the plant was mostly below that of the surrounding air. These experiments are in accordance with what we know to be the law of the development of heat in more highly organized textures. In winter the vital processes of plants are slow or almost suspended; hence the small increase of temperature at that season. In the spring the process of growth is most rapid, and there is the greatest conversion of nutritive matter into the structure of the plant, and it is at this season of the year that the temperature of the plant is highest above the surrounding air; but in summer the heat of the air becomes greater, and the temperature of the plant is kept under that of the atmosphere by the exhalation which is constantly going on from all parts of its surface.

In the development of heat during germination the changes that take place are more evident. The starch or fecula surrounding the young plant is converted into sugar, and this process takes place through the separation of carbon and oxygen in the form of carbonic acid, which, during their union, give out heat. A familiar instance of this process is seen in the increased heat of the growing barley previous to its being dried to form malt.

The increase of heat is more evident still in the flowering of plants, which, according to Dunal, results from the conversion of a certain portion of starch or fecula in the disk and petals of the plant into sugar, for the nutrition of the anthers and ovules of young plant. The increased heat of the flowers of plants during certain stages of their development was first observed by Madame Hubert in Madagascar, who, being blind, was the more dependent on the organ of touch; and in handling plants she found that the *Arum cordifolium* was much warmer than others. This led Bory St. Vincent to pursue a series of experiments on this plant, in which he found a very high degree of heat developed during its flowering, which was sometimes 7° higher than the surrounding atmosphere. The flowers of the *Arum* tribe are very favourably constructed for the development and retention of heat; but all flowers, previous to the full development of their anthers and the function of impregnation, undergo these changes, which produce an increase of temperature.

(Meyen's *Pflanzen Physiologie*, band ii.; and Lindley's *Introduction to Botany*.)

TEMPERING OF STEEL. [STEEL.]

TEMPESTA, ANTONIO, a celebrated Italian battle and animal painter and engraver, was born at Florence in 1553. He became the scholar of John Strada or Stradanus, a Fleming, who was settled at Florence in the employ of the grand-duke, and who assisted him in the battles which he painted in the old ducal palace. Tempesta, after painting some years with Strada, whom he surpassed in many respects, visited Rome, and was employed by Gregory XIII., in the Vatican, where he painted, in small figures in fresco, the Translation of the Body of St. Gregory of Nazianzus, and some other subjects, which acquired him a great reputation among the artists and virtuosi of Rome, and procured him constant occupation from the Roman nobility. He executed several good works for the Cardinal Alessandro Farnese, at his villa at Caprarola, and some at Bassano for the Marquess Giustiniani. Tempesta resided chiefly at Rome, and died there in 1630, aged seventy-

five. His reputation rests now almost entirely upon his etchings, although in his time he had a great name as a painter. Lanzi terms him the first Italian who ever attained distinction in landscape and animal painting, and considers him at this period to have been unrivalled in his own style in Italy; he was however surpassed afterwards by Cerquozzi and Borgognone. Horses were his favourite subjects, and he excelled in battles, processions, cavalcades, hunts, and various field-sports. His designs, particularly his etchings, are remarkable for their spirit and boldness of conception, but they are at the same time coarse and heavy, and careless in their execution. He painted generally small figures; in large ones he was not successful, and he seldom attempted them: he however occasionally prepared large cartoons for tapestries, in the style of his master Strada. Tempesta's chief works in painting, besides those in the Vatican, already noticed, were a Slaughter of the Innocents, in the Church of San Stefano Rotondo, at Rome; and two great cavalcades and state-processions, executed for the Cardinal Scipione Borghese, as friezes around the loggia of his palace on Monte Cavallo (afterwards Palazzo Bentivoglio), which, according to his biographer and contemporary Baglioni, were alone sufficient to have ensured him a lasting reputation if he had never painted anything else. One represented a state procession of the Pope: the other, one of the Grand Turk. Tempesta has executed etchings of both these subjects. His invention was amazingly fertile: he has been equalled by few artists in the number of his designs. According to Gandellini, Tempesta etched 150 plates, and about 500 have been engraved after him by other masters. He also engraved after other masters himself; he executed some battles, and 40 plates of the Spanish story of 'The Seven Twin Sons of Tara,' after Otho Venius: Filibien, in his 'Entretiens sur les Vies des plus célèbres Peintres,' has related the story at length, and has described the subject of each plate.

Tempesta's style of etching is peculiar and not able; and although his designs are bold, and contain grand parts, they are heavy, his style of design gross, compositions generally confused, and his light and disposed without taste: his most valuable designs are hunts and field-sports, and his studies of horses. Of other pieces the following are among the best and most celebrated:—

A set of 150 illustrations to the Old Testament, known as 'Tempesta's Bible': 15 large figures of Christ, the Virgin and the Apostles: a very large plate of the Victory of Jews over the Amalekites, marked 'Hebraeorum Victoria ab Amalechitis reportata,' the composition of which is spirited, but very confused; the Life of St. Antony plates; 150 small plates from Ovid's 'Metamorphoses': 13 of the Labours of Hercules: and 7 of the Wonders of the Antient World. He etched many cavalcades and processions, and engraved also large plates of the following statues—they are however executed much in his own style to be faithful representations of the originals:—Castor and Pollux, and the horses on Cavallo, and the equestrian statue of Marcus Aurelius in the Capitol, at Rome; and the equestrian statue of Charles V. by John of Bologna, at Florence; that of Henry IV. of France, at Paris, which was destroyed in 1792; and one of Henry II. of France. The last statue however existed, for a figure of Louis XIII. was placed upon the horse which was originally designed for a statue of Henry II., who was killed at a tournament. Tempesta's bears the following inscription: 'Effigies equi aenei a Dan. Ricci, Volterrani, fieri jussit Reg. Maria ob Reg. Henrici II. F. M. sui viri, qui obiit in tomi'

A spirited design of the Battle of the Centaurs and Lapithae, by Tempesta, was cut in a large size in wood, by Jeronime Parobole. As a man Tempesta appears inferior to his contemporary Baglione, to have been accomplished in every respect, and to have been highly esteemed by his companions. There is a list of the works of Tempesta in Heineken's 'Dictionnaire des Artistes,' &c., and in the 'Peintre Graveur' of

TEMPESTA, CAVALIERE, called also in Italy, by Mulier or de Mulieribus. This artist, who is sometimes confounded with Antonio Tempesta, was a native of Holland, although better known in Italy, and his name was Peter Molyn. Fiorillo says he was the landscape-painter of the same name, and was born at

637. He was called Tempesta through his skill in painting sea-storms and similar subjects, in which he was eminent, and in some respects rivalled Backhuysen: also nearly equally excellent as an animal painter, especially of wild animals, and some have said that had he been in his own country and pursued entirely such a course he would have rivalled Rubens and Snyders in that department. There is yet another comparison to be made respecting him; he rivalled, or perhaps surpassed, the Venetian Casdagno in moral depravity. Pascoli, who gives an account of Tempesta in his 'Lives of the Artists,' says that his father was a merchant, and that he intended to bring up his son to his own business; but the latter was however naturally so fond of drawing, that, even as a boy, instead of going to school, he used, under the sanction of his parents, to spend his time in sketching upon paper, sometimes drawing the sea and shipping off the coast, and at others cattle grazing near the shore. He was eventually allowed to take his own course, but he appears to have been his only or at least chief master. He was distinguished by great success in various cities of the Netherlands, he became acquainted at Antwerp, in about the year 1610, with a monk of the barefooted Carmelites, who converted him from Calvinism, in which he had been brought up, to Popery, and Tempesta was thence strongly induced to make a journey to Rome. At Rome he found a powerful patron in the Duke Bracciano, and his success surpassed his expectations. He received so many orders and commissions, that he was obliged to employ assistants; and one of these, his favourite, known as Tempesta's wife, became his wife. He however never appears to have had in great amity with her, but the fault is said to have been in Tempesta's. The story of the deep tragedy allowed is told differently by Pascoli, and the artist's 'Museo Fiorentino,' in which there is a Life of Tempesta, but there is no discrepancy in their statements as to the main fact. Tempesta made up his mind to leave Rome, in order to get rid of his wife, and he requested the permission of the Duke Bracciano to depart: the duke consented, but unwillingly, yet he presented Tempesta with a cross and a chain of gold, and knighted him on his departure. Tempesta left Rome, and proceeded to send for his wife as soon as he was settled; he was met by Venice and Milan, where he made a short stay. In Genoa he was as successful as he had been in Rome; but soon after his arrival he became acquainted with a beautiful Genoese lady, and being unable to obtain possession of her except by marriage, he refused to marry her, and he got over the obstacle of having one wife in the following infamous manner: he dispatched a hired assassin to Rome, with a letter to his wife, ordering her to accompany the bearer to Genoa; his wife, who knew her husband's character, and disliked the messenger, delayed going, but she soon received summons from her husband she complied, and commenced the fatal journey. The unfortunate lady was murdered by the ruffian, her companion, at Genoa. The affair was not long a secret, and Tempesta was soon afterwards arrested upon suspicion, and convicted, and condemned to death. The sentence was never carried into execution: Tempesta obtained a respite, or, according to the other account, had recourse to interest to obtain a commutation of sentence to a term of death to one of perpetual imprisonment. He says he was set at liberty again, after remaining some time in prison, through the intercession of the Count of Milan, governor of Milan; according to the other account he regained his liberty during the bombardment of Genoa in 1654, when the prisons were thrown open, and he suffered an imprisonment of sixteen years. He was however busily employed with his pencil during the confinement, and he found it difficult to satisfy the demand for pictures. On recovering his liberty he went to Genoa, and there he established himself, where, through his notoriety, his success was even greater than it had been previously either at Rome or at Genoa. He received a great income, lived in splendid style, and kept a private menagerie, containing many species of wild animals, solely for the purpose of painting them. His conduct at this period of his life was still more dissipated than with his previous immorality, for though enjoying the greatest affluence, he not only deserted his second

wife, but left her destitute, according to Pascoli; yet how such conduct could be suffered by the laws is difficult to understand. He had several mistresses, and he acquired the cognomen of *Mulier* or *de Mulieribus* by his profligate habits; Peter Mulier is the name by which he is best known in Italy. As he grew old his powers of painting forsook him, and his means accordingly gradually diminished, and as he was too improvident to make any provision for his old age, his affairs became embarrassed at the end of his life. He died of a fever in 1701, aged 64, in a state of poverty when compared with his former affluence. His pictures are numerous in the collections of the north of Italy: those which he painted during his imprisonment are generally accounted his best.

TEMPIO. [SARDEGNA.]

TEMPLARS, KNIGHTS TEMPLARS, or KNIGHTS OF THE TEMPLE, are the popular designations for the Brethren of the Temple of Solomon at Jerusalem, also called the *Soldiery of the Temple* (*Militia Templi*) and the *Soldiers of Christ*. The three great religious military Orders, the *Knights of the Hospital of St. John of Jerusalem* (commonly called the *Knights Hospitallers*), the *Templars*, and the *Teutonic Knights of St. Mary of Jerusalem* (or *German Knights of the Cross*), all originated in the twelfth century; the two former towards its commencement, during the first crusade, the last not till near its close. The founders of the Order of the Templars, which is held to date from the year 1118 or 1119, were nine Knights, all French, of whom the two chief were *Hugues de Payens* or *de Paganès* and *Geoffroi de St Omer* (or *St. Ademar*). One account makes all the nine to have been previously members of the Order of St. John; but it is at least doubtful if this was the case. At all events, the Hospitallers were not yet a military order; their distinguishing profession was to entertain pilgrims and to attend the sick and wounded; the idea of adding to the three common vows of chastity, poverty, and obedience, an engagement to fight against the infidels, appears to have been first put in practice by *De Payens* and his brethren. Up to this time, when a knight entered the society of the Hospitallers, he seems to have laid aside his arms. Nor probably did the nine Knights forming the new association at first contemplate either the extensively military character which their order eventually assumed, or even the establishment of an order which should extend and perpetuate itself. Their original vow was simply to maintain free passage for the pilgrims who should visit the Holy Land; nor did they proceed to add to their number till six or seven years after their association. In another respect also their early condition and pretensions were remarkably contrasted with their subsequent state; for at this time they made the greatest show of poverty, even *De Payens*, who was styled *Master*, and his friend *De St. Omer*, keeping only one horse between them, a circumstance commemorated in the seal of the order, which represents two armed knights mounted one behind the other on the same horse. At this their beginning, indeed, the name which they took, and by which they were commonly known, was the *Pauper soldiers* (*Pauperes Commilitones*) of the Holy City; and they professed to have no source of subsistence but the alms of the faithful. The king of Jerusalem, *Baldwin II.*, gave them their first place of residence, a part of his palace; to which the abbot and canons of the church and convent of the Temple, which stood adjoining, added another building for keeping their arms, whence they acquired the name of *Templars*.

The new principle of their association, however, immediately drew general attention; so much so, that in 1120 the Hospitallers got their order remodelled by *Pope Calixtus II.* on the same principle. The first regular embodying of the Templars was by *Honorius II.*, the successor of *Calixtus*, who in 1128 confirmed a rule for them which had been drawn up and decreed that same year by the Council of Troyes, on the requisition of *Hugues de Payens* and several of his brethren, who had come to Europe for that purpose with strong recommendations from king *Baldwin*. *Honorius* at the same time, to distinguish them from the Hospitallers, who were arrayed in a black mantle, assigned the brethren of the new order a white mantle for their peculiar dress, which they wore plain till *Eugenius III.*, in 1146, appointed them to wear a red cross on the left breast, in imitation of the white

cross worn by the Hospitallers. This bloody cross was also borne upon their banner, which was formed of cloth striped black and white; whence it was called *Bannerant*, an old French term applied to a horse marked with these colours. This word consequently became the famous war-cry of the Templar chivalry.

The new order speedily rose into consideration. Members of the noblest families in every nation of Christendom eagerly sought to be joined to it; legacies and donations in lands and money were showered upon it by persons of all ranks; and in course of time it acquired ample possessions in nearly every country of Europe. At the head of the order was the Master, or Grand-master (*Magister*, or *Magnus Magister*), who was however not only elected by the Chapter, or general body of the Knights, but very much controlled by that body: the Grand-Master had immediately under him his Seneschal, or lieutenant; and other high officers were the Marshal, the Treasurer, &c. The several countries in Asia and Europe in which the order had possessions were denominated Provinces; and each of them was presided over by a resident chief, called, indifferently, a Grand Prior, Grand Preceptor, or Provincial Master. Under the provincial masters were the Priors, otherwise called Bailiffs, or Masters, who had charge each of one of the districts into which the province was divided; and finally, under the priors were the Preceptors, each of whom presided over a single house of the order (or sometimes over two or three adjoining houses which were considered as one establishment), hence called a Preceptory. The head province was that of Jerusalem; the affairs of the order, in fact, were for the most part directed by the chapter of this province, which was invested by the constitution with all the powers of a general chapter at all times when such a chapter was not assembled. The grand-prior of Jerusalem was ex-officio treasurer of the order; and in this province the grand-master resided so long as the Christians retained any footing in the country: first in the city of Jerusalem, from the origin of the order till 1187, when Jerusalem was taken, and the kingdom founded by Godfrey of Bouillon put an end to, by Saladin; then (after a retirement of four years to Antioch) at Acre, from 1191 till 1217; then at the newly-built fortress of the Pilgrims' Castle, situated on the sea-coast a few miles north of Caesarea, till the fall of Acre, and the final extinction of the Latin power in Palestine, in 1192. On this the Knights took refuge in the town of Limisso (otherwise called Limasol) in Cyprus. The other provinces in the east were Tripolis and Antioch; to which Cyprus, till then included in one of these, was added after that island became the head-quarters of the order. The western provinces were, Portugal, Castile and Leon, Aragon, France and Auvergne, Normandy, Aquitaine or Poitou, Provence, England (in which Scotland and Ireland were included), Germany, Upper and Central Italy, Apulia, and Sicily.

For some time after its institution the order of the Templars consisted exclusively of laymen. But in the year 1162, the famous bull entitled 'Omne Datum Optimum,' issued by Pope Alexander III., among other important privileges which it bestowed upon the order, permitted it to receive as members any spiritual persons who were not bound by previous vows. These spiritual members were called Chaplains. They did not fight, nor take the military vow; but, in lieu of that duty, they not only celebrated mass and other religious offices in the houses of the order, but usually also acted as secretaries to the chapter. They were not allowed to take any share in the government of the society unless specially invited by their superiors; but they were treated with much ceremonious respect, and they were frequently appointed preceptors. Among the other privileges granted by the bull of 1162, was that of having the offices of religion celebrated once in the year in the houses of the order, even in countries lying under an interdict; a permission well calculated to induce persons to join the society, especially after it came, as is asserted, to be interpreted in practice as entirely exempting the Templars from the effects of interdicts. Alexander's bull also allowed the order to have its own burial-grounds: released it from all spiritual obedience, except only to the holy see; freed it from the payment of tithes, and even authorised it to receive them if the bishop gave his consent; and prohibited any one who had once become a Templar from ever leaving the order unless to enter into a stricter one.

At a date a little later the society still farther extended its scheme and its influence, by admitting as members many persons who were not knights or of noble birth, but who were desirous of participating in the advantages of belonging to so powerful a body, on condition of acting as the squires and servants of the knights. These were styled Serving Brethren; and in this class were sometimes found individuals both of great wealth and eminent station, though not of high birth or knightly rank. The serving-brethren however could not be preceptors, or hold any of the higher offices in the order. Latterly, they were divided into two classes—those of arms and those of trades; the former attending the knights to the field as esquires; the latter exercising various handicrafts in the houses or on the lands belonging to the order. The serving-brethren of arms were considered to form by much the more honourable of the two classes, and were treated with much more consideration than the others; but both appear to have been equally entitled to be present at meetings of the chapter, although it may be presumed that none of the serving-brethren either voted or took part in the deliberations. The order also associated to itself persons under the name of Affiliated Members, who took no vows, assumed no peculiar dress, nor became subject to any duties or services; but, continuing to pursue ordinary secular occupations, merely purchased entrance into the ranks of the powerful and highly privileged members of the Temple for the sake of the protection and other advantages, both temporal and spiritual, which even such a mere nominal membership ensured. The affiliated comprehended women as well as men. Finally, there were the *Donati* and the *Oblati*, consisting of children dedicated to the order by their parents or other relations; also of persons of all ranks, both laity and clergy, who, without entering the order, pledged themselves to stand by it and to maintain its rights.

The history of the Knights Templars would embrace the history of the wars of the Christians against the Infidels in the East for all the time they lasted after the establishment of the order. For more than a hundred and seventy years the soldiers of the Temple formed the most renowned portion of the Christian troops, and almost every encounter with the enemy bore testimony to their unequalled prowess and daring. But it may nevertheless be questioned whether the establishment of this and the other religious military orders proved advantageous to the attempt so perseveringly made to wrest the Holy Land from the dominion of the Infidels. The Templars and Hospitallers probably damaged and weakened the cause for which they fought, as much by their rivalry, dissensions, and frequently open contention, as they assisted it by their valour. On some occasions this opposition between the two orders rose so high as not only to desert or withhold assistance from each other in the most extremest dangers, but even to throw one of them for a time into concert with the common enemy. No charges (though such charges have been brought) can be maintained against the bravery of either; but they can be acquitted of treachery in some instances to one another, and the most scandalous abandonment of their duty to the public cause. Then, the immense wealth and power which the Templars in particular speedily acquired altogether changed the original character and spirit of their institution long before it was half a century old. Within thirty or forty years from the origin of the order, two at least of the four vows which the members still continued to take had become a mockery and a profanation; instead of poverty and chastity, they were already distinguished by their pomp and pride, and the general luxury and licentiousness of their lives. But the vast material forces of the association, the extent to which it had projected its ramifications in all directions, and its other elements of strength, might have long withstood the price of corruption thus at work within it, if it had not upon itself an assault from without by which it could not fail to be overpowered.

The destroyer of the Templars was the resolute and vindictive Philip IV., surnamed Le Bel, or The Fair, of France. Philip, who came to the throne in 1285, at the age of seventeen, was the enemy of the church by education, by temper, and by circumstances. He had already proceeded to extremities in a quarrel with Pope Boniface VIII., which was terminated only with the life of that

pontiff. His successor, Benedict XI., is supposed to have been poisoned at the instigation of Philip. Benedict was succeeded by Clement V., who is believed to have purchased his elevation from Philip on condition, among other compliances, of co-operating with him in the destruction of the Templars. This was in 1305. Obnoxious already as the natural allies and defenders of the Holy See, and tempting the attack of the needy and unscrupulous king by their immense possessions, these knights are also said to have further irritated Philip about this time by their suspected share in exciting an insurrection of the Parisians against a debasement of the coinage, a practice which he repeated so often in the course of his reign, that he acquired for himself the name of the money-forgery (*Je faux-monnaieur*).

In 1306 Jacques de Molay, the master of the Temple, was drawn to Europe by a summons from the pope, who professed a desire to consult with him on the expediency of a union of the two orders of the Templars and the Hospitaliers. The following year, while Molay was at Paris, the first distinct accusations against the Templars were made by two individuals lying in prison under sentence of death; Squin de Flexian, who had formerly been a member of the order and prior of Mont-faucon, but had been ejected for heresy and other offences, and a Florentine called Noffo Dei, also, according to one account, a degraded Templar, by general admission a person of the worst character. They made their revelations to Philip himself, and were immediately liberated from prison. Their charges, imputing to the order the systematic practice and encouragement of all sorts of secret immoralities, as well as the strangest confusion of heresy, idolatry, and infidelity, are far too absurd for examination. Very soon after this, on the 12th of September, 1307, royal letters were issued sealed to all the governors of towns and other officers of the crown in authority throughout the kingdom, and transmitted along with orders to them to arm themselves and the persons under their command on that day month, and then to open the letters in the night, and to act as they should find themselves therein directed. The result was that the next day nearly all the Templars in France, De Molay included, were in custody. Their houses and goods were also everywhere seized; the vast stronghold of the Temple at Paris, the chief seat of the order in that kingdom, was entered and taken possession of by Philip himself; and on the following day, the 15th, the university met there, and examined De Molay and some other knights.

An act of accusation was forthwith published; and Philip at the same time wrote to the pope, and also to the king of England, intimating what he had done, and calling upon them to second him. Edward II. expressed himself at first disinclined to believe what was said against the knights; but on soon after receiving letters from Clement, he yielded, and the English Templars were also all seized and thrown into confinement about the end of December. Meanwhile the examinations had been going on in France under the direction of the king's confessor, Imbert, a Dominican priest, and as such the inveterate enemy of the order of the Templars. Confessions, in many cases incredible from their inherent absurdity, were extracted from many of the knights at Paris and elsewhere by the most savage tortures: the confession was in numerous instances speedily followed by a recantation; but a new application of the wheel, or the fire, to which the accused were exposed in some cases till the roasted flesh dropped from the soles of their feet, generally made them repeat their former testimony. This went on for many months. In August, 1309, Clement, whose very person Philip had now contrived to get completely into his power, issued a bull, calling upon all Christian princes and prelates to aid him in examining into the guilt of the order; and about the same time his holiness appointed a commission, consisting of the archbishop of Narbonne and other prelates and dignitaries of the church, to meet at Paris to try the case. This commission however did not commence its sittings till the 7th of August, 1309. A few months later, examinations under judges, deputed or nominated by the pope, commenced in England and other countries. Altogether many hundreds of knights were examined by these commissions during the years 1309, 1310, and 1311; but it was only in France, where torture was made use of, that any admissions were

obtained of the crimes laid to the charge of the order, or any at least that were not manifestly and undeniably unworthy of all regard. Even the Paris commission however did not satisfy the impatience of Philip: on its requisition a great number of knights had stood forward to defend the order, among whom were several of those who had confessed and afterwards retracted. Philip, having forced the pope to nominate Philip de Marigni, bishop of Cambrai, the brother of Enguerrand de Marigni, his prime-minister, to the archbishopric of Sens, which had just become vacant, and then included the diocese of Paris, got the new archbishop to convoke his provincial council in the capital, on Sunday, the 10th of May, 1310; and this body, on the Wednesday morning following, had fifty-four of the defenders of the order, who had formerly made confession, brought out as 'relapsed heretics' to a field behind the abbey of St. Antoine, and there committed to the flames. They all died asserting their innocence and that of the order. This terrible example was speedily imitated in the province of Rheims and elsewhere; and some months after, the archbishop of Sens held himself another council, and burned four more knights. These proceedings put a stop to the attempt at defending the order: the rest of the knights who had undertaken this task now all declared their renunciation of it. Meanwhile a general council had been appointed by Clement to meet at Vienne in October, 1311. It assembled on the 13th of that month, but it was not found so compliant as Philip and the pope had expected; and Clement, having put an end to the session, assembled the cardinals and a few other prelates upon whom he could depend in a secret consistory, and abolished the order by his own authority, on the 22nd of March, 1312. When the council reassembled, pursuant to the adjournment, on the 3rd of April, Philip was seated on Clement's right hand, accompanied by his brother and his sons, and attended by an imposing military force; and his holiness read the bull of abolition, the council listening in silence. It was formally published on the 2nd of May following. On the 18th of March, 1314, Molay, the grand-master, and Guy, commander or grand-prior of Normandy, who had all this while remained in prison at Paris, were brought before the archbishop of Sens, condemned to death, and burned on one of the small islands in the Seine, about the spot where the statue of Henri IV. is now erected on the Pont Neuf.

After all, Clement and Philip, the former of whom died suddenly about a month, and the latter, of a fall from his horse, within a year after the martyrdom of De Molay, were able to secure to themselves only a small portion of the plunder which they had probably hoped for. The king of France seized and kept, or divided with his confederate, the moveable property of the Templars in that country; but there, and also in England, and throughout the rest of Europe, with the exception of Spain and Portugal, it was found necessary to transfer their landed possessions to the Hospitaliers, or Knights of St. John (at this time commonly known, from the place where they had fixed their head residence, as the Knights of Rhodes). In Spain the lands of the Templars were bestowed upon the Knights of Our Lady of Montesa, a new order, founded in 1317; and in Portugal the society merely took the new name of the Order of Christ, which still subsists. It is affirmed that even in France the order of the Templars has survived to our own day; and it is certain that a society calling itself by that name exists in Paris, which professes to be in possession of the original register and records of the ancient Templars, and to have been governed by an unbroken succession of grand-masters, many of them of illustrious rank, ever since the time of Jacques de Molay. It pretends therefore to be the supreme chapter of the order. In England, and we believe also in Germany, the Freemasons are in the habit of holding themselves up as a sort of representatives of the ancient Templars.

It is asserted by Matthew Paris, that about the year 1244 the manors or estates in possession of the Templars throughout Christendom already amounted to 5000; and it has been calculated that the entire revenues of the order when it was dissolved did not fall short of six millions sterling, though it seems impossible that this should not be a great exaggeration. Their possessions in England particularly were even at a comparatively early period of great extent and value, as may be seen from an 'inquisitio,' or account

of their lands, taken by royal authority in the year 1185, which Dugdale has printed in his 'Monasticon' (vol. vi., pt. ii., pp. 815, &c., edition of 1830). They are supposed to have been settled in the Old Temple, at London, which stood on the south side of Holborn, near the present Southampton Buildings, by the beginning of the reign of Stephen: they removed to their new house at the western extremity of Fleet Street, the site of which still retains the name of the Temple, in 1185. This was the chief seat of the order in England.

The question of the guilt or innocence of the Templars has been much discussed in modern times; and although it may be said to be now almost universally admitted that the particular charges upon which they were condemned were for the most part entirely unfounded, some attempts have been made to show the probability that the order nevertheless was held together by certain secret principles or doctrines which made its existence dangerous to society and called for its suppression. Von Hammer, for instance, in his 'Geschichte der Assassinen' (or 'History of the Assassins'), of which there is an English translation by Dr. G. C. Wood, has endeavoured to establish a similarity and connection between the order of the Templars and that famous association; and in a disquisition, printed in the sixth volume of his 'Mines de l'Orient,' the same writer has attempted to convict the order of a participation in the apostasy, idolatry, and impiety of the Gnostics and Ophianites. Von Hammer's Essay has been answered by M. Raynouard, in a long note printed in the fifth volume of Michaud's 'Histoire des Croisades,' p. 572, &c.; and also in two articles in the 'Journal des Savans' for March and April, 1819; and in two others, published in the 'Bibliothèque Universelle,' tom. x., p. 327, and tom. x., p. 3. The documents relating to the condemnation of the Templars were first published in a work entitled 'Traitez concernant la Condemnation des Templiers,' par M. Du Puy, 8vo., Paris, 1654; reprinted, with additions, under the title of 'Histoire de la Condemnation des Templiers,' &c., par Pierre Du Puy, 2 vols. 8vo., Bruxelles, 1713; and under that of 'Histoire de l'Ordre Militaire des Templiers, avec les Pièces Justificatives,' 4to., Bruxelles, 1751. Other works on the subject are—'Nicolai Gürtleri Historia Templariorum,' 8vo., Amstel., 1691, and, with large additions, 1703; 'Christiani Thomasi Dissertatio de Templariorum Equitum Ordine Sublato,' 4to., Halae, 1705; Raynouard, 'Monumens Historiques relatifs à la Condemnation des Templiers,' 8vo., Paris, 1813; Voltaire, 'Essai sur les Mœurs et l'Esprit des Nations,' chap. 66; Munter, 'Statutenbuch des Ordens der Tempelherren,' Wilke, 'Geschichte des Tempelherrenordens'; 'Secret Societies of the Middle Ages' (in the 'Library of Entertaining Knowledge'), 12mo., Lond., 1837; and 'The History of the Knights Templars, the Temple Church, and the Temple,' by C. G. Addison, Esq., 4to., Lond., 1842. See also Tanner's 'Notitia Monastica,' fol., Lond., 1744, pp. 307-310, for numerous references to printed books and MSS. on the subject of the English Templars.

TEMPLE (the Latin 'Templum'). What is known of the architecture of the nations of antiquity is derived chiefly from their temples; for of all their public edifices those devoted to religion are the most numerous, if we except perhaps those of the Romans, the remains of whose thermæ, aqueducts, theatres, amphitheatres, and other monuments of that class, are as common as their temples, and have been as well preserved. Nearly all of what may, for distinction's sake, be termed the *columnar architecture of the antients*—Egyptians, Greeks, and Romans—is seen in their temples. In those of the Egyptians, it may be said to display itself exclusively, and likewise much more extensively than in the temples of the other two, with this further difference as regards the general design and character, viz. that in the Egyptian edifices the columns are placed *internally*, that is, so as to form colonnades along the sides of an enclosed fore-court, and the portal or frontispiece of the temple itself. Of this disposition of the entire plan, with a walled-in cortile or cloister, an example is shown in *EGYPTIAN ARCHITECTURE* (p. 316), where other particulars relative to Egyptian temples and some of the characteristic differences between them and those of the Greeks are mentioned. Instead of being composed of a variety of parts grouped and combined together, these latter consist only of a simple parallelogram, a *cella*, or body of the temple itself, either *in antis*, or else *perip-*

teral, that is, entirely surrounded with an external colonnade; for to these two distinctions may be reduced those subordinate ones for which separate technical terms have been invented, yet they do not at all affect the general shape and outline, which still remains a simple broken parallelogram, either with or without colonnades along its sides.

An explanation of those terms having been given in *CIVIL ARCHITECTURE*, page 221, col. 1, we refer to it there said for the respective definitions, and in repeating them, now introduce here what will render them more intelligible, and be of assistance in the present article, viz. examples of the different forms of temples regards *columniation*, or the arrangement of the columns.

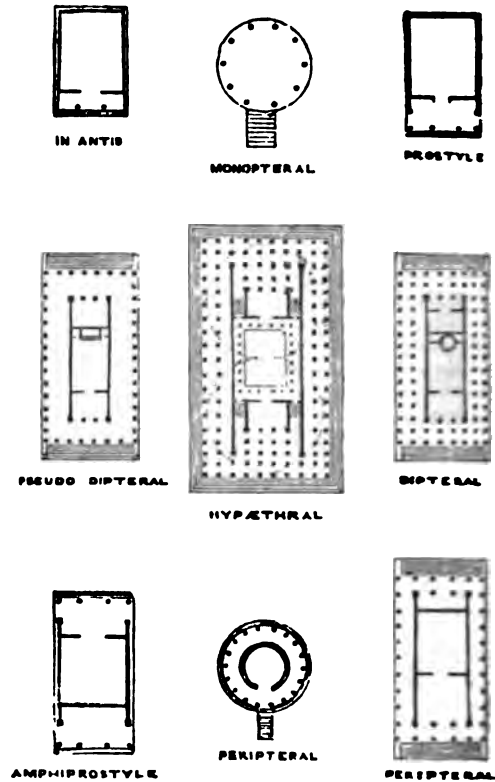

Though so exceedingly small as to show little of the position of the columns, without any regard to correctness in other respects, these slight diagrams will both fully render evident many circumstances that call for explanation, and also to exemplify the various denominations of temples and porticos according to the number of columns in front. The one 'in antis' is a *distyle in antis*, there being only two columns between the antæ, or three intercolumns, as in the two last examples (prostyle and amphiprostyle); whereas there are four columns between the antæ, it is termed a *tetrastyle in antis*, and have as many intercolumns as there are columns; and the hypæthral a *decastyle*. This may be taken as an example (though an imperfect one) of a *prostyle*, for it will be seen that if the portico were a *prostyle*, it would project forward two intercolumns beyond the body of the temple. In this figure the portico may also be termed *polystyle*, on account of the great number of columns in successive rows between the antæ, closing that part of the plan (pronaos), which may be described as a dipteral or double *tetrastyle in antis*, a distyle in antis behind it, and a *diprostyle decastyle* in front of it.*

Still there is no variety whatever as to external form for individual character as to outline or even the general

* Though such is the case in the plan given above as an example of hypæthral, it must not therefore be supposed either that all decastyle temples were hypæthral, or all hypæthral ones decastyle; neither, again, that all decastyle ones had deep polystyle pronaos filled with files of columns extending to the lines of those in front.

thing of combination or of design, as the last ally understood; but the difference of effect together upon the actual dimensions of the upon material and execution, upon circum-etail and finish, and on the degree and partic-decoration in regard to sculpture and poly-bellishment. The only instance of combina-ouping is that afforded by the Erechtheion, or e on the Acropolis at Athens, which has two ticos, viz. an Ionic hexastyle monoprostyle at and a tetrastyle diprostyle of the same order side, and upon a lower level; besides which aller attached or projecting structure at the ugle, forming a tetrastyle diprostyle arrange-ryatic figures, raised upon a screen-wall or he combination is here not very harmonious, ard has been paid to symmetry; for which very all the more striking, as forming a decided con-unvaried and even monotonous uniformity he temple-architecture of the Greeks. It is nly Grecian structure that can be said to be as gushed by picturesqueness as by elegance of l detail, and it is therefore to be regretted that een studied by modern architects, with especial uch quality, instead of their attention being ively given to the details and proportions of al parts. This edifice moreover affords almost tance in the Grecian style of distinct porticos : projecting from a building [PORTICO], other ing either in *antis*, so as to be recessed within alls forming the sides of the edifice; or are l or ends of the colonnades continued through-ole exterior: consequently in neither case does o show itself as an actual prostyle. The only n examples of Greek prostyles are the two : temples at Athens, that on the banks of called the temple of Panops; and that dedi-ike Apteros, or Wingless Victory. Both these rostyle, and not *in antis*, consequently had a portico at each end; and in both the porticos

Of the former nothing now remains, en known from Stuart's delineations, and the -of plain and bold but elegant character—has ed as the type—not to say stereotype—of r modern Grecian Ionic. Though amphipro-orticos were not exactly similar in plan; for e was a mere monoprostyle, that forming the id was also deeply recessed within the main e manner of a portico in *antis* without he other temple, the ruins of which have been ithin only a very few years, was a very small ere votive chapel, close by the west front of ea of the Acropolis, with its hinder portico ith wing of that edifice, yet turned obliquely uch want of parallelism is utterly at variance dern notions of architectural symmetry and t although they carried regularity almost to s, the Greeks seem to have paid no regard to it d osing buildings relatively to each other, for r and apparently intentional want of paral-reen the Parthenon and Erechtheion on the self; nor are either of them in a line with the r equidistant from such line or axis. [PAR-
lan.]

tion to uniformity of arrangement, where uings are brought together on one general a striking difference of taste in that respect e Egyptians and the Greeks. The temples of ns consist of various architectural parts sub-er principal structure, but combining with that ch other to form a whole; which scheme was further extended by an architectural avenue of front of the buildings. The Greeks, on the ertainly did not attempt to imitate or rival ans in the extent and complex arrangement les, though there can be little doubt that iginally indebted to them for much of their al knowledge. Their temples were almost in-ngle structures, not only detached from but unconnected with adjacent ones, instead of h them a symmetrically arranged assemblage It seems however to have been in some degree e to erect several temples in the immediate

neighbourhood of each other, and in a particular district of a city, as was the case in the Forum and Capitol at Rome, where temple succeeded to temple almost uninterruptedly; and the ruins of Pæstum, Agrigentum, Selinus, and other places show a somewhat similar concentration of sacred edifices about the same spot. Temples were frequently surrounded by a sacred grove or plantation of trees, *Temenos*, or else placed within an enclosure, *Peribolus*, formed either by mere walls or by colonnades, but there are scarcely any examples of the kind now remaining; and they are chiefly Roman works, viz. the temples at Baalbec and Palmyra. Similarly enclosed and standing in the centre of a peribolus or piazza (therefore very different in plan from an Egyptian temple preceded by a fore-court), were the temples of Jupiter and Juno, Venus and Roma, at Rome [ROMAN ARCHITECTURE, p. 74]; that of Jupiter Olympius at Athens, a work completed in the time of Hadrian; and also, among Græco-Asiatic examples, the temples of Minerva Polias at Priene, and Apollo Didymæus at Miletus.

Similar as it is upon the whole to that of the Greeks, the temple-architecture of the Romans differs from it in many other circumstances besides those of style; which latter was, with very few exceptions, Corinthian—the national style of the Romans, as the Doric was of Greece and its Italian colonies. One leading distinction in regard to general arrangement is, that Roman plans were hardly ever *in antis*, and not often *peripteral*, but generally prostyle, with the portico projecting out from the *cella*, or body of the structure, three or more intercolumns, so as to be *triprostyle*, &c. [PORTICO.] Such façade was generally further distinguished by having a flight of steps enclosed within pedestals at its ends, which were continued as a podium or moulded basement along the sides of the edifice; whereas the Greeks raised the temples only three steps or so above the ground, and carried those gradini quite round the structure, wherefore each elevation or side of their *peripteral* temples was uniform in design, having no other variety than that produced by greater extent and number of columns in one direction, and by the pediments at the extremities. The Romans certainly evinced greater taste for both contrast and picturesque combination than the Greeks, although decidedly inferior to them in beauty of detail and finish of execution; except perhaps in one or two particular examples of that order which, although called Corinthian, is so peculiarly their own, that Roman would be the more correct name for it. In order to give greater dignity to the whole temple or to the principal structure in an architectural group, they elevated it upon not a mere basement or substructure with an ascent in front or at both ends, but upon a spreading-out platform, constituting a terrace on every side. They appear to have occasionally formed a succession of terraces of flights of steps, leading up to if not continued on every side of the building. The celebrated Temple of Fortune at Præneste, usually supposed to have been originally founded by Sulla, was a very remarkable example of the kind. Very little now remains of it, except the terraces themselves; neither have we any account of the architecture, but besides the principal edifice or temple there were several subordinate ones, on the different platforms. 'I know of no other example,' says Woods, in his 'Letters of an Architect,' 'either of antient or modern times, where so great a number of edifices, and occupying so great an extent, were combined into one regular and symmetrical plan; and our admiration is still increased when we consider that it was necessary not only to erect the building, but absolutely to build a place for it to stand on.'

Circular plans for temples are peculiar to the Romans, and occasion a diversity of character not to be met with in those of the Greeks. Besides the two simplest forms, the monopteral and peripteral, which have been shown above, there were other varieties and combinations. For a notice of some of them we refer to ROMAN ARCHITECTURE (p. 73).

Instead of entering into formal descriptions of particular temples, we subjoin a synopsis with accompanying remarks. Some of the measurements and other particulars stated in it may not exactly accord with other accounts of the respective structures; for so great is frequently the discrepancy between different authorities, whether writers or delineators and restorers, that it is impossible to obtain complete accuracy.

TABLE OF SOME OF THE PRINCIPAL GREEK AND ROMAN TEMPLES.

Athens	Theseion	Doric	Hexastyle, peripteral, with 12 intercolumns on sides, 4
"	Parthenon	Doric	Octastyle, peripteral, hypæthral, 100×228 feet; Ictin crates, architects. [PARTHENON.]
"	Propylæa	Doric	Hexastyle on both fronts, with wings of a smaller c angles to west front. [PARTHENON—Plan.] Mne tect, 437-432 B.C.
"	Erechtheion	Ionic	Hexastyle, prostyle at east end, with a tetrastyle, (
"	Panops	Ionic	north side. Tetrastyle, amphiprostyle. A well-known example longer extant, having been destroyed by the Turks time.
"	Nike Apteros	Ionic	Tetrastyle, amphiprostyle. Recently explored, and six
"	Jupiter Olym- pius	Corinthian	Decastyle, peripteral, columns 60 feet high, 96×259 fe by a peribolus. A Roman work originally begun in Pisistratus, continued by Antiochus Epiphanes, an by Hadrian.
Eleusis	Ceres	Doric	A square building of about 180 feet on each side, wit style colonnade forming the west front. This tem Ictinus; colonnade added by Philo, architect, about
"	Propylæum	Doric	Hexastyle on both fronts, with inner Ionic order a 50×60 feet. A second and smaller propylæa peribolus, distyle in antis. See 'Unedited Antiquiti None of these buildings now remain.
Thoricus	Doric	Eptastyle, peripteral, or with seven columns at each e teen on each side. No cella remaining; but supp been a double temple, with a passage through the the sides, dividing the cella into two.
Rhamnus	Nemesis	Doric	Hexastyle, peripteral, 11 intercolumns on sides, 33×7
"	Themis, or lesser Temp. of Nemesis	Doric	Distyle in antis.
Ægina	Jupiter Pan- hellenius	Doric	Hexastyle, peripteral, hypæthral, 41×90 feet. Thi celebrated for its polychromy and sculpture (the Æ bles).
Olympia	Jupiter Olym- pius	Doric	Hexastyle, peripteral, hypæthral, 95×230 feet. Con 435 B.C. Libon, architect.
Basææ	Apollo Epi- curius	Doric	Hexastyle, peripteral, hypæthral, 47×125 feet. Date a Ictinus, architect. In interior, Ionic columns.
Tegea	Athene Alea	Ionic	Peripteral, hypæthral. Doric internally; with uppe order. Scopas, architect.
Nemea	Jupiter	Doric	Hexastyle, peripteral.

MAGNA-GRÆCIA AND SICILY.

Pæstum	Neptune	Doric	Hexastyle, peripteral, hypæthral, 79×195 feet.
Agrigentum	Ceres	Doric	Hexastyle, peripteral, 47×107 feet. [PÆSTAN ARCHITECT
"	Jupiter Olym- pius	Doric	Apteral, or with engaged columns, eptastyle, 182× (For description, see AGRIGENTUM.) Wilkins, in u of it, makes this temple hexastyle amphiprostyle.
"	Juno Lucina	Doric	Hexastyle, peripteral, 57×124 feet.
"	Concord	Doric	Hexastyle peripteral, 31×93 feet. Deep pronæos and mus.
Segeste	"	Doric	Hexastyle, peripteral, 76×190 feet. All the external (
Selinus	Great Temple	Doric	fluted) standing, but no remains of cella. Octastyle, dipteral, 160×330 feet. There are r other temples, two of which appear to have u peripteral.
Syracuse	Minerva	Doric	Hexastyle, 13 intercolumns on sides: now converted in with a modern Italian Corinthian façade.

ASIATIC GREEK.

Ephesus	Diana	Ionic	Decastyle, dipteral, hypæthral; columns 60 feet high. largest Grecian temples, being 220×425 feet. Cto Metagenes, architects. Date about 340 B.C.
Miletus	Apollo Didy- mæus	Ionic	Decastyle, dipteral, hypæthral, 164×303 feet. Color meters. Pæonius, architect. A peribolus.
Magnesia	Diana	Ionic	Octastyle, pseudo-dipteral, 106×198 feet. Hermogene
Priene	Minerva Polias	Ionic	Hexastyle, peripteral, 64×116 feet. Pytheas, architect B.C. The order the best example of Asiatic Ionic. had a peribolus and propylæum; the latter tetrastyle rows of square pillars within.

ASIATIC GREEK.

Bacchus	Ionic	Hexastyle, peripteral. Hermogenes, architect; about the time of Alexander the Great.
Juno	Ionic	Decastyle, dipteral; 189 × 346 feet.

ROMAN.

Concord	Ionic	Hexastyle. Appears to have been a diprostyle, but nothing of the cella remains.
Fortuna Virilis	Ionic	Tetrastyle, diprostyle, cella pseudo-peripteral; about 24 × 44 feet.
Jupiter and Juno	Corinthian	Two separate temples, alongside each other, in centre of a colonnaded peribolus. Similar in dimensions, but the one octastyle, peripteral; the other octastyle, diprostyle. Erected by Metellus Macedonicus, about 140 B.C. No remains; but the authority is the antient plan of Rome in the capitol.
Jupiter Stator	Corinthian	Supposed to have been octastyle, peripteral. The celebrated 'Three Columns,' in the Forum, are all that now remain of this very fine example.
Jupiter Tonans	Corinthian	Octastyle, dipteral; 92 × 115 feet. Columns 47 feet high.
Mars Ultor	Corinthian	Of this temple, sometimes called that of Nerva, only three columns remaining; but it is said to have been octastyle, peripteral.
Venus and Roma	Corinthian	Decastyle, pseudo-peripteral, enclosed within a peribolus formed by double colonnades of a lesser order. [ROMAN ARCHITECTURE, p. 74.]
Antoninus and Faustina	Corinthian	Hexastyle, triprostyle; 33 × 55 feet.
Pantheon	Corinthian	An octastyle, triprostyle, attached to a rotunda. [PANTHEON.]
Vesta	Corinthian	A circular peripteral of 20 columns. [For further description, and an account of other temples at Rome, see ROME, p. 93, &c.]
Vesta, or the Sibyl	Corinthian	A circular peripteral, of 18 columns around cella. The order a very peculiar and fine example. [ROMAN ARCHITECTURE.]
Fortuna	Corinthian	No remains of this celebrated temple itself; but merely of the series of terraces and flights of steps on which it was elevated.
Jupiter	Corinthian	Hexastyle, tetraprostyle; about 50 × 110 feet.
Maison Carrée, or Temple of Caius and Lucius	Corinthian	Hexastyle, triprostyle; order continued along the cella, making it a pseudo-peripteral; 38 × 77 feet. [NISMES.]
Great Temple	Corinthian	Decastyle, peripteral; 160 × 290 feet. [BAALBEC.]
Lesser Temple	Corinthian	Octastyle, peripteral; 118 × 225 feet. [BAALBEC.]
Helios, or the Sun	Corinthian	Octastyle, peripteral; 95 × 180 feet. Enclosed within a peribolus about 740 feet square, formed by an outer wall and two ranges of Corinthian columns, making a double colonnade. [PALMYRA.]

ve table might be rendered more copious and ended; and it might also have been differently a several ways, each of which would have had to recommend it, according to the purpose for may happen to be consulted. Chronological instance, if the respective dates could be ascer- tolerable accuracy, may be considered prefer- persons; or the buildings might have been according to the number of columns in front, ng in antis, prostyle, peripteral, &c.; or else to their relative size and dimensions. In fact a le is required for each mode of classification ment; but as that could not be done, we have t we consider the most satisfactory upon the e may however render it in some measure more y here pointing out that the *decastyle* examples in it are the Temple of Jupiter, Athens; Diana, Apollo, Miletus; Juno, Samos; Venus and me; and the great temple at BAALBEC. As mensions and relative size, the following are the etures, viz. :—

	Width of Front.	Length.
us	220 feet	425 feet.
um, Great Temple	182 "	369 "
s, Great Temple	160 "	330 "
us and Roma	116 "	350 "
ens, Parthenon	100 "	228 "
ple of Jupiter	96 "	259 "

of affording a standard of comparison, we add the of St. Paul's, London, and La Madeleine, at Paris, 1er, 180 by 500; the other 138 by 328 feet. SOLOMON'S. For 447 years after the He- entered the land of Canaan they continued to C., No. 1511.

worship at the tabernacle which had been framed for their use in the Wilderness. The incongruity of a settled people having only a tent for the celebration of their splendid ritual service first occurred to the mind of David. It appeared unseemly to him that the Ark of God should still 'dwell between curtains,' while he abode himself in 'a house of cedar,' and he therefore proposed to build a temple in which the worship of God might be more becomingly conducted (1 Chron., xvii. 1). The prophet Nathan was however commissioned to inform him that having been engaged in constant warfare, and shed much human blood, he could not be allowed to execute the design he had formed, which was to be reserved for the peaceful reign of his son Solomon. This undertaking was however a principal subject of David's thought and care during the remainder of his reign; and to it he appropriated a large proportion of the immense treasure which his many victories produced. He may be said to have provided all, or nearly all, the materials before his death; consisting of large but variously estimated quantities of gold and silver, brass and iron, stone and timber. He also secured the services of skilful mechanics and artificers for every branch of the work, and furnished the design, plan, and site of the building; so that more of the credit of this work seems due to David than to Solomon (1 Chron., xxi.; xxii.; xxviii. 11-19).

The foundation of the Temple was laid in B.C. 1012, being the fourth year of Solomon's reign; and in seven years and a half it was completed. During this time 183,600 persons were employed on the work. Of Jews there were 30,000 serving by rotation of 10,000 monthly; and of Canaanites there were 153,600, of whom 70,000 were labourers, 80,000 hewers of wood and stone, and

2,000 workmen of the others. To save the labour of carriage, the parts were all prepared for use at a distance from the site of the building, and when they were brought together, the structure was reared without the sound of hammers, axes, or tools of iron (1 Kings, vi. 7).

To furnish a distinct idea of Solomon's temple from the materials which have reached us, even if we take in the ideal temple of Ezekiel, which is conceived to be framed on the same model, would require such a combination of real architectural knowledge with deep Biblical learning as have perhaps never been combined in any one person. Hence all the descriptions which have been deduced from such materials differ greatly from one another. These only claim our confidence in the points in which all, or nearly all, of them agree; for such points of agreement appear to embody all the real information which has hitherto been collected from the text. There are however materials of comparison and illustration, which, taken along with the text, might furnish some clearer notions than have yet been realized in a matter which circumstances have invested with considerable interest. 1. It would be considered that the temple was on the same essential plan as the tabernacle, differing chiefly in materials, extent, and in additions to the enclosure. 2. Reference would be made to other antient Oriental temples, of which we know more, and especially to those of Egypt, some of which are in sufficient preservation to allow their relative parts and proportions to be clearly understood. And in this regard it will be seen that those plans of the temple which appear most in agreement with the text offer the most striking analogies to Egyptian temples (see the chapter 'An Egyptian Temple,' vol. i., pp. 69-127, of 'Egyptian Antiquities,' in *Library of Entertaining Knowledge*). And although it is probable that, from the friendly relations which Solomon had already established with Egypt, Egyptian as well as Phœnician artists supplied the artistic labour for the temple in which the Hebrews were themselves deficient, such analogies need not be necessarily traced to imitation, but to similar conditions and circumstances producing similar results. The popular notion of a temple, as a vast pile of building in which, as in our cathedrals, large multitudes might assemble for worship under cover, does not in these cases apply. A temple was a large area, enclosed by a wall, and laid out in courts, where the crowds worshipped and where sacrifices were offered; and in colonnades around these courts, where the worshippers might walk or find shelter from the sun or rain. Apartments for the numerous officiating priests, and chambers for stores and treasures, also increased the display of building within and around the enclosing walls. The sacred edifice itself, being only intended to contain the sacred symbols, and being entered only by the priests for particular services, was never large; but what it wanted in size was made up in cost of materials and splendour of workmanship. These ideas apply equally to the temples of Jerusalem and of Egypt; and in both the sacred building was divided into three parts, which were in Solomon's temple called the Porch, the Holy Place, and the Most Holy Place, answering in some degree to the porch, the nave, and the chancel of Christian churches, the parts of which were indeed arranged originally with an intended reference to those of the Jewish temple. Even the pillars called Jachin and Boaz, which Solomon set up at the porch, find analogies in the obelisks which the Egyptians placed in a corresponding situation. 3. Another source of illustration is offered in the more ample description which is given by Josephus of Herod's temple; for although that appears to have been architecturally a greater and more imposing fabric than that of Solomon, there is no doubt that it had the same parts, and that they were similarly proportioned to each other. 4. The antient Christian churches also offer some analogies of arrangement, which claim to be considered when viewed as intended retrospects of the Jewish temple. Among the plans of antient churches given in Coleman *Antiq. of the Christian Church*, Andover, U. S., 1841, that of the church at Tyre affords some remarkable illustrations.

The site of Solomon's Temple was the summit of Mount Moriah, one of the eminences on which Jerusalem stood. This eminence rose to no great height within the city, but was high and steep above the valley of the Kedron, which it overlooked. It faced the Mount of Olives. The Mosque of Omar now occupies the same site, and the imposing figure

which it makes in every view of Jerusalem, and in a more advantageous situation could not have been surpassed. The top of the hill was levelled, and the sides banked up to afford a sufficient area. This area was divided into three courts (but in Herod's temple three, courts, in the outermost of which stood the people. It was separated by a low wall, or, as some think, by a latticed fence or trellis, from the inner court, called the Court of the Priests, in which was the great altar of burnt offerings, and where the priests and Levites officiated in view of the people, and in front of the holy house, or proper temple. The proper temple, as previously indicated, was an oblong building. It was 70 cubits in length, 20 in width, and 30 in height: this last was however only the elevation of the house or holy place; for the innermost sanctuary was but 20 cubits high (1 Kings, vi. 20); and although the porch is said, in 1 Chron. iii. 4, to have been 120 cubits high, or four times the height of the main building, the numbers in that text are now generally admitted to be corrupted: 20 cubits, which we find in the antient versions, is probably the true number; being the same height as the sanctuary. The porch covered the breadth of the building 20 cubits, and was 10 cubits deep; the holy place was 40 cubits long by 20 wide; and the sanctuary was a perfect square of 20 cubits. The building fronted the east. Along the north and south sides, and the west end of the structure, were attached certain buildings called 'side chambers,' in three stories, each five cubits high. This made 15 cubits of total elevation, which was not more than half the height of the main building; in whose walls, above, there was therefore room for the splayed windows which gave light to the temple.

The sacred utensils were of the same description and occupied the same relative position as in the tabernacle; but some of them were larger, as the altar, candlestick, &c., in proportion to the more extensive establishment to which they belonged. The principal of the new utensils was the great brazen laver for ablutions, which rested on the backs of twelve oxen of the same metal.

The inner sanctuary was separated from the holy place by a rich curtain or veil. The whole of the interior was wainscoted with cedar, carved with figures of cherubim, palm-trees, and flowers, and then overlaid with the finest gold. The doors were also covered with gold; all the utensils in the house were of that metal; and even the floor appears to have been overlaid with it (1 Kings, vi. 30). It is this lavish expenditure of precious metal upon the building, and the elaborate workmanship bestowed upon it, which, rather than its architectural effect, accounts for the reports of its surpassing magnificence, and for the immense wealth consumed in its erection. The popular impression concerning it, however, being based rather upon the exaggerated statements of Josephus than upon the more sober accounts in Scripture, does, no doubt, greatly exceed the truth. More might be said of its richness than of its grandeur. Its wealth is indeed attested by the spoiliations of successive kings and conquerors; and it may be well to remember that this was not, as in other nations, one of many temples, but was the sole temple of the whole nation, and in the production of which the whole nation could therefore concentrate its resources.

The Temple of Solomon retained its pristine splendour only for forty years, when its treasures were plundered by Shishak, king of Egypt. After undergoing various other profanations and pillages, it was finally destroyed by the Chaldeans under Nebuchadnezzar, B.C. 586, having stood 417 years. After the Captivity, the temple was rebuilt, on the same plan, and on a more extensive scale, but with greatly diminished splendour. This temple stood until some years before the birth of Christ, when Herod the Great, to propitiate his subjects, whom most of the measures of his reign had tended to exasperate, undertook to rebuild it on a larger scale and with greater magnificence. In nine years, during which 80,000 workmen were constantly employed, he accomplished his original design; and produced a fabric, which, while the same in its essential characteristics, much surpassed the Temple of Solomon in extent and architecture, although the precious metal may have been less lavishly displayed in the interior decorations. Many years after, the Jews kept workmen employed in embellishing the pile. In A.D. 61, nothing remained to be done, and the temple

8,000 workmen excited some alarm for the part they took in the troubles which had already commenced, and which, a few years after, brought upon the armies of Rome under Vespasian and Titus, ruined the temple and city of Jerusalem in one ruin, A.D. 70.

LE, SIR WILLIAM, an eminent statesman, diplomatist, and writer, was born at Blackfriars, in London, in the year 1628, and was the eldest son of Sir John Temple, who was Master of the Rolls in Ireland, and author of a History of the Irish Rebellion which began in 1641. He was educated first by his uncle, Dr. Henry Temple, a learned divine and zealous royalist, and was afterwards, on his uncle being turned out of his living by the parliament, sent to a school at Bishop-Stortford, and thence, at the age of seventeen, to Emmanuel College, Cambridge, where he was taught by the celebrated Cudworth was his tutor. He is said to have been a very gay and dissipated youth, and, after having spent about two years, he went away without a degree; then went abroad, and having spent two years in France, and visited Holland, Flanders, and Germany, he returned to England, skilled in the French and Spanish languages. As he was about to start on his travels, he met at the Isle of Wight, the young lady to whom, after many trials and difficulties, arising out of want of fortune and opposition of the friends of both, he was eventually married. She was the daughter of Sir Peter Osborne, a kinsman of Charles I., and a great sufferer by his misfortunes. Her letters of hers which are preserved show her to have been a very superior woman: she remained faithful to her husband through a long engagement, amid many and various persecutions, and at last, after the death of her husband, after six years' waiting, they were married in 1653. It appears that, among many offers which she refused, Temple was one from Henry Cromwell.

He was trained to no profession, though his father had intended independently of his appointment as Master of the Rolls in Ireland, and when deprived of this for some time during the civil wars, was exceedingly hampered in his business. Sir John Temple was restored to this appointment in 1653, the year before his son's marriage; and after his marriage, resided with him in Ireland. In 1657, at his father's roof in Dublin, or in a country-seat in the parish of Carlow, Temple passed five years, which were devoted between literary pursuits and county business, which were marked by the birth and death of his father. In 1660 Temple was chosen, without solicitation, to be the previous knowledge, member of the Irish House of Commons of that year for the county of Carlow.

At the Restoration he was re-elected for the same county in the first regular parliament that was called: he was chosen for his colleague, and a younger brother was chosen for the city of Carlow. He appears to have been a very able and useful member of parliament. In July, 1661, as one of the commissioners sent to wait on the king to urge several measures affecting the interests of the county, on the prorogation of the parliament in 1663, he went to reside in England. He carried an introduction to the duke of Ormond to Lord Arlington, secretary of state, who conceived a great fondness for him, and in 1664 he was appointed, in 1665, on a secret mission to the province of Münster. The object of this mission was to prevent an invasion by the bishop of Münster of the provinces, towards which England, then at war with France, had guaranteed a subsidy; and though the king had made the first advances to England, and in his engagement, and, in fear of France, to negotiate a separate treaty with the Dutch, Temple was not allowed to blame for this failure of the object of his mission. His employer was so satisfied with the success which he had acquitted himself in his first diplomatic employment, that he was appointed in the same year Lord Arlington's influence, resident at the court of Spain at Brussels.

His residence at Brussels for two years presents no peculiar interest. It was his business at first to maintain the neutrality of Spain in the Dutch war, and to cultivate a good understanding between Spain and the United Provinces, with a view to a treaty which was then being negotiated at Madrid, but which never came to pass, and which was intended to bring about peace with the United Provinces and France. This last object was accom-

plished in July, 1667, by the treaty of Breda, which however Temple had no part in negotiating, and the mode of bringing about which he had not altogether approved of. In 1666 Temple's services had been rewarded, without any solicitation on his part, by a baronetcy.

In the close of the year 1667 Temple received orders from Arlington to repair to the Hague, to negotiate a treaty against France, and for the protection of the Spanish Netherlands from that power; and by his energy, judgment, and address the celebrated Triple Alliance was concluded on the 23rd of January, 1668. England, Holland, and Sweden bound themselves by this alliance to bring about peace between France and Spain, and to prevent France from entering the Low Countries. Temple had thus achieved an object which he had had at heart, even before the treaty of Breda, so favourable to French views, a blow to the ambition of Louis XIV. The successful conclusion of this treaty established Temple's diplomatic fame, and was of the first importance to England and Europe.

Temple was next appointed ambassador at Aix, where the negotiations for peace between France and Spain, in pursuance of the Triple Alliance, were to be carried on. On the conclusion of the peace of Aix, he was appointed ambassador at the Hague. Here he continued, carrying out the policy of the Triple Alliance, till September, 1670, when a complete change having been silently worked in the councils of Charles II., and the celebrated secret treaty having been made with France, Temple was ordered home, and found himself on his arrival in England no longer in the confidence of Arlington, and in the summer of 1671 was dismissed from his post. There was a rumour that Temple's dismissal had been made a condition by the French government. (Temple's *Works*, ii., 179.) He now retired to Sheen, and meditated never again returning to public life, saying that 'he had been long enough in courts and public business to know a great deal of the world and of himself, and to find that they were not made for one another.'

During this retirement Temple devoted himself to gardening, the improvement of his house at Sheen, and literature, and published several of the works on which his reputation as a writer rests; among them, the 'Observations upon the United Provinces,' published in 1672. Temple was summoned however from his literary retirement in the summer of 1674, to conclude the second Dutch war, and he obeyed the summons. He was on the point of starting for the Hague, as envoy and plenipotentiary for this purpose, when the Spanish ambassador in London received full power to negotiate there, and in three days the treaty of Westminster was concluded. Temple was now offered the embassy to Spain, which, at his father's wish, he refused. He was very soon after appointed again to the Hague, as ambassador extraordinary, and the next year ambassador to the congress at Nimeguen. The peace of Nimeguen, concluded in the beginning of 1679, ill carried out the views which Temple assiduously laboured to establish, and he was glad to avail himself of a point of form for the purpose of withholding his signature to the treaty.

Temple now returned to England to receive an offer of the post of secretary of state, which he refused. He was much consulted by the king, who had just lost the services of Lord Danby; and in the ministerial difficulties which followed upon Danby's impeachment and committal, Temple submitted to the king a plan of a council, which the king adopted: not always following Temple's opinions however as to the persons of whom it should be composed, and, above all, in defiance of his advice, placing Lord Shaftesbury at the head of it. This council was not long-lived, but it did not die until after its author had been removed from it. [CHARLES II.]

Thus ended Temple's political career. The remainder of his life was passed in the country, and divided between learning and rural pursuits. He now composed his 'Memoirs.' He died on the 27th January, 1699. No particulars of his death have been transmitted to us.

After the Revolution of 1688, Sir William Temple refused office from William III., who was very anxious for his counsel and for the authority of his name. But his son, with his permission, accepted the place of secretary at war, and within a week after committed suicide.

Neither as statesman nor as author does Sir William Temple occupy a foremost place: but in both characters he is more than respectable. The following is a happy

description, by Sir James Mackintosh, of his character as diplomatist and statesman. 'He was a most admirable person. He seems to be the model of a negotiator, uniting politeness and address to honesty. His merit as a domestic politician is also very great: in an age of extremes he was attached to liberty, and yet averse from endangering the public quiet. Perhaps diplomatic habits had smoothed away his turbulence too much for such a government as England.' (*Life of Mackintosh*, ii. 139.) Dr. Johnson, speaking of Sir William Temple as a writer, has said that 'he was the first writer who gave cadence to English prose.'

There are two or three biographies of Temple: one by Abel Boyer, published about fourteen years after his death, and another by his sister, Lady Giffard, prefixed to the edition of his works published in 1731, 2 vols. folio. A very laboured and somewhat diffuse life has been lately published by the late Mr. Peregrine Courtenay, and to this work all who wish for the fullest information as to Temple's life will resort. The best edition of Temple's works is that published in 1814, in 4 vols. 8vo.

TENACITY, from the Latin 'tenacitas,' 'the power of holding'), a property of material bodies by which their parts resist an effort to force them asunder.

This property is a result of the corpuscular forces acting within the insensible spaces supposed to exist between the particles of bodies: it is consequently different in different materials, and in the same material it varies with the state of the body with respect to temperature and other circumstances.

Those corpuscular forces consist of attractions which vary according to unknown laws with the distances of the particles from one another, and even at certain distances they become repulsions; but, in all bodies except the elastic fluids, the combined actions of all the particles produce that coherence which constitutes the tenacity of the masses. In those fluids the particles have no coherence, and when the pressures to which they are subject are removed, those particles immediately separate from each other with forces depending, probably, upon the quantity of caloric with which they are combined. In non-elastic fluids and in solids, tenacity exists, but in very different degrees: its force depending upon differences in the intensity of the attracting powers between the particles, upon differences in the distances of the particles themselves, upon the action of the caloric, and, in some cases, upon variations in the pressure of the atmosphere.

The molecules of liquids adhere to one another, and generally to those of solid bodies, by attractive forces which decrease very rapidly; and, at insensible distances from the supposed places of contact, the adhesion entirely disappears [CAPILLARY ATTRACTION]: the real tenacity of the molecules being, as Dr. Young observes, equal to the excess of their mutual attractions above the forces of repulsion arising from the actions of the caloric particles. It is on account of the small distance to which the attractions of the fluid molecules extend, and to the freedom with which the particles move on one another, that fluids appear to have so little tenacity; but from the weight of water which it supports in glass tubes, Dr. Robison has estimated that the mutual attractions of the particles of water on a surface equal to one square inch must far exceed 190 pounds.

Grains of dust or sand, while dry, have no power of adhering together, probably because their forms do not permit a sufficient number of points on their surfaces to be brought within the distance at which corpuscular attractions take place; but, if slightly wetted, the mutual attractions between the dust and the liquid produce a certain degree of tenacity: this is very sensible in clay moistened with water; for being then drawn into the form of a rod, it is capable of bearing a small weight suspended from it. Tenacity exists in various degrees in viscid fluids, as oil, gum dissolved in water, &c.; sealing-wax and glass also, when heated, lose their brittleness, and are capable of being moulded into any form, while their particles retain a considerable degree of adhesive power.

The tenacity of solids constitutes, in part, the subject of the power of bodies to resist strains; and under **MATERIALS**, **STRENGTH OF**, will be found a table p. 8, col. 2 of the weights which would overcome the force of cohesion in not immovably fixed at one end and pulled in the direction of their length: these weights may be considered as

the measures of tenacity in the different kinds of material; and it may be here added that, from a mean of several experiments made by Mr. Telford on the tenacity of forged iron, the breaking strength, when reduced to that which it would be if the area of a transverse section of the bars had been one square inch, is 29½ tons. The bars were cylinders or parallelepipeds varying in length from 1 foot 5 inches to 2 feet 3 inches; and in area of section, from 0.56 to 3.11 square inches: they stretched in length from 2 inches to 4 inches before they broke. Mr. Telford found also that a bar of cast-steel bore suspended from 15½ tons, a bar of blistered steel 17.27 tons, and of cast-iron Welsh pig 7.26 tons: the area of the section in all being one square inch. Tenacity in solid bodies varies greatly with their temperature. M. Coulomb took a piece of copper-wire, which, when cool, carried 22 lbs. suspended from it: and, upon bringing it to a white heat, it would scarcely bear 12 lbs.

Though, when a piece of metal is fractured, the parts will not by simple adjunction adhere together; yet, in some cases, by hammering them upon one another, so many points on their surfaces may be brought within the limits to which the force of cohesion extends, that they will acquire a tenacity equal to that which the metal had in its natural state.

The tenacity of wood is much greater in the direction of the length of its fibres than in the transverse direction, the fibres being united by a substance having little cohesive power. Few experiments have been made on the tenacity of wood perpendicularly to its grain, as it is called; and from those of Mr. Emerson it appears to vary from one-tenth to one-seventh of the tenacity in the other direction. When a strain takes place in the direction of the fibres, they become disengaged from one another, and thus lose the strength which arises from their lateral cohesion: they then become subject to separate strains; the weaker ones are first ruptured, and at length all give way, leaving an irregular surface of fracture.

With respect to metals, the processes of forging and wire-drawing increase their tenacity in the longitudinal direction; the augmentation of friction and lateral cohesion, arising from the particles being forced together in the transverse direction, more than compensates for the diminution of the attraction which may result from the particles being forced or drawn farther asunder longitudinally. Copper and iron have their tenacity more than double while gold, silver, brass, and lead have it more than triple by those metals being drawn into wire.

Mixed metals have, in general, greater tenacity than those which are simple: the tenacity varies with the different proportions in which the metals are mixed: but the proportions which produce the greatest strength differ in different metals. The only experiment on this subject with which we are acquainted are those of Muschenbroek; and from these we find that a compound of which ½ were gold and ½ copper had a tenacity of cohesion, more than double that of the gold or copper alone; brass, composed of copper and zinc, had a tenacity more than double that of the copper, and nearly twenty times as great as that of the zinc: a metal of which ¼ were block-tin and ¾ lead, had a strength more than double that of the tin; and a mixture of which ⅓ were lead and ⅔ zinc had a tenacity nearly double that of the zinc, and nearly five times as great as that of the lead alone.

TENAILLE, in Fortification, is a rampart raised in the main ditch, immediately in front of the curtain between two bastions; and, in its most simple form, it consists of two faces coinciding in direction with the faces of the bastions, and, consequently, forming with each other a re-entrant angle. Generally, however, it consists of three faces, of which two have the directions just mentioned, and the third forms a curtain which is parallel to that of the enceinte. See P. *Fig. 1*, **BASTION**, and P. in the plan, p. 377, **FORTIFICATION**.

This work was originally proposed by Vauban, in order to serve the purpose, in part, of a fausse-braye [*Faux-braye*], since the fires of musketry on its faces may be employed, in conjunction with those of artillery and musketry on the flanks of the bastions, to oppose the passage of the enemy across the main ditch when about to mount a breach in the ramparts of the place.

The relief of the tenaille, or the elevation of its crest above the bottom of the ditch, is determined consistently

tention of thus defending the main ditch; and at the defenders of the tenaille may not be the shot fired over their heads, from the flanks on, it is usual to make the crest of that work a horizontal plane passing three or four feet joint where a line of fire from one of those d cut a vertical plane, bisecting the angle of its curtain. The height thus determined the parapet of the work to be elevated from feet above the terreplein of the ravelin in its consequently, from the curtain of the tenaille re of musketry might be employed to protect of the ravelin, or of its reduit, if there is one, defenders of either of those works abandon it ence of an assault being made) before the time to cover himself in it by a lodgment: that o contribute powerfully to prevent the enemy ating to enter the ravelin by its gorge.

at first, gave to his tenailles short flanks nearly hose of the bastions, but he soon abandoned ction, perceiving that though the defenders fire correctly along the main ditch, yet the those flanks were liable to be destroyed by the e enemy's counter-batteries [H, Fig. 1, Bas- hey were enfiladed from the rampart of the or from the glacis of the places of arms (L). ffording additional fires for the defence of the the tenaille serves to cover, in part, the revet- curtain in its rear, and prevent it from being fire from any lodgments of the enemy on the parapet serves also to mask the postern in the e enceinte, which would otherwise be so much the fires from the counter-batteries, that the ight be unable to communicate through it tworks. On this account the breadth of the en the curtain of the tenaille and that of the made such only as to allow the parapet of the relief determined as above mentioned, to postern from the view of the enemy on the is ditch is advantageous in preventing the de- he tenaille from being injured by the splinters be detached from the flanks and curtain be- d, when dry, it serves to cover bodies of troops issue from thence and attack the enemy while main ditch, previously to making an assault. ditch contains water, the tenaille serves to oats and rafts by which the defenders of the municate with the outworks.

lle has been considerably improved by Bous- returning, in one respect, to the original idea has given flanks to the work in order that tch may be directly defended by them. These aised high enough to cover the revetments of f the bastions, while their upper surfaces may y a fire of artillery from thence; and, instead rmed with open terrepleins, and parapets for s usual, each flank of the tenaille is provided tes, or vaults, for four pieces of artillery which nearly on a level with the terreplein of the r. These guns are consequently capable of ted against the counter-batteries (H) of the ell as of defending the foot of a breach in the bastion.

truction was adopted by Chasseloup de Laubat lles of the detached works which he executed andria, in Italy, when Napoleon (after the andrego) proposed to make that city the base tions beyond the Alps. But, in order to avoid f which results from a fire directed against the shot in striking the cheeks or sides of the detaching from them splinters, which being the vault do more injury to the defenders than elf, this engineer raised before each flank of a mass of earth which was reveted with brick- perforated in such directions that, in defending the shot from the casemates could be fired apertures, while the mass served as a mask d prevent the enemy from seeing the embra- flanks of the tenaille.

n his 'Science des Ingenieurs' (1729), proposed ith each face in the form of a circular arc, between the curtain and the shoulder of the ut this construction, to which the name of

'ram's horns' was given, has seldom been put in practice.

Any work belonging either to permanent or field fortification, which, on the plan, consists of a succession of lines forming salient and re-entering angles alternately, is said to be a *tenaille*.

TENAILLON, or Great Tenaille, in Fortification, is a species of exterior work which has been occasionally constructed before the faces of a small ravelin, with a view of increasing the strength of the latter, procuring additional space beyond the ditch, or covering the shoulders of the bastions. They were invented by Vauban, who, however, very seldom constructed them; and subsequent engineers have generally considered them as inferior in defensive qualities to a counterguard [QQ, FORTIFICATION, Fig., p. 377] placed over the faces and salient angle of the ravelin.

The form and position of a tenaillon may be understood, Y being supposed to represent a small ravelin, if beyond the ditch of the latter the ramparts of the right and left faces be produced till each of them meets a rampart nearly perpendicular to the face of the bastion and extending to the place of meeting from the counterscarp of the main ditch at a point opposite the middle of that face. The works thus formed, one over each face of the ravelin Y, constitute a tenaillon; before each line of rampart is a ditch, and part of the general covered-way, the main ditch and that of the ravelin being in the rear. The two faces which are beyond the salient angle of the ravelin would, if produced towards the latter, form with each other a re-entering angle, whose vertex would coincide with that of the said angle.

The objections to tenaillons are, that the besieger would experience little difficulty in establishing a lodgment on that part of the covered-way or glacis which is immediately in front of the salient angle of the ravelin; and in this situation he would be able to breach the faces of the two half-bastions in four places, by fires of artillery directed along the ditches of the ravelin and those on the side faces of the tenaillon. The salient angles of the tenaillon, and of the ravelin which it covers, may be breached at the same time, and, when the ditches are dry, it would be possible to attack and carry the ravelin at the time of making the assaults on the tenaillon: then, the enemy having got possession of the former work, any retrenchments which may have been made in the tenaillon must necessarily be abandoned by the defenders.

At the siege of Lille, in 1708, one of the tenaillons held out a long time, but this is ascribed by French engineers rather to the faulty manner in which the siege was conducted by the allies than to the strength of the work.

The re-entering space between the two faces which are in the prolongation of the faces of the ravelin, and which constitute the head of the tenaillon, is sometimes occupied by a small redoubt, consisting of two ramparts perpendicular to the faces which have been just mentioned; and thus there may be obtained a good crossing fire for the defence of that part of the covered-way which is concealed by the salient angles of the tenaillons from the defenders of the bastions.

Demi-tenaillons are works placed also on the sides of a ravelin, and consisting of two ramparts which are perpendicular to and nearly opposite the middle of the faces of the bastions and ravelins: these are usually accompanied by counterguards which cover the salient angles of the latter works, and are called *Bonnets*.

TENANCY. [TENANT.]

TENANT. [TENURE.] Tenants, in the more extended legal sense of the word, are of various kinds, distinguished from each other by the nature of their estates; such as tenants in fee simple, in fee tail, for life, &c. [ESTATE; TENANT IN FEE SIMPLE, &c.]

TENANT AND LANDLORD. The word tenant in the more limited legal sense, which is also the popular sense, is one who holds land under another, to whom he is bound to pay rent, and who is called his landlord. The present article is confined to this sense of the word, in which it is proposed to show the nature, construction, and effect of the contract by which the relation of landlord and tenant is created; the rights, liabilities, and duties of each under it; how it ceases or may be terminated; and the legal means by which the rights and duties of each may be enforced.

The word land is here used in its comprehensive legal sense, which means not only the actual land itself, but also all things, such as buildings, woods, and water, which may be upon it. Any one who has an estate in land, provided he is also in possession, may let the land to another. The character and duration of the letting are partly regulated by the nature of the interest of the lessor or landlord and partly by the contract of letting. Thus one who is the owner of land in fee simple may let the land for any limited period, while one who holds only for life cannot let for any longer period than the life upon which his estate depends, unless he has a special power to grant leases; and if he should let for any longer period, the interest of the tenant will cease on the expiration of the life. To constitute the relation of landlord and tenant, the period for which the land is let must be shorter than that during which the land is held by the lessor, so that the lessor may have a reversion. If he parts with his whole interest, he is an assignor, not a lessor. Where the letting takes place by an express contract between the parties, the contract is called a lease. [LEASE.] A lease may be made by deed, by writing without deed, or by a mere verbal agreement. By the 29 Ch. II., c. 3, s. 1, all leases, estates, &c. in land, &c. not put into writing, and signed by the parties so making or creating the same, or their agents thereunto verbally authorized or by writing, shall have the force and effect of leases or estates at will only, and shall not either in law or equity be deemed or taken to have any other or greater force or effect, &c. The second section of this act makes an exception in favour of 'all leases not exceeding the term of three years from the making thereof, whereupon the rent reserved to the landlord during such term shall amount unto two third parts at least of the full improved value of the thing demised.' Under the construction which this statute has received, an unwritten lease for a longer period than three years will create a tenancy from year to year, and the terms as to rent, &c. upon which the tenant holds will be those which are agreed upon in the unwritten lease. The loss of a lease will not destroy the tenancy, provided the previous existence and the terms of it can be proved.

But the relation of landlord and tenant may be created otherwise than by a formal lease. If one man with the consent of another occupies his land, a contract of letting is assumed to have been made between them, and the occupier becomes tenant to the owner. Formerly such tenants were called tenants at will, and might have been turned out at any time by the landlord; but now a more convenient and reasonable construction of their occupation prevails, and they are considered to be upon the same footing as if the lands had been let to them for a year dating from the commencement of their occupation. At the end of the first year, a second year's tenancy begins, unless six months' notice of the intention to determine the contract has been given by either party to the other, and so on from year to year. The same construction is applied to cases where a tenant continues to occupy land after the expiration of a lease made by deed; but in this case all the covenants of the expired lease as to payment of rent, repairs, insurance, and the like are held to be in force unless the lease is cancelled by destroying the seal; and even if there should be a verbal agreement for a different rent, still the old covenants subsist, unless the lease is cancelled. If a party who has the power to set aside an existing lease chooses to receive rent under it, he will be held to have confirmed it; and even where a lease has determined, as a lease granted by a tenant for life for a longer period than he was entitled to grant one would become upon his death: yet if the remainder-man or reversioner has allowed the tenant to lay out money on the premises, he will be prevented by a court of equity from discharging the lease.

Besides tenancies for fixed periods, a tenancy may exist at Will and by Sufferance. [TENANT AT WILL; TENANT AT SUFFERANCE.] A tenant at will cannot lawfully be turned out of possession, nor can the landlord succeed in an action of ejectment against him, till after a demand to quit has been made upon him by his landlord; but a tenant by sufferance may be turned out by an action of ejectment without any demand. A master may let land to his servant, but where the servant is allowed by the master to occupy premises belonging to him for the mere purpose of more conveniently performing his duties as servant, or as

in part or total payment of wages, the servant therefore become a tenant, and the premises are to be in the occupation of the master. The landlord and tenants generally applies also, so not restricted or varied by the particular circumstances of the contract between the parties, to the case of tenants and occupiers of lodgings.

In every case where the relation of landlord and tenant exists, either by express or by implied contract terms are implied by law to have been agreed upon by the parties as forming part of the contract. It is of the power of the parties, where the contract is express, to qualify these terms so implied by the language of the contract itself. But it may be observed that as these terms are comprehensive in their nature, and distinctly implied in law, the interests of parties are often better protected by leaving them to the general protection afforded by these implied terms than by attempts to define and enumerate in detail the respective rights and duties of landlord and tenant. The terms implied on the part of the landlord are, that the tenant shall quietly enjoy the premises; on the part of the tenant, that he will keep the premises in repair to a certain extent after mentioned, and use the land, &c. in a landlordlike manner.

As a general rule it may be laid down that the tenant is not entitled to set off against his rent, debts due to the landlord to him; but there are some exceptions. If the landlord is himself tenant of the premises to another landlord, and neglects to pay his rent, and the superior landlord is called upon to pay it to the superior landlord, the tenant may do so, and set it off against the rent due from his own landlord. Payments also made by the tenant under the land-tax act (38 Geo. III.) may be set off against the rent due to his landlord. When a landlord is bound to repair, and the tenant, in order to prevent further damage, expends money on the repairs, or the landlord undertakes to repay the tenant the amount of such repairs, &c. paid in the first instance by him, the tenant may set off. If a tenant has covenanted without condition or reservation to pay rent during the term of a lease, and the lease has been granted to him, he will be bound to pay rent, even although the premises should be entirely destroyed by fire or other casualty; and even although he has assigned his lease to another and ceased to have possession, he will still remain liable under his covenant to pay rent. But the party to whom he has assigned the lease, as a general rule, remain liable for rent to the landlord only so long as he continues in the possession of the premises.

Generally, the tenant is bound to repair the premises. Repairs have been divided into two kinds, viz. substantial repairs and ordinary repairs. The division is a very simple one, but great difficulty often arises in practice in determining to which kind any particular kind of repair belongs. Tenants for a long term of years are said to be liable for substantial repairs, such as rebuilding, &c.; tenants from year to year are liable for ordinary repairs, and for injuries caused by their negligence. A landlord is in no case, unless under agreement to that effect, liable to any action for repairing nor even for not rebuilding where there is a total destruction of the premises. But in the case of short tenancies, if the landlord should not rebuild the premises, the tenant would be liable for the substantial repairs necessary, if the landlord should not rebuild the premises and would cease to be liable for rent. It has been already observed that a tenant who has a lease which contains covenants to repair, who by neglecting to do so and paying rent after the expiration of his term becomes a yearly tenant, will still be liable to be ejected in the same manner provided for by the covenants. Such a tenant, therefore, though only a yearly tenant, may be bound to do substantial repairs; and if he wishes to avoid liability, he should guard against it by an express agreement. In the case also of a lease which has been acted on by the parties as if valid, the terms of the lease will be looked to for the purpose of determining what are the duties and liabilities of the tenant as to repairs, &c. No tenant, in the absence of agreement to that effect, is bound to rebuild after accidental destruction of the premises by fire. But under a general covenant to repair, and *leave repaired*, the tenant is bound to rebuild even in the case of destruction by fire.

repair are said to be construed by the courts for the landlord, but the tenant is not bound to act the natural consequences of the wear of time and elements.

The natural tenancies the lease itself generally determine the mode in which the farm is to be treated, and the meaning of the expressions used will be ascertained by the action put upon them by persons familiar with the law.

Unless also the lease expressly or impliedly provides for the operation of the custom of the country, the tenant is bound to conform to it. The custom of the country means the general practice employed in neighbourhoods of a similar description, with reference to the mode of cultivation, crops, keeping up fences, and other like matters of farms it is often the practice to protect the tenant against certain acts of the tenant, such as the cutting up meadow land, &c., by introducing certain provisions into the lease. These provisions may operate in various ways; to the phraseology used, either to assign a value or to determine the liquidated damages agreed upon for the act done. It is often a matter of great importance and of some nicety to determine which class the provisions fall. If under the lease the landlord is not entitled to the whole penalty for an act being done, but he can only recover in an amount of the actual damage which has accrued under the second, he is entitled to the whole of the damages agreed on. A covenant by a tenant not to plough up meadow under a penalty of 5*l.* per acre ploughed, is an instance of the first class: a covenant not to pay 5*l.* rent for every acre of meadow ploughed up, is of the second class. The right to timber or trees belongs to the landlord; loppings and bushes, to the tenant. Different definitions are given in different counties of timber and timber-like trees.

Various customs prevail as to what amount of the rent a tenant may be allowed to employ (after the rent has been called on to select it) for the purposes of the lease. No tenant, unless he employs the land as a garden or gardener, can remove any kind of shrub or tree, not even a row of garden box, though planted in the garden.

[WASTE.] Neither can a tenant remove fixtures put down by himself. A fixture is a chattel which is fastened to the soil, or united to some other part of the premises. There are some exceptions to this rule in the case of fixtures used for the purpose of trade or agriculture, or for merely ornamental purposes, where the removal causes little or no damage. (*Amos and Ferard, On Wastes*)

A tenant in occupation of the premises is, in the first instance, liable for all taxes and rates of every description on the premises. The party therefore who is bound to collect them may proceed against the tenant in occupation to recover them. It is generally a condition of the agreement between the landlord and tenant that the tenant shall pay all rates and taxes except the land tax, if however the landlord has undertaken to pay the land tax, rates and taxes, and fails to do so, the tenant is liable for the amount from his rent, or bring an action against the landlord; but this should be done during the current year; if the tenant allows a considerable time to elapse before claiming a deduction or bringing an action, he is held to have waived his claim to recover them from the landlord.

If a fixed rent has been agreed upon, has become due, and is neither paid nor tendered, the landlord, under the provisions mentioned hereafter, has a right to seize the tenant's crops, any kind of stock, goods, or chattels, upon the premises, or pasturing any common enjoyed in right of the premises, whether such things are the actual property of the tenant or not; and if the rent remains unpaid, he may distrain them. The exceptions are: Things in actual use, such as a horse or a horse on which a tenant is actually riding. The reason given for these exceptions is that the seizure of goods so circumstanced would be a breach of the peace. Things sent to a tenant for the purpose of being worked up by him; things sent to a principal to his factor for sale, and the carriages conveying them; the goods and cattle of a tenant at an inn; goods that are already in the hands of the law, such as goods in a bailiff's hands in execution, &c. The tools, &c. of a man's trade, such as the plough, &c., are not liable to distress

if there are other goods sufficient in value upon the premises. [DISTRESS.]

The contract of letting may cease otherwise than by the mere lapse of time. By 29 Ch. II., c. 3, the Statute of Frauds, a surrender of a lease can only be by a deed or note in writing, signed by the party surrendering or his agent authorised in writing, or by act and operation of law.

The deed or note in writing must proceed upon mutual agreement between the tenant in possession and his immediate landlord, and, besides being signed, must be duly stamped. A lease may cease to exist by act and operation of law: 1, upon the acceptance by the tenant of a new lease in writing for the same premises from the landlord, the operation of which is to begin at some period during the term for which the original lease was granted; 2, in the case of a yearly tenancy, where the landlord permits the tenant to quit, and he does quit, and the landlord accepts the possession; 3, where the estate of the landlord and tenant become united in the tenant, the tenancy ceases to exist; 4, by forfeiture. A forfeiture may arise either by a breach by the tenant of one of those conditions which are implied by or attached to the relation of landlord and tenant, as where a tenant disclaims or impugns the title of his landlord by acknowledging, for instance, the right of property to be vested in a stranger, or asserts a claim to it himself, or by a breach of a condition which is expressly introduced into the lease, the breach of which is to be attended with a forfeiture of the tenancy, as a condition to pay rent on a particular day, to cultivate in a particular manner, &c. To this head may be referred provisions in a lease for re-entry by the landlord on the doing or failure to do certain acts by the tenant, such as the commission of waste, the failure to repair, &c. The courts are said to be unfavourable to forfeitures; therefore, when the landlord has notice of an act of forfeiture, or an act which entitles him to re-enter, he must immediately proceed in such a way as to show that he intends to avail himself of his strict legal right. If after the commission of the act he does anything which amounts to a subsequent recognition of the tenancy, as by the acceptance of rent subsequently due, he will be held to have waived his right to insist upon the forfeiture.

A yearly tenancy, where no period of notice is agreed on, must be determined by a notice to quit at the expiration of the current year, given six months previously. If the period at which the current year expires is uncertain, the notice should be to quit at the end of the year which shall first occur after the expiration of six months from the service of the notice. Where a fixed period of notice is agreed on, what has been said as to the period will apply to the period agreed on. Where different portions of the premises have been entered on at different times, the entry upon the principal portion will, for the purposes of quitting the premises, be considered as the entry upon the whole; and in case of a dispute at a trial which is the principal portion, the jury must determine. In the case of lodgings, the time, when less than a year, for which they are taken, will be the time for which a notice is necessary. Thus lodgings taken by the month or week require a month's or week's notice. A notice to quit may be waived by an acceptance of rent or by a distress for rent due after the expiration of the notice.

If by the default of the landlord the premises cannot be occupied beneficially, as where the landlord is bound to repair, &c., and does not, the tenant may quit without notice.

The notice to quit need not be in writing, though, from the greater facility of proving it, a written notice is always desirable. It should distinctly describe the premises, be positive in its announcement of an intention to quit or require possession, be signed by the party giving it, and served personally upon the party to be affected by it.

If a tenant, after having given notice to quit, continues to occupy, he is liable to pay double rent. If he does so, no fresh notice is necessary. If he continues to occupy after the landlord has given him notice, he is liable to pay double value for the premises.

At the expiration of the contract the tenant is bound to deliver up possession of the premises; but if either by special agreement or by the custom of the country the tenant is entitled to the crops still standing on the land, and which are called away-going crops, he may enter for

the purpose of gathering them, and also use the barns and stables for the purpose of threshing and conveying them away. The in-coming tenant may also enter during the tenancy of the preceding tenant to plough and prepare the land.

An action for the recovery of rent may, if the land is let by lease under seal, be in debt for the amount, or in covenant for the damages incurred by the non-payment of it. If there is no indenture, the action may be in debt on the simple contract, or in assumpsit for the use and occupation of the land.

If the tenant refuses to deliver the possession of the land, the landlord may bring an action of ejectment to recover it. By 4 Geo. II., c. 28, which was passed with a view to remove the difficulties existing under the common law as to the necessity for a formal entry, &c. by the landlord, it is enacted that where there is half a year's rent in arrear, no sufficient distress on the premises, and the landlord to whom the same is due has a right of re-entry, he may, without any formal demand or re-entry, serve a declaration in ejectment, which shall stand in place of the same.

By the 11 Geo. II., c. 19, and 57 Geo. III., c. 52, if a tenant, under any lease or agreement, written or verbal, though without a clause of re-entry, of lands at a rack-rent, or rent of three-fourths the yearly value, shall be in arrear for half a year's rent, and shall leave the premises deserted and without sufficient distress, any two justices of the county, at the request of the landlord, may go and view the premises, and fix on the most conspicuous part of them notice in writing on what day, distant fourteen days at least, they will return again to view the premises; and if on the second day no one appears to pay the rent, and there is no sufficient distress on the premises, the justices may put the landlord into possession, and the lease shall become void. These proceedings are subject to appeal before the judges of assize for the same county at the ensuing assizes.

By 1 & 2 Vic., c. 74, where the interest of any tenant of land, &c. at will, or for a time less than seven years, liable to the payment either of no rent or a rent of less than 20*l.* a year, shall have ended or been duly determined, and the tenant shall refuse to quit, the landlord may serve him with a notice, a form for which is given in the act, to appear before a justice for the county; and if he fails to show satisfactory cause why he should not give up possession, the justices, on proof of the tenancy and of the expiration of it, may give possession to the landlord. If the landlord was not at the time of the proceedings lawfully entitled to possession, he will be liable to an action of trespass at the suit of the tenant, notwithstanding the act of parliament.

(Woodfall's *Landlord and Tenant*; Cooté's *Landlord and Tenant*.)

TENANT AT WILL, AND FROM YEAR TO YEAR. 'Tenancy at will,' says Littleton, s. 68, 'is where lands or tenements are let by one man to another to have and to hold to him at the will of the lessor, by force of which lease the lessee is in possession. In this case the lessee is called tenant at will because he hath no certain or sure estate; for the lessor may put him out at what time it pleaseth him.'

An estate at will may arise by implication, as well as by express words. Thus, where a tenant for years continues in possession after the expiration of his term, and pays rent as before, the payment and acceptance of rent constitute a tenancy at will. So, where a man enters under an agreement for a lease or a contract for the purchase of an estate, he must be considered at law as the tenant at will of the person who has the legal title. (10 Vin., *Ab.*, 400; 1 B. and C., 448; 3 Camp., 8.)

Where a mortgagor continues in possession of his land with the consent of the mortgagee, after default in payment of principal and interest at the time stipulated in the mortgage deed, he is tenant at will. So also, where the legal estate is vested in a trustee, the beneficial owner, or *cestuique trust*, if he be in possession, is considered at law as tenant at will under the trustee. (Cruise, *Digest*, tit. 9, c. 1, § 4.)

A tenant at will having no certain estate, has nothing which he can grant to another, and a person entering under a grant from a tenant at will is subject to an action of trespass. (Co. Litt., 57 a.)

A tenant at will has no right to commit any waste; but, on the other hand, he is not liable to sustain houses, &c., and therefore there is no action against him for permissive waste. (Co. Litt., *Rep.*, 13 b.)

A tenancy at will may be determined either by declaration of the lessor that the tenant shall no longer, which must be made on the land, or notice of it to the lessee (Co. Litt., 55 b.), or by some ownership exercised by the landlord inconsistent with the continuance of the estate, such as entering on and cutting down trees demised, making a feoffment lease for years to commence immediately. On the part of the tenant, any act of desertion, an assignment of the land to another, or the commission of waste, is a determination of his estate. A lessor determining the tenancy loses the rent; and on the other hand, a lessee who determines it before the rent is due must notwithstanding pay it up to that time. If either party determines the tenancy, if it be of a house, continues till the next rent-day; and if of land, until the summer next following. (Co. Litt., 55 b. 57 a.)

Where a tenancy at will is determined by the landlord, the tenant is entitled to emblements; but not if determined by the tenant himself. (Litt., § 68, 116.)

It is settled that a landlord cannot bring an action against the tenant at will or his representatives, without giving six months' notice to quit. (Cruise, tit. 15.)

The courts are always inclined to construe demises for no certain term as estates at will, and not as estates for years, unless a certain term is mentioned, not as estates at will, but as estates for years, and the circumstances are such as to warrant this construction. (2 Black-st., 1171.) A remainder-man receives rent from a tenant under a lease for years which is void as against him, before he can avoid it, a tenancy from year to year is created. (R., 478.) Also where an agreement for a lease for more than three years is made by parol, and is therefore void by the Statute of Frauds, there is a tenancy from year to year regulated by the terms of the agreement. (5 T. R., 378.)

A tenancy from year to year, when once constituted, is binding not only upon the reversioner, but his heirs and assigns. (1 T. R., 378), and does not cease upon the death of the tenant, but goes to his executors or administrators. (3 T. R., 13; 15 Ves., 241.) The tenant is bound to give six months' notice to quit, ending at the expiration of the year, and thus a new year is continually added to the term as often as the half year's previous notice is given at the proper time. (3 B. and C., 448.)

A tenant at will is capable of taking a release of the inheritance after he has entered, but his estate is not a bar to the foundation of a remainder. (Litt., iii., 460; *Rep.*, 75 a.)

TENANT AT SUFFERANCE. says Lord Coke, 'he that at first came in by lawful demise, and estate endeth continueth in possession, and will holdeth over.' Thus a tenant *pur autre vie*, or for years, in possession after the death of *cestuique vie*, or for years holding after the expiration of his term, or a person who, having been tenant at will, continues in possession after the death of the lessor, are all tenants at sufferance.

As the tenant at sufferance holds only by the sufferance of the owner, there is no privity of estate between them, therefore the tenant at sufferance is not capable of releasing the inheritance. (Litt., § 160.) On this ground it was held that tenants at sufferance are bound to pay any rent; but by the 4 Geo. II., c. 28, it is enacted that 'where any tenant holds over after the expiration of his term, and notice in writing given for delivering possession, such persons so holding over shall pay the yearly value of the lands so detained, for so long as they shall hold over; to be recovered by action against the recovering of which penalty there shall be no relief in equity.' By the 11 Geo. II., c. 19, § 18, a penalty is imposed on tenants giving notice to quit, and afterwards holding over. And by the 1 Geo. IV., c. 27, various provisions are made for enabling landlords to recover possession of lands and tenements lawfully held over by tenants.

T-RIGHT is the name for a species of custom-peculiar to the northern parts of England, in which services against Scotland were antiently before the political union of the countries. The estates were holden of the lord of the payment of certain customary rents and the services above mentioned, are descendible to the heir according to a customary mode of descent respects from the rule of descent and command were not devisable by will either directly or of a will and surrender to the use of the same, they are now made devisable by 1 Vic., c. 26, s. 3. These estates appear to have many incidents not properly belong to villenage tenure or copy-holden at the will of the lord, or by copy of right and being alienable by deed and admittance has been determined that they are not freehold, they fall under the same general rules as copy-holds. (Doe v. Reay v. Huntington, 4 East, 271.)

T IN FEE-SIMPLE. A tenancy in fee-simple is the best estate which a subject can have in land.

The possession of an estate in fee-simple is an absolute power of disposition over the land; the grant made in fee-simple the grantor has parted with the whole interest.

It is necessary for transferring an estate in fee-simple to be reduced to this form: 'I give this land to you and your heirs.' (Litt., 1.) The addition of the words 'to you and your heirs' is not absolutely necessary in a deed, and no other words will serve; for any such words as 'I give the land to you for ever;' or 'to you in fee-simple,' or 'to the grantee nothing more than an estate in fee-simple,' or words of limitation, such as 'heirs,' are not necessary to pass a fee-simple by devise. (1 Vic., c. 26, s. 3.)

If a tenant in fee-simple dies intestate, the estate goes to the heirs general of the purchaser (in the sense in which the word is explained in 3 & 4 Wm. IV., c. 106), male or female, lineal or collateral. [DESCENT.] If a tenant in fee-simple in possession are subject to the claims of the husband and the dower of the wife. [COURTESY.]

If a tenant in fee-simple in the hands of the heir were subject to the law to the debts of the ancestor due to the ancestor, he is liable to specialty debts. By the 11 Geo. IV. and 1 Geo. IV., c. 47, a complete remedy was given for all specialty debts, both against the heir and devisee; and by 3 & 4 Wm. IV., c. 104, estates in fee-simple are liable in the hands of the heir or devisee for the simple contract debts of the ancestor.

If a tenant in fee-simple are forfeited to the crown for high treason (Co. Litt., 390 b.) In cases of petty treason and forfeiture to the crown is only for a year and a day, and the offender is bound to give the annus, dies et vastum; after which state escheats (in cases of petty treason and murder) to the lord. By the 54 Geo. III., c. 145, the forfeiture consequent upon attainder for felony, murder, or high treason, petty treason, and murder, is to the life-interest of the offender. It would have been thought that the power of dishealing the estate after his decease. Trust-estates in fee-simple may be forfeited to the crown, but are not subject to forfeiture.

The estate of a man and his heirs may be given upon any terms or limitations, which are capable of abridging or enlarging. The estate cannot then properly be called a fee-simple; but is, according to the circumstances, a qualified, or base fee. (Co. Litt., 1 b.)

T IN TAIL. The origin and general nature of the estate in tail have been already described. [ESTATE; TENANT; SETTLEMENT.]

The estate of the tenant-in-tail has some essential characteristics. He has a right to commit waste of all kinds, timber, pulling down houses, opening mines, and other like acts; and this right of the tenant-in-tail is not restrained. (11 Rep., 50 a; 3 Mod., n., 251.) His estate, being an estate of inheritance, is a tenant by sufferance: he is one who, though wrongfully entered, continues to occupy wrongfully, as when it is an estate in possession, to the courtesy of the husband and the dower of the wife. [COURTESY; DOWER.] The tenant-in-tail is also entitled to the custody of the lands, which the Court of Chancery will order him to have. (11 Rep., No. 1512.)

to be delivered up to him. (2 P. W., 471.) The tenant-in-tail is not bound to pay off incumbrances affecting the fee of the estate, as he has only a particular interest, and not the entire property in the land; and it seems that he is not in general even bound to keep down the interest on such incumbrances; though if he do pay off such incumbrances, it will in general be presumed to have been done in exoneration of the estate. (Cruise, Digest, tit. 2, c. 1, s. 40; and tit. 15, c. 4, s. 74.)

By the statute *De Donis* the tenant-in-tail was restrained from alienating his estate in any manner for a longer period than his own life, that is to say, the estate of the alienee, though not *ipso facto* determined by the death of the tenant in tail, became thereupon defeasible by his issue or the remainder-man or reversioner. (2 Id. Raymond, 779.)

If the tenant-in-tail conveyed his estate by lease and release, covenant to stand seised, or bargain and sale and grant, the right of entry of the issue and remainder-men was not affected by the conveyance. But a forfeiture or fine made or levied by the tenant-in-tail in possession by virtue of the entail, caused what was called a discontinuance of the estate tail, whereby the issue and the persons in remainder and reversion lost their rights of entry and were driven to their action. (Litt., 595, 596, 597.) This discontinuance might be either in fee, or for a limited period, according to the duration of the estate created by the conveyance of the tenant-in-tail; but while it lasted it affected not only the estate tail, but all the remainders and reversions. (Litt., 620, 625.) A discontinuance might also be produced by the obligation of a warranty by the tenant-in-tail descending on the person entitled under the entail. This discontinuance however was but partial, extending only to the heirs general of the person who made the warranty. (Co. Litt., 328, 329 a.) A fine duly levied with proclamations was an absolute bar to the issue, though not to the remainder-men, creating what was called a base fee; and by means of a common recovery duly suffered, the tenant-in-tail might bar his issue and all the remainders over, and make an absolute conveyance of the estate. [RECOVERY.]

By the 3 & 4 Wm. IV., c. 74, fines, recoveries, and warranties of land were abolished, and by the Statute of Limitations (3 & 4 Wm. IV., c. 27) it was enacted 'that no discontinuance or warranty which may happen or be made after that day (31st of December, 1833) shall defeat any right of entry or action for the recovery of land.' It seems therefore that no discontinuance, properly so called, can now be produced by any mode of conveyance, for, whatever may be the form of discontinuance, the last-mentioned statute takes away its effect.

The 3 & 4 Wm. IV., c. 74, which abolished fines and recoveries, has substituted for them certain modes of assurance whereby the tenant in tail may now at once bar his estate tail and all the remainders over. [FINE; RECOVERY; SETTLEMENT.]

In accordance with the principle which prevented a tenant in tail from alienating his estate for more than his own lifetime, leases by tenants in tail might be avoided after their death by the issue in tail. But by the 32 Hen. VIII., c. 28, tenants in tail were enabled to make leases for three lives or twenty-one years, which should bind their issue, though not the persons in remainder or the reversioner.

The estate of the tenant in tail is not subject to any of the debts or incumbrances of his ancestor, except debts due to the crown, by the 32 Hen. VIII., c. 39, s. 75.

Estates tail are subject to the bankrupt laws. The mode of procedure as to bankrupt tenants in tail is regulated by the 3 & 4 Wm. IV., c. 74, the 55th section of which expressly repeals the 6 Geo. IV., c. 16, s. 65, and virtually repeals the 1 & 2 Wm. IV., c. 56, s. 26. The powers of the commissioners of bankrupts as to the disposition of such estates are defined (ss. 56-69).

Estates tail are subject to forfeiture for high treason by the 26 Hen. VIII., c. 13. By attainder for high treason, the estate of the tenant in tail, of his issue, and of all such of his collateral heirs as would have been entitled to take under the estate tail, are forfeited, but not the estates in remainder or the reversion.

The 26 Hen. VIII. extends only to cases of high treason, and therefore as to felonies the statute *De Donis* is still in force, and the forfeiture by attainder for felony extends

only to the life interest of the tenant in tail. (Co. Litt., 392 b.)

TENANT FOR LIFE. Tenancy for life of lands or tenements is the possession of a freehold estate or interest, the duration of which is confined to the life or lives of the tenant or some other person or persons.

The estate of the tenant for life is either (1) such as is created by deed or some other legal assurance, or (2) such as arises by operation of law.

(1) An estate for life may be created by lease with livery of seisin, or by any other conveyance at common law which might be employed in conveying the fee, or by a declaration of a use, or by will. The estate so limited may be either to a person for his own life, or it may be given to one for the life of another, or for any number of lives mentioned in the grant. In the last case, the estate is in effect one for the life of the survivor of the persons so named. On the other hand, an estate may be granted for the joint lives of A and B, in which case it is in fact an estate for the life of the person who dies first.

When lands or tenements are conveyed by deed, without any express limitation of the quantity of estate to be taken by the grantee, he takes an estate for life only. This however is the case only when the grantor might lawfully create such an estate; for if he be tenant in tail, the conveyance, unless it be a lease within the provisions of the stat. 32 Hen. VIII., c. 28, will pass only an estate for the life of the grantor. (Co. Litt., 42 a.) Before the 1 Vic., c. 26, a devise without words of limitation conferred on the devisee a life estate only; but now by sec. 28 of that act, a devise, though without any words of limitation, passes the fee simple, or the whole of such other estate as the testator had power to dispose of, unless a contrary intimation appear by the will.

Formerly, when lands were given to A for the life of B without any words of limitation, if A, or the person to whom he had assigned his estate, happened to die in the lifetime of B, the estate was considered as a kind of *hereditas jurens*, belonging to whoever first took possession; and the person who did so was called the general occupant (Co. Litt., 416). [OCCUPANCY.]

A gift to two persons for their lives is an estate in joint tenancy, and for the life of the survivor, if the parties continue joint tenants; but if the jointure be severed, each has then an estate in the moiety for his own life only. (2 Blackst., *Com.*, 187.)

A condition may be annexed to an estate for life, as well as to an estate in fee simple; but the condition, it appears, must not be one prohibiting alienation on pain of forfeiture, such a condition being considered inconsistent with the nature of the estate. (18 Ves., 433.)

(2) The estates for life arising by operation of law are, the estate tail after possibility of issue extinct, and the estate by courtesy and the estate in dower.

The estate tail after possibility of issue extinct arises when, by the death of one of the persons from whom the inheritable issue is to proceed, it has become impossible that any person should exist upon whom the estate tail can descend. Thus, if lands be given to A and the heirs of his body by B, his wife, or to A and B and the heirs of their bodies, and B die without leaving any issue of their two bodies living, A, from being tenant in tail special, becomes tenant in tail after possibility of issue extinct; which is in effect nothing more than a tenancy for life, with certain peculiar privileges remaining to the tenant out of his former inheritance, the principal of which is the right of committing waste. (Co. Litt., 27, 6; Cruise, *Digest*, tit. 4.)

As to the nature and incidents of tenancy by the courtesy and tenancy in dower, see *COURTESY* and *DOWER*.

Tenants for life are entitled to estovers; that is to say, to an allowance of necessary wood for the repair of houses and fences on the land; but no tenant for life, except tenant in tail after possibility of issue extinct, can cut down more timber than is necessary for such purposes, or build new houses, or open mines, without being guilty of waste, unless his estate be, as it may be, made expressly without impeachment of waste. [WASTE.]

When a tenant for life dies before harvest-time, his executors will be entitled to the crops then growing on the lands, as a return for the labour and expense of cultivation, and these are called in law *Emblements*. (Co. Litt., 55 b.)

A tenant for life is not bound to pay off the principal of incumbrances affecting the inheritance, but he is bound to keep down the interest of all such incumbrances. (1 Bro. R., 209; 1 Ves. jun., 233; 2 Bro. R., 124.)

In real actions all tenants for life, except tenants in tail after possibility of issue extinct, may pray in aid, or call for the assistance of the person entitled to the inheritance to defend his title, because the tenant for life is not generally supposed to have in his possession the evidences of the title to the inheritance. (Cruise, *Dig.*, t. 3, c. 1, s. 28.) It seems to have been formerly considered that the tenant for life had no right to the custody of the title deeds, but the contrary appears now to be established. (2 P.W., 477; 1 Ves., jun., 72; 1 Sch. and Lef., 209.)

The tenant for life may convey or demise his tenement by the same means as a tenant in fee, provided he does not attempt to convey any estate greater than his own.

If he convey by grant, lease for years, bargain and sale, or lease and release, he can pass no interest greater than that which he himself possesses, the conveyance for the excess is merely void, and no forfeiture is incurred. But a conveyance by feoffment, or by any assurance equivalent to a fine or recovery, if purporting to exceed the bounds of the life estate, displaces the estates in remainder and creates a wrongful fee simple. The person entitled to the next estate in remainder or reversion becomes then immediately entitled to enter, thereby restoring all the estates which had been displaced by the tortious conveyance, except that of the tenant for life, which becomes absolutely forfeited. (Litt., 609, 610, 415, 416.)

As to the merger and surrender of estates for life, see *MERGER* and *SURRENDER*.

The name tenant for life is also applied to the person to whom, in settlements or wills of personal property, is given an interest for life only in the fund which is the subject of the settlement or will. [SETTLEMENT; WILL.]

TENANT FOR YEARS. [ESTATE; LEASE; TERM OF YEARS; TENANT AND LANDLORD.]

TENANTS or TENANCY IN COMMON. [COMMON TENANCY IN.]

TENASSERIM, or TENASSERIM PROVINCES, is a term which has lately come into general use to designate those countries on the west coast of the peninsula which the Ganges which lie on the east side of the Gulf of taban, and were acquired by the British by the peace of Yandabo (1826) from the Birmans. At that time boundaries of this country were very imperfectly except that they were washed on the west by the Bengal. Even during times of peace predatory incursions had been made both by the Birmans and Siamese, which had the effect of converting large tracts contiguous to boundary-line into complete deserts, and thus it happened that the limits of the Birman and Siamese countries were unknown to the two states, which here came into contact with one another, and even up to the present British are very imperfectly acquainted with the extent of this possession. A river, Pakham, constituted, according to old records, the southern boundary-line of Birman parts, and the first maps which were published since the peace of Yandabo laid the boundary down near 11° N. but it was afterwards ascertained that the mouth of this river is south of 10° N. lat. and of Cape Victoria. During the occupation of the country by the Birmans, it had been considered that all the country drained by the rivers which fall into the Bay of Bengal belonged to their dominions, and that those whose drainage went to the Gulf of Siam formed a portion of the Siamese empire. When the British took possession of Tenasserim, this watershed was thought to be from 30 to 50 miles from the Bay of Bengal, but it has been ascertained that in some parts it is at a much greater distance, and that between 16° and 17° 40' N. lat. it is probably 100 miles from the sea. On the map annexed to Snodgrass's Birman War, the northern boundary is laid down between 18° and 19° N. lat., but it is now known that it is formed by the lower course of the river Thoung Yin, a tributary of the Saluen, and that it does not extend to 17° 40' N. lat. Thus we know that Tenasserim extends from 10° to 17° 40' N. lat., and it is supposed that the boundary, at least in some parts, approaches 90° long. It is evident that in the present state of our knowledge of the country it is impossible to determine the area of Tenasserim, but we are inclined to think that

of Dr. Helfer, who assigns to it an extent of 4000 square miles, is not too great.

The Salween or Salween from its confluence with the Irrawaddy to its mouth divides Tenasserim from Burma, and the young Yin divides Tenasserim from the Shan States of Zimmay, Laboung, and Yaihang. A range of mountains running from north to south through the whole Malay peninsula constitutes the boundary between the Malay Peninsula and Tenasserim as far south as the source of the Salween, and from that point the course of the Salween river forms the boundary to its mouth. In the Bay of Bengal and opposite to Tenasserim are the Mergui Islands.

Mergui Islands.—The coast of Tenasserim from the Salween river on the north (16° 30' N. lat.) to the Pakcham (10° N. lat.), extends in a straight line for 450 miles, and as its bends are not large, nor its depth or deep, its length probably does not exceed 400 miles, measured from point to point. A marked irregularity exists between this coast and that of the opposite Coromandel. The coast of Coromandel extends in a straight line without a single break, and does not afford a place of refuge even for a small vessel; that of Tenasserim is frequently interrupted by short projecting peninsulas, which several small harbours are formed, and a large number of receiving large vessels. The rivers of Coromandel do not admit vessels of any size, on account of the shallow water at their mouth, but in those of Tenasserim a considerable depth of water covers the muddy bars which they embouchures. No soundings are found off the coast of Coromandel at a distance of seven or eight miles, whilst along that of Tenasserim there are soundings to the distance of 60 or even 80 miles, and some places considerable irregularities occur, which may be generally said to be tolerably regular, the depth decreasing gradually to ten and even five fathoms as we approach the land. The coast from the Pakcham to Kmi or Kiaykami, situated on the west of and near the town of Amherst, as far south as Tavoy, is a low elevation. Between Tavoy and Mergui it is a low elevation, and in this part it is lined by a rocky reef, and a great number of small islands rise to a moderate elevation above the sea-level. These islands are known by the collective name of Long Island, and the reef on the west, having little water on it, renders the approach to this part of the coast dangerous, and in many places is practicable even for small vessels. South of the Pakcham the coast-line is broken by several deep inlets, and a large promontories, and enclose some small islands. The intricacies on this part of the coast are dangerous, that even at present it has not been completely surveyed, and is laid down rather by guess, though much has been done to clear up its position by Dr. Helfer. This indented coast extends from 12° 30' to 10° N. lat. South of the last-mentioned parallel inlets likewise occur, but though numerous, they do not extend to a great distance inland. In these parts close to the sea is more elevated than at any other part, and probably may contain many harbours.

Islands occur along the western coast of the Bay of Bengal, between 14° 40' and 8° N. lat. North of 12° they extend to the distance of 70 or 80 miles from the shore, but south of 12° N. lat. they are separated by only 30 miles in width. These islands are included under the collective name of the Mergui Archipelago. All the sea between them and the coast of Tenasserim has soundings, though near the islands they are too deep for anchorage. These islands also afford shelter from the sea during the south-west monsoon, and the deep channels which divide them from the coast offer great advantages to vessels coasting along the coast, which however have hitherto been little used, and the Mergui Archipelago has only been surveyed in 1825. The islands themselves are rather high, and are visible at the distance of 30 to 40 miles, including the islands which occur between 12° 30' and 10° N. lat., near the shores, and which are divided by narrow channels from the continent that are considered as parts of the mainland, the Mergui Archipelago comprehends seven larger and many smaller islands, including the larger islands from north to south are King's Island, Ross Island, Domel Island, Kisse-

roing Island, Sullivan's or Lampee Island, and St. Matthew's Island. These seven islands are more than 20 miles long, but vary in width from three to eight or nine miles. They are covered with timber-trees and well provided with water, but all of them have a very rugged and uneven surface, and do not appear to possess great fertility. No part of them seems to be cultivated, and they are only inhabited by a tribe of fishermen, the Seelongs. Two of these islands require notice, on account of their excellent harbours. The northern of these harbours is called King's Island Bay, being formed by the island of this name and Plantain Island, which lies east of it. This harbour is opposite to that of the town of Mergui on the mainland. It can only be entered from the north by large vessels, as the southern portion of the channel, which divides Plantain Island from King's Island has so little depth as to be only passable for country boats. The harbour is spacious and safe, but the entrance has some difficulties, as a shoal extends over a part of it, which has 19 feet of water on the shoalest part at high-water, and only nine feet at low-water. The second harbour is called Elephant Harbour, and occurs at the northern part of the Island of St. Matthew: it is described as very spacious, and capable of containing the largest navy in the world. The soundings vary from 17 to 12, 11, and 10 fathoms nearly close to the shore in some places, and the bottom is soft. It is protected from the sea by several small islands at the entrance, and on the other sides it is sheltered from all winds by the high hills which surround it, so as to be completely landlocked. This harbour was discovered in 1825, by Lieut. Low. The island of St. Matthew is the most elevated of the group; the highest part, situated in the middle, is nearly 3000 feet above the level of the sea.

Mountains.—It is supposed that a continuous range of mountains forms the watershed between the rivers flowing on one side into the Gulf of Siam, and on the other into that of Bengal, and that this range is the boundary-line between Siam and Tenasserim. It is also supposed that the elevation of this range varies between 3000 and 5000 feet above the sea-level, and that the most northern part, which is known among the natives by the name of Thown-gee Mountains, is the most elevated portion. It is stated that in this part it makes a great bend towards the east, forming nearly a segment of a circle. But we have no account of this part of the range: it has only been traversed at the Three Pagodas, which stand near the sources of the upper branches of the river Atta-yen (Attaran); and in reading the account which Dr. Richardson gives of his travels, one would suppose that at this place the summit of the range can hardly be less than 1500 feet above the sea-level: yet he does not say that he traversed it by a mountain-pass. The southern part of the range, when seen from the Gulf of Siam, presents only a succession of peaked mountains, of which some appear to rise to the elevation of 3000 feet. The Siamese give to these mountains with some propriety the name of Sam-roi-yot, which means in their language 'the 300 peaks.' Two roads are said to have formerly been used in crossing this part of the chain; and it is certain that the chain terminates, or rather has a great depression, at the sources and upper course of the river Pakcham. This river runs from north-east to south-west, and is navigable for large boats to Karaa or Pakcham, about 40 miles from its source. To the east of this place runs another river in an opposite direction, which falls into the Gulf of Siam, and is called the river of Choomphon, from the place where it reaches the sea, or Telimfoung, as Dr. Helfer heard it named by the natives. The interval between the navigable parts of these two rivers, occupying a space of about six hours' march, or 30 miles, is a level tract. It is even stated that at high tides the rivers rise so as to inundate this tract, and to mingle their waters; but Dr. Helfer, who visited the place, does not mention this circumstance, and it seems to have been stated on very slender authority. As far as it is known, this chain is chiefly composed of granite and gneiss. These mountains are scarcely ever very precipitous, and are generally rounded near the tops, which rise in gentle declivities. The surface of the rocks is generally decomposed and covered with vegetation; a bare rock is rarely seen. Only a few spots are occasionally cultivated by the Kareans, who are in exclusive possession of these wildernesses.

Surface, Soil, and Rivers.—The general character of the country is hilly, and in some places even mountainous.

but there are also plains of considerable extent and some wide valleys. The degree of fertility which the soil possesses cannot be determined with any certainty, as only a very small portion of it is under cultivation; but we are inclined to adopt the statement of Dr. Helfer, according to which these provinces are much superior in fertility to the Malay Peninsula, by far the greater part of them being really fertile, or capable of being made productive. He thinks that the unproductive, sterile, or unavailable lands are less than one-fourth of the whole; and he ascribes the fertility not only to the natural constituents of the soil, but partly also to the quantity of humus or decayed vegetable matter which has accumulated through centuries, as the whole country is an uninterrupted forest, the greater part of which has never been felled.

The Northern portion of Tenasserim we shall call the Region of the Atta-yen (Attayan), as this river drains the most fertile portion of it, and its valley must soon become the centre of a considerable population. This region comprehends the whole of the country as far south as 15° N. lat., or the districts of Amherst and Yee. The most northern districts are mountainous. Along the southern banks of the Thoung-yin, which forms the northern boundary of Tenasserim, runs a mountain-chain, which, as far as it is known, constitutes a continuous ridge. It is called Bo-Thoung, and rises to more than 2000 feet above the sea-level. It is composed of sandstone, limestone, and clay-slate, and its declivities are very steep. In some parts it is overgrown with forests of bamboo. It is not known how this chain is connected with the Thown-gee Mountains, and the upper course of the Thoung-yin river is equally unknown.

The country south of the Bo-Thoung, adjacent to the river Salween, and to the distance of 50 miles from it, for the more inland parts are not known, is a plain, which however contains numerous masses of rocks, composed chiefly of limestone and sandstone. These masses are isolated, but they are disposed in lines running north-north-west and south-south-east. Some of them rise to the height of 2000 feet above the sea-level, but in proceeding southward they sink lower, and on the banks of the Atta-yen they rarely exceed 600 feet. Their structure, especially that of the limestone rocks, is remarkable, as the sides generally are almost perpendicular, and consequently bare, except in a few places, which are not so steep, and where some stunted trees or shrubs grow. No level ground occurs on their top, where they are also quite bare. On their sides there are numerous chasms and caverns. In the southern districts the number of these isolated masses decreases. The tracts of land surrounding their bases are distinguished by fertility, the soil consisting of fine black loam. The remainder of the plain is much less fertile, the soil being composed of an arenaceous clay mixed with a small portion of saline and vegetable matter. The forests which cover the plain contain only trees of moderate size, and there is no underwood.

Within the country just described there is an extensive alluvial tract, which occurs where the three rivers Salween, Gyeng, and Atta-yen join. The principal of these rivers is the Salween or Saluen, generally called by the natives Than-Lweng: it originates in the south-western part of Proper China, in the province of Yun-nan, or farther to the north; for its upper course is not known: in China it is called Noo-kiang and Loo-kiang. Running in a generally southern course, it is supposed to form the boundary between the Shan States (Laos), which are subject to Siam, and the Birman empire. This part of its course is not known. At the mouth of the Thoung-yin it begins to separate Tenasserim from Birma, and this is the only part of its course which has been investigated. Though at this point the river is only about 100 miles from its mouth, and has a great volume of water, it is not navigable. The limestone and sandstone rocks, which are very frequent in these parts, cross the bed of the river, and form several ledges, over which the current rushes with great impetuosity. Near Towng-bio-nyo, about 17° 30' N. lat., the rapids are so strong as to prevent every kind of navigation except perhaps during the north-east monsoon. There are several other rapids, though less dangerous, farther down, and they cease only at Colon Island near 17° N. lat., where the river divides into two channels. The eastern channel alone is navigable. The island is rocky, and about 10 miles long, but only about two miles wide in the widest

part. Even below this island the banks of the generally bordered by limestone rocks; and the navigation is very dangerous, owing to the force of the current, and the numerous eddies produced by the depth of the bed of the river, which in these places is very deep. A boat once drawn within the vortex of a pool is inevitably lost; both boat and crew are carried down, and never known to make their appearance.

The Atta-yen or Attaran is known up to the very source. Its principal branch originates to the east of the Three Pagodas in the Thown-gee range, and is called Zimee. It flows north or north by west, and is a deep river, for even at a short distance from its source it is three feet deep, and this depth increases as it flows farther down, where it is joined by numerous smaller branches from the Thown-gee range. The current is very strong, and hence it is used for floating down teak timber. At the mouth of the Atta-yen, about 70 miles from the mouth of the Zimee, the river is joined by the Way-nio, which comes from the south. After the confluence of the two branches, the river is called Atta-yen. This river has a very winding course, and the current is hardly perceptible. As the tide here rises to 19 or 20 feet, advances more than 10 miles above the confluence of the Zimee with the Way-nio, it is very probable that the whole fall of the Atta-yen amounts to 50 miles, if all its bends are taken into account, does not exceed 12 feet. The river is very deep, and in its lower part no bottom is found with 9 fathoms.

The Gyeng or Gain comes from the east, but its course is imperfectly known. It is a broad river in its lower course, but is shallow and full of sand-bar.

These three rivers unite nearly at the same place, about 30 miles from the open sea, and by their confluence form a broad sheet of water, which is about 15 miles long, running north-east to south-west, and from five to six miles wide, and interspersed with numerous wooded islands. The expanse of waters is separated from the sea by a narrow island called Phulloo-gewn, or, according to the natives, Balú. This island is about 20 miles long, and of moderate width. A chain of low sandstone hills runs across its length, never exceeding 200 feet in height. Two-thirds of the island are covered with low mangrove jungle, and it forms only a narrow belt, which is traversed by several creeks that penetrate several miles into the interior. On which behind the mangrove jungle there are hills which extend to the hills and are covered with rice. The water which is collected above this island runs to the sea by two channels, of which the western runs due south and is about 20 miles long, and is called the Martaban river. The navigation of this river is not more than two fathoms at several places, and there are many sandbars. It does not appear that the channel north of the Phulloo-gewn is visited by large vessels.

The country which surrounds the expanse of water where the three rivers disembogue is interspersed with limestone hills, but the intervening plains are covered with a thick layer of alluvial soil. The banks of the three rivers are covered with mangroves, and are not used for agricultural purpose, but at a short distance from the water's edge the alluvial plains are destitute of mangroves, and exhibit a very considerable degree of fertility, producing rich crops of rice where they are cultivated. This rich agricultural tract extends to the confluence of the Zimee and Way-nio rivers.

The country drained by the Zimee is also a plain, but is much higher than that of the Atta-yen. The banks of the first-named river rise to 20 feet above the level of the sea, whilst those of the Atta-yen are very low, and are subject to inundation during the rains. The plains of the Zimee river are nearly a dead level in their lower districts, but no limestone hills occur above the confluence of the Zimee with the Way-nio rivers; but in proceeding farther south the plain country becomes undulating, and in approaching the Thown-gee range it is broken by numerous small hills, though it cannot be called mountainous. This tract is covered with a deep layer of clay of considerable fertility, and the country contains extensive tracts of rice, which the teak-tree grows to a large size. But there are also tracts of less fertility, where the soil is very

l with small nodules of ironstone: such tracts are overgrown with bamboo jungle, and are the numerous elephants, rhinoceroses, and other wild

entry between the Atta-yen river and the sea is by ridges of sandstone hills about 500 feet high. It runs in continuous swells as far south as $14^{\circ} 30'$. This tract, whose surface is strongly undulating, is without fertility, owing to the aridity of the soil, which lacks moisture. It is chiefly covered with forests, as thick according to the depth of the soil. In places the rocks approach the surface, and have only a thin layer of earth over them, and in such places there are few bushes, and patches of grass which soon dry in the rains. This tract contains two small rivers, and two harbours. The most northern, called Kal-yen, is on the sea east of the new town of Amherst, and constitutes the harbour. On its bar, which is of about 2 fathoms and a half of water at low tide, there are two fathoms and a half of water at low tide, and as far as 8 miles up, it is 12 fathoms and a half and five fathoms deep; and near the mouth from 400 to 500 yards wide. It thus forms a harbour, which most merchant ships can enter at neap-tides, and at high-water ships of any size. Near $15^{\circ} 12'$ is the mouth of the Yee river, which discharges into the gulf, but it is too shallow to admit large merchant ships may sail up to the town of Yee, about five or six miles from the river's mouth.

The tract east of the sandstone tract, and surrounding the town of Vay-nio and extending to the Atta-yen, is the eastern part of Tenasserim. The vegetation is stunted, and at part of this tract is covered with bamboo forest. The soil is an argillaceous transition schist, unmineralized, and contains particles, which quickly absorbs all moisture.

The basin of the *Tenasserim River* comprehends the greater portion of the country, extending from 15° to 12° N. in the northern districts, as far south as $13^{\circ} 30'$, presenting an uneven surface. Several ridges of hills traverse the country from north to south: they consist chiefly of granite and gneiss, and rise to a moderate elevation. They are gently rounded near the tops, and their declivities are gentle. The valleys which are inclosed by them are of moderate width, and fertile. The decomposed particles of the adjacent rocks are washed by the rains from the hills, and deposited at the bottom of the valleys, where they are mixed with a large quantity of detritable matter, which makes a rich soil. Level tracts of great extent are rare: the largest are near the town of Vay-nio and at the foot of the Thown-gee range, where an elevated table-land occurs, called *Meta-mio*. These plains consist of clay or loam, with little iron, and is very fertile.

The northern districts resemble the northern, except the mountain ranges, which here also run north and south, and occupy a much smaller portion of the surface, the plains are more numerous and of greater extent. The largest rivers which occur along the sea-shore, but especially the *Tenasserim*, which is many miles in length, and extends along the left bank of the sea above the town of Tenasserim. It is covered with a deposit of argillaceous marl of great depth and fertility. The fertile is the extensive alluvial tract which is divided into the several branches into which the *Tenasserim* divides before it reaches the sea, and which occupies the greater part of the islands which lie between the coast and the sea. A part of this alluvial tract is unfit for cultivation, being inundated at high-water, and covered with groves. The whole region is overgrown with bamboo, with the exception of a few spots which are uncultivated.

The most important river of this region is the *Tenasserim*. According to Low, it rises near $15^{\circ} 30'$ N. lat., but various facts render this improbable, and its sources are shown in our maps south of 15° N. lat. It flows in a westerly direction over nearly three degrees of latitude than 200 miles in a straight line. The upper course is interrupted by numerous rapids and cascades, which occur even farther down, and as far as $13^{\circ} 15'$, the most rapid are. To this place the tides of the river still has a rapid current, numerous annually changing banks, and shifting shoals. In the dry season it is impracticable for boats drawing more than 17 inches. It becomes deeper at its confluence

with the Little Tenasserim, or *Khioung-gale*, which joins it at its most southern bend, and brings down a large volume of water from the *Sam-roi-yot* range. Up to this place, where the town of Tenasserim is built, the river is deep enough for vessels of 100 tons. At the same place the *Tenasserim* turns to the west, having passed between two high hills to the north-west. Soon afterwards it begins to divide into two arms, which in approaching the sea again subdivide, so that, according to the survey of Captain Lloyd, it reaches the sea by six or seven channels. There are sand-bars across these channels, but the bar which is found on the channel south of the town of Mergui has depth enough for vessels of moderate size at high-water, the tide rising between 14 and 15 feet. Below the town of Tenasserim the river still runs above 40 miles in a straight line. Its whole course is about 240 miles.

The river *Tavoy*, which originates near 15° N. lat., runs first to the south-west, but turns gradually to the south, so that its lower course is parallel to the shore. The wide estuary by which it is connected with the sea reaches to $13^{\circ} 30'$ N. lat.; the whole course of the river in a straight line is not less than 100 miles. It is stated that the tide, which rises from 13 to 14 feet, runs up more than 50 miles from the sea, and that to this distance the river may be navigated by boats, though the navigation is rendered difficult by numerous low islands and shoals. The town of *Tavoy* is about 35 miles from the sea, and so far vessels of 120 tons burden may ascend. There is no bar at the entrance of the river, but the navigation is intricate, owing to the numerous shoals and low islands, as there are various channels among them which in some places have only 2 or 2½ fathoms, but in most parts the depths are from 6 to 12 fathoms. There is good anchorage on the east side of *Tavoy Point*, which is on the west side of the entrance of the river, in 6 fathoms, on a soft even bottom, and it is well sheltered, except against southern winds.

The *Southern Region* of Tenasserim, or that which lies between 12° and 10° N. lat., is situated on the long isthmus which connects the Malay Peninsula with the main body of Asia, and is known as the *Isthmus of Kra*. It is the least known part of Tenasserim. Dr. Helfer, who lately investigated its geology and minerals, found it uninhabited, with the exception of a few spots, and from his observations it appears that the whole country is covered with high hills, and contains only a few small valleys. The soil does not appear to be distinguished by fertility, and it may be conjectured, that with the *Isthmus of Kra* that sterile tract begins which extends over the whole of the Malay Peninsula to its most southern extremity, and which, though favourable to the growth of fruit-trees, produces only scanty crops of rice and other grain. The inhabited places of this tract are almost exclusively confined to the banks of rivers, and do not extend far inland. The rivers, though they have not a long course, are said to be large and navigable to a considerable distance from their mouths. The largest are, from north to south, the *Lenya*, the *Bockpyn*, and the *Pakcham*. The last-mentioned river, which divides Tenasserim from Siam, has already been noticed.

Climate.—Like all other intertropical countries, Tenasserim has only two seasons, the dry and the wet season. They depend on the monsoons, the rains being produced by the south-west monsoon, whilst the dry season lasts during the north-east monsoon. There appears to be some difference in the wet season between the climate of *Maulmain* and of *Mergui*, the only two places in which a few meteorological observations have been made, and this difference appears to depend on the circumstance, that along the southern coast the effects of the south-west monsoon are diminished by the elevated islands of the *Mergui Archipelago*, whilst farther north they reach the land in all their force. At *Maulmain* the rainy season sets in towards the end of May or the beginning of June, and during the first three months the rains are heavy and nearly incessant, but they gradually diminish in September, and entirely cease in October. This is the hottest part of the year, but the heat is far from being so oppressive as on the coast of *Coromandel*. In May the thermometer averages at 8 o'clock in the morning 78° , and at 4 o'clock in the afternoon 82° , in June it keeps at 72° at 8 o'clock, and at 76° at 4 o'clock, and in July and August at 77° at 8 o'clock, and at 80° at 4 o'clock. The thermometer has never been observed to rise above 90° . The difference

between the temperature of the air in the day and at night is remarkable, as the thermometer is often found at 65° at sun-rise, even in July. In the dry season the thermometer varies between 60° and 80°, and the weather is very constant, rain rarely falling, and only in short showers. The heat is moderated by the sea and land breezes, which blow very regularly in this season.

At Mergui the rainy season sets in towards the end of April or the beginning of May, and lasts to the month of November. During the first two months the rains are moderate; but from the middle of June to the beginning of September they are heavy, when they again begin to abate, and gradually to diminish. Rain falls also during the dry season, but only in showers, which occur at intervals from four to six weeks. The greatest heat occurs before the rains, and in the first two months after they have set in, but it is stated that the average temperature of the six hottest months does not exceed 84°. Land and sea breezes are regular during the dry season. At some places in the interior, which are considerably elevated above the sea, as the table-land of Meta-mio, the climate is some degrees more temperate than near the coast.

The climate is considered very healthy. This opinion is confirmed by Dr. Helfer, who lived there many years, and who says that it is the most healthy of all known tropical countries for Europeans; and he supports his opinion by the statement that the lists of mortality kept by the medical gentlemen of the European British corps stationed at Maulmain and its dependencies show that the rate of mortality scarcely ever exceeds and is sometimes less than it would be under similar circumstances in Europe. This is the more remarkable, as many of the adjacent countries, and especially Aracan, which resembles Tenasserim in nearly every respect, have acquired a bad name for their insalubrity. Helfer cannot account satisfactorily for this phenomenon. He finds no other reason than that the country is either part of a narrow peninsula or immediately adjacent to one, and that the extensive seas on both sides produce a constant though not always perceptible current of air, by which the noxious vapours that rise from vegetable matter and other elements of malaria are either destroyed or carried away. Even the exposure to the sun is rarely attended by bad effects, and the climate does not produce languor or mental inactivity, which is partly to be attributed to the coolness of the nights.

Productions.—If the value of a country were to be estimated by the number of marketable articles exported from it, Tenasserim would certainly be one of the least valuable. For, if a small quantity of rice and some teak timber are excepted, hardly any article worth mention has been exported from that country up to the last few years. But it vies with any country on the globe in the varieties of its natural products, and when cultivated it will export almost every article which belongs to tropical countries.

Though the greater part of the country has not been explored, it is known to be rich in minerals. Gold is found in some of the rivers, but in small quantities. A silver-mine exists in the range of the Bo-Thowng, but its value is still doubtful. It has lately been ascertained that there is copper-ore in the north-east portion of Sullivan's Island, and on the island of Calla-gkiank, near Mergui. Tin is the only metal which has ever been worked. The tin-mines are about one day's journey to the east of the town of Tavoy, and in the vicinity of Mergui. But Dr. Helfer, who has explored the southern districts, states that the range of hills which runs north of the Pakcham River is the richest in tin-ores, the grains or crystals being sometimes of the size of a pigeon's egg, and the layer in which they are found being 8 or 10 feet thick. It is however difficult to work these ores, as the contiguous country is entirely uninhabited. Tin-ore is also found on the banks of the Bokpyn river and on Domel Island. The richest deposits of tin-ore are probably yet unknown. Iron-ore of good quality is found in abundance in the vicinity of Tavoy, and at several other places farther south, especially in the districts south of the Tenasserim river. Antimony occurs in the neighbourhood of Maulmain. Extensive coal-measures have been lately discovered in several places on the banks of the Tenasserim river. The coal is generally of good quality, and the best kind is near the banks of the river below the last rapids, so that it can be brought to Mergui at moderate expense. Three or four years ago this mine began to be worked at the expense of

the East India Company. It is thought that some of these coal-measures will have some effect on the navigation of the Gulf of Bengal and the S. laccas. Limestone and marble are common in the districts.

Rice constitutes the principal object of culture; it does not appear that irrigation is practised, and only one crop is taken. Wheat is cultivated at a small scale. Other objects of agriculture are chilies, yams, sweet potatoes, plantains, and sugar-cane, indigo, and tobacco are only for domestic consumption, and also cotton, which is of an inferior quality. It is thought that these last articles could be raised to a great extent if there was a demand for them. The trees which are cultivated the most important are the palm, which succeeds well as far north as Ava. Since the occupation by the British, the natives have begun to cultivate it on an extensive scale, and it yields a large article of export if the fruits should continue to be used in Europe for the preparation of oak-bark and sumach. Of late years coffee-trees, and clove-trees have been introduced, and both thrive well, and promise to remunerate the cultivator; but the success of the clove-trees is still doubtful. The produce of the coffee-trees is compared with that of Java. Nearly all the delicious coffee grows in the Malay Peninsula and the Indian Archipelago may be raised in Tenasserim. The durian is raised in 16° N. lat., and is exported to Rangoon and Ava. The mangosteen has lately been introduced, and thrives well, but only south of 13° N. lat. Pine-apples, guavas, and oranges also succeed. Some parts of the arnotto (*Bixa orellana*) are raised in plantations are rather extensive near the sea. The nipah palm (*Nipa fruticans*). The toddy of the latter contains more saccharine matter than that of the former. Nearly the whole of Tenasserim is covered with trees, which are not much used at present. The countries surrounding the Bay of Bengal are cleared of such forests, and the demand for timber is increasing, they will soon be considered as a source of wealth. Extensive forests of teak-trees still remain on the banks of the Attayen, and furnish at present a very important article of export. A small number of boats are annually built by Chinese at Mergui and the Hopea odorata, which is also employed in the construction of small craft. Timber-trees, except the teak, belong to the cas, and Shoreas; the most numerous are the carpeæ, which attain an enormous size, but are of inferior wood. All these trees when full grow to 70 to 120 feet in height, rising with a straight trunk 60 feet high, and before they throw out any branches have a circumference of 10 to 30 feet. In the mountains the natural productions which are not cultivated are various kinds of trees yielding caoutchouc, gamboge, sassafras, cajeput-oil, different gums, oil, black varnish, sandal-wood, dammar, and other substances, several dyes, aloes, and sapan-wood. Mum-plants are said to be found in the most eastern boundary, and hemp grows wild on the islands. Large tracts are covered with rattan and bamboo begins to be exported, having a superior quality to that grown in the neighbouring countries. On the Sam-roi-yot range there is a wood, called by the natives callame, which grows down to Mergui, and there shipped for Rangoon.

Domestic animals are not numerous, with the exception of buffaloes, which are large. As to wild animals, Dr. Helfer observes that as Tenasserim constitutes a peninsula, the bridge by which the continent of Asia is joined to the Indian Archipelago, its zoology possesses some peculiarities to these two great natural divisions of Asia. The number of species common to Hindustan is comparatively small, but in the districts of Tenasserim there are many species peculiar to the countries east of the Brahmaputra, even several of Bhoon and Nepal; and in others which have hitherto been exclusively Indian Archipelago.

There are five different kinds of quadrumanous animals, of which *Cercopithecus* belongs to the rarest animals.

found in the northern districts, on the isolated rocks. The Malay bear occurs in the more southern parts as far north as 13° N. lat. The royal and in great numbers, and is very strong and it is said that it rarely attacks men. The black marten is common. There are also leopards and wild-cats. They are numerous, and they have a wide extent of range in. They are killed and eaten by the natives to bring their teeth to Maulmain. The rhinoceros is common, and all the known Asiatic species. The Malay tapir, called by the natives the 'tiger', is found in the most southern districts. The tiger is common, and also the Sus Babiroussa. There are numerous: *Rusa Hippelaphus*, *Elaphus Cervus Aristotelis*, *C. Axis*, and *C. Muntjac*. Two other species, are known to exist. The rhinoceros and *Domesticus* are both in a wild state; the Bisons, the great *Gaurus* is rather rare, but the rhinoceros is very common. A variety of *Cinnyris*, *Alcedo*, in its splendid plumage and diminishes the humming-birds. Four species of *Alcedo* in colours the species of Java and Australia. The peacock is abundant in the interior near mountains. There are five species of parrots. The Phasianus, the origin of our domestic fowl, is very common in the jungle, and the native breed is kept up by eggs from the forests. The *Hirundo esculenta* is common on the cliffs along the southern coast and the islands of the Andaman Archipelago, and a considerable number of them are annually collected and exported by the natives. There are several species of hawks, falcons, and vultures. There are five kinds of pigeons, some of which are very common. Fish is abundant between the islands of the Andaman Archipelago, where an extensive fishery is carried on by the Malays, and Chinese, who prepare fish which is done by spreading it over a framework of bamboo poles, and drying it in the sun: it is also daily sold in the market. No salt is ever employed in the fish: some kinds of fish are smoked. In these fish are also shrimps, prawns, &c., of which balapang is made, which is an article of commerce. The *halas* are frequently seen among the islands of the Andaman Archipelago, and a little oil is got. There are also *halas*, which were formerly fished, but an attempt was made for that purpose some years ago was not successful. Balapang is one of the principal objects of fishery. Pearls, mother-of-pearl, and ambergris are collected in great quantities by the Seelongs. Wax and resin are also an important article of internal commerce, and also exported. There are said to be five different kinds of wild bees, two of which are without stings. They are numerous, but only a few kinds are poisonous. —Helfer estimates the population of Tenasserim at about 100,000 individuals, and consequently about three to a square mile. Though this population is very small, it consists of very different races, and we find different races mixed. This is chiefly owing to the frequent conquests to which the country has been subjected since the time when it was first discovered by Europeans. In the last two centuries the Malays, and Burmese have alternately and more or less possessed Tenasserim. These nations appear to have pursued a policy which we find mentioned in the historical records of Western Asia, namely, the migration of the inhabitants of one country to a great distance from it.

The population consists of Birmans, Thaliens, Siamese, and Karians or Karens. Though the Birmans have some physical features which belong to the Chinese race, yet there are others which indicate their affinity with other races has taken place. They approach nearest to the Chinese: they have a small nose, prominent cheek-bones, black hair, and thin lips, and a colour more or less like the Birmans and Thaliens are half Malays and half Chinese, and the Karians half Malays and half Chinese. The features of the Karians approach so much to the Caucasian form, that many of them have a high forehead, and the European facial angle. The resemblance to the Caucasian race seems one of the reasons which has led some American Baptist missionaries to call the Karians as the lost tribes of Israel.

who were the lords of the country up to

the peace of Yandabo, are still the most numerous. They are settled in the plains on the rivers Atta-yen and Gyeng, in the vicinity of Mergui, Tavoy, and Yee, either near the sea-coast or on the banks of navigable rivers or creeks, and never far inland. They are healthy, strong, and muscular. Their principal occupation is agriculture. They are indolent and self-conceited; but honest, polite in their manners, and neither passionate nor revengeful, by which they are distinguished from the Malays. They are Buddhists, and consider the sovereign of Ava as the head of their religion: they are quiet subjects. The children are placed at an early age in monasteries, established in almost every village, and endowed by the voluntary contributions of the inhabitants: the children remain here for a certain time, during which they are fed by the monks, and instructed in reading, writing, and religion; and thus elementary knowledge is more generally diffused among the lower classes than in most countries of Europe; but the knowledge of the higher classes is not much greater. The knowledge of their priests is limited to the explanation of theological and metaphysical doctrines. The missionaries have hitherto failed in their attempts to convert them to Christianity, with the exception of a few isolated instances, where Birmans have nominally become Christians for the sake of worldly gain. This want of success is not to be ascribed to fanaticism or obstinacy on the side of the Birmans, but to their religious dogmatical indifference. They admit the beauty of the Christian morals, but contend that theirs are equally good; and with reference to the dogmas, they say that the Christian religion is as unintelligible as the Buddhist.

The Thaliens or Peguans do not differ in physical constitution from the Birmans, and their separation into two nations might be considered merely a political one, as they had formerly two different governments, if it were not that the Thaliens speak a different language, which is said to have scarcely any resemblance to that of the Birmans. But this language is fast declining, as the greater number of the Thaliens speak the Birman language, which has been adopted as the language of the courts, of public transactions, and of general conversation. The Thaliens are likewise Buddhists, and participate in the education provided by that religious establishment. Their chief and almost sole occupation is agriculture, and rice is almost the only object of cultivation. A small number of Thaliens were settled on the Atta-yen previous to the occupation of Tenasserim by the British, but a much greater number have emigrated since that event. Having shown during the war a great partiality for the British, they feared the vengeance of the Birmans when their country (Pegu) was restored to that nation, and took refuge in Tenasserim, where they settled in the vicinity of the new settlement of Maulmain, where there are at present twenty Thaliens for one Birman.

When Tenasserim was subject to the king of Siam, the Siamese were very numerous, but after their conquest by Alompra they retired from these provinces almost entirely, except the districts south of Mergui, where a number of them remained on the banks of the rivers Lenya and Bok-pyn, that part of the country having always remained a disputed district. The security and equitable administration introduced by the British have attracted a considerable number of emigrants from Siam, who have formed settlements in several parts of the country, especially on the banks of the Greater and Lesser Tenasserim rivers. They are, according to Helfer, an industrious, hardy race, and more enterprising than the Birmans, besides being quiet, obedient, and orderly. He thinks that their immigration in greater numbers would be a desirable accession in the wilds of Tenasserim. They have introduced the cultivation of the sugar-cane for the purpose of making sugar, which art they have learned from the Chinese who are settled in their country, though this cultivation has not yet become important. Many of the Siamese are hunters by profession, living for months in the wildest forests, where they shoot elephants for the ivory; they are also the trappers, tamers, and managers of elephants in general. Under the Birman rule few elephants were tamed, but at present the practice is becoming more general through the Siamese, in whose country elephants are the most important of domestic animals.

The Karians occupy exclusively the country adjacent to the mountain-range which divides Tenasserim from Siam,

never being found near the sea-shore. They are said to be the same nation which occupies several mountain-tracts in Birma, and is dispersed over the delta of the Irawaddi [BIRMA, vol. iv., p. 440], and to support this opinion it is affirmed that the Birman Karians bordering upon China, at the distance of 13 degrees of latitude, speak a dialect of the same language which is current among the Karians of Tenasserim. This fact requires to be confirmed, for in other respects these nations differ greatly in habits. In Birma the Karians are the most industrious cultivators of the soil, and manufacture several kinds of cotton and silk cloth, but those of Tenasserim are an agricultural people without any fixed habitations, migrating every second or third year. When a Karian family has chosen a place for a plantation, huts of bamboo thatched with palm-leaves are constructed, and a part of the forest is cleared, just as much as is necessary to plant the ground with rice sufficient to maintain the settlers for a year. The paddy is sown upon the ground, which is imperfectly cleared, without any tillage or other preparation, and whatever else is wanted (cotton, indigo, sesamum, vegetables, &c.) is sown or planted promiscuously on the same spot. The following year another spot is cleared in the vicinity, and after some years, or when a death happens, the family removes to a greater distance, and begins again the laborious task of felling immense forest-trees, visiting only from time to time the old establishment, which yet yields fruit for several seasons, and thus the Karian wanders all his lifetime without ever settling permanently. It seems however that an improvement in the condition of the Karians is taking place. Their religion is heathenism. They believe in evil spirits, called nats, which have a direct influence on the destinies of mankind, and they try to propitiate them by sacrifices of fowls, tobacco, rice, and pieces of money, which they deposit at certain places. The attempts to convert them to Christianity by the American missionaries have been successful. A tribe of the Karians, called the Red Karians, inhabit the mountains north-east of Maulmain, and these mountaineers are said to live by robbery.

The Seelongs are the lowest in civilization among the nations of Tenasserim. They are confined to the islands of the Mergui Archipelago, and are a race of wandering fishermen, who build temporary huts of reeds, palm-trees, and bamboos, during the inclemency of the monsoon, and pass the rest of the year either in boats or on the sea-beach under the shade of trees. They never cultivate the ground, but live upon the spontaneous products, chiefly turtles, fish, and shell-fish, which form their principal food. They have a peculiar language, but too little is known of it for us to determine whether it is a mixture of languages or a peculiar tongue. They form a petty tribe, not exceeding, it is said, 1000 souls in number, and it is very difficult to meet them in the islands which they visit, as they hide themselves whenever they see a strange sail approaching. This is probably the effect of their having suffered much from the pirates, who, until lately, infested those seas, and it serves to explain the statement of the early European navigators, who landed on these islands, and found them uninhabited. The Seelongs have a vague idea that there are certain invisible beings which exercise an influence over the destinies of mankind, but there is no established mode of worship, and they are entirely ignorant of a future state. No attempt has yet been made to convert them.

Helfer reports, that among the natives the opinion is general that in the most mountainous part of the country there is a race of wild men, who shun all intercourse with their neighbours, and seem to be hardly superior to monkeys. He is much inclined to think that these wild men are the gigantic orang-outang of Sumatra. But the Andaman Islands are inhabited by a puny race of men, the lowest in the scale of intellectual beings, which seems to belong to the race of the Australian negroes; and only a few degrees farther south, in the kingdom of Queda, a small tribe, the Samang, are found [MALAY PENINSULA, vol. xiv., p. 327], who greatly resemble the inhabitants of the Andaman Islands. It is therefore not improbable that a small remnant of such a tribe may still exist in Tenasserim.

The Karians, Seelongs, and the last-mentioned race are probably aborigines: the others have emigrated from the neighbouring country. Many Chinese are settled in the sea-ports, where they are merchants, ship-owners, ship-builders, spirit-distillers, carpenters, blacksmiths, bakers,

and gardeners. A few of them settled who was subject to Birma, and others have occupation by the British. They are mar women, but their children, if males, are Chinese, and adopt the customs, manners, a fathers. There are also a number of Chu of Coromandel, settled in the places where reside, with whose customs and wants they acquainted than the natives, and by admiring they gain their livelihood. The same may Bengalees, who however are always inferior of the peninsula of Hindustan in enterprise. Their number is not great. As Tenasserim settlement for the British possessions in 1800 2000 convicts have been sent there, as they are treated with great mildness, and have been converted into useful men. Many of them have married, and on their banishment expiring have settled in the Maulmain a few Armenians and Parsees being the only place in Tenasserim where on.

The English settled in Tenasserim in official capacities, either civil officers of great military officers of the two regiments who here. The number of private persons is small, all of them are congregated in Maulmain chiefly engaged in ship-building, or other with the teak-timber trade. Besides a few first Missionaries, there are many descendants. By intermarrying with native women, they the advantages of European civilization, being nearly the same with that of the natives, but frequently much lower. Their steadiness in to their faith preserves them as a distinct race, also mostly preserved their language, but corrupted.

Towns.—In a country so little cultivated, and in which is dispersed over such an extent, there can be no large towns. When the British first entered the country they founded the town of Amoy at the mouth of the Martaban river, hoping that the population of the country would concentrate at that place. [HEURST, vol. i., p. 452.] But these expectations have never been answered. Maulmain, which was originally a military post, has since risen into importance, increasing, as its situation near the confluence of the Salween is the most favourable for trading on the trade in teak, which constitutes the most important article of export. Ship-building, which is carried on to any extent. The town is also small, but it has some commerce with the coast of Mergui. The town of Mergui has a safe and well-protected harbour. The distance between the mainland and Madramacan Island is from 6 to 15 fathoms, and the bay is sheltered from all winds. It is about six miles long. But vessels of moderate size can sail into the river, and anchor off the town. Though it is at present a small place, it is of great importance, as in the country at present the richest deposits of coal and tin have been discovered in the neighbourhood, and the cultivation of the plantations of spice-trees, and the Siamese have cultivated the cane for making sugar: it is a favourable opportunity for commercial intercourse with the countries of Siam which surround it. The name of Tenasserim, an ancient town, which was destroyed in the wars between the Siamese and the British, is in ruins, but will probably be revived, and a town will be built in the neighbourhood and the sloop navigation will be carried on to that place.

Manufactures and Commerce.—If we except the building of vessels and small craft at Mergui, and especially Maulmain, there is no manufacturing in Tenasserim; nearly the whole population is in a state of barbarism, and the degree of civilization in which it has not yet attained refinement and comforts, and articles of luxury are not much in demand. Such as coarse cloth, coarse china-ware, and iron tools, are brought by the Chinese from Bangkok, a gunpowder, and arms imported from Bencoolen, Penang or Calcutta. There are also im-

from Rangoon, and spices and sugar from chief exports are teak and rice; there are ivory, wax, tin, nut-oil, trepang, edible and bamboos. The only places with which intercourse exists are Calcutta, Rangoon, and hoped that an overland commerce will soon

between Maulmain and the south-western China, especially Yun-nan, as caravans from usually visit the Shan States (Laos) north of and the merchants of the caravans manifested an intention to proceed to Maulmain, but failed by political circumstances.

Nothing is known of the early history of these when they were first visited by the Portuguese; places were much more thriving than they seems that at that time the bulk of the population of Thaliens, and probably the country of the kingdom of Pegu. It was affected with Siam, from which it was wrested by the founder of the present Birman dynasty, in the middle of the last century. Notwithstanding contests and incursions of the Siamese, it remained of the Birman empire until it passed into the British by the peace of Yandabo (1826). The population was estimated at 50,000 individuals; it probably considerably exceeds the former part of the government of Penang.

Journal of an Embassy to the Court of Ava; Observations, &c. in Asiatic Researches, vol. xviii.; *Geography to the Mergui Archipelago*; Helfer, *Notes on the Tenasserim Provinces*, and its insertion in the *Journal of the Asiatic Society* 1840; Foley's 'Notes on the Geology, &c. in the neighbourhood of Manlamyeng,' *Journal of the Asiatic Society of Bengal*, 1836; Richardson, *Journal of a Mission to the Court of Siam*, in the *Asiatic Society of Bengal*, 1840.)

[WORCESTERSHIRE.]

PEMBROKESHIRE.]

fresh-water fish belonging to the family Cyprinidae. [TINCA.]

A tender is the offer to perform some act, generally consists in an offer to pay money to a party indebted, or who has done some injury, or to the party injured.

The amount of forty shillings may be made beyond that amount it must be in gold. If a tender of a larger amount in silver, or in banknotes, is taken at the time to the meeting it is made, the objection to the tender on the tender will be held to be waived, and the tender will be good for the full amount to which it is made. The tender must be actually produced and shown, or the offer of other thing which contains it shown to the creditor; it is intended to be made, unless it is made by some declaration or act by the creditor. The creditor, upon with such strictness, that even though the creditor that he is about to pay him so much, and put into his pocket to produce the money, or to leave the presence of the debtor before the money is actually produced, no tender will have been made unless the creditor refuse to receive the money men- tioned that it is insufficient in amount, the tender is not necessary to constitute a tender.

The offer must be absolute and without condition; an offer of a larger amount with a request of the creditor with a request of a receipt, or on condition that the thing shall be done on the part of the creditor, is not a valid tender; but an offer of a larger amount without a demand of change is good. A tender is made either to the party actually entitled to the money, or to an agent or servant authorised to receive the money; a managing clerk; and a tender will not be good unless it is made the creditor has put into the hands of his attorney and the creditor refuses to receive it, assignment is not a reason for doing so. If the creditor refuses to receive the money, a tender made to him or to his managing clerk at the time when it is made they disclaim to receive the money. A tender ought to be made by the party from whom the money is due; or by a party appointed by him to make the tender offer for him.

a larger sum than he is authorized to do, the tender will nevertheless be good for the full amount to which the tender is made.

If the defendant in an action plead a tender, he must state that he has always been ready to pay the money, and he must also pay it into court. The effect of the plea is to admit the existence of the contract or other facts stated in the declaration which form the cause of action in the plaintiff. The plea goes only in bar of damages. The plaintiff therefore in such case can never be nonsuited; but if issue is taken on the mere fact whether or not the tender has been made, and that fact is found for the defendant, it is a good defence to the action.

By various statutes, magistrates, officers of excise, &c. are empowered after notice of action to be brought against them, to tender amends; and if the amount tendered is sufficient, the tender is a defence to the action.

TENDON, or Sinew, is the tough white and shining tissue by which muscles are attached to the bones or other parts which it is their office to move. The name of tendons however is generally applied only to those which are thick and rounded, and which serve for the attachment of the long round muscles, such as those of the biceps muscle on the front of the upper arm: those which are broad and flat, and which serve for the attachment of the membranous muscles, are commonly called aponeuroses. But whatever be the external form of a tendon, its intimate construction is the same, being chiefly composed of the same fibrous or tendinous tissue of which a large class of organs, including the ligaments, fasciæ, periosteum, and several others, consist.

The fibrous or tendinous tissue is of a peculiarly glistening bluish-white colour, dense and tough, nearly insensible, not vitally-contractile, and very little elastic. It is composed of bundles of delicate fibres, which are united by cellular tissue; and each fibre is made up of several fibrillæ, or filaments, which are discernible only with the microscope. The filaments are transparent and cylindrical, with well-defined outlines: they vary in diameter from $\frac{1}{3000}$ to $\frac{1}{1000}$ of an inch, and, though they have a generally straight direction, are finely undulated. The tendinous fibres are from $\frac{1}{100}$ to $\frac{1}{200}$ of an inch in diameter; the filaments are arranged within them in parallel lines, and are connected by a firm substance, in which no distinct structure can be discerned. The bundles of the fibres are arranged in various plans in the different tendons and aponeuroses: in some, they are parallel; in some, interlaced or variously woven together; but their arrangement is always such that they possess the greatest force of resistance in the direction in which the muscle acts upon them.

The tendons, like the other fibrous tissues, are composed of a substance slowly yielding gelatine by boiling. A large quantity of the ordinary glue of commerce is obtained by boiling down the tendons and ligaments about the feet of horses. They contain about 60 per cent. of water; and when dry become hard, brittle, yellow, and transparent. In vital properties they are distinguished by a very low degree of sensibility. No pain is excited by the application of stimuli; but when stretched or twisted, the dull aching pain is produced, with which most persons are acquainted as characteristic of a sprain. Their diseases are few and are peculiarly slow in their progress.

The chief differences of appearance in the tendons depend on the quantity of cellular tissue interposed between the bundles of tendinous fibres. In the round tendons there is so little, that it is with difficulty demonstrated, and they are, in a corresponding degree, compact and strong. In the flat membranous aponeuroses the cellular tissue is much more abundant, and fills up large interspaces between the fibrous bundles. The more abundant the cellular tissue, the more numerous do the blood-vessels of the tendons seem to be. In the round compact tendons they are scarcely discernible; but when well prepared, the same arrangement is observed in them as in the blood-vessels of all the fibrous tissues; that is, they run in parallel lines between the fibrous bundles, rarely dividing into smaller branches, and communicating by short canals which pass transversely across the bundles. The blood-vessels of the tendon are chiefly derived from those of the muscle to which it is attached. In most instances a large branch runs across the line of boundary between the muscular and tendinous fibres, and gives off many smaller branches to the latter.

At that end of a tendon which is affixed to a muscle each primitive fibre or fasciculus of the latter [MUSCLE] terminates in an abruptly-rounded extremity, which is embraced by a fasciculus of the filaments of the tendon, expanding and enclosing it in a sheath, or in a manner which may be coarsely represented by placing the end of the fore finger of one hand within a circle formed by the ends of all the fingers of the other hand. The larger bundles of cellular and fibrous tissue in the tendon are also continuous with the cellular tissue which is placed between the secondary fasciculi of the muscle.

At their opposite extremities the tendons are usually affixed to bones. Their fibres are intermixed and firmly united with those of the periosteum, and often pass into the very substance of the bone.

Although the chief and proper office of tendons is to serve as media for the action of muscles, yet many of them fulfil other purposes in the economy. Thus the aponeuroses of the abdominal muscles form a great part of the walls of the abdomen, and, by their toughness, support and protect the organs within its cavity; the tendons of the muscles of the fingers add strength to each joint over which they pass; and many, in other parts, are arranged so as to act like ligaments.

TENDRAC. [TENREC.]

TENDRILS, or *Circhi*, are those elongated and filamentous organs of plants which possess a power of twisting in one direction or another, and by which the plants on which they grow are enabled to embrace other plants, and thus to elevate themselves. Tendrils are only found on those plants which are too weak in the stem to enable them to grow erect. In most cases the tendrils are only forms of the petiole; for although they may occur on the parts of flowers, yet the flowers must be regarded as metamorphoses of the leaf. Tendrils are distinguished according to the parts of the leaf from which they grow. When the tendril consists of the elongated petiole of a compound leaf, it is called a *cirrhus petiolaris*, as in the common pea. When, as in *Smilax horrida*, it branches off on each side at the base of the lamina into a twisting branch, it is called a *cirrhus peduncularis*. When it is extended from the point of a single leaf, as in the *Gloriosa superba*, it is a *cirrhus foliaris*; and when it occurs in the petals of a flower, as in *Strophanthus*, it is called *cirrhus corollaris*. Those tendrils which are in connection with the stem alone, as those of the passion-flowers and vines, are called *Campreoli*. The type of these organs however is the same in all cases. (Bischoff, *Wörterbuch der beschreibend-n Botanik*.)

TENEDOS (*Tenedos*), an island in the Greek Archipelago, off the coast of Troas, in 39° 47' to 51' N. lat. and 25° 58' to 26° 5' E. long. It is said to have been antiently called Leucophris, and to have derived the name Tenedos from Tennes, the son of Cyenus, king of Colone in Troas, who reigned over the inhabitants, and was afterwards deified by them. (Pausanias, x. 14; Schol. in Hom. *Il.* i. 37; and more fully Diodor., v. 83.) According to Homer (*Il.* xi. 624), it was sacked by Achilles, and occupied by the Greeks when they retired from the siege of Troy immediately before its capture. (Virg., *Æn.* ii. 21.) This connection with the story of the Trojan war has given Tenedos some celebrity. It was colonized by Æolians from Amyclæ in Laconia, under the command of Peisander and Orestes. (Pindar, *Nem.* xi. 45-6; Herod., i. 151.) Little mention is made of Tenedos in antient history. It was independent in the time of Cyrus, king of Persia, but was made subject to Persia after the revolt of Ionia in the time of Darius (B.C. 493); it was afterwards a tributary of Athens, and in the fourth year of the Peloponnesian war took part with the people of Methymna against the rest of the Lesbians. (Thucy., iii. 2.) Pausanias states that the Tenedians, becoming unable to defend themselves, submitted at some period of their history to Alexandria in Troas. Aristotle (*Rhet.*, i. 16) mentions some dispute as having recently occurred between them and the Sigæians, in which they cited in support of their cause the writings of Periander of Corinth. According to Cicero, Verres robbed the Tenedians of a statue of Tennes, their founder, of most beautiful workmanship. (*De Verbor.* i. 19.) Pindar (*Nem.* xi.) speaks of the Prytanes, or yearly magistrates of Tenedos, to one of whom, Aristagoras, he addresses this ode. It appears from Stephanus Byzantinus that Aristotle wrote on the constitution of Tenedos. On the antient silver

coins of the island are the types of a double-edge peculiar form; and on the reverse a bifacial head of Janus. The 'Tenedia securis' axe of Tenedos, a proverb expressing any summary mode of execution or dispatching an affair; derived from the law of Tenedos, mentioned by Aristotle as quoted by Plutarch, which permitted a person who caught others in the act to kill both parties with an axe. See the passage, by Eckhel, and Cic. *Ad. Quintum Fr.*, ii. 11. The name of Apollo also occurs on coins. On the word Tenedos here, and its transmission to Tenea near C. Müller, *Doricus*, i. 247.

According to Strabo (p. 604) there were two islands at Tenedos. It was used by the emperor Justinian as a depôt for corn going from Egypt to Constantinople, detained by contrary winds. According to Nees (Athenæus, xiii. 609) the women of the island surpassing beauty.

Tenedos was visited by Chandler, who found few remains of antiquity worthy of notice. In the walls, and burying-grounds were pieces of fragments of pillars, with a few inscriptions.

Asia Minor, p. 20; *Inscriptions Antiq.*, pp. 3-4. The greatest length of the island is from east to west with its harbour situated in a low and sheltered bay at the north-east corner. In the market-place of Atticus, father of Herodes Atticus. (Clarke ii. 178; who refers to an accurate plan and section of the island in Tournefort, *Voyage du Levant*, i. Pl. 17.) It contains two hundred Turkish and three hundred Greek houses. To the north of the harbour is a fortress with forty-two pieces of cannon, but it is not from the heights in the rear. (Frankland's *Travels*, i. 232.) The aspect of Tenedos from the sea is very fine red wine.

TENEMENT is a word employed in describing property. Though in its usual and popular use it is applied only to houses and other buildings, its original proper and legal meaning includes any thing of a permanent nature that may be held, whether corporeal or incorporeal. It is sometimes used in a confined sense, in which it is appropriated to feudal tenure; but in general it includes not only the land, but every modification of right concerning it. The word 'Liberum tenementum,' frank-tenement, is applicable not only to lands and other solid property, but also to offices, rents, commons, and the like. (Litt., 154. a. n. 7.)

TENERIFFE, or more properly TENERIFE, the largest and most important of the Canary Islands, is situated in 28° N. lat. and 16° 5' W. long. The most southern cape, Punta Roxa, is in 28° N. lat. and 16° 5' W. long. The most northern, Punta del Hidalgo, is in 28° 37' N. lat. and 16° 5' W. long. The most eastern part, Punta de Anaga, is in 16° 5' N. lat. and 17° 55' W. long. The most western, Punta de Tena, is in 17° 55' W. long. Towards the south-west to north-east is about 100 miles long, and towards the south-eastern extremity it is nearly 50 miles wide, but it grows gradually narrower towards the north-east, being near that extremity hardly more than 10 miles wide. In Humboldt's Travels, the area is stated to be 73 maritime square leagues, or 104 square miles; but according to a more recent calculation the area is 83805 Spanish square leagues, or 104 square miles, which is nearly equal to the area of the island of Sicily.

About one-seventh of the area, computed at 15625 square miles, is available for agricultural purposes. The remainder is covered with lava, volcanic productions, and a great part is destitute of vegetation; a small portion only is covered with the highest ground of the island is the Peak of Teide, by the inhabitants Peak of Teyde, which rises from Echeide, by which term the Guanchians call the mountain. This mountain is situated towards the north-east of the island, and is a volcano with two summits, which the south-eastern and more elevated one is 11,946 feet above the sea-level, and the northern Mount Chaborra, is 8888 feet. Their base is a short ridge, which is somewhat lower than the Mount Chaborra. Both summits are extinct. The crater of the Piton, called Caldera, is of itself only 300 feet long from south-east to north-east, and only 200 feet in the opposite direction. It is disting-

sular wall which surrounds it, and which would access to the crater, if it were not broken down eastern side. The depression of the crater does ed 160 feet. The crater of Mount Chahorra is e, as it takes more than an hour to go round it : it 140 feet deep. It is not on record that volcanic as issued from either of them : they are at present uraa, from the crevices of which sulphuric continually arising. But to the west of Mount e four volcanic cones, from which in 1798 great s of lava flowed and covered the adjacent tracts. In eat quantity of lava issued from the north-eastern he ridge which unites the Piton to Mount Cha- These lavas reached the sea and almost filled the of Garachico, which up to that time was the best, properly speaking, the only harbour in the island. ated volcanic masses extend from Mount Cha- a north-west direction to the Punta de Tena, which t elevated cape of the island. These masses o 0 feet above the sea-level.

Peak of Teyde is surrounded on the south-west, d south-east by an uninterrupted ridge of moun- sea, which form a semicircle, and arc about three m its base. These mountains are very steep to e volcano. On the other sides only single moun- cur. The tract which lies between the base of no and the semicircle is called Los Llanos de las , from a plant called retama, nearly the only plant egetates on this tract, which is covered with stones. Its surface is uneven, but has a regular m the base of the volcano towards the masses semicircle. Near the base of the volcano it feet, and near the semicircle about 6000 feet . The mountains forming the semicircle rise o 1800 feet above their base. It is supposed eak de Teyde and the mountains that belong to an area of 120 square miles.

the outer edges of the semicircle the country de- n rapid and broken slopes towards the sea on the d on the north, but on the south and east the semi- surrounded by table-lands, whose surface is like- ch broken, but which at the distance of several eerve an elevation of between 4000 and 6000 feet e sea. These table-lands are most extensive to , where they terminate, about 20 miles from the e, on the Plain of Laguna. These table-lands and no taken together probably cover nearly half the In many places the table-lands and the slopes of which cover it are overgrown with pines, but the art consists of bare volcanic rocks or lava. No part icultivated, with the exception of a small portion icinity of Chasna, south of the semicircle, where own, and where there are extensive plantations of s. On the edge of the table-land, west of Guimar, volcano, which made an eruption in 1705.

ain of Laguna is traversed by 16° 20' W. long. hat plain the cultivable country is found only near nd from three to four miles from it, with the excep- e table-land of Chasna, which is more than eight ant. The cultivable tract along the sea is so hat it is almost impossible to find a square mile n be called level. A portion of it rising in steep ridges cannot be cultivated, but where the de- re moderate the soil generally repays the labour on it. The most fertile tract is on the north side and, between Tegna and San Juan de la Rambla, y west of Santa Ursula, which portion is called v of Taoro. The soil consists of a mixture of nic matter, and some clay, and produces rich wheat and all kinds of fruit, especially grapes. San Juan de la Rambla are a few fertile valleys, eat part of the country is covered with recent e most sterile part lies along the west coast, be- nta de Tena and Punta Roxa, where there are w narrow valleys, and where a tract several miles t on both sides of Puerto de los Christianos is ren. Between Punta Roxa and Santa Cruz there al fine valleys, which have a fertile soil com- decomposed pumice-stone and tufa intermixed vel; but their fertility cannot be compared with the valley of Taoro, which is mainly to be as- the smaller quantity of rain which falls on the shores.

The plain of Laguna occupies the middle of the island, near 16° 20' W. long. : it is about 1700 feet above the sea, and enclosed by hills; the surface is nearly a dead level, occupying a space of about 12 square miles. After the rains it is partly covered with water, and hence is derived its name. The soil consists of a reddish clay, and produces abundant crops of grain, but no part of it is covered with trees.

The eastern portion of the island, or the peninsula which extends east of the plain of Laguna, is only hilly in comparison with the western portion, as the highest summit, the Bufadero, rises only to 3069 feet above the sea-level. In this part no traces of lava and no volcanic cones occur: the hills consist mostly of black basalt: the valleys are numerous, but narrow. These valleys and the adjacent hills are cultivated and planted with trees where the surface is not too steep: they produce the finest fruits in the island. The country descends gradually towards the east, and Punta de Anaga is only elevated a little above the sea-level.

Climate.—Teneriffe, being situated near the tropic, partakes of the climate both of the countries within and without the tropic: it has only two seasons, a rainy and a dry season, but the rainy season does not occur when the sun is nearest, as in the tropical countries, but when it is near its greatest southern declination. It occurs in the same period of the year as in southern Europe. The dry season is produced by the trade-winds, which, when the sun approaches the northern tropic, proceed farther north, and are met with at 30° and even 33° N. lat. These winds blow on Teneriffe without interruption from April to October, and always from the east-north-east: they are strongest from the middle of May to the middle of August. The wind begins in the morning between ten and eleven o'clock, and continues to five or six in the afternoon, when it is followed by a calm, which lasts till midnight. From midnight to seven or eight o'clock the land-breezes blow, and they are again followed by a calm, which lasts till the trade-wind sets in. Along the western shores of the island these winds are not felt, but there is a continual calm, which extends about 15 miles into the sea. The trade-wind renders the communication between the islands tedious and difficult. From Teneriffe a vessel can run to Hierro in less than one day, but to return from Hierro to Teneriffe it generally takes ten or twelve days, and sometimes even three or four weeks. A voyage from Madeira to Teneriffe is made in two days, but it takes more than a month to sail from Teneriffe to Madeira. During the prevalence of the trade-winds the weather is constantly fine, and not a drop of rain falls.

In the rainy season, from October to April, south-west winds prevail: in October the winds turn to the east and south-east, and then the summit of the Peak of Teyde begins to be covered with clouds which proceed from the south. These clouds accumulate on the Peak, and gradually descend lower. When they have sunk to about 6000 feet above the sea-level, and cover the most elevated part of the island, they produce terrible thunder-storms. The rain begins to descend in torrents on the sides of the mountains, and the summit of the peak is covered with snow. In summer the mountain is quite free from snow, which is only found in a deep depression on the northern slope. This depression is called Cueva del Yelo. The snow rests on the mountain about four months. At the beginning of November the wind is settled in the south-west, and whilst it blows the rains sometimes last for three days. In February, March, and April the wind turns to the west-north-west, north-west, and north-north-west, and the rains decrease gradually. They cease at the end of March.

The climate of Teneriffe and of the Canary Islands in general is disagreeably affected by the wind called El Levante, which comes from the south-east, and generally blows before or after the beginning of the rainy season. Its effect on all organic bodies is very great, and the heat which it brings from the Sahara is felt much more in elevated places than near the sea-shore, the more so as water is very scarce in those parts, and the thirst which the wind produces is intolerable. In those higher places it blows with such force that it frequently throws down men and horses. The air is misty, and it is not possible to distinguish objects even at a moderate distance; but there are no clouds in the sky. Sometimes this wind brings locusts in large numbers to the island. It was

formerly thought that these insects reached the island by flying, but MacGregor states that such immense numbers of them are carried from the Sahara into the sea as to form a thick layer; and that in this way they are carried to the Canary Islands, and that most of them are dead when they arrive there, but those which cover the upper surface are alive, and spread their devastation over the corn-fields and plantations.

We subjoin the meteorological observations made at Santa Cruz and at Laguna: the last-mentioned place is about 1700 feet above the sea.

Santa Cruz	Jan. 63° 53'	Feb. 64° 34'	Mar. 67° 16'	April. 67° 32'	May. 72° 11'	June. 73° 59'	July. 77° 27'	Aug. 78° 53'	Sept. 77° 42'
Laguna	55°	56°	58°	59°	62°	65°	69°	71°	70°
Santa Cruz	Oct. 74° 60'	Nov. 70° 43'	Dec. 65° 81'	Winter 65° 11'	Spring 71° 11'	Summer 77° 56'	Autumn 70° 11'	Ann. mean. 71° 04'	
Laguna	66°	62°	55°	56° 33'	62° 00'	70° 09'	62° 09'	62° 53'	

This table shows that the climate of Tenerife is distinguished by its moderate temperature, and that the heat of the summer is prolonged to the month of November, October being considerably warmer than May, and November than April.

Productions.—All European domestic animals are reared, and also white camels, which are used as beasts of burden, and reared on the west coast of the island, but not in large numbers. Cattle are rather scarce, on account of the want of pasture-ground. They are only kept for slaughter and for the plough: the cows are never milked. Horses are still less numerous. They are of good breed, of a middling size, and very hardy. Goats are very numerous, and their milk is exclusively used, and butter of a white colour, called 'mantequilla,' and a large quantity of cheese, are made of it. These goats are of a peculiar breed, which existed on the island before the arrival of the Europeans. They constituted the principal riches of the Guanches. Sheep are also numerous. The breed is small, and the wool is coarse, but abundant: it is consumed in the island. Asses are rather numerous, but small: mules are much used as beasts of burden. According to MacGregor, the number of cattle is about 4900, of horses 1000, of camels 60, of mules 1400, of asses 2200, of goats 30,000, of sheep 18,000, and of hogs 3000. The silk-worm is extensively reared, and the annual produce of silk may amount to 8000 lbs., but it fetches a less price than the Italian silk, not being so well prepared. In 1828 the cochineal insect was introduced, and the first trials at rearing it succeeded very well. We are not acquainted with the result of this attempt. Bees are abundant, domestic as well as wild. The honey is of the best quality, especially that which is collected in the neighbourhood of the Peak of Teyde, which is extracted by the bees from the blossoms of the retama plant. Between 7000 and 8000 lbs. of wax are annually collected. Rabbits are very numerous.

The domestic birds are fowls, ducks, geese, and pigeons. A great number of turkeys are reared. The number of wild birds is very great. Some of them are always found on the island, and others arrive only at certain seasons, in their migration from north to south, and *vice versa*. The most remarkable belonging to the first class are the wild pigeon, various species of Tetraonidae, quails, and larks. The canary-bird is common. Fish is far from being abundant. The inhabitants live mostly on potatoes and salt fish, which is obtained from the fishery on the coasts of Africa [SAHARA, vol. xx., p. 317]; but of late the inhabitants of Tenerife have abandoned this branch of industry, and buy the fish from the fishermen of the other islands. Whales are sometimes met with among the Canary Islands, and still more frequently dolphins. Seals rarely visit the coast.

The principal objects of agriculture are potatoes, wheat, maize, barley, and rye. Where the soil is good, and means of irrigation are at hand, two crops of maize, and one of potatoes, or two of potatoes and one of maize, may be raised in twelve months. According to an average of five years (1800-1804), the annual produce was about 70,000 quarters of potatoes, 21,700 quarters of wheat, 6511 quarters of maize, 5533 quarters of barley, 2200 quarters of rye, and only 40 quarters of oats. It is however stated that since that time the cultivation of grain, and especially that of potatoes, has considerably increased. Other objects of cultivation are flax, canary-seed, sumach for the tanneries,

pumpkins, cucumbers, yams, cabbage, peas, garbanzos, lentils, lettuce, capsicum, onions. The orchards produce apples, pears, cherries, cots, peaches, mulberries, almonds, chestnuts, Indian figs, oranges, and lemons, and also plums, apples, dates, pomegranates, papayas, guava, and a few other fruits derived from the West Indies. The most important object of cultivation is the sugar-cane, which yields the largest article of export. According to an average of five years (1800-1804) the annual produce amounted to 24,846 pipes, each containing 100 gallos stated that to this quantity from 5000 to 6000 pipes should be added, which during the vintage were cut up and made into brandy. Thus the annual produce amounted to 30,846 pipes. But the war between Spain and its colonies, to which a large quantity of wine and brandy was exported, has considerably diminished this branch of cultivation, and at present the annual produce hardly exceeds 10,000 pipes. The best sort, known by the name of Vides Madeira, and is sent to England. The demand for it was formerly in great request, but the demand has been diminished. The difficulty of obtaining a price for their wines and brandies has of late induced the inhabitants to introduce some other objects of cultivation. Cotton has begun to be cultivated; the produce is not yet that of Pernambuco. They have also made several successful trials with coffee. Two centuries ago sugar-cane was the most important branch of cultivation on the island. There is only one sugar-mill on the island.

Large forests still cover some of the high mountains of the island, though they have been greatly reduced. The trees there are numerous kinds of *Laurus*, *L. barbusana*, *L. nobilis*, &c. Two or three kinds of plants are used for making barilla, and the *Salicornia* *crystallinum* is cultivated for that purpose on a small scale. Two kinds of lichens which grow on the rocks are collected for their dyeing qualities. One is called *tinctoria*, which yields the archil, and the other is called *peruvianum*, and is mostly sent to England.

Teneriffe has no metals, except some iron-ore, but no use is made. Sulphur occurs in large quantities at the Peak of Teyde.

Population and Inhabitants.—According to the data of MacGregor, founded on the old census of 1763, the population of Tenerife amounted to 85,000 individuals; so that on the average there were 125 persons to each square mile. The greater part of the population of Guanches, who inhabited the island at the time of the Spaniards, perished in the war by which the Spaniards obtained possession of it, and the remainder intermarried with the Spaniards. The present inhabitants must be considered as Spaniards, whom they also resemble in their manners and character. The Spanish language alone is spoken in the parts remote from the town of Santa Cruz, and in other words.

Political Divisions and Towns.—For the purposes of justice the island is divided into three jurisdictions for which are at Santa Cruz, Laguna, and Santa Cruz de Santiago, the seat of the government of the Canary Islands, is built on the south-western part of the island, not far from its eastern extremity. The town is not large, and is well protected against the winds from those that blow from the south. At the distance of 75 to 100 fathoms from the land there is a reef of rocks in 6 to 12 fathoms, and half a mile off in 25 fathoms. The lowest part of the town is more than 2000 feet above the sea-level, and the ground rises gently. The houses are built in the Spanish Moorish fashion, with a patio in the middle, and have only one floor. The streets are straight, but narrow, and have foot-pavements. The population amounted, in 1829, to 8620 individuals. The place carries on a considerable commerce, and is annually visited by 80 to 100 vessels.

San Christoval de la Laguna is considered to be the seat of administration. It is situated in the middle of the plain of Laguna, and is a pleasant place. The streets are straight and wide, well paved, and have foot-pavements. Most of the houses have only one floor. The population amounts to more than 10,000 individuals. The inhabitants of Santa Cruz pass the summer months in the climate of Laguna is much cooler.

Tacoronte, not far from the northern coast, has 4000 inhabitants.

is on the declivity of a steep hill, nearly 1200 the sea-level: it is a well-built and thriving nearly 8000 inhabitants. It carries on a commerce by means of its harbour, called Puerto de la Cruz, which is about 2 miles distant, and contains a population of 4600.

On the southern coast, is in a very fertile valley, abounds much wine and wheat: it is rather well cultivated and contains 3500 inhabitants. In the vicinity are of the ancient inhabitants, the Guanches, which are now extinct.

Manufactures and Commerce.—There are a few manufactures at Icod de los Vinos, a town on the north coast, with 4000 inhabitants. These manufactures were formerly very active, and their produce went to America; but they are now in a declining state, especially since the discovery of Teneriffe have begun to wear cotton instead of woollen stuffs are made by the families for domestic consumption. Woollen stockings were formerly made for the American market, but this branch of manufacture has entirely ceased. Earthenware, especially tiles and filters, is still sent to Cuba and Puerto Rico. Manufactures of soap and vermicelli at Santa Cruz de Tenerife produce a very indifferent leather, which is exported. The number of distilleries is large, and the produce is hardly inferior to Cognac. Ropes are made from the agave; and hats, baskets, and mats from the date-palms. Good cabinet-work has long been made for the South American market.

Foreign commerce is concentrated in the port of Santa Cruz and Port Orotava, which are annually visited by 20 vessels, mostly English. The inhabitants employ 200 vessels, with which they visit the American coast. The most active commerce is that with England, which consists of 80 vessels are constantly employed.

The principal exports consist of iron utensils, hardware, iron in bars, crockery, leather, candles, soap, large quantities of cotton goods, provisions, cod, and some other articles. The most important exports are wine, sugar, and barilla: there are also exported almonds, raw silk, and archil. The commerce with the West Indies of America and with Hamburg is also considerable.

—The Canaries were known to the ancients, and were called the Fortunate Islands. [CANARIES, vol. I.] Teneriffe was occupied by the Spaniards in 1492, and has always remained in their possession.

History and Conquest of the Canary Islands; Voyage aux Régions Équinoxiales du Nouveau Monde, vol. i.; Von Buch, *Physikalische Beschreibung der Canarischen Inseln*; and *Die Canarischen Inseln in ihrem gegenwärtigen Zustande*, von Maclean, 1831.)

DAVID (the Elder), was born at Antwerp in 1610, and had the good fortune to study painting under the highly esteemed Peter Paul Rubens, who benefited him by the instruction of that great master, and the advantage of learning his manner of preparing and managing his materials. It is said that he went to Rome with the intention of improving himself in the higher branches of the art, but he there contracted a friendship with his countryman Adam Pannini, whose exquisitely-finished cabinet pictures were so much admired, and he studied with him several years, and painted many small pictures. It was here that he acquired neatness of pencilling for which his works are distinguished, and which, with the knowledge of colours acquired from Rubens, gives to his works so great a charm.

On his return to his native country after ten years' absence, he returned himself with the greatest ardour to the practice of his art, and chose the familiar scenes of ordinary life, such as merry-makings, weddings, the interior of public-houses, rural games, chemists' shops, and grotesque subjects, such as the Temptation of Christ, and the like. These subjects he treated with the most truth and fidelity to nature. His colouring, his design, the pleasing distribution of light and shadow, the skilful composition of his groups, procured him a high reputation and constant employment: every artist was eager to possess some of his works. He is generally considered as the inventor of a new style of painting, which was followed and carried to a still higher

degree of perfection by his son. He died at Antwerp in the year 1694, at the age of sixty-seven.

TENIERS, DAVID (the Younger) was born at Antwerp in 1610, and received his first and principal instruction from his father. Some authors have affirmed that he left his father to become a disciple of Adrian Brouwer, who however was only two years older than himself, and that he had the advantage of the precepts of Rubens. Others have pretended that he was likewise a pupil of Elsheimer, who died when Teniers was only ten years old. He adopted, as we have observed, the subjects and style of his father; but, with a more fertile imagination, he produced compositions much more varied and ingenious; his colouring is more vivid, rich, and transparent, and the facility of his execution is enchanting. He studied nature in all her varied forms with the most critical attention. He possessed, in perfection, what we have heard one of the brightest living ornaments of the British school call 'the art, or rather the gift, of seeing.' Hence the truth and nature of his pictures, which look almost like reflections in a convex mirror. His pencil is free and delicate; the touching of his trees light and firm; his skies are admirably clear and brilliant, though not much varied. The expression of his figures, in every varying mood, of mirth or gravity, good or ill humour, is strongly marked, striking, and natural; he represented them however precisely as he saw them before him, but was perhaps inferior in delineation of character to Jan Steen or Wilkie.

It is remarkable that at the commencement of his career very little regard was shown to his merit, so that he was often obliged to go in person to Brussels to dispose of his pictures. But he was not long neglected. The archduke Leopold having seen some of his pictures, immediately distinguished him by his patronage, appointed him his principal painter and gentleman of his bedchamber, presented him with a chain of gold to which his portrait was affixed, and gave him the direction of his gallery of paintings, which contained works of the most eminent masters of the Italian and Flemish schools. Teniers, who possessed an extraordinary talent in imitating the works of other artists, made copies of this gallery, in which the touch, the colouring, and the manner of the several painters, however different from each other, were reproduced with such a deceptive fidelity, that he acquired the name of the Proteus of painting. Some writers have objected that his figures are too short and clumsy, and that there is too much sameness in their countenances and habits: but it must be remembered that he designed every object as he saw it; and the charm which his art has thrown on scenes flat and insipid in their forms, even subjects low, barren, and commonplace, justly excites the admiration of all lovers of the art, and the extraordinary prices which are given for his works in every part of Europe are an incontestable proof of the universal admiration and esteem in which they are held. This circumstance is the more deserving of attention, as his works, far from being scarce, are extremely numerous: his extraordinary facility of execution and the great age to which he attained enabled him to produce such a number of pictures, that he was used to say in joke that to hold all his paintings (though they were of such small dimensions) it would be necessary to build a gallery two leagues in length. It is worthy of remark that while of all the Flemish painters his works are the most popular, he was habitually conversant with the higher classes of society. The suavity of his manners and his irreproachable conduct secured him the esteem of all his countrymen. Besides the archduke Leopold, he was honoured with the favour and protection of Christina, queen of Sweden, the king of Spain, Don John of Austria, who became his pupil, the Prince of Orange, the bishop of Ghent, and other eminent personages. He often assisted the landscape-painters of his time by inserting figures into their pictures, and many works of Artois, Van Uden, Breughel, and others derive additional value from this circumstance. The galleries and collections in England contain a great number of his finest works. He died at Brussels, in the year 1694, at the advanced age of eighty-four years.

(Pilkington; Fuseli; *Conversations Lexicon*; *Biographie Universelle*; Dr. Waagen, *Arts and Artists in England*.)

TENIMBAR ISLANDS. [SUNDA ISLANDS, LESSER.]

TENISON, THOMAS (born 1636, died 1715), an Eng-

lish divine, son of a clergyman in the diocese of Ely, who was advanced by his own deserved reputation for piety, charity, learning, and liberality, to the highest station in the English church. He was born at Cottenham in Cambridgeshire, educated in the grammar-school at Norwich, from whence he passed to Corpus Christi College, Cambridge, where he was admitted in 1653, and took his bachelor's degree in 1657. The university was then in the state to which it had been brought by the parliamentary commissioners, and the turn of mind of Tenison not according with what at that time was expected from persons undertaking the ministry, he for a time turned to the study of medicine; but about 1659 he was privately ordained in the episcopal method then proscribed by the government of the time. The ordination was performed at Richmond in Surrey by Dr. Duppa, the expelled bishop of Salisbury. The restoration of the king, and with it of the episcopal church, soon following, he was made minister of St. Andrew's Church in Cambridge, in which situation he gained much credit by his attention to his parishioners during the time of the plague, in 1665. He had other preferment in the country, as the church of St. Peter Mancroft in Norwich, and the rectory of Holywell in Huntingdonshire. This brings down his history to the year 1680, when, being then doctor in divinity, he was placed on a more conspicuous stage, being presented by King Charles II. to the living of St. Martin's in the Fields.

In this public situation he acted with great prudence, and with a liberality which emulated the munificence of the clergy of earlier times, giving more than 300*l.* to the poor of his parish in the time of the distress occasioned by the hard frost of 1683, and endowing a free-school, and building and furnishing a library. In 1685 he discharged the difficult duty of attending the duke of Monmouth previous to his execution with singular discretion. In his politics he was a Whig, and favourer of the Revolution, and was accordingly early marked out by King William for advancement in the church. In 1689 he was made archdeacon of London, and in 1691 bishop of Lincoln. This large diocese, which had been too much neglected, he brought into order. In 1694, on the death of Dr. Tillotson, he was made archbishop of Canterbury, in which high dignity he remained for twenty years. He died on the 14th of December, 1715, and was interred in the parish church of Lambeth.

A large account of his life was published soon after his death, without the name of any author in the title-page, but evidently written by a person possessed of good information, and who was fully sensible to his merits. He speaks of him thus:—'And as he was an exact pattern of that exemplary piety, charity, steadfastness, and good conduct requisite in a governor of the church, so perhaps since the primitive age of Christianity and the time of the Apostles there has been no man whose learning and abilities have better qualified him to discharge and defend a trust of that high importance.'

The library which he founded in the parish of St. Martin's still exists; and he may be regarded as the founder of the library in the cathedral church of St. Paul, having presented two hundred and fifty pounds to make up four hundred and fifty, which the dean and residentiares gave for the libraries of two clergymen bought by them in 1707. His will contains many munificent bequests for charitable and religious objects.

Archbishop Tenison has left no writings behind him which can be said to make part of the general literature of the country, or to establish for him a literary reputation. Yet he published several treatises, mostly connected with the religious and political controversies of his age.

TENNANT, SMITHSON, a distinguished chemist, was born at Selby, in Yorkshire, November 30, 1761, and died February 22, 1815. He was the only child of the Rev. Calvert Tennant, of whom little is known except that he had been a Fellow of St. John's College, Cambridge, and was a friend of Dr. Rutherford, Regius Professor of Divinity in that University.

While very young he gave many proofs of a particular turn for chemistry and natural philosophy, and after quitting school he was very desirous of completing his chemical studies under the immediate instruction of Dr. Priestley, who was then enjoying high and deserved reputation for the extent and variety of his discoveries in pneumatic chemistry; but this was found impracticable in consequence of the previous engagements of Dr. Priestley.

In the year 1781 he went to Edinburgh with the view of studying medicine. Of his companions, or studies while in Scotland, little is known; that he received instruction from Dr. Black; he did however continue long in that University, for in 1782, he was admitted a member of Christ's College bridge, where he then began to reside.

In the summer of 1784 he travelled into Denmark and Sweden, with the intention, partly of examining mines of the latter country, but chiefly of becoming personally acquainted with Scheele, for he had conceived a high degree of admiration, on account of the simplicity of the apparatus which he employed in his chemical researches. In a year or two afterwards he went to Paris, where he became acquainted with some of the eminent chemists; thence he went to England and the Netherlands, after having recovered from an illness with which he was seized during his residence in the French capital.

In January, 1785, he was elected a Fellow of the Society, and in 1786 he left Christ's College and returned to Emmanuel College; in 1788 he took his bachelor's degree of physic, and soon after quitted Cambridge to reside in London. In 1796 he took a doctor's degree at Cambridge, but as his fortune was indigent he relinquished all idea of practice as a physician; in 1813 he was elected Professor of Chemistry at Cambridge, having in the previous year delivered, with great success, a few lectures on the principles of mineral chemistry to his friends.

In the month of September, 1814, Mr. Tennant returned the last time to France, and on his return home, in February, 1815, he arrived at Boulogne with the intention of embarking there. They embarked on the 10th, but were forced back by the wind, and meant to return in the evening; in the meantime they took a short walk to see Bonaparte's pillar, about a league going off the road on their return to look at a monument of which the drawbridge wanted a bolt, they were thrown, with their horses, into the ditch. Baron was merely stunned, but Mr. Tennant's skull was severely fractured, that he died within an hour after.

The following character of Mr. Tennant is chiefly taken from some variations, from the *Annals of Philosophy*, vi., and the writer of this brief notice, having well known the subject of it, is able to testify to the accuracy of the statements in all the more important particulars.

Mr. Tennant was tall and slender in his person, with a thin face and light complexion. His appearance, notwithstanding some singularity of manners, and great neatness of dress, was on the whole striking and agreeable. His countenance in early life had been singularly engaging, and at favourable times, when he was in good health, still very pleasing. The general cast of his features was expressive, and bore strong marks of intelligence; several persons have been struck with a general resemblance in his countenance to the well-known portraits of Newton.

Of his intellectual character, the distinguishing and characteristic principle was good sense; a prompt and accurate perception of truth, both upon those questions where certainty is attainable and those which must be determined by the nicer results of moral evidence. In quickness of mind, united with soundness and accuracy of judgment, was perhaps without an equal. He saw immediately with great distinctness where the strength of an argument lay, and upon what points the decision was ultimately to depend; and he was remarkable for the facility of stating the merits of an obscure and complicated question very clearly and with great simplicity and precision. The candour and temper, as well as the singular perspicuity displayed on such occasions, were alike admirable; and he failed to convince the unprejudiced, and to convert or silence his opponents. He had a peculiar humour, which was heightened by a perfect self-possession, a quiet familiar manner, and a characteristic simplicity of language. In consequence of the declining state of his health, his conversation was perhaps less uniformly conspicuous in his latter years, but his mind had lost none of its vigour, and he never failed, when he exerted himself, to display his peculiar powers.

The *Philosophical Transactions* contain eight papers by Mr. Tennant:—1, 'On the Decomposition of Fi-

; 2, 'On the Nature of the Diamond,' 1797; 3, 'On the
of Nitre upon Gold and Platina;' 4, 'On the Dif-
Sorts of Lime used in Agriculture,' 1799; 5, 'On the
Position of Emery,' 1802; 6, 'On two Metals found in
lack Powder of the solution of Platina,' 1804; 7, 'On
ier Mode of procuring Potassium than that which is
adopted;' 8, 'On the Mode of producing a Double
ation by the same Heat.'

the first volume of the 'Transactions' of the Geolo-
Society, 1811, he published the analysis of 'A Vol-
Substance containing the Boracic Acid.'

his experiments on the diamond, he proved it to be
carbon, by heating it in a gold tube with nitre; the
d was converted into carbonic acid by combining
oxygen of the decomposed nitric acid, and this
with the potash of the nitre; by the evolution of
carbonic acid, the quantity of carbon, in a given weight
ad, was estimated. In his paper on 'Limestones,'
ed that the presence of carbonate of magnesia in
rendered them prejudicial when calcined and applied
manure.

in the paper on 'Emery,' he proved that this substance is
ely a variety of corundum, or sapphire. The two metals
he found in native platina were osmium and iridium.
h respect to these memoirs it may be observed that
il bear the impress of originality, and that the opera-
- which they include and describe are of the greatest
simplicity, and stated in the plainest language.

NANTITE, a variety of grey copper-ore, so named
honour of Smithson Tennant, a distinguished chemist.
occurs in attached crystals, which are usually small.
form a cube. Cleavage parallel to the planes

lar octohedron. Fracture uneven and imper-
ly lamellar. Hardness: scratches carbonate of lime, but
scratched by the phosphate. It is brittle. Colour vary-
: from tin-white to blackish iron-grey, frequently tar-
on the surface. Streak reddish-grey. Lustre me-
- sometimes splendid. Specific gravity 4.375.

when heated by the blowpipe, it decrepitates, and burns
th a blue flame, emitting arsenical vapours, and then
es into a black scoria, which is attracted by the magnet.
It occurs only in Cornwall, and has there been found in
eral copper-mines.

Analysis by—

	R. Phillips.	Hamming.
Sulphur . . .	28.74	21.8
Copper . . .	45.32	48.4
Iron . . .	9.26	14.2
Arsenic . . .	11.84	11.5
Silica . . .	5.00	5.0

100.16

100.9

TENNESSEE is one of the inland states of the North
can Union, and lies between 35° and 36° 40' N. lat.
een 81° 30' and 90° W. long. The southern bound-
- which runs along 35° N. lat., is contiguous to the
n limits of the states of Georgia, Alabama, and Mis-
-, and is 356 miles long, of which the boundary with
- amounts to 100, that with Alabama 140, and that
-issippi 116 miles. On the west of it are Ar-
- and Missouri, from which it is separated by the
-ppi, whose course along this border amounts to
- 150 miles, measured along the numerous bends.
- of Tennessee are Kentucky and Virginia. The
-line towards Kentucky between the rivers Mis-
- and Tennessee runs along 36° 30' N. lat. for about
-, but east of the last-mentioned river it follows its
- or about 12 miles until it reaches 36° 40' N. lat.
- 33' W. long., and then extends a little south of
- until it meets the south-western angle of Virginia
- 33° 30' W. long. The distance between the Tennessee
- and the last-mentioned point is about 250 miles.
- ine which divides Tennessee from Kentucky is con-
- l eastward between Tennessee and Virginia for 105
- when it arrives at the most eastern point of the state.
- of Tennessee is North Carolina; the boundary-line
- ten them, which is 150 miles long, is formed by one
- e ranges of the Appalachian Mountains, called the
- Mountains. The length of Tennessee from east to
- is about 445 miles, and its breadth from north to south
- miles. The area is about 40,200 square miles, or
- 20,000 acres. It is about 10,000 square miles less in
- at than England without Wales.

Surface and Soil.—This state is naturally divided into
three regions, which may be called the Eastern or Moun-
tain region, the Middle or Hilly region, and the Western
or Level region; and this division coincides tolerably well
with that made for the administration of justice, according
to which the country is divided into the Eastern, the
Middle, and the Western District. The first and the last
are nearly equal in extent, each comprehending about
10,000 square miles, but the Middle District is about
double that size.

The *Eastern or Mountain Region* lies within the ranges
of the Appalachian Mountains. This extensive mountain-
system may be said to commence along and near the southern
boundary-line of Tennessee. Near 35° N. lat. and 82° W.
long., on the boundary-line between South and North Caro-
lina, the country forms a ridge of hills, a continuous high
ground which extends westward to 85° W. long., a distance
of more than 160 miles. In the Carolinas it is known by
the name of the Blue Ridge. It does not terminate at
85° W. long., but west of that meridian it forms a kind of
mountain-knot, consisting of several ridges, which extend
south-west and north-east, in the direction of the whole
mountain-system. These ridges lie between 34° and 35°
20' N. lat., and the Tennessee river traverses this tract in a
south-west direction. The highest of these ridges is on the
east of the river valley, and is called the Look-out Moun-
tains. The elevated ground just mentioned constitutes
the southern extremity of the Appalachian Mountains;
for from its eastern extremity, west of 82° W. long., a ridge
runs in a general north-east direction, which is also called
the Blue Ridge, being considered as the continuation of
the before-mentioned ridge so called, and from its western
termination (near 86° W. long.) there runs another ridge
under the name of the Cumberland Mountains, first north-
north-east, and afterwards east-north-east and north-east.
The space included between these two ranges extends from
east to west about 200 miles. It is traversed by several
minor ridges, among which the most elevated and least in-
terrupted is called the Iron Mountains. It extends south-
west and north-east, is much nearer the eastern Blue Ridge
than the Cumberland Mountains, which are west of it, and
constitutes the boundary-line on the east between North
Carolina and Tennessee.

The mountain-region of Tennessee occupies the tract en-
closed by the Iron Mountains and the Cumberland Moun-
tains, whose most elevated parts are about 70 miles distant
from one another. The northern half of this tract is tra-
versed by three minor ridges, which in general run parallel
to the larger ranges, and thus with the two outer ranges
form four valleys, which are traversed by four of the upper
branches of the Tennessee River, namely, Powell's, Clinch,
Holston, and Frenchbroad River. The valleys are rather
wide, but as there is little alluvial land along the water-
courses, their surface is uneven and broken, and the soil,
which consists mostly of siliceous gravel, is of indifferent
quality, except in the valleys of the Holston and French-
broad rivers, where it contains a mixture of clay. Only a
comparatively small portion of it is strong enough for the
growth of wheat; the greater part produces rye and oats; but
the mountains afford good pasture-grounds, and large herds
of cattle and sheep are kept. The most elevated part of
the mountains is overgrown with forests of pitch-pine, which
yield timber, and from which tar, pitch, and turpentine are
extracted. The minor ridges terminate near 35° 50' N. lat.,
where the upper branches of the Tennessee river form their
union. The country south of 35° 50' can only be called moun-
tainous near the southern portion of the Blue Ridge and the
Cumberland Mountains, the interior being covered by a
succession of hills rising hardly more than 300 feet above
their base. The soil of this tract is of indifferent quality,
and mostly used as pasture-ground, but the forests contain
many large trees, as pitch-pine, red cedar, and black wal-
nut. Along the watercourses there are some tracts of mo-
derate extent fit for the growth of rye and oats.

The *Hilly or Middle Region* extends from the Cumber-
land Mountains westward to the Tennessee River, where it
traverses the state by running from south to north. The
general level of this region is several hundred feet above
the sea-level, and it is covered with numerous hills, which
form several continuous ridges, such as that which, under
the name of Elk Ridge, runs from east to west near 35° 20'
N. lat. between the Elk River and Duck River. The water-
courses are usually much depressed below the general level,

and most of them run in narrow channels. This tract varies greatly in fertility. Near the Cumberland Mountains, and to the distance of 20 miles from them, the soil consists chiefly of gravel mixed with limestone, and is of moderate fertility, but in general it is better than in the mountain-region, and larger tracts are fit for the growth of wheat. The country west of this tract is the most fertile portion of Tennessee: it extends over the whole of the state from north to south, and reaches westwards to 87° W. long. The soil is not inferior to the best part of Kentucky, and consists of a large portion of clay and loam mixed with sand and gravel. A large quantity of wheat is produced, but the staple articles are tobacco and maize. In the better lands, especially along the Cumberland River, the common produce of maize is from 60 to 70 bushels for one, and in other places 40 or 50. The forests, which still cover a great part of the surface, consist chiefly of ash, elm, black and honey locust, mulberry, sugar-maple, and the wild plum; and wild grapes are abundant. The western districts, or those which lie near the Tennessee River, and extend about 30 miles east of it, are less hilly, but they are also less fertile: they produce the same articles, but the crops are less plentiful. In some places cotton is cultivated.

The *Western or Level Region* lies between the Tennessee and Mississippi rivers. The surface is traversed by some swells of high ground: the most extensive is that which runs across the state from north to south, about 12 miles from the western bank of the Tennessee River, and is several miles wide. Other swells traverse the southern districts, running from south-east to north-west, and terminating on the banks of the Mississippi with the Chickasaw Bluffs. The north-west districts are nearly a dead level, which descends imperceptibly to the banks of the Mississippi, where it terminates in a large wooded swamp, called the Wood Swamp. This region was very thinly inhabited twenty years ago, but it cannot be of indifferent quality, if we judge by the rapidity with which the population has increased. It appears however that the more elevated portions of the country are much more thickly settled than the level tract, which may be attributed to the circumstance that the last-mentioned tract contains many swampy places, and is less favourable to health. In these regions every kind of grain is grown, and cotton and tobacco are extensively cultivated.

Rivers.—Numerous rivers drain this state, and some of them have a long course. The larger rivers are navigable for keel-boats and for steam-boats, but only during the boating-season, which generally commences on the 20th of February, and terminates early in June. Occasional freshets contribute to render them navigable during a short portion of the other months, but no reliance can be placed on periodical returns of freshets, except those of the spring season.

The Tennessee River rises with numerous branches in the Appalachian Mountains: the most remote of them originate in Virginia near 81° 20' W. long. and 37° N. lat., and run south-west. The largest branches are the Clinch and Holston rivers: they unite with other branches, which rise in North Carolina, in the country enclosed by the Blue Ridge and the Iron Mountains, and which break through the last-mentioned chain. The largest of them are the Frenchbroad River, the Tennessee, and the Hiwassee. After these numerous branches have united, the Tennessee traverses the mountain-knot between 34° and 35° 20' N. lat. It passes through the ridge, which on the south is called Look-out Mountains, and on the north Walden's Range. It rushes through this gap with great impetuosity over a rocky bed: this place is called the Suck: its course within the mountain-tract is very rapid, and it escapes from it by another gap near Fort Deposit, in Alabama. At this place it changes the south-west course into a western course, and after draining Alabama for about 200 miles, it returns to Tennessee. In Alabama the river widens from two to three miles, and in this part there are extensive rocky shoals, which are known under the name of the Mussel Shoals, and occupy for seven or eight miles the whole of the bed. In low-water these rocks entirely obstruct the navigation, but in the time of the freshets boats of moderate size may ascend and descend without danger. The lower course of the Tennessee River, as far as it lies within Tennessee, is from south to north. After having entered Kentucky it gradually declines to the west, and falls into the Ohio. The whole course of the Tennessee probably does not exceed 800 miles, reckoned from the source of the Holston or

Clinch. In the boating season it may be ascended river-boats to the Mussel Shoals, and even to that which it escapes from the mountains by small boats of its upper branches are navigable for small boats the Suck. It appears that within the Appalachian mountains it may be descended by boats, but the ascension is laborious and even dangerous.

The Cumberland River rises in Kentucky, is formed by the Cumberland Mountains and the Mountains, and traverses the south-eastern district of the state by a general western course: after a run of 150 miles it turns to the south-west and enters the Ohio, where it soon resumes its western course. In the northern districts of Tennessee by a course of 100 miles; and turning gradually more to the north of Kentucky, where its general course is to the west, it falls into the Ohio a few miles above the mouth of the Tennessee. This river runs about 450 miles, and its current is very gentle, the navigation is easy for as far as Nashville, more than 150 miles from its mouth, it is stated to be navigable for river-boats 150 miles up, but in Kentucky the upper course is obstructed by extensive shoals in several places.

Climate.—No meteorological observations have been published, we are unable to give a precise idea of the climate. It is very probably assumed by Darby, that the general level of the Western Region is about 800 feet more elevated than the level of the sea. This of course must produce a difference in the climate of the two regions. The vegetation in Virginia, east of the Blue Ridge, is several weeks earlier than in the valley west of it. It is stated that the winter in the Mountain Region lasts for 10 weeks, and that the frost is rather severe. In the western part of the range the rivers are generally covered for a few days in the winter. Snow falls to the depth of 10 inches, but seldom lies more than twelve or fifteen days on the ground. In winter and spring a considerable quantity of rain falls; but in the other seasons it seldom does, nor does it continue for any length of time. In some parts of Tennessee is remarkable for its dryness.

Productions.—The state of agriculture in Tennessee is best inferred from the statement of the returns according to which the quantity of maize grown in 1820 amounted to 42,467,349 bushels, a quantity much larger than that produced in any other of the United States. As maize is best adapted for the feeding of hogs, the number of hogs was also larger than in other states, amounting to 2,795,630. Oats were raised to the amount of 1,250,000 bushels; wheat, 4,547,273 bushels; potatoes, 1,250,000 bushels; rye, 297,033 bushels; buckwheat, 1,250,000 bushels; and barley, only 4758 bushels. The quantity of tobacco amounted to 128,250,308 lbs., which was not half as much as that produced in Mississippi (289,838,818 lbs.); more than half the quantity that was raised in Georgia (240,379,669 lbs.), but nearly as much as was raised in Ohio (148,907,880 lbs.), and Ohio 134,322 lbs. Tobacco was produced to the amount of 26.54 more than one-third of the quantity grown in Virginia (74,157,841 lbs.). Flax and hemp yielded 45 and the meadows only 38,512 tons of hay. Rice was cultivated, as the produce was only 7729 lbs.: the plantations yielded only 840 lbs. The cultivation of silkworm seems not to have made much progress, only 1163 lbs. of cocoons were gathered. The value of the produce of the orchards was estimated at 336,711 dollars, which proves that horticulture has made considerable progress. A small quantity of wine was made, amounting to 653 gallons. The sugar made from the cane amounted to 251,745 lbs. Though the principal articles drawn from the forests has decreased, it is still considerable: the lumber was estimated at 200,000 cords, besides 3119 barrels of pitch, tar, turpentine, rosin, and 212 tons of pot and pearl ashes. The number of horses and mules amounted to 327,526, the number of cattle to 773,390, and that of sheep to 748,459. The value of the poultry was estimated at 581,531 dollars. The value of the dairy was to the value of 930,600 dollars, the quantity of wool was 1,029,526 lbs.; and 50,715 lbs.

Buffaloes were once numerous, but they have since disappeared; the elk and moose-deer are also

mountain Region, and the deer is still abundant. There are bears, pumas, wild-cats, and wolves; beavers, otters, and musk-rats. Racoons, foxes, opossums, rabbits, polecats, and minxes are very common; pheasants, partridges, pigeons, swans, wild ducks, and geese are abundant. There is fish in the rivers, but not very abundant. The wild trees and shrubs yield fruits are the wild plum, the crab-apple, wild vine, and the strawberry. There is gold in the mountains bordering on North Carolina up to 1834 only 12,000 dollars' worth had been discovered. Lead exists in the same mountains, but is not worked. Iron-ore is found in great abundance on the side of the Cumberland River, and also at several places. Limestone and marble are got in the mountains, and nitre in abundance in some places near the Mountain Region. Salt-springs are numerous, and some of them are strong. Some of the salt is sent out to a great amount, as salt is easily obtained in the western districts of Pennsylvania and

North Carolina.—In 1838 the Cherokees, who up to that time were in possession of the southern districts of the mountain region, left Tennessee, and went to the west of the Mississippi. [NORTH AMERICAN INDIANS.] At present the population consists of the descendants of European

slaves. At the census of 1820 the population consisted of 422,813. At the census of 1830 it had increased to 517,000, which gives an increase of 61·3 per cent. in ten years. According to the last census (1840) the population amounted to 829,210, so that in the ten years preceding it had increased 21·6 per cent., which is double the rate of increase in most countries. The increase however has not been equal in the different parts of the state. In the Eastern District it had risen to 224,259, or about 14·7 per cent.; in the Western District, from 374,749 to 411,710, or only 9·9 per cent.; in the Eastern District, from 110,854 to 193,241,

the population consisted of 535,746 whites, 141,603 slaves; and in 1840, 527 whites, 5524 free coloured people, and 141,603 slaves; whence it is evident that the slave population increased more rapidly than the white, as the number of slaves amounts to 29·2 per cent. of the white inhabitants to the slaves in the Eastern District, which contains only 18,714 whites, so that the slaves constitute 20·3,371 whites, so that the slaves constitute 21·6 per cent. of the number of the whites. In the Western District there were 301,137 whites and 107,735 slaves, which raises the slave population to 32·4 per cent. of the whites. In the Western District the number of whites amounted to 136,099, and that of the slaves to 44,610, so that the slaves constituted 41·6 per cent. of the white population.

The population were equally distributed over the state. There would be 20·6 individuals to each square mile. In the Eastern District there are 90, and in southern Sweden about 100 individuals to each square mile. It is remarkable that the sterile part of Tennessee, the mountain-region, is the least populous. If we allow it 10,000 square miles, it probably somewhat too much, it contains 100 individuals, whilst the Middle District has only 21·2 individuals, and the Western District only 19·3 individuals to each square mile.

Divisions and Towns.—For the administration the state is divided into three districts; and for judicial purposes into seventy-two counties. As Tennessee is essentially an agricultural country, none of the towns has risen to any importance. The capital is Nashville, on the left bank of the Cumberland River, where navigation for large boats begins. It is a well-thriving place, which in 1830 contained 5565 inhabitants; and in 1840, 6929. Knoxville, on the river in the centre of the mountain-region, has a population of about 3000. The other towns are small. Memphis, south-east of Nashville, in one of the mountain districts of the state, has about 1500 inhabitants. Nashville, on the Mississippi, near the mouth of the State of Mississippi, is a very thriving place of resort for the steam-boats which ply on the river.

See also, No. 1514.

Manufactures.—Manufacturing industry has not made much progress in Tennessee. In 1840 the number of persons employed in manufactures and trades was only 17,605; of whom 10,409 were in the Middle District; 4679 in the Eastern; and 2727 in the Western. The number of distilleries was 1381, but all on a small scale, as may be inferred from the produce, which amounted only to 1,060,693 gallons: in New York 38 distilleries produced more than 4 millions of gallons, and in Massachusetts 37 distilleries more than 5 millions. Cotton and linen stuffs for clothing are made at home. There is a small number of families who make coarse cotton, linen, and hempen fabrics for sale; and there are also a few paper-mills and manufactures of cordage and ropes. Some bar-iron is made, and nails are manufactured. There are also several small tanneries.

Commerce.—Tennessee is not favourably situated for commerce, as the only river which is navigable for large boats all the year round washes its western extremity. The mountain-region labours under the greatest disadvantages, as the mountains which separate it from the Atlantic regions are difficult to pass. Its commercial wealth consists of live stock: they send their neat cattle to Virginia, and their horses, mules, and hogs to the Carolinas. The Middle and Western Districts are commercially connected with New Orleans, to which place they send, by the Mississippi, cotton, tobacco, maize, pork, potatoes, flour, hemp and flax, deer-skins, lumber, ginseng, and bar-iron. The foreign articles consumed in the country, which consist mostly of grocery and some other articles of manufacture, are imported from Pittsburg and Philadelphia, or from New Orleans.

Education is not neglected. The number of white persons above twenty years of age unable to read and write amounted, in 1840, to 58,532; the number of elementary and common schools was 983, and the number of children attending them 25,090, of which number 6006 were taught at the public expense. The number of academies and grammar-schools was 152, and they were attended by 5548 boys. There are five universities or colleges. The best is the university of Nashville, which has six instructors and a library of about 8500 volumes. Jackson College is near Columbia. The colleges of Greenville, Washington, and Knoxville are smaller. There is a theological seminary at Maryville in East Tennessee for Presbyterian clergymen.

History and Constitution.—The first settlements in Tennessee were made about the middle of the last century, but in 1760 they were destroyed by the Cherokees, then the possessors of this country, from the northern and central part of which they were expelled in 1790. Since that time the number of settlements has continually and rapidly increased. Up to 1790 Tennessee formed a part of North Carolina, but in that year it was ceded by that state to the United States, who converted it into a territory. In 1796 it was admitted into the Union. The legislative power is vested in a general assembly consisting of a senate and a house of representatives, elected by the freeholders for two years. The senate is at present composed of 25 members, and the house of representatives of 75 members. The executive power is vested in a governor, who is chosen by the electors for the term of two years, and is not capable of holding office more than six years out of eight.

(Cornelius, *Tour in Virginia, Tennessee, &c.*; Long's *Expedition to the Rocky Mountains*, by James; Darby's *Geographical View of the United States*; Pitkin's *Statistical View of the Commerce of the United States*; the *American Almanack and Repository of Useful Knowledge* for 1842.)

TENNIS, a game in which a ball is driven to and fro by several persons striking it alternately, either with the palm of the hand, naked or covered with a thick glove, or with a small bat called a racket, held in the hand; the aim being to keep the ball in motion as long as possible without allowing it to fall to the ground. Strutt, on the authority of St. Foix, a French author, states that the French game of ball called palm-play, or 'jeu de paume,' was formerly played with the naked hand, then with a glove, which in some instances was lined, and that afterwards the players bound cords and tendons round their hands to make the ball rebound more forcibly; and hence, it is added, the racket derived its origin. He states that palm-play, or hand-tennis, was exceedingly fashionable in

France during the reign of Charles V., it being often played by the nobility for large sums of money. Perhaps the first historical notice of the game in England is that which Shakspeare has introduced, almost in the words of the old chroniclers, in his 'Henry V.' (act i., sc. 2), where the dauphin sends a present of tennis-balls in answer to Henry's demand for the sovereignty of France. Henry VII. was a tennis-player; and, as an entry in a MS. register of his expenditure in the thirteenth year of his reign mentions an item of twelve-pence for his loss at tennis and three-pence for the loss of balls, it may be inferred that the game was played abroad, as the loss of balls is not likely to have happened in a tennis-court. Be this as it may, in the sixteenth century tennis-courts were common in England, and the game was very popular with the nobility, which it continued to be down to the reign of Charles II., who frequently diverted himself by playing at tennis with his courtiers. Tennis-courts were divided by a line stretched in the middle, and the players, standing on each side with their rackets in their hands, were required to strike the ball *over* this line. A similar game was sometimes played with a hollow leather ball, inflated with air, and called a *balloon*, which was driven from one player to another by striking with the hand, or with a wooden bracer fixed upon the hand and lower arm. Further particulars respecting these and other games played with a ball may be found in Strutt's 'Sports and Pastimes,' and 'Horda-Angel-Cynnan.'

TENON, JACQUES-RE'NE', an eminent French surgeon, whose father also belonged to the medical profession, was born in 1724. He went to Paris in 1741, where his zeal and talents soon gained him the notice of Winslow, and also of Antoine and Bernard de Jussieu. The first of these celebrated men initiated him in the study of anatomy; the two others developed in him a taste for botany and natural history. In spite of the prejudices and example of his contemporaries, Tenon understood that surgery, far from being separated from the other branches of medical science, and restricted to the mere performance of operations, is on the contrary most strictly united to them. Accordingly from this time he had a wider field opened to him for his professional labours; and he united to the study and treatment of surgical affections minute anatomical investigations and ingenious physiological experiments. In a short time he acquired a well-merited reputation; and though inferior to some other modern French surgeons in skill and genius for that particular department of science, yet few have surpassed him in the extent of his studies and the variety of his information. In 1744 Tenon was appointed an army surgeon of the first class (*chirurgien de première classe aux armées*), and served in the following year throughout the campaign in Flanders. On his return to Paris he obtained by competition (*au concours*) the situation of chief surgeon to the hospital of La Salpêtrière, and founded near it a celebrated establishment for inoculation, a practice which his labours contributed much to propagate. He afterwards became a member of the College and of the Royal Academy of Surgery, and succeeded Andouillé as professor of pathology. In 1757 he was received into the Academy of Sciences. Tenon belonged to the first Legislative Assembly, and there displayed the same zealous philanthropy which seemed to belong to all his actions. Upon the re-organization of the learned societies, he became a member of the Institute of the first class, and read in that assembly many interesting papers. He was also a member of the Legion of Honour and of several learned and scientific societies, and preserved to the end of his life the same love of labour and the same zeal for the advancement of science which had marked the early years of his career. He died at Paris, on the 15th of January, 1816, at the advanced age of ninety-two. Few persons have written so many memoirs and monographs as Tenon; many of these have only been published in the annual analysis of the proceedings of the Institute: he is also said to have left behind him a great number of manuscripts. More than thirty of his works are mentioned in the *Biographie Médicale*, of which the following are the most important:—'De Cataracta,' Paris, 1757, 4to. 'Mémoires sur l'Exfoliation des Os,' read before the Academy of Sciences in 1758, 1759, and 1760, and afterwards printed, together with some others, with the title 'Mémoires sur l'Anatomie, la Pathologie, et la Chirurgie,' Paris, 1806, 8vo. 'Mémoire sur les Hopitaux de

Paris,' Paris, 1788, 4to.; a very able memoir, which served as a model for many that have been since written on the same subject, in which are pointed out all the improvements that have been introduced in French hospitals. His last work, which was published when he was ninety years old, is entitled 'Ouvrage de quelques Moyens pour prolonger la Vie.' TENOR, the name of the most common of male voices, that which is between the extreme highest and lowest, or Contratenor [ALTO] and [BASE-VOICE.] The compass of the Tenor is from second space in the base, to *c*, the second line treble. Example, in the tenor clef:—

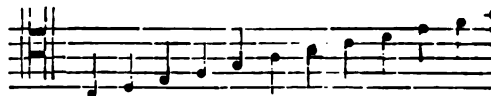

Hence it will be seen that the tenor and treble are procally at the distance of an octave; consequently is calculated for the one voice, as relates to compass at a distance of eight notes, invariably suit the of.

The word is derived from *Teneo*, to hold; for in part-compositions, the plain-song, or air, if it may be denominated, was given to, or held by, the Tenor. [TENOR-CLEF is the *c*, or mean clef, placed on the line for the use of the tenor-voice. Example:—



It is also occasionally used for the violoncello; part of the tenor trombone is written in this clef.

TENOR is also the English name for a larger instrument of the violin kind. See VIOLA.

TENOS (Τήνος), now Tino, a small island in the Archipelago lying to the south-east of Andros, between that island and Myconus, and forming one group called the Cyclades. S. Nicolo, on its north is in 37° 30' N. lat. and 25° 15' E. long. It is 15 miles long, and its greatest length is from west to south-east. It was antiently called *En* because it was well watered (*καράριον*) Byzant., v. *τήνος*; Pliny, *Hist. Nat.* iv. 12; and (Strabo, p. 487, ed. Casaub.), because it abounded in the time of the Persian invasion of Greece a trireme rendered good service to the Greeks by coming from the enemy, and giving intelligence of their movements immediately before the battle of Salamis. The name of the Tenians was in consequence inserted in the tripod at Delphi in the list of states to whom was indebted for the repulse of the invader. Herodotus (82.) According to Pausanias (v. 23) the Tenians among those whose names were inscribed on the tripod of Jupiter at Olympia, dedicated by the Greeks fought at Platæa. The island paid tribute to Athens during the Peloponnesian war. (Thucyd., vii. 57.) taken, and the inhabitants enslaved by Alexander of Pheræ, b.c. 362. (Demosthen. in *Polycl.* 137. 1 Clinton, *Fasti Hellen.*, a. 362.) In the reign of Trajan when the Roman senate instituted an inquiry into the rights and privileges attached to temples in the provinces of the empire, the Tenians quoted an oracle of Apollo which they had been commanded to consecrate a temple to Neptune. Tacitus, *Annal.* iii. 63. temple was of considerable size, as appears from (p. 487), and on the coins of Tenos the trident of Neptune is a common type; on the reverse there is usually a bunch of grapes. The island is still celebrated for its vine which about twenty sorts are grown.

TENREC. *Centetes*, Ill.; *Centetes*, Desm.; Geoff. The Tenrecs may be considered—indeed they have been considered by most zoologists—as Hedgehogs without the power of rolling themselves up into a ball. They were not included in the genus *Echinaceus* of Linnæus; he left it, in his last edition of the *Systema Naturæ* (12th), but in the 13th (Gmelin's) all the known species were included under that genus. They have no regular nocturnal for the most part in their habits, feed on insects; lie dormant during a considerable portion of the year that during the hot season, and have the skin beneath the spines or spine-like bristles.

this genus that we first find the jugal bone wanting in the Insectivora.

Geographical Distribution and Habits of the Genus.—Remarks that three species are found in Madagascar, of which, the *Tenrec*, properly so called, *Centetes* (*Erinaceus ecaudatus*, Gmel.) is, he observes, found at the Isle of France.

Swainson (*Classification of Quadrupeds*) states that the division of the family SORECIDÆ is composed like animals, apparently connected to the Shrews, American *Scalops* and the African *Chrysochloris*, it includes but three genera. [SORECIDÆ, vol. 261.] Of the Tenrecs (or Tendiracs as he writes) he treats as animals peculiar to Madagascar, only as capable of domestication as their European counterparts. 'Although inhabiting a warm region, proper Swainson, 'they are said to pass the three months of the year in a state of torpidity: this, it is owned, is a singular circumstance, and is the only record of an animal hibernating, so to speak, in the month of summer. In other respects they feed like the European Hedgehog, and are nocturnal animals.' The peculiarity of the circumstance vanishes when we find that in which the Tenrec becomes dormant is not the warm season, but the dry season, and the apparent torpidity becomes another instance of the harmony of nature in which prevails throughout nature. A suspended active powers of life becomes absolutely necessary in insectivorous quadrupeds, because there must be seasons when they would find no food.' Our usual mode of retiring, in order to give way to this nature, is hibernation; because, in our latitudes, this nature of worms and insects takes place in winter. Bats, Hedgehogs, and Shrews lay themselves up in winter to return to call forth their prey. But in Madagascar the dry season is that in which the absence of insects occurs; and then it is that the Tenrec is in its half living and half dead state.

Formula:—Incisors $\frac{6}{6}$; canines $\frac{1-1}{1-1}$; molars

40.

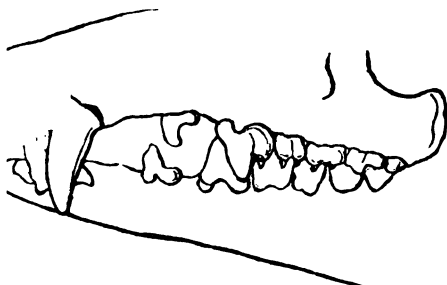
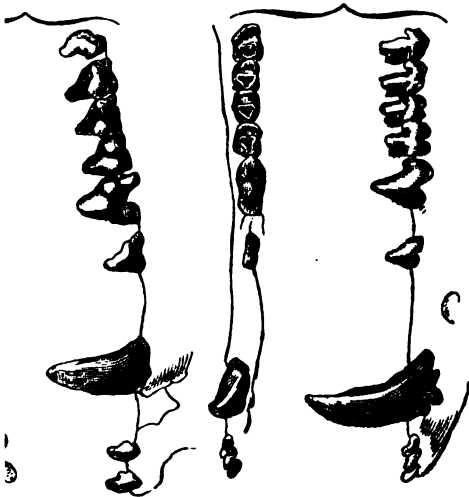

of Tenrec, one-third larger than the natural size. (F. Cuv.)
The classification assigned by Cuvier to the Tenrecs is be-

tween the Hedgehogs (*Erinaceus*, Linn.) and *Cladobates*. [TUPAIA.]

Cuvier remarks that the muzzle of the Tenrecs is very pointed, and that their teeth are very different from those of the Hedgehogs.

Generic Character.—Body spiny; not capable of being rolled up into a ball, as in the Hedgehogs; muzzle elongated; five toes on each foot, separated and armed with crooked claws.

Examples.—The species are called Tenrec and Tendirac; but the latter name is confusedly applied to at least two species.

Of the first, the *Centetes ecaudatus*, Ill., is the largest, exceeding our Hedgehog in size. It is covered above with long flexible spines, except on the vertex and occiput, and has no coloured bands: the under part of the body is clothed with hairs or bristles only, which are yellowish, mixed with some longer black ones. Baron Cuvier, who is followed by Lesson, states, in his last edition of the *Règne Animal*, that this species has only four incisors in the lower jaw; but M. F. Cuvier, who makes the number six in each jaw, says that his illustration is taken from *Cent. ecaudatus* and *Cent. setosus*; and Fischer gives the same number.



Centetes ecaudatus.

Centetes setosus, Ill.—The *Tendirac* of Buffon and Zimmerman—is less than the former, and the spines are short and rigid.

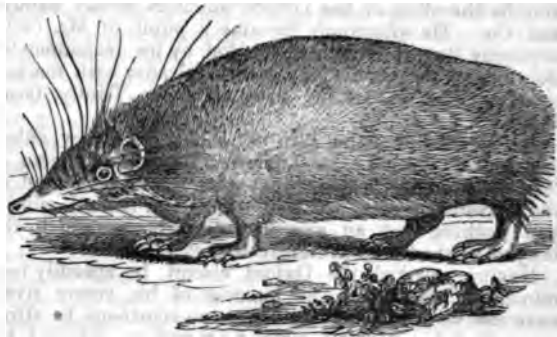

Tenrecs.

The *Centetes semispinosus* is still less, and hardly so large as a common mole. Its body is clothed with a mixture of spines and bristles, and is banded longitudinally with yellow and black.



Striped Tenrec.

TENSION (Mechanics), the name given to the force by which a bar or string is pulled, when forming part of any system in equilibrium or in motion. Thus when a weight is supported by a string, the tension of the string is the weight which is suspended to it. Every point of the string may be considered as a point of application of two equal and opposite forces, downwards and upwards, each equal to the weight applied.

TENTERDEN. [KENT.]

TENTERDEN, CHARLES ABBOTT, LORD, born at Canterbury, on the 7th of October, 1762, was the son of a barber, who has been described as 'a tall, erect, primitive-looking man, with a large club pigtail, going about with the instruments of his business, and attended frequently by his son Charles, a youth as decent, grave, and primitive-looking as himself.' He was entered in 1769 on the foundation of the king's school of the cathedral, under Dr. Osmund Beauvoir, who is stated by Sir Egerton Brydges to have been an admirable classical scholar, of fine taste, and some genius. Sir Egerton, who for some years held the place next to Abbott in the class, speaks of him as remarkable even in his school-boy days for accuracy, steadiness, and equality of labour; as well acquainted with the rules of grammar, sure in any examination or task, and a tolerably correct writer of Latin verses and prose themes.

In the beginning of 1781 Abbott was elected scholar of Corpus Christi College, Oxford, with an allowance, including his exhibition, of 50*l.* a year. His mathematical acquirements are said by his friends to have been considerable. In 1784 he obtained the chancellor's medal for the best Latin verses on Lunardi's balloon, 'Globus Aerostaticus;' in 1786 his essay 'On the Use and Abuse of Satire,' obtained the chancellor's medal for the English essay. This essay displays the turn for neat, lucid, and exhaustive arrangement, which was the most marked feature of his matured intellect, and also a good deal of that want of passion and imagination which, perhaps as much as any of his positive qualities, contributed to his judicial eminence. He was elected a fellow of his college, and appointed junior tutor to Mr. (afterwards bishop) Burgess.

By the advice of Mr. Justice Buller, whose son was one of his private pupils, Abbott entered himself of the Inner Temple in 1788. He also, in compliance with the suggestion of the same experienced lawyer, attended some months the office of the London solicitors Messrs. Sandys and Co. He afterwards became a pupil of Mr. (subsequently Baron) Wood; and, aided by his recommendation, began to practise as a special pleader with marked success. He was called to the bar in Trinity term, 1795.

He married, on the 13th of July, 1795, Mary, eldest daughter of John Logier Lamotte, Esq., a gentleman of fortune in Kent. It is said that when the father hinted at the expediency of a marriage-settlement, Abbott said he had nothing but an excellent law-library, which the lawyers might tie up as tightly as they pleased.

Having selected the Oxford circuit, he speedily rose into great business. The jealousy of his young rivals gave rise to rumours of his being too courteous to attorneys; but by whatever means he may have obtained his position, he kept it by the preference the leaders evinced for a junior who could often suggest a case in point, and was master of all the technicalities of pleading. To this he owed his appointment, by Sir Vicary Gibbs, when solicitor-general, to the office known among the members of the bar by the name of treasury-devil, the junior counsel to whose care the business of government is intrusted. In this character he took part in most of the numerous state-trials which occurred about the close of last century. As his character became established, he was appointed standing counsel to the Bank and other great mercantile communities. When the returns of the income-tax were called for, Mr. Abbott's account was looked upon as a curiosity, both for its minute accuracy and for the largeness of the sum-total of his fees during the past year—802*l.* 5*s.*

In a sketch of Lord Tenterden, which appeared in the sixty-ninth volume of the 'Edinburgh Review,' Lord Brougham says of his career at the bar:—'As a leader he very rarely, and by some extraordinary accident only, appeared; and this in a manner so little satisfactory to him-

self, that he peremptorily declined it whenever feasible; and he seemed to have no notion of a duty beyond exposing the pleadings and the law of case to the jury, who could not comprehend them with his explanation. His legal arguments, of which years the books are full, were extremely good, reaching any very high pitch of excellence; they quite clear, abundantly full of case law; betokening dread of grappling with principle, and displaying none the felicitous commentary that marked Mr. Holbrod's.

In 1802 Mr. Abbott published his 'Treatise of Law relative to Merchant-Ships and Seamen.' This gone through many editions: it exhausts the well arranged, and well written: its merits have repeatedly acknowledged: it is one of the best E treatises.

In 1808 Mr. Abbott was offered a seat on the bench, but declined from prudential motives, his professional income far exceeding the salary of a judge. As years grew upon him however, and his fortune increased, he began to long for the comparative repose of the bench. In February, 1816, he was offered a seat as puisne judge in the Court of Common Pleas, and accepted it. In May of the same year, on the death of Mr. Justice Le Blanc, he yielded to the importunity of Lord Ellenborough, and was chosen to supply the vacancy in the Court of King's Bench, and was knighted about the same time. On the 4th of November, 1818, Sir Charles Abbott succeeded Lord Ellenborough as chief-justice of that court.

It has been alleged that at the outset of his career chief-justice Abbott was apt to lose himself in the minute details of the cases which were him. It is allowed at the same time that seven or eight years of his time he took comprehensive views of questions, and displayed judicial capacity. He had learned to deal with his law was, as it always had been, safe, accurate, ready. His statements and decisions were direct, succinct, and appropriate language. He to over-curious subtleties; loved to overrule objections both in civil and criminal pleadings; a great anxiety to make his decisions accord with common sense and substantial justice. Perhaps he most in the management of arguments which recombination of scientific with legal knowledge: him preside over a complicated patent case a great treat, whether to a lawyer or a man of science reasonable distinction, a reasonable interpretation of law, were his favourite phrases. He was, as every and judicious lawyer must be, rather impatient check of a jury; and was not always able to temper in command when arguing with the impartiality, as far as the parties were concerned, questioned. 'It was an edifying sight,' says Lord ham, 'to observe Lord Tenterden, whose temper visibly affected during the trial (for on the bench not always that entire command of it which we have scribed him as possessing at the bar), addressing to the points in the cause with the same perfect and indifference with which a mathematician abstract truth; as if there were neither the advocates in existence, and only bent on the elucidation of truth.' Chief-Justice Abbott to support the executive authority on all beyond a doubt excessive; but this appears to be the consequence of temperament and very early ciations: it shows itself even in his prize essay Satire.

Sir Charles Abbott was raised to the peerage in 1822 the title of Baron Tenterden. He made a successful as a speaker in the House of Lords in support Turner's divorce bill; he pertinaciously opposed ing of the Corporation and Test Act Repeal Bill; the most impressive speaker against the Roman Relief Bill. His judicial labours rendered him next two years an unfrequent attendant in the House of Lords; but he recorded his protest against the Bill. He took at the same time an active part in the preparation of legislation. Among his well-studied prepared acts are—9 Geo. IV., c. 14, for the law as to the limitation of actions; 10 Geo. IV., c. 15, to prevent the case; 9 Geo. IV., c. 15, to prevent by reason of variances between records.

evidence; 1 Will. IV., c. 21, Mandamus and Injunction Act; 1 Will. IV., c. 22, Interrogatories Act; 1 Will. IV., c. 58, Interpleader Act; 2 & 3 Will. IV., c. 71, Form of Process Act; 2 & 3 Will. IV., c. 71, on Acts; and (prepared under his sanction) 3 & 4 Will. IV., c. 27, for the limitation of actions and suits on real property, and for simplifying the remedies in the rights thereto.

His political opinions were of the kind generally un- to predominate at Oxford, so his literary tastes were the impress of his University education. When he was called to the bar, he was, like Mr. Scarlett, on the trial of Mr. Hunt for the publication of 'The Vision of Judgment,' alluded to the Lord Byron as familiar to the jury, Lord Tenterden not to repress the observation that, for himself, he was bred in too severe a school of taste to admire many poets.' His favourite recreations during the time were the perusal of the classics, the study of the composition of Latin verses on flowers, &c. He founded and endowed, in the grammarian's native city, two annual prizes; the one for the best Latin essay, the other for the best Latin verse. In the discharge of his public duties, he was of a mind narrow, it may be, and unimpassioned, but dexterous, and elegant.

For several years he was overclouded with ill-health, and was assailed by the aspect of public affairs. He nevertheless discharged assiduously the duties of his profession. He presided for the two first days at the trial of the Duke of Bristol for misconduct during the riots in London at the time of the Reform Bill, but on the third day he was confined to bed by a violent attack of inflammation of the lungs, which baffled the skill of his physicians, and he died on the morning of Sunday, November 4, 1832. He was buried in the church of St. Dunstons, and died on the 19th of December following. He was survived by two sons, one of whom succeeded him in the title, and two daughters.

Materials for this article have been found in a notice of Lord Tenterden in the Obituary of *The Gentleman's Magazine* for December, 1832; in a 'Life of Lord Tenterden' which appeared in the 26th volume of *The Gentleman's Magazine*, pp. 51-87; in a sketch of the 'Judicial Career of Lord Tenterden' by Mr. Sergeant Talfourd, in a volume of the same work, pp. 234-6; and in a notice of his career and character by Lord Brougham in a volume of the *Edinburgh Review*, pp. 14-23. There is also a portrait of Lord Tenterden taken by Owen in 1815, engraved in mezzotint in a quarto form by S. B. B. and another by C. Penny engraved by H. B. B. A cast for a bust was taken from his countenance in 1815.

TENTH, a genus of Hymenopterous insects of the order Terebrantia. The genus *Tenthredo* of Linnæus was formerly regarded as constituting a family, to which the name *Securifera* has been applied by Latreille, and *redimidæ* by Leach.

Leach restricts the generic term *Tenthredo* to those species which have nine joints to the antennæ, and in which the basal segments are not distinctly thickened at the base. The larvæ have from eighteen to twenty-two feet. *Tenthredo* is however still further restricted by other authors, and it is especially to Dr. Leach (*Zoöscellany*, vol. iii.) that we are indebted for pointing out distinguishing characters for the subdivisions of this extensive Linnean genus. By this author the *redimidæ* are divided chiefly according to the structure of the antennæ, and the cells enclosed by the nervures. The first section, according to Dr. Leach, consists of those species which have the antennæ short and the third joint long; the wings with two marginal and three submarginal cells. This section includes the genera *Cimbex*, *Trichiosoma*, *Cladonia*, *Abia*, &c.

Species of the second section have the antennæ of moderate length, filiform, and composed of three joints; the third joint long, slightly thickened at the extremity, males ciliated, and sometimes forked. It contains the genera *Hylotoma* and *Schizocerus*. The characters of the third section are—antennæ short, with nine or ten joints; the third joint longer than the fourth; body increasing in thickness towards the apex. Genera: *Andria*, and *Fenusia*.

4.—Antennæ composed of nine joints, moderate

length; body moderately long; upper wings with two marginal cells. To this section belongs the genus *Tenthredo* as at present restricted; it is distinguished by the upper wings having four submarginal cells, and the antennæ with the third and fourth joints of equal length. The genus *Allantus* differs only from *Tenthredo* in having the third joint of the antennæ longer than the fourth. The *Allantus scrophulariæ* is a very common species in this country, and is found on the scrophulariæ, on the leaves of which its larvæ feed. The perfect insect somewhat resembles a wasp, but is of a rather more slender form; it is black, and has the body adorned with yellow rings; the legs (with the exception of the thighs) and antennæ are also yellow. The larva, which is provided with twenty-two feet, is white and has black dots, and the head is black. When touched it rolls itself up in a spiral manner, as indeed do the larvæ of other *Tenthredinidæ*.

Section 5.—Superior wings with but one marginal cell; body short, narrower at the extremity in the males; antennæ simple, nine-jointed, slightly ciliated, increasing in thickness in the middle, and decreasing at the extremity. This section contains the genera *Cræsus*, *Nematus*, and *Cladius*, examples of each of which are found in this country.

Section 6.—Antennæ with numerous joints; body rather depressed; wings with two marginal and four submarginal cells. British genera *Tarpa*, *Lyda*, and *Lophyrus*. The larvæ of the species of *Lophyrus* live in society, more particularly on the pines, and are said to be very injurious to the young plants. The species of this genus are very rare in England. The antennæ are serrated in females, and in the males they are provided with a double series of denticulations.

TENTHS are the tenth part of the yearly value of all ecclesiastical livings. They were formerly claimed by the pope as due to himself by divine right, after the example of the Jewish high-priest who had of the Levites a tenth-part of the tithes; and his claim was sanctioned, in this country, by an ordinance in the 20th year of Edward I., when a valuation of all livings was made, in order that the pope might know the amount of his revenue from this source. The possessions afterwards acquired by the church were not liable to the payment of tenths to the pope, as all livings continued to be charged according to that valuation. (Coke, 2 *Inst.*, 627.) When the authority of the pope was extinguished at the Reformation, Henry VIII. transferred the revenue arising from tenths to the crown, and had a new valuation of all the livings, so as to obtain the tenth of their true yearly value at that time. (26 Hen. VIII., c. 3, s. 9-11.) By royal grants under 1 Eliz., c. 19, s. 2, the Archbishop of Canterbury and the Bishop of London were exempted from tenths and were also authorized to receive the tenths of several benefices as a compensation for certain estates which were alienated from their sees. By the 6 Anne, c. 24, all benefices were discharged from the payment of tenths which, at that time, were under the annual value of 50*l.*, except those of which the tenths had previously been granted by the crown to other parties. There are also some other special exemptions. At the present time, out of 10,498 benefices, with and without cure of souls, there are 4898 which remain liable to tenths. (*Parl. Rep. First-Fruits and Tenths*, 1837, No. 384.) Queen Anne gave up the revenue arising from tenths, as well as from first-fruits, which had been enjoyed by her predecessors since the Reformation, and by act 2 and 3 of her reign, c. 11, assigned it to the augmentation of poor livings; for which purpose she erected a corporation by letters patent in 1704 to administer the funds, called the Governors of Queen Anne's Bounty. This act declared that Episcopal sees and livings not exempted should continue to pay in such rates and proportions only as heretofore, or according to the valuation of Henry VIII., commonly known as the 'King's Books.' Tenths under the act 1 Vict., c. 20, are collected by the Treasurer of the Governors of Queen Anne's Bounty. Payment is enforced by Exchequer process, when not duly made, and the treasurer is required to give notice of arrears within one month after the proper time of payment. In case of a living being vacated, the Exchequer is empowered by act 26 Hen. VIII., c. 3, s. 18, to recover arrears of tenths, not only from the executors and administrators, but also from the successor of the last incumbent. (2 Burn's *Ecclesiastical Law*, 9th ed., pp. 273-295.) [FIRST-FRUITS, TAXATIO ECCLESIASTICA; TITHES.]

TENTZEL, or **TENZEL**, **WILHELM ERNEST**, a German historian and antiquarian, was born in 1659, at Greussen in Thuringia, where his father was pastor. After the completion of his school education he went, at the age of eighteen, to the university of Wittenberg, where he chiefly devoted himself to the study of the antient and Oriental languages in connection with history. In 1685 he was appointed teacher at the gymnasium of Gotha, and was at the same time intrusted with the care of the collection of antiquities and coins belonging to the Duke of Saxe-Gotha. Several learned dissertations which he published shortly after this time attracted the attention of his learned countrymen, in consequence of which he became a very active contributor to the 'Acta Eruditorum,' and to the 'Observationes Hallenses.' Tentzel was the first German who conceived the idea of establishing a German journal for reviewing new books and for publishing interesting essays. This periodical was set on foot in 1689, under the title 'Monatliche Unterredungen einiger guten Freunde von allerhand Büchern und andern annehmlichen Geschichten.' The undertaking had great success, and was carried on till 1698. The whole was published in monthly parts, and consists of ten volumes. The extensive knowledge of history, especially of the history and antiquities of Germany, procured Tentzel, in 1696, the honourable post of historiographer to the house of Saxony of the Ernestine line. Before he commenced writing on the history of Saxony he travelled through the greater part of Germany, visiting several courts and examining various libraries to find materials. In 1702 the elector of Saxony (also king of Poland) conferred upon Tentzel the title of councillor, and made him historiographer of the electorate. In this capacity Tentzel took up his residence at Dresden, and was frequently obliged to appear at court. But the simple honesty and straightforwardness of the man made him a subject for ridicule among the ignorant and idle courtiers, and as soon as Tentzel became aware of it he resigned his office and retired to private life, devoting himself entirely to his historical and antiquarian studies. He died on the 24th of November, 1707, in great poverty.

Besides the numerous essays in the periodical publications mentioned above, the following separate works of Tentzel deserve to be mentioned: 'De Ritu Lectorum Sacrarum,' Wittenberg, 1685, 4to.; 'Exercitationes Selectæ, in duas partes distributæ,' Leipzig, 1692, 4to.; 'Epistola de Sceleto Elephantino Tonniæ nuper effosso,' Gotha and Jena, 1699, 12mo.: 'Von dem Alter der Buchdruckerkunst,' Gotha, 1700, 12mo.; this interesting work is translated into Latin and incorporated in Wolf's 'Monumenta Typographica,' ii. 644, &c. The principal work of Tentzel is his 'Saxonia Numismatica, sive Nummophylacium Numismatum Mnemonicorum et Iconicorum à Ducibus Saxonie cudi jussorum,' Frankfort, 1705, 2 parts in 4to. He also continued the history of Gotha which had been commenced by Caspar Sagittarius, in two supplementary volumes. His history of the Reformation, 'Historischer Bericht vom Anfang und Fortgang der Reformation,' which was edited by E. S. Cyprian, in 2 vols. 4to., Leipzig, 1718, is a valuable work, which should still be consulted by the student of that important period.

(Jöcher, *Allgem. Gelehrten-Lexicon*, iv., p. 1057, &c.; *Conversations-Lexicon*, s. v. 'Tenzel'.)

TENUIPEDES, Lamarck's second division of the *Conchifera Dimyaria*, consisting of the *Mastracea*, *Corbulacea*, the *Lithophaga* (*Saxicola*, *Petricola*, and *Venerupis*), the *Nymphacea*, the *Cardiacea*, the *Trigonacea*, the *Naiades*, and the *Chamacea*.

In the first division, *Crassipèdes*, are comprised the *Tubicolæ*, the *Solenacea*, and the *Myaria*.

M. Deshayes, in the last edition of Lamarck, objects, and we think with reason, to these divisions as being defective; nor does he consider the arrangement capable of amelioration, because the principal character is too exclusive. He observes that to follow it rigorously it would be necessary to break very natural links which bind certain genera together.

TENUIROSTRES. Cuvier made the *Tenuirostres* the fourth family of his *Passeraux*, placing it between the *Conirostres* and the *Syndactyles*, and comprising under it the genera *Sitta*, Linn. (with the subgenera *Xenops*, Ill.; *Anabates*, Temm.; and *Synallaxis*, Vieill.); *Certhia*, Linn. (with the subgenera *Certhia*, Cuv.; *Dendrocolaptes*, Herm.; *Tichodroma*, Ill.; *Nectarinia*, Ill.; *Dicaeum*, Cuv.; *Melithreptus*, Vieill.; *Cinnyris*, Cuv.; and *Arach-*

nathera, Temm.); *Trochilus*, Linn. (dividing it into the Humming-birds properly so called, or *Trochilus*, Lacép.; and the *Oiseaux Mouches*, or *Orthorhynchus*, Lacép.); *Upupa*, Linn. (with genera *Fregilus*, Cuv.; the Hoopoes properly *Upupa*, *Promerops*; and *Epimachus*).

Mr. Vigors, after pointing out the place of one the Linnæan *Certhiæ* which climb and feed food among the *SCANSORES*, and that of the one which live only on the nectar of flowers, and formed for perching only [CREEPER, vol. viii. thus enters the family now before us, and (the *Suctorial Birds* as the most interesting perhaps of the animal world. [SUNBIRDS, v. p. 284.] He remarks that the aberrant families order are so numerous in their forms, and hitherto been so unsatisfactorily characterized, that it is to speak of them with that certainty which observations on better defined groups. The genus *Promerops* appears to him to be that form of the present which approaches nearest to the adjoining tribe *ROSTRIS*. Retaining, Mr. Vigors observes, the name of the *Tenuirostres*, *Promerops* exhibits somewhat broad base of the bill of the *Fissirostres*, and, at the same time, the gressorial feet. By means of *Merops*, by the curved bill of which approaches the structure of its own, it appears to be immediately connected with the *ROSTRIS* group. 'Of the limits of this family, which its appellation from M. Brisson's above-meantime continues Mr. Vigors, 'I can say nothing as yet. I do wish to enter into more than a general view of the succeeding family of *Meliphagidæ*.' (See for this.)

The families admitted by Mr. Vigors into the *INSESSORES* will be found in the article *St. cit.*

Mr. Swainson (to whose publication on this subject the 1st vol. of the 'Zoological Journal,' which appears in the paper *On the Natural Affinities that connect the Orders and Families of Birds* was sent to press, refers), in his tenth chapter of the second volume, 'Classification of Birds,' remarks, that the most division of the *inseorial* order is that of the *Tenuirostres* or honey-suckers, so called from the great majority of their subsistence both from insects and the nectar which they suck up by means of a long or forked tongue adapted for the purpose. 'As these birds,' Mr. Swainson in continuation, 'are further removed from the types of their order, they consequently show less affinity to the *Scansores* on one hand, and to the *Proserpes* on the other, than to the more perfect types of the perchers, as seen in the *Dentirostres* and *Conirostres* like the *scansorial* creepers, the bill is slender, feet very short; but there the comparison ceases, as *scansorial* birds derive their food entirely from insects, and, in general, have a simple and pointed tongue, those we are now to consider are chiefly extractors of vegetable juices, extracted by means of a very long and always retractile, and either simply forked, or divided into so many slender filaments as to resemble a painter's brush; the bill moreover is so soft or delicate, that it is incapable of grasping food, and appears, in the groups, principally intended to protect the tongue, the chief member by which life is supported.'

Mr. Swainson includes the following families in the tribe:—*MELIPHAGIDÆ*; *Cinnyridæ* [SUNBIRDS]; *LIDÆ* (Humming-Birds); *PROMEROPIDÆ* (Hoopoes); *PARADISIDÆ* [BIRDS OF PARADISE].

The *Tenuirostres* are placed by this author between the *SCANSORES* and the *FISSIROSTRES*.

M. Lesson makes the tribe *Tenuirostres* (which ranges between the *Latirostres* and the *Syndactyles*) consist of the following families and genera:—

1. *Promeropidæ*.

Genera.—*Upupa*; *Promerops*.

2. *Certhiidae*.

Genera.—*Certhia*; *Tichodroma*; *Dendrocolaptes*; *mactensis*; *Furnarius*; *Cæreba*; *Dicaeum*.

3. *Philetonidæ*.

Genera.—*Drepanis*; *Cinnyris*; *Pomatorhinus*; *Orthotomus*; *Myzomela*; *Myzantha*; *Anthus*; *Tropidorhynchus*; *Melisiuga*.

4. *Trochilidæ*.

Genera.—*Polytmus*, Brisson; *Ornisigma*, Lesson.

G. R. Gray's 'List of the Genera of Birds' (2nd ed.), a work remarkable for its accuracy and the condensed labour which it contains, the *Tenuis* and the second tribe of Insectores, between the *es* and the *Dentirostres*, and comprise the families, subfamilies, and genera:—

1. Upupidæ. (See the article.)
2. Nectarinidæ. [SUNBIRDS.]
3. Trochilidæ. (See the article.)
4. Meliphagidæ.

Subfamily 1. *Myzomelinae*.

—*Myzomela*, Vig. and Horsf. (*Phylidonyris*, *erthia*, Gm.; *Meliphaga*, Vig. and Horsf.): *Acanthus*, Gould (*Leptoglossus*, Sw.; *Melithreptus*, *Certhia*, Lath.; *Meliphaga*, Vig. and Horsf.): *a*, Sw. (*Meliphaga*, Lew.).

Subfamily 2. *Meliphaginae*.

—*Meliornis*, G. R. Gray (*Certhia*, Lath.; *Melie-w.*; *Philedon*, Cuv.; *Strigiceps*? Less.): *Pro-s.*, G. R. Gray (*Merops*, Lath.; *Anthochaera*, Vig.); *Philemon*, Vieill.; *Sturnus*, Daud.; *Meli-temm.*; *Philedon*, Cuv.): *Ptilotis*, Sw. (*Meli-ew.*; *Philemon*, Vieill.; *Certhia*, Lath.): *Ang.* G. R. Gray (*Anthomyza*, Sw.; *Melithreptus*, *Furnarius*, Steph.; *Certhia*, Sparr.; *Philedon*, *Philemon*, Vieill. (*Anthochaera*, Vig. and Hors.; Gm.; *Meliphaga*, Temm.; *Philedon*, Cuv.): *s.*, Boie (*Turdus*, Gm.; *Chloropsis*, Jard. and *eliphaga*, Horsf.): *Meliphaga*, Lew. (*Zantho-r.*; *Merops*, Lath.; *Philemon*, Vieill.; *Antho-g.* and Hors.; *Xanthomyza*, Strickl.; *Philedon*, *Anthochaera*, Vig. and Hors. (*Creadion*, Vieill.; Cuv.; *Merops*, Lath.): *Acanthogenys*, Gould *era*, Fras.): *Entomyza*, Sw. (*Gracula*, Lath.; *.*, Vieill.; *Gymnops*, Cuv.; *Entomyzon*, Sw.; *hynchus*, Vig. and Hors.; *Meliphaga* (Lew.), *Tropidorhynchus*, Vig. and Hors. (*Philedon*, *lerops*, Lath.; *Meliphaga*, Temm.; *Gymnops*,

Subfamily 3. *Melithreptinae*.

—*Plectorhynchus*, G. R. Gray (*Plectorhyncha*, *Manorhina*, Vieill. (*Myzantha*, V. and H.; *Phi-Less.*; *Gracula*, Lath.): *Psophodes*, V. and H. *a*, Lath.; *Timalia*? Sw.): *Eidopsarus*, Sw. Wagl.); *Melithreptus*, Vieill. (HEMATOPS, Gould; *rys*, Sw.; *Meliphaga*, Temm.; *Philedon*, Cuv.; *a*, V. and H.; *Certhia*, Shaw): *Entomophila*,

5 Certhidæ.

Subfamily 1.

—*Cinclodes*, G. R. Gray (*Furnarius*, Less.; *inchus* (Temm.), Gould and G. R. Gray; *Upu-Orb.*; *Motacilla*, Gm.): *Upucerthia*, J. Geoffr.; *s.*, Vieill. (*Opetiorhynchus*, Temm.; *Figulus*, *lerops*, Gm.; *Turdus*, Licht.): *Geositta*, Sw. *uda*, D'Orb.; *Furnarius*, G. R. Gray; *Alauda*, *Lochmias*, Sw. (*Picerthia*, J. Geoffr.): *Enicornis*, *ia* (*Eremobius*, Gould); *Ochetorhynchus*, Meyen *ia*? D'Orb. et Lafr.): *Limnornis*, Gould; *Scle-r.*: *Cinlocerthia*, G. R. Gray (*Stenorhynchus*,

Subfamily 2. *Anabitanæ*.

—*Synallaxis*, Vieill. (*Sphenura*, Licht.; *Pa-ix*; *Synallaxis*, D'Orb. et Lafr.): *Diglossa*, *rrirostrum*, D'Orb. et Lafr.; *Dendroma*, Sw.; *inchus*, Bonap.; *Uncirostrum*, D'Orb. et Lafr.): *.*, D'Orb. et Lafr. (*Annumbi*, Azara; *Furnarius*, *Sphenura*, Licht.; *Malurus*, Sw.; *Anabates*, *sthus*, Less.; *Synallaxis*, Gould); *Anabates*, *philydor*, Spix; *Sphenura*, Licht.; *Motacilla*, *nops*, Lafr.; *Oxyramphus*, Strickl. (*Oxy-Temm.*; *Oxyruncus* (olim), Temm.).

Subfamily 3. *Dendrocolaptinae*.

—*Dendroplex*, Sw. (*Nasica*, Less.; *Oriolus*, *ndrocolaptes*, Cuv. and Temm.): *Glyphorhyn-Max.* (*Sphenorhynchus* (olim), Pr. Max.; *Den-s.*, Licht.; *Sittacilla*, Less.; *Zenophasia*, Sw.; *a*, Strickl.): *Dendrocops*, Sw. (*Dendrocolaptes*, *ndrococina*, G. R. Gray (*Dryocopus*, Pr. Max.; *aptes*, Licht.): *Dendrocolaptes*, Herm. (*Den-Vieill.*; *Gracula*, Gm.): *Xiphorhynchus*, Sw. *laptes*, Temm., Cuv.; *Picolaptes*, Less.; *Den-Vieill.*): *Prolaptes*, Less. (*Ziphorhynchus*, Sw.; *aptes*, Spix; *Oxyurus*, Less.; *Dendroplex*, Sw.):

Sittasomus, Sw. (*Neops*, Vieill.; *Synallaxis*, Cuv.; *Den-drocolaptes*, Temm.).

Subfamily 4. *Certhinae*.

Genera:—*Certhia*, Linn.: *Oxyurus*, Sw. (*Synallaxis*, Less.; *Sylvia*, Lath.; *Motacilla*, Gm.): *Climacteris*, Temm. (*Petrodroma*, Vieill.; *Meliphaga*, Temm.): *Ti-chodroma*, Ill. (*Petrodroma*, Vieill.; *Certhia*, Linn.): *Geo-bates*, Sw.: *Tatara*, Less. (*Sitta*, Less.; *Turdus*, Gm.; *Thryothorus*, Quoy et Gaim.; *Oriolus*, Forst.).

Subfamily 5. *Sittinae*.

Genera:—*Sittella*, Sw. (*Neops*, Vieill.; *Sitta*, Lath.): *Sitta*, Linn.: *Dendrophila*, Sw. (*Orthorhynchus*, Horsf.; *Sitta*, Horsf.): *Dendrodromus*, Gould; *Xenops*, Hoffm. (*Neops*, Vieill.).

Subfamily 6. *Orthonyctinae*.

Genera:—*Orthonyx*, Temm.: *Mohoua*, Less. (*Certhia*, Quoy et Gaim.; *Muscicapa*, Gm.; *Orthonyx*, Less.).

Subfamily 7. *Troglodytinae*.

Genera:—*Rhinocrypta*, G. R. Gray (*Rhinomyza*, D'Orb. et Lafr.): *Menura*, Dav. (*Parkinsonius*, Bechst.; *Mega-podius*, Linn.; *Pteroptochos*, Kittl. (*Hylactes*, King; *Megalonyx*, Less.; *Leptonyx*, Sw.): *Scytalopus*, Gould (*Myiothera*, Pr. Max.; *Platyurus*, Sw.; *Motacilla*, Gm.; *Malacorhynchus*, Menetr.; *Sylvia*, Lath.; *Troglodytes*, Kittl.; *Sylviopsis*, Less.; *Leptonyx*, D'Orb. et Lafr.): *Mi-crourea*, Gould (*Micrura*, Strickl.): *Merularis*, Less. (*Platyurus*, Sw.; *Malacorhynchus*, Menetr.; *Merularis*, D'Orb. et Lafr.): *Thriothorus*, Vieill. (*Sylvia*, Lath.): *Campy-lorhynchus*, Spix (*Turdus*, Gm. et Licht.; *Cichla*, Wagl.; *Sphenura*, Licht.; *Opetiorhynchus*, Pr. Max.; *Picolaptes*, Lafr.; *Anumbius*, D'Orb. et Lafr.): *Rhampocænus*, Vieill. (*Troglodytes*, Sw.; *Acontistes*, Sundev.; *Scolopacinus*, Bonap.): *Troglodytes*, Vieill. (*Motacilla*, Linn.; *Anor-thura*, Renn.; *Regulus*, Briss.; *Lucinia*, Linn.).

Of these genera, Mr. G. R. Gray remarks that *Anthomyza* had been previously used in botany; *Plectorhyncha* and *Oxyrhynchus* in ichthyology; *Rhinomyza* in entomology; and that *Eremobius* is very like a word employed in that science; that *Dryocopus* had been previously used in *Picidæ* and *Stenorhynchus* for a crustaceous animal. *Stenorhynchus* has also been employed to designate a genus of SEALS. [Vol. xxi., p. 163.]

TENURE. The general nature of tenure and its origin and history in England are explained in the article FEUDAL LAW. A few remarks may be made here on tenure as at present existing by the law of England, for which purpose a short recapitulation is necessary.

All land was and is held of the king either mediately or immediately. All tenures were distributable under two general heads, according as the services were free or base; and consequently there was the general division of tenures into Franktenement or free-holding, and Villeinage. The act of Charles II. (12 Car. II., c. 24) abolished military tenures, which were one kind of free services, and changed them into the other species of free services, namely free and common socage. Thus one tenure in socage was established for all lands held by a free tenure, which comprehended all lands held of the king or others, and all tenures except tenures in frankalmoyne, copyhold, and the honorary services of grand-serjeanty; and it was enacted by the same act that all tenures which should be created by the king in future, should be in free and common socage. It is particularly provided in the act which abolishes military tenures, that it shall not alter or change any tenure by copy of court-roll, or any services incident thereto, nor take away the honorary services of grand-serjeanty, other than charges incident to tenure by knights' service.

Thus it appears that tenure is still a fundamental principle of the law relating to land in England.

AM the land in England in the hands of any layman is held of some lord, to whom the holder or tenant owes some service. It is by doing this service that the tenant is entitled to hold the land: his duty is a service, and the right of the lord is a seignory. The word tenure comprehends the notion of this duty and of this right, and also land in respect of which the duty is due: the land is a tenement. As already observed, all land is held either mediately or immediately of the king; and ultimately all land is held of the king. The ownership of land in England is therefore never unlimited as to extent, for he who is the owner of land in fee, which is the largest estate that a man can have in land, is not absolute owner: he owes services in respect of his fee (or fief), and the seignory

of the lord always subsists. This seignory is now of less value than it was, but still it subsists. The nature of the old feud was this: the tenant had the use of the land, but the ownership remained in the lord; and this is still the case. The owner of a fee has in fact a more profitable estate than he once had; but he still owes services, fealty at least, and the ownership of the land is really in the lord and ultimately in the king. For all practical purposes the owner's power of enjoyment is as complete as if his land were allodial, but the circumstance of its not being allodial has several important practical consequences.

No land in England can be without an owner. If the last owner of the fee has died without heirs, and without disposing of his fee by will, the lord takes the land by virtue of his seignory. If land is aliened to a person who has a capacity to acquire but not to hold land in England, the king takes the land; this happens in the case of lands being sold to an alien. The forfeiture of lands to the king for high treason and to the lord in cases of petty treason and murder are also consequences of tenure.

The case of church lands seems something peculiar. They are held by tenure, though no temporal services are due. This tenure was originally the tenure in frankalmoigne. By the tenure in frankalmoigne the tenant was bound 'to make orisons, prayers, masses, and other divine services for the soul of his grantor or feoffor,' &c. (Litt., s. 135); but he did no fealty. If land was given for 'certain divine service in certain to be done,' &c. (Litt., s. 137), the lord might distrain, and in this case it seemed the lord might have fealty; this tenure by certain service was not called tenure in frankalmoigne, but tenure by divine service. Coke, in his 'Commentary on Littleton' (86, b) observes, 'for this divine service certain the lord hath his remedy, as it here appears by our author, in *foro seculari*; for here it appears that if the lord distrain for not doing of divine service, which is certain, he shall upon his avowry recover damages at the common law, that is, in the king's temporal court, for the not doing of it.'

The Act which abolished military tenures could not from its terms affect tenure in frankalmoigne; but for greater caution it was declared that this act should not subject tenures in frankalmoigne to any greater or other services. Tenure in frankalmoigne therefore is now exactly what it was before the 12th of Charles II. was passed. Church lands then, which are held in frankalmoigne, still owe no services; but the lord of whom they are held must be considered the owner. And this conclusion is consistent with and part of the law of tenure, by which no land in England is ever without an owner. Church land differs from land held by laymen in this, that the beneficial ownership can never revert to the lord, for all spiritual persons are of the nature of corporations, and when a parson dies, the corporation sole (as he is termed by an odd contradiction in terms) is not extinct, and it is the duty and right of some definite person to name a successor. It is stated by Blackstone (i. 470) that 'the law has wisely ordained that the parson, *quatenus* parson, shall never die any more than the king, by making him and his successors a corporation; by which means all the original rights of the parsonage are preserved entire to the successor: for the present incumbent and his predecessors who lived seven centuries ago, are in law one and the same person.' But notwithstanding this ingenious attempt to make a man, together with others not ascertained, a corporation, the difficulty really is, that when a parson dies, there is no person who has a legal ownership of the land until a successor is appointed, if Blackstone's theory is true. The comparison of the case of a parson with that of the king is unapt, for the successor to a deceased king is ascertained by the death of his predecessor; but the successor of a parson is generally ascertained by the will of some other person being exercised, and till the person entitled to appoint a parson has named one, and he has been duly instituted, the lands of the church have no legal owner, unless the lord is the owner. This seignory may be worth nothing, but it still exists. The difficulty may indeed be solved without the supposition of a seignory still existing, and in the following manner. There is succession in the case of one parson succeeding another, for which the notion of a corporation is not necessary. The notion of succession is this: the right which is the object of the succession, continues the same; the subject, that is, the person, changes. In order to con-

stitute strict succession, the new owner begin at the moment when the former ownership or right is derived from and from former ownership or right. This is the case of the crown. In the case of a parson, when a parson is appointed, his right by a fiction of law commences at the time when his predecessor's right ceased, though the time which the Romans applied to the case of a parson who did not take possession of the hereditas till some time after the death of the testator or intestate. This doctrine is discussed by Savigny, *System des Römischen Rechts* vol. iii. When then the parson dies, the fee is considered to be in abeyance till the death of the successor, one of the few instances in which it is said that a freehold estate can be in abeyance.

No seignory, in the sense above explained, was created except by the king. It was enacted by the Statute of Quia Emptores (18 Edw. I.), that all feoffments in fee simple must be so made that the feoffee shall be tenant, by the same services by which the feoffor was tenant, by the same services by which the feoffor was tenant. Therefore all seignories exist now which existed at the time when the statute of Quia Emptores was made. A lord may release the services to a tenant; but it is consistent that the king could not release the services to him, for if that were the case land might be land without an owner, which is inconsistent with the fundamental principles of law in England. Still it is said that the king can release the services, and yet that the tenant is not tenant by this assumption of a still subsisting tenure above mentioned is avoided.

Tenure of an imperfect kind may be created. Wherever a particular estate is created, it is a reversioner by an imperfect tenure: this case of landlord and tenant. If no rent or services are reserved from the tenant of the particular life or years, the tenure is by fealty only, and the tenant is required to take the oath of fealty. But where a reversioner to whom services are due is reserved, the reversion, and is created at the time when the perfect tenure originated in the particular case, which the seignory of the lord was the legal owner of the land, and the tenant owed his service to him. The only perfect tenure now existing is the tenure, the services of which are certain, and which is called fealty, of some certain annual rent.

The right of wardship was one of the incidents of military tenures. The lord had a right to the custody of the infant tenant until he was twenty-one years of age; this right was in many respects prejudicial to the interest of the heir. This right was abolished with the abolition of military tenures. The right of guardianship of the person of a tenant in socage only continues to the present time, but the act of Charles II. (12, c. 24) gave a power by deed or will, executed as the statute requires, to appoint a guardian to any of his children till they should be of twenty-one, or for any less time. The right of wardship was the next of kin to the heir, and the guardian was from that line, whether paternal or maternal. If the lands had not descended to the heir, such guardian could never be the heir of the land; and if the guardian then had no relation to the land.

If the services due in respect of a particular estate are rendered by the tenant to the lord, he is not to take any chattels that are on the land until the services are due; and an infant tenant is not to be deemed a perfect one, and a reversioner is not to be deemed a perfect one, until the services due from the tenant of the particular estate are rendered.

A right still incident to a seignory which is not a fee-simple is that of escheat, which happens when the fee-simple dies without leaving any heir to the land without having incurred any forfeiture to the crown for high treason. It has been observed that the right of escheat is not a purchase, because the escheat descends as the seignory would have descended, if the lands were forfeited to the king for high treason or murder, the escheat descends to the lord, and generally, in whatever way lands come to the lord, the tenure is of necessity extinct.

The nature of tenure as

od by consulting the following articles: [C-ISTRESS; FEUDAL SYSTEM; MANOR; RENT;

Teos), now called Búdrúm, a town of Ionia, the south-side of the peninsula between the Ionia and the gulf of Clazomenæ, very near Teos, in 38° 15' N. lat., 26° 30' E. long. It was colonized by Minyæ from Orchomenus, under and afterwards strengthened by a colony from the time of the Ionian migration, under Naubolus of Codrus, Apœcus and Damasus, and by the Teians led by Geres. (Pausan., vii. 3.) Teos was one of the twelve cities which formed the confederacy of the Ionians (Herod., i. 142), and was recommended from its central position as the place of conference for the Ionian states. It was also one of the four cities which participated in the Hellenium at the time of Amasis. (Herod., ii. 168.) At the time of the conquest of Ionia by Cyrus the Teians rendered aid in Thrace, where they founded a colony and retained the parent state. (Herod., i. 168.) At the time of the seven Teian ships are mentioned among the Greeks. Teos still existed as an Ionian city in the Peloponnesian war. The Teians revolted during the Sicilian expedition from the Athenian general, but they destroyed the wall which they had built towards Teos (Thucyd., viii. 16, 19); but Teos submitted afterwards to Diomedon, the Athenian general.

Teos is the birth-place of Apellicon, the preserver of the birth-place of Aristotle, and of Anacreon, to whom a temple was erected there (Pausan., i. 25), and who is represented on the coins of the place playing on his lyre. It is mentioned by Livy (xxxvii. 28) that it had two ports, one to the north-west, and the other, Geræ, not quite four miles north-west, the entrance to which was so narrow that it admitted two ships at a time; it is now the castle of Sigah-jik, whence a Sanjak receives

orders from Teos, 'We found it almost as desolate as Clazomenæ. The walls, of which the remains were, as we guessed, about 5 miles in extent, were in a masonry handsome. It was with difficulty we could find the temple of Bacchus; but a theatre in the hill is more conspicuous. The vault only, on the east side, remains, with two broken columns. The city port is partly dry, and rises above the surface of the water. On the west side are the vestiges of a wall, and before it are two towers.

On the left hand, or toward the continent, is a hill which seemed artificial, the water not deep. In the Temple of Bacchus, which was visible on the east side, on the right hand, lay in the distance a corn-field, and is overrun with bushes and trees.

It was one of the most celebrated structures in Ionia. The remains of it have been engraved at the request of the Society of Dilettanti, and published, with its title "Ionian Antiquities" (i., ch. i.).' (*Travels in Ionia*, pp. 111-2; see also Choiseul Gouffier, *Travels in Ionia*, pl. 124.) This temple is an example of the work of Vitruvius, who tells us that it was a temple of Bacchus. It was the work of Hermogenes, the architect of the eustylus, and is probably of the time of the Ptolemies. (Müller, *Archäologie der Kunst in Asien*, p. 350) states the diameter of the temple to be 3 feet 8 inches at the base; he considers the length of the front to be about 64 feet on the east side, with about 11 columns at the sides, as according to Diodorus (iii. 65), the Teians believed Bacchus was born there, and, on his account, their temple was sacred or protected. On the autonomous coins of Teos there are on those of Abdera: perhaps this type is due to the worship of Apollo. The imperial series of Augustus to Gallienus. (Mionnet, *Recueil des Antiques*.)

TEPHRODORNIS, Mr. Swainson's name for a genus of birds, of the order *Prionops*. [SHRIKES, vol. xxi., p. 416.] *Character*.—Bill resembling *Prionops*; the base of the bill being partially covered with procumbent bristles and bristles. Wings moderate, rounded. Tarsi short, perfectly even. Tarsi and toes short; middle toe unequal; hinder toe longer than the tar-

Examples, *Tephrodornis superciliosus*, Sw., and *Tephrodornis Indica* (J. E. Gray). G. R. Gray (*Ind. Zool.*).
Locality.—Warm latitudes of the Old World.

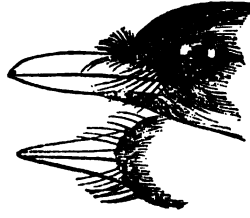

Bill of *Tephrodornis*, Sw.

TEPHRO'SIA (from *τεφρός*, ash-coloured), the name of a genus of plants belonging to the papilionaceous division of the order Leguminosæ. The genus consists of shrubs or herbs, with usually unequally pinnated leaves, and lanceolate or subulate stipules distinct from the petiole. The flowers are white or purplish, arranged in racemes which are mostly axillary. The calyx is without bracts, 5-toothed, nearly equal; vexillum of corolla large, silky outside, and reflexed in a spreading manner; wings adherent to the keel; stamens separate or united in one or two parcels: legume mostly sessile, linear, compressed, many-seeded, with the valves flat; seeds compressed. This genus at present includes 84 species, but it is probable that a more accurate investigation will result in making several genera of the present one. The American and Asiatic species are in some measure distinguished by their properties. In the former a narcotic poison is more frequently secreted; in the latter a colouring-matter.

T. toxicaria, the poison Tephrosia, is a half-shrubby erect plant, with 18 to 20 pairs of oblong-lanceolate, obtuse leaflets, pubescent on the upper surface, silky beneath; legumes linear, velvety, mucronate. This plant is a native of the West Indies and of Cayenne, and is said by Tussac to have been first brought from Africa. The whole plant affords a narcotic poison, and if the leaves are taken and pounded, and then thrown into water where there are fish, they become intoxicated, and losing all power over their muscles, they float about as if dead, and may be easily caught. If placed in fresh water, or the fresh water be allowed to come in contact with them as in a stream, the fish soon recover. It is, however, generally fatal to the smaller fish.

T. Virginiana, the Virginian Tephrosia, is an erect herbaceous plant, with leaves containing from 8 to 11 pairs of oval-oblong acute leaflets, villous beneath; the calyx is also villous. It is a handsome plant with reddish flowers, and is covered with villi. It is found in woods on dry and sandy soils in North America from Canada to Florida. It is considered in America a powerful vermifuge. Several other species of Tephrosia are found in North America, and are abundant on dry and sandy soils, in Georgia, Florida, and the Carolinas.

T. emarginata is an arborescent plant, with tomentose branches, leaves with 14 pairs of linear-oblong deeply emarginated leaflets, and silky straightish legumes. It is a native of South America, and has been found about the mission-stations of the Orinoco. The root possesses the same properties as the *T. toxicaria*, and is also used for the purpose of poisoning fish.

T. tinctoria, the Ceylon Indigo, is a shrubby glabrous plant with five pairs of leaflets, silky and villous beneath; flowers purple or flesh-coloured, seated on axillary peduncles; straight, pendulous legumes. This plant is a native of Ceylon, where it is called *Anil*. Its tissue yields a blue colouring-matter, which has the same properties as the indigo, and is used in Ceylon for the same purposes. There are other plants used in Ceylon for dyeing, also called *Anil*.

T. piscatoria, the Fisher's Tephrosia, is a shrubby plant with five or six pairs of leaflets, which are pilose beneath, the peduncles are 2-edged, the legume straight, ascending, and rather villous. This plant is found in the East Indies, and also in the islands of the Pacific. It contains the narcotic principle of the genus, and is used in the East Indies for the same purpose as *T. toxicaria* is in the West Indies.

T. Apollinea is shrubby, and covered with a close pubescence; the leaflets are silky beneath, and in two or

three pairs; the legume is 6- or 7-seeded, and rather pubescent. It is a native of Egypt, and yields a blue colouring-matter, which is used in dyeing.

T. Senna, Buga Senna, is a glabrous shrub, with leaves having six pairs of leaflets, and the legumes and calyxes covered with pubescence. It grows on the banks of the river Cauca, near Buga, in Popayan. Its leaves have a purgative quality like senna, and are used by the natives for the same purposes as that plant is used.

In the cultivation of these plants a mixture of loam and peat should be used. They may be easily propagated by seeds, or by young cuttings planted in sand, and covered with a bell-glass. Some of the species require the heat of a stove.

TEPIC. [MEXICAN STATES.]

TEPLITZ, TOEPLITZ, or TEPLICE, a town in the circle of Leitmeritz in the kingdom of Bohemia, celebrated for its warm sulphureous springs, is situated in 50° 38' N. lat. and 13° 50' E. long. The name is Slavonian, and given by the Bohemians and Croats to warm springs in general. The tradition respecting the discovery of these springs is, that a servant of a Chevalier Kolastug, a vassal of Duke Przemysl, who resided in the neighbourhood, was one day driving the swine, when several of the animals perished in the hot springs. This is said to have happened in the year 792. This discovery induced the chevalier to build a castle, and many settlers were soon attracted by the salubrious properties of the water, so that a street (in Slavonian, *Alice*) was formed, which was called *Tepla Alice*, 'the warm street,' and by contraction *Teplice*, or *Teplitz*.

This small town, which has not above 2500 inhabitants, is situated on a stream called the Saubach, in a beautiful plain or valley four leagues in length and one in breadth, formed by the Erzgebirge and the Mittelgebirge. The town forms an irregular quadrangle, is about half a league in circuit, and has three gates. The principal buildings are—1, the palace of Prince Clary, to whom the town belongs, with an extensive garden and park open to the public, in which there is a ball-room and a pretty theatre; 2, the church of St. John the Baptist; 3, the townhall, built in 1806; 4, the chapel of the Cross, outside of one of the gates. The town is connected by a row of handsome houses with the village of Schönau. There are several springs both in the town and in Schönau, each of which supplies several public and private baths distributed in different establishments. 'The quantity of water which the principal spring yields,' says Dr. Granville, 'is truly marvellous, being not less than a thousand large pailfuls, or one million one hundred and eighty-nine thousand six hundred and seventy cubic inches in an hour.' The temperature of these springs is said to have increased within the last forty years from 117° to 122° Fahrenheit, which is the present temperature of the chief spring. The medicinal effects of the hot springs of Teplitz are allowed by all physicians acquainted with them to be very beneficial in cases of suppressed gout, chronic rheumatism, diseases of the joints, contracted limbs, old wounds, obstinate cutaneous eruptions, paralytic affections, to which Dr. Granville adds, 'that the specific virtue of these baths lies in the power they possess of restoring a cripple, it matters little from what cause, to perfect motion and elasticity.' The waters have been used almost exclusively for bathing; of late they have been recommended and used internally. Prince Clary has spared neither pains nor expense to render the place worthy of the patronage of the kings and princes who habitually visit it, some of whom have built palaces for themselves and public hospitals for their invalid soldiers. The number of visitors every year is from 4500 to 5000. Besides the attraction of its waters, it may be added that the expense of living at Teplitz is far less than in any other watering-place in Germany, that the private baths are fitted up in a manner unquestionably superior to those of any other Spa in that country, and that there are ample sources of recreation and amusement without gaming, which is wholly prohibited.

(*Jenny, Handbuch für Reisende in dem Oesterreichischen Kaiserstaate; Die Oesterreichische National Encyclopædie; Conversations Lexicon; Dr. Granville, The Spas of Germany.*)

TEPTIARES. [RUSSIAN EMPIRE.]

TEQUENDAMA. [GRANADA, NEW.]

TE'RAMO, PROVINCIA DI, called also *Altra I.*, is an administrative division of the Abruzzo kingdom of Naples, stretching east of the great ridge, and sloping down to the Adriatic sea. It is on the east by the Adriatic, north by the Papa of Fermo and Ascoli, west by the Neapolitan province of Aquila, and south by that of Chieti. The principal rivers are the Tronto, which marks the boundary between the Papal State, the Tordino, which flows by the Teramo, and the Vomano, whose several sources descend the eastern slope of Monte Corno, called also 'Sasso d'Italia,' the highest group of the Apennines (about 6000 feet above the sea), which rises on the borders of the provinces of Teramo and Aquila, occupying great part of the area of both. The river Pescara, in its lower course, marks the boundary between the province of Teramo and that of Chieti.

The province of Teramo is divided into two active districts, Teramo and Penne, containing several communes: the whole population amounted in 1806 to 200,719 inhabitants. (Serristori, *Statistica d'Italia*) The area is estimated at about 1000 square miles. A population are employed in agriculture. There are several manufactories of silk, delft ware, liquorice, paper, of tartar, and leather; copper-ore is dug, and so worked at Chiarino. The principal towns are, 1, Teramo, a bishop's see, the chief town of the province, the residence of the intendente or king's lieutenant, a tribunale civile, or court of first instance, an *Corte Criminale*; a royal college, a clerical school, several churches and convents, and about 8000 in population. The surrounding country is productive in corn, pulse. 2, Penne, or *Cività di Penne*, is a town of about 6000 inhabitants. 3, *Civitella del Tronto*, a small town on the frontier of the Papal State. 4, *Assisi*, a town which gives the title of duke to the ancient *Acquaviva*. (Petroni, *Censimento dei Reali d'Italia del Faro; Neigebaur, Gemälde Italien.*)

TE'RAPHIM (תְּרָפִים; Sept., *ἰδωλα*). This

word is of somewhat uncertain etymology and significance. The teraphim were of human form seems evident from 1 *Sam.*, xix. 13. They appear to have been set up as if not idolatrously, revered as penates, or household gods (*Gen.*, xxxi. 19, 34, 35; 1 *Sam.*, xix. 13-17; xxiii. 24). In some shape or other they were used as oracles (comp. *Zech.*, x. 2; *Judg.*, xvii. 5; xviii. 5; *Hos.*, iii. 4). This is confirmed by 1 *Sam.*, xv. 17. Teraphim are mentioned in connection with the practice of divination. With this the alleged Syriac etymology of the word coincides; for, according to Bar Bahlul, in that language, *an inquirer, one who asks*.

TERBURGH, GERARD, a very eminent painter, born at Zwoll, near Overysse, in the year 1608, was instructed in the rudiments of his art by his father, but not much known as a painter, but appears to have spent some years at Rome. Some think that he perfected himself under another master at Haarlem; however, he had acquired considerable reputation in the Netherlands as a painter of portraits of a small size, before he solved to travel for his improvement. He first visited Italy, but whatever advantage he may have derived from the study of the great Italian masters, he never changed his residence, proceeding from Italy to France, practising with success at Paris. From France he returned to the Netherlands, where he was highly esteemed and fully employed. He visited Münster during the sitting of the celebrated congress at which the treaty that terminated the Thirty Years War was concluded. Here he painted his most celebrated picture, containing the portraits of the sixty-nine plenipotentiaries assembled on that important occasion. He painted also Pignoranda, the Spanish ambassador at Münster, when he visited Spain, where he painted the portrait of Philip IV. and all the royal family, and of the most distinguished nobility. His performance procured him satisfaction to the Spanish king, that he conferred on him the honour of knighthood, and presented him with a chain and medal, a sword, and silver spurs. After returning to his own country he married, and became burgomaster of the town of Deventer, where he died in 1681, at the age of seventy-three. The subjects which Terburgh generally painted

aits, conversations, persons engaged at different games, ormers on musical instruments, ladies at their toilets. nished his pictures highly, with a light and delicate a, and is remarkable for introducing white satin in the of some figure in all his compositions: he always caré to throw the principal light upon it, and seems r to have painted a picture without satin drapery. Dr. n says of him, 'Terburgh is the real founder of the a painting conversation pieces, and at the same time most eminent master in this style. In delicacy of excn he is inferior to none, and in a certain tender fusing ie colours he excels all others; but none can be coml with him in the enchanting harmony and silvery and the observance of the aerial perspective. His ea, which are well drawn, have an uncommon ease of it, and are frequently very graceful.' Many of his works are in England, in the collections of Sir a, Peel, the duke of Sutherland, Lord Ashburton, Mr. s, the marquess of Bute, and Her Majesty. (Pilking-Fuseli; Dr. Waagen.)

TERCEIRA is considered the principal island of the es or Western Islands, though it is neither the largest he most fertile. It is situated nearly in the centre of roup, and it is the seat of government. It extends een 38° 36' and 38° 50' N. lat., and between 26° 58' and 2° W. long., and is about 20 miles long from east to with an average width of about 13 miles. This gives ea of 260 square miles, or about 60 square miles more the smallest of the English counties, Rutlandshire. rceira, and all the other Azores, with the exception of Maria, has probably been produced by volcanic acout its surface does not exhibit that extreme irregu which occurs in the other islands, and in general in es which owe their existence to that agency. The a indeed are rocky and precipitous, but the higher of the island are chiefly composed of beautiful and plains, and entirely destitute of the numerous cones, ers, and peaks which distinguish the island of St. hael. There is however, about 6 or 7 miles north- t of the town of Angra, a wide depression, from the s of which sulphuric vapours issue in abundance, which is surrounded by hills composed of pumice- It is called Furnas de Euxofre. It is stated that crevices were formed by the earthquake of 1614, was the last experienced in the island, up to 1841, the town of Praya was completely destroyed by an ke, and the whole island suffered much. The in- n the island does not contain many steep or inac- rocks, which is mainly to be attributed to the ups which have been very frequent, and still happen e to time. The most elevated part of the island dle, and extends from east to west, where it tes with Punta Seretta. Near this cape, and north- it, the ground seems to attain its greatest elevation, owever probably does not exceed 3000 feet above evel. The elevated rocky coast along the western orthern shores cannot be approached without great r by large vessels, and the whole island has only arbours, Praya on the east, Angra on the south, itos on the north-west, but the anchorage is bad, and certain winds vessels are obliged to seek the ea. The soil is composed of volcanic ashes, pumice- gs, decomposed lava, a quantity of ferru- tter, a small portion of clay or sand, and a mestone. But a large quantity of vegetable matter with these materials, which imparts to the soil derable degree of fertility. Grain is only cultivated more level and low tracts along the sea-coast. The overgrown with trees.

orological observations have been published, en te is known to be very moderate, as it is that the average range of the thermometer is only 50° to 75°, and rarely exceeds these two extremes. he weather is nevertheless subject to great changes, s only settled between the summer solstice and the al equinox. Showers of rain are frequent through- year, and in winter so violent as to cause constant s in the face of the country, washing away enormous of pumice-stone from the mountains, throwing projecting portions of the rocks composed of soft nic materials, and leaving the surface of the rocks rhts in many places quite destitute of soil. The of fine days is estimated at about 200, and the

wet ones at sixty. The sea which surrounds the Azores is remarkable for the incessant gusts and gales to which it is subject, on which account it is rather dreaded by seamen. This phenomenon is probably connected with the Gulf-stream, which reaches the most western islands (Flores and Corvo), and frequently extends over the whole group. All navigators have observed the frequency of these gusts and sudden squalls, especially along the northern edge of the Gulf-stream. The prevailing winds during the winter range between north-west and south-west; the south-west wind generally blows in strong gales, and is attended by heavy rains. During the summer the most frequent are northerly, north-easterly, and easterly winds; but at all seasons the changes of the winds are frequent and sudden, and render the navigation between the islands very tedious.

The soil being more suitable to agriculture and pasturage than to the cultivation of fruit, grain and cattle are the staple articles. The principal objects of cultivation are wheat, Indian corn, flax, French and broad beans, and a little barley. The yearly produce of the grain is stated to be 720,000 bushels, and some is exported to Lisbon, Oporto, and Madeira. The most common vegetables are yams, potatoes, sweet potatoes, onions, and capsicums. All the fruit-trees of southern Europe succeed, but their cultivation has been neglected until lately, when the inhabitants have begun to apply themselves to that of the orange-tree, and the oranges of Terceira are now hardly inferior to those of St. Michael, and are largely exported to England and Hamburg. The vineyards are extensive, and their annual produce exceeds 4000 pipes, but the wine is converted into brandy, and the wine consumed in the island is imported from Fayal. The apples, pears, figs, chestnuts, and wallnuts are tolerably good. On the declivities there are some pine-woods and beech, but the higher parts are covered with underwood and impenetrable bushes of briars, among which are many evergreens, such as myrtle, juniper, and box, with stunted cedars. Quantities of orchilla are collected from the rocks. Cattle are numerous, and of good size in the cultivated parts, and those parts which are not cultivated serve as pasture-grounds for sheep and goats. Goats are rather numerous. Only a few small horses are reared; the oxen and asses, which are numerous are used as beasts of burden. Hogs are very numerous, and are fed on Indian corn and chestnuts. There are no wild animals, except rabbits, and no poisonous reptiles. Fowls and turkeys abound. There are thousands of blackbirds, woodcocks, and partridges, but no pheasants nor peacocks. Fish is said to be abundant. Sometimes whales are seen near the island.

In 1820 the population amounted to 40,717, and in 1832 it was estimated at 50,000 individuals, which gives more than 192 persons to each square mile, rather a large proportion when it is considered that much more than half the island is not cultivated and does not produce food for man. Lincolnshire has only 130 to each square mile, according to the census of 1841. This population is settled in three towns and fifteen villages. Angra is the capital. [ANGRA.] Praya, which has about 3000 inhabitants, is situated in the centre of a beautiful sandy, deep, indented bay, well defended by nature and art, and has some commerce with Portugal and Madeira: it exports grain and live-stock.

Very good linen and coarse woollen-cloth is made on the island for home consumption. Coarse earthenware is also manufactured to a considerable extent, the clay for which is imported from Santa Maria. The exports consist of grain and live-stock, which go to Portugal and Madeira, and of brandy, oranges, and orchilla, which go to foreign countries, chiefly England and Hamburg. The imports are principally coarse cotton fabrics, some woollen-cloth, hardware and cutlery, and cod, most of which articles are brought from England.

Terceira was discovered in 1445 by some Portuguese navigators who were returning to Europe from Cape Verde, and it then received its present appellation, being the third of the Azores in the order of discovery. It was then uninhabited, but it was immediately settled by several families from Portugal. In 1580, when Philip II. took possession of Portugal, the inhabitants declared against him, and repulsed his fleet from their shores; but in 1583 they were obliged to submit. In 1828, when Don Miguel

had abolished the constitutional government of Portugal, and proclaimed himself absolute king, Terceira declared for Donna Maria; and, in 1829, a large fleet and army sent by Don Miguel for the conquest of the island were repulsed with great loss from the town of Praya. In 1831 the other islands of the group were recovered for Donna Maria by a small number of troops sent there from Terceira.

(Ashe's *History of the Azores or Western Islands*; Von Buch's *Physikalische Beschreibung der Canarischen Inseln*; Fowler's *Journal of a Tour in the State of New York, and Return to England by the Western Islands*; Boid's *Description of the Azores or Western Islands*; and Capt. Bartholomew, in *London Geographical Journal*, vol. iv.)

TEREBELLA. [TUBICOLIDÆ.] (N.B. This comes too near to *Terebellum*.)

TEREBELLA'RIA, a genus of Polypiaria, included by Blainville in the family of Milleporæa.

TEREBELLUM, Lamarck's name for a genus of testaceous mollusks, placed by Cuvier among his Pectini-bianchiata Gastropods, between *Orula* and *Voluta*; by De Blainville among his *Angyostomata*, between *Conus* and *Oliva*; and by Rang between *Mitra* and *Ancillaria*.

The fossil *Terebellum convolutum* is the type of Montfort's genus *Seraphs*.

Generic Character.—Animal?

Shell delicate, polished, subcylindrical, rolled upon itself; the apex pointed; the aperture longitudinal and triangular, very narrow behind and notched before; edge of the right lip simple and trenchant; columellar border smooth, truncated, and slightly prolonged forwards.

There appears to be but one recent species known, *Terebellum subulatum*.

De Blainville divides the genus into two sections:—

A. Species whose spire is visible, and whose aperture is shorter than the shell. (*Terebellum*.)

B. Species whose spire is nearly entirely hid by the rolling up of the whorls of the spire, and whose aperture is nearly as long as the shell. (*Seraphs*, fossil.)

Example, Terebellum subulatum.

Description.—Shell subulato-cylindrical, rather thin, smooth, and polished; the spire distinct; the outer lip attached to the columella.

There are at least four varieties:—

A. Clouded with chestnut, quadrifasciate, or with the colour in patches.

B. Ornamented with flexuous subspiral or transversely oblique chestnut lines.

C. Thickly dotted with rich chestnut.

D. Entirely white.

Locality.—The East Indies.

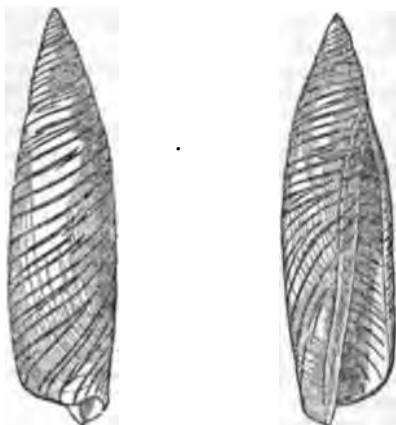

Terebellum subulatum.

FOSSIL TEREBELLA.

The fossil species appear to belong to the Tertiary formation, Eocene period of Lyell (Grignon, &c.). M. Deshayes, in his *Tables*, notices but two, *Terebella convolutum* and *fusiforme*, the same that are recorded by Lamarck.

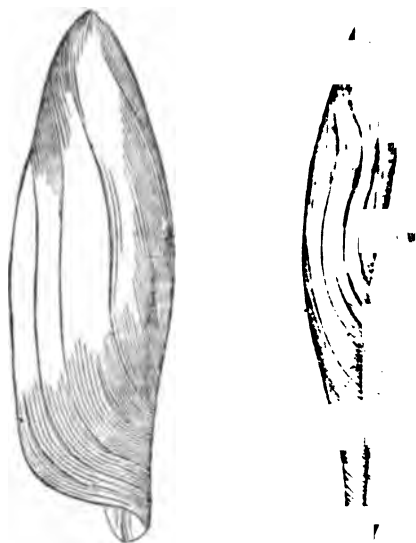

Terebellum convolutum. (Genus *Seraphs* of Montfort)

TEREBINTACEÆ, a natural order of dicot plants. They are trees or shrubs, abounding in gummy, caustic, poisonous, and sometimes milky latex. The leaves are alternate and simple, ternate, or bipinnate. The flowers are terminal or axillary, mostly regular. The calyx is small. The petals and stamens are in a number to the divisions of the calyx; sometimes the petals are twice the number; the disk is fleshy and simple; fruit indehiscent, with a single seed.

This order was constituted by Jussieu, and by De Candolle, Arboott, Don, and other writers in systematic botany. Brown has however constructed it from this, viz., Anacardiaceæ, Burseraceæ, Cocciniferaceæ, and Amyridaceæ. The orders here recognised by Kunth, Lindley, and others; and characters and properties are given in this work under their respective names. [ANACARDIACEÆ; BURSERACEÆ; COCCINIFERACEÆ; SPONDIACEÆ; AMYRIDACEÆ.]

TEREBRA. [ENTOMOSTOMATA, vol. ix., p. 4]

TEREBRALIA, Mr. Swainson's name for a testaceous Gastropods, arranged by him under *thinæ*, the fifth subfamily of his *Strombidae*, characterized:—

Outer lip much dilated, generally uniting at the inner lip, leaving a round perforation at the base of the pillar; channel truncate, operculum round (see *cology*.)

Mr. Swainson places the genus between *Pirenanopsis*] and *Rhinoclaris*, Sw.; and, among others, refers to *Terebralia Telescopium*, *Cerithium Telescopium*, &c. of authors. [ENTOMOSTOMATA, vol. ix., p. 451.]

Whatever may be thought of this genus, the name is coming so near to *Terebra*, may produce confusion.

The reasons for not admitting *Pirena* as a genus are found in the article MELANOPSIS.

TEREBRATULA. [BRACHIOPODA, vol. v., p. 10]

TEREDINA, a testaceous mollusk of the family of *colæ* of Lamarck, and belonging to the *Acicula* of Blainville.

Generic Character.—Valves equal, but the umbones prominent; when closed, orb-like with a triangular opening in front and a subcircular aperture at the back. Tube testaceous, subcylindrical, with a posterior extremity, without any septum, uniting the posterior part of the two valves.

This genus is fossil only. Lamarck places it between *Septaria* [TEREDO] and *Teredo*; Cuvier between *Clavagella* and *Clavagella*.

Mr. Swainson arranges it in his family *Pholidae* and makes it a subgenus of *Teredo*.

Mr. J. E. Gray places *Teredina* among the *Pholidae* between *Jouannetia* and *Teredo*.

M. Deshayes, in the last edition of Lamarck's *Tables*, that this curious genus was not well known to the zoologist. The *Teredina*, M. Deshayes remarks, is

PHOLAS fixed at the end of a tube, and has in exterior characters of the *Pholades*. It carries an on the umbones, and within it is provided with endages which so readily distinguish the *Teredo* the *Pholades* from other genera. The shell is ternal, and soldered by the posterior extremity of to the anterior part of the tube, which is very terminated by a blackish part of a horny appearance internal surface is sometimes divided into lar carinations.

Lamarck, in his Tables, gives two species, *Teredina* and a new species, both from the tertiary beds of Lyell). In the last edition of Lamarck no taken of the new species, and to the second *Teredina bacillum*, recorded by Lamarck, is apnote stating that this last does not belong to the *redina*; and that, according to the description of Brocchi, it can only be a *Clavagella* or a ; but that it is not *Clavagella tibialis*, as M. de believed.

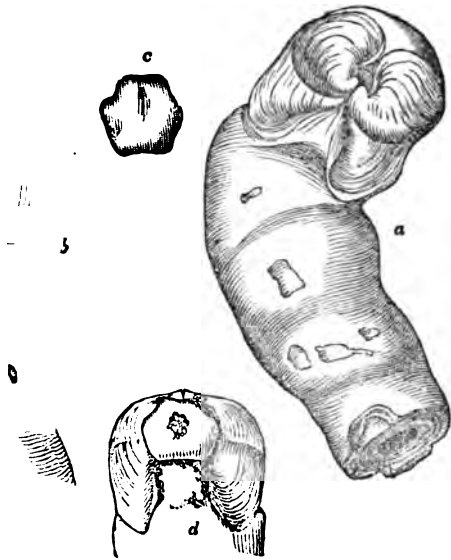

Teredina personata. (Courtaignon, &c.)

a valves; b. the other termination of the tube; c. necessary valve; d. accessory valve in its place. (G. B. Sowerby.)

DO, the name given by Linnæus to a genus of mollusks, highly interesting on account of the which one of the species commits upon submerged

s, in the twelfth edition of the 'Systema Naturæ,' e genus among his *Vermes testacea*, between and *Sabella*: nor is this certainly inapt position idered at when we consider the very infant state logy in his day.

in his last edition of the 'Règne Animal,' makes e of the genera of his *Enfermés*, the fifth family halous *Testaceans*, arranging the genus between d *Fistulana*.

Mainville arranges the genus in the tenth family a) of his *Pyloridians*, between *Teredina* and , immediately after which comes *Septaria*.

k had placed the genus among his *Tubicolées*, ang adopts that arrangement, giving it a position between *Jouannetia* and *Fistulana*, next to which, diately before *TEREDINA*, *Septaria* appears.

k ended with this genus his *Tubicolées*, which diately followed by the *Pholadaires*. *Teredo* is ly preceded by *Teredina*, and this again by

In speaking of the last-named genus, M. in the last edition of Lamarck, observes ough the animal and the shell of *Septaria* nown to him, the great portions of its testa-e or sheath, which he had seen, convinced the animal is analogous to that of the *Fistulana*, er from it principally in size only; and because terior siphons are very long, and form for them:h a particular testaceous sheath. The animal

ought therefore to have posteriorly, he remarks, a bivalve shell, which had escaped those who have collected the great tube, or the portions of it which we see in cabinets. M. Deshayes goes on to state that he has only seen a few septa, unequally distant and entirely incomplete. Some *Fistulanae*, he adds, have also vaulted septa in the posterior part of their sheath; but the diminished or anterior part of this offers only particular tubes projecting out wards (1835).

Again, when Lamarck concludes his observations by saying that, for the rest, the *Septaria* is hardly anything but an exaggerated *Fistulana*, and scarcely deserves to be distinguished as a genus, M. Deshayes declares that if we substitute for the word *Fistulana* that of *Teredo*, these remarks would be perfectly just. This genus, he adds (Lamarck's *Septaria*), which had been believed to be peculiar to the seas of India, has been found some years since in the Mediterranean; and he refers to the paper published on that animal in the 'Annales des Sciences et de l'Industrie du Midi de la France,' Marseille, 1832, by M. Mathéron, in which that naturalist proves the animal of *Septaria* to be similar to that of *Teredo*; and this resemblance, says M. Deshayes, in conclusion, confirms his own opinion of the necessity of uniting the *Septariæ* and the *Teredines*.

Mr. Swanson (*Malacology*, 1840) places *Teredo* with the subgenera *Teredo* and *Teredina*, at the end of the '*Pholidae*.'

Mr. J. E. Gray arranges *Teredo* between *Tereatina* and *Bankia*, under his *Pholadæ*, the first family of his second order (*Cladopoda*) of *Conchifera*. *Septaria* is introduced, with a query, into his second family, *Gastrochenidæ*.

ORGANIZATION.

It is now 36 years since Sir Everard (then Mr.) Home laid before the Royal Society, with the assistance of Mr. Clift in making the drawings, and the aid of Sir Benjamin (then Mr.) Brodie, his *Observations on the Shell of the Sea-Worm found on the Coast of Sumatra, proving it to belong to a Species of Teredo, with an account of the Anatomy of the Teredo Navalis*. Sir Everard remarks that the internal structure and economy of *Teredines* were so little known, and so much of what was said of them by Sellius was so vague, that it became necessary to acquire an accurate knowledge of the common *Teredo navalis*, before any adequate idea could be formed of the new species, which he names *Teredo gigantea*.

On examining the shell of *Teredo navalis* while in the wood, Sir Everard found its external orifice very small, just large enough, in fact, to give a passage to the two small tubes. The greatest thickness observed was $\frac{1}{4}$ of an inch. The canal in the wood at its termination, and for an inch in length, was not lined with shell, but smeared over with a dirty green-coloured mucus, which was also spread upon the last-formed portion of shell. According to Mr. Hatchett's analysis, the shell of *Teredo navalis* was perfectly similar to that of *Teredo gigantea*, being devoid of phosphate of lime, and composed of 97 parts of carbonate of lime and 3 of animal matter.

While the animal was in the shell alive and undisturbed, what is termed the head was in contact with the end of the canal in the wood; but, on laying the head bare, it was drawn in for an inch into the shell. The body of the animal filled the area of the shell completely, but appeared much smaller when taken out, in consequence of the sea-water which it contained having escaped. The largest of the worms examined which were of different lengths measured 8 inches in length. Many of them were alive 24 hours after being removed from their shell, and in these the heart was seen to palpitate. The blood in the vessels going to the head was red, as also the parts near the liver; but this colour disappeared soon after death.

The head of the worm was enclosed between the two concave boring shells, so that what Sir Everard calls the face was the only part exposed. These shells were united together on what is termed the back part of the head by a very strong digastric muscle, having a middle tendon from which the fibres go off in a somewhat radiated direction, partly for insertion into the concave surface of each shell, and partly into a long semicircular process projecting from the posterior part of each shell. The two inclose the œsophagus and other parts surrounding it. The double muscle was inclosed in a smooth shining fascia. When first exposed it was of a bright red.

On the opposite side of the head the shells were united by a ligament from which they were readily separated; at this part were two small tooth-like processes, one from the narrow edge of each shell, where they were joined together.

From the middle of the exposed part of the head projected a kind of proboscis; which in the living animal had a vermicular motion: its extremity was covered by a cuticle not unlike the cornea of the eye. On removing this, the cavity immediately beneath it was found to contain a hard brown-coloured gelatinous substance, like a Florence flask, with the large end uppermost in form. Sir Everard remarks that as this proboscis has no orifice, there is reason to believe that it adheres to the wood, acting as a centre-bit, while the animal is at work with the shell, and thus the canal in the wood is perfectly cylindrical. The mouth was nearly concealed by the projection of the proboscis, but, when exposed, presented a very distinct round orifice between the proboscis and the large digastric muscle.

'The body of the worm,' proceeds Sir Everard, 'is inclosed in one general covering, extending from the base of the boring shell, with which it is firmly connected to the root of the two small tubes, which appear out of the wood. It terminates in a small double fold forming a cup, on the inside of which are fixed the long small stems of two opercula, which become broad and flat towards their other extremity. These, when brought together, shut up the shell, and inclose the two contracted tubes within it: not one operculum corresponding to each tube, but in a transverse direction. In the *Teredo gigantea*, the opercula are similarly situated, each shutting up one-half of the bifurcation. At the base of this cup the general covering is thick and ligamentous, for about one-fourth of an inch in length, where the stems of the opercula are connected with it; and at one spot of this thickened part there is an adhesion to the cylindrical shell, which is the only part of the animal connected with it. There is a depression in the shell pointing out this spot. The double fold of the outer covering, that forms the cup, contains the sphincter muscle, which closes the orifice by bringing the opercula together. The general covering is composed of two membranes, the outer the strongest, and made up of circular fibres, the inner much finer, having no fibrous structure. On the back of the animal, this covering is firmly connected to the parts underneath, and is there strongest. On the belly it forms a cavity, and is thinner. It is everywhere sufficiently transparent to show the different viscera through it.'

Sir Everard Home began his dissection by dividing this covering and exposing its cavity, into which there are two natural openings: one, that of the largest of the above-described tubes, by which it receives the water from the sea; the other, a transverse slit under the union of the boring shells, one-quarter of an inch long, opening into the space before the mouth. The author states that the smaller tube has no communication with this cavity, and that there is none between this cavity and that of the belly, the viscera having a proper covering of their own: the breathing organs however, which are attached on the posterior surface of this cavity, are described as having their fringed edge loose and exposed to the influence of the salt water; so that the larger tube is constantly applying salt water to them, and conveying it to the animal's mouth through the aperture for that purpose.

Digestive System.—The head and abdominal viscera were found to occupy about one-third of the animal's length, the breathing organs another third, and the space between their termination and the ends of the small tubes the remaining third. The œsophagus was very short, lying on the left side of the neck. On the right were two large approximated glands connected with its coat. The œsophagus gradually swelling out became stomach, which externally appeared as a large bag, extending the whole length of the abdomen; the intestine commenced close to the termination of the œsophagus: but when the stomach was laid open, a septum appeared dividing it into two distinct bags, except at the lower end, where they communicate. It may therefore be said, observes Sir Everard, to be doubled on itself. In those worms which were examined alive, the stomachs were quite empty; but in some preserved specimens the contents were a yellow-coloured pulp, of which we shall have to say more presently: the

quantity in a specimen from the British Museum was about 10 grains.

The intestine was very small, and became dilated into a cavity, containing a hard, white, globular body, of the size of a large pin's head, and then made a turn upon it. Here the liver is attached to the stomach, to which it adheres. The gut passed forwards till it reached the dorsal line of the stomach, opposite the septum, and continued its course along that viscus, passing round its lower end and up again on the opposite side. It was then continued on one side of the œsophagus nearly as high as the mouth, where it was reflected over the middle tendon of the digastric muscle of the boring shells, and ran along the back of the animal, till it terminated in the small duct through which its contents are emptied.

Circulating and Respiratory System.—The heart was found in the middle between the mouth and the lower end of the stomach, and was situated on the back of the animal. There were two auricles, composed of a thin dark-coloured membrane, which opened by contracted valve-like orifices into two white strong tubes, which united to form the ventricle. This ventricle, Sir Everard observes, may be said to be continued into an artery, which supplies the viscera, and ascends to the muscles of the two boring shells. The heart was very loosely connected to the surrounding parts; its action was distinctly seen through the external covering, and was observed, in some instances, after it had been laid bare. The first contraction was in the two auricles, which shortened themselves in that action. A swelling of the ventricle, followed by a contraction, is thus produced. Sir Everard found that the artery from the ventricle could be traced up to the head, and the vessels from the auricles were seen very distinctly as far as the breathing organs. The auricles were lined with a black pigment, so that their contents could not be seen through them; and the coats of the ventricle were too thick for transparency: but the muscle of the boring shells was of a red colour, as well as the liver, and most of the surrounding parts between the heart and the head.

Sir Everard observes, that this structure of the heart admits only of a single circulation, as in other animals. It breathes through the medium of water, but that the mode of its being performed is different from that in fishes. In the *Teredines*, he remarks, the blood passes directly to the heart to the different parts of the body, and retires through the vessels of the breathing organs to the gills; while in fishes it goes first to the breathing organs, and then to the different parts of the body. This peculiar circulation, he adds, becomes a link in the gradation of modes of exposing the blood to the air in different animals: it appears to be less perfect than in fishes, the exposure to the air is carried on more slowly, and more perfect than in caterpillars.

Brain and Nervous System.—Sir Everard doubts the existence of the brain and nerves in animals so simple as their organs as the *Teredines*, but he failed to detect them during his investigation.

Generative System.—Sir Everard Home described the testicles as two long glandular substances, one on each side of the stomach, of a whitish colour and granular structure. From each of them a duct passed to the ovary, which lay between the two breathing organs. The ducts ran upon their outer edge, and terminated near the end of the small tube. In this way, he remarks, the eggs are impregnated before they pass out at that orifice. In the worms from Sheerness, examined in February, the testicles were small, and no appearance of ovaria could be seen; but in specimens from the Hunterian Museum the testicles were much fuller, and the ovaria formed two distinct longitudinal ridges: these, when examined with the microscope, were seen to contain innumerable eggs. When the ovaria are empty, Sir Everard states, there is nothing to be found between the two breathing organs but the small seminal vessels. He then adverts to the statement of Sellius, who says that the *Teredo navalis* has its ovaria full of eggs in the spring and summer; that they are met with as late as December; but that those individuals which he examined in February had their ovaria flaccid and empty.

With regard to *Teredo gigantea*, the same author observes that, when arrived at its full growth, it closes up the end of its shell, and so does *Teredo navalis*. Sellius believed that the animal by this act formed its own tomb.

ld no longer destroy the wood in which it was Sir Everard however remarks that in *Teredo* path is not a consequence of seclusion from the wood in which it is imbedded. In some of Mr. Griffiths the shell was just covered in, and the tube to the termination extremely thin, whilst in others it increased twenty-fold in thickness. In others the animal had not only become thick, but the animal had from its first inclosure, and had formed a tube six inches up the tube, and afterwards a third further on, and had made the sides thicker and as to diminish the canal in proportion to the size of its own size.

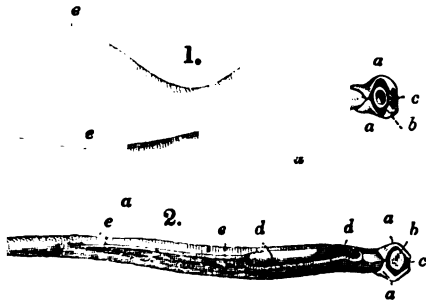

Animal of *Teredo nautilus* out of the shell.

1. the tubes retracted. 2. the opercula in their protruded state. a, a, the boring shells; b, the proboscis; c, d, the contents of the abdomen seen through the transparent g; e, e, breathing organs seen in the same way. (*Phil. Trans.*)

rd considers these facts as proving that *Teredo* when arrived at its full growth, or whenever it had increased in length, closes up the end of its tube and lives a long time afterwards, furnished with food from the sea-water. *Teredo nautilus*, he observes, forms its shell in the same manner: it must therefore, in its period, be supplied with food entirely through the tubes of sea-water. The *Teredines*, he adds, turn the shell, to which they are not attached, and their covering only has a slight connection at a particular spot, to prevent the external tubes from being drawn in. This motion, Sir Everard observes, is for the purpose of boring.

Character.—Animal very much elongated, very thin, with a very delicate mantle, open in front and adapted for the passage of a mammiliform foot; head, very short, especially that for the dejection small; labial appendages short; anus situated at the extremity of a small tube floating in the cavity of the tube; branchiæ riband-like, united on the same side to their length, and a little prolonged in the middle; a muscular ring at the point of junction of the tubes, in which is implanted a pair of corneo-calcareous appendages or palmules, the larger one against the other.

The head is thick, very short, annular, equally open behind; equivale, inequilateral, angular, with three lobes, trenchant in front, and only touching the two opposite edges; no hinge; an elongated, straight, subfiliform, spoon-shaped process; a deep, highly-marked muscular impression.

The tail is cylindrical, straight or flexuous, closed with age at the extremity, so as to envelope the animal and the tube, and stays open at the other, and lining the cavity of the tube, he animal has introduced itself.

Mr. Rang's definition of *Teredo*, excluding *Teredo septaria*, of which he gives the following description, deriving that it closely approximates to the *Teredo fistulana*:—

Unknown. (But see the paper of M. Mathéron referred to.)

Unknown. (But see the descriptions of Mr. Griffiths and Sir Everard Home here noticed.)

Calcareous, thick, solid, in the shape of a very long, and irregularly flexuous, furnished internally, incomplete, annuliform septa; terminated at both extremities by a convexity, and at the other end by a pair of separated tubes.

Number of species of *Teredo* (exclusive of *Septaria*) given by Lamarck in the 'Animaux sans Vertèbres': two, *Teredo nautilus* and *Teredo palmulatus*:

of the latter Lamarck, who had seen neither its tube nor its shell, says that it probably only differs from *Teredo nautilus* in its greater size, its longer palmules having been more easily observed.

M. Deshayes, in his Tables, makes the number five living and five fossil (tertiary), exclusive of *Septaria*; and, in the last edition of Lamarck, adds to the two species above noticed *Teredo corniformis* (*Fistulana corniformis*, Lam.), *Teredo gregatus* (*Fistulana gregata*, Lam.), and *Teredo arenarius* (*Septaria arenaria*, Lam.).

N.B. Lamarck had stated that the *Ropan* of Adanson (*Sénégal*, pl. 19, f. 2) belonged to the *Teredines*, remarking however that he (Lamarck) knew it not. But M. Deshayes points out that M. Rang, on his return from a voyage to Senegal, where he had an opportunity of observing the *Ropan*, found that this curious shell belonged neither to the *Teredines*, as Lamarck believed, nor to the *Pholades*, as Bosc says, and still less to the *Gastrochæna*, as M. de Blainville supposes; but that it is a *Modiola* already known, *Modiola caudigera*.

Teredo Nautilus.—This is sufficiently described above, and we therefore proceed to the consideration of its

Food, Habits, &c.—Some of the *Teredines* examined by Sir Everard Home were sent from Sheerness in the wood alive, and they lived in salt-water for three days after being brought to town. Sir Everard observed that when the surface of the wood was examined in a good light, while only an inch in depth in the water, the animal threw out sometimes one, at others two small tubes. When one only was protruded, the other almost immediately followed it. One of them was about three-quarters of an inch long; the other only half that size. When the largest was exposed to its full extent, there was a fringe on the inside of its external orifice of about twenty small tentacula, scarcely visible to the naked eye: these were never seen except in that state; for when the tube was retracted, the end was first drawn in, and so on, until the whole was completely inverted: and therefore in a half-protruded state it appeared to have a blunt termination with a rounded edge. The smaller tube was not inverted when drawn in. 'These tubes,' says Sir Everard Home, in continuation, 'while playing about in the water appeared at different times to vary in their directions, but usually remained at the greatest convenient distance from each other. The largest was always the most erect, and its orifice the most dilated; the smaller one was sometimes bent on itself with its point touching the wood. In one instance, where a small insect came across the larger one, the point of the smaller turned round and pushed it off, and then went back to its original situation. In several instances the smaller one appeared to be the most sensible; since by touching the larger one gently it did not retract; but on touching the smaller one they both were instantly drawn in. Indeed whenever they were retracted they always were drawn in together. When the worm was confined within the shell the orifice was not to be distinguished in the irregular surface of the wood, which was covered with small fungi. The worm appears commonly to bore in the direction of the grain of the wood, but occasionally it bores across the grain to avoid the track of any of the others; and in some instances there was only a semitransparent membrane as a partition between two of them.'

Sir Everard observes that as the *Teredo gigantea* bores in mud, on which it cannot be supposed to subsist, or even to receive any part of its nutriment from it, it becomes a question whether the *Teredo nautilus*, an animal of much smaller size, derives support from the wood which it destroys, or is supplied wholly from the sea. The last opinion seems the most probable to Sir Everard, because the animal, having red blood and very perfect organs, necessarily requires a great deal of nourishment for the purposes of growth, and to supply the waste constantly going on; but if, he observes, the aggregate of shell and animal substance is taken, it will be found equal in bulk, and greater in specific gravity than the wood displaced in making the hole: hence, he remarks, it is obvious that the quantity of wood which the animal has taken into its body is wholly insufficient for its formation and subsistence. When once it is established that the *Teredo* can be supported independently of the wood which is eaten, and can afterwards subsist when the communication between it and the wood is cut off, a doubt, he adds, is created about the wood forming any part of its aliment, and it becomes pro-

bable that the *Teredo navalis*, like the *Teredo gigantea*, forms its habitation in a substance from which it receives no part of its sustenance; and that the sawdust conveyed through the intestines is not digested, particularly as that examined by Mr. Hatchett had not undergone the slightest change.

Mr. Hatchett found the ten grains of pulp from the specimen above referred to to be an impalpable vegetable sawdust. When burnt the smoke had precisely the odour of wood; it formed a charcoal easily consumed, and was converted into white ashes, in every respect like vegetable charcoal. Solution of potash did not act upon it, as it would have done if it had been an animal substance.

Sir Everard Home suggests that the straight course of the intestine in the *Teredines* makes it probable that the sawdust retards the progress of the food, so as to render convulsion unnecessary.

Teredo Navalis has been found at depths ranging from the surface to ten fathoms.

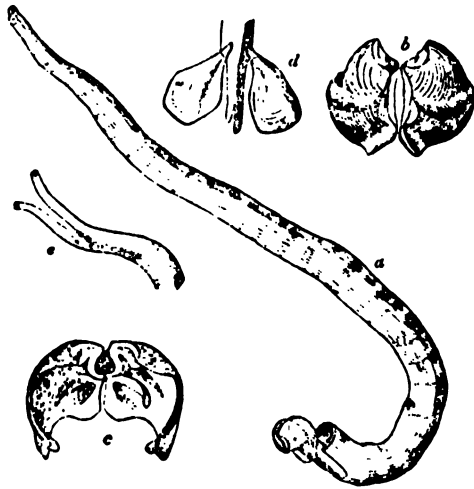

Shell and tube of *Teredo navalis*.

a, tubes with valves in their position at the end; b, c, two views of the valves; d, double operculum; e, representation of the protrusion of the two tubes of the animal. (*Phil. Trans.*) G. H. Sowerby.

It is said, probably with truth, that *Teredo navalis* was introduced into Europe from warmer climates. However that may be, it now unfortunately swarms in our seas. The ravages of this apparently insignificant animal are terrible. Ships, piles, all submarine wood-works, are ruinously affected by it: small as it is, it threatened the submersion of Holland by its destruction of the dykes. The living specimens which formed the subject of Sir Everard Home's observations were furnished from one of the royal dockyards. The rapidity of its growth and the destructive celerity with which it works are hardly credible. A piece of deal, after a submersion of forty days, was riddled by them, and some had attained considerable size. Those from the dockyard at Plymouth, examined by Montagu, were in piles which had been recently taken up to be replaced with new; they had not, according to the information given to Montagu, been under water above four or five years, but they were greatly perforated, though they were sound solid oak when they were driven. The only effectual way of preventing the attacks of this animal upon piles appears to be by covering all that part which is continually beneath the surface with short broad-headed nails. The action of the sea-water on the nails produces a strong coating of rust, said to be superior to a copper sheathing.

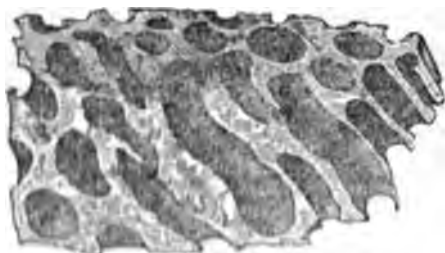

Wood perforated by *Teredines navalis*.

Teredo gigantea.—Rumphius, in his 'Amboinsche riteitkamer,' gives two figures, here copied, of a specific tubular shell found in shallow water among mangrove trees. He describes the ground whence they were brought and the mode in which the large end of the shell is so as to leave little doubt that it was *Teredo gigas*, though the separation of the two tubes through parts of the animal pass out is different from the specimen brought home by Mr. Griffiths. This difference, as the latter observes, may have been connected with the situation in which the animal was found, namely water among the mangroves.

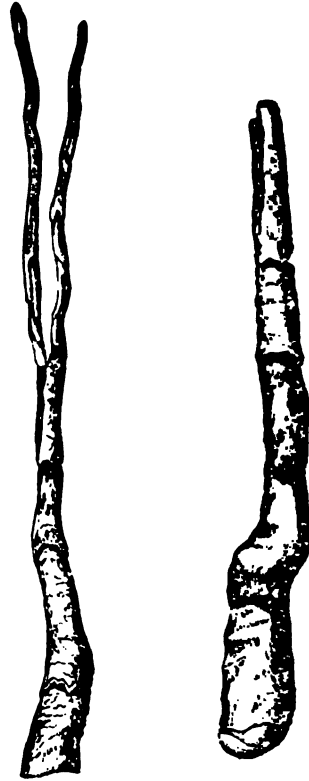

Teredo gigantea (Rumph.).

In 1805 Captain Maxwell of the *Calcutta East Indiaman* gave to Sir Everard (then Mr.) Home, a specimen of a shell, five feet long, but imperfect at both extremities. The captain said it was brought from Sumatra. Several of Mr. Home's friends considered it as a mineral substance, a hollow stalactite, being misled by its radiated structure. Sir Joseph Banks decided that it was a shell, and it was analysed by Mr. Hatchett, who found that it was composed of carbonate of lime and an animal gelatinous substance which was greater in quantity than in *Chama gigas*, less than in the common oyster. Mr. Home then applied to Mr. Marsden, who introduced him to Mr. Griffiths, the paper of the last-mentioned gentleman immediately precedes that of Mr. Home in *Phil. Trans.* for 1806.

Mr. Griffiths relates that a short time after a very violent earthquake that occurred in Sumatra in the year 1800, which produced 'a most tremendous' inundation of the did great damage, and caused the loss of many lives, shells were procured in a small sheltered bay with a mud bottom, surrounded by coral reefs, on the island of Ra. When the sea receded from the bay after the inundation they were seen protruding from a bank of slightly indurated mud, and two or three specimens were brought to Griffiths at Padang, by the master of a boat trading between that part and the island, for cocoa-nut oil, sea-coco, &c. Mr. Griffiths then sent one of his servants, a Pa-Coffee, who was very expert at diving, in a small boat. This servant stated that he had found the shells in a before-mentioned bay and in an inlet of the sea, about 100 yards out of rather hard mud, mixed with small stones, &c. from eight to ten inches or more, and from three to four fathoms under water. Both the servant and Mr. Griffiths assured Mr. Griffiths that the animal thro-

e two apertures of the apex of the shell, that
ed the small *actinix* adhering to the rocks about
and that the body of the shell was filled with a
stinous flesh, similar to that of the *Teredo navalis*,
they had washed out on account of its putridity.
d that the shells were in considerable number, and,
gently shaken, easily taken up; but all of them
tilated more or less, the effect probably of the
ake, when many large fragments of madrepora,
&c. were torn from their seat by the agitation of

More than twenty specimens were brought to
ffths, but not one was complete: a portion of the
th the apex nearly perfect, and another with the
closed extremity nearly so, were however pro-

The length of the longest of Mr. Griffiths's shells
eet 4 inches, and the circumference of the base
s, tapering upwards to 2½ inches. There were
ood ones of smaller size. The large specimen was
erfect, having a small part of the lower extremity

Most of the shells had adhering to them, about
or more from the top, the small cockscob oyster,
erpulæ, &c.; consequently, Mr. Griffiths observes,
ust have been protruded that distance from the
id; but the water being thick and discoloured, the
of Battoo had not taken notice of them antecedent
arthquake. The specimens were milk-white on the
and within were tinged with yellow. Mr. Griffiths

that the large end of the shell is completely
nd has a rounded appearance; at this part it is
n. The small end, or apex, is very brittle and
by a longitudinal septum running down for eight
inches, forming it into two distinct tubes, inclosed
he outer one, from whence the animal throws out
a. Mr. Griffiths goes on to describe the substance
hell as composed of layers having a fibrous and
appearance, covered externally with a pure white
nd internally as having a yellow tinge; and the
l surface as frequently interrupted in a transverse
n by a sudden increase of thickness, which, he
s, probably indicates different stages in the growth

of the shell, although they are at unequal distances, some-
times at six inches, sometimes at four, in the same shell.
Many of the shells, he adds, are nearly straight, others
crooked and contorted.

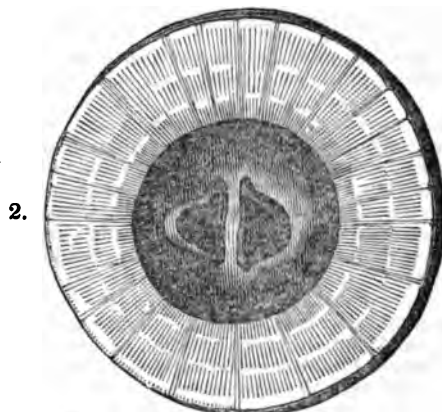
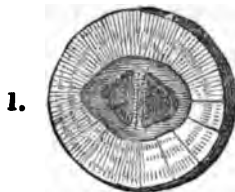

Teredo gigantea.

1, transverse section of shell, giving a front view into the orifices of the double tube, and showing the thickness of the shell at that part. 2, transverse section of shell at the thickest part after it had been polished, showing the structure, and giving a front view of the orifices into the double tube. (*Phil. Trans.*)

Fossil TEREDINES.

M. Deshayes in his Tables notes five species of fossil *Teredines* in the tertiary formation, Eocene period of Lyell:—one from the English crag, one from Paris, and four from Belgium. Mr. Lea (*Contributions to Geology*) records a species, *Teredo simplex*, from the Claiborne Beds, Alabama (tertiary). Professor Sedgwick and Mr. Murchison notice the genus in their *Table of Fossils found in the Gosau Deposit and its Equivalents in the Alps*; and also '*Teredo* or *Pholas*,' in their *Table of Fossils of Lower Styria*, as belonging to the 'middle system.' Dr. Fitton, in his *Systematic and Stratigraphical List of Fossils in the Strata below the Chalk*, notes the genus, with a query, from the gault of Kent and Cambridge.

TERENTIA. [CICERO.]

TERENTIAN METRES. Few subjects connected with Latin literature have been treated with less success than the principles and laws which govern the metres of Latin comedy. The majority of readers seem to look upon the writings of Plautus and Terence as so much humble prose arbitrarily distributed so as to present to the eye the appearance of verse without its realities. For them it would be better if the whole were printed consecutively, and such an arrangement would in fact be supported by not a few of the existing manuscripts. On the other hand, there have been writers who have laboured to remove the difficulties that obscure the subject, among whom none but Bentley and Hermann appear to have had any success; and what they have done still leaves the subject in a very unsatisfactory position. Even the writer of the *Life of Terence*, in the '*Biographie Universelle*' (published in 1826), has the following extraordinary criticism upon the metres of Terence:—'The sole rule which he observes with tolerable regularity is to end each verse with an iamb; and even this limitation he often disregards, as, for instance, in the terminations *hic consistit*; *si vis, nunc jam*; *audio violenter*; *huc adducam*; *hanc venturam*, &c. With regard to the other feet, he freely substitutes for the iamb or spondee, a trochee, anapest, dactyl, double pyrrhic, or four short syllables, and a cretic or short between two longs,' &c. This writer thus starts with the false impression that all the verses of Terence are reduced by critics to the single metre, called trimeter iambic; where-

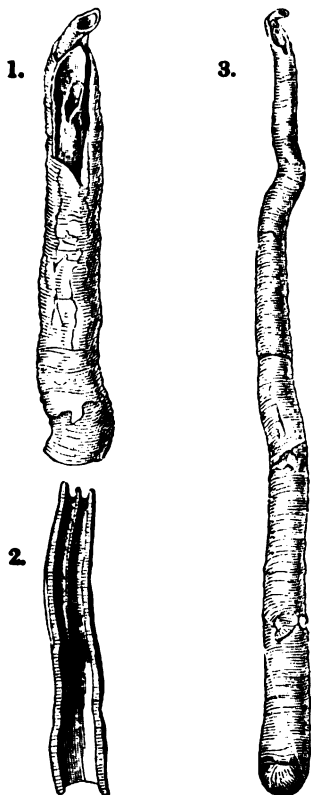

Teredo gigantea.

small or upper extremity of the shell, the external covering broken showing the termination of the tubes, one of which is broken. 2, a section of that part of the shell where the double tubes are formed. 3, complete, or nearly so, the exception being the imperfect state of extremity. (*Phil. Trans.*)
P. C., No. 1516.

as, in fact, all who have dealt with the subject, except himself, are aware that the poet has at least three forms of verse which end trochaically; and his second exception is disposed of by the more correct orthography *nunc iam*. In England again, so late as the year 1837, we have a scheme of the Terentian metres, which for the commonest of those metres, the trimeter-iambic, gives us the following scale:—

—	—	—	—	—	—
—	—	—	—	—	—
—	—	—	—	—	—
—	—	—	—	—	—
—	—	—	—	—	—
—	—	—	—	—	—
—	—	—	—	—	—
—	—	—	—	—	—
—	—	—	—	—	—
—	—	—	—	—	—

with the additional remarks that *quo quid hunc* may be a dactyl, that *hic quidem est, studet* &c., and the three first syllables of *voluptati*, may pass for anapests, &c. &c. All this is exceedingly unsatisfactory, and it would be better to abandon the problem as insoluble, than to give currency to extravagancies which would enable us to find in any given chapter of Cæsar a series of trimeter-iambics.

It must be admitted that the metres of the Greek dramatists, and more particularly of the tragedians, gratify the ear with rhythms which, comparatively speaking, are smooth and appreciable. But it should be recollected, in the first place, that the Greek language is distinguished from among other languages by its abundance of words which end in a short syllable, and the advantage to the poet is increased by the large number of instances where these short final syllables have a vowel ending. Compare, for instance, the accusatives singular *μουσαν, ζουλον, ποτιν, δαιμονα*, with the Latin *musam, sergom, parim, leonem*; the nominative and accusative plural *δαιμονες, δαιμονας*, with the Latin *leones*; the numerals *επτα, δεκα*, with the Latin *septem, decem*; the verbs *τυπτει, τυπτοισι*, with the Latin *scribitis, scribunt*; the pronouns *με, σε, ι*, with *mē, tē, sē*. In fact, the Latin language exceeds the Greek in the number of long syllables, as much as the English and German languages exceed the Latin.

A still more important matter is the question whether and how far the written language of the Romans is an exact representative of the spoken language. It seems to be a condition of language in general that its pronunciation should always be passing through a series of changes, and that those changes should consist for the most part in the gradual omission of letters and even syllables. Thus the Roman phrase *mea domina* is in Italian *madonna*: in French *madame*; in English *madam, ma'am*, and even *mom* and *mim*. Meanwhile, for the most part, the changes in orthography are slow, and consequently nearly always in arrears of the orthoepy. Thus it will be found that the sounds of English and German words which appear to the eye so weighed down with consonants, are in the mouth of a native tolerably harmonious. Was such the case with the Roman also? We answer with little hesitation in the affirmative, partly because the laws which now govern language can scarcely have been wanting in ancient Italy, and partly because we find the point established by several incidental remarks in Latin writers. Thus Suetonius says, in his Life of Augustus (c. 88), ‘Orthography—that is, the laws and principles of writing laid down by grammarians—he was not very observant of, but seems rather to follow the opinion of those who hold that we should write as we speak. For as to his habit of changing or omitting not merely single letters, but even whole syllables, that is a common error.’ It should be observed too, that Suetonius had himself seen the handwriting of the emperor. (Ibid., c. 87.) Again, Quintilian (*Inst.*, xi. 3, 33) says, ‘As, on the one hand, it is essential that every word should be clearly articulated; so, on the other hand, to reckon up, if we may so speak, every separate letter, is painful and wearisome.’ In the same chapter he further observes, ‘Not only is a coalition of vowels very common, but some too of the consonants are disguised (*dissimulantur*), when a vowel follows; where he must refer to some other letter than *m*, probably the final *s* generally and the final *d* of neuter pronouns. Moreover Priscian, who by the way appears to have written when the Latin language had ceased to be spoken as a living tongue, at times throws out such conjectures as the following:—‘I think that *vigil, vigilis*,

should rather be pronounced *per synepoam*. We might appeal to Cicero’s authority for the fact that a final *s* was frequently omitted in pronunciation. But there are still other arguments in support of the principle for which we are contending. Within the limits of the Latin language itself we find such changes actually in progress—*magis, nisi, ipsius, neque, atque, vir, nec, videtur, videtur, providens, mihi, nihil, quibus, populus, tegmina, opera, potesse, mavolo, nocerit, novisti, doctus*, becoming severally *mige, ni, ipse, nec, ac, vir, neu, videre, videre, prudens, mi, nil, quia, populus*; compare also *populus, tegmen, opus, posse, malo, nocit, nosti, deus or dis*. Principles of etymology would enable us to carry the list out to a vast extent, and this still more if we employed the analogues of the Greek tongue.

Again, the languages which are acknowledged to be derived from the Latin, such as that of the Troubadours, the Italian, French, Spanish, Portuguese, and one portion of the English, by their shortened forms, confirm our views. And this will be found to be specially the case with the French. To those who may express their surprise that the French should thus take precedence in our argument of the It the answer is, that the French is probably derived from the Latin more completely than even the Italian; the Celtic, Teutonic, and Iberic languages spoken in France before the Roman conquest of that country were of too foreign a character to mix with the language of the conquerors or to supply the place of it in the mouths of the provincials with their masters; whereas in France there already existed dialects which were intelligible to those who came from Rome, and for that very reason were not supplanted by that particular form of the Italian language which happened to prevail in the metropolis. In the same way the authorised dialect of our own tongue is more likely to become the current language of Italy than of Yorkshire. Add to this that the language now called Italian belongs to Tuscany, not to Rome.

Lastly, we find much to strengthen our present argument in the abbreviated forms of writing which were in use by the Romans and are still found in manuscripts. Thus the word *consul* is written *cos*, because the *n* was not pronounced before *s*, as Diomedes expressly tells us. (Putsch, 424.) Again, the word *modo* not unfrequently occupies such a position in the verses of Terence as to seem to require a monosyllabic pronunciation, such indeed as seems more consistent with its enclitic character. This very word enters into the composition of the Latin *quomodo*, which again in the languages derived from Latin assumes various forms: in the Romance, *com*; in Spanish, *com*; in Italian, *come*; and in French, *comme*. To this we add the fact that the Romans themselves represented a simple word by the abbreviation *mō*. Again, *en* is a manuscript mode of denoting the conjunction *et*, which must often be pronounced like *en* to fulfil the conditions of Terence’s metre. We may observe of this *en* as of *modo*, that an enclitic should not attract the attention of the ear. A third example shall be a third enclitic, *quidem*. Bentley himself observed the trouble caused by this word in the verses of Terence (*Andr.*, i. 3, 20), and his remedy is to drop the final *m*, which however still leaves the verse encumbered with a superabundance of syllables. We contend that this also is commonly a monosyllabic word, and on the following grounds. First, the metre of Terence requires it. Secondly, if *quidem* has a reduced form, the analogy will give us *quem* for *quidem*. Thirdly, the Romans, like the French, did not pronounce the vowel *u* at the end of words, *quid* for instance, would have had the first syllable long, and they also disguised the final *m*. Quintilian implies in the passage to which we have already referred. Thus we have arrived at a sound *qu*. Now the Greek language has a word of precisely the same power and character, *γῆ*, which we strongly suspect to be the very same word; so that if our suspicions be right, *quidem* and *γῆ* are of one origin, as well as of one meaning. Lastly, there are reasons still remaining which demand a monosyllabic pronunciation for *quidem*. We have already called it an enclitic, and it appears beyond dispute in that character in the words *equidem, siquidem, quandoquidem*. Now an enclitic should in its nature sacrifice itself to give tone to the word which precedes it. Yet if we believe the ordinary teachers of Latin prosody, *quidem*, though a corruption from *egoquidem*, or *equidem*, has the first syllable short. Again, *quando* by itself has the final *o* common

take the most unfavourable view, for in the poets of Augustan age it would be difficult to find a single mple where *o* is short; and in *quandoque*, *quandoque*, the vowel is always long. But add *quidam* and they say *quandoquidem* has the same vowel *ys* short. So also *si* in *siquidem*, according to their *loses* its length the moment the enclitic attaches to it. If our views be right, the true pronunciation *these* three words may be represented by something like *ke*, *quandōke*, *sike*; the last corresponding to the Greek *να*. We will here observe in passing, that our pronunciation of *quidem* suggests a correction of a corrupt passage in Persius, Sat. i. 10:

'Littera. Per me quidem sicut omnia protinus alba.'

The current reading is *equidem*; and relying upon one error the editors have allowed the same *equidem* to stand with *dubites* in Sat. v. 45, when the context, as well as grammar, requires *dubitem*.

to return to the subject before us. It is not uncommon with critics to imagine to themselves that the laws of Greek and of Latin verse are based upon principles essentially different from those of modern languages; the former depending, they say, upon the length of syllables, the latter upon accent. This distinction we believe to be wholly without foundation. We rely little upon the fact that Priscian's treatise headed 'De Accentibus' is a schoolboy-like scanning of the first lines in the *eid*, because, as has been already said, that writer's authority is not of great weight in what concerns the spoken tongue; and in fact, for the same reason there is a dependence to be placed upon the dogmas of the former so-called grammarians, such as Diomedes. Our views upon this subject are rather derived from the perusal of Terence and Plautus themselves, and are confirmed to a considerable extent by the hexameters of Virgil and the lyrics of Horace. They also seem to be supported by the general principles of language. We will endeavour briefly to state the results at which we think we have fairly arrived.

I. In words of more than two syllables, if, according to the received prosodies, two or more short syllables, exclusive of the final syllable, occur together, the second of these short syllables was slurred over. For instance, in cases the changing a vowel *i* or *e* into the sound of a *y*, or of a vowel *a*, *o*, or *u* into the sound of a *w*, would be the simplest mode of effecting such a result. Thus *adtribuere*, *peritimus*, *consilium*, would upon our theory be pronounced *adtribuere*, *periyimus*, *consilyum*. The last of these is confirmed by Horace's use of the same word in odes, and the Italian *consiglio*, Fr. *conseil*, Sp. *consejo*; and at any rate our pronunciation of the two former is more consistent with the quantity of the vowels in the mode usually adopted, viz. *per-ti-imus*, *adtribuere*. They have himself observed (*Eun.*, ii. 2, 36) that the *mulier*, *mulieris*, &c. are always so placed in Terence as to have the accent on the first syllable; which, by the way, is consistent with the Italian *moglie*, and the Spanish *muger*. We doubt however whether the dative would be found to obey the law laid down by Terence. In those cases where the second short vowel is followed by a consonant, the abbreviation proposed becomes impracticable, if at least that consonant be really to be sounded. In such cases the right course is probably to drop the syllable altogether. Thus *miseria*, *familia*, and other words. Hermann (*De Re Metrica*) truly says, are to be pronounced with the accent on the first syllable, and this in accordance of the law laid down by all the grammarians, that the accent cannot be carried farther from the end of a word than the antepenult. Hermann has not attempted to reconcile the two assertions, but they fall at once into agreement if we are right in dropping the second syllable. Then the first becomes an antepenultimate; and we are only doing what is common in our own language, as in *try*, *lovely*. This principle moreover may be clearly seen in forms acknowledged to be Latin. Thus from *populus* should be formed *populicus*, but that becomes *opticus* or *publicus*. If *pello* has a perfect *pepuli*, *cado* perfect *ceccidi*; the compounds with *re* should strictly give us *repepuli*, *receccidi*; but we find *reppuli*, *reccidi*. Again, in connection with *optifex* we ought to have *optifexium* and *optifexina*; but these have been supplanted by *optifexium*, *optifexina*. So too the Greek *επιπιδω* becomes

in Latin *oppidum*, as opposed to the *arx*, or citadel; and the adverb *επιπιδως* takes the form of *oppido*, an equivalent in meaning to *plane*.

II. The accent of a Latin dissyllable or polysyllable will fall upon the penult if long. Where that penult is long by the nature of the vowel, and at the same time the final syllable is short, the accent upon the penult is called a circumflex; in other cases an acute accent. Secondly, if the penult be short, put an acute accent upon the antepenult, always performing the previously mentioned abbreviation, if need be; the necessary effect of which is to give us a long antepenult, if the penult itself be short.

III. The preceding rules dispose of every case except two classes of words, viz. dissyllables with a short penult, and monosyllables. The former are either to be pronounced as monosyllables, or else to be attached to the preceding or following word; and the double word thus formed to be accentuated as a polysyllable. When a word is attached in pronunciation to that which precedes, it has already received in common use the name of enclitic. Hermann, who first observed that there are also words which attach themselves to those which follow, has proposed to give them the name of proclitics. The Greek article, for instance, belongs to this class, as also not unfrequently the Latin *hic*, *haec*, &c. The same is true of prepositions, when really prepositions, that is, when they precede their noun; and the Latin *non* or *ne*, like the Greek *ου*, should perhaps in many cases be pronounced in immediate connection with the following verb, just as we, who are accustomed to place our *not* after a verb, write *cannot* as a single word. Many little conjunctions also may probably require such treatment, as *si*, *ut*, &c. Again, the list of enclitics should be extended so as to include most of the conjunctions which require to be placed second in a sentence, and even conjunctions in general, together with the relative itself when they are forced, if the word may be used, into a second place, as, for instance, in the first line of the 'Æneid,' which acquires additional power by the pronunciation *Troiaë-qui*. In the same way a postponed preposition becomes an enclitic, as in the phrase *allis-de montibus*. In this way many dissyllables and monosyllables will coalesce into polysyllables, and be accentuated accordingly. We even entertain a strong suspicion that a verb in the middle of a sentence must often be treated as an enclitic to give tone to some important word before it. But a statement of our grounds for this belief would require too much room.

IV. The principle of elision will often modify the accent of a word. Thus *cumprimum*, *scribendum*, *argumento*, would in ordinary circumstances have the accent as marked. But if elision take place, they sometimes have the accent displaced. In this way the first and eleventh lines of the Prologue to the 'Andria' should be read: 'Poëta cum-prim am' adscribend' adpult'; and 'Non yt' dissim'li sunt argumēt' et tamen.' It should also be observed that elision often destroys the initial vowel of the second word, instead of the final syllable of the preceding word, as *nunc tuamst officium*, rather than *nunc tu' est officium*.

If now the principles we have assumed on the grounds above mentioned be applied to the plays of Terence, we arrive at the result, that the verses, with very few exceptions, acquire the desired rhythm; and that there should be exceptions must be expected where the text of an author is not yet established upon a careful comparison of manuscripts, and where even the transposition of two words will often alter the accent. Moreover it should always be recollected that in the comic drama it may be even desirable to avoid the purer rhythm of verse, and approach somewhat to the prose of natural conversation, as Cicero has himself remarked (*Orator.*, 55). That what we now say may be put to the test, we will give a list of those words requiring abbreviation which most commonly occur, observing at the same time that a word at the end of an iambic trimeter, or after a monosyllable, is often to be pronounced with all its syllables, though elsewhere liable to contraction. Of this an example may be seen in the tenth line of the prologue already referred to, which contains both *noverit* and *norit*.

senex = *sen*. Compare the genitive.

pater = *père*. Compare *parricida*.

soror = *soeur*, as in French.

voluntas = *vountas*. Compare *vis* = *vôlts* and *invitus*.

acruma = *larma*. Compare *serment*, from *sacramentum*.
hodie = *oggi*, as in Italian.
dies = *jes*. Compare *jour*, *journée*.
ego = *yo*. Compare Italian.
causa = *cau*. Compare Cicero's story about the word *cauneas*.
tace = *tai*, as in French.
quibus = *quis*. Compare the loss of *b* in the dat. pl. of the first and second declensions.
tibi = *ti*.
sibi = *si*.
ibi = *i*. } Compare the Romance, Ital., Fr., Sp., and
ubi = *ou*. } *mhi* = *mi*.
abi = *ai*.
jube = *ju*. Compare the perfect *jussi*.
inde = *in*. Compare the French *en*, and Latin *dein*, *exin*, &c.
redi = *rei*.
magis = *mais*. Compare *mai* It., *mais* Fr., *mas* Sp.
minus = *mins*.
alius = *alyus*. Compare Greek *ἄλλος*.
facere = *fare*. Compare Fr., Ital., Sp.
vigilare = *vigliare*. Compare Fr., Ital.
vide = *vi*. Compare Fr. *voi-ci*, *voi-la*.
novos = *nous*. Compare Greek *νεός*, English *new*.
sine = *sin*. Compare Fr., Ital., Sp.
duo = *do*. Compare Greek *δύ-δeka*, Fr., Eng.
ille, &c. = *il* or *le*, &c. Compare It., Fr., Sp.
bonus = *bon*,
sumus = *sommes*, } as in French.
bene = *ben*.
male = *mal*.
homo = *homme*, as in French.
rei = *re*. Compare the forms of the fifth declension used by *Cæsar*, *Virgil*, &c.
puer = *pur* or *por*. Compare Greek *παῖς*, Spartan *παιρ*, Latin *Lucipor*.
suus, &c. = *sus* or *sos*. } Compare It., Fr., Sp., and also
meus, &c. = *mus*, &c. } the forms used by *Ennius*, and
tuus = *tus*, &c. } in Greek.
fuit = *fut*. Compare It., Fr., and Latin *fore*.
animus = *âmus*. Compare Ital., Fr.
asinus = *ânus*. Compare Fr.
edepol = *epol*. Compare *ecastor*, *ecere*, &c.
legere = *lere*. Compare Fr.
oculus = *oeilus*. Compare Fr.
generis = *genris*. Compare Fr.
aperire = *aprire*. Compare It., Fr., Sp.
opera = *opra*. Compare the form in *Ennius*, and Fr., Sp.
similis = *sim'lis*. Compare Fr. *semble*, Eng. *resemble*.
tamen = *ta'n*. Compare *tametsi* for *tamenetsi*, and *tandem* for *tamendem*.
aliquis = *alquis*. Compare It. *alcuno*, Fr. *aucun*, from *aliquis-unus*.
hujus = *his*. Compare the abbreviation of *nullius* into *nullus* and *nulli*.
ejus = *is*.

For a more detailed exhibition of these words see *Journal of Education*, vol. ii., p. 344; and on the subject of Latin prosody generally, the same work, vol. iv., p. 336.

It should be added that of modern editors *Hermann*, *Bothe*, and *Lindemann* alone seem to have a distinct idea of the nature of the metres of *Terence* and *Plautus*, for all that has been said applies to *Plautus* as well as *Terence*. Among older writers, *Bentley* certainly possessed a clearer insight into the subject than some of his notes would lead one to suppose. That this is the case is proved by an anecdote in *Bishop Monk's Life* of that scholar. The reverend doctor, dining at a friend's house in London, kept the gentlemen longer over their wine than was thought proper by the ladies in the drawing-room, and added to the scandal when his voice was heard, even above stairs, in what was supposed to be a song to the tune of 'Unfortunate Miss Bailey.' The doctor was only reading to them some specimen of *Terence's* *Comic Septenarius*, or, to use a harder phrase, the *Iambic Tetrameter Catalectic*.

TERENTIANUS MAURUS. [MAURUS TERENTIANUS.]
 TERENTIUS, or more fully P. TERENTIUS AFER, was one of the two comic poets of Rome whose works have come down to us. The facts of his life were matter of dispute even among the Romans themselves. If we may rely upon the biography attributed by some to *Donatus*, by

others to *Suetonius*, he was born at Carthage, and became the slave of a Roman senator named *Terentius Lucanus* who, pleased with his abilities and handsome person, gave him a liberal education and afterwards his freedom at an early age. Some, on the other hand, stated originally fell into slavery as a prisoner of war. He lived on terms of intimacy with many men of family, particularly the second *Scipio Africanus* and *Laelius*, who were even said to have assisted in the composition of the six comedies which bear the name of *Terence*. There were even some who asserted that two nobles merely borrowed the name of *Terence* was wholly their own. Before he had completed his thirty-fifth year he left Rome, either to avoid the which grew out of the suspicion that he had published the writings of others as his own, or to study the manners of the Greek nation, and thus qualify himself for fresh exertions in the field he had chosen. He returned, but the accounts of his death were very different. Some said that he embarked for Asia, and was never seen from the hour of his embarkation; others that he died on his way back from Greece, where he had translated hundred and eight plays of *Menander*; while others contended that having sent his translated plays in a private ship, he received the news that this ship with the valued property was lost at sea, and died through grief the consulship of *Cn. Cornelius Dolabella* and *M. Fulvius Nobilior*, either at *Stymphalus* in *Arcadia* or at the *Cadian promontory*. He was of moderate stature, slender figure, and dark complexion. He left a daughter, who married a Roman of equestrian rank, and a property of jugers on the *Appian road*. But another authority reports that he died in the most abject poverty. *Eusebius*, or *St. Jerome*, places the death of *Terence* in the reign of *Ptolemy Philometor*, and this king died in the third year of the 158th Olympiad, or the close of 146 B.C.

The difficulties in the life of *Terence* are chiefly of a chronological character: the following table of dates bears upon it:—

218 B.C. Commencement of Second Punic War.
 201 B.C. Peace granted to the Carthaginians.
 185 B.C. Birth of *Scipio Africanus* the younger.
 184 B.C. Death of *Plautus*.
 169 B.C. Death of *Ennius*.
 168 B.C. Death of *Cæcilius* (partly on the authority of *St. Jerome*).
 166 B.C. The 'Andria' acted at the *Megalensian* games.
 165 B.C. The 'Hecyra' acted at the same games.
 163 B.C. The 'Hautontimorumenos' acted at the same games.
 161 B.C. The 'Eunuchos' acted at the same games as the 'Phormio' at the Roman games.
 160 B.C. Death of *Emilius Paulus*. The *Ad Phormionem* acted at his funeral games, at the expense of *his* *Fabius* and *Scipio*.
 159 B.C. Consulship of *Cn. Cornelius Dolabella* and *Fulvius Nobilior*.
 149 B.C. Commencement of the Third Punic War.

Thus it appears that the whole period of *Terence's* life must have been included in the peace between the Second and the Third Punic wars; so that if taken prior to the first war, that war could not have been one between Rome and Carthage. Again, there is a chronological difficulty in the story that the poet, when he offered his comedies to the *ædiles*, was directed to obtain the approval of *Cæcilius* that he accordingly went to the house of the latter, who was coldly bidden to seat himself on a stool and commence reading while the other dined; but that a few verses *Cæcilius* was so charmed that he begged *Terence* to take his seat at the table and dine with him, after which he read through the remainder of the comedy and filled *Cæcilius* with admiration. Now the date of *Cæcilius*, though the date, as we have observed, is a measure founded upon the testimony of *St. Jerome*, occurred two years before the 'Andria' was acted. The assertion that *Scipio* and *Laelius* assisted the poet altogether rendered impossible by the youth of the latter, although *Scipio* was but nineteen when the 'Andria' acted, and *Laelius* was of about the same age as his friend; but the difficulty becomes greater when we consider the prologue of the 'Adelphoe,' that the nobles who were said to give him their aid, are spoken of in terms applicable to men so young.

Be the parties charged to have lent their aid to the poet who they may, it is clear that the poet gives no denial to the accusation, either in the words just alluded to, or in the dialogue to the 'Hautontimorumenos.' Even Cicero (*Ad Atticum*, vii. 3) mentions the report that Lælius was the real actor; and Cornelius Nepos, who by the way makes the same parties, Scipio, Lælius, and Terence, of the same age (see *Uales*), tells us an anecdote which confirms the report. Lælius, says he, happening to pass the Matronalia (as on the first of March, when the husband for once in the year was bound to obey the lady) in his villa near Puteoli, told that dinner was waiting, but still neglected his duties. At last, when he made his appearance, he excused himself by saying that he had been in a peculiar situation of composition, and quoted certain verses which occur in the 'Hautontimorumenos,' viz. those beginning *Satis potest esse me Syri promissa huc induxerunt.*

The fact of the poet being called Terentius is perfectly in harmony with the circumstance of his alleged mastering that name, as it was the ordinary practice of the admitted slave to take the nomen and prænomen of his master. On the other hand, it is altogether an error to suppose the part of Orosius to confound the poet with the Quæstor Culleo, who, in the garb of a manumitted slave, accompanied the triumphal procession of Scipio after his destruction of Carthage in the year 146 B.C. The name of Culleo seems to confirm his Carthaginian birth, unless indeed the assertion be only an inference from the name itself. Terence acknowledges in the titles to his plays his obligation to the Greek comedians Menander and Apollonius, but he was not a mere translator, for one of the charges brought against him was that he drew the materials of a single play from two or more of the Greek plays. He was much and deservedly admired by his countrymen, even by Cæsar himself, notwithstanding the phrase in which he speaks of him, as a 'dwarfed Menander' (diminutive Menander). From Plautus, with whom alone we can now make any satisfactory comparison, he differs most widely. Though Plautus excelled in powerful but ludicrous expressions, he was altogether deficient in the formation and development of a plot. Terence, on the other hand, though even he occasionally introduces the buffoonery of the 'miles gloriosus,' the 'parasitus,' and the 'currens currens,' to gratify the prejudices of his more unpolished readers, who were better able to appreciate the merits of a boxer or a rope-dancer, still deserves our admiration for his efforts to place before his countrymen the comedy of Mæcenas. If he was not always successful, the failure was to the rude minds of his spectators and the magnificence of a Roman theatre, and perhaps also to the use of the metre, which, if always used, must have been a serious obstacle to the best efforts of the comic actor. The best specimen of Terence is that of Bentley, Amsterdam, 1727. The modern imitations of Terence may be seen in Dunlop's *Roman Literature*. George Colman has translated the comedies of Terence into English. There are French translations by Madame Dacier and Le Monnier.

TEREZ. [MEXICAN STATES.]

TERGIPES. [NUDIBRANCHIATA, vol. xvi., p. 361.]

TERM (Algebra). A simple term in an algebraical expression means all that involves multiplication, division, extraction of roots without addition or subtraction, in the expression

$$a^2b^3x^2 - 2abx^3 + \sqrt{ab} \cdot x^4,$$

where the terms are $a^2b^3x^2$, $2abx^3$, and $\sqrt{ab} \cdot x^4$. But compound terms are also called terms when they are put in such form that additions and subtractions are subordinate to subsequent multiplication, division, or extraction. Thus,

$$(a+b)x^{c+d} + \sqrt{(a^2-b^2)} \cdot xy$$

consists of two terms, $(a+b)x^{c+d}$ and $\sqrt{(a^2-b^2)} \cdot xy$. If the first be altered into

$$ax^{c+d} + bx^{c+d} + \sqrt{(a^2-b^2)} \cdot xy,$$

the expression then has three terms. Most frequently however there is one letter in powers of which the whole expression is arranged, and then all that involves any one power of this principal letter is a term. Thus $a+bx+cx^2+x^3$ has three terms, namely, a , $(b+c)x$, and x^3 . When one quantity is said to be expressed in terms of another, it generally means merely that the first is to be expressed as an explicit function of the second. Thus, in $x+y=a$, we have expressed $x+y$ in terms of a : deduce $y=a-x$,

and we have y expressed in terms of a and x . This is the distinction between y being expressed in terms of x , and y being a function of x : if for instance $y=a-x$, $z=x^2+x$, y is a function of x , but it is not expressed in terms of x , but of z ; substitute for z its value, and y is then expressed in terms of x . It is to be remembered that by saying that a quantity is expressed in terms of x , it is not meant that x is the only letter which enters, but that no other letter, if there be any, is a function of x . Thus, in the preceding, where we obtain $y=a-x-x^2$, y is expressed in terms of x if a be no function of x . But if a be a function of x , say x^3+x , then y is not expressed in terms of x , until the value of a has been substituted, giving $y=x^3-x^2$.

TERM. The law Terms are those portions of the year during which the courts of common law sit for the dispatch of business. They are four in number, and are called Hilary Term, Easter Term, Trinity Term, and Michaelmas Term: they take their names from those festivals of the Church which immediately preceded the commencement of each. After the institution of Christianity, all days in the year, Sundays included, were among Christians for some time open for the purposes of litigation. This practice continued even after Christianity became the religion of the Roman empire. Eventually however the courts of law were closed during Sundays, and also during the times of the solemn fasts and festivals of the Church. This regulation was made by a canon of the Church, in the year A.D. 517, and also by a constitution of the younger Theodosius which appears in the Theodosian Code. By these means one vacation was created in the winter during the time of Advent and Christmas, another in the spring during Lent and Easter, and a third during Pentecost. The long vacation in the summer and autumn was also found necessary, and therefore appointed during the time required for collecting the harvest and vintage. The same arrangements were introduced with Christianity into this island. The laws of Edward the Confessor contain the same provisions as to the observance of a vacation from legal business during the fasts and festivals before mentioned. The necessities of a people at that time so universally agricultural seem to have compelled the observance of the long vacation. The Terms therefore consist of what remains of the whole year after the ecclesiastical and agricultural vacations had been taken out of it. It was the commencement of the Terms which was ascertained by the dates of the festivals from which they take their names. Various acts of parliament have been passed relative to the regulation of the Terms. The statute which now determines them is the 11 Geo. IV. and 1 Wm. IV., c. 70, amended by 1 Wm. IV., c. 3, which enacts that Hilary Term shall begin on the 11th and end on the 31st of January; Easter begin on the 15th of April and end on the 8th of May; Trinity begin on the 22nd of May and end on the 12th of June; Michaelmas begin on the 2nd and end on the 25th of November. The Monday being in all cases substituted for the Sunday when the first day of Term falls on the latter day. During Term four judges sit in each court, and are occupied in deciding pure matters of law only, without the intervention of a jury. The fifth judge in each court sometimes sits alone to determine matters of smaller importance or to try causes at Nisi Prius. By the statute 1 and 2 Vic., c. 32, the courts of common law are empowered, upon giving notice, to hold sittings out of Term for the purpose of disposing of the business then pending and undecided before them. These sittings are conducted in the same manner as those during the Term, except that no new business is introduced. The period during which they have the power to do this is restricted to 'such times as are now by law appointed for holding sittings at Nisi Prius in London and Westminster.' These times are appointed by 1 Wm. IV., c. 70, s. 7, and consist of 'not more than twenty-four days, exclusive of Sundays, after any Hilary, Trinity, and Michaelmas Term, nor more than six days, exclusive of Sundays, after any Easter Term, to be reckoned consecutively after such Terms.' The judges are also empowered by the same section to appoint such day or days as they shall think fit for any trial at bar (that is, a trial before four judges of the court) and the time so appointed, if in vacation, is for the purposes of the trial to be deemed a part of the preceding Term.

There is also a provision which enables the judges, with the consent of the parties, to appoint any time not within

the twenty-four days for the trial of any cause at Nisi Prius. The sittings during these twenty-four and six days are called the sitting after Term, and are held for the trials for causes at Nisi Prius for London and Westminster, which places do not form part of any of the circuits. Sittings at Nisi Prius are also held for the same purpose before single judges during Term time, but no special jury cases are taken within the Term. (Spelman, *Of the Terms*; 3 Blackstone's *Com.*, 275.)

TERM (of years), in legal language, signifies the estate and interest which pass to the person to whom an estate for years is granted by the owner of the fee.

A term of years may be created by a conveyance at common law, but no estate is vested in the grantee, nor anything beyond a mere *interesse termini*, until an actual entry is made by him upon the land. The tenant for a term of years is not said to be seised of the land, and the possession is not given to him by livery of seisin. The delivery of a lease for years gives to the grantee a right of entry on the land; when he actually enters, he becomes possessed of the term; the seisin of the freehold still remains in the lessor, and the possession of the lessee for years is then considered as the possession of the person entitled to the freehold or reversion expectant on the determination of the term. (Co. Litt., 200 b.)

By the operation of the Statute of Uses an estate for a term of years may be created without an entry by the tenant; as where a freehold estate is conveyed to A and his heirs to the use of B for 99 years, with remainder to the grantor in fee: there the use is immediately executed in B, and the statute instantly annexes to it the legal estate, without any actual entry by B.

A term of years may also be created by devise in a will.

A term of years may be limited to commence *in futuro*, which a freehold cannot; for the freehold is not put in abeyance by the creation of such a term, as it would be by the creation of a freehold estate to commence *in futuro*, but it continues in the grantor. (Co. Litt., 46 a.)

A term of years may be limited so as to cease by a proviso in the conveyance itself, upon the happening of any event, or the performance of any particular act (Co. Litt., 46 a.); and it is usual, when terms of years are created for the purposes of certain trusts, to insert a proviso for the ceasing of the term upon the performance and satisfaction of the trusts of the term.

Long terms, as of 500 or 1000 years, are frequently created by way of mortgage, with a proviso for determining them upon payment of the money by a certain day. These are more advantageous than mortgages in fee in one respect, that there does not arise, as in the case of the latter, a separation of the legal estate and the interest in the debt upon the death of the mortgagee. Similar terms are also frequently granted to the trustees of marriage settlements for the purpose of enabling them by sale or mortgage of the terms to raise portions for children and for other purposes. It sometimes happens therefore that, though courts of equity interfere, as in case of mortgages in fee, to enlarge the period of redemption, long terms of years of the kind above mentioned become absolute property. Again, it frequently happens that when a redemption does take place after the time fixed in the original contract, when, according to the theory of mortgages, the estate has become absolute at law, the term may, instead of being surrendered to the owner of the inheritance, be assigned to a trustee for him and his heirs, and retained as an appendage to that inheritance under the name of an attendant term. The advantage of this practice is that it gives the power of defeating the claims of strangers upon the inheritance, by setting up the term as prior in creation, and therefore in right. The right to take advantage of such terms is limited by courts of equity to such incumbrances as the owner of the inheritance had no notice of at the time when he acquired it; otherwise it is obvious that great injustice might be occasioned by the use of them. A term of years attendant on the inheritance is governed by the same rules as the inheritance itself is subject to. The right to it does not go to executors, but follows the devolution of the inheritance. It will not be forfeited as a chattel by the felony of the owner of the inheritance; but if the inheritance escheat, the term will follow it. (3 *Cha. Rep.*, 19.) As to the assignment of attendant and outstanding terms to attend the inheritance, see **VENDOR AND PURCHASER**.

Terms of years are considered in law not but as chattel interests in real property, and do not descend to the heir of the person who of them, but vest in his executor or administrator of other chattel; and the principle is the same the length of the term. (Co. Litt., 9 a.)

Marriage entitles the husband to the term long to his wife, as well as to the rest of the estate. He may administer to the estate of his wife, and is entitled for his own benefit to the term, whether reduced into possession, or contingent; and in case of the husband's death, his wife, his next of kin, and not hers, are entitled to the administration. (Co. Litt., 351 a.) The husband may, during the wife's life, dispose of her chattels real, but not by will; and if he dies without issue, they will belong to the surviving wife. If the husband be an alien, he cannot acquire by purchase a right to a term of years belonging to his wife. (*Mod.* 43; *Id.* 104.)

The tenant for years is entitled to the same rights as the tenant for life (Co. Litt., 41 b.); and, for life, he is not entitled to commit waste, such as to cut down timber, building houses, opening mines, &c. (Co. Litt., 53 a.) He is also punishable for perjury, and therefore bound to keep all houses and lands on the land in good and tenantable repair. (Co. Litt., 57 a.) If a woman tenant for years contracts and marries, the husband, having acquired the term by marriage, becomes answerable for the waste. A term of years may however, like an estate for life, be granted without impeachment of waste, and the grant is construed in the same manner as a grant of both estates. When the determination of a term occurs when lands are let for 21 years, the tenant is entitled to emblements, for it was his own folly that he knew that he could not reap. But where the determination of a term depends upon an uncertain event, as the death of a particular person, the tenant will be entitled to emblements in the same manner as a tenant for life. (Co. Litt., 55 b.; 16 *Mod.* 43.)

Terms of years, being chattel interests, are not subject to crown debts while they continue in the hands of the debtor, but not in the hands of a *bona fide* purchaser for valuable consideration without notice, or before any execution awarded by the court. (Co. Litt., 171.) They are in like manner assets in the hands of the executor or administrator for the payment of simple contract debts, but not after assignment to a purchaser for valuable consideration.

Terms of years, not being estates of inheritance, may be entailed, but they may be limited to persons *in esse* successively for life, with a proviso so as to be inalienable for a life or lives in fee simple. [**SETTLEMENT.**]

Terms of years, like life estates, may be determined by becoming vested in the owner of the term by surrender to the person in remainder. [**MERGER; SURRENDER.**] But a mere *interesse termini*, not being an actual estate, cannot be surrendered, though it may be extinguished. (Cro. Jac., 619.) It was formerly deemed that one term could merge in another, but it is now held that when two terms, granted out of the same estate, the first merges in the term in reversion. (Cro. Jac., 66.) Where a term has been created to a tenant for years, the court of equity will sometimes relieve against it, so far as to make it answer the purpose of a term. (3 Swanst., 603, 608.)

TERMES. [**TERMITINA.**]

TERMINAL. We cannot say that this word is a word of mathematics to the extent to which we shall see in the very great convenience which would attend the extension of its use is sufficient justification for its use in new meanings. Term is a word of geometry, and signifying boundary or extreme, and terminal value and terminal form are so used, and signify the last and most complete value of a series, added to a certain number, makes up the equivalent of the series, which the series is deduced, or stands for a finite expression of the series, this finite expression

the terminal expression. Thus in TAYLOR'S THEO-
2 have one terminal expression in D'Alembert's
other in that of Lagrange.

is also another use of the word, which would con-
distinction much wanting words to express it: we
to what might be called *terminal language*. All

of the words infinitely small and infinitely great
RE; LIMIT] is entitled to this name; as follows:
we say, for example, that a circle is a regular
with an infinitely great number of infinitely small
he language used is that of an end arrived at, a
mation actually made: the circle is described as
r consisting of straight lines; and the language is
e (expressive of a boundary actually attained).
e meaning of this language is, or is generally held
alse: no polygon is a circle, how great soever the
; or how small soever the magnitude, of the sides.
osition which is really true, that is, over which
ke hands, whatever their notion of infinity may be,
the terminal proposition, true or false, is one to
an interminable and unlimited degree of approxi-
may be made. An inscribed regular polygon may,
ides enough, be made to coincide with the circle
any degree of nearness we please to assign: or the
ng proposition—'the area of the inscribed polygon
e made to differ from that of the circle by less than
h part of the latter'—may be made true for every
of n that can be named, however great. Terminal
ge, properly employed, may be made the means of
iation of all those truths whose announcement con-
terminable approximation: the development of
nce is the object of the article INFINITE.

MINALIA, the festival of Terminus [TERMINUS],
ated at Rome every year on the 23rd of February.
s said to have been instituted by Numa with the
in of the god himself. The festival was of a twofold

either public or private, according as it was held
v daries between the fields of private persons, or
e b ary of the Ager Romanus. In the former
persons possessing adjoining lands met with their
e and servants at the stone which divided the pro-
s adorned it with garlands and offered sacrifices, and
n which the neighbours partook was intended to
ue friendly relations existing between them. (Ovid.,
ii. 643, &c.) Dionysius states that down to his time
mans did not offer any bloody sacrifices on this
n, but only cakes and fruit. But we have the most
c statements which show that the assertion of

can only apply to the early period of the
e, and that subsequently a lamb or a sucking pig
rificed. (Dionysius, ii. 74; Plutarch, *Numa*, 16;
Rom., 15; Horatius, *Epod.*, ii. 59.) The public
alia were solemnised in a similar manner by the
people on the boundary of the Ager Romanus.
Fest., ii. 679, &c.)

tung, *Die Religion der Römer*, ii., p. 52; *Diction-*
Greek and Roman Antiquities, v. 'Terminalia.')

MINALIA (from *terminus*) is the name of a genus
its belonging to the natural order Combretaceæ.
cies of this genus consist of trees and shrubs, with
te leaves, which are usually crowded together at
ls of the branches. The flowers are destitute of
and are disposed in spikes, which are racemose and
d: in the lower part of the spikes they contain
mens and pistils, but in the upper part they con-
stamens. The limb of the calyx is campanulate,
with acute lobes. The stamens are ten in number,
d in two series, and are longer than the calyx.
ary contains two ovules, the style is acute, and the
drupaceous, containing only one seed. All the
are inhabitants of the tropical parts of Asia and
a: they are numerous, and many of them are used
cine and the arts.

angustifolia, Narrow-leaved Terminalia: the leaves
ar-lanceolate, very thin at both ends, pubescent
; the petioles are also pubescent, and have two
at their apex. This tree is a native of the East
and was formerly called Terminalia Benzoin, as it
n tapping a gum-resin very similar to benzoin, and
g the same properties. This gum exudes from
n the form of a milky juice, which, on being dried,
t light whitish substance, exceedingly friable.
rently dried it assumes the form of a white powder,

which was in great repute as a cosmetic. It has an agreea-
ble fragrance, resembling gum-benjamin, which in a great
measure depends on the benzoic acid it contains.

T. vernix, Varnish Terminalia, has linear-lanceolate
leaves, narrowed at each end, and glabrous beneath; the
petioles are also glabrous. This plant is a native of the
Moluccas, and abounds in a resinous juice, which is col-
lected by the inhabitants, and used in the natural state as
a varnish. It is also used for the same purpose in China.

T. Cutappa has obovate leaves, tapering to the base,
pubescent beneath, and glands on the under sides of the
midrib. It is originally a native of the East Indies, but
has now become naturalised in the West India Islands.
Some botanists have described the West India species as
distinct from the Asiatic, but there is no good distinctive
character. The drupaceous fruit of this tree is about
three inches long, and contains a large seed, which is
used for eating and obtaining an oil, in the same man-
ner as the almond. This tree, on account of its thick
foliage, is much planted in the tropics for the purpose of
forming avenues near houses. The bark and leaves yield
a black pigment. Indian ink is manufactured from the
juice of this tree. It yields a light durable timber, which
is much used.

T. glabrata, smooth Terminalia, very much resembles
the last, but the leaves are glabrous beneath and small.
The fruit is also of a much less size, oval, and less fur-
rowed. It is a native of the Society and Friendly Islands,
and is cultivated by the inhabitants near their huts and in
their burial-places. The wood is used in these islands for
building boats, making benches, &c., and the seeds are
eaten.

T. Bellerica, Belleric Terminalia, has glabrous, elliptic,
entire, acute, alternate leaves, and bi-glandular petioles.
It is a native of mountainous districts of the East Indies.
Its flowers are very fetid. The fruit is reputed to possess
tonic, astringent, and attenuant properties. When the
bark is wounded a gum flows out, which is insipid, resem-
bling gum-arabic.

T. Chebula is also an East Indian species, it is distin-
guished from the last by possessing opposite leaves which
are pubescent beneath. The fruit of this species is more
astringent than the last and is used for the purposes of
dyeing. A durable ink is made by mixing the salts of
iron with an infusion of the outer rind of the fruit. Both
this species and the last are subject to the attacks of
insects producing gall-nuts. These galls possess the as-
tringent principle in abundance, and are also used for
dyeing. They are called *Caducay* by the Tamuls.

The genus *Bucida* is very nearly allied to *Terminalia*,
and belongs to the same natural order. It is distinguished
from the latter genus by its urceolately-campanulate calyx,
its didymous anthers, baccate fruit, and angulated puta-
men. The most remarkable species is the *Bucida buceras*,
the ox-horn olive-tree, known in Jamaica as the black
olive, in Antigua as the French oak, and in the French
Islands as *Grignon*. It has obtuse glabrous ovato-cunei-
form leaves, and small yellowish flowers disposed in cylin-
drical spikes covered with a silky pubescence. It is a
native of the West India Islands on clayey soils near the
coast. It has obtained its name from the tendency of its
branches to shoot out into monstrous spongy excrescences
resembling in form the horns of an ox. These excrescences
resemble galls in their nature, and are probably produced
by insects puncturing the terminal bud of the branch.
This tree is remarkable in appearance for its slender
crooked branches and tufted leaves, but it attains a con-
siderable size, and its timber is valuable. The bark of this
tree contains an astringent principle which is extensively
used in tanning.

In the cultivation of species of Terminalia and Bucida
a soil composed of loam and peat should be preferred.
Cuttings strike freely when placed in a pot of sand and
covered with a hand-glass.

(Don's *Miller's Dictionary*; Burnett's *Outlines of Bot-*
tany; Bischoff, *Lehrbuch der Botanik*; Lindley, *Natural*
System.)

TE'RMINUS, a Roman deity whose worship was said
to have been introduced by king Numa Pompilius, when
he ordered the fields of the citizens to be separated from
one another, and the boundaries to be marked by stones
which were to be considered as sacred to Terminus, or as
Dionysius calls him, Ζεὺς ὅριος. (Festus, s. v. *Terminus*,

Dionysius, ii. 74.) A careful examination of the worship of this god shows that Terminus was only a surname of Jupiter, who was worshipped under this name as the guardian of boundaries. The stone pillars themselves were regarded as symbolical representations of the god himself, and hence perhaps the severe law mentioned by Festus, that whoever displaced such a pillar should, together with his oxen, be devoted to the god. In the same manner in which the boundaries between the lands of private individuals were marked, the original territory of Rome (Ager Romanus) was separated by pillars from the territory of neighbouring tribes. In the direction of Laurentum there was such a pillar (terminus) between the fifth and sixth milestones from Rome on the Laurentine road. This was the public Terminus. The god had a temple on the Capitol, and the part of the roof just above the symbolical pillar was left open. (Festus; Servius, *Ad Aen.*, ix. 418.) A story to account for this peculiarity is related by Ovid (*Fasti*, ii. 671, &c.) and others.

TERMINUS, or TERM, signifies, in sculpture and architecture, a pillar: statue, that is, either a half statue or bust, not placed upon, but incorporated with, and as it were immediately springing out of the square pillar which serves as its pedestal. If they be mere busts, figures of this kind are usually distinguished by the name of Hermae (*Ἑρμαί*); and busts which, instead of having a circular moulded base, resemble the upper part of a terminus, are called terminal busts. There are many such busts and also some termini in the Townley Collection at the British Museum; among others a double terminal bust of Bacchus and Libera; and a terminal statue of Pan, nearly a whole figure, with a deeply moulded base. The terminus or pillar part is frequently made to taper downwards, or made narrower at its base than above, which mode of diminution, the reverse of that employed for columns, was no doubt intended by way of similarity to the general outline of the human figure, whose greatest breadth is at the shoulders. It has been supposed that the earliest statues were merely terminal figures,—upright stones, erected as land-marks and boundaries, the upper end of which was rudely carved into the shape of a head, which form was afterwards retained for occasional purposes after sculpture had arrived at perfection. By modern artists the pedestal part is usually made tapering downwards or narrowest just above its base; when it is called the *guine*, from its resemblance to the scabbard of a sword.

In architectural design *Terms* are employed in lieu of Caryatides, not however as insulated pillars, but as pilasters forming a small order or attic, or a decoration to gateways, doors, &c. They frequently occur in what is called the *cinquecento* and our own Elizabethan style.

TERMINUS is also now used to signify the buildings for offices, &c., at the extremity of a railroad, whereas those erected at intervals along its course are called *stations*. The establishment of railroads has therefore given rise to a new class of structures, which from their nature and extent admit of being rendered very striking in character and design. One of the most *monumental* architectural works of the kind as yet erected, is the Terminus of the London and Birmingham Railway, in Euston-square,—a Grecian Doric propylæum (distyle in antis, on both fronts) on a large scale, the columns being about 70 feet high. The Terminus at the Birmingham end, though by the same architect (Hardwick), is in the Italian style. (For views, &c. of both structures, see Companion to the 'Almanack' for 1839.) Other termini that may be mentioned for their pretensions to architecture, are—those of the London and Southampton Railway, the one at Nine Elms, Vauxhall, the other at Southampton, both handsome buildings in the Italian style, by Tite; that at Blackwall, by the same architect, and in a similar style; and those at Liverpool, York, and Brighton. The positive necessity for some covered gallery, either colonnade or arcade, and the obvious opportunity afforded for making a spacious portal, either propylæum or gateway, a marked feature in the general design, affords more than ordinary scope to the architect. Now that railroads (*Chemins de Fer*, and *Eisenbahnen*, as the French and Germans term them) have been introduced upon the Continent, they have there also given occasion to many architectural constructions for their termini. Some designs for *Abfahrtsgebäude* (Termini) may be seen in Stüler and Strack's 'Architectonisches Album.'

TERMITINÆ, a section of Neuropterous insects, in

which Latreille includes the genera *Mantispa*, *Raphidia*, *Termes*, and *Poccus*. These genera however are usually regarded as constituting three distinct families, and should be here treated as such, commencing with the *Raphidiidae* of Leach, which contains the two first-mentioned genera. The insects of this family have the antennæ slender and composed of more than ten joints: the tarsi have from three to five joints; the wings are nearly equal in size and have numerous nervures inclosing small polygonal cells; the prothorax is long and slender.

The genus *Mantispa* is at once distinguished by peculiar structure of the anterior pair of legs, which are large, have the tibiæ broad and compressed, and are furnished beneath with spines; the joints of the tarsi are also and also furnished beneath with spines: the other four legs are distinctly five-jointed. The antennæ are short, about equal to the head in length, and the prothorax is elongated, slender, and broadest at the base. The wings, when at rest, meet over the abdomen.

The *Mantispa pagana* (Fabricius) is rather less than three-quarters of an inch in length, and of a brownish-brown colour; the wings are transparent, the upper margin have the upper margin yellow. It is found in France and Germany.

In Brazil are species closely allied to *Mantispa*, which differ in having the antennæ as long as the body, the wings are nearly horizontal; the body is depressed and terminated by two little appendices. They form the *Hoplophora* of Perty.

In the genus *Raphidia* the body is rather slender, the prothorax is long and almost cylindrical, the head is somewhat depressed, and the eyes are prominent. The antennæ are as long as the head and thorax, and composed of about thirty-seven joints. The abdomen is terminated in the female by a long ovipositor. The legs are of moderate length, and the tarsi are four-jointed.

Raphidia ophiopsis is not an uncommon insect in this country: it is rather more than one-third of an inch in length, and the expanded wings measure $\frac{3}{4}$ of an inch. The head and body are black, the antennæ and legs are yellow, and the wings are transparent.

The larva of this insect lives in the bark of trees and is said to prey upon other insects. It is exceedingly active in its motions, which are somewhat like those of a caterpillar. The body is soft, long, and slender, of a brown color, striped, and variegated with yellow; the head and prothorax are corneous and of a black colour. In the perfect insect all the parts of a perfect insect are distinct, being enveloped in a thin membrane.

Family *Termitidae*.—This family is distinguished by the following characters:—Wings with few transverse nervures folding horizontally; tarsi four-jointed; antennæ short and moniliform; body depressed.

In the genus *Termes* the head is large and rounded, besides the ordinary compound eyes, it has three occular simple eyes, situated on the upper surface; the antennæ are as long as the head and thorax, inserted in front of the head and composed of about eighteen joints. The abdomen is terminated by two small jointed appendages.

The Termites, or white ants, as they are often called, though they have little affinity with the true ants, are chiefly confined to the tropics: some few species extend into the temperate regions. Like the bees and ants, which live in society, the Termites are composed of three kinds of individuals, males, females, and neuters or workers. Their ravages in the parts of the globe are well known. They unite and compose each of an immense number of colonies, living in the ground and in trees, and often attacking wood-work of houses; in which they form innumerable galleries, all of which lead to a central point. In these galleries they avoid piercing the surface of the wood-work, and hence it appears sound when the slightest touch is sometimes sufficient to cause it to fall to pieces.

The termites sometimes erect their domiciles on the ground in the form of pyramids or cones, sometimes with a roof, and these nests are often very numerous, and resemble the huts of savages.

The larvæ nearly resemble the perfect insect, except that they possess no wings. The pupæ have rudimentary wings. The neuters differ from the males and females in possessing no wings, in having the body stouter, and much longer and provided with long jaws.

ty. They are said to defend the nests, and station themselves near the outer surface, they are the make their appearance when their habitation is : they will attack the party molesting them, and h considerable strength.

negroes and Hottentots consider these insects a elicity. They are destroyed with quick-lime, or adily with arsenic, which is thrown into their ons.

Poocidae are very small insects, having soft and bodies: the head is very large, nearly trigonal, and l with three ocelli on the upper surface. The hen folded meet at an angle above the abdo- d are sparingly provided with nervures. The an- re setaceous, and composed of about ten joints. are short, and usually two-jointed. They are ve in their motions, and live in the bark of old in dwelling-houses. Nearly forty species are ce found in this country.

MOLL. [SANNIO.]

MONDE. [DENDERMONDE.]

V. STERNA, the name of those web-footed birds which are vulgarly known as *Sea-Swal-*

us, in his last edition of the *Systema Naturee*, he genus *Sterna* between *Larus* and *Rhynchops*. r arranges the *Hirondelles de Mer* between the 's (*Larus*) and *Rhynchops*. He observes that these 'les de Mer derive their names from their exces- ng and pointed wings, their forked tail, and their gs, which give them a port and flight analogous of the Swallows. Their bill, he adds, is pointed, d, straight, without curvature or projection; uills, situated towards the base, are oblong and through; the membranes which unite their toes much notched, they therefore swim but little. in all directions, and with rapidity over the sea, loud cries and cleverly picking up from its sur- mollusks and small fishes which form their food. advance inland to lakes and rivers.



Head and foot of Tern:

me author states that the *Noddies* may be distin- from the other *Sea-Swallows*. Their tail is not

iews of Mr. Vigors, Mr. Swainson, and others, as osition of the Terns, will be found in the article

swainson makes the genus *Sterna* consist of the fol- subgenera:—*Sterna*, Linn.; *Thalassites*, Sw.; , Linn.; *Rhynchops*, Linn.; *Gavia*, Briss.

Prince of Canino places *Sterninæ*, the second sub- f his *Laridæ*, between the subfamilies *Rhynchop-* l *Larinæ*. The *Sterninæ* consist of the following

1. Linn.; *Hydrochelidon*, Boie; *Megalopterus*, .B. *Sterna Stolidæ* of authors); *Thalasseus*, Boie; *idon*, Brehm; and *Stylochelidon*, Brehm. (*Birds pe and North America*.)

2. R. Gray (*Genera of Birds*) arranges the *Ster-* the third and last subfamily of *Laridæ*, imme- after *Rhynchopinæ*, with the following genera:— *usa*, Wagl.; *Gelochelidon*, Brehm; *Thalasseus*, *Stylochelidon*, Brehm; *Gygis*, Wagl.; *Sterna*, *Sternula*, Boie; *Hydrochelidon*, Boie; *Anoüs*, *Sterna stolidæ*, of authors); *Onychoprion*, Wagl.; *ecanopus*, Wagl.

Pelecanidæ immediately follow.

raphical Distribution and Habits.—The habits of ? C., No. 1517,

the Terns, which are widely diffused over the maritime parts of the globe, are noticed in the article *LARIDÆ*. The following have occurred, some occasionally only, in Europe:—

The Caspian Tern, *Sterna Caspia* (genus *Stylochelidon*, Brehm); The Sandwich Tern, *Sterna Cantiaca* (genus *Thalasseus*, Boie); the Gull-billed Tern, *Sterna Anglica* (genus *Gelochelidon*, Brehm); the common Tern, *Sterna Hirundo* (genus *Sterna* of authors); the Roseate Tern, *Sterna Dougallii* (genus *Sterna*); the Arctic Tern, *Sterna Arctica* (genus *Sterna*); the Little Tern, *Sterna minuta* (genus *Sternula*, Boie); the Noddy, *Sterna stolidæ* (genus *Anoüs*, Leach; *Megalopterus*, Boie); the Black Tern, *Sterna nigra* (genus *Hydrochelidon*, Boie; *Viralva*, Leach); the White-winged Tern, *Sterna leucoptera* (genus *Hydrochelidon* ? Boie); and the Moustache Tern, *Sterna leucopareia* (genus *Hydrochelidon* ? Boie; *Viralva* ? Leach). Of these, the largest is the Caspian Tern.

Our limits will not allow us to give more than two ex- amples, and we select the Common Tern and the Noddy. We should premise that all the Terns of the British Islands are strictly migratory: many species visit us regularly for the purpose of breeding; but those, the Noddy for instance, whose home is far away, are seen casually and rarely.

The Common Tern.—*Description*.—Forehead, top of the head, and long feathers of the occiput, deep black; posterior part of the neck, back, and wings, bluish ash; lower parts pure white, with the exception of the breast only, which is slightly clouded with ash-colour; quills whitish ash, terminated by ashy-brown; tail white, but the two lateral feathers blackish-brown on their external barbs; bill crimson-red, often blackish towards the point; iris reddish-brown; feet red. Length 13 to 14 inches. Such is M. Temminck's description of the *adult male and female*.

The same author describes the *young of the year before the autumnal moult* as having the front, and a part of the top of the head, of a dirty white, marked towards the occiput with blackish patches; the long occipital feathers brownish-black; upper parts of tarnished bluish-ash; all these feathers bordered and terminated with whitish and irregularly spotted with brown or bright reddish; the lower parts of a dirty tarnished white; tail-feathers ash-coloured, terminated with whitish; base of the bill faded orange; iris blackish-brown; feet orange.

This is the *Pierre Garin* of the French; *Fionco* and *Rondine di Mare* of the Italians; *Meerschwalbe* and *Rothfussiger Meerschwalbe* of the Germans; *Zee-zwaluw* of the Netherlands; *Kria* of the Icelanders; *Tende*, *Tendelobe*, *Sand-Tolle*, and *Sand-Tærne* of the Norwegians; *Tærne* of the Danes; *Sea-Swallow* of the modern British; and *Y för-wennol fwyaf* and *Yscreaan* of the antient British.

Geographical Distribution, Habits, &c.—'The Common Tern,' says Mr. Gould, in his great work on *the Birds of Europe*, 'although not universally dispersed over our coasts, is nevertheless a very abundant species, being found in great numbers over the southern shores, but more sparingly over the northern, which are almost exclusively inhabited by its near ally, the Arctic Tern. It is now satisfactorily ascertained that the common Tern does not extend its range to the American continent, and that its place is there supplied by another species, to which the Prince of Musignano, now Prince of Canino, 'has given the specific appellation of *Wilsoni*, in honour of the celebrated ornithologist by whom it was first described.' The Prince however gives both *Sterna Wilsoni* and *Sterna Hirundo* as American species, in his *Birds of Europe and North America*; and M. Temminck states that individuals killed in North America differ in nothing from those of Europe. In the fourth part of his *Manuel* (1840), though he adds to the synonyms and references, quoting among the rest Mr. Gould's work, he leaves his own observation above noticed uncontradicted. 'How far,' says Mr. Gould in continuation, 'the Common Tern is distributed over the Old Continent we have not satisfactorily ascertained, but we believe its range is extended from the Arctic Circle to the Mediterranean, and even to the coasts of Africa and India, to which southern and eastern countries it is supposed to retire during our winters. The Common Tern does not confine itself entirely to the sea, but frequently resorts to inland streams, &c.; and when thus ascending our creeks and rivers these little fairies of the ocean fear-

lessly fish around our boats, nothing can be more pleasing than to observe their poise and dip. When with their scrutinizing eyes they have observed a fish sufficiently near the surface, they precipitate themselves upon it with unerring certainty, and a rapidity that is truly astonishing; this mode of capture strongly reminds us of the fissirostral tribe among the land birds, and they may indeed be truly termed the swallows of the ocean, their long and pointed wings, and small but muscular bodies, being admirably adapted for rapid and sustained flight, and affording the means by which they are enabled to traverse the surface of the deep with never-tiring wings.'

We have seen them performing their graceful evolutions so far inland as near Oxford, where they were continually dipping in the Isis for bleak, as it appeared to us, which were abundant there.

Mr. Selby states that this tern breeds upon the sand or shingle beyond high-water mark, making no artificial nest, but scraping a slight concavity for the reception of two or three eggs, which vary much in colour, the ground in some being of a deep oil-green, in others of a cream-white, or pale wood-brown, but all blotched with blackish-brown and ash-grey. 'In warm and clear weather,' says Mr. Selby in continuation, 'this bird incubates but little during the day, in such situations the influence of the sun upon the eggs being sufficient; but it sits upon them in the night, and also through the day under a less favourable state of weather. The young, when excluded, are covered with a mottled grey and white down, and are assiduously attended by the parents, and well supplied with food until able to fly and accompany them to sea. During the time of incubation the old birds display great anxiety, and are very clamorous when any one approaches their station, in flying round and frequently descending so near as to strike the hat of the intruder.'

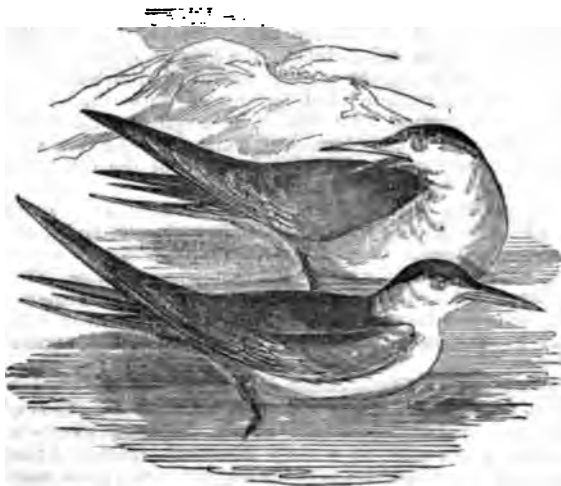

Common Tern: two adults; one in winter, the other in summer plumage. (Gould.)

The following notice respecting the Arctic Tern, from the 'Bristol Mirror' newspaper (1842), is deserving of attention. The time alluded to was that when we had very blowing weather:—'During the high winds that prevailed on Sunday last, our harbour and floating-docks were visited by large flights of a rare and beautiful species of bird, the *Sterna Arctica*, or Arctic Tern. The birds were assembled in such vast numbers, that two or three hundred were killed with stones and other missiles, whilst several were caught alive; and so tame were they, that many were observed to pitch on the backs of passers by. This tern, as its name indicates, is a native of the higher arctic regions, and has been met with in all the late expeditions to the polar seas. It is a summer visitant to the coasts of Scotland and the north of England, but is rarely met with more southerly, and until the present there was no instance on record of a specimen having been obtained in this neighbourhood. The appearance of such vast flights of arctic birds, rare as a species, in the very heart of a large city, is an occurrence as remarkable as it is interesting. Flocks of these birds were also observed the same day at Clevedon, Weston, and other places along the Channel Coast.'

The Tern was formerly considered choice food. Thus, in the 'Household-book of the Earl of Northumberland' we find 'Ternes' among the delicacies for principal feasts of his lordship's own 'mees'; and they are charged at four pence a dozen.

The Noddy.—*Description.*—In this form of tern the wings reach beyond the rounded tail. Forehead white, passing into grey-ash towards the top of the head, and into a deeper grey at the occiput, in front of the eyes a deep black patch; throat and cheeks grey-brown; all the upper and lower plumage chocolate or sooty-brown. Bill and feet black. (*Summer or nuptial dress.*) Length about a foot.

Geographical Distribution and Habits.—America principally, where its head-quarters appear to be the Gulf of Mexico, the coasts of Florida, and the Bahama Islands. Dr. Latham was told that they breed in great numbers on certain small rocky islands near St. Helena. Mr. Audubon observed numbers collected from the American coasts above mentioned in 1832, on one of the Tortugas, called, from the flocks that visit it, Noddy Key.

Mr. Gould remarks that the noddy, unlike the generality of terns, builds in bushes on low trees, making a large nest of twigs and dry grass, while hovering over or near which the old birds utter a low querulous murmur: the eggs, three in number, are reddish-yellow, with dull red and purple patches and spots, and the young are said to be very good eating. It does not take its prey like the other terns, but as it skims along the water; and, when full grown, seeks its food at much greater distances from the land than the rest of the group.

Two were shot off Wexford in Ireland in 1830. Temminck states that it has been seen in France, but he had never seen it on the coasts of Holland.



Noddy.

Mr. Nuttall gives a lively description of its habits.

'Familiar to mariners who navigate in the equatorial regions, the noddy, like the voyager, frequents the seas to the distance of some hundreds of leagues from land, and with many other birds of similar appetitious propensities, they are seen in great flights, assiduously following the shoals of their finny prey. They pursue by flying near the surface of the water, and may not be seen continually dropping on the small fish, which approach the surface to shun the persecution of the kinds, by which they are also harassed. A rippling silvery whiteness in the water marks the course of timid and tumultuous shoals; and the whole air re-echoes with the clangor of these gluttonous and greedy birds, who, exulting or contending for success, fill the air with their varied but discordant cries. Where the strongest rippling appears, there the thickest swarm of noddies and sea-fowl are uniformly assembled. They frequently board of ships at sea, and are so stupid or indolent on such occasions, as to suffer themselves to be taken on hand from the yards on which they settle: they are however, when seized, bite and scratch with great violence, leading one to imagine that they are deluded or misled from flight by excessive fatigue or hunger. It is imagined that the appearance of the noddy at sea in the proximity of land; but in the manner of the common tern, they adventure out to sea, and, like the latter, themselves, the shelter of whose friendly wings they often voyage at random for several days at a time, committing themselves to the mercy of the bill.'

g at certain seasons no predilection for places, climate suits, the roving flocks or stragglers find home on every coast, shoal, or island.' (*Manual nology*.)

sel however is not always friendly. Bligh found a seasonable supply to himself and his famished celebrated boat-voyage after the mutiny of the *Bligh*; and Byron has improved the incident into a noble scene after the shipwreck in 'Don Juan.' ol. v., p. 159.]

TE, an island in the Indian Archipelago, is by 50' N. lat. and 127° 20' E. long. It is 10 and from four to five miles wide. It derives its name from the circumstance that its sovereign is in possession of a considerable portion of the islands of Celebes; and on this account the Dutch have expedient to form a considerable establishment at Fort Orange. The northern group of the islands has been called the Ternate Islands, though this only one of the smaller ones which belong to the group of which are of great extent, especially

the western part of the island appears to be occupied by a volcano, which, according to Valentyn, attains an elevation of 367 fathoms and 2 feet, or 4095 feet English, above sea-level. The remainder of the island is very fertile and affords rice and the other productions of the Indian Archipelago: but we have very little information respecting the points, as the Dutch have always excluded the natives and prevent the natives from trading with the neighboring islands, lest the spices which grow on this island should be brought to the neighboring islands by any other channel than their own command although the English have been twice in possession of the Dutch settlement, their attention has been directed to the great Dutch colonies than to this very small establishment. We learn only from the accounts of the inhabitants of the Sooloo Archipelago that they traded with Ternate, and that they imported quantities of different articles of Chinese ware, which they exchanged for rice, edible birds'-nest, sharks' fins, tortoise-shells, and small pearls: they obtained also a great number of lories.

The inhabitants are Malays, who have embraced Islam. There are three mosques. The king, who possesses also a portion of Gilolo, and the north-eastern limb of the island where the Dutch have two settlements at Manado and Malu, and several of the adjacent islands, lives in Ternate. These countries however are governed by chiefs, who in many respects resemble the feudal lords of the middle ages: but the king and the chiefs are dependent on the Dutch governor of Amboyna, of which Ternate forms a regency.

Ternate was first visited by the Portuguese in 1521, and afterwards they formed a settlement, which passed into the hands of the Dutch in 1606; who, in 1680, declared the king to a state of dependence on them, and their establishment. In 1797 it was taken, together with Amboyna, by the English, who restored it at the Treaty of 1801: it was again taken in 1810, and again given up by the treaty of Paris in 1814.

See *Voyage to New Guinea and the Moluccas*, G. Forster's *Voyages to the East Indies*; Von Schlegel's *Beschreibung der Canarischen Inseln*.

[SPOL.ETO.]

TRÔMIA'CEÆ, a natural order of plants belonging to the Calycose group of polypetalous Dicotyledons, at present constituted, by Cambessedes, who is followed by Lindley, this order consists of trees or shrubs with coriaceous leaves, without stipules, mostly simple and sometimes with pellucid dots. The flowers are generally white in colour, sometimes pink or red, and are arranged in axillary or terminal peduncles, at the base. The calyx is composed of 5 or 6 imbricated in aestivation, the innermost the outermost 5, 6, or 9, often combined at the base; stamens finite with monadelphous or polyadelphous and versatile or adnate anthers; ovary superior; 1-celled; seeds few, attached to a central axis, without albumen, and a straight embryo, the cotyledons of which are very large, and often filled with oil. This order includes the Theaceæ of Mirbel and the

Camelliæ of De Candolle. Their closest affinity is with the order Guttiferae, from which they differ in their alternate leaves; in the parts of their flowers being 5 and its multiples; in the calyx being distinct from the corolla; in their twisted aestivation, and in their thin inadherent cotyledons. They have also relations with Hypericaceæ and Marcgraaviaceæ. The plants of this order are principally inhabitants of Asia and America; one species only is a native of Africa.

This order includes the genus *Thea*, and hence is one of great oeconomic importance. [*THEA*.] It is supposed that the dried leaves brought to this country under the name of tea are not alone the produce of the genus *Thea*, but that the leaves of some species of *Camellia* are also mixed with them. [*CAMELLIA*.] Independent of these two genera, little is known of the properties of this order. The *Cochlospermum insignis* is used as a medicine in internal bruises in Brazil, where it is called *Butua do curvo*. The *C. tinctorium* yields a yellow dye; and the seeds of *C. Gossypium* yield a gum resembling *Tragacanth*, for which it is substituted.



Thea Boba.

1, branch with flowers and leaves; 2, superior ovary with trid stigmata; 3, fruit entire; 4, capsule dehiscent.

TERPANDER (*Τέρπανδρος*), the earliest and the most important historical personage in the history of Greek music and its connection with poetry, for he was both a musician and a poet. He was a native of Antissa, in the island of Lesbos, and his best period falls in the latter half of the seventh century before Christ. There are few events in his life that can be chronologically established. In B.C. 676, at the first celebration of the musical contests during the festival of the Carneia near Sparta, Terpander was crowned as victor. (Athenæus, xiv., p. 635.) He afterwards gained four successive prizes in the musical contests at the Pythian games (Plutarch, *De Musica*, 4); and these victories probably fall between the years 672 and 645 B.C., since in the latter of these years he was at Sparta, and there introduced his nomos (*νόμοι*) for singing to the accompaniment of the cithara, and was engaged in reducing the music of the Greeks, such as it then was, to a regular system. (*Marmor. Parium*, Epoch. 34; Plutarch, *De Mus.*, 9.) At this time his fame must have reached its height. His descendants, or at least the musicians of his school (*καθημεροί*), continued for more than a century to obtain the prize at the Carneia every year without any interruption.

Numerous musical inventions are said to have been made by Terpander; many of them however may have been made by other persons, especially such as belonged to his school, and were subsequently ascribed to the father and founder of the art. Of many of his inventions we are unable to form any clear idea. The most important among them however is the seven-stringed cithara (*heptachord*).

Previous to his time songs, hymns, and rhapsodies had been accompanied with a cithara of only four strings (tetrachord), to which Terpander added three new strings, so as to make the cithara comprise a full octave, or, as the Greeks called it, a diapason. The heptachord soon came into general use, and remained the favourite instrument of the Greeks, especially the Dorians, notwithstanding the various alterations and improvements that were made. Another very important improvement which the antients unanimously assign to Terpander, is the reduction of the antient melodies to certain systems (*vôpos*), which continued unaltered for several centuries. These nomes appear to have been of a twofold character: he either invented them himself, or he merely fixed those which had been used before his time. This fixing of certain tunes and melodies he is said to have effected by marks or notes which he made over the verses of a poem. In this manner he marked the tunes of his own poems, as well as of portions of the Homeric rhapsodies. His own poetical compositions, which, with the exceptions of a few fragments, are now lost, consisted of hymns, proemia, and scolia.

(Müller, *History of the Literature of Antient Greece*, i., p. 149, &c.; Bode, *Geschichte der Lyrische Dichtkunst der Hellenen*, ii., p. 363, &c.)

TERPSICHOIRE. [MUSES.]

TERRA DI LAVO'RO. [LAVORO, TERRA DI.]

TERRACINA, a town of the Papal State, in the administrative province of Frosinone, near the borders of the kingdom of Naples, and on the high road from Rome to Naples. The old town, which is built on the site of the antient Anxur, rises in the form of an amphitheatre on the slope of a calcareous rock which is a projection of the ridge called Monti Lepini, leaving but a narrow strip of land between it and the sea, along which runs the high road to Naples in the track of the antient Via Appia. Along the road are the modern buildings of Terracina, constructed by Pius VI., and consisting of the post-house and inns, custom-house, granaries, and other structures for public use. The old harbour, which was restored by the emperor Antoninus, has been long since filled up, but remains of the mole are still seen. The old town is an assemblage of poor-looking houses, perched one above another, surrounded and overtopped by white cliffs which are seen from afar (Horace, *Sat.* i. 5), and intermixed with myrtle, orange, and palm trees, and with plants of aloes and cactus. Above all rise the cathedral with its lofty steeple, an elegant palace built by Pius VI., the remains of the palace called that of Theodoric, which is a structure of the fifth century of our æra, and is situated on the summit of the hill, and about 600 feet above the sea, and an old castle raised in the middle ages. The cathedral is ornamented with some fine fluted Corinthian columns, which have been taken from a temple of Jupiter now ruined. Remains of a theatre are also seen. The climate of Terracina is very mild and genial in winter, but is unwholesome in summer.

The population of the town is 4000 inhabitants. Terracina is 56 miles south-east of Rome and 59 miles north-west of Naples. Beyond Terracina, on the side towards Naples, is a detached rock of a pyramidal form, nearly 200 feet high, one side of which was cut perpendicularly by C. Appius to make room for his road. About two miles farther is the frontier of Rome and Naples, where a military post is kept by each respective state. (Tournon, *Etudes Statistiques sur Rome*; Valéry, *Voyages en Italie*; Calindri, *Saggio Statistico dello Stato Pontificio*.)

Anxur was a thriving town of the Volsci long before the Roman conquest, was taken by the Romans in the year 403 B.C., was retaken by surprise in 399, and taken again by the Romans three years after. It afterwards became a Roman colony by the name of Tarracina. During the second Punic war the temple of Jupiter at Tarracina is mentioned by Livy as having been struck by lightning. (Livy, iv. 59; v. 10-13; xxviii. 11.)

TERRANOVA. [SICILY.]

TERRAPE'NE. [TORTOISES.]

TERRASSON, JEAN, a French writer of the last century. He was born at Lyon, A.D. 1670: his father was Pierre Terrasson, one of a family of considerable eminence and activity in that city, and a man whose devout temper led him to make all his four sons (of whom Jean was the eldest) members of the Congregation of the Oratory. They were all at Paris in the house of that Society when their father died: the three younger remained members of

the Congregation, but Jean (now a sub-deacon) whose position disinclined him to the life of an ecclesiastic, quitted the Society, not however without having acquired considerable acquaintance with theology. The simplicity of character which ever distinguished him rendered him the dupe of men, by whom his small patrimony was soon wasted; but he found a shelter in the house of a friend, M. Rémond, to whose son he became tutor. He subsequently (A.D. 1714) undertook the education of the son of his cousin Mathieu Terrasson, a celebrated advocate in the parliament of Paris. He had become an associate of the Académie Royale des Sciences, A.D. 1707. In 1715 he made his first appearance as an author by taking part in the dispute then raging on the value of the Homeric Poems, and the comparative merits of the antients and moderns. His work was entitled 'Dissertation Critique sur l'Épique d'Homère,' 2 vols. 12mo., Paris: it met with a favourable reception from those who joined in or approved of the attacks then made on Homer, who was severely criticised. Next year Terrasson published an addition to his dissertation on Homer, in 12mo., in reply to André Dacier, by whom he had been attacked. In A.D. 1719 the financial system of Law enabled Terrasson to obtain a large fortune, and induced him to form an establishment and set up his carriage: but wealth was to him rather a source of embarrassment than of pleasure; and when he lost his fortune the next year in the financial change which took place, he contentedly observed that it would be more convenient to him to live a little. In A.D. 1720 he published a small work in defence of Law's financial schemes, entitled 'Trois Lettres sur le Nouveau Système des Finances,' 56 pp., 4to., Paris, and another small work in defence of the French India Company. He saved some small part of his fortune from the general wreck; and this, with the income of a professorship, which he obtained next year (A.D. 1721) in the Collège Royal, and a pension subsequently conferred by the crown, rendered his circumstances easy for the rest of his life. He became a member of the Académie Française A.D. 1732.

In 1731 Terrasson published a romance in imitation of the 'Telemaque' of Fénelon. It was entitled 'Sémis,' 3 vols. 12mo., Paris, and professed to be a translation of a Greek manuscript. The scene is laid chiefly in Egypt. This work obtained sufficient circulation to go through several editions, of which the last was in 1813, in 6 vols. 18mo., but never became popular. An English translation was published in London in 1732. In the year 1737-44 he published the seven successive volumes of a 12mo. of a translation of Diodorus Siculus. This translation has been reprinted once or twice, but is very rare. This was his last work of any extent. His mind and his bodily strength gradually failed, and he died A.D. 1750, aged 80.

He wrote also a treatise entitled 'De l'Infini' (1744) which he allowed one or two transcripts to be taken during his life; but it was never published, nor was the manuscript found among his papers at his decease. He left also a small work, published after his decease, 'La Philosophie applicable à tous les Objets de l'Étude de la Raison' (Paris, 8vo., 1754).

From an anonymous letter printed, with one or other pieces, at the commencement of this small volume and containing a biographical notice of Terrasson, we derived the substance of this article. See also the *Terrasson*, by D'Alembert; Quéraud, *La France Littéraire Universelle*.

TERRESTRIAL MAGNETISM. This term is used to denote the action of the magnetic fluid in or upon the earth; the effects of that action being manifested in various phenomena presented by magnetized needles or wires.

The general polarity of a magnetized needle when supported or suspended in a balanced state, and in relation to the horizon, with the slow variations to which it is subjected, as well as the intensity of the magnetic force, are phenomena which are conceived to be caused by causes existing in the earth and pervading its whole surface, while the temporary effects, as the diurnal variations of the needle, are supposed to depend upon electrical currents produced by variations of temperature at different distances from the horizon, and perhaps from other causes: finally, great temporary discharges of electricity in the upper regions of the atmosphere may be

those occasional agitations in the needle, to which the effect of magnetic storms has been lately applied, and which are now known to extend at the same moment over a great portion of the earth's surface.

The declination (variation) of the needle is that elemental magnetism which was first observed, and the effect of its amount in different regions, as well as the change at the same station, was early noticed. Dr. Halley, on his return to England after his second voyage, which he had made many observations on the various different parts of the Atlantic and Pacific oceans, in 1701, a chart, on which were traced what have since been called *isogonical lines*, that is, lines passing through the points on the earth's surface where the variation is zero; and other charts of a like kind have since at various times been constructed. The expectation at first was, that such a chart might serve as a means of determining the longitude of a ship at sea by an observed variation of the needle has not however been fulfilled, yet no formula has been discovered by which the variation at any given time and place may with sufficient accuracy be found: but though the changes of the variation hitherto rendered such charts of little use for the purposes of navigation, yet a knowledge of the form of the

lines of equal variation at different periods may be of great importance as a step to the discovery of the law of those changes. The latest variation chart is one which was published by Adolf Erman, after his journey, in company with Hansteen and Due, through the whole length of the Russian empire, and his return to Europe by sea. Erman determined the positions of the isogonical lines from his own observations, and from the most authentic of those which had been made by other observers between the years 1827 and 1830; and subjoined is a representation of the principal lines on the two hemispheres of the earth, projected stereographically on the plane of the equator. The lines marked *o o* pass through places where the variation is zero; the positive sign before a number indicates that the variation is westward, or that the needle deviates to the west of the astronomical meridian; and the negative sign indicates that the variation is eastward. On an inspection of the lines, it is manifest that on a sphere they must be curves of double curvature with bends in opposite directions; that most of them converge towards two points on the earth's surface, one in or near Baffin's Bay, and the other to the southward of New Holland; and that between the inflexions there are some which return into themselves.

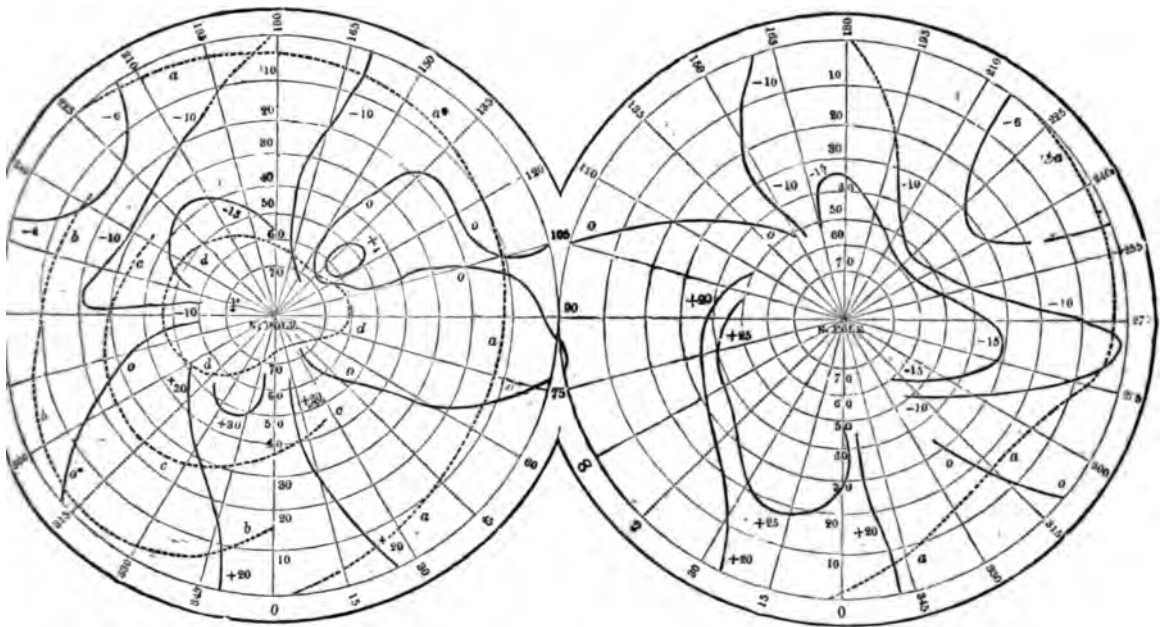

The dip, or inclination of the needle to the horizon, which is another element of terrestrial magnetism, was first recorded by Robert Norman [INCLINATION], and numerous observations have been made to ascertain its value in different parts of the world, together with the variations to which it is subject in process of time; but a general chart exhibiting the forms of the isoclinical lines, as those of equal dip are called, is still wanting. On the above cut are represented by dotted curves some of the lines which are best known; and these have been taken chiefly from a partial chart given by Major (now Colonel) Sabine, in the 'Philosophical Transactions' for 1840. The data are stated to have been obtained from above 140 observations made on land between 1834 and 1839, and from many others were made at sea by Mr. Dunlop in 1831, and by Mr. Sullivan in 1839. Some points have also been taken from the observations made by Erman in the Pacific Ocean, of which last observations a table is given in the 'Fifth Report of the British Association' (vol. vi.).

The line *a, a*, represents the line of no dip, which is evidently a curve of double curvature, and crosses the terrestrial meridian in two points at least: *b, b, b*, is the known portion of the isoclinical line for a dip of 30 degrees below the horizontal part of the horizon: *c, c*, is the line for 60°; and *d, d*, the line for 75°.

An inspection of the cut will show that the oval lines of equal dip go on diminishing in magnitude northwards, and finally terminate at the pole of the dip, or place where that element is a maxi-

mum, may be fixed at a point (*P* in the diagram) in long. 263° (117° west), and in lat. 70° N.: at that place, by the observations of Captain James Ross, the dip in 1831 was found to be 89° 59'. Professor Hansteen, of Christiania, has deduced, from the observations which have been made in the polar regions, that the isogonical lines in the northern hemisphere tend to two points in the vicinity of the pole of the dip; those which are on the north side uniting in a point a little way to the north of the latter pole, and those on the south side a little way to the south of the same pole.

Till within the last fifty years it was the general opinion that the intensity of terrestrial magnetism was the same at all parts of the earth's surface; and to the Académie des Sciences, in France, is due the honour of having been the first learned body which proposed that observations should be made for the purpose of determining that element. In the instructions which its members drew up for the use of the unfortunate La Perouse, it was recommended that the intensity should be observed at places very distant from one another, in order to ascertain whether or not any differences existed in its value. The accounts of any observations which may have been made during the voyage perished; but between the years 1791 and 1794, M. Rossel, who sailed from France with the expedition in search of La Perouse, determined with a dipping-needle the inclination to the horizon, and the times of performing a vibration, at different places; and from the latter the fact of a difference

of intensity was established. After that time extensive series of observations on the dip and intensity were made by Humboldt in South America, and in France, Italy, and Germany; by Hansteen, Duc, and Erman in the north of Europe and in Siberia, and by the last-mentioned gentleman in the Pacific Ocean. Also by Colonel Sabine during his voyages to the polar seas and the equatorial regions of Africa and America; by the Russian admiral Lütke, in a circumnavigation of the globe; and by captains King and Fitzroy in the survey of the coasts of South America; and now, no observations on terrestrial magnetism are considered complete unless all the three elements, the declination, the inclination, and the intensity, are determined at the same time at every station.

Previously to the time when Humboldt made his magnetical observations in South America, the opinion that the intensity was a minimum at places where the dip of the needle was zero prevailed; and that philosopher, in consequence, assumed unity as the measure of the intensity at a certain station in Peru, where the dipping-needle assumed a horizontal position. From the times in which a certain number of vibrations were made by such needle at that station, and subsequently at Paris, Humboldt found that the intensity at the latter place was equal to 1.3842 (that in Peru being unity); and M. Arago and Col. Sabine afterwards, by a comparison of experiments made by themselves, ascertained that the intensity in London was (in 1827) expressed by 1.372. The scale of intensity which had been assumed by Humboldt continues to be used, though it is now known that the zero of dip does not

correspond to the minimum of intensity, and it became necessary to employ terms less than unity to express intensity at many places within and even beyond the tropics. The intensity is subject to a secular variation, but of the amount and the law of that variation, no certain knowledge has been obtained.

In the subjoined cut (No. 2), which, like the first, is a stereographical projection of the northern and southern hemispheres of the earth, are represented the isodynamical lines (lines of equal intensity) from the chart given by Col. Sabine in the 'Seventh Report of the British Association.' That chart was formed from the authenticated experiments on the intensity of magnetism which have been made between the years 1798 and 1834; and in order to avoid confusion, there are given in this cut, in order to avoid confusion, there are given five lines corresponding to the intensity represented by 1.4, 1.6, 1.7, and the points at which the intensity is to be 1.8, which is the highest as yet observed. The tract between the curve lines marked 1.4 and 1.5 is a band of low intensity: the breadth of this band is very unequal; at points in long. 110° and 120° the lines approach within 3 or 4 degrees of each other, while near the meridian of Greenwich they are separated by an interval of about 50 degrees. In this band of low intensity which surrounds the South American pole, it may be expected that the intensity should be the lowest; in fact, M. Erman, in his return to Europe, observed a few degrees westward of St. Helena, that the intensity was 0.743, which is the lowest yet obtained from any observation.

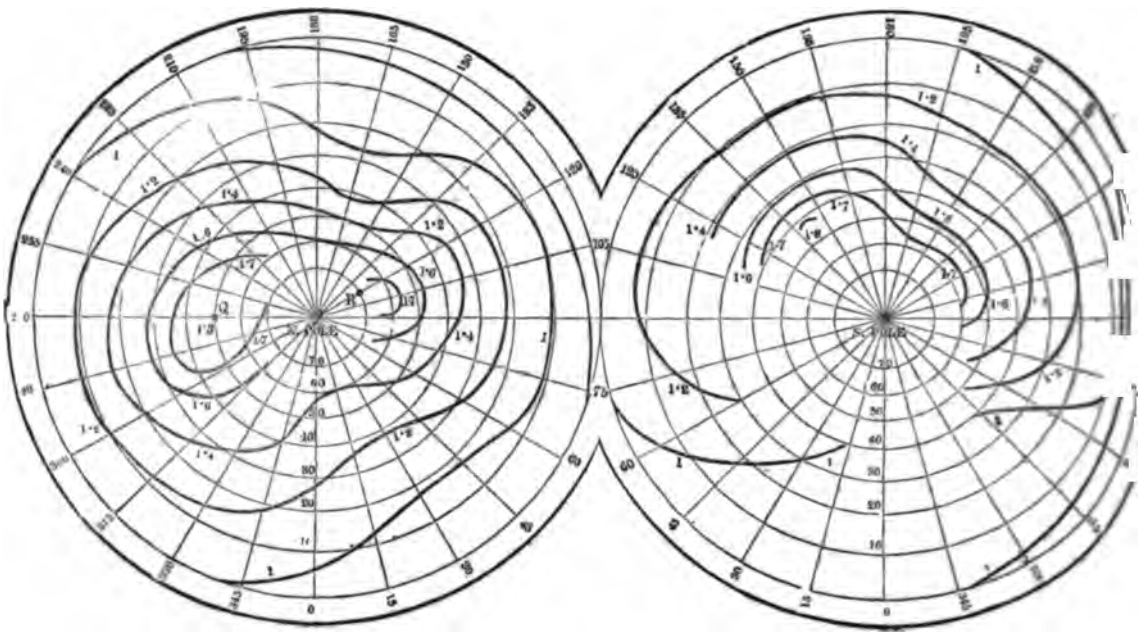

Some of the isodynamic lines in both hemispheres are incomplete, because observations are still wanting at places through which the lines are supposed to pass, but no doubt can exist that all of them are curves which return into themselves. A simple inspection will show that in each hemisphere they constitute a system with two loops, or with two polar points: in the northern hemisphere, judging only by the forms, it may be perceived that the western pole, or point of maximum intensity, must be at a spot whose longitude is about 270° (90° W.), and latitude about 50°; that is, near Hudson's Bay. The eastern, or Siberian pole, appears to be in longitude 120°: its latitude is uncertain, but probably about 70°. The eye will readily detect also, that in the southern hemisphere the curves, as they are more distant from the equator, assume more perceptibly the form of loops about two points as poles whose positions are, by estimation, in long. 140°, lat. 60°, and in long. 240° (= 120° W.), lat. 60°; the former being to the south of New Holland, and the latter in the southern part of the Pacific Ocean. The nearest distance in longitude between the intensity-poles about Hudson's Bay and to the south of New Holland is about 130 degrees; and

the nearest distance in longitude between the South American pole is about 120 degrees. The distances in latitude are about 110° and about 120° respectively, so that those poles are not diametrically opposite to one another.

The intensity of magnetism at the New Holland pole appears to be nearly equal to that which has been observed at the North American pole, the observed intensity at Van Diemen's Land and at New York being 1.76; the intensity at the Siberian pole is nearly equal to that at the South Pacific pole, the observed intensity at the South American pole being 1.76, and the highest at present observed in the South Pacific being 1.7. The fact that these intensities are less than the former is indicated by the curves about them being smaller than those about the two poles; and Erman thinks it probable that the intensity of magnetic attraction, where the intensity is less, is at a less depth below the surface of the earth, so that the loops contain greater areas.

Since there exists one pole of stronger and one of weaker intensity in each of the hemispheres on the Earth, south of the terrestrial equator, it may be

ed by Col. Sabine, that the quantities of magnetism in two hemispheres are nearly equal; but as all the poles lie in one hemisphere of the earth, which would mediate if the latter were cut by the plane of a meridian through points whose longitudes are 100° and 280° it must follow that the hemisphere which contains the poles, that is, the hemisphere which contains the Atlantic and the Pacific Ocean, must have a greater quantity than the other.

Dynamic lines present the appearance of double arcs like those of equal dip; and in both systems of lines there is a like tendency to form two foci, or centres of attraction; and the bends gradually become more marked as the lines approach the equatorial line of the earth, but it is obvious that the lines in the northern hemisphere are far from being parallel to one another: in the southern hemisphere the isodynamical line 1 crosses the equator no dip in two places at least; and each of the lines *bb. cc. dd.* in No. 1, would pass through several isodynamical lines in No. 2. Even within the limits of the deviations of the two systems of lines the differences of intensity are very sensible ('Memoir,' by Major Sabine in the *Eighth Report of the British Association*); and it is inferred that, at least in the northern hemisphere, the pole of maximum intensity is quite distinct from the pole of the dip, the distance between them in latitude being probably as much as 20 degrees. Q and R in the figure are the presumed places of the two intensity-poles in the northern hemisphere. It is at present quite uncertain whether or not there is a corresponding difference in the southern hemisphere, but the circumstance is deduced from the fact that the highest observed intensity is both equal at places (New York and Van Diemen's Land) where the dips are also equal, and where they are the greatest.

Hansteen, in his treatise on the magnetism of the earth (1819), has shown, from a comparison of the observations of the four poles of the dip at different times, that each of them has a slow movement about the axis of rotation. Not much dependence can be placed on the observations of the periods of the revolutions, but M. Hansteen has shown that of the North American pole 1890 years, and that of the Siberian pole 860 years.

The existence of two magnetic poles in each hemisphere is evident, and Gauss of Göttingen observes that there is also a third point between each pair, which is the character of both, and therefore is a true pole. In his *Theory of Terrestrial Magnetism*, translated into English in the *Scientific Memoirs*, pt. vi.) This is indeed obvious if a dipping-needle were carried from one pole to the other, it would begin to deviate from the vertical direction towards the pole it had quitted; and, near the other, it would be found to deviate from the vertical towards the pole which it was approaching; these deviations are in opposite directions, there is an intermediate point at which the needle would be in a vertical position.

Just as soon as a few observations on the phenomena of terrestrial magnetism were collected, Dr. Halley (1701) conceived a theory in order to account for them. He supposed that the earth itself might be a shell, containing a globe which revolved with it about the same axis of gravity and the same axis; the outer globe, or shell, being supposed to perform its rotation in twenty-four hours and the other in a time rather greater or less. Each globe was supposed to have a magnetic axis passing through its own centre, but the two axes were supposed to be parallel to each other and to that of the diurnal rotation; consequently there were supposed to be, in all, four magnetic poles.

The deviation of these magnetic axes from that of the earth's rotation was supposed to be the cause of the variation (declination) of the compass-needle, and the slow deviation of the magnetic axes from each other was supposed to be the cause of that continual variation of declination which is observed at every place on the earth's surface. The theory is highly ingenious, and resembles that of the epicycles, by which, in the infancy of astronomy, it was attempted to account for the variations in the movements of the planets: but when observations were applied, and the variations of the needle at constant intervals of time were compared together, it was

found to be incapable of representing the phenomena; and Mayer, of Göttingen, without gaining any advantage, modified the hypothesis by assuming that the centre of the small magnet was placed at a certain distance from that of the earth.

Subsequently (1805) M. Biot, assuming that there were two points in a supposed magnetic axis of the earth, by one of which the magnetized needle was attracted and by the other repelled, investigated a formula for expressing the dip and variation in terms of an indeterminate distance between those points. On comparing the result obtained by computation from the formula with the observed phenomena, he found that the latter were represented with tolerable accuracy when the points of attraction and repulsion were infinitely near to each other and to the centre of the earth. From the result of the investigation it follows that if a plane, supposed to pass through the centre of the earth perpendicularly to the magnetic axis, were considered as a magnetic equator, the tangent of the dip of the needle would be equal to twice the tangent of the magnetic latitude of the place on the earth's surface; and a like conclusion had been previously arrived at by Professor Kraft at St. Petersburg, from such observations as then existed. It is here supposed that the curve of no dip is the circumference of a great circle or of the sphere, and we have seen that this is far from being conformable to observation, yet the rule just mentioned may be advantageously employed when it is required, from any observed dips of small magnitude, to determine the situation of a point on the earth's surface where the dip is zero. The last attempt to account for the phenomena of terrestrial magnetism in this manner was made by M. Hansteen (1811), who assumed the existence of two small magnets of unequal strength at certain distances from the centre of the earth. He compared the results, with respect to variation, dip, and intensity, which he obtained by computation from that assumption, with the values of those elements observed at different places; and though, to a certain extent, the agreement was satisfactory, yet in several instances the differences were such as to show that the hypothesis was erroneous or incomplete. Professor Gauss of Göttingen, in his *Treatise on the General Theory of Terrestrial Magnetism* above quoted, has investigated the elements independently of all hypotheses concerning the distribution of the magnetic fluids in the earth, and assuming only that the terrestrial force is the collective action of all the magnetized particles in the earth's mass, he has exhibited the resulting formulæ in converging series; and has given, for ninety-one places on the globe, a table of the values of the declination and inclination of the needle, and of the intensity of magnetism, computed from his expressions for the horizontal and vertical components of the force, together with the observed elements at the same places; and the smallness of the differences between these last and the computed elements are satisfactory proofs of the correctness of the theory. For a supposed connection between the temperature of the earth's surface and terrestrial magnetism, see ISOTHERMAL LINES.

The want of complete success which has hitherto attended the different attempts to exhibit the laws of magnetical phenomena make it evident that the time has not yet arrived in which that can be done with respect to magnetism which Newton accomplished with respect to gravitation. But though the hypotheses formed, in order to account for the phenomena of terrestrial magnetism, have not brought out formulæ which will entirely satisfy the observed elements, it must not be understood that they are therefore without utility; since the approximative rules which have been obtained from them afford the means of computing small differences in the elements with sufficient accuracy to allow observations made at times or in places not very distant from one another to be reduced to what they would have been had they been made at one time or station; and thus several observations may be made to concur in the determination of a correct mean value of the element. This remark may be considered as applicable to most of the hypotheses which, in the physical sciences, have been proposed for the purpose of exhibiting the laws of the phenomena; and it may be further remarked, that the assumption of an hypothesis, by indicating the fittest place for observing, or the nature of the observations which are requisite for verifying it, is

advantageous in leading the observer to select his stations or to vary the construction of his instruments, so as to put himself in the most favourable circumstances for determining the laws from observation.

In the year 1818 M. Arago, at the Observatory of Paris, made a series of observations on the irregular changes to which the declination of the needle is subject; and M. Kupffer having about the same time made similar observations at Kasan, a comparison of the results led to the discovery that the perturbations were simultaneous at those places, though they differed in longitude above 47 degrees. This remarkable circumstance immediately attracted the notice of philosophers, and a plan for making simultaneous observations in many different places was organized by M. de Humboldt in 1827. For this purpose magnetic stations were established at Berlin and Freyberg; and the Imperial Academy of Russia, entering with zeal into the project, caused a chain of stations to be extended from St. Petersburg to Pekin, at all which places simultaneous observations were appointed to be made seven times in the year, at intervals of one hour, during twenty-four hours.

In 1834 Professor Gauss discovered the fact that the synchronism of the perturbations was not confined to the declination of the needle, but that every deviation at one place of observation had its counterpart at another; and he was therefore induced to recommend a plan of simultaneous observations at intervals of five minutes during twenty-four hours, four times in the year. This suggestion was immediately adopted, and on the Continent magnetic stations were formed at more than twenty cities of Europe, from Dublin to St. Petersburg. The British Government and the East India Company also, besides the principal observatories of the former at Greenwich and Dublin, immediately sanctioned the formation of magnetic stations, under the direction of scientific officers, at St. Helena and the Cape of Good Hope, in Canada, the East Indies, and New South Wales; and in the present expedition to the antarctic regions under Captain J. C. Ross, one of the leading objects is the determination of the magnetic elements in that remote part of the world. The system of simultaneous observations at numerous and stated times of the year, which has been organized in Europe, is to be conformed to by all the British observers; and the Royal Society of London has caused an able Report of the objects of scientific inquiry in physics to be drawn up for the use of travellers in general, and particularly for the persons who have been appointed to take part in the observations respecting magnetism and meteorology.

The instruments employed for determining the elements of terrestrial magnetism, and the variations to which they are subject, are of three kinds: the declination magnetometer; and the horizontal and vertical force magnetometers. The first is a needle or bar, from twelve to fifteen inches in length, nearly one inch broad, and a quarter of an inch thick, suspended in a horizontal position in a stirrup by untwisted silk fibres about two feet long. The apparatus is contained in a box, to protect it from the agitation of the air, with two apertures in opposite positions; one of these is for illuminating the scale, and the other is used for the readings, which are taken by means of a telescope at a distance. For a description of such an instrument and its adjustments, see Taylor's 'Scientific Memoirs,' part v. By this instrument may be observed the absolute declination, or the angle which the axis of the needle makes with the astronomical meridian of the place, the variations of the declination, and the horizontal component of the earth's magnetic force. The latter is found by experiments of deflection and experiments of vibration; and the formulæ to be employed for the purpose are given in the work of Gauss, entitled 'Intensitas vis Magneticæ Terrestris' (1833). See also the Report of the Committee of the Royal Society, 1840. But Gauss considers that determinations of intensity by the vibrations of a needle are inaccurate on account of the changes which may take place in the intensity during the time in which the vibrations continue; and in 1837 he invented a new instrument, which is called a Bifilar magnetometer, for the purpose of determining the horizontal intensity alone. This consists of a magnetized needle or bar resting horizontally in a stirrup placed under a circular graduated plate, to the upper part of which are attached the two extremities of a fine steel thread or wire. The middle, or

the bend, of the thread passes over two pulleys fixed in the upper part of the building; and the ends of the thread hang in vertical positions, or parallel to another, when the needle rests in the magnetic meridian. Then, on turning the whole apparatus horizontal to make the needle deviate from the magnetic meridian, the tendency of the needle to return to its former position causes the threads to assume directions oblique to each other; and there is some position of the needle in which its directive force is equal to the force by which the threads resist being made to cross each other's directions, so that, when equilibrium takes place, the needle shall lie in a direction at right angles to the plane of the magnetic meridian. The torsion of the threads by which the needle is held in that position indicates the horizontal component of the magnetic force, and every change in the declination of the latter affects in a direct manner the position of the needle. The magnetized bar in use at the Observatory weighs 25 lbs., and the length of the suspending threads is 17 feet. (Taylor's *Scientific Memoirs*, parts vi., vii.) Instruments on the same principle, but of smaller dimensions, are made for ordinary use at the Royal Society's Report.

The vertical force magnetometer consists of a needle resting on agate planes by what are called the edges, and it is made to assume a horizontal position by means of weights: the deviations of the needle from the horizontal position, when in the plane of the magnetic meridian, are measured in a vertical plane making any angle with that plane, and serve to determine the variations in the vertical component of the magnetic intensity.

Gauss observes that, on account of the relation that the horizontal and vertical components bear to one another, these are more proper to serve as the basis of a theory, than the usual expression of the magnetic force by the total intensity, the inclination, or the declination; and he recommends that, in all calculations, the intensity in the horizontal direction should be taken distinct from the other elements.

TERRIER (*Canis familiaris Terrarius*), a dog remarkable for the eagerness and courage with which it goes to earth, and attacks all those which come under the gamekeeper's denominated *Vermin*, from the Fox to the Rat.

In the genealogical table of the different races we find the Hound immediately next in descent to the Shepherd dog, which is placed as the immediate ancestor of the Lapland dog, the highest in the table lateral to the Hound, the Terrier, and Harrier.

Lieut.-Col. Hamilton Smith (*Naturalist's Library*, treating on the *Cur Dogs*, after stating that in Africa we have a race of small Sacalian dogs; in one of Thuan's form; in India, the parent Pariah apparently captured in the woods of the coast of Southern China, all Persia, Natolia, and Russia, a similar predominant race of curs; and that there is everywhere evidence of an original species of small dimensions, or at least of one brought by the earliest colonists of the west, extending from the British Isles to Spain,—goes on to observe, that if we find that kind which now seems to be the most typically possessing innate courage, sagacity, and proficiency without training or care in breeding,—these are found most unquestionably united in the terrier, where so fully marked, with all the tokens of originality, as in the rough-haired or Scottish breed, the terrier,' says Col. Smith in continuation, 'with all the alacrity of innate confidence, all the resources of the willingness to remain familiar with subtle habits, and all the daring and combination of makes him fearless in the presence of the most formidable animals; for it is often noticed in India, that a bull-dog pauses, British terriers never hesitate to grapple with the hyæna, the wolf, or even the tiger. . . . If there be an original and in Britain, it is surely the species we have now, for if the Irish wolf-dog, or a questionable breed were derived from the British wolf, such a conquering powerful and ferocious animal could scarcely have been achieved without the aid and intelligence of a more domesticated and smaller species. But it is more probable that the terrier of antiquity was of the same race as

l-footed dogs of the Cymbers, and that the first were ight over from the north-west of Europe with the pri-ve inhabitants. Certain it is that the intermixture of-ier blood with other and later races has in no instance led to diminish their courage, hardihood, and fidelity; in no part of Europe has the rough-haired breed re-ed so completely as in Britain all the traits which con-ite a typical species.

erriers may be divided into two sections, the one rough-wire-haired, the other smooth-haired and generally e delicate in appearance. In courage and sagacity e is little difference if the dogs be well bred, but the and wiry coat of the former is a greater protection the attack of its adversary, and it is, if anything, the biter of the two. They are of all colours, red, will tanned faces, flanks, legs, and feet, brindled, y, own pied, white, and white pied. The Pepper Mustard breeds, rendered famous by Sir Walter Scott, highly valued.

very pack of fox-hounds, to be complete, should be mpanied by a brace of terriers, and one should be ller than the other, so that if one should be stopped small earth, the other may enter. For terriers going hounds, any colour is better than all red, for a red netimes mistaken for a fox, and hallooed off as y inexperienced sportsmen.

fr. Daniel, in his 'Rural Sports,' gives the following ount of the ferocity and affection of a terrier bitch:—

a very severe burst of more than an hour, a fox was . Daniel's hounds run to earth at Heney Dovehouse, roudbury, in Suffolk; the terriers were lost, but as the went to ground in view of the headmost hounds, and as the concluding day of the season, it was resolved to him. Two men from Sudbury brought two terriers that purpose, and, after considerable labour, the hunted was got and given to the hounds. While they were aking the fox, one of the terriers slipt back into the th and again laid; after more digging a bitch-fox was en out. The terrier had killed two cubs in the earth, : three others were saved from her fury. These the ner of the bitch begged to have, saying he should make : suckle them. This was laughed at as impossible; the n however was positive, and had the cubs: the bitch : was carried away and turned into an earth in another ntry.

Daniel then relates that, as the terrier had behaved well at earth, he some days afterwards bought her, with cubs which she had fostered. The bitch continued to them regularly, and reared them until they were : shift for themselves: what adds to the singularity, iel observes, is that the terrier's whelp was nearly o weeks old, and the cubs could just see, when this ege of progeny was made. He also states that a cir-ance partly similar to the foregoing occurred in 1797, duke of Richmond's, at Goodwood, where five foxes : tured and suckled by two foxhound bitches.

the same author states, that in April, 1784, his hounds at Bromfield-Hall wood. By some accident the er-in was thrown out, and after following the track ree miles, gave up the pursuit. As he returned e came through the fields near the cover where ox was found. A terrier that was with him whined very busy at the foot of a pollard oak, and he anted, supposing that there might be a hole at the harbouring a polecat or some small vermin. No l he discern. The dog was eager to get up the e which was covered with twigs from the stem to the and upon which was visible the dirt left by some- that had gone up and down the boughs. The n lifted the dog as high as he could, and the eerness increased. He then climbed the tree, up the dog before him. The instant the terrier a the top the man heard him seize something, and, : surprise, found him fast chapped with a bitch-fox, he secured, as well as four cubs. The height of the was twenty-three feet; nor was there any mode for : to go to or from her young, except the outside : the tree had no bend to render the path easy. of the cubs were bagged, and bred up tame to com-orate this extraordinary case: one of them belonged r. Leigh, and used to run tame about the coffee- at Wood's hotel, Covent Garden.

The breed of terriers recommended in the old times P. C., No. 1518.

when the huntsman went on foot, was from a Beagle and Mongrel Mastiff, or from any small thick-skinned dog that had courage. Thus the coat and courage were supposed to come from the Cur, and the giving tongue from the Beagle. The time for entering the young terriers at a fox or badger was when their age was ten or twelve months, with an old terrier to lead them on. When entered at a fox, and the old one was taken, the young terriers were set to attack the cubs unassisted, and when they killed them, both young and old terriers were rewarded with the blood and livers fried with cheese, with fox's or badger's grease: at the same time the dogs were shown the heads and skins to encourage them. There were other ceremonies recommended, too cruel to be repeated, and which could have been of little or no service. Honest Dandie Dinmont's mode of entering his Pepper and Mustard gene-rations is as good as can be practised.

A cross of the terrier with the bull-dog for the purposes of badger-baiting, &c., was at one time much in vogue. Of this breed was the celebrated dog Billy, famous for his destruction of rats. He was often turned into a room with a hundred of those animals, and he frequently killed every one of them in less than seven minutes.

Of those inhuman practices—it is degrading the term to call them sports—badger-baiting, cat-killing, dog-fighting, and the like, we purposely say nothing here, except that they have been, most properly, put down by law in the metropolis and its vicinity.

TERRIER, from the French word *terrier*, a land-book, a register or survey of lands. Those best known in this country are the ecclesiastical terriers made under the provisions of the 87th canon. They consist of a detail of the temporal possessions of the church in the parish. They ought to be signed by the parson, and are sometimes also signed by the churchwardens and some of the substantial inhabitants of the parish. Their proper place of custody is the bishop's or archdeacon's registry: a copy also is frequently placed in the parish chest. If a terrier is proved to be produced from the proper custody, and therefore may be presumed to be genuine, it is in all instances evidence as against the parson. And in those instances where it has been signed by churchwardens elected by the parish or by the inhabitants, it is also evidence as against the inhabitants generally; even against those occupying lands other than the lands occupied by the inhabitants who signed it. The questions in respect of which a terrier is generally employed as evidence are those relating to the glebe, tithes, a modus, &c.

(Starkie, *On Evidence*.)

TERTIARY STRATA, the title given by almost universal consent of geologists to the uppermost great group of strata. Previous to the publication of the 'Essay on the Geology of the Basin of Paris,' by MM. Cuvier and Brongniart, in 1810, but little attention had been awakened to this great mass of deposits, though the familiar use of the terms primary and secondary, and the acknowledged dissimilitude between the latest of these strata and modern accumulations from water, in respect of mineral aggregation and organic exuvia, seemed to be prophetic of the discovery of a newer type more in harmony with existing nature.

The extent to which, over great tracts in all quarters of the globe, this type has been found to prevail, is exceedingly great: most of the capital cities of Europe are built upon tertiary strata; many of the broadest plains and widest valleys in the New and the Old World are nothing but the dried beds of seas and lakes of the tertiary period: and some considerable mountain ranges bear on their high summits, and still more abundantly on their flanks, portions of the shelly tertiary strata which were uplifted from their original horizontality and subjected to the convulsive movements of which the mountain ranges are the result. In almost every part of the globe strata of this tertiary series prevail, and yield astonishing numbers of shells, corals, crustacea, and other remains of marine, fresh-water, and terrestrial invertebrata, and more locally abundant layers of fishes, and rich deposits of bones of mammalia, &c. Possessing so many attractions, and affording such unusual facilities for study, the tertiary strata of Italy, France, England, Northern Europe, the eastern states of North America, the great tracts of Brazil, Patagonia, &c., have been the theatre of great and laborious investigations, which have brought forward our knowledge of these de-

posits to at least an equal advance with that of the older strata.

More than this can hardly be said with justice; for though, in consequence of the great similitude between the agencies concerned in producing modern accumulations of sediments and organic exuvia, and those which produced the tertiary strata, the *minute* history of particular portions of these is almost completely known, their *general* history is imperfectly comprehended, because the original formation of those strata was performed under as great a variety of *local* conditions as the accumulations of sands and shells on the actual sea-bed, and because, since their production and elevation from seas or lakes to form dry land, they have, from their surface position and inferior induration, been more subject to superficial waste and destruction than the older, more sheltered, and more consolidated strata. The incompleteness of our knowledge of the *general* history of the tertiary strata is evident by the incompleteness of the classification which represents that history, and on this point, the only one which it appears necessary here to discuss, we shall offer a few remarks. Among the primary and secondary strata [GEOLOGY] subdivisions corresponding to successive times of production have been found practicable and definable, and traceable over immense areas by means of a combination of mineral, structural, and organic characters. Limestones of certain kinds, as chalk, oolite, magnesian-limestone, accompanied with green, brown, or red arenaceous and argillaceous beds, and holding spatangi, apicrinites, or palæonisci, mark and distinguish cretaceous, oolitic, and magnesian formations and systems of secondary strata corresponding to the carboniferous and other older systems of rocks. This has not been found so practicable in regard to the tertiary strata, which, though presenting many different sorts of strata, offer in the *manner of combination* amongst these too many general analogies, and too much of local difference, to be conveniently ranged into formations or systems having more than a local value, by means of mineral and structural characters.

Some assistance towards the desired classification appeared to be furnished by the alternation of marine and fresh-water sediments, as in the Isle of Wight, and in the basin of Paris, and hence the titles of Upper and Lower Marine, Upper and Lower Freshwater deposits acquired a considerable application. But the most successful and probably best-founded classification of tertiary strata rests upon a study of their organic contents.

It has been long remarked that in those strata, wherever they occur, the forms of animal and vegetable life make a near approach, even specifically, to living types. By careful examination, a certain number of species have been found in tertiary strata actually identical with or undistinguishable from living objects. The proportion in which these still living species are mixed with now extinct (or believed to be extinct) forms varies, so that in Sicily tertiary beds occur with above 90 per cent. of still living species of shells, but in the basins of London and Paris others are found containing only about 5 per cent.

There are reasons independent of these proportions which leave no doubt that the strata near London and Paris, which contain only 5 per cent. of living forms, are among the oldest of tertiary beds; while the Sicilian beds, which contain only about 5 per cent. of extinct species, are amongst the most recent.

Views of this kind generalized lead to a speculation which is strongly confirmed by the general current of geological discovery, that the relative antiquity of tertiary strata may be judged of by the relative proportion of extinct species of shells which are found in them. On this postulate M. Deshayes and Mr. Lyell have founded the most prevalent modern classification of tertiary strata, which may be thus briefly sketched:—

Recent Period.

Newer Pleiocene Period, the strata containing not above 10 extinct species in a hundred.

Older Pleiocene Period, the strata containing about 50 or 60 extinct species in a hundred.

Miocene Period, the strata containing about 80 extinct species in a hundred.

Eocene Period, the strata containing about 95 extinct species in a hundred.

Secondary Period.

(These terms are taken from the Greek *καιρός*, recent

combined with *πλιών*, more, *μείων*, less, and *φως*, the dawn.)

The principle of *per centage* employed by Mr. Lyell in this classification should not be strongly objected to on account of its rigorous numerical results being sometimes found locally inapplicable. It is impossible that this should be otherwise, for the numerical proportions of organic life must always vary in proportion to local conditions as well as to the general succession of physical influences; but that the great cause of the systematic variations of the forms of plants and animals in successive geological periods, whether primary, secondary, or tertiary, is the successive and systematic change of physical circumstances influential on organic life, appears amply proved. There appears no good reason to doubt that the variations of individual organizations, and the numerical proportions of their combinations, are in harmony with and indicative of the successive physical conditions when they lived, and consequently of the successive periods to which these physical conditions belonged. The comparison of individual fossil and living forms is merely *one*, and that not the most general or important, mode of manifesting the *numerical constants* of organic life of the several geological periods. By some other less obvious arithmetical processes, the relative analogies of ancient and modern nature may be made to appear numerically, independent of any such specific comparisons, and without limitation of geological age or geographical region. This has been attempted in regard to the Palæozoic fossils generally, and to the fossils of Devonshire specially, and the result affords remarkable encouragement to the application of rigorous calculations based on exact data representing the *numbers* of distinctly recognisable forms of different groups of organic remains, whether these be of living or extinct tribes.

We have only further to remark, that the tertiary strata are far more distinctly defined and separated from the uppermost secondary strata than from the recent deposits of water. In fact the most natural classification of tertiary volcanic products, tertiary strata, and tertiary organic remains, is with the living creation. In tertiary strata the phenomena of mineral accumulation seem to be such as are witnessed in daily operation: they contain marine, littoral, and pelagic deposits; æstuary and fluvial deposits; lacustrine beds hardly distinguishable from such as are now in progress. In these sediments occur remains of a system of terrestrial and aquatic life as complete as we except reasoning man) as that now in activity; and if the absence of man, and the animals which seem to be associated with him for his comfort and advantage in actual creation, be thought a sufficient reason to justify from historic time the account of tertiary deposits, and to justify the adoption of a distinct quaternary or modern period in geological classifications, it is not the less that the geological date of the epoch of this period, the line of separation between it and the tertiary is entirely unknown by direct and positive facts, and is incapable of determination by reasoning on any of the phenomena at present ascertained.

(Lyell, *Principles of Geology*; De la Beche, *Geological Manual*; Phillips, *Palæozoic Fossils of Devon*.)

TERTULLIANUS, QUINTUS SEPTIMIUS FLORENS, the earliest of the Latin ecclesiastical writers, lived in the latter part of the second century and the beginning of the third. The exact date of his birth is unknown; Tillemont supposes that it was in 160 A.D., and others have fixed it as early as 135. He was born, according to Jerome (*De Vir. Illust.*, 53), at Carthage, where his father was a centurion in the service of the proconsul of Africa. He embraced the profession of an advocate or rhetorician, in which he appears to have attained to some eminence. During this period of his life he was a heathen, as he himself informs us (*Apolog.*, 18; *De Spectac.*, 19; *De Resurrect. Carn.*, 19, 59; *De Penitent.*, 1). He was converted to Christianity at Carthage in all probability, though an expression of Eusebius (*Hist. Ecc.*, ii. 2) has been thought to imply that his conversion took place at Rome. Immediately upon his conversion he was of a presbyter. About the end of the second century, writers suppose about the year 200, he became a Montanist. [MONTANISTS.] Jerome (*l. c.*) ascribes this to his suffering from the envy and insults of the clergy of the Roman church, but a more adequate and more pro-

son for it is found in the character of Tertullian. In his writings composed before his Montanism many traces of that zeal and asceticism which is peculiar characteristic of the Montanists. It is doubted whether he remained a Montanist to his end; some have thought that he returned to the catholic and others suppose that he at last settled down on an intermediate between those of the Montanists and of the orthodox. For neither of these suppositions there any sufficient proof. There existed indeed, in the fifth century, a sect called Tertullician, but between them and Tertullian there appears to be no historical connection.

Whether he remained a Montanist or not, he continued to be in the greatest respect by the African churches. It is to his influence that we must trace the changes which distinguished those churches from others, and which at length, through Augustin, gave to the Christianity of the West. His influence was great upon Cyprian, in whose writings there is a close resemblance to some of Tertullian's, and of which he is asking for the works of Tertullian as well to say, 'Da magistrum' ('Give me my

te of Tertullian's death is unknown, but we are told that he lived to a great age. One of his works (ad Scapulam) was written as late as 216 A.D.

A portion of his works have come down to us, and they are divided into three classes: (1) apologetic, (2) moral, and (3) doctrinal or controversial. The same work is sometimes stated differently, as follows:—(1) against the heathen; (2) writings on the morals, rites, &c. of the church; and (3) writings against heretics. It is important to distinguish, if possible, the works which he wrote before he became a Montanist and those which he wrote afterwards. This has not been attempted by Neander and Bähr. On the other hand, a few writers have thought that all the works of Tertullian were composed after he adopted the doctrine of Montanism. (J. G. Hoffmann, *Diss. omnia opuscula Tertulliani scripta videri*, Wittenberg, 1738.) In the list of Tertullian's Apologetic Works the following are placed along to the earlier part of his life, and to have been written in the reign of Septimius Severus. They are the peculiar tenets of Montanism:—(1) *Martyres*; for the encouragement and vindication of those who suffered for being Christians. (2) *Spectaculis*; written about 198, against the games and festivals, and to dissuade Christians from attending them. (3) *Idololatria*; an exposure of the character and of idolatry, with an exhortation to Christians to avoid its approach to participation in it. (4) *Apologeticus adversus Gentes pro Christianis*; his first work of this class, and one of the best of all his works; a powerful refutation of the accusations made against the early Christians, and a warm remonstrance against the persecutions they suffered, addressed to the Roman emperors. It was written in the year 198, and has been highly held in very high esteem both in ancient and modern times.

(5) *De Nationibus Libri II.* These two books, which were first printed in manuscript by James Gothofred, and were first printed at Geneva, 1625, 4to., form a kind of continuation to the 'Apologeticus.' The first contains the same matter as that book, sometimes expanded, sometimes abridged, and sometimes newly arranged; the subject of these books appears to be about 199, if they were written after the 'Apologeticus'; but some writers suppose, as Neander and Münter, suppose that they were written before the latter work, in the year 198.

(6) *De Testimonio Animæ*; may be considered another supplement to the 'Apologeticus,' the subject of which contains in fact the same argument in a different form. Its object is to prove that there exists in the human mind, to a certain extent, a knowledge of the true God, and that this knowledge of God is the Christian doctrine of his character.

The remainder of Tertullian's apologetic works appear to have been written after he became a Montanist. They

(7) *Corona Militis*; a vindication of a Christian

soldier, who refused to wear a crown which had been awarded to him, on the ground that it was a badge of heathenism, and who was imprisoned for his refusal. This work contains remarks on other questions relating to the duties of a Christian citizen under a heathen government.

(8) *De Fuga in Persecutione*; a statement of the Montanist opinion that Christians, when persecuted, might neither attempt to save their lives by flight nor by money. Written about 202.

(9) *Contra Gnosticos Scorpiace*; an answer to the slurs thrown upon the martyrs in the persecution of Septimius Severus, by those *scorpions* the Gnostics.

(10) *Liber ad Scapulam*; a defence of the Christians, addressed to Scapula, the proconsul of Africa, who persecuted them.

II. *Practical Works*, relating to Christian morals and discipline. The following were written before he became a Montanist:—

(11) *De Patientia*; on Christian patience.

(12) *De Oratione*; on prayer: one of Tertullian's earliest works.

(13) *De Baptismo*; on baptism: a defence and explanation of the rite.

(14) *De Poenitentia*; on repentance: a manual for Catechumens and newly-baptized Christians.

(15) *Libri Duo ad Uxorem*; exhorting his wife not to marry a second time, if he should die before her.

The two following works were, in Neander's opinion, most probably written after Tertullian became a Montanist:

(16) *De Cultu Feminarum*; on female attire: consisting of two books, the first of which is sometimes denoted by a separate title, namely, *De Habitu Muliebri*.

(17) *De Virginibus Velandis*; on the veiling of virgins: in opposition to the custom then prevalent at Carthage, of virgins appearing in church with the face exposed.

The remaining works of this second class are undoubtedly Montanistic:—

(18) *De Exhortatione Castitatis*; dissuading a friend from marrying a second time. To the same purport are

(19) *De Monogamia*; and (20) *De Pudicitia*.

(21) *De Jejunitate*, or *De Jejuniis*; recommending the severe practices of the Montanists, in preference to the milder doctrine of the orthodox respecting fasts. In this work, and others of his writings, he applies to the orthodox the term *psychici* (*ψυχικοί*), *carnal*, which is used by Paul (1 *Cor.*, ii. 14) in opposition to 'spiritual.'

(22) *De Pallio*, composed in the year 208, is a treatise recommending the wearing of the Greek pallium in preference to the Roman toga. It contains much information respecting the form of these garments.

III. *Works on Christian Doctrine and Polemics*. The only one of this class which seems to have been written before his Montanism is

(23) *De Præscriptione* (or *Præscriptionibus*) *Haereticorum*; against heretics in general, and especially the Gnostics and Marcionites.

He continued his attacks upon the heretics, and especially the various sects of Gnostics, after he became a Montanist, in the following works:

(24) *Adversus Marcionem Libri V.*

(25) *Adversus Valentinianos*; which Semler supposes to be a close imitation of Irenæus, *Contra Haereses*.

(26) *De Carne Christi*, and (27) *De Resurrectione Carnis*, are treatises on the resurrection, in opposition to the Gnostics.

(28) *Adversus Hermogenem*; against the doctrine held by a Gnostic of that name, that matter is eternal, and that out of this eternal matter not only all sensible things, but also the souls of men are made, the latter being besides endowed with a divine principle of life (*πνεῦμα*). Against this doctrine concerning the soul Tertullian wrote another work, from which only some quotations have come down to us: *De Censu Animæ*. Our loss is the less, as we have a fuller treatise by Tertullian on the same subject, (29) *De Anima*; in which he discusses the theories of heathen philosophers concerning the soul, and opposes to them all the doctrines of Christianity, that it is spiritual, immortal, and received direct from God.

There is also a work by him on the doctrine of the Trinity.

(30) *Adversus Praxean*; written about 204 or 205, against the doctrine of Praxeas, which was in fact essen-

tially the same with that which afterwards became known as Sabellianism.

In the latter part of his life he wrote a work, (31.) 'Adversus Judaeos,' in answer to the Jewish objections against Christianity.

The above list contains all the extant works of Tertullian, but he must have written many more, since Jerome informs us that many of his works had been lost even before his time. (Hieronym., *De Vir. Illust.*, c. 53.) Among his lost works, of which the titles are known, besides that 'De Censu Animae,' already mentioned, are some which were especially designed to explain the opinions of the Montanists, namely, 'De Spe Fidelium,' one of the earliest works in which was put forth the doctrine now known as Millenarianism, of the personal reign of Christ on earth for a thousand years [MILLENNIUM], and 'De Paradiso.' He also composed a defence of the 'ecstasies' of the Montanists in six books, to which was added a seventh against a certain Apollonius. His treatise 'De Aaronis Vestibus' appears to have been lost before Jerome's time. (See Hieronym., *Epist.* lxiv., near the end.)

Two works which are sometimes erroneously ascribed to Tertullian are the 'Carmina Sibyllina,' and the 'Acta Perpetuae et Felicitatis.' Tertullian holds one of the first places, if not the very first, among the Latin fathers, for learning and intellectual power. Even those to whom his peculiar opinions were the least acceptable have eulogized him in the highest terms. Thus Jerome says (*Epist.* lxx., sec. 5), 'What more learned, what more acute than Tertullian? whose apology and books against the heathen embrace all the learning of the age.' Vincentius Lirinensis (*Commonitor.*, c. 24) adjudges to him 'by far the highest place among the Latin fathers,' and attributes to him 'the most extensive learning both in things divine and human, and a grasp of mind which comprehended all philosophy, all sects of philosophers, their authors and supporters, and every variety of historical and scientific knowledge.' Erasmus calls him 'by far the most learned of all the Latin theologians.' (*Prefat. ad Hilar.*) In short, the general judgment of the orthodox in ancient and modern times may be summed up in the words of Jerome: 'His genius I praise, his heresy I condemn' (ejus ingenium laudo, haeresin damno). In fact, he appears from his writings to have become acquainted with all the learning then taught in the schools of the rhetoricians, while to this he added the results of careful observation, and then brought all his knowledge to the support of the opinions he embraced, first as a Christian and afterwards as a Montanist. Perhaps the most striking feature in his writings is his intimate acquaintance with all the ramifications of heathen theology and worship, and the powerful use he makes of this sort of learning in his controversies with the heretics.

His excellencies and defects are strangely mingled. We trace the skill of the rhetorician in his forcible reasonings and his eloquent style, but he has also the rhetorician's faults in arguing often with more sophistry than truth, and in taking liberties with language till his meaning becomes obscure. His warm and zealous temper gives life and impressiveness to his writings; but its excess made him an enthusiast and ascetic, perhaps we ought in truth to say, a fanatic. In his writings we may generally see a striving after words to express the warmth of his feelings and the depth of his convictions, and the result of this effort, combined with the rhetorical character of his style, is often to render his eloquence inflated and obscure. He indulges frequently in figures and hyperboles, and excels in satire and irony. His writings differ greatly both in argument and style. His polemical works are the clearest, but not the most elegant. His best works are his Apology (4), and those on the Prescription of the Heretics (23), on Repentance (14), on Baptism (13), on Prayer (12), on Patience (11), and his address to Martyrs (1).

The best editions of Tertullian are those of Rhenanus, Rigaltius, and Semler. A full account of editions and illustrative works is given at the end of the excellent small edition of Tertullian by Leopold, in Gersdorf's 'Bibliotheca Patrum Ecclesiasticorum Latinorum Selecta,' 4 vols. 12mo., Leips., 1839-41, Tauchnitz.

It is doubtful whether the Tertullianus, or Tertullianus, from two of whose works there are excerpts in the 'Digest,' is this Tertullianus. The subject is briefly discussed by Zimmern ('Geschichte des Röm. Privatrechts'), with re-

ferences to other remarks on this subject. Tertullian, in his theological works, shows that he was well acquainted with Roman law.

(The Church Histories of Mosheim, Neander, and Schröckh; Baehr's *Christlich-Römische Theologie*; Neander, *Antignosticus Geist des Tertullianus*, &c., Berlin, 1825, 8vo.; Bishop Kaye, *The Ecclesiastical History of the Second and Third Centuries, illustrated from the Writings of Tertullian*, Camb., 1826, 8vo.; Münter, *Primordia Ecclesiae Africanæ*, Hafn., 1829, 4to. Other works on the Life and Writings of Tertullian are mentioned in the Appendix to Leopold's edition.)

TERUNCIUS. [As.]

TESCHEN, a circle of Austrian Silesia, is bounded on the north by Prussian Silesia, on the east by Galicia, on the south by Hungary, and on the west by Moravia. area is stated by most authors at about 720 or 740 square miles: Von Liechtenstem (alone, we believe) it 1360 square miles. The number of inhabitants is 180,000. The country consists entirely of mountains and valleys, but especially in the south, where the Carpathian chain commences. The northern part is flatter, but marshy, with many small lakes or meres, so that it is not well adapted for tillage. The Oder forms for a short the north-western boundary towards Prussian Silesia. The Ostravitza divides it on the west from Moravia. The Vistula rises in the Carpathians on the Hungarian frontier, from three springs, which unite near the mountain Tankow, flow to the village of Weichsel, and to the town Silesien, and Schwarzwasser, and then running along the northern frontier of the circle, pass into Galicia. The circle has many forests, and consequently timber abundance; fine pasturage; and a good breed of horned cattle, and swine. The inhabitants raise some oats and rye, and a great quantity of potatoes. There are mines of iron and coals, which are not so extensively worked as they might be. The inhabitants in general manufacture woollen cloth, linen, and wood-ware. The circle contains the duchies of Teschen and Bielitz, and several inferior lordships. [BIELITZ.] The duchy of Teschen however constitutes by far the greater part of the circle, having a population of 140,000 inhabitants, who are mostly of Slavonian origin.

The duchy of Teschen formerly belonged to the emperors, as kings of Bohemia. In 1722 it was assigned Leopold, duke of Lorraine, as an indemnity for the It duchy of Montferat, to which he had some pretensions. Upon his death in 1729 it was inherited by his son, afterwards the emperor Francis I., whose daughter Christina obtained it in 1776, and she having married Prince Albert of Saxony, he took the title of Duke Saxe-Teschen. Prince Albert dying February 10, 1790, without lineal descendants, the duchy was inherited by Archduke Charles, who governs it under the sovereignty of Austria.

TESCHEN, the capital of the circle and the duchy, is situated in 49° 40' N. lat. and 18° 32' E. long., at the foot of a gentle eminence, an offset of the Carpathian peninsula, or tongue of land formed by the river Olza, and a small stream called the Bober or Bobrecka. town has three suburbs, which are not separated from the town by walls or gates: the streets are in general broad and straight, a great fire in 1780, before which it resembled an irregular dirty Polish town, having given an opportunity to rebuild it in a better style; there are still however narrow and steep streets. There are four Roman Catholic churches and one Lutheran church; the last is a very large and handsome edifice. The Oberring is a regular square, or rather parallelogram, in which is the town-house, a building with a lofty tower, at the back of which is a theatre and concert-room. Teschen is the seat of the courts of justice and public offices of the circle and duchy. There is a Roman Catholic gymnasium, with a library of 12,000 volumes, and collections of minerals, sects, and medals; and a Protestant gymnasium and schools. The inhabitants, now 7000, manufacture broadcloths, kerseymere, leather, and a kind of wax known in Germany by the name of Teschinks. They have also a considerable trade in leather, wool, broadcloths, Hungarian wines, honey, and wax. The treaty between Frederick II. of Prussia and the empress Maria Theresa, which terminated what is called the war of the Bavarian succession, was concluded at Teschen in 1779.

; Stein; Cannabich; *Oesterreichische National*
—radie.)

MAURO ANTONIO, or, as he is sometimes
 after the name given him by his patron and ad-
 Algarotti, Il Maurino, was born at Montalbano in
 tory of Modena, January 15, 1730. Though in
 umstances, his parents were so desirous of giving
 a good education, that they removed for that pur-
 o Bologna, where he was admitted into the Scuole
 Manifesting a great taste for drawing, he was placed
 Carlo Morettini, a mere heraldry painter. It is
 re not without reason that Algarotti calls him self-
 , for though he afterwards received some instruction
 an engraver named Giovanni Fabbri, it could have
 ed but little towards the excellence he displayed
 branch of art which he selected,—architectural
 and painting. For this he was doubtless most of
 ted, after his own talent, to the instruction and
 ce of Algarotti himself, who made him the com-
 of his journeys to various places, and treated him
 son. The attachment was reciprocal; and it was
 to his attentions to his patron during his last illness
 that he fell into ill health himself, and died two
 erwards at Bologna, July 18, 1766.

otti has made frequent mention of Tesi in his
 where he has described many of his works at con-
 ue length, and speaks both of them and him in
 that would seem quite exaggerated, if they were
 sed by a less intelligent critic, or were his praises
 nfirming by the opinions of others. The encomium
 o his memory in the inscription on his monument in
 ch of St. Petronio, Bologna,—‘Elegantia veteris
 o ornatu, et architectura restitutori,’—has not
 red more than is due to one who set an
 re ut more refined and purer taste in architectural
 u and composition. His productions are highly
 d, and though his pictures are few, he left a great
 ce of drawings, and also a series of architectural plates
 ved by himself.

(Carboschi, *Bibl. Modenese*; Lanzi, *Storia Pittorica.*)

TRESSERA, a small cube or square resembling our dice,
 b was used by the antients for various purposes,
 accordingly it consisted of different materials, as
 e, precious stones, ivory, glass, wood, or mother-of-
 Such small tesserae of different colours were used
 m the mosaic floors, or pavements in houses, which
 hence called tessellata pavimenta. (Sueton., *Cæsar*,
) The same kinds of cubes, usually made of ivory,
 or hard wood, and marked on all their six sides, were
 y the antients as dice in games of hazard, just as in
 u s. In the earlier times three dice were used in a
 afterwards only two.

word tessera was also employed to signify any token
 as was given to persons by which they might recognise
 ther. In this case however the tesserae were pro-
 mot cubes, but were of an oblong form, or small ta-
 marked with certain signs. Thus we find mention of
 era hospitalis, which strangers when forming a con-
 n of hospitality gave to one another, that they or
 children might afterwards recognise one another, and
 that a tessera in this case was marked with the
 Jupiter hospitalis. (Plautus, *Poenul.*, v. 1, 25;
 &c.) Tesserae frumentariae, or nummariae, were
 y given at Rome to the poor to serve as a token
 on the presentation of which they received a cer-
 t of corn or money. (Sueton., *Aug.*, 40; *Nero*,
) The Roman soldiers also, before they commenced
 le, received a tessera containing the watchword by
 y recognised their comrades, and were enabled
 wish them from strangers. (Virgil, *Æn.*, vii. 637,
 note of Servius.)

Dictionary of Greek and Roman Antiq., ‘Tessera.’)

TESSIN. There are three eminent Swedes of this name,
 son, and grandson. The first of them, Nicodemus
 er, or NICODEMUS VALENTINSON TESSIN, was born at
 id in 1619, and held the appointment of royal or
 rchitect, which was conferred upon him by Queen
 na in 1645, then vacant by the death of Simon de la
 Very little more has been recorded of him, except
 e visited Italy, that a patent of nobility was granted
 e 1674 by Charles XI., and that he filled the office
 ate at Stockholm. Even the time of his death is
 ly stated, but it appears from collateral evidence

to have been somewhere about 1688. As an architect one
 of his chief works is the palace of Drottningholm, begun
 by him for the queen-dowager Hedwig Eleonora (widow
 of Charles Gustavus), but completed by his son. He also
 erected the royal villa of Strömsholm, and the mauso-
 leum of Charles Gustavus. In fame he has been surpassed
 by his more eminent son,

COUNT NICODEMUS TESSIN, who was born at Nyköping
 in 1654, and had for one of his baptismal sponsors the
 queen Maria Eleonora, widow of Gustavus Adolphus. He
 was carefully educated by his father, expressly with a view
 to his future profession. As soon as he had completed his
 studies, first at Stockholm, afterwards at Upsala, he was
 sent at the age of eighteen to Italy, whither he accom-
 panied the Marquis del Monte, a nobleman in the service
 of Christina of Sweden. He studied at Rome under Ber-
 nini, and acquired a taste for the fine arts generally. After
 four years thus spent, he visited Naples, Sicily, and Malta,
 and again returned to Rome, at which place he received
 from Sweden his appointment as future hof-architect in
 1689. On his return he was allowed, by Charles XI., to
 prosecute his travels conformably with his earnest wish for
 further improvement, and this time he visited England and
 France, in which latter country he remained three years.
 On finally settling in his native country, he received, in
 addition to his former appointment, that of city-architect
 to the magistracy of Stockholm. The destruction of the
 royal palace by fire in 1697 afforded him an opportunity
 for displaying his ability far more favourable than might
 else have offered itself; and of which he so well availed
 himself as to render the new edifice one of the noblest of
 its kind in Europe, though not what it would have been had
 his ideas been fully carried out. He had also numerous op-
 portunities of exhibiting his taste on a magnificent scale;
 but unfortunately they were only of a temporary nature—
 on occasions of splendid court pageants and festivals, in
 which his talent for architectural decoration was employed.
 One of them was at the solemnization of the public entry
 and coronation of Ulrica Eleonora, the wife of Charles XI.,
 who was herself an artist, and displayed considerable pro-
 ficiency in portrait-painting. By the queen-dowager
 Hedwig Eleonora he was employed not only to complete
 Drottningholm, but to lay out the grounds and gardens
 both there and at Ulriksdal. Besides the cathedral at
 Calmar, and Oxenstiern’s monument, he executed or de-
 signed a great number of other buildings, including a pro-
 ject for rebuilding the palace at Copenhagen, which was
 partly carried into effect, many years after his death, when it
 was curtailed, and by no means improved in other respects.
 Elevations of the original design were published by his son,
 under the title of ‘Regiæ Hafniensis Facies,’ &c. In addi-
 tion to his professional occupations, the count (which title
 was conferred upon him in 1714) was engaged in many
 offices that he held at court, and he took a considerable
 share in public and political affairs. At the time of his
 death (1728) he was chancellor of the university of Lund.
 Count Nicodemus was twice married.

COUNT CHARLES GUSTAVUS TESSIN, the son of Count
 Nicodemus by his first marriage, was born at Stockholm in
 1695. Though not without talent for architecture, which
 he had considerably improved by travelling, he did not
 exercise it professionally, except in completing the palace
 at Stockholm after his father’s death. His claim to cele-
 brity was of a very different kind; it was as a statesman
 and diplomatist that he chiefly distinguished himself. He
 was ambassador at the court of France from 1739 to 1742,
 and president of the chancery from 1747 to 1752. As tutor to
 the prince-royal, afterwards Gustavus III., he wrote for his
 instruction a series of letters on political and moral topics,
 which were published, and of which there is a French
 translation. Count Gustavus was a zealous promoter of
 every scheme for the advancement of his country; he did
 much for the encouragement of arts and manufactures, and
 first established the Swedish Academy for Painting and
 Sculpture in 1735. Some years before his death he with-
 drew from public business and affairs, and lived in retire-
 ment on his estate at Akeröe in Sudermania, where he died
 in 1771; and by his death the family became extinct.

(Weinwich, *Kunstner-Lexicon*; Nordin, *Minna öfver
 Namnkunniga Sverika Män*; Ehrenström, *B. Artis en
 Suede*; *Biogr. Univers.*)

TESTACELLUS, the name of a genus of testaceous
 pulmoniferous mollusks. For the views of authors as to

its place in the system, see the article LIMAX. Mr. J. E. Gray arranges it between *Plectrophorus* and *Helix*, under the *Helicidae*, his second family of *Pneumonobranchiata*.

Generic Character.—Animal elongated, cylindrical, acuminated at each extremity; no cuirass; head distinct, furnished with four retractile tentacles, of which the posterior are the longest and carry the eyes; foot long and rather indistinct; pulmonary cavity situated at the posterior fourth of the animal's length, its orifice placed entirely backwards, under the right side of the apex of the shell, the anal aperture is very near it; organs of generation united, and showing their orifice near and behind the great right tentacle.

Shell external, solid, uniform, depressed, with the spire more or less projecting, having a very large and oval aperture; the right lip simple and trenchant, the left convex and reflected: the shell covers the posterior part of the pulmonary cavity.

The number of species given by Lamarck is one only; and though M. Deshayes in his Tables makes the number two (both recent), one only is recorded in the last edition of Lamarck. Mr. G. B. Sowerby figures and describes three:—*Testacelli haliotideus*, *Scutulium*, and *Maugei*.

History, Habits, &c.—This form appears to have been first noticed by M. Dugué, in a garden at Dieppe in 1740: but it does not seem to have attracted much attention till M. Maugé, some years since, brought home specimens from the island of Teneriffe. 'It has also been found,' says Mr. Sowerby, 'in several parts of France, and in Spain, and more lately in a garden at Bristol. Some specimens from the last-mentioned place have been handed to us by Mr. Miller of that city. It feeds upon earth-worms, having the power of elongating its body to such a degree that it is able to follow them in all their subterranean windings: we have observed them attentively, and were rather surprised that an animal generally so extremely sluggish in its motions, after discovering its prey by means of its tentacula, thrusting from its large mouth its white crenulated revolute tongue, should instantly seize upon with extraordinary rapidity, and firmly retain, an earth-worm of much greater size and apparent force than itself, but which by its utmost exertion is unable to escape.' Mr. Sowerby adds, that De Férussac and Cuvier consider this to be the only carnivorous terrestrial mollusk.

De Férussac remarked that the simple, gelatinous, contractile mantle of the animal, hidden habitually under the shell, is divided into many lobes capable of enveloping the whole body by an extraordinary development, when the animal finds it necessary to protect itself from the consequences of too great dryness.

Localities.—*Testacelli haliotideus* inhabits the South of France; *Test. Maugei* is an inhabitant of Teneriffe, but naturalized at Bristol; and *Test. Scutulium*, which was discovered by Mr. Sowerby in a garden at Lambeth, may, in the opinion of Mr. G. B. Sowerby, be considered as a native of this island.

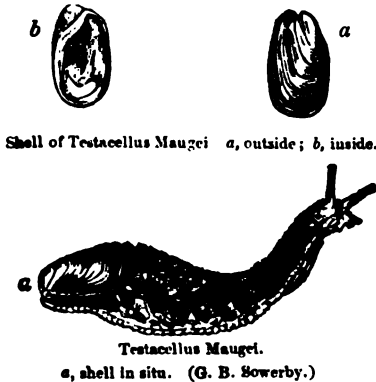

Shell of *Testacelli Maugei* a, outside; b, inside.

Testacelli Maugei.

a, shell in situ. (G. B. Sowerby.)

TESTAMENT. [WILL.]

TESTAMENT, OLD AND NEW. Some critical disputes have arisen respecting the meaning of the word *Testament*, as applied to the Canonical Scriptures. These, under the name of the two Testaments, comprise the revelations of God to man, which, being imparted under two principal conditions—the Law and the Gospel—are divided into two corresponding classes. The word thus translated by *covenant* is the Hebrew *berith*, so used in the first

division of the sacred writings, and rendered in by *diathece*. But a further notion than that of the Hebrew is contained in the Greek term belongs also to the ecclesiastical Latin one, *Testamentum*, the original of the ordinary designation of the two of the Scriptures, the Old and New *Testamentum*—more appropriate designation than that of the *ment* can be applied to the second portion. tion to the books of the Old was defended by (among other authorities of equal weight), on that 'Testamentum non voluntatem dei sed pactum viventium.'

This compact or covenant was originally by the Almighty with Abraham (although, to the outline of it was given on the fall of man). tory of the religion of the Old Testament the call of Abraham may be regarded as gressive development of a belief in the (view: 1, the knowledge of a Revelation connected work, and in its subject-matter; the attributes of God, so multiformously but time so harmoniously manifested. 'Antie ended as it had begun. The first discovery of it and the conclusion of it in the book of directed to one point. In its course it had disclosures, and furnished various succours to created an authentic record of God's providence government to be committed to the world. But and its latest use was in the preparatory Christianity.' (Davison.) The other subject, the Old Testament is taken up, is, as we have the progressive declaration of the attrib There is observable throughout the books of tament a *moral* as well as a *Christian* rev manner with the latter, 'the divine law Patriarchal and the Mosaic covenants do a model of the law of righteousness serve his Creator, as the later revelation Prophets.' (Ibid.)

The leading use of the Old Testament tory revelation of Christianity. Its one pressed or implied, was that of the depravity, and weakness of man. How de human conviction was this feeling, may be the universality of sacrifice for sin, and mediatorial ministry of a priesthood. Their weakness, and consequent estrangement from exhibited to the Jews by the sin offerings which God deigned to receive, not at the ordinary men, but at those of his servants. Nor were even these favoured as free from the lurking infection of their before whom the very heavens are not clean. priests the nearest access to God was forbidden the high priest (that awful and mysterious of Heaven) the Holy Place was closed, save on under certain restrictions. So clearly then divinely appointed law show forth to the Jews and the necessity and difficulties of a reconciliation God, which other nations saw but faintly, were destitute of some glimmerings of the truth. Jewish nation went a step beyond others. All in practice the necessity of sacrifice and a priest the people of God stood alone in this,—that hopefully forward to a time when the law high-priests of men having infirmity should a period be put to the daily ministering and same sacrifices, which can never take away was coming, when the words of God's be fulfilled respecting a more copious dif ledge of the Lord. And all this was was at once offering and priest, God Jesus Christ.

This great doctrine of Christ's atonement, an to mankind, form the end of the types, the and the sacrifices of the Old Testament. change was necessarily introduced by the at all sacrifice and priesthood in the great and end of the Son of God. Christ entered in once into Place, having obtained eternal redemption f leaving behind him, to the faithful, boldness to the holiest by his blood, by a new and li

7, or the religion of both Testaments, is that course of life which rests upon a conviction of necessity of the redemption of the world, and of the of a personal redeemer—Jesus Christ. Hence the y of various terms employed occasionally as us with Christianity (such as the religion of c uct; a practical belief in immortality and r- ; or the worship of God according to the *pattern of Jesus*) to express its distinctive peculiarities. of the religions to be found in the world at the birth can claim alliance with Christianity, save that alone has any pretensions to be regarded as nd positive, and which was directly alluded to in the words that 'Salvation cometh from the re the reasons of this difficult to be traced. on of the need of redemption turns the mind viction of sin; sin leads it to the considera- law broken and violated; and this last con- up to the original destination and capability of his relation to God; and nowhere are these steps ed so clearly as in the Law and the Prophets—the h contain the fullest account of the existing promised remedy.

that heathenism served in some sort to prepare for Christianity. This is clear from two facts: with which heathen converts adopted the tenets nity; and the analogy instituted by the early apologists between the relics of revealed truth, ned the brightest gems of heathenism, and their f 1. But this preparation was merely *negati-* mism did no more than point out contraries a could not reconcile, doubts which it could not and wishes which it could not gratify. All *positive* tion for Christianity and the subject-matter of reve- belongs to the Old Testament exclusively.

knowledge of the subject-matter of the Christian is drawn from one source exclusively, apostolical as preserved to us in the sacred writings of the Testament. From these alone authoritative instruc- deduced. An analytical outline of the system of untained in these writings is most properly divided o portions, respectively comprising the periods of terior and subsequent to the coming of Our Lord. nsidering the ante-Christian period, the attention ed between Judaism and heathenism, or in other between man under the law of God, and man with- law,—the two great classes into which the human dived subsequently to the publication of the ode. But although different in many particulars, s are included under one general point of re- e, their wretchedness and want of a redeemer.

his helpless condition of man the mind reverts to whence this dominion of sin and death, inse- uited, dates its commencement. But here a arises, whence was derived the power of sin to self among those who, like the Jews, possessed a ze of the will of God? The considerations arising of the relation of sin and death to the law, lead on that the commandment which was or-

was unto death. The law, according to so far from affording deliverance from sin, or r- antification, was the means of aggravating both ation and guilt. This is still further illustrated facts laid down by St. Paul, that the law can ce man holy or happy in the sight of God. Being y was it given at all? The answer is, that it be-

the plan by which God designed to make man of redemption through Christ. To establish the of such redemption, to impress upon men a con- if the need of it, and to kindle a longing for it in s, is the object of the period anterior to Christ.

u 7 a survey of the state of the human race ny to the coming of Christ leads to a conviction ed of a redeemer. The heathens lived in vice, knowledge of God, serving idols. Their standard was little higher than that afforded by earthly few traces remaining of a higher knowledge. tion of the Jews was very different. They were possession of the divine law, but they sought in e blish their righteousness before God by ob- o, its precepts.

gh redemption, the difficulties which characterized -Christian period (and more especially the Jewish

portion of it) were removed, and God and man reconciled. The statement of the conditions and accomplishment of this reconciliation leads to the consideration of the new and holy life arising from it.

The primary source and commencing point of the whole scheme of redemption is God. According to his eternal council, God decided on reconciling to himself a world which had become alienated from him, and on rescuing the race of Adam from the ruin to which they were hastening. This decree God had made known through his prophets. An evidence of his truth and faithfulness was supplied by its accomplishment. The instrument of this was the mission of his Son, according to the eternal purpose of his Father, 'that in the dispensation of the fulness of time he might gather together in one all things in Christ, both which are in Heaven and which are in earth.' This mission of the Son, from which the newer period, that of Christianity, dates, coincides with the time when heathenism and Judaism may be said to have filled their appropriate spheres of moral action. Although no dogmatic system, technically speaking, is to be found in the writings of the New Testament, two points immediately relating to the person of Christ are brought prominently forward throughout. The first of these is his *claim* to divine honours as the Son of God; the second, his meritorious course of action, of which the crowning point was his death, to which his resurrection was the glorious sequel, and the proof of the completeness with which his office had been discharged.

The object of our Lord's earthly life was rather a course of blameless and exemplary action than the delivery of a moral code for human guidance. Hence, although in the hortatory portions of St. Paul's Epistles allusion is made to the excellencies exhibited by Christ, the mode 'of becoming like him' was conceived in a spirit far deeper than that of mere moral imitation. It is described as a putting off the old man, and being clothed with Christ; as being buried with Christ, and as rising again with him. Such expressions arise necessarily from the inseparable connection, laid down in the New Testament scheme, between the death and resurrection of Christ, as the foundation of the justification of man in the sight of God.

The doctrines of repentance and a holy life implied in these characteristics of the new covenant are essential conditions on the side of the human party to the contract. This is the sum and substance of the Sermon on the Mount, which stands at the entrance of our Lord's earthly ministry, a fit entrance and portal to the temple which lies beyond, and an unfolding of the spirit and pure meaning of the law under which Christ came to live and suffer. A better observance of this would have obviated the Antinomian perversions which have risen up from the earliest times. One garment, and one only, will make man meet for Heaven (the wedding garment of Christ's parable), which is the imputed righteousness of Christ, the accepted sacrifice for the children of Adam. But while the human race exists, the essential rules of that law which Christ came to satisfy will be binding, and men will find their truest pleasure and profit in obedience to its spirit. Christ came to found a new kingdom. Accordingly he opens his first discourse by describing the members of it, their condition and prospects in the world. And yet his kingdom was not so much a new one, as a fulfilling and spiritualizing of the former dispensation; for which reason the second part of his sermon is taken up in expounding the law of Moses, and its real obligations, and, in the words of Robert Hall, 'in animating its spirit, and in filling up or directing its practice.' But essential to a due performance of the conditions of this law 'must be reckoned the assistance or guidance of God's holy spirit, as the chief of all aids, and which contains all others. And because this cannot be understood without admitting that the Holy Spirit is omnipresent, all-sufficient, and, in a word, strictly divine; therefore the divinity of the Holy Ghost is a fundamental article of the Christian covenant.' (Latham, *Harmonia Paulina*.)

Christian Society forms the second part of the theological system which may be extracted from the New Testament, as comprehending the origin of the Christian community, its gradual progress and necessary conditions, the relation of its members to each other, and their unity in the spirit. We cannot fail to observe, according to Hammond, 'from the interchangeable mixture of the graces described by Christ in the opening of the Sermon on the

Mcunt, that to God belongs the chief and first and last of our love and obedience, yet so as not to *exclude*, but *require* also in its subordination our care of duty and love towards man also; one intermixing lovingly and friendly with the other, and neither performed as it ought, if the other be neglected.' The common bond of all Christians is the faith and hope by which they become partakers of the benefits and salvation placed within their reach by the meritorious death and the resurrection of Christ. Accordingly, 'the partakers of this common faith and hope form collectively that spiritual body of which Christ is the head, namely, the Christian Church, in which, as in the natural body, various offices are distributed to the different members; but the most excellent endowment of any member is to walk in Christian love and purity under the guidance of the Holy Spirit. The two sacraments, which were typified to the Israelites in the wilderness, baptism and the Lord's Supper, are symbols of the Church's union with Christ. In baptism, the outward sign of our resurrection to a new life from the death of sin, and of our admission to the Church, we are joined by the Holy Spirit to Christ our Head; and the perpetual commemoration of Christ's death, according to his command in the Lord's Supper, is a means whereby we perpetually renew our spiritual strength, and draw more closely our union with him and with each other.' (Latham, *Harm. Paul.*)

The conclusion of the subject-matter of the New Testament is a sketch (by prophetic anticipation) of Christian society in its completeness of glory, which shall be accomplished by Christ at his second coming as the glorified Son of God, when he shall triumph over all opposition, and the redeemed be united with God in everlasting happiness. We have seen that Christ's obedience unto death was in order that many might live; and this will be accomplished at that resurrection which Christianity alone teaches clearly. Those who are now in the image of the earthly, will then be in that of the heavenly. The same spirit, which we learn from the New Testament dwelleth in our mortal bodies, shall quicken these that they shall be raised from the dead. When 'those that dwell in the dust shall awake,' then our mortal bodies will be changed, and made like unto the glorified one of Christ, by the power wherewith he is able to subdue all things unto himself.

TESTAMENT, OLD AND NEW. The view of the connection of the Old and New Testaments and the general theory of divine revelation given in the preceding article are by no means admitted by all Christians. They are departed from in various directions and degrees by different sects, but are most completely opposed by Unitarians. They deny that the doctrine of hereditary and total depravity is either consistent with reason and experience or at all sanctioned by Scripture. They hold the nature of the sacrifices, both in the patriarchal times and under the law, to be altogether misunderstood by those who consider them as referring to a corrupted nature and to an atonement. They endeavour to prove that the sacrificial language of the New Testament is founded on figurative allusions to the rites and ceremonies under the law, may be naturally traced to the circumstances of the writers, and has peculiarities which it could not have had if intended literally to express a great religious doctrine. They maintain that the whole system of types and antitypes in the Old and New Testament is without good Scriptural authority, and loaded with inconsistencies and false views both of the law and the gospel. They also reject the applications which are made of some real or supposed prophecies.

The view which prevails among modern Unitarians of the general theory of revelation and the connection of the various parts is, that the different divine interferences were adapted to different stages in the progress of mankind from infancy towards maturity; that each was best fitted for the time in which it was given, uniting the greatest amount of immediate good with the greatest power to promote the advancement of the race; that the Jewish system in particular was designed to preserve the great doctrine of the Unity of God at a time when the world in general was sinking fast into a degrading and corrupting idolatry, to exhibit to the nations around, and to all who should afterwards contemplate the history of the chosen people, a proof and illustration by example of the moral government of God, and to prepare the way for the establishment, when the world should be in a fit state for re-

ceiving it, of the more perfect dispensation of which which may be properly represented as a spiritually perfected Judaism, adding to it whatever impious truths could not have been previously with advantage, especially the grand doctrine of a future life, and opening the privileges of religious faith, and hope to men of all nations without and without ritual observances. The known paternal character of God and of his readiness to receive all his children who sincerely desire and endeavour to please him; the doctrine of a future life distinctly directly proved, and the enforcement of the principles, constitute, according to their view, the value and value of Christianity; and the whole of God's holiness requiring human punishment, and merits saving men from wrath, is rejected as unreasonable, and pernicious. It is enough to state the opposite doctrines which form the basis of controversy in the Christian world. All give an account of the evidence appealed to would lead us far beyond the bounds which we wish to prescribe to ourselves.

TESTAMENTS OF THE TWELVE PATRIARCHS, a Greek work which professes to contain the history of the twelve patriarchs, the sons of Jacob, but is considered to be undoubtedly spurious by all writers. Whiston, who accepts it as a part of the canon of the Old Testament; but no weight can be attached to it on the matter.

The age and authorship of this work is a subject which is once quoted by Origen, who flourished about the year 230. The most probable opinion is that of Cave and Lardner, who suppose it to have been written by a Jew who converted to Christianity about the end of the first century after Christ.

It appears to have been the writer's object to insert quotations from the books of the Old Testament into the Canon, since, though he mentions many of them by name. The only quotation by name is 'the book of Enoch the prophet.'

These testaments have been frequently translated into Latin. They were first printed in Greek by Spicileg. Patr., and afterwards by Fabricius in his *Pseudepigraph.*, and Whiston published an edition of them in his *Authentic Records.*

(Lardner's *Credibility*, part ii., c. 29, § 3, and see there quoted.)

TESTIMONY. [EVIDENCE.]

TESTIMONY, PERPETUATION OF. [PERPETUATION OF TESTIMONY.]

TESTONE, or TESTOON. [MONEY.]

TESTS, CHEMICAL, or Chemical Reactions. Substances which are employed to detect the presence of other bodies, by admixture with which they produce certain changes in appearance. Thus, for example, as the blue colour of litmus is destroyed by acids, it is considered as used to determine their presence when uncombined with alkalis; so also litmus which has been reddened by acids is used to determine their presence when uncombined with alkalis.

We give these examples from those which have been selected, merely to explain the term chemical test, observing that change of colour is only one of the many alterations adduced in proof of action: thus the solubility of certain salts in water, and not in others, constitutes another test of the nature of bodies.

We cannot enter particularly into this subject, as its extent is equalled only by its importance; and it is a requisite that we should do so, since, in the analysis of various metals, &c., the tests of their presence are given with the properties of their salts.

We refer the reader who wishes for a complete treatise on the subject to two works which have appeared viz. 'Traité élémentaire des Reactifs,' &c., by Chevallier, in 2 vols. 8vo., and 'Dictionnaire de Chimiques,' by Lassaigne, in 1 vol. 8vo.

TESTUDINATA. [TORTOISES.]

TESTUDO. [TORTOISES.]

TETANUS (*tétanos*, derived from *τετανω*, to stretch), both a generic and a specific term: generically,

l to be a more or less violent and rigid spasm of or all of the muscles of voluntary motion; the name particularly applied (as will be seen hereafter) to the species of this affection. Both the disease and name are as old as the time of Hippocrates; and, proved by experience to be much more frequent in the antient physicians probably had peculiar images in observing it, and accordingly seem to paid particular attention to it. The following de- on by Aretaeus (*De Caus. et Sign. Morb. Acut.*, cap. 6, p. 6, ed. Kühn) is written in his usual graphic (The translation by Dr. Reynolds has been chiefly ed.)

'Tanic spasms,' says this author, 'are attended with pain, and prove rapidly fatal, and by no means admit of relief; they make their attack on the es and tendons of the jaws and neck, but impart the e to every other spot, for all parts become sympath- affected with those which were primarily assailed. ere are three forms of the convulsions: the straight, ickward, and the forward. The straight one is true , when the patient is stretched straight and inflexi- ue backward or forward varieties have their name he direction and locality of the tension; hence the ion of the patient backwards is termed *opisthotonos* (ὀπισθοτόνος), from the nerves being affected in this direc- while, if the bending be forward, by the nerves in it is termed *emprosthotonos* (ἐμπροσθότονος), for *tonos* is a term which signifies both a *nerve* and *tension*. e causes of these affections are numerous: they often a wound of a membranous part, or punctures in r nerves, and in such cases the patients usually r (as Hippocrates says, *Aphor.*, sect. v., § 2, tom. iii.,) "traumatic spasms are fatal." A woman may be after miscarriage, and she seldom recovers; some are seized with spasms from a violent blow on the intense cold may prove a source, and hence these s are particularly liable to occur in the winter; they s frequent in the spring and autumn, and least of all summer, unless they arise from a wound, or a visita- f foreign diseases. Women are more liable to con- is than men, because they are of a colder tempera- but they more frequently recover, from the moisture r temperaments.

respects the various periods of life, children are liable affection, but do not often die, for it is one they d to, and familiar with; youths are less frequently l, but more die; adults are least of all liable to be d; while the old have it, and die from it, more y other class of persons: the cause is referrible to idity and dryness of old age, which is also the of death, for, if the cold be attended with mois- ne spasms are less injurious and fraught with less

be said in general of all these affections, that they cued with pain and tension, both of the tendons , and of the maxillary and thoracic muscles; for iench the lower jaw to the upper, that it is not separate them either by lever or wedge; and if, r separating the teeth, any liquid be introduced, swallowed, but returned, or retained in the mouth, through the nostrils, for the passage of the closed, and the tonsils, being hard and tense, do se so as to depress the food in swallowing. The and mottled, the eyes nearly fixed, turned with round, there is a strong feeling of stifling, respira- d, the arms and legs on the stretch, the muscles g, the face distorted in all sorts of ways, the cheeks tremulous, the chin in constant motion, the teeth and sometimes the ears will move, as I have myself l with amazement: the urine is either retained ient pain, or flows off involuntarily from compres- the bladder. These appearances are common to all cies of spasms; each variety of this disease has r its peculiarities.

tetanus the whole body is stretched in a right d and immovable, while the legs and arms are

opisthotonos the patient is bent back, so that the called in that direction lies between the shoulder- while the throat projects; the lower jaw is usually and is rarely locked with the upper; the respiration rous, the abdomen and thorax are prominent, and in P. C., No. 1519.

this form especially there is incontinence of urine; the epigastrium is tense and resonant when struck, the arms are forcibly wrenched back in a state of tension, while the legs lie bent together, for the elbow bends in a manne: the reverse of what the ham does.

'If *emprosthotonos* take place, the back is bent, the hips are forced on a level with the shoulders, the whole spine is on the stretch, the head is dependent and bent on the chest, the chin fixed upon the sternum, the arms cramped up, and the legs at full stretch. The pain is severe in all the forms, and wailing is the voice, deep are the sobs and groans, and if now the disorder has assailed the chest and respiration, it soon hurries the sufferer off—a boon indeed to him, as it relieves him from pain, distortion, and humiliation, and serving also to lighten the distress of those present, even if they be his own father or son; but if there be still respiration enough to support life, and although oppressed it be still performed, the patients are not merely bowed forward, but are even rolled up like a ball, so as to have their head on their knees, and their legs and back parts wrenched forward, so as to look as if the knee joint were thrust into the ham. It is an affliction more than man can bear, a sight revolting and painful to behold; and this cruel disease is irremediable, and from the distortion the sufferer is not recognised, even by his dearest friends, and the prayer of those around (which would have been heretofore impious, but hath become now righteous) is, that the wretched sufferer may depart out of life, and be released at the same time from his existence, pain, and horrible torment; and the physician, though present and looking on, is not merely unable to save his life, or to give relief to his pains, but he cannot even improve his shape; for to attempt to straighten the limbs would be like mangling and breaking the man in pieces while yet alive, and therefore, no longer offering his assistance, he is reduced to the sad necessity of merely contributing his sympathy.'

The three forms of the disease mentioned by Aretaeus are described by most of the antient writers: the species called *trismus*, or *locked-jaw* (which is the name applied to it when the spasms are confined to the muscles of the jaw or throat), forms a fourth in modern authors; and to these has been added a fifth, under the name *Pleursothotonos* (πλευροσθότονος), which signifies that the body is drawn to one side. These different terms applied to tetanic affections do not imply so many particular diseases, but only the seat and various degrees of one and the same complaint. Trismus is invariably a part of each of the other varieties. This subdivision of the disease is of little or no practical importance; but a much more essential division is into *acute* or *chronic*, according to its greater or lesser intensity. The former kind is exceedingly dangerous and usually fatal; while the latter, on account of the more gradual progress of the symptoms, affords more opportunity of being successfully treated. (Larrey, in *Mém. de Chirurgie Militaire*, tome i., pp. 235, 236, quoted in Cooper's *Dict. of Pract. Surgery*.) Tetanus is also divided into *traumatic*, or that arising from a wound, which is also occasionally termed *symptomatic*; and into *idiopathic*, or that which proceeds from other causes.

Traumatic tetanus sometimes comes on in a surprisingly sudden manner, and quickly attains its most violent degree. The most rapidly fatal case that has ever been recorded is one that we have on the authority of the late Professor Robison of Edinburgh. It occurred in a negro, who scratched his thumb with a broken china plate, and died of tetanus a quarter of an hour after this slight injury. (Rees's *Cyclo-pædia*, art. 'Tetanus,' quoted by Cooper.) Most commonly however the approaches of the disorder are more gradual, and it slowly advances to its worst stage. In this sort of case the commencement of the disorder is announced by a sensation of stiffness about the neck, a symptom which, increasing by degrees, renders the motion of the head difficult and painful. In proportion as the rigidity of the neck becomes greater, the patient experiences in the throat a sense of dryness and soreness, and about the root of the tongue an uneasiness, soon changing into a difficulty of mastication and swallowing, which after a time become totally impossible. The attempt at deglutition is attended with convulsive efforts, especially when an endeavour is made to swallow liquids; and so great is the distress which accompanies these convulsions, that the patient becomes very reluctant to renew the trials,

and occasionally refuses all nourishment: sometimes it even inspires him with a dread of the sight of water, and a great resemblance to hydrophobia is produced.

With respect to the causes of tetanus, 'it must ever be regarded,' says Dr. Gregory (*Theory and Practice of Med.*), 'as a very singular fact in pathology, that an affection of so peculiar a character as this should have its source in causes apparently so dissimilar; that the puncture of a nerve, the laceration of a tendon, or an extensive burn, should bring on the same kind of nervous affection as that which is the occasional consequence of cold.' Every description of wound, no matter how inflicted, or in what part, or in what stage, may be the occasion of tetanic symptoms which form the species denominated *traumatic*. Cases are on record (and are quoted by Dr. Symonds in the *Cyclopædia of Practical Medicine*, art. 'Tetanus'), wherein the patient was attacked with the disease in consequence of a bite on the finger from a tame sparrow; in which it supervened on the mere stroke of a whip-lash under the eyes, though the skin was not broken; in which it was occasioned by a small fish-bone sticking in the pharynx; by a slight solution of continuity in the external ear from a musket-shot; by the application of a seton to the thorax; by the stroke of a cane across the back of the neck; by a blow on the hand from the same instrument; by the extraction of a tooth, &c. In short, according to Sir James M'Grigor (quoted by Dr. Symonds), 'it occurs in every description and in every stage of wounds, from the slightest to the most formidable, from the healthy and the sloughing, from the incised and the lacerated, from the most simple and the most complicated.'

Next in frequency to wounds as an exciting cause of tetanus is exposure to cold and damp; indeed there are but very few cases of true idiopathic tetanus which are referrible to any other. The irritation of worms and other disordered states of the alimentary canal have been considered by some authors as the cause of tetanic affections. To generate this form of disease however, it would appear that a certain *predisposition* is also requisite, and it is doubtless the same with that which operates as an *accessory cause* of the traumatic tetanus. The predisposition to tetanic affections is given, in the first place, by warm climates and warm seasons. Within the tropics therefore it prevails to an extent unheard of in colder latitudes. Secondly, tetanus is chiefly observed to prevail when the atmosphere is much loaded with moisture, and particularly where this has suddenly succeeded to a long course of dry and sultry weather. Even in this country exposure to the cold and damp air of the night has occasionally been followed by an attack of tetanus. In tropical climates children are particularly subject to this complaint, and with a few peculiarities which, though producing no specific difference, have been thought sufficient to constitute a variety known by the name of *trismus nascentium*. The disease in this case is vulgarly known by the absurd name of *falling of the jaw*. It occurs chiefly between the ninth and fourteenth day after birth, and seldom after the latter period. Without any febrile accession, and often without any perceptible cause whatever, the infant sinks into an unnatural weariness and drowsiness, attended with frequent yawnings and with a slight difficulty of moving the lower jaw. This last symptom takes place in some instances sooner, in others later, and soon increases in intensity. Even while the infant is yet able to open its mouth, there is occasionally an inability to suck or swallow. By degrees the lower jaw becomes rigid, and totally resists the introduction of food. There is no painful sensation, but the skin assumes a yellow hue, the eyes appear dull, the spasms often extend over the body, and in two or three days the disease proves mortal.

The prognosis of this disease is mainly to be determined by the nature of the exciting cause, and by the type of the seizure. Tetanus of the idiopathic kind has certainly been cured in a larger proportion of cases than that which follows external injury, which 'is a fact well-known' (says an able writer in the 'Edinburgh Journal,' vol. xv., p. 292, quoted by Dr. Symonds) 'to every planter in the West Indies, who never considers his negroes as safe when the disease supervenes on a wound, but is frequently successful in alleviating the idiopathic species.' The type of the disease as acute or chronic is a no less important guide as to the probable termination. It may be said that recovery in a case of acute tetanus is almost, if not alto-

gether, hopeless: the chronic form however is milder character. The usual termination of it may be stated to occur on the third or fourth day; if the patient survives that time, there are good hopes of recovery: it is rarely protracted beyond the eighth day. Mr. Cooper however mentions, *Surg. Dict.*, the case of a patient (who had been wounded, and suffered a laceration of the thigh) who lingered five weeks with chronic tetanus before he died.

The dissection of patients who have died of tetanus has thrown little or no light upon the real nature of the complaint, as is indeed the case in almost all other neuralgic disorders. Sometimes slight effusions are found within the cranium, but in general no appearance whatever can be detected within the abdomen. There is always more or less of an inflammation in the œsophagus and in the villous coat of the stomach about the cardia. These appearances are common to a great number of diseases, and are formerly met with in every case of rapid or violent inflammation. Besides the redness and increased vascularity of the vessels, Baron Larrey found the pharynx and œsophagus contracted, and covered with a viscid reddish mucus. He also found numerous lumbrici in the bowels of the patients who died; but this, as Mr. Cooper remarks, could only be an accidental complication, and not a consequence of the disease. In several cases Dr. M'Arthur found the intestines inflamed; and in two of them a yellow wax-like substance of peculiar offensive smell, covered their interior. Whether the inflammation was primary, or a consequence of the pressure of the abdominal muscles which contract so violently in this disease, he is unable to say. (*Med. Chir. Trans.*, vol. vii., p. 475, quoted in *Surg. Dict.*)

The treatment of Tetanus is confessedly a matter of infinite difficulty, as the disease frequently resists every mode of practice, and, in certain instances, even well under the employment of the very best remedies which decidedly fail in other similar cases. In the whole it will probably be universally admitted that no effectual remedy for Tetanus has yet been discovered, and every plan has occasionally succeeded, and even failed, and still more frequently failed. The following is a summary of the opinions of the ancients on this point given by Adams in his Notes to 'Paulus Ægineta.'

Hippocrates (*Aphor.*, v. 70), Galen (*De Lib. lib. iii.*; *De Meth. Med.*, lib. xii.), Octavius (lib. ii., cap. 10), and Avicenna (lib. iii., sen. 2, c. 1) agree in stating that a fever coming on tends to aggravate the tetanic affection. Cælius Aurelianus (*De Lib. lib. iii., c. 6*) seems to question the truth of this aphorism. Hippocrates disapproves of the use of bloodletting in cases of traumatic Tetanus: Alexander Aphrodisias however speaks rather favourably of it (*Probl. i. 53*). Aëtius (lib. vi., c. 38), Oribasius (*Synops. c. 16*), and Nonnus (*De Medic.*, c. 38, l. 1) recommend the use of Ægineta (*De Re Med.*, lib. iii., c. 20), recommending emollient fomentations, and the bath of Asclepiades (ap. Aëtium, *loco cit.*) directs to prepare a decoction of Asclepiades by adding a fifth part of oil to the water.

The treatment recommended by Celsus (*De Lib. lib. ii., c. 1*) is judicious, and not unlike that of Ægineta. He expresses himself hesitatingly as to the propriety of a section, and forbids the early use of wine; he directs to open the belly. This practice is strongly recommended by Dr. Hamilton of Edinburgh.

The treatment of Aretæus (*De Cur. Morb. lib. i., c. 6*) is altogether soothing and relaxant. He commends to lay the patient upon a soft bed, and, from whatever cause the complaint arises, to begin with abstracting blood from the head, and to give soft liquid food is to be given, and the patient wrapped in wool moistened with some oleaceous matter. He directs to apply bladders half filled with tepid oil are to be applied to the parts most affected. He directs to cup the back of the neck, but cautions against exciting irritation by the application of heat. To the wound he recommends purgative applications containing frankincense, myrror, rosin, and the like; for he remarks (and the practice is confirmed by the experience of the late M. J. Mercurius) recommends a similar mode of practice. If tetanus supervenes, the sore becomes dry. He recommends assafœtida as anti-spasmodic; and, if

ed, they are to be given in an injection. He also gives hiera in an injection.

Aurelianus (*loco cit.*) enumerates nearly the same as Aretæus, and describes all the symptoms of tetanus with the greatest precision. His treatment is the same as that of Aretæus, namely, emollients to the neck, venesection, and oily clysters; he enjoins the bath of oil, which has fallen in modern practice, most probably solely on the expense with which it would be attended. He sometimes to use the common bath, but he allows wine in certain cases. He follows Hippocrates for giving both wine and emetics, and recourse to venesection, without due discrimination; he blames him also for recommending the affusion of water, inasmuch as he himself had pronounced injurious to the nerves, bones, &c. Galen how- in his Commentary upon this aphorism of Hippocrates (t. v. § 21), that cold in this case is not the cause of the benefit derived from this remedy, but the shock which it imparts to the system proves beneficial by rousing the vital heat of the patient. Hippocrates however, as he forbade the cold affusion in traumatic tetanus, Ægineta's opinion of this practice is justly in profession in general now entertains, after it has been another trial upon the recommendation of the late Sir John Ferriar. (See *Medical Reports*, and Larrey's *Mé- thode Chirurgie*, t. 1.)

Horatianus (*loco cit.*) recommends bleeding, emollients, purgative clysters, the tepid bath, and soporifics. The use of the last-men- tioned remedies does not appear to have been suf- ficiently understood by the ancients; at all events they do not seem to them in this case than the moderna.

The ancients enjoin nearly the same treatment as the moderna (*loco cit.*) and Mesue join the preceding in recommending strongly the use of castor and antispasmodics; and yet it is deserving of notice that modern surgeons do not repose much confi- dence in these. (See Sir James M'Grigor's com- munication in the *Medico-Chirurg. Transact.*, vol. vi.) All the others, praises the bath of oil. See also the *Pract. Med.*, c. 27 speaks of a bath prepared with emol- lients. Haly Abbas (*Theor.*, lib. ix., cap. 10, 11; *Pract.*, c. 31) describes minutely the two varieties of tetanus, one by repletion or inanition. For the former, he recommends purging with hot drastic purgatives, and the other by friction after it; he also approves of castor. For the latter variety he praises the affusion of plain water, barley, &c. have been boiled. He re- commends the internal use of milk and other demulcents, of oil, and rubbing the body with oil of violets. He also recommends by Alsharavius (*Pract.*, c. 21) is very similar. Rhazes mentions (*Divis.*, c. 1) Hippocrates' proposal of the bath of oil; but, like Paulus Ægineta, he rather dis- approves of it. He himself recommends bleeding; when necessary, when symptoms of repletion, emollient applications to the head, bath of oil, the application of leeches to the head, and purging with aloes, &c., and the adminis- tration of antispasmodics, such as castor, assafœtida, and

the use of opium. The principle of cure, as Dr. Good remarks, is to remove the local irritation, wherever such exists, and to relieve the nervous erethism of the entire system. The objects of these two objects is of great importance in tetanus, or trismus, of infants; for, by removing the acrimonious meconium, or whatever other- wise is in the stomach or bowels, we can some- times obtain a speedy cure without any other medicine.

For the best aperient on this occasion, and re- lieve both by the mouth and by injections. If these do not succeed, we should have recourse to opium: of these the best is opium, which is ad- ministered in doses of from three to five drops according to the age of the patient. Opium is more extensively resorted to in the cases of tetanus almost any other remedy; and Dr. Good, Dr. Ferriar, and others profess that it is that on which they chiefly, if not their only reliance. To give it a

fair chance of success, we must begin its use from the earliest appearance of tetanic symptoms. It must be given in very large doses; and these doses must be repeated at such short intervals as to keep the system constantly under the influence of the remedy. It is astonishing to observe how the human body, when labouring under a tetanic disease, will resist the operation of this and other remedies, which, in its healthy state, would have been more than sufficient to overpower and destroy it. It is advisable to begin with fifty drops of laudanum, and to repeat this at intervals of two or three hours, or even oftener if the urgency of the symptoms require it, until some effect has been produced on the spasms. In the early stage of the disease we are to bear in mind the approaching closure of the jaw and difficulty of deglutition; and our remedies are accordingly to be pushed before such serious obstacles to their administration arise. When they have occurred, and are found to be insuperable, opiate enemata and frictions may be tried; but we must not anticipate much benefit from such feeble means. Such are Dr. Gregory's remarks; but Dr. Symonds considers that the employment of opium is recommended chiefly by systematic writers, and for theoretical, rather than for practical reasons; while most of those who give the results of their own experience express the greatest dissatisfaction with the remedy.

Probably a much more efficient class of remedies than the preceding is that of purgatives; both on account of the obstinate costiveness which attends the disease, and also because we have in daily practice such convincing proofs of their strong revulsive influence on diseases of the cerebro-spinal centre. The testimony of the army physicians, as we learn from the report of Sir James M'Grigor, is highly in favour of a rigid perseverance in the use of purgatives, given in adequate doses to produce daily a full effect. Dr. Forbes states that a solution of sulphate of magnesia in infusion of senna was found to answer better than any other purgative; and it was daily given in a sufficient quantity to produce a copious evacuation, which was always dark-coloured and highly offensive; and to this practice he chiefly attributes in one severe case the removal of the disease. (*Med. Chir. Trans.*, vol. vi., p. 452, quoted by Mr. Cooper.) Dr. Good condemns drastic purgatives, forgetting apparently that mild ones have no effect. Strong cathartics have indeed frequently proved of great service, and none has higher repute than croton oil.

The employment of the warm bath has been recom- mended by numerous writers, but it would be difficult to trace in their accounts any facts which decidedly show that its adoption was ever followed by unequivocal benefit. Cold bathing has also been advised, but it has generally been found to be worse than useless; and there are several cases upon record of almost instant death having followed its employment.

The practice of bleeding is another that has been tried, but most frequently without effect. In some few cases amputation of the limb, from the injury of which the tetanus has arisen, has been successful; but as this extreme measure is also very uncertain, it is not likely to be ever extensively adopted.

Numerous other remedies have been tried, with no, or very imperfect, success; for instance, acupuncture, strychnia, mercury, caustics, blisters, tobacco, oil of turpentine, æther, camphor, musk, bark, wine, sesqui-oxide of iron, &c. &c. However, it must, after all these have been tried, be confessed that tetanus is one of the most formidable and unmanageable of disorders, and that recovery in the acute form still continues to be almost hopeless.

(Cooper's *Surgical Dict.*; Symonds, in the *Cyclop. of Pract. Med.*; Good's *Study of Med.*; Gregory's *Theory and Practice of Med.*; from which works most of the preceding remarks have been taken. A reference to numerous other works on the same subject will be found in Pleuquet's *Liter. Med. Digesta*; Cooper's *Surg. Dict.*; and Forbes's *Medical Bibliography*, in the *Cyclop. of Pract. Med.*)

TETBURY, an antient market-town in Gloucestershire, near the borders of Wiltshire, situated on elevated ground near the source of the Warwickshire Avon, 89 miles west by north from London, and 20 miles south-east of Gloucester. The parish, with four hamlets, contains a population of

2030, according to the census of 1831. The town consists of one long street intersected by two shorter ones, with the market-place and a spacious market-house in the centre. The streets are paved and lighted, and the houses built chiefly of stone. A bailiff and constable are annually appointed at the court-leet of the feoffees of the manor. There are fairs held three times a year, for cheese, cattle, sheep, horses, &c. The parish church, which was built soon after the Conquest, was taken down in 1794, with the exception of the tower, and rebuilt in the pointed style; and a modern spire was placed on the tower. The living is a vicarage, of the annual gross value of 903*l*. The Baptists and Independents have places of worship. In 1723 Elizabeth Hodges left a rent-charge of 30*l*. for the education of 15 children; and in the years 1783, 1795, and 1797, the sum of 100*l*. was left by three different persons for the support of a Sunday-school. In 1833 there were ten daily schools, attended by 173 children, and three Sunday-schools, at one of which, in connection with the Established Church, 174 children were instructed, and the other was a Baptist school, attended by 153 children. In the reign of James I., Sir William Romney, a native of the town, founded almshouses for eight poor persons, and left property for the endowment of a grammar-school. The traces of an antient encampment were visible on the south-eastern side of the town up to the middle of the last century; and at this spot fragments of British weapons and coins of the Lower Empire have been found.

TETHY. [SENNÆ.]

TETHYS. [NUDIBRANCHIATA, vol. xvi., p. 361.]

TETRABRANCHIATA, Professor Owen's second order of the class *Cephalopoda*. This order is equivalent to the 'Céphalopodes testacés polythalamés' of Lamarck; to the 'Polythalamacés' of De Blainville; the 'Siphonoides' of De Haan; and the 'Sifonifères' of D'Orbigny.

The following characters of the order are given by the Professor:—

Eyes, subpedunculate. *Mandibles*, calcareous at the apex. *Arms*, abbreviated, tubular, and furnished with retractile tentacles. *Mantle*, membranaceous, with two anterior apertures; a posterior membranaceous tubule running through the siphon of the multilocular shell. *Gills*, four. *Branchial heart*, null. *Excretory tube*, with the walls disconnected below. *Shell*, internal or external multilocular.

The genera comprised by Professor Owen under this order, in his *Memoir on the Pearly Nautilus* (1832), are—*Belemnites*, *Baculites*, *Lituola*, *Spirula* (?), *Ammonites*, *Orbulites*, *Nautilus*, *Cibicides*, *Rotalites*, &c.

In the *Cyclopædia of Anatomy and Physiology* (1836), Professor Owen modifies the views above given. In that work the *Tetrabranchiata* form the first order of the *Cephalopoda*, with the following synonyms: *Polythalamacés*, Blainville; *Siphonifera*, D'Orbigny; minus the *Spirulidæ* and *Belemnites*.

The *Tetrabranchiate Cephalopods* (of which the *Pearly Nautilus* may be regarded as the type) are described as provided with a large external univalve shell, symmetrical in form, like the body of the animal which it protects, straight or convoluted on a vertical plane, and divided by a series of partitions into numerous chambers, of which the last formed is the largest, and alone contains the body of the animal; a dilatible and contractile tube is continued from the posterior part of the animal through all the partitions and chambers of the shell; but the attachment of the shell to the body is effected by means of two strong lateral muscles which are inserted into the walls of the last chamber. The numerous hollow arms and retractile tentacles are peculiar to this order, and the head is further provided with a large ligamento-muscular plate or flattened disc, which, besides acting as a defence to the opening of the shell, serves also, in all probability, as an organ for creeping along the ground, like the foot of the *Gastropods*. There are no fins or analogous organs for swimming.

The following are the characters given in the *Cyclopædia of Anatomy* by the Professor:—

Jaws strengthened by a dense, exterior, calcareous coating, and with thick dentated margins. *Eyes* pedunculated and of a simple structure. No organ of hearing. *Gills* four in number and without branchial hearts. *Circulating system* provided with but one ventricle, which is systemic or propels arterial blood. No *ink-bag*. Inferior parietes of the funnel divided longitudinally.

The second order, *Dibranchiata*, has the following synonyms: *Cryptodibranches*, Blainv.; *Acetabulifera*, D'Orb.; plus the *Spirulidæ* and *Belemnitidæ*.

The *Tetrabranchiata* are divided into two families:

1. *Nautilidæ*: Genera:—*Nautilus*, Lam.; *Clypeus*, Müntz.; *Campulites*, Deshayes; *Lituites*, Breyn; *Orthoceratites*, Breyn.

2. *Ammonitidæ*: Genera:—*Baculites*, Lam.; *Hemula*, Parkinson; *Scaphites*, Parkinson; *Ammonites*, Brug.; *Turrilites*, Lam.

Of the *Dibranchiata*, Professor Owen remarks, that this order also had its representative in the era of the antient world, as the shells called *Belemnites*, or thunder-stones, the fossil shells of the *Sepiæ* discovered by Cuvier, and the horny rings of the acetabula found by Buckland in the coprolites, or fossil faeces, of *Irathyosaurus* testify; but, he remarks, our knowledge of this order is chiefly founded on observation of existing species. 'These,' says the Professor, 'are extremely numerous: they frequent the seas of every clime, from the ice-bound shores of *Boothia Felix* to the open main, and floating *Sargassum* or Gulf-weed of the Equator; they seem however to be most abundant in temperate latitudes. Many species frequent the coasts, creeping among the rocks and stones at the bottom; others are pelagic, swimming well, and are found in the ocean at a great distance from land.'

Professor Owen then adverts to the great variety of size presented by the *Dibranchiata*, remarking that although the bulk of the gigantic species has been undoubtedly exaggerated, yet the organization of this order is favourable to the attainment of dimensions beyond those presented by the individuals of any other group of invertebrate animals. He then alludes to the Uncinated *Calamary* caught by Banks and Solander in the southern ocean [SEPIADÆ, vol. xxi., p. 253], and to the fragment of the cephalopod weighing one hundred pounds obtained by the French naturalists in the Atlantic ocean under the line, and preserved in the Museum of the Garden of Plants at Paris.

The *Dibranchiate Cephalopods* are divided by Professor Owen into two tribes, the *Decapoda* and the *Octopoda*.

The *Decapoda*, besides the possession of ten, characterised by having a pair of fins attached to mantle; by having the funnel either adherent at tero-lateral parts of its base, and without an valve, or articulated at the same part by two socket joints to the mantle, and provided with a ventrally at its apex; by having fleshy append branchial hearts, and glandular appendages to ducts; by having generally a single oviduct with superadded glands; and lastly, by the shell or being single, mesial, and dorsal.

Professor Owen considers the *Decapodous* tribe that which is most nearly allied to the *Tetrabranchiata* order, and he regards *Spirula* as the type of the family of the *Decapodous* tribe, or that which succeeds the *Tetrabranchiata*.

The following are the families of the *Decapoda*—

1. *SPIRULIDÆ*: genus *Spirula*.

2. *Belemnitidæ*: genera, *Belemnites*, Lam.; *Actinoptera*, Miller; *Pseudobelus*, Blainv.

3. *Sepiadæ* (Cuttle-fishes): genus *Sepia*.

4. *Teuthidæ* (Calamaries); thus divided:—

A. Funnel with an internal valve, and articulated at its base to two ventro-lateral cartilaginous processes of the mantle.

Genera:—*Sepioteuthis*, Blainv.; *Loligo*, Cur.; *Ophichoteuthis*, Licht.; *Rossia*, Owen; *Sepioida*, Leach.

B. Funnel unprovided with an internal valve, and adherent at the antero-lateral parts of its base to the mantle.

Genera:—*Loligopsis*, Lam.; *Cranchia*, Leach.

Of the tribe *Octopoda* the Professor observes, that besides wanting the long tentacles, they are also limited by the want of mantle-fins, and consequently retrograde progression while swimming. acetabula, he adds, are sessile and unarmed, and two oviducts, but without detached glands for secretion: the *Decapods* have a single oviduct attached glands for secreting the nidamentum.

The *Octopods* are thus arranged by Professor Owen:—

1st Family, *Testacea*: genus *Argonauta*, Linn.

2nd Family, *Nuda*: genera *Octopus*, Leach; *E*

BELEMNITE; BELLEROPHON; CEPHALOPODA; GONIAITIS; NAUTILUS; PAPER NAUTHALAMACEA; SEPLADÆ; SPIRULIDÆ; TEU-

CEBRATA. [POLYBRANCHIATA.]

CHORD, the Greek name for any part of the string of four notes, the highest of which is a fifth to the lowest. Thus in the common diatonic scale we assume a knowledge of this article throughout) the following tetrachords:—

DEFG, EFGA, GABC, ABCD, BCDE.

air of giving anything like a satisfactory account of music; not that we think the difficulty lies with the writers, but in the manner in which they have proceeded. It was an assumption that the nation which produced such models as the moderns could not surpass in sculpture, and perhaps in painting, was to be regarded as necessarily possessed of a system of music to perfection. Their writers on the subject taken as having an agreement with each other, to be detected and established, any apparent discrepancy, however evident, notwithstanding. The speculations which were the objects of inquiry in the history of the parts of the scale gave the subject the character of a science; and explanations which required the assistance of the scholar, the mathematician, and the philosopher were undertaken by persons who were deficient in the science, if not in two. The consequence has been a mass of confusion as the world never saw in any age; writers whose undertakings required them to be exacting, copying absolute contradictions from their writers; others glad to adopt anything which appeared whether true or not; others again, unable or unwilling to state the simplest facts of their own knowledge; their readers are not even made aware which of the remarkable opposite opinions they mean to

adopt in the present article, without looking into the writings of a writer, to draw from Ptolemy and Euclid, who are known to be trustworthy on other subjects, the tetrachord that we can find to bear the test of certainty and precision, and to be likely to aid the reader in approaching, should it please him, to a mass of different accounts which have been

as seem agreed that the Greek scale, which at first consisted of only two or three leading consonances, was gradually enlarged until it comprehended two octaves, and was now called diatonic (a word which means the same as with the Greeks), was minor in its character in fact it would be represented by

C D E F G A¹ B¹ C¹ D¹ E¹ F¹ G¹ A¹.

It is known that the Greeks were early in possession of the art of dividing a string so as to produce their several notes, that, by the time of Ptolemy at least, they took advantage of the vibrations (on which they knew the length of the string to be inversely as the lengths of the

strings were numerous: three were considered as the primary, and were called *enharmonic*, *chromatic*, and *diatonic*; the two first words not having any special meaning as with us. The remaining scales had a special quality attached to them, Lydian, Dorian, &c. The distinction between these lay in the different modes of the octave, as seems to be now generally agreed, and we have been those who have thought that these names, &c., were the names, not of scales, but of modes. *Enharmonic*, *chromatic*, and *diatonic* scales, Ptolemy distinguished fifteen from his predecessors, and eight from each of them is an octave, and all of them are particular: first, each has the fourth and fundamental note perfect; secondly, each has been made by the fundamental note and its intervals in precisely the same manner as that of the diatonic octave. That is, if we call the notes of this

CPQFGKSC¹;

where C is the fourth, and CG a fifth, always; and the intervals, QF are severally equal to the intervals GK, thus it appears that the fourth was to the

Greeks what the octave is to us, the unit, as it were, of the scale, in the subdivision of which consisted the differences of their systems. We now give a tetrachord from each of these twenty-three scales, assigning the intervals first by the ratios of the vibrations, next by the number of mean semitones they contain, as in the article SCALE. We prefix the Latin rendering of Ptolemy's appellatives from Wallis.

And first as to *enharmonic* scales, which are mentioned first, and seem to have been ancient, and regarded with high approbation.

	Ratio of Numbers of Vibrations in each Interval.			Mean Semitones in each Interval.		
	CP	PQ	QF	CP	PQ	QF
Archytas	5 : 4	36 : 35	28 : 27	3·86	·49	·63
Aristoxenus } Eratosthenes }	19 : 15	39 : 38	40 : 39	4·10	·44	·44
Didymus	5 : 4	31 : 30	32 : 31	3·86	·57	·55
Ptolemy	5 : 4	24 : 23	46 : 45	3·86	·74	·38

It seems then that the *enharmonic* system would allow only of the following notes in an octave—

C E P F G B Q C¹;

where P means a note about half way between E and F, and Q one half way between B and C. An odd scale truly for a modern musician to look at; but, it may be, not incapable of pleasing effects to ears not accustomed to music in parts.

The *chromatic* scales come next in order, as follows:

	Ratio of numbers of Vibrations in each Interval.			Mean Semitones in each Interval.		
	CP	PQ	QF	CP	PQ	QF
Archytas	32 : 27	243 : 224	28 : 27	2·94	1·41	·63
Aristoxenus, mollis Chromatica	56 : 45	29 : 28	30 : 29	3·79	·61	·58
Do., Sesquialterius Chromatica	37 : 30	77 : 74	80 : 77	3·63	·69	·66
Do., tonici Chromatica Eratosthenes	6 : 5	19 : 18	20 : 19	3·16	·94	·88
Didymus	6 : 5	25 : 24	16 : 15	3·16	·71	1·12
Ptolemy, mollis Chromatica	6 : 5	15 : 14	28 : 27	3·16	1·19	·63
Ptolemy, intensi Chromatica	7 : 6	12 : 11	22 : 21	2·67	1·51	·80

To make something as like as we can to these scales, we should write down in modern music

C E^b Eⁿ F G B^b Bⁿ C¹

The *diatonic* scales, Ptolemy allows, are more agreeable to the ear, and his specimens are as follows: we shall now write the scale with the usual letters throughout.

	Ratio of numbers of Vibrations in each Interval.			Mean Semitones in each Interval.		
	CD	DE	EF	CD	DE	EF
Archytas	9 : 8	8 : 7	28 : 27	2·04	2·31	·63
Aristoxenus, mollis diatonica	7 : 6	38 : 35	20 : 19	2·67	1·43	·86
Do., Intensi Diatonica	17 : 15	19 : 17	20 : 19	2·17	1·93	·88
Eratosthenes*	9 : 8	9 : 8	256 : 243	2·04	2·04	·90
Didymus	9 : 8	10 : 9	16 : 15	2·04	1·82	1·12
Ptolemy, mollis Diatonica	8 : 7	10 : 9	21 : 20	2·31	1·82	·85
Do., tonici Diatonica	9 : 8	8 : 7	28 : 27	2·04	2·31	·63
Do., intensi Diatonica	10 : 9	9 : 8	16 : 15	1·82	2·04	1·12
Do., aequabilis Diatonica	10 : 9	11 : 10	12 : 11	1·82	1·65	1·51

These scales have all so far the *diatonic* character that they divide the tetrachord into two larger intervals followed by a smaller one: the scale of Didymus would have been exactly the modern untempered diatonic scale, if he had inverted the order of the two larger intervals in his second

* This is also Ptolemy's Diatonic Diatonica.

tetrachord. As to the other modes, the Dorians, &c., there is much confusion in Ptolemy respecting them, arising from the corruptness of the text, which Wallis has endeavoured to remedy. According to him, they are divisions of the octave, somewhat more fantastic than those which precede. In more recent times the idea has been started of their being simply different keys, or rather answering to different variations of the diatonic scale, by using intermediate semitones instead of some of the notes: it would be difficult, we think, to produce authority enough for this conjecture.

If it were true, as supposed, that the two octaves of the Greek scale, beginning, say with A, were minor, it would follow that Ptolemy, in his diatonic scales, exhibited the octave from C to C¹, as we have supposed. Accordingly, the principal mode of exhibiting the formation of the octave from two tetrachords and a tone would be the one we have taken, namely,

(C D E F) (G A B C¹)

But it is frequently supposed that it was the following:

C { D E F (G) } A B C

or the following—

A { B C D (E) } F G A.

On this point we shall only say that there never was, we believe, so strong a union of the three characters of scholar, mathematician, and musician, as was seen in Dr. Smith, the author of the Harmonics. He had studied the Greek scale attentively, and to him the first of these methods was a matter of course. 'The Greek musicians' (*Harmonics*, 1749, p. 45), 'after dividing an octave into two-fourths, with the diatonic or major tone in the middle between them, and admitting many primes to the composition of musical ratios, subdivided the fourth into three intervals of various magnitudes placed in various orders, by which they distinguished their kinds of tetrachords.'

We do not, we confess, though admitting that it is exceedingly hard, and probably impossible, to reconcile the Greek writers with themselves and each other, find that sort of difficulty which Dr. Burney owned to, when he said that he neither understood those writers himself, nor had met with any one who did. He was a musician, and was looking out for an intelligible mode of arriving at and distributing the most agreeable concords, with a strong predetermination to arrive at musical truth or nothing. But the Greek writers were arithmeticians, with as strong a determination to find natural foundations in integer numbers: they did not ask how to find sounds which would best suit the ear, but how to discover triplets of fractions which multiplied together should produce four-thirds of a unit. Pleased with the simplicity of the ratios which give the fourth, fifth, and octave, their efforts at musical improvement were confined to the attempt at discovering magic numbers to fill up the intervals. It was not until one of these philosophers had laboured at his abacus, and tasked his metaphysics to find *a priori* confirmation of some question in arithmetic, that he strung his monochord and tried how his scale sounded: it would have been hard indeed if his ear had refused to sympathize with his brain. In all probability the musicians, whose object was simply to please, laughed at the arithmeticians, as Tycho Brahé did at Kepler, when the latter had discovered reason for the distances of the planets in the properties of solid bodies: they had motive enough, and, beyond all question, reason more than enough.

TETRACHORD (*τετραχορδον*, 'four-stringed'), in the music of the Greeks, was a system of four sounds,—as, for example, the diatonic tetrachord, c, d, e, f; the chromatic, c, c♯, d, e; and the enharmonic, c, c♯, d♭, e. The antients proceeded from the key-note to the octave by two conjoint tetrachords; and so far as the diatonic scale is concerned, they and the moderns agree. In what relates to the two other scales, so little is accurately known, and the subject is so unimportant, to either the general or the musical reader, that we should not further enter on it, even if the space allotted to our department allowed of extension. [GENERA; MUSIC, HISTORY OF.]

TETRADYNAMOUS (from *τετρας*, four, and *δυναμις*, power), a botanical term employed by Linnæus to indicate the character of those flowers which, possessing six stamens, have two of them shorter than the other four. This peculiarity is found exclusively in the plants belonging to the

natural order Cruciferae. Hence the Linnaean classification, including only plants with the stamens: in this manner, is an exceedingly natural one, and the few instances in which a peculiarity in the prevails throughout a whole family. *Didymum* term which expresses the existence of four stamens of which are short and two long. This character a great number of natural families, as Labiatae, Lamiaceae, Bignoniaceae, &c., and is always throughout a family where it exists. The Linnæan Didymia is founded on this peculiarity of the

TETRAGON (properly a four-angled figure usually applied to the square only, when used, seldom is. [REGULAR FIGURES.]

TETRAGONIA'CEÆ, a natural order of plants by Lindley in his Curvembryose group of incompletely developed. It includes the genera *Tetragonia*, *Suvium*, and *Miltus*, which are generally placed in the order Ficoideae or Mesembryaceae. The reason Dr. Lindley for this separation is the want of petals in the Mesembryaceae is of too powerful to admit exception. The relation of these apetalous to Chenopodiaceae is so strong, that Dr. Lindley there is no character to distinguish them, except the ovary being formed of several carpels.'

Like Ficoideae, this order possesses thick leaves, which in many of the species might be substituted for spinach. The *Tetragonia* is native of New Zealand and Japan, and is used by natives of those countries as a remedy in the cutaneous disease called scurvy. It might be used in cookery instead of spinach. The *Asplenium canariense* and *A. hispanicum* grow on the sea-coasts of the Canaries and Spain, and are amongst the plants which after burning.

TETRAGONOLOBUS from *τετραγωνος*, four, and *λοβος*, lobe), a genus of plants belonging to the natural division of the natural order Leguminales herbs with broad leafy stipules, trifoliate petioles, alternate leaflets and flowers seated on peduncles, furnished with a bract. The calyx is tubular, the wings shorter than the vexillum; the stigma is cylindrical and beaked; the legume is cylindrical, with four foliaceous wings which give it a 4-lobed appearance.

T. purpureus (purple winged-pea) is a prostrate decumbent stems, entire obovate leaflets, less than the calyx, and a glabrous legume, with globular seeds. It is a native of the south of Europe, and has dark flowers; a variety is, however, found with a dark yellow colour.

There is also a variety called *T. p. minor*, in which the stem, leaves, and legumes are much smaller. In some regions, where this plant grows in perfection, the legumes are cooked and eaten in the same manner as French beans.

There are four other species of *Tetragonolobus* which are inhabitants of Europe. In general appearance they very much resemble the species of *Bursera* (*Lotus*), and in gardens are well adapted for rock-work. They are best propagated by seeds.

TETRAHEDRON (a solid of four faces) is applied to the regular tetrahedron. [REGULAR TETRAHEDRON.]

TETRAOGALLUS, Mr. J. E. Gray's name for a family of birds, placed by Mr. G. R. Gray in the subfamily *phorinæ*, of the family *Phasianidae*. Example, *Gallus Nigollis*. (*Ill. Ind. Zool.*)

TETRAONIDÆ, Dr. Leach's name for a family.

Linnæus, in his last edition of the *Systema Naturæ*, places the genus *Tetrao* at the end of his fifth lineæ, next to the genus *Numida*. The *Gallus* between the *Grallæ* and the *Passeres*, the genus is the last of the order *Grallæ*, and the genus is the first of the order *Passeres*.

The Linnaean genus *Tetrao* is very extensive, and not only the true Grouse, but also the Franciscan Grouse, and Quails.

Cuvier, in his last edition of the *Règne Animal*, places the *Tetrao* (under his fourth order) under the *Tetrao* (Linn.) under his fourth order *nacés* (*Gallinæ*, Linn.), placing them between

Phasianus Linn.) and the Pigeons (*Columba*

great genus in the arrangement of Cuvier is more nensive even than that of Linnæus, for it includes wing subgenera:—1. *Les Coqs de Bruyère* (*Tetrao*); 2. the *Lagopèdes*, or Snow Partridges (*Perdix neige*); 3. the *Ganga*, or *Attagen* (*Pterocles*); 4. the *Partridges* (*Perdix*, Briss.); comprising the ordinary Partridges, the Quails, and the Partridges and Quails of America; 5. the *Tripterygiæ* (*Lacép.*, *Hemipodius*, Temm.), including *Turnix*, *Ortygis*, Ill.), and *Syrhaptæ*, Ill.; 6. The *Tinamidae*, Lath., *Crypturus*, Ill., *Ynambus*, D'Azara. The last subgenus Cuvier remarks that some, the *Pezus*, have still a small tail hidden under the feathers; others, the *Tinamus* of Spix, have no tail at all; and others are placed a little farther backward; and that one should distinguish *Rhynchotus* of Spix, has the bill stronger, without any furrow, slightly and depressed, with the nostrils pierced towards its

Vigors places the *Tetraonidæ* among the *RASORES*, and that the groups which form the family are distinguished in modern systems from those of the *Struthionidæ* by their more simple appearance; by the fact of those ornaments to the plumage, and the uncarunculated appendages to the cheeks and the bill, which are in the present to the mere space that encircles the bill; and by the weaker conformation of the hinder toe. Mr. Vigors observes, further to separate them; for in the *Tetraonidæ* becomes shorter and weaker, until it is completely lost in some of the species. Thus viewed, Mr. Vigors is of opinion that the *Tetraonidæ* occupies an intermediate station between the *Phasianidæ*, where the hind toe, although high on the tarsus, is yet comparatively strong, and the *Struthionidæ*, where it is generally, if not always, wanting. He further remarks that the groups which compose the *Tetraonidæ*, corresponding with those that form the *Tetrao* of Linnæus, seem to be immediately related to the preceding family by means of the genus *Ortyx*, Temm., which resembles them in the similarity of the plumage of the head. This group, he leads directly to *Coturnix*, Briss., and the true *Ortyx*, where it has, he observes, been generally arranged, which it has been chiefly separated by the deficiency of a nail to the hinder toe. From *Perdix* Mr. Vigors proceeds to *Pterocles*, Temm., which, by its half-tarsus, is intermediate between that genus and the *Tetrao*. By means of *Lagopus*, Cuv., in which the bill as the legs are feathered, Mr. Vigors arrives at the singular genus *Syrhaptæ*, Ill., which is immediately connected with *Ortygis* of the same author by the deficiency of the hind toe. With these groups, in addition, on the genus *Tinamus*, Lath., corresponds by the information of the same member, the joint of the bill, feeble and the nail scarcely developed. This leads him back again to *Cryptonyx*, which has no joint of the hinder toe. The whole of these united groups, thus united, correspond also, Mr. Vigors observes, in the shortness or weakness of their tails. The *Tetraonidæ* which exhibit a weakness or deficiency of the hinder toe, lead Mr. Vigors to the three orders of the *Struthionidæ*, with the bills of which, particularly that of *Rhea*, those of some species of which, he observes, correspond. (*Natural Affinities and the Orders and Families of Birds*, in Linn. ol. xiv.).

Vigors makes the *Tetraonidæ* form the third order of the *Rasores*, and states that it is composed of the Grouse, and Quails; all of which agree in the shortness of their tails and of their hind-toe: also, he observes, remarkable for a total want of tail-feathers; and a plumage which so eminently characterises the *Tetraonidæ*, between which family and the *Struthionidæ* places the *Tetraonidæ*. The genus *Cryptonyx*, he remarks, as a small group of Oriental birds highly beautiful in their elegant form and the texture of their feathers, has been thought to connect the two; a supposition, by no means improbable, yet requiring a proof. He then notices, as following these, the those of the colder latitudes, he adds, constitute

the genus *Tetrao*, while *Pterocles* includes such as inhabit the arid sands of Africa and Southern Europe. The northern parts of our empire, he observes, still furnish us with several species; but he laments the extermination in Britain* of the largest and most noble grouse of Europe the cock of the rock (cock of the wood must be meant).

Mr. Swainson goes on to point out how sometimes the side feathers on the neck of the male grouse are developed in a singular manner, so as to resemble little wings—a character mostly confined to the American species (*Tetrao Umbellus* and *Cupido*). He also adverts to the several new additions to this group brought home by the expedition under Captain (now Sir John) Franklin. The African and Indian Grouse (*Pterocles*) have, he remarks, frequently very pointed tails, and the hind-toe is very small: heat with them, he observes, appears to be as essential as cold to the true grouse. But he notices one species, *Pt. setarius*, Temm., which extends its range to the South of France. He then proceeds to point out that nearly all the Grouse have the toes and legs more or less covered with soft feathers; but that this character disappears in the Partridges—an extensive group scattered over nearly all parts of the Old World, but unknown in the New, where they are represented by the genus *Odontophorus*, Vieill. In the Quails, he observes, we have the miniature resemblance of Partridges, but the tail is so short as to be nearly imperceptible. Closely approaching to the true quails, we have, he remarks, the genus *Hemipodius*, distinguished by the total absence of the hind-toe; and he adverts to the extreme pugnacity of these little birds, a disposition taken advantage of by the Javanese and other Indian nations with whom quail-fighting is even a more fascinating amusement than cock-fighting is, or rather was—for we are happy to say it is much on the decline—in Europe.

Mr. Swainson then calls attention to that singular race of birds in Tropical America called *Tinamus* by some of the Brazilians, and *Ynambus* by D'Azara. With scarcely any tail, their body is thick, and Mr. Swainson remarks that their whole appearance reminds the observer of a pigmy Bustard, which group, he thinks, they probably represent in the New World. 'As for their flesh,' says Mr. Swainson in conclusion, 'we have often tasted it, and consider it both in whiteness and flavour infinitely above that of the partridge or pheasant. We believe these birds never perch, as some suppose, but that they live entirely among herbage, principally in the more open tracts of the interior.' (*Classification of Birds.*)

In the Synopsis at the end of the volume, Mr. Swainson places the *Tetraonidæ* in the same relative position as that above assigned to them. He thus defines the '*Tetraonidæ*, Partridges and Grouse:—'Bill and tail very short. Hal-lux elevated;' and he comprises under the family the following genera and subgenera:—

Cryptonyx, Temm.; *Odontophorus*, Vieill.; *Ortygis*, Ill.; *Tetrao*, with the subgenera *Tetrao*, Linn., *Lagopus*, Willughby, *Lyrurus*, Sw., *Pterocles*, Temm., and *Centrocercus*, Sw.; *Perdix*, Briss., with the subgenera *Perdix*, *Chaotopus*, Sw., *Coturnix*, Briss., *Ptilopachus*, Sw., and *Ortyx*, Steph.; *Crypturus*, Ill., with the subgenera *Crypturus* and *Nothurus*, Wagl.

The Prince of Canino, in his *Birds of Europe and North America*, makes the *Gallinæ* the third order of his second subclass, *Grallatores*; and this order comprises the families *Pteroclidæ*, *Phasianidæ*, *Tetraonidæ*, and *Crypturidæ*. The order next in succession to the *Gallinæ* is formed by the *Grallæ*.

The *Pteroclidæ* include the following subfamilies and genera:—

1. Syrrhaptinæ.

Genus, *Syrrhaptæ*, Ill.

2. Pteroclinæ.

Genus, *Pterocles*, Temm.

* See the article CAPRECAILLIE. The attempt at reintroduction has since been followed up with every prospect of success by the patriotic Marquis of Breadalbane. In 1838, and the early part of 1839, that nobleman received at his seat in Scotland forty-four of these magnificent Grouse: they were all old-seasoned birds, and about two-thirds of them were hams. They were collected in Sweden with great pains and expense by Mr. L. Lloyd. Mr. Powell Buxton presented them to Lord Breadalbane. His Lordship turned out part into the forest, and retained another portion in a large aviary. Both experiments succeeded, and it was ascertained that seventy-nine young birds had been hatched out in the season of 1839. Forty-nine were hatched out in the aviary by Grey Hens (females of Black Grouse).

In 1838 three were sent to the Duchess of Athol at Blair, and seven were forwarded to the Earl of Derby at Knowlesley, where five young birds were hatched in the aviary in the summer of 1839: four of these were doing well when last heard of.

The *Tetraonidae* comprehend the following subfamilies and genera:—

1. *Percinæ*.

Genera, *Lophortyx*, Bonap.; *Ortyx*, Steph.; *Franco-linus*, Brisson; *Perdix*, Bonap.; *Sterna*, Bonap.; *Coturnix*, Temm.; *Bonasia*, Bonap.; *Tetrao*, Linn.; and *Lagopus*, Vieill.

The *Crypturidae* consist of the subfamily *Ortyginæ* and the genus *Ortyx*, Ill.

Mr. G. R. Gray, in his *List of the Genera of Birds*, arranges the *Tetraonidae* between the *Phasianidae* and the *Chionidae*, with the following subfamilies and genera:—

1. *Percinæ*.

Genera, *Rhizothera*, G. R. Gray; *Ptilopachus*, Sw.; *Ithaginis*, Wagl.; *Lerua*, Hodgs.; *Pternistes*, Wagl.; *Franco-linus*, Brisson; *Chacura*, Hodgs.; *Perdix*, Antiqu.; *Arborophila*, Hodgs.; *Coturnix*, Antiqu.; *Rollulus*, Bonn.; *Odontophorus*, Vieill.; *Ortyx*, Steph.; *Lophortyx*, Bonap.; *Callipepla*, Wagl.

2. *Tetraoninæ*.

Genera, *Tetrao*, Linn.; *Lyrurus*, Sw.; *Bonasa*, Brisson. (*Bonasia*, Bonap.); *Centrocercus*, Sw.; *Lagopus*, Brisson.

3. *Pteroclinæ*.

Genera, *Pterocles*, Temm.; *Syrphantes*, Ill.

Mr. G. R. Gray gives the synonyms of all these genera, and sufficiently numerous they are. The same author, in his Appendix, states that *Chacura* should have before it *Caccabis*, Kaup; and directs the reader to add near the genus *Alectoris*, Kaup, *Tetrao*, Gm.; also to add the genus *Oreias*, Kaup. He further remarks that *Ocyptes* is synonymous with *Thinocorus*.

We shall endeavour to illustrate this article with examples of the natural history of the grouse properly so called: an account of some of the leading forms of the family, taken in its more extensive sense, will be found under the respective titles.

EUROPEAN GROUSE.

The following species are European:—*Tetrao Urogallus*, the *Capercaillie*, or *Cock of the Wood*; *Tetrao hybridus*, Sparbm. (*Tetrao medius*, Meyer), the *Hybrid Grouse*, generally considered by ornithologists to be a hybrid between the *Capercaillie* and the *Black Cock*; *Tetrao Tetrix* (genus *Lyrurus*, Sw.), the *Black Grouse* or *Black Cock*; *Bonasia Europaea*, the *Hazel Grouse* or *Gelinotte*; *Lagopus Scoticus*, the *Red Grouse*; *Lagopus mutus*, the *Common Ptarmigan*; *Lagopus terrestris*, the *Rock Ptarmigan*;* *Lagopus saliceti*, the *Willow Ptarmigan*; *Lagopus brachydactylus*, the *Short-toed Ptarmigan*; *Pterocles arenarius*, the *Sand-Grouse*; *Pterocles setarius*, the *Pin-tailed Sand-Grouse*.

Of these the *Black Cock*, the *Red Grouse*, and the *Common Ptarmigan* are British; to which we trust that we may now add the *Capercaillie*, restored by the praiseworthy care of the Marquis of Breadalbane and others.†

We select as an example the *Common Ptarmigan*, *Lagopus mutus*.

Description—Winter Plumage (Male).—Pure white; a black band proceeding from the angle of the bill and traversing the eyes; lateral tail-feathers black, terminated by a white border; feet and toes well covered with woolly feathers; above the eyes a naked space, which is terminated by a small dentilated membrane; these naked parts are red; claws hooked, subulate, and black; bill black; iris ash-coloured. Length about fifteen inches and a quarter.

Winter Plumage (Female).—Differing from that of the male in having the naked space above the eyes less, and no black eye-band. Smaller than the male; the length about fourteen inches and a half.

Perfect Summer Plumage (Old Male).—Top of the head, neck, back, scapulars, and the two middle tail-feathers, as well as the upper coverts, rusty ash crossed by numerous zigzags of deep black; breast and sides variegated with feathers of the same colour, among which are always found a great number of feathers of a deep black varied with some scattered zigzags of a bright rust-colour; black eye-band always distinctly marked; throat most frequently white, but often marked with blackish; the whole of the belly, abdomen, lower coverts of the tail, wings, wing-coverts, and feet pure white; eye-brows large, of a very lively red.

* But see post.

† Ante, p. 266 (note).

Female always distinguished by the total absence of black eye-band, and to be recognised also by her plumage, which has less white; the head and parts of the body, the neck, the breast, the abdomen streaked with transverse bands of white and black, with a good deal of regularity; only of the belly, the feet, and the wings are pure white.

The *Young* are marked with very fine, black and rusty streaks. (Temm., &c.)

N.B. The bird figured by Mr. Gould, in his *The Birds of Europe*, under the name of *Lagotis*, *The Rock Ptarmigan*, with great doubt by ornithologists as to its identity with the North species, appears, according to Temminck, to be *Ptarmigan* in her perfect summer plumage.

The *newly-hatched young*, according to Mr. Ray, are covered with a light yellowish-grey down on the back with brown, and have, on the top of the head, a light chestnut mark, edged with darker colour. When first fledged they are, he says, very similar to the *Red Grouse*, but banded and spotted with reddish-yellow: but this plumage, he says, is so that in the beginning of August many of the brown feathers of the back are exchanged for white and barred with pale grey and brown, and the wings are white as well as the wings. In conclusion, that these young birds become white the first of the old ones. (*History of British Birds*.)

This *Ptarmigan* is supposed by some, and reason, to be the *Lagopus* of Pliny (*Nat. H.* 48), who notices its excellent flavour, and states that their 'hare-like hair' gave the bird its name; the *Tetrao lagopus* of Linnæus; *Lagopus tinnunculus*; *Pernice de Montagna*, *Pernice alpestris*, *bianco* of the modern Italians; *Perdrix à note blanche* of the French; *Perdiz blanca* or *Schneehuhn* and *Haasenfussige Waldhuhn* of the Germans; *Rype* of the Norwegians; *Riupharre* (female) of the Icelanders; *Tarmachan of Gael*; and *Coriar yr Alban* of the Welsh.

Geographical Distribution.—North of the British Isles, Norway, Sweden, Russia. The Alps, the middle and south of Europe. North of the islands lying in the south-west of Baffin's high hills keeping near the snow-line; C (Franklin; Richardson).

In the British Islands it was formerly found in the north of England, and, as its Welsh name indicates, but it no longer occurs in those localities, nor met with in Ireland.

Mr. Macgillivray (*History of British Birds*) states that it inhabits the bare and weather-beaten higher mountains of the middle and northern Scotland; but, he adds, that even in the north of the south of that part of the United Kingdom the mountains of which, being more than two feet high, seem well adapted for it, no individual was met with. 'I have frequently,' says this observer, 'chased it on Ronaval and Corrie Harris; and it is said to occur on Each Uist, on the Park and Uig hills in Lewis, on the Strath mountains in Skye, as well as in the mountains of the north of Scotland. On all the elevated summits of the north of Scotland it is not uncommon; and, on most of the Grampian mountains, especially the great granite and slaty masses from the sources of the Dee, the Spey, and the Tay, it is said to be even abundant. Great numbers are killed, but as the haunts of this *Ptarmigan* are not so accessible as those of the brown species (*Lagopus lagopus*) it is not at all likely to be exterminated.'

Food, Habits, &c.—The summer food of the *Ptarmigan* consists principally of Alpine berries, and in the winter of young heath. Mr. Macgillivray found that it crops a large quantity of fresh green twigs of *Cyanus*, *Vaccinium Myrtillus*, and *Empetrum* in the largest fragments not exceeding five-twelfths of an inch in length. He adds, that leaves and twigs of *Vitis-idaea*, *Salix herbacea*, seeds of various *Cyperaceæ*, and other plants, with berries in autumn form part of their food, which is thus, he observes, most part the same as that of the *Red Grouse* and the *Brown Ptarmigan*.

The author last quoted gives the following

bits of this species from personal observation: autiful birds, while feeding, run and walk among er-beaten and lichen-crusts fragments of rock, h it is very difficult to distinguish them when in motionless, as they invariably do should a in sight. Indeed, unless you are directed to a spot by their strange low croaking cry, which compared to the harsh scream of the missel-it which seems to me much more like the cry of a may pass through a flock of Ptarmigans with- ing a single individual, although some of them e ten yards distant. When squatted however they und, their object being to conceal themselves; discover the one from which the cry has pro- u generally find him on the top of a stone, ready off the moment you show an indication of hos- you throw a stone at him, he rises, utters his is immediately joined by all the individuals hich, to your surprise, if it be your first renco- e spring up one by one from the bare ground. rally fly off in a loose body, with a direct and rapid flight, resembling, but lighter than, that vn Ptarmigan, and settle on a distant part of the or betake themselves to one of the neighbour- ts, perhaps more than a mile distant.'

r it appears that these birds associate, forming fly or more; and it is also stated that, during , they burrow under the snow, thus giving coun- the statement and cut of Olaus Magnus, copied showing that the 'Urogalli minores' lie hid : ' to be sure, this retirement is said to be of duration—two or three months, and 'sine cibo.' McGillivray states that early in the spring the ; separate and pair. He describes the nest as llow, scantily strewn with a few twigs, and stalks f grass; the eggs, as regularly oval, about an ven-twelfths in length, and an inch and from one fths across, white, yellowish-white, or reddish, d spotted with dark brown, the markings being n those on the eggs of the red grouse. He the young run about as soon as they leave the re, from the first, so nimble and expert at com- emselves, that a person who has accidentally th a brood very seldom succeeds in capturing one. bird it seems has recourse to the same strata- e partridge and other gallinaceous birds to lead r from her little ones. 'On the summit of the intains,' says Mr. Macgillivray, 'I once hap- troll into the midst of a covey of very young , which instantly scattered, and in a few seconds l among the stones, while the mother ran about w yards of me, manifesting the most intense d pretending to be unable to fly. She suc- effectively in drawing my attention to herself, l at last began to search for the young, not one uld be found, although the place was so bare ight have supposed it impossible for them to ction.'

cies has been reared in confinement without ificulty, and has bred in a tame state. (Selby.) e must have observed the numbers of Ptarmigan sent to this country early in the spring. The any of the London poulterers are then positively them. These are imported from the north of ere they are principally taken in snares made of

Mr. Yarrell states that he has more than once r noose round the neck of Norway Ptarmigan don market, and that others have found the e numbers taken are immense. According to whom we have so often had occasion to quote, it will set from five hundred to a thousand of s in the winter season. The captured birds are frozen state till the dealers come; and one of ers will sometimes buy and sell fifty thousand in a season. According to the calculation of de Capell Brooke, sixty thousand of these birds l during one winter in a single parish, which was rge. Mr. Grant informed Mr. Yarrell that he d, when in Norway, that the number of ptar- ed in that country every winter was beyond o thousand dozen, if Mr. Grant remembered e quantity exported from Drammen in one ship d in 1839, and great numbers, he adds, are sent ., No. 1520.

to the Copenhagen market. Mr. Yarrell goes on to state that besides those brought to this country from Drammen, great quantities are also received in London, during the months of February, March, April, and May, from Bergen, Drontheim, and other ports on the west coast of Norway, from whence conveyance is obtained for them in the boats which bring constant supplies of lobsters to the London market. 'On one occasion,' says Mr. Yarrell, 'late in the spring of 1839, one party shipped six thousand ptarmigan for London, two thousand for Hull, and two thousand for Liverpool; and at the end of February or very early in March of the present year, 1840, one salesman in Leaden-hall market received fifteen thousand ptarmigan that had been consigned to him; and, during the same week, another salesman received seven hundred capercaillies and five hundred and sixty black grouse.'



Common Ptarmigan in winter and summer plumage. (Gould.)

ASIATIC GROUSE

We select the *Pin-tailed Sand-Grouse*, *Pterocles setarius*, *Gunga Gata*, as an example.

Description.—*Old Male.*—Throat black; sides of the head and front of the neck yellowish-ash; on the breast a large cincture, about two inches, of rusty orange, bordered above and below by a narrow black band; head, nape, rump, and tail-coverts streaked with black and yellowish; back and scapulars streaked in the same way, but towards the end of each feather there is a large band of bluish-ash, succeeded by another of a yellowish colour; lesser and middle wing-coverts marked obliquely with chestnut-red, and terminated by a white crescent; greater coverts olive-ash, terminated by black crescents; belly, sides, abdomen, thighs, and extremity of the lower coverts of the tail pure white; tail-feathers terminated with white, and the external one bordered with that colour; the two middle feathers, which are very long, slender, and of loose texture, are three inches longer than the others. Total length, without reckoning the long tail-feathers, 10 inches 6 lines.

Female differing much from the male; throat white; below this part a large black semicollar, which only extends to the sides of the neck; the cincture large and orange-coloured as in the male; upper parts nearly the same; middle, lesser, and greater wing-coverts bluish-ash, then an oblique reddish band, and all the feathers terminated by black crescents; the two long tail-feathers or filaments are longer than the others by an inch and six lines.

Young before their first moult.—Plumage less variegated; upper parts olive clouded with ash; the white of the sides, the thighs, and the abdomen is barred with yellowish and brown zigzags. (Temm.)

Geographical Distribution.—Very numerous on the arid plains of Persia. Not very numerous in France, on the sterile 'Landes' near the Pyrenees, and along the coasts of the Mediterranean; less common in Provence and Dauphiné, where they occasionally arrive; more common in Spain, Sicily, Naples, and throughout the Levant. Temminck, who gives these localities, states, in the fourth part of his *Manuel*, second edition, that it is common in Provence, in the uncultivated plains of Crau, and says that it avoids cultured tracts, and only inhabits the sterile Landes of the south; but he adds that it is abundant in the Pyrenees, and that it is to be found all the year round in the markets of Madrid. Mr. Gould states that the species is found in the North of Africa.

Food, Habits, &c.—Seeds, insects, and the young shoots
Vol. XXIV.—2 L

or plants form the food of this sand-grouse: but its wild nature and the barren places which it frequents are adverse to observation; and little or nothing is known of its habits. The nest is a hollow in the earth, and, according to Temminck, the eggs, nearly of the same size at each end, of an Isabella grey, marked with small brown points and large black patches, are only two or three, a small number compared with those of the majority of the *Tetraonidae*.



Pin-tailed Sand-Grouse, male and female. (Gould.)

AFRICAN GROUSE.

Dr. Andrew Smith remarks, that though we find species of *Pterocles* beyond the confines of Africa, yet the majority of those now known are peculiar to that quarter of the globe. The regions south of the equator, he observes, have furnished nearly as many species as those to the north of it; and he thinks that both will doubtless afford many additional ones when the yet unknown districts shall have been thoroughly explored. Each of the known species, as far as his observations go, has a limited range; and should the range of such as inhabit the unexplored tracts of the interior not be greater, he is of opinion that we may in time expect great additions to the following list of known species which he gives:—

Pterocles arenarius, Temm., Barbary and Senegal; *Pterocles guttatus*, Licht., Egypt; *Pterocles quadricinctus*, Temm., Senegal; *Pterocles coronatus*, Licht., Nubia; *Pterocles Lichtensteinii*, Temm., Nubia; *Pterocles tricinctus*, Swain., Senegal; *Pterocles exustus*, Temm., Egypt and Senegal; *Pterocles Tachypetes*, Temm., South Africa; *Pterocles bicinctus*, Temm., South Africa; *Pterocles simplex*, Roux, South Africa; *Pterocles maculosus*, Burchell, South Africa; *Pterocles gutturalis*, Smith, South Africa. It will be seen that *Pterocles setarius*, to which Mr. Gould assigns North Africa as a locality, is not in Dr. Smith's list.

We select as an example *Pterocles gutturalis*, Smith.

Description.—*Male*.—Top of the head dull green, faintly freckled with black; sides of the head and chin straw-yellow; eyebrows yellowish-white; space between the eye and bill black; neck, breast, and a portion of each shoulder intermediate between oil-green and sulphur-yellow; bases of all the feathers pearl-grey; immediately behind the yellow chin, the throat and sides of the neck are crossed by a deep brownish-black crescent. Inter-scapulars and scapulars clouded with pale reddish-brown, pearl-grey, and bluish-black or brownish-black, the latter generally prevailing towards the quills. Back and upper tail-coverts pearly grey, strongly tinged with brown, and when the feathers are separated, each is found with a yellowish tint at the base, and with a strong satin lustre. Secondary wing-coverts intermediate between Dutch and reddish orange, with the base and a considerable portion of the inner vane of each pearl-grey; primary wing-coverts and all the quill-feathers umber-brown; secondaries narrowly tipped with rusty-white; tail-feathers blackish-brown, the outer vanes edged with pearl-grey, and all, except the two middle ones, broadly tipped with the same colour as the secondary quill-coverts. Belly and under tail-coverts between chestnut and reddish-brown. Bill and claws dark horn-colour; eyes dark brown; toes greenish-brown. Wings when folded nearly reaching the tip of the tail; first quill-feather rather longer than the second; longest of the tertiaries intermediate between the sixth and seventh quill-feathers; tail wedge-shaped, the two middle feathers rather the longest and acuminated at their extremities; outer and inner toes of equal length. Total length 12 inches 6 lines.

Female.—Top of the head brownish-black, spotted rusty-white; back of the neck dull cream-yellow, dashed with brown; sides of the neck and throat honey-yellow; back, shoulders, and breast brownish, with large cream-coloured spots; belly deep black, with pale chestnut. Under tail-coverts bright cream towards their bases barred with black. Tail black brown, with partial bars of light cream-yellow; except the two middle feathers, tipped with pale orange. Length 11½ inches. (Smith.)

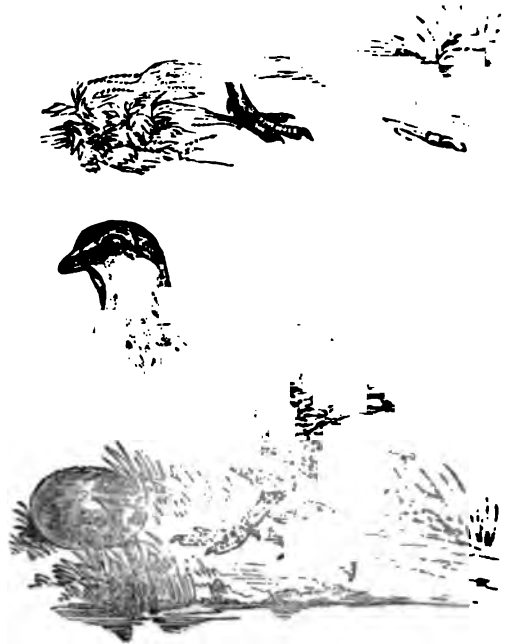

Pterocles gutturalis: male and female. (Smith.)

Locality, Food, Habits, &c.—Dr. Smith states that this species was first discovered in lat. 25° 30', about 100 miles to the eastward of Latakoo; and it was there remarked its cry to differ from that uttered by *P. Tachypetes*, Temm., that he was led to suspect this distinct. He says that, in common with the other African species of this genus, it resorts in large flocks to regular and fixed periods to localities where water is abundant; that at such times specimens are most readily procured, but he warns the sportsman to be quick in his movements as they scarcely reach the water before they are on the wing. As they approach and recede from such localities they almost incessantly utter cries resembling *tuet tuet tuet*.

Dr. Smith remarks, that from observing these birds when they are in quest of water, one would be led to consider them gregarious, a notion soon dissipated when their feeding-grounds are discovered, for they are generally dispersed singly or in pairs, and the occasional congregation is only effected by solitary individuals successively joining others who are on their way to a greater distance. *Pterocles gutturalis* seeks the water about ten in the morning and three in the afternoon, resembling in this respect *Pterocles Tachypetes*, which he tells us, drinks during the early part of the morning, and *Pterocles bicinctus* in the dusk of the evening, and the early part of the night. In such an arrangement, however, we must admit design; for if all the various of

experience thirst at the same time, both delay and would occur in quenching it, since, owing to the scarcity of water in the districts inhabited by these birds of the same species, even as it is at present, to be seen fringing the brink of a pool for hours and occasionally disputing for the first sip. Dr. and grass-seeds, ants, and abundance of gravel in the crevices of most of the individuals which he procured. He lays two or three eggs, which are nearly of the same size at each end, of a dirty-white or cream-colour, with irregular streaks and blotches of pale rusty grey or ash-colour, upon the bare ground, without any cover or shelter, once or oftener during the warm season; and it is not until the level spots fitted for the reception of the eggs are readily obtained, that the birds of this genus, according to Dr. Smith, bestow any labour on the preparatory places. Nothing, he adds, is ever interposed between the eggs and the soil; and indeed whatever is attempted to separate them is carefully avoided. Almost as soon as the young escape from the shell, they take to a flying life, and remove from place to place with the greatest rapidity in search of food. (*Illustrations of the Zoology of Africa.*)

AMERICAN GROUSE.

This genus possesses several species of grouse, consisting of several genera and subgenera *Bonasia*, or *Bonasa*, *Lagopus*, and *Centrocercus*. We have already described the *Ruffed Grouse* [*BONASIA*], and here select for description the *Centrocercus urophasianus*.

Centrocercus urophasianus.—*Male*.—General ground-colour: of upper parts light hair-brown, mottled and variegated with ochre-brown and yellowish-white. Each feather of the wing with three bands of yellowish-white at equal distances from each other, the lowest narrow, the middle one the outer one at the tip of the feather almost entirely white. Between these the colour is hair-brown, prettily marked with small irregular zigzags of light hair-brown: the shafts cross the shaft; but on the wing-coverts and the shafts are all marked by a narrow conspicuous line of yellowish-white. On the tail there are about

eleven of this colour, the lower ones being tolerably distinct, those towards the ends obscure: the margins are edged, and bordered by dark amber-brown, with zigzag lines of the same, upon a light hair-brown between each bar. Quills light, and almost unmarked at the extremities of the tail almost black. Breast white, unspotted on the breast and part of the neck; but dark amber-brown, approaching to black, over half of the body and part of the flanks; the throat and vent, marked as on the upper plumage. Tail-coverts black, broadly tipped with white. The thighs and tarsi light hair-brown, mottled with dark lines. Throat and region of the head varied with a white ground. Shafts of all the feathers dark black, rigid, and looking like hairs; scales of the sides white and thicker. Bill, which is strong, and toes blackish. On each side of the neck two prominent naked protuberances, destitute of feathers, more forward than the analogous parts of the *Cupido*. On each side of the protuberances and on the neck, a tuft of feathers, having their shafts considerably elongated and naked, gently curved and ending in a pencil of a few black radii. These tufts resemble the same part as these of the *Ruffed Grouse*, but are much behind the naked protuberances in the position from which the description was taken,* so that they do not appear intended to cover them when not inflated. On the sides of the neck and across the breast, the protuberances, the feathers are very short, rigid, and overlapping each other like the scales of a fish. The tail is short in proportion; lesser quills ending in a small tail rather lengthened, considerably rounded, each unmarked and gradually attenuated to a fine point. The body clothed with feathers to the base of the toes. Length 22 inches 6 lines.

Female.—Whole upper plumage, tail, wing-coverts, throat of the neck, and sides of the breast, dark umber-brown, and yellowish-white, irregularly and mottled in nearly equal quantities; but the upper part forming larger blotches towards the base, and colour bars on the tips and stripes on the shafts. Length 22 inches 6 lines.

Food, Habits, &c.—The favourite food of this species is said to be the pulpy-leaved thorn, but it probably feeds also on buds and berries. This grouse appears to have been first recorded by Lewis and Clark; and it has since become familiar to the fur-traders on the banks of the Columbia. Dr. Richardson gives the following interesting account of its habits by the late Mr. David Douglas:—

The flight of these birds is slow, unsteady, and affords but little amusement to the sportsman. From the disproportionately small, convex, thin-quilled wing—so thin, that a vacant space half as broad as a quill appears between each—the flight may be said to be a sort of fluttering, more than anything else: the bird giving two or three claps of the wings in quick succession, at the same time hurriedly rising, then shooting or floating, swinging from side to side, gradually falling, and thus producing a clapping, whirring sound. When startled, the voice is “*Cuck, cuck, cuck,*” like the common Pheasant. They pair in March and April. Small eminences on the banks of streams are the places usually selected for celebrating the weddings, the time generally about sunrise. The wings of the male are lowered, buzzing on the ground; the tail spread like a fan, somewhat erect; the bare yellow oesophagus inflated to a prodigious size,—fully half as large as his body, and, from its soft membranous substance being well contrasted with the scale-like feathers below it on the breast, and the flexile silky feathers on the neck, which on these occasions stand erect. In this grotesque form he displays in the presence of his intended mate a variety of attitudes. His love-song is a confused, grating, but not offensively disagreeable tone,—something that we can imitate, but have a difficulty in expressing—“*Hurr-hurr-hurr-r-r-r-hoo,*” ending in a deep hollow tone, not unlike the sound produced by blowing into a large reed. Nest on the ground, under the shade of *Purshia* and *Artemisia*, or near streams, among *Phalaris arundinacea*, carefully constructed of dry grass and slender twigs. Eggs, from thirteen to seventeen, about the size of those of the common fowl, of a wood-brown colour, with irregular chocolate blotches on the thick end. Period of incubation twenty-one to twenty-two days. The young leave the nests a few hours after they are hatched. In the summer and autumn months these birds are seen in small troops, and in winter and spring in flocks of several hundreds. Plentiful throughout the barren arid plains of the river Columbia; also in the interior of North California. They do not exist on the banks of the river Missouri, nor have they been seen in any

place east of the Rocky Mountains.’ (*Fauna Boreali-Americana.*)

This is the *Tetrao urophasianus* of the Prince of Canino, the *Cock of the Plains* of Lewis and Clark, and the *Pygmie* of the Kyuse Indians.

Food, Habits, &c.—The favourite food of this species is said to be the pulpy-leaved thorn, but it probably feeds also on buds and berries. This grouse appears to have been first recorded by Lewis and Clark; and it has since become familiar to the fur-traders on the banks of the Columbia. Dr. Richardson gives the following interesting account of its habits by the late Mr. David Douglas:—

The flight of these birds is slow, unsteady, and affords but little amusement to the sportsman. From the disproportionately small, convex, thin-quilled wing—so thin, that a vacant space half as broad as a quill appears between each—the flight may be said to be a sort of fluttering, more than anything else: the bird giving two or three claps of the wings in quick succession, at the same time hurriedly rising, then shooting or floating, swinging from side to side, gradually falling, and thus producing a clapping, whirring sound. When startled, the voice is “*Cuck, cuck, cuck,*” like the common Pheasant. They pair in March and April. Small eminences on the banks of streams are the places usually selected for celebrating the weddings, the time generally about sunrise. The wings of the male are lowered, buzzing on the ground; the tail spread like a fan, somewhat erect; the bare yellow oesophagus inflated to a prodigious size,—fully half as large as his body, and, from its soft membranous substance being well contrasted with the scale-like feathers below it on the breast, and the flexile silky feathers on the neck, which on these occasions stand erect. In this grotesque form he displays in the presence of his intended mate a variety of attitudes. His love-song is a confused, grating, but not offensively disagreeable tone,—something that we can imitate, but have a difficulty in expressing—“*Hurr-hurr-hurr-r-r-r-hoo,*” ending in a deep hollow tone, not unlike the sound produced by blowing into a large reed. Nest on the ground, under the shade of *Purshia* and *Artemisia*, or near streams, among *Phalaris arundinacea*, carefully constructed of dry grass and slender twigs. Eggs, from thirteen to seventeen, about the size of those of the common fowl, of a wood-brown colour, with irregular chocolate blotches on the thick end. Period of incubation twenty-one to twenty-two days. The young leave the nests a few hours after they are hatched. In the summer and autumn months these birds are seen in small troops, and in winter and spring in flocks of several hundreds. Plentiful throughout the barren arid plains of the river Columbia; also in the interior of North California. They do not exist on the banks of the river Missouri, nor have they been seen in any



Cock of the Plains. Male. (Swainson.)

place east of the Rocky Mountains.’ (*Fauna Boreali-Americana.*)

Nuttall says that the flesh is dark and less palatable than that of other species.

TETRAPLA. [ORIGENES.]

* Now in the British Museum.

TETRARCHI (*τετραρχία*), from two Greek words, signifying *four* and *to govern*, a title used by the Greeks at a very early period to describe the ruler of each part of a country which was divided into four parts, either on account of its occupation by different tribes, or merely as a political division. Each of such four parts was called a tetrarchy (*τετραρχία* or *τετραρχία*). In process of time the title came to be applied to the rulers of different divisions of the same country, or to the chiefs of different tribes inhabiting the same country, without any reference to the number four. In this sense it was equivalent to the titles *ethnarch* and *phylarch*. Under the Roman government, in the later ages of the republic and under the emperors, there were several such petty princes, independent of each other, but tributary to Rome. These *tetrarchs*, *ethnarchs*, or *phylarchs*, were either the legitimate governors of their subjects, or persons who had received the title and government from Rome as a mark of honour. They ranked below those other subject princes who were permitted to retain the title of king.

The principal examples of tetrarchies are those of *Thessaly*, which was antiently so divided, and the division was again made by Philip, the father of Alexander the Great; of *Galatia*, which was peopled by three Gallic tribes, each of which was divided into four tetrarchies: of *Syria*, many of the petty princes of which bore the title of tetrarchs, especially certain princes of the family of Herod the Great. Concerning the tetrarchs of *Syria*, see Niebuhr's *History of Rome*, ii., pp. 134-5.

TETRAN, Dr. Leach's name for one of the **BUSTARDS** placed by Mr. G. R. Gray in the subfamily *Otodinae* of the family *Struthionidae*.

Example, *Otis tetraz*, Linn.

TETRICUS, **CAIUS PESCUVIUS**, a Roman senator, one of the numerous usurpers of the Imperial purple in the third century A.D., who are distinguished in Roman history by the name of the Thirty Tyrants. He was governor of Aquitania, and, after the death of several pretenders in Gaul, was made emperor there, A.D. 268, by Victorina, said to be his kinswoman, and the widow of Victorinus. He reigned for a few years not unprosperously; but after the accession of Aurelian, finding himself unable to control the turbulent and licentious soldiery who sustained his power, and becoming weary of their crimes, he invited the new emperor into Gaul, and resigned his usurped dominion in the following manner. Dreading the resentment of his troops if he deserted them openly, he pretended to prepare for an engagement near Châlons in Champagne, and then betrayed his army into the hands of Aurelian. Gibbon places this event before the defeat of Zenobia; but Vopiscus ('Aurelianus,' *Historia Augusta*) says that it took place subsequently. The triumph of Aurelian, A.D. 274, was ennobled by the presence of the queen of the East, and of Tetricus and his son, in the train of captives. The deposed emperor was treated by his conqueror with every mark of distinction during the remainder of his life, and was made corrector of Lucania according to Vopiscus and other writers, or of all Italy, if we follow Trebellius Pollio. His son Tetricus, who had been made Cæsar by Victorina, met with not less favour than his father at the hands of Aurelian, and was honoured with senatorial dignity. On the coins of Tetricus, which are extant in gold, silver, and copper, we find the reading IMP.C.C.PESV.TETRICVS.AVG. and also IMP.TETRICVS.AVG; with, on the reverse, IMP.C.C.LAVDIVS.AVG, which, as Eckhel (*Doct. Vet. Num.*) remarks, would imply an alliance between him and Claudius Gothicus. Spon (*Miscell.*, 274. Lugd., 1685) gives an inscription on a marble found at Rouen with the titles of Tetricus more at length: C.PESVIVIO. TETRICO. NOBILISSIMO. CÆS.P.F.AVG.L.II. Coins struck in the name of the younger Tetricus yet remain. (Trebellius Pollio, 'Trigint. Tyr.' in the *Historia Augusta*; Eutropius, ix. 13; Gibbon., ii.)

TETRODON, a genus of fishes of the order *Plectognathi*. These fishes, instead of having distinct teeth as usual in the class, have the jaws provided with a substance resembling ivory, formed somewhat like the beak of a bird, and fitted for crushing crustaceous animals and fuci, upon which they live. Both the *Tetrodon* and *Diodon* (*Diodon*, Linn., a very closely allied genus, have the power of inflating the body with wind, or rather a membrane which extends along the under side of the abdomen, which causes them to float on the surface of the water, without the

power, it is said, of directing their course: the membrane when inflated, gives to the fish an almost spherical form, and is usually defended by spines and prickles. The pectoral fins are rather small; and besides these and the tail-fin, they have one dorsal and a ventral fin. The *Diodon* have but one large tooth above and below, and are usually protected by large strong spines. The *Tetrodon*s are distinguished by the possession of four large teeth, the jaw being each divided by a central suture. These fishes are confined to the seas of warm climates: some of them are called Globe-fishes.

TETUAN. [MAROCCO.]

TETZEL, J. [TEZEL.]

TEUCRIUM from Teucer, son of Scamander, and father-in-law of Dardanus, king of Troy is the name of a genus of plants belonging to the natural order *Lamiaceæ* or *Labiatae*. It has a tubular 5-toothed, nearly equal, 2-lipped calyx. The tube of the corolla is shorter than the calyx, the upper lip is abbreviated and bipartite; lower lip is longer, spreading, and trifid. The stamens much exerted, and the cells of the anthers are erect and spreading. The species are herbs and shrubs inhabiting most parts of the earth, and having a variable smell and inflorescence. Upwards of seventy species are described in Don's Miller's Dictionary. Of these comparatively few are known in this country; some of them are cultivated in our gardens, and three are natives of the British Isles.

T. Scordonia, Wood Germander, or Sage, has cordate, downy, petiolate, crenate leaves; the flowers are of a pale yellow colour, with violaceous stamens, and are arranged in lateral and terminal one-sided racemes; the stem is erect, hispid, pubescent, or nearly glabrous. It is a native of Europe in woody hilly situations, where the soil is damp and stony. It is not an uncommon plant in Great Britain. The smell and taste of this plant resemble very much the hop. In Jersey, where it is called *Ambrose*, the inhabitants use it as a substitute for hops in their beer; and by some persons the bitter given by the Germander is preferred to that of the hop.

T. Sordium, Water Germander, has oblong, downy serrate leaves; flowers purplish, arranged in whorls, 2-6 flowers in each; the stem is procumbent and villous. It is a native of Europe and the western parts of Asia in boggy wet places. It is a rare plant in Britain. Its fresh leaves are very bitter and rather pungent, having a smell similar to garlic. It had once a great reputation in medicine, but is now seldom used; it is however employed in cases where an aromatic is desirable.

T. Chamædrys, Wall or Common Germander, has ovate, inciso-serrate leaves, tapering into a footstalk; the flowers are reddish-purple, and arranged in axillary whorls; the stem is ascending, and most frequently branched. It is a native of Europe and some parts of Asia, on rocks and dry places. It is only rarely found in Britain. This plant was once much employed in medicine, and entered as an ingredient into the celebrated *Diacordium* powder. It has the tonic aromatic qualities of the *Chamaedryas* to which it belongs, which frequently render them useful in diseases connected with depressed powers of the nervous system and digestive organs.

T. Marum, Cat-Thyme, has small ovate quite entire leaves, with 2-4 flowered whorls; stem erect, branched. It is a native of the region of the Mediterranean. When the leaves are rubbed between the fingers, they emit a volatile aromatic smell, which excites sneezing, and on this account it is used as an errhine, and forms an ingredient in the *pulvis asari compositus* of the 'Pharmacopœia.' It has been recommended as a stimulant and aromatic in various diseases, but is not much used. Cats are very fond of it, and destroy it when they get near it.

T. polium, Mountain Poly, has cuneate oblong leaves with revolute edges; whorls few, condensed into tubular terminal heads; stems procumbent, much branched. This plant is a native of Europe and Africa, on the shores of the Mediterranean. According to soil, situation, and other circumstances, it assumes a variety of forms, and have been recognised as species by many botanists. Bentham, in his monograph on *Labiatae*, has placed several of these species under the present. There are other species of *Teucrium*, chiefly found on the shores of the Mediterranean, called *Polica*,

vation of the Germander a dry soil and shady best. The annual kinds are best propagated in an open border. The perennial and are readily increased by division and by young wood.

Æ. Professor Owen's name for the *Calamath* family of Decapodous Cephalopods, *deuthos* (τεῦθος), applied by Aristotle to the *ilakia* with an internal horny plate or *glalina* of the family will be found in the article **DATA**.

racter.—*Animal*, body sometimes oblong and generally elongated and cylindrical; with a ring in their relative size and position, but shorter than the body, and terminal.

rudimental, in the form of a thin, straight, horny lamina; encysted in the substance of the mantle.—(Owen.)

Owen divides the family into the following

Section A.

oteuthis, Blainville.

racter.—Body oval, flattened, with narrow extending its whole length; anterior margin unattached. Horny hoops of the acetabulated margins. *Gladius* or rudimental shell. (Owen.)

pioteuthis loliginiformis, Rüppel.

go, Cuvier.

racter.—Body elongated, cylindrical, pair of rhomboidal or triangular fins, shorter, and terminal, their apices generally compound, and united to the end of the mantle; fin of the mantle free. Horny hoops of denticulated. *Gladius* long and narrow.

oligo vulgaris. The common Calamary, or *ndant* on our coasts.

hoteuthis, Lichtenstein.

racter.—Body and fins as in the genus and narrow; horny hoops of the tentacular, of the brachial, acetabula produced into the or claws. *Gladius* long, broadest in the *en*.)

sia, Owen. [SEPIADÆ, vol. XXI., p. 253.]

ola, Leach.

racter.—Body rounded, short; anterior mantle adherent to the back of the head; fins ular, short, subpedunculate, distant and *ubius* short and narrow. (Owen.)

epiola Rondeletii, Leach.

Section B.

gopsis, Lamarek.

racter.—Body long and cylindrical, termir of conjoined, large, round fins, forming iregular disc; anterior border of the mantle e back of the head for a small extent. *Tenning* and slender (frequently mutilated). *Glarrowest* in the middle, dilated posteriorly.

oligopsis Teranii, Férussac.

chia, Leach.

racter.—Body elongated, sacciform; anteof the mantle adherent to the back of the hort, rounded, subpedunculate, approximate, subterminal. *Gladius* long and narrow.

ranchia scabra, Leach.

ie arrangement and definitions given by Proin the *Cyclopædia of Anatomy and Physiology* appears to us to be truly natural; and is are very accurate. The views and defini- r authors regarding the forms belonging to and an illustration of the forms themselves, in the article **SEPIADÆ**.

GERMAN WILD. [GERMANY.]

NATIONS is the general name under which l the different nations of the Teutonic race, ived into three branches. The first branch High Germans, to whom belong the Teutonic f Upper and Middle Germany, those of Swit- the greater part of the Germans of Hungary; d into the Suabian and the Franconian minor

branches. The second is the Saxon branch, which is divided into three minor branches: the first of which contains the Frisians, the second contains the Old Saxons or Low Germans, with the Dutch, the Flemings, and the Saxons of Transylvania; and the third contains the English, the Scotch, and the greater part of the inhabitants of the United States of North America. The third branch is the Scandinavian, to which belong the Icelanders, the Norwegians, the Danes, and the Swedes. Upwards of eighty-two millions of individuals belong to the Teutonic race. The Germans amount to about forty-two millions, thirty-three of which live in Germany, the remaining eight or nine millions form a greater or less part of the population of East Prussia, of Switzerland, of Hungary, of Transylvania, of France (in Alsace and north-east Lorraine), of Russia (in the Baltic provinces, in the kingdom of Poland, in the Crimea, in Bessarabia, and in the German colonies in the environs of Saratov on the Volga), of the duchy of Sleswig, and of the United States of North America, especially Pennsylvania. The English amount to twenty-eight millions, there being about sixteen millions of English and Scotch in Great Britain and Ireland, two millions in the English colonies, and about ten millions of Anglo-Americans in the United States. The number of the Frisians is about one hundred and thirty thousand, in the province of West Friesland in Holland, in the islands in the German Ocean along the Dutch and the German shore, in the Saterland (near Oldenburg), and in the islands along the west coast of the duchy of Sleswig. There are about three millions of Dutchmen in Holland, and in her colonies and the Cape of Good Hope; and there are about two millions five hundred thousand Flemings in the north part of Belgium, in the south part of Holland, and in the north-east part of France. The number of individuals belonging to the Scandinavian branch amounts to about six millions, among whom there are nearly fifty thousand Icelanders; one million five hundred thousand Danes in Denmark, in her colonies and in the north part of the duchy of Sleswig; one million two hundred thousand Norwegians; and about three millions two hundred thousand Swedes in Sweden and in the present Russian province of Finland, especially along the coast of the Gulf of Bothnia, in the districts of Abo and Nyland, and on the Aland islands, which are entirely inhabited by Swedes.

Light hair and blue eyes in the northern countries, and brown hair and brown or blue eyes in some of the southern countries, are characteristics of the Teutonic race. Their stature is generally tall, although in those provinces where the Germans are mixed with Wends, Sorabians, and Bohemians, many of the people have the broad shoulders and the short square form of the north-western Slavonians. The straight black hair of some Slavonian tribes also sometimes appears. The mixture of Germans with the south-western Slavonians, such as Winds and Croations, whose stature exceeds that of the Wends and Bohemians, is more difficult to be distinguished, the black straight hair and a darker complexion being almost the only indication of such a mixture. The mixture of Germans with Celts in Belgium and in the adjoining part of France has formed a tall race which differs from their Teutonic neighbours. only in the dark colour of their hair and their black eyes. (Platé, *Scenen aus dem Volksleben in Belgien*.)

It is very difficult to distinguish the descendants of English and Irish parents as belonging either to the Teutonic or the Celtic race, though it appears that wherever aquiline noses are seen among the lower classes they are a proof of Celtic origin, the true Teutonic nose not being aquiline, but either straight or curved only in its upper part. In general also the Teutonic forehead is broader between the temples than the Celtic. (Clement, *Die Nordgermanische Welt*; Herder, *Ideen zur Philosophie der Geschichte*, vol. i.)

The moral and intellectual difference between the Teutonic nations is less remarkable than that which exists between other European nations of the same race with one another. Capable of strong and violent passions, they do not easily lose their self-control, the intellectual functions being more developed than in most other races. Southern nations, confounding liveliness of feeling with intensity, and nervous excitability with moral sensibility, have been deceived by the cool character of the Teutonic nations, and have accused them of indifference. But the most superficial examination will show their sensibility, a fact which is proved by their poetry. The Teutonic nations are less excitable

than the Celtic, the Slavonian, and other races, but capable of deeper thought. Southern nations have accomplished great things by sudden efforts; the Teutonic nations have reserved their enterprise for vast plans, which it requires centuries to carry into effect. Thus they destroyed the Roman empire after a struggle of three centuries, and they formed new kingdoms in Europe upon new social principles, which have maintained their vigour to the present day. The Normans became powerful wherever the sea permitted them to effect a landing. The Germans, diminished in number after they had sent their swarms to western Europe, turned back towards the east part of their country, then occupied by Slavonian nations, which they conquered, and Germanised upon a plan of colonization which enabled them to civilise the east of Europe. And lastly, the English colonies have spread over the world: their dominion in the east and in the west is the result of plans which imply more boldness of conception, more prudence in execution, and more reflection, than the conquests of Alexander the Great and the ephemeral power of Napoleon.

The same character of deep and patient reflection exercised on great objects appears in German philosophy and in the inventions of the Teutonic nations. The watch, the gun, and the art of printing are Teutonic inventions. They have subjugated the power of steam; and the first model of the modern sea-vessel was constructed at the mouth of the Eider by the hands of an old Saxon or Frisian ship-builder (Clement, *ibid.*)

The name of the Teutones was made known to the ancients by Pytheas of Massilia (Marseille), who, in the age of Alexander the Great, about 320 B.C., discovered a nation of that name in the Chersonesus Cimbrica, and on the adjacent islands, or in the present countries of Holstein, Sleswig, Denmark, and perhaps also in the southern extremity of Sweden. It seems that they had long been settled there, for they lived in houses, and were acquainted with agriculture and commerce. Other traces of the name appear later. Among the Celtic tribes which invaded Greece and besieged Delphi under the second Brennus (B.C. 278), there was a people called Teutobodiaci, who afterwards passed the Hellespont and settled with the Celts in Galatia, in Asia Minor. About a hundred and sixty years later, the Romans were attacked by the Cimbri and Teutones, who came from the same country, where they had been seen by Pytheas. The Teutonic origin of the Cimbri has been disputed: some historians consider them identical with the Celtic Cymri, but this error has been long since refuted, although it has been reproduced in our days by Thierry, in his 'Histoire des Gaulois.' It is said, and it is not improbable, that inundations of the sea compelled the Teutones and their neighbours the Cimbri to leave their country and to seek other abodes. The choice was soon made. The wealth of Rome and the arts of Greece were not unknown to them. From the most remote times adventurous merchants, starting from the shores of the Black Sea, followed the course of the Dniepr towards its sources, and reaching the Diina and the Niemen, descended these rivers to their mouths in the Baltic, where they exchanged the commodities of the south for amber, the electrum of the ancients. The same trade, as it seems, was carried on by the merchants of Massilia along the Rhone and the Rhine, and therefore Schlüzer, in his 'Nordische Geschichte,' says that but for the amber Germany would have remained unknown to the ancients for five centuries more. Their acquaintance with Rome and Massilia was perhaps the principal cause which led the Cimbri and the Teutones to the south of France and to Italy (B.C. 113-99). Their destruction by Marius has been related. [MARIUS; CIMBRI.]

When the Romans first heard the name of the Teutones, they thought that they were a single tribe. They did not know that it was also the general and ethnographic name of all those nations to which they afterwards gave the vague designation of Germans.

Origin of the name Teutones.—The root of the word Teuton is *thu* or *do*, which originally represented the idea of 'activity,' of 'living, procreating, nourishing,' and also of 'taming, educating, and ruling.' From this root are formed the following words, some of which are still used in the popular dialects:—*Teut*, God, creator, ruler, father, nourisher *Thor*, *Tuisco*; *thut* or *thiud*, earth; *tott*, *dote*, *dat*, godfather; *todu*, nurse; *thiud*, father of the people, lord, ruler, king, in Gothic *thiudans*, in old Bavarian

theodo; *diet*, people, in old Swedish *thiut* a *thiudinassus*, in Gothic, kingdom. (Fulda, *Wurzel buch*.) The names of king and of people being derived from one root, which expresses the notion of a fact which proves that they belong to the law of a nation in which there was neither absolute power, nor absolute submission to their chiefs. This corresponds exactly to the political state of the ancient nations, among whom the sovereignty was in the person of the executive power of the chiefs or kings, which, though obeyed, was always regarded as derived from the law. The idea of ruling, expressed by the root *Thu*, why this word occurs so frequently in the names of the ancient Teutonic kings, dukes, or chiefs, such as Theoboch, Theodorix, Diorix, Theodorix, Theodo, Theodimir, Teutagon, &c. It is likewise a general name of all the Teutonic nations, and is used in various tribes, as the Teutones, the Teutonarii, and the Dithmarses or Dietmarses. It is visible in 'burger Wald,' the name of that range of mountains which stretches from Detmold westward to Osnabrück, in which is situated the Grotenburg, 'Teut' or 'Teutoburg,' with the farm of 'Teutoburg' Varus was overthrown by Arminius; in 'Deuisburg,' 'Duisburg,' 'Deuz,' and in a great number of localities in Germany. 'Hammerstein, *Ueber die feld des Varus*; Reichardt, *Germanica*, p. 73, &c. is identical with *Deutsche* or *Teutsche* (in Low Dutch, in Dutch *Duitsch*, in Danish *Tyck*, in English *Dutch*), which from the remotest time has been still the general name of that part of the Teutonic nations which we now call Germans, who considered themselves as their common ancestor. There are many instances of the word Teuton having had this extensive use in the earliest German history, but this is perhaps the earliest political state of the Teutonic nations, which were originally divided into numerous tribes, each of which came separately known to the Romans. In the eleventh, and even as early as the tenth century, the difference between Franks and Saxons was well marked in the German empire, these nations, each of which had their own language and laws, never objected to be called by the general name of *Deutsche* or *Teutones*, and there is no German tribe which has the particular name of Teutones, but although the Germans are composed of very distinct nations, the High Germans and the Low Germans, they call themselves *Deutsche* and their language *Deutsch*, though they do not understand each other. This is very different from the state of things in France. The true meaning of 'Français' is political, signifying a citizen of the kingdom of France, a Frenchman, a German, a Briton, or a Basque; in France the name of Français is given to the people of the Loire; and, on the contrary, the name of Frenchman is never given to any of the dialects of France, nor to the Walloon dialect in Belgium. It may be observed in Spain. If however such distinctions are the consequence of France and originally been inhabited by nations of different circumstances that the name 'Deutsch' has been applied to all Germany and applied to all her dialects from the earliest historical period proves that the name had a general application long before the commencement of German history. Another circumstance corroborates this opinion. The name has never changed its name for another except in the case of a great political revolution. Thus the Tatare, the Mongols, the Italians, the Romans, the Romans, the Franks, when one man, or one city, or one tribe had a predominant influence over the remainder of the nation, and these nations have preserved the memory of their revolutions. [TARTARS.] But no such revolution is to be seen in the history of Germany. A further proof of this is the Dutch and the Flemings dislike to hear themselves called 'de Hollandsche taal,' or 'de Vlaemsche taal,' they prefer giving it the name of 'de Neder taal.'

Origin of the Teutonic Nations.—The Teutonic nations originally from Asia. The Teutones immigrated into Europe at different periods unknown to history, although it appears that the last of them entered Europe by the migration of nations in the fourth and fifth centuries.

* As early as the beginning of the ninth century Louis, the son of Pious, who governed Germany, was called Louis the Teutonic.

of their Asiatic origin is given in their ancient sagas, principally in the Sagas of the Scandinavians. The recollection of their ancient homes was not lost in Germany in the eleventh century, for we find the following verses in the 'Lobgesang auf den Heiligen':

'Deren Geschlechte dero quam willin ero
Von Armente der herin.
Man sagit, daz dar in Halvin noch sin
Die der Ditschin sprechin,
Ingegin India vilii verro.'

the Bavarians) came a long time ago from the noble Armenia. It is in the Alps, far off towards India, there are still people who are like.' (Schilter, *Thesaurus. Antiq. Teuton.*, p. 1., sect. ult., p. 15.)

So said that Benedict Goesius (Goez), a Jesuit, in 1603, in the mountains of the Hindu Kush, north of Kabul, a people with fair hair like the Dutch, and which was settled in the Montes. But all this is of little value, unless it is corroborated by other facts. Such facts have been furnished by modern philologists of our age, especially by Friedrich Schlegel, Adelung, Bopp, Grimm, and Hammer. A comparison of the Teutonic languages with the Persian, Sanskrit, and the Sanscrit, has shown the relationship existing among these languages [LANGUAGE; GERMANIC; SANSKRIT], and by means of these facts, the Myths of the Sagas become important for history. According to these myths, Deut or Diuta were the names of the Teutonic gods who led the tribes which emigrated from the east to the west. (Hammer, in *Wiener Literatur-Zeitung*, October, 1816; Ritter, *Erdkunde*, vol. ii., p. 118, 119; Ritter, *Vorhalle*, p. 317, 460, 620; Grimm, *Grammatik*, especially in the preface, p. xxvi., 27; *Ausführliche Erläuterung der zehn ersten Bücher der Schrift des Tacitus über Deutschland*, p. 88, 89; Ritter, cited above, i., p. 400; Mathæus Riccius, *Itinerarium Expeditione apud Sinas suscepta à Societate S. P. d. 606.*)

The Teutonic nations appeared in history, they were divided into many bodies or confederations of tribes, as, at a later period, the Franks, the Suevi, the Marcomanni, and the Alemanni. Long before these names were known, there was a similar confederation of tribes which came from the north-north-west, conquered the countries on the left bank of the Rhine, and then inhabited the Celtic nations, which fled to the west in Central Gaul. The epoch of this invasion is not known, but the event happened long time before the time of Cæsar, who found those countries settled by a Teutonic nation. Tribes of the Condrusi, the Eburones, the Menapii, and the Paemani, were united in a confederation, and adopted the name of Germani, or 'war-like people,' his name was gradually used by the Romans to designate other nations which belonged to the Teutonic race. (*Germ.*, c. 2), and subsequently it was adopted in English as a name for the 'Deutsche,' while this name, changed into Dutch, now designates the inhabitants of Holland. It has been pretended that the name Germani was known long before the time of Cæsar, and this opinion is founded upon the following passage from the 'Fasti Capitolini':—

CLAUDIUS M. F. M. N. MARCELLUS-
S. DE. GALLEIS. INSUBRIBUS. ET. GERMANEIS.
MART. ISQUE SPOLIA OPIMA RETTULIT
CE HOSTIUM VIRIDOMARO AD CLASTIDIUM
perfecto.

word 'Germane' is here right, and there is no objection for putting 'Cenomane' in its place, the name of the Romans with the Teutonic nations was used long before the invasion of the Cimbri and the Teutons. There is a passage in Livy (xxi. 38) which shows that at the time of the invasion of Italy by Hannibal (218) the country of the Alpes Penninae was called by 'nationes semigermae,' by which expression the Romans have hastily concluded that a mixture of Teutonic and Celts is meant; but the passage admits of another interpretation.

Teutonic Nations after Cæsar.—When Cæsar crossed the Rhine, Northern Germany, Holland, Belgium, and the countries on the Middle Rhine were inhabited by Teutonic nations which belonged to the northern branch. They had been settled in fixed habita-

tions for several centuries, and they must be considered as the first of this race which settled in Germany. The southern part of this country was then inhabited by Celts and Rhaetians, except the tract between the Upper Rhine and the Upper Danube, which was conquered by the Suevi, who belonged to the Teutonic race. The word 'Suevi,' which comes from 'schweifen,' may be translated 'wanderers,' or people who rambled about for the purpose of settling in any convenient country. It was adopted by a great number of tribes, the majority of which belonged to the High Germans, and came from the countries on the Baltic between the Oder and the Niemen. Cæsar was obliged to fight with their leader Ariovistus (b.c. 58), who had invaded Gaul. Ariovistus was compelled to go back to Germany.

Tacitus divides the Germani into three great bodies: the Ingaevones, in the north; the Istaevones, in the west, from the mouths of the Rhine upwards to Basel; and the Hermiones, in Middle Germany and towards the north-east. This division seems to have an ethnographic and still more a political value. The position of the Ingaevones corresponds to that of the later Saxons, and both the names have one meaning, Saxon signifying a settled people, and In-gae-vones a people who live in a cultivated country divided into districts (In-gau-wohner or Inwohner). The Istaevones, or Western Germani (West-wohner), correspond to the later Franks, and the Hermiones to the Suevi, including the Alemanni. Further, the name of Hermiones is undoubtedly identical with Hermunduri, one of the greatest Suevian or High-German tribes, the name of which is generally supposed to be the same with Doringi or Thuringi, the present Thuringians.

From the time when Cæsar first met with the Suevi under Ariovistus, there was a deadly enmity between the Romans and the Germans. The Romans wished to make Germany into a province, and the Germans aimed at the possession of Gaul: on both sides there was the passion or conquest and the necessity of self-defence. Ambition pushed the Romans into Germany, and want of fertile lands, and perhaps some great revolution among the nations of Eastern Europe, led the Germans into Gaul and Italy. The Roman eagles were seen in the wilds of the Hercynian forest, but Arminius saved his nation from slavery in the forest of Teutoburg, where Varus was slain with three legions (A.D. 9). The campaign of Germanicus, who advanced as far as the Elbe, led to no results, though he gained a complete victory over the Germans on the field of Idistavisus near the Weser (A.D. 16); when he celebrated his triumph in Rome (A.D. 17), the Germans between the Rhine and the Weser were as free as before. These tribes made a confederation, and chose Arminius for their leader. A war arose between him and Maroboduus, king of the Marcomanni, who was defeated and obliged to implore the assistance of the Romans (A.D. 19). Being attacked by Catwald, or Catualdus, the chief of the Gothones, he lost his crown, and the confederation of the Marcomanni was broken. Arminius, the hero of Germany, fell by the hands of his jealous kinsmen, in his thirty-seventh year. (Tacitus, *Annal.*, ii. 88.)

Notwithstanding the civil wars in Germany, the Romans gave up the idea of conquering the country, and Tiberius ordered a defensive system to be observed on the frontiers, which were formed by the Rhine from its mouths to the Moselle, and from the junction of this river with the Rhine they followed the Lahn as far as the present district of Wetterau. The frontier then took a southern direction, passed the Main at Obernburg, the Jagst at Jagsthausen, the Kocher at Hall, and joined the Danube near Pörfing, from which town it ran along the Danube as far as Pannonia. The rivers were defended by castles, and the tracts between them by a strong rampart with towers, the Vallum Romanum of Hadrianus, a considerable part of which, the Pfahlgraben, is still visible. The Germans west and south of this barrier became Roman subjects, but those who lived east and north of it enjoyed their ancient liberty.

All the German tribes practised agriculture, but warfare being their favourite occupation, they abandoned their fields and their flocks to the care of bondsmen. Their agricultural system, which is still practised in some countries of Westphalia, and which is now called Dreifelder Wirtschaft, consisted in cultivating a field during three successive years, after which it was used as pasture-ground for three years. The fine arts were not exercised among the Germans, but they were acquainted with the

art of writing [Runic Letters], although only for religious purposes. (Rhabanus Maurus, in Goldast, *Script. Rer. Alem.*, ii. 1, p. 67; Hiccesius, *Theo. Ling. Septentr.*) The groundwork of their social and political constitution was the union of a certain number of families into a community, 'Marcha,' 'erd-marcha,' now 'Mark-Genossenschaft.' Several marchas formed a 'gow,' now 'gau,' a district which had its own administration. Twice a month, and sometimes every week, the members of a gow assembled and held the 'gowding;' the gowdings were civil and criminal courts, and also meetings for legislation, and war and peace were decided on in them. Besides the gowdings there were 'graven' or 'greven' (graviones, comites), or delegates of the gowding, who were assisted in their judiciary functions by a certain number of freemen. The magistrates were chosen from the nobles (edelings or adelings), the 'principes' of Tacitus, who had also the right of forming a kind of senate, where they deliberated on important affairs previously to their being brought before the gowding, and they dispatched matters of little importance, which did not come before the gowding. The nobles had also the privilege of keeping a 'dienst-gefolge,' or a band of freemen who served them in their feuds and wars; and they had individually the right of protecting unfree people in the gowding, a right which also belonged to the community as a body, but not to individual freemen. The privileges of the nobles were probably connected with the religious institutions, of which we have no positive knowledge, although it appears that priests and nobles formed only one class, an opinion which is corroborated by the fact that wherever Christianity was introduced into Germany, it met with no opposition from the common people as soon as the nobles were converted. Some of the earlier Teutonic nations had hereditary kings, the 'reges' of Tacitus, who however had a very limited authority. The greater part of them chose princes only as commanders of the army in time of war. The name of these commanders was 'herzog,' in low German 'hertog,' or 'hartog,' in Latin 'dux.'

Besides the freemen and the nobles, there were bondsmen, 'lazzi,' 'lati,' or 'liti,' now 'leute,' in low German 'lüde,' or 'lide,' who were either the primitive inhabitants of a conquered territory, or prisoners of war, or freemen who had lost or sold their liberty. Their condition was in no way like that of the Roman Servi, who, legally speaking, were not considered as persons, but in most respects things. Domestic and personal services, and especially agriculture, were their exclusive occupations.

The military organization of the Teutonic nations was founded on two principles. When a gow, or a confederation of several gows, determined on war, every freeman was obliged to take up arms for the defence of the commonwealth. These wars had rather a defensive character, and they occurred principally among the inhabitants of northern Germany between the Baltic and the Rhine. But war was sometimes made for the private interest of some powerful noble, who carried it on with his 'dienst-gefolge,' which was a numerous body when the military renown of the chiefs, or the hope of easy conquests, promised rich rewards to the adventurous band. These were generally offensive wars, and we find that they occurred chiefly among the Suevian nations.

We know little about the religion of the ancient Teutonic nations. They worshipped a supreme being under the name of Wodan or Odin, but the true character of their religion was the worship of Nature in her different manifestations. Thor, Hertha, and Freya were personifications of the power of heaven, of earth, and of love and procreation.

Such was the moral, social, and political state of the Teutonic nations when they began their wars with Rome. The Vallum Romanum prevented them from invading the Roman empire during the first and second centuries. In the third century they often crossed it. In the fourth they conquered a considerable part of the countries on the Danube; and in the fifth they invaded and conquered all the European provinces of the Roman empire. Instead of following the chronological order, which would cause confusion, we shall give a view of all these invasions by referring them to their several heads, according to the people by which they were effected.

Alemanni. [ALEMANNI.] Towards the middle of the fourth century swarms of people belonging to the Suevi

came from north-eastern Germany to the country of the Rhine and the Danube, where they settled, their army and colonists having retired beyond these rivers. They called themselves Alemanni. In the latter part of the fifth century the Alemanni conquered the country on the bank of the Rhine, as well as parts of Noricum, Vindobona, and Helvetia, and founded the kingdom of the Alemanni. Clovis, king of the Franks, conquered the western part of the Alemanni in 496: the eastern and larger part, which was conquered by Theodoric, king of the Ostro-Goths, was added to the Franks in 536. (Cassiodorus, *Var.*, ii. 41.) The Alemanni lost a considerable part of their lands, almost all of which were deprived of their estates, many of them were killed, and the remainder became vassals of the Franks. In 613 and 623 the laws of the Alemanni were collected by order of the Frankish king Clotarius, under the name of the Lex Alemannorum. This collection is in Latin, and contains laws of the other Teutonic nations of the period, as well as the laws of the Anglo-Saxons, which are written in their own language.

The Lex Alemannorum was revised in 688 by Charlemagne, king of the Franks, and again by Louis the Pious, Frankish duke of Alemannia, in the beginning of the eighth century. There is no trace of the Lex Alemannorum, except in one single case (tit. 30 of the Lex Saxonum), as well as all the other earlier laws of the Teutonic nations, are contained in Ferdin. Schöffer's 'Corpus Juris Germanici.' Sichard published it in the 'Leges Ripuariorum, Bajuvariorum, Alemannorum,' 1530, 8vo. Besides these collected laws are in the collections of Herold, Lindenbrog, Heineccius, Georgisch, Canciani, and Baluzius.

Burgundians. [BURGUNDY.] The Burgundians came from north-east Germany, and first assisted the Romans against the Germans; but they left Germany at the beginning of the fifth century, penetrated into Gaul, and formed the powerful kingdom of Burgundy on the sides of the Jura, which was incorporated with the Franks in 534. The collection of their laws, Lex Burgundionum, 'Gundobada,' or 'Loi Gombette,' was made towards the end of the fifth century, under king Gundobald, who died in 523, and was augmented (517) by king Sigismund, in 523.

The legislation of Gundobald goes as far as the beginning of the sixth century. The following titles, although they contain regulations of Gundobald, were added by Charlemagne: completed the code by two 'additamenta,' or additions of his own laws. Charlemagne made a third edition of the Lex Burgundionum, without altering the code itself. The Lex Burgundionum, which is written in much purer Latin than the other Teutonic codes, contains several of the Roman law concerning donations, and especially the laws of the Emperor Justinian (tit. 43 and 60). A separate edition was published at Lyon in 1611.

Franks. [FRANCE.] In the very countries of Gaul the Romans traversed on their way to the woods of the north, the Usipetes, the Tencteri, the Sicambri, the Brueteri, the Ansibarii, the Marsi, the Tubantii, the Chatti—all tribes belonging to the now Saxon branch (Ingaevones) of the Germanic nations, a confederation, and called themselves Franks, because they were particularly 'free and bold,' or 'franc,' from the name of their 'barbed lances' (frameae). Their independence appears in 242, when some of them made an expedition into Gaul during the reign of the emperor Gordianus. Aurelianus, defeated them. In the beginning of the fifth century they had conquered Belgium as far as the Somme, and in 487 their king Clovis put an end to the Roman power north of the Loire. The Franks then conquered Southern Gaul, then divided between the Visigoths; Germany, and the countries as far as Poland; part of Pannonia; the kingdom of Italy; and Spain between the Pyrenees. Charlemagne was the lord of all the Teutonic nations, except the Scandinavians, the Angles in England, and the remainder of the Goths in Spain and Asturias. The Frankish language, a mixture of Low German, was spoken at the court of Charlemagne, and among the nobles in France, and by many of the Franks who settled among the Suevi in Germany, the Middle Rhine and the Main, and the mixture of the Frankish and the Teutonic languages is the origin of the present Middle

ian dialects. Among the Teutonic nations which in Roman provinces, the Franks were the last who reverted to the Christian religion: their king Clovis (Clodoveus) after his victory over the Alemanni at Zülpich (Zülpichum) in 496. They founded a mighty arisia France, the political influence of which was by Louis XI. The personal and social influence ranks lasted till the Revolution of 1789, which is regarded by the best modern French historians as a of the subjugated Celtic people against haughty lent Frankish invaders.

Franks were divided into Franci Salici, who lived in the low countries between the Zuider Zee, the Maas, Somme; and Franci Ripuarii, who were settled on the Rhine between Nymegen and Bonn. Each of them had their code. The Lex Salica was written in very old Latin, under Clovis, between 484 and 496, and was revised, although it contains some laws by the king Clovis, which begin with the 62nd (63rd) title. The first rule in title 14, about the rape of free persons, and another concerning marriage within the prohibitions, this code contains no trace of the Roman law. It is very important for the history of the laws of the Teutonic nations. The ancient Lex Salica is often confused with the present Salic Law, which regulates the order of succession in several sovereign and noble families in Europe. But this latter Salic law is only a single article of the Lex Salica, and originally concerned the succession to the tax-free estates of free or noble Franks (liberici), which belonged to the male issue, to the exclusion of females. It is contained in title 62, 'De Alode,' 'De terra vero Salica nulla portio haereditatis masculinae: sed ad virilem sexum tota terrae haereditas pertinet.'

The law was not peculiar to the Franci Salici: it was the greater part of the other ancient Teutonic

laws, *la, Geschichte und Auslegung des Salischen Gesezses*, Ant. Germ., i. p. 265, 285; a separate edition of the Lex Salica was published by Pithou, Paris, 1600.)

The Lex Ripuaria was collected by Theodoric, the son of Clovis, between 511 and 534. It was several times revised, especially by Dagobert. It resembles the Lex Saxonica and contains no traces of the Roman law.

While the Alemanni, the Burgundians, and the Ostro-Goths invaded the Roman empire on the Danube, the Visi-Goths, or Thervingi, west of it. Their eastern frontiers were attacked by the Ostro-Goths originally inhabited the countries on the Rhine between the Vistula and the Niemen; but as the close of the second century A.D. they appeared on the shore of the Pontus Euxinus and the Crimea, where they founded two great kingdoms,—that of the Ostro-Goths, or Greuthungi, east of the Dnieper, and that of the Visi-Goths, or Thervingi, west of it. They were broken by the Huns, by whom they were partly destroyed, partly forced to take refuge in Dacia and in the Crimea.

The Visi-Goths then left the Danubian countries, and descended into Italy as far as Reggio, opposite Sicily, and conquered the southern part of Gaul, and Spain. The Ostro-Goths, less fortunate in their attempt on Thrace, were forced to go back to Dacia, where they became subject to the Huns. After the death of Attila, in 453, they declared their independence, and leaving the dangerous part of the eastern part of Dacia, they settled in the part of this country, which the emperor Zeno was obliged to cede to them in 474. In 488 their king Theodoric having besieged Zeno in Constantinople, compelled him to cede his claims on Italy, then under the rule of Odoacer, the chief of the Rugii, the Heruli, and other tribes, who had put an end to the Roman empire in Italy by deposing the last emperor, Romulus Augustulus, in 475. [THEODORIC.] Odoacer was deprived of his throne and his life by Theodoric in 493, who founded the kingdom of the Ostro-Goths in Italy and Illyricum, which he ruled till 527, when Tejas, the last king, was murdered by Narses.

The code of the Ostro-Goths, 'the Edictum Theodorici,' was composed by order of Theodoric in 500, is a mixture of Roman laws. This king wished to form one code for the Romans and the Goths (*Edictum*, § 30), and he adopted the laws of the most civilised of his subjects.

Leaving the Gothic laws exclusively to the Franks, C., No. 1521.

memory of the people, he knew that they would soon fall into oblivion without being formally abolished. In some cases, however, he supplanted Gothic customs by Roman laws. The *Wehrgeld*, or *Wehre*,—that is, the fine for crimes,—was entirely abolished, and in place of it the punishment of death was introduced in many cases, an innovation which seemed very hard to the Goths, who, like all the other Teutonic nations, inflicted the punishment of death only for high treason and a few such crimes. Pithou published a separate edition of the 'Edictum Theodorici' (Paris, 1579). Rhon, *Commentatio ad Edictum Theodorici, Reg. Ostrogoth.*, Halae, 1816, 4to.

The Visi-Goths settled in the southern part of Gaul in 412, and invaded Spain in 414. This country was then in the hands of the Suevi, the Alani, and the Vandals, who became subject to the Goths, or were forced to emigrate. In 451 the Visi-Goths, together with the Franks, defeated Attila and his 700,000 Huns, Goths, Gepidae, and other vassals, in the plain of Châlons-sur-Marne. Their king, Alaric II., lost Gaul, except the eastern part of Langue-doc and Provence, in the battle of Vouglé against Clovis; king of the Franks, in 507. The kingdom of the Visi-Goths lasted for three centuries, when it was overthrown by the Arabs in 712. [SPAIN.]

Among all the Teutonic nations the Visi-Goths were the first who had written laws. (Isidorus Hispalensis, 'Chron. ad annum Aer. Hisp. 504, A.D. 466.') A collection of them was made by their king Euric (466-484), which is written in Latin and has the title of 'Lex Visigothorum.' Its present form dates from King Egica, whose new code was translated into the Gothic language under King Receswind. It contains many traces of the Roman law, and is the only early Teutonic law which may be considered as a code in the modern signification of the word. The Lex Visigothorum must not be confounded with the Breviarium Alarici (Alaric II., in 506), or the Code for the Romans, who were subjects of the Visi-Goths, and continued to live under their own laws until they were abolished by the kings Chindaswind and Receswind, who declared the revised Lex Visigothorum obligatory on all the inhabitants of the kingdom of the Visi-Goths.

The Goths, the most civilized among the Teutonic nations, were the first who adopted the Christian religion. They had a literature from the time when Ulphilas translated the Bible. The Visi-Goths were at first Arians, and though they returned to the Roman Church, they distinguished themselves from the other Roman Catholics by their form of worship, or the Officium Gothicum, which was approved by the fourth Council of Toledo, A.D. 633. It is also called Officium Beati Isidori: Isidore presided over that council. It contains many customs and forms which have been used in the Spanish church from the earliest times of Christianity. It was written in Latin, but in old Gothic characters, which differ from the Scandinavian runes.

The Ostro-Goths soon disappeared among the Longobards, while the Visi-Goths preserved their language and nationality till the invasion of the Arabs; and another portion of them maintained their nationality until a very recent period.

These were the *Gothi-Tetraxitae*, who, after the emigration of their brethren to the western countries, retired to the eastern part of the Chersonesus Taurica, now the Crimea, and the opposite island of Taman. There they lived for eleven centuries under the successive dominion of Huns, Bulgarians, Greeks, Khazars, Tartars of Kiptshak, and Tartars of the Crimea, and, lastly, of Turks Osmanlis. Their part of the Crimea was called Gothia during the middle ages. Busbequius, who was the ambassador of the emperor Rudolph II. at Constantinople, towards the end of the sixteenth century, is the last writer who mentions them. It appears that they afterwards adopted the language, the customs, and the religion of the Tartars. Russian scholars have traced the Gothic language among the Tartars of the Crimea. (*Journal de St. Pétersbourg*, 31st January (12th February), 1829.)

Another part of the Goths invaded Sweden, and founded the kingdom of Gothland (Gautland), which was afterwards divided into East Gothland and West Gothland (Eystra-Gautland and Vestra-Gautland). They mixed with the Scandinavians, and it became a general opinion that they were originally the same people. But a comparison of the Gothic of Ulphilas and the old Scandinavian language

shows that this opinion is unfounded. (Olaus Verelius, *Gothrici et Rolfi Westrogothiæ Regum Historia*, Upsalis, 1664; Antonius, *Bibl. Hisp. Vel.*, i., p. 62; Michael Geddes, *Miscellaneous Tracts*, vol. ii., diss. 1; vol. iii., diss. 1; Manso, *Geschichte des Ostgothischen Reichs in Italien*; Mascov, cited below, ii., p. 553-566.)

Suevi.—From the country east of the Black Forest, between the Upper Danube and the Alps, the Suevi, by which name the Quadi and the Hermunduri were perhaps likewise meant, spread over Gaul and forced their way into Spain (406-409). Their king Hermanaric or Hermanrich became master of Portugal, Galicia, and the western parts of Asturias, and Leon: he resided at Bretonia, near the mouth of the Miño, now a small village named Breaña. His successors were independent kings, but in 565 the Suevi became subjects of Leovigild, king of the Visi-Goths. Their laws have not been collected. They were at first Catholics, but king Remismund (461) professed Arianism; Theodemir (Ariamir) returned to the Catholic faith in 561.

Vandals.—This name, which was known to Tacitus, comprises various tribes of Teutonic and also of Slavonian origin, who lived in Eastern Prussia and Pomerania. The Slavonian tribes were subject to the Teutonic Vandals, who are often confounded with the Wends (Venedi), who afterwards occupied the country of the Vandals. The Vandals left their homes towards the end of the fourth century, and a part of them, after a sojourn in Pannonia, traversed Germany and Gaul, and founded the Vandal kingdom in Spain in 409. In 417 they subjugated the Alani, who had also settled in Spain. In 429 they were forced by the Visi-Goths to abandon this country, and they went over to Africa. Their king Genseric or Geiseric took Carthage (439), all Mauritania, and the islands of Sardinia, Corsica, the Baleares, and the western part of Sicily. On the 12th July, 455, they plundered Rome, and their name became proverbial as that of the most barbarous among the barbarians. Their kingdom lasted till 535, when it was destroyed by Belisarius, and became a part of the Byzantine empire. All the names of the Vandal kings are Teutonic, and resemble those of the Gothic kings, a fact which proves that however numerous the Slavonians were among them, the Teutonic tribes were the ruling nation. Their name is visible in that of the province of Andalusen or Vandalusia. (Papencordt, *Geschichte der Vandalen*.)

Longobards. [LOMBARDY.]—The Longobards lived on the right bank of the Lower Elbe, and afterwards on the left side of this river, near Lüneburg and Brunswick: in language and person they resembled their neighbours the Saxons, a strong body of whom appeared with them in Italy. Before they invaded Italy they had lived in the present country of Upper Hungary, in Pannonia, and in Noricum (494-568). Their king Alboin subjugated the Gepidae in Transylvania (563?), and in 568 he conquered the greater part of Italy. Their last national king, Desiderius, was deprived of his throne by Charlemagne (774), who assumed the title of king of the Longobards: but the Longobards neither lost their constitution nor their estates; the only change was in the reigning dynasty.

When the Longobards were subjugated by the Franks, they had possessed written laws for 130 years. The first collection was made by King Rotharis in 643. The laws of Grimoald were collected in 668, those of Luitprand between 713 and 724; those of Rachis in 746, and those of Aistulf in 754. They contain only a few heads of Roman law concerning prescription and succession. (Muratori, *Script. Rer. Ital.*, tom. i., p. 2; and especially Biener, *De Origine et Progressu Legum Jurumque Germanicorum*, i., p. 150, &c.)

These are the Teutonic nations that founded permanent kingdoms within the limits of the Roman empire. Except the Alemanni, they all came in contact with a population, the educated part of which was entirely Romanized, although, except Italy and some parts of the south of Spain and Gaul, the inhabitants of the villages were still Celts or Iberians when they were subjugated by the Teutonic invaders. (Fauriel, *Hist. de la Gaule Méridionale*, vol. i.) The political institutions of the new masters of the civilized world rested on two great principles.

The Teutonic laws were not territorial, as they now are, but personal: a Frank was judged after the Frankish law, a Burgundian after the Burgundian, wherever he lived. This principle being applied also to the Romans, gave rise

to a double legislation, one for the ruling Teutonic nation, and the other for the subject Romans. The second principle was that the sovereignty belonged to the body of the conquerors, and not exclusively to their king. The sovereignty not only comprised the supreme authority in legislation and administration, but it was considered as comprehending a right to the private landed property of the vanquished nation. Every free Frank or Goth became the master of a considerable portion of land which he took from the Romans. The rights and duties of the king towards their Teutonic fellow-conquerors remained the same as before; the kings had no right to punish any freeman, unless in time of war and for neglect of his duties. The freemen also could not be summoned to serve in any war to which they had not given their consent; and they did not pay any taxes to their king, but were only the first among their equals. As to the Romans, the Teutonic kings became the lords of a number of the civilized nation: as successors to the rights of the Roman emperors, and with regard to the Romans, they held private power, and they became proprietors of the private estates of the emperors. They maintained the provincial administration, which was established by Constantine the Great and his successors, but they often performed various functions on one person in order to render complicated administration more easy to manage. As conquerors lived among the subject people, each king had a double administration, one for the ruling nation and the other for the subject nation. But there was much confusion from this circumstance, that the kings were obliged, especially in Gaul, to sacrifice the part of the Roman administration, and to govern in the Frankish way, although the names of the higher public functionaries were Roman. The first functionary in each province was the Frankish king, the Dux, who had the military command, and sometimes also the authority of a judge. The second was the Comes, who was chief judge and director of all affairs concerning taxes and the revenue of the fiscus. From the eighth century the functions of Dux and the Comes were conferred upon one person, who is sometimes styled Dux, and sometimes Comes.

The fate of the Romans in the Frankish empire was threefold. One part of the Romans entered into private service of the king, and preserved a portion of their estates on condition of obedience to him. The great landowners belonged to this class, which had the name of 'Romani convivæ regis.' A second part, the 'Romani possessores,' remained in possession of their lands, but were obliged to pay taxes for them, a duty from which the conquerors were exempt: this class principally consisted of small landowners. The third class were the 'Romani tributarii,' who lost their liberty, although they became Servi in the Roman sense of the word: they were the ancient 'coloni.' In many towns the Romans continued to enjoy their municipal institutions. The Teutonic community gradually arose within the empire and had its separate constitution. In other towns the richest among the Romans lost their liberty and became 'ministeriales,' a kind of privileged vassals; but they were treated as the Romani tributarii in the villages.

The Teutonic nations which became subject to the Frankish kings were treated with less severity. The Burgundians, the Longobards, and the Bavarians only lost their dynasty, but the greater part of the Teutonic and of the Alemanni lost a considerable portion of their lands, which were given to Frankish nobles, of whom they became vassals.

Besides those nations which founded permanent kingdoms within the Roman empire, many tribes maintained their independence there only for a short period, or came and went rapidly without leaving further traces, or were subjugated by others, and adopted the names of their conquerors. Many among them were of Slavonian or other origin.

The Alani came from the Caucasus, traversed the Black Sea, and lived independent in southern Spain: King Respendial, from 409 to 417, when they were subjugated by the Visi-Goths and carried into the south of Gaul. Another part of them settled between the Garonne and Nantes under their chief Goar (406), but in 463 they were defeated and dispersed by the Visi-Goths. The Alani were not of Teutonic origin; the names of their kings (Respendial, Utacea, Goar) have no

rankish, or Gothic names. They are probably with the Ossetes or Iron, an old Persian tribe in al part of the Caucasus. The country of Albania, the Caucasus, was known to the Greeks and Roman Byzantines called the tract between the Terek and Alania. (Procopius, *De Bello Goth.*, l. iv.; *Memoriae Populor. 'Alania'*, in tom. iv.; Suhm, *te der Dänen*, übersetzt von Gräter, i. 1; Zeuss, *chte der Deutschen*, 'Alanen.')

uadi, who lived in Silesia and Moravia in 375, Suevoian people. The *Gepidae* perhaps were of origin; their kingdom in Transylvania was destroyed by Alboin, who killed Kunimund, the last king of the Gepidae.

Arminius, the commander of a band of *Scyrrri*, or *Scirri*, called *Heruli*, put an end to the Roman empire in the West, but he was put by order of Theodoric the Great in 493.

The *Scyrrri* were Germani; the origin of the *Scyrrri* and *Heruli* is uncertain. It has been pretended that the *Heruli* were a Lithuanian tribe.

within the limits of Germany which lost their Independence under the Franks.—The *Bojarii*, *Bojobari*, *Bajuvarians* [BAVARIA], whose name became known in the year 480, were a confederation of Suevoian tribes: the *Bojarii* between the Danube, the Lech, and the Ens. In the year 480 they were forced to yield to the Frankish kings, and were ruled by dukes of the dynasty of the Agilolfingians, which were collected between 613 and 630. The laws of the Alemanni, though they are only traces of the Roman law. (Mederer, *Leges Germanorum, oder ältestes Gesetzbuch der Bajuvarier*, 1-8.) The *Thuringians* occupied the country between the Bavarians as far as the Unstrut, and even to the Elbe river. They were related to the Goths, and their language seems to resemble that of the *Thervingi*, the *Thuringi*, and *Hermiones*. Their last king, Hermanfrid, was deposed by the Franks in 531. Charlemagne said to have made the first collection of their laws, but there is no evidence in support of this statement. The title is known under the title of 'Lex Angliorum et Thuringorum, hoc est Thuringorum.' These Angles and the *Werini* were settled in the northern part of Germany, but it does not appear why their names are mentioned before that of the *Thuringians*, who were the Germanic nation. This collection is brief and incomplete. (Leibnitz, *Script. Rer. Brunsvic.*, i., p. 81.)

Saxons; SAXONY; SAXONY] dwelt north of the Elbe. On the east their frontiers were the Elbe, the Baltic, and the Baltic; on the north, Denmark; on the west, the German Ocean, and Friesland; on the west, they corresponded to the western frontiers of the province of Westphalia. When they had sent their settlers to Britain, their power became considerable to their neighbours, the *Wends* in the north, and the *Franks* in the west. The *Franks* were united with them against the *Romans*, but when they conquered Gaul, the *Saxons* were obliged to submit to their incursions into this country, and hence to the loss of their independence and hostility. The south-western parts were conquered by the *Franks* as early as 555; the rich land-owners were compelled to give a considerable part of their property to the *Frankish* nobles, and the common freemen to the yoke of servitude. The remaining part of the population was free, though from time to time the *Saxons* paid tribute, until, after the memoranda of Duke Wittekind (772-803), Charlemagne became master of all Saxony. But the *Saxons* were not so obedient like the *Romans*. They promised to adopt Christianity, to acknowledge Charles as their king, and to give to the governors (*greves*) and bishops. On the other hand, they granted them equal 'Wehre' (value of their property) in case of wounds, murder, &c., and the privileges which the *Franks* had, especially freedom of trial, and the privilege of being tried in their own courts according to their own laws, and by their equals.

*Saxones patris et libertatis honore
Hoc sunt postremo sociati foedere Franci,
Ut geus et populus fieret concorditer unus.*

in Leibnitz, *Script. Rer. Brunsv.*, i. p. 153. Comber, *Osnabrückische Geschichte*, i. 3-40, the best which has been published about the old *Saxons* in

Germany. Charlemagne was the first king of the *Saxons*, who formed a great confederation of free communities; they appointed dukes for their wars, and only acknowledged obedience to the 'gouwing' and to 'greves,' chosen by the freemen among the 'edelings' of the communities. The laws of the *Saxons* were collected by order of Charlemagne. They consist of nineteen titles, and are so short and incomplete as to justify the opinion that only a part of them has been preserved. Two 'Capitularia' of Charlemagne concern the political and ecclesiastical condition of those parts of Saxony which were conquered at the time of their publication, 788 and 797. This 'Lex Saxonum' must not be confounded with the 'Sachsen-Spiegel,' the 'Mirror of the Saxons,' a code of Saxon law which was written in Latin and afterwards translated into the Saxon language by Eicke van Rebgo, between 1215 and 1218. (Gaertner, *Saxonum Leges Tres. Accessit Lex Frisionum*, 1730-4.)

Frisians [FRISIANS].—The *Frisians* were brought under the Roman power by Drusus, the brother of the emperor Tiberius. Olenius, their governor in A.D. 28, oppressed them by fiscal measures, and they cast off the Roman yoke. In the war between the *Romans* and *Claudius Civilis* they joined the latter. When the *Franks* invaded Gaul, the *Frisians* occupied some countries which were abandoned by the *Franks*, the islands between the mouths of the Schelde and the Rhine, and the present provinces of Gelderland, Zutphen, and Overijssel; and after the emigration of the Anglo-Saxons they gradually took possession of the coast and the islands of the German Ocean as far as Jutland. In 689 they were attacked by the *Franks* and obliged to pay them tribute. After the establishment of the German kingdom, the *Frisians* obeyed the king (emperor) as their sovereign, but they chose their own judges and other authorities. During the middle ages they formed the powerful republic of the Seven *Frisian* Sealsands, which was broken by the counts of Holland, of Oldenburg, and several other princes of the empire. The last independent *Frisians* were the *Dithmarschen* between the Elbe and the Eider, who were subjugated in 1559 by Christian III., king of Denmark, and Adolphus I., duke of Holstein.

The laws of the *Frisians* were collected by Charlemagne under the title of 'Lex Frisionum.' (Gaertner, *Saxonum Leges Tres. Accessit Lex Frisionum*.) The 'Statuta Opstalbonica,' the laws of the Seven Sealsands, which are written in the *Frisian* language, are a different collection. The dialect of this language which most resembles the Anglo-Saxon language is that of the northern *Frisian* islands on the coast of Sleswig. (Clement, cited below.)

Anglo-Saxons.—An account of their history has been given under the heads *SAXONS* and *ENGLAND*. The first settlement of Teutonic tribes in Great Britain previous to the arrival of the Anglo-Saxons has been treated with great learning by Dr. Clement, in his work 'Die Nordgermanische Welt,' Copenhagen, 1840. The author, who has travelled in all parts of Great Britain where he supposed he could find traces of such settlers, has paid particular attention to Caithness and the eastern coast of Scotland. With this book the reader may compare Finn Magnusen, *Om Picternes og deres Navns Oprindelse*, in 'Det Skandinaviske Litteratur-Selskabs Skrift,' 1816 and 1817.

The following works contain full information concerning the history of the Teutonic nations:—Mascov, *The History of the Antient Germans*, translated by Thomas Lediard; Gibbon, *Decline and Fall*; Eichhorn, *Deutsche Staats- und Rechts-Geschichte*; Savigny, *Geschichte des Römischen Rechtes im Mittelalter*; Grimm, *Deutsche Rechts-Alterthümer*, and his *Deutsche Grammatik*.

The Scandinavian branch of the Teutonic nations appears late in history. The Sagas tell us that in the fifth century B.C. Odin led the Scandinavians to Sweden and Norway; but this Odin is a god. Less fabulous is the history of a second Odin, who, in the beginning of our æra, came from Asia to Scandinavia, accompanied by his 'Asen,' or perhaps 'Ansen,' or fellow-warriors. The name of the *Suiones* or *Swedes* was known to Pliny and Tacitus, and Pliny knew the name of Scandia, now Scania, the southern extremity of Sweden, which name gradually acquired its present general meaning. Goths came to Scandinavia at a very early period, and the second Odin was perhaps their chief. They mixed with the Scandinavians, and traces of their language have been found in the dialects of the provinces of East and West Gothland in Sweden, and

their name is still preserved in many localities. The aborigines of Sweden and Norway belonged to the Finnish race. They fled towards the north, but not without leaving their traces in the mountains of the Kjölen and the Dovre Fjeld.

The Scandinavians, Northmen, or Normans, became known to the southern nations by their piracies, and they were often leagued with the Saxons. In the wars between Charlemagne and Wittekind, the Danes assisted Wittekind, who had married Gera, the daughter of their King Siegfried. As early as the beginning of the eighth century the Danes and Jutes appeared in the north of England; in the beginning of the ninth century the Danes settled on the south-east coast of Ireland. Normans or Norwegians occupied the Orkneys before the end of the ninth century; in 861 they came to the Farø Islands, and they sent colonies to Iceland as early as 870. The northern parts of North America were known to these bold navigators four centuries before the time of Columbus. Other Normans conquered Normandy, Apulia, Sicily, and the opposite coast of Africa. From the eighth century the Waregians, who came from Norway and Sweden, penetrated into Russia and founded the Norman dynasty of the grand-dukes of Kiev: some of the first families of the Russian nobility are of Norman origin.

The Swedes conquered the coast of Finland as early as 850, and settled in great numbers in the districts of Abo and Nyland. Although Finland is chiefly inhabited by a nation of Finnish origin, and though it has become a Russian province, the Swedish language is the only language used for public acts and legal documents. [SCANDINAVIAN LANGUAGE.]

Suhm is one of the best authorities for the critical history of the Scandinavians. He has written in Danish on the origin of the Scandinavians, on their mythology, a critical history of Denmark, a history of Denmark, and several other works concerning this country.

(Müller, in his *Kritisches Examen der Dänischen und Norwegischen Sagengeschichte*, examines the historical truth of the Sagas; Peringskjöld, *Monumenta Sævo-Gothica*, Stockholm, 1710, fol.; Peringskjöld, *Wilkina Saga, sive Historia Wilkinensium*, contains an account of the exploits and conquests of the Scandinavians in Russia, Italy, &c.)

Table of the modern Teutonic Languages and their Dialects.

I. HIGH GERMAN LANGUAGES.

(The German language as it is written or spoken by the well-educated Germans, belongs to the High German languages, but is not a dialect.)

A. *Swabian* branch.

- a. *Swabian* subordinate branch, containing the dialects of
 - 1, *Swabia*, that is, of the Black Forest, of the Neckar, and of the country between the Danube and the Lech.
 - 2, *Bararia*, that is, of the Alps, of Salzburg, and of the Danube.
 - 3, *Tyrol*, that is, of Vorarlberg, of the Inn, of the Etsch (Adige), and of the Puster-Thal.
 - 4, *Austria*, that is, of the archduchy of Austria, of Styria, of Carinthia, of Carniola, of Southern Bohemia, and of Moravia.
- b. *Allemanic*, subordinate branch.
 - 1, *Allemanic*, commonly so called in the south-west corner of the Black Forest.
 - 2, Dialects of *Switzerland*, that is, of Bern, of the Oberland of Bern, of Wallis, of the country of the Grisons, and of Appenzell, &c.
 - 3, Dialects of *Elsass* (Alsace) and of *Baden*.
- c. *Old Thüringian*, subordinate branch, containing the dialects of the Thüringer Wald, of part of the Fichtelgebirge, and of the northern part of the Böhmerwald. These dialects are generally confounded with those of the adjacent flat countries of Thüringia and the Upper Palatinate, which belong to the Franconian branch.

B. *Franconian* branch.

- 1, Dialects of *Franconia*, of the Palatinate, of the Middle Rhine, and of Southern Hesse.
- 2, Dialects of Thüringia, except the Thüringer Wald, of Northern Hesse, and of the Eichsfeld.
- 3, Dialects of *Lorraine* and *Luxemburg*, which are much mixed with Low German.
- 4, Dialects of Upper Saxony, of Meissen, of the Erzgebirge, and of Lusatia.
- 5, Dialects of Northern Bohemia, of Silesia, and of part of the German colonies in Hungary.

- 6, Dialects of the nobles, the clergy, and the citizens of Curland, Livonia, and Esthonia.

II. SAXON LANGUAGES.

- A. *Frisian* branch, which contains the dialects of *West Friesland*, of *Saterland*, of the islands along the Dutch and the German coast, and of the islands along the coast of Sleswig.
- B. *Low German* branch, divided into six sections:
 - 1, Of *Lower Saxony*, containing the dialects of *Holstein*, of *Hamburg*, of *Bremen*, of *Brabant*, of *Hanover*, of the country between the *Harz*, *Weser*, and of the *Marshes with East Frisia*.
 - 2, Of *Westphalia*, with the dialects of *Upper land*, of *Lower Münsterland*, of *Osnabrück*, of *Upper Weser*, of *Sauerland*, of *Mark*, and of *East Berg*.
 - 3, Of the *Lower Rhine* between *Neuwied* and *Düsseldorf*, especially the dialects of the *Eifel*, of *Cologne*, and of *Aix-la-Chapelle*.
 - 4, Of the *Netherlands*, containing the *Dutch language*, and the dialects of *Jülich*, *Cleve*, and of *Geldern* in Germany.
 - 5, The dialect of the Saxons in *Transylvania*.
 - 6, Of the ancient *Wendish* countries, colonized by Saxons, containing the dialects of *Mecklenburg*, of *Pomerania*, of *Brandenburg*, of the *Marks*, and of *Prussia*.

C. *English* branch. [SAXONS: ENGLAND.]

III. SCANDINAVIAN LANGUAGES.

- A. *Old Norman* branch, containing the dialects of the mountaineers of Norway, the Icelandic language, and the idiom of the Farø islands.
- B. *Danish* branch, containing the Danish language, and the dialects of the islands, of *Jutland*, and of *North Sleswig*, and the modern Norwegian language.
- C. *Swedish* branch, containing the Swedish language, and the dialects of *Gothland*, of *Dalecarlia*, of *Stockholm*, and the adjacent country, of *Finland*, and of the islands.

(Adelung und Vater, *Mithridates*: Balbi, *Atlas Ethnographique*; Ober-Müller, *Atlas Ethno-géographique l'Europe*, Paris, 1841.)

TEVERONE. [PAPAL STATES.]

TEVIOTDALE. [ROXBURGHSHIRE.]

TEWKESBURY, an ancient market-town and municipal and parliamentary borough in the north-western Gloucestershire, close to the borders of Worcestershire 9 miles from Gloucester and 103 from London. It is situated on the eastern bank of the Avon, near its junction with the Severn; and the small rivers Carron and Swilgate which are tributaries of the Avon, flow through the town. The immediate neighbourhood of the town is subject to floods. Within half a mile of the town is a handsome iron bridge of one arch, 172 feet span, over the Avon, and there is an ancient bridge of several arches over the Avon, with a causeway leading from it to the above-mentioned iron bridge. The Carron is crossed by a stone bridge, and the Swilgate by two. The parish extends about 4 miles from north to south, and its width at the extreme breadth. Immediately to the north of the town the width of the parish is only half a mile. The Avon has been diverted by an artificial cutting to form a New Avon, or Mill Avon. The parish contains 1,200 acres, with the hamlets of Southwick in the south-west and that of Mythe in the northern part. Tewkesbury is a borough by prescription: it received its first charter of incorporation from Queen Elizabeth in 1574. By the charter of William III., granted in 1698, the jurisdiction of the borough magistrates was extended over the whole of the parish. It has returned two members to parliament since the 7 James I. Before the passing of the Reform Act, parts of the town, particularly on the eastward, were not comprised within the limits of the parliamentary borough, but the whole parish is now included. The number of voters was formerly in the freemen and burgage holders and inhabitants paying scot and lot. The number of electors on the parliamentary register in 1840 was 409, including 89 who possessed double qualifications; and former number, 238 were occupiers of houses rated at £10 and upwards. The town is not divided into municipal wards. The corporate body consists of a mayor, 12 aldermen, and twelve councillors. The old corporation

posed of a high-steward, twenty-four principal burgesses, including in that number two bailiffs and the recorder; and there were besides several minor officers, such as constables, and justices for the borough. The appointment of our assistant burgesses was directed by the charter of William III., but none had been elected for many years prior to the passing of the Municipal Corporation Reform Act. The twenty-four burgesses were elected by the bailiffs and burgesses out of the burgesses. The annual income of the old corporation did not exceed £22, and in 1828 it was in debt to the amount of £1,000. The sum of £2000 was advanced by the recorder, the property of the corporation conveyed to him, on the condition that the creditors were paid 6s. 8d. in the pound. Quarterly meetings for the borough are held, and there is a court for the recovery of debts under £50.

Tewkesbury is said to be of Saxon origin, and to derive its name from Theot, a Saxon, who founded an hermitage in the seventh century. Early in the eighth century the Mercians, dukes of Mercia, founded a monastery, which, in the tenth century, became a cell to Cranbourn Abbey in Wiltshire. In the twelfth century Robert FitzHaimon, Earl of Hereford, the buildings and liberally endowed the institution, the consequence of which the monks of Cranbourn Abbey considered Tewkesbury the chief seat of their establishment. At the dissolution the abbey belonged to the Benedictines, and its annual revenue was £598. A great battle was fought on the 14th of May, 1471, within half a mile of the town, when the Lancastrians sustained a most disastrous defeat, and both Queen Margaret and her son Prince Edward were taken. The town was successively in the hands of the royalists and parliamentarians at the commencement of the civil war; but in 1644 it was taken by the parliamentarians, and held until the close of the war.

The town principally consists of three good streets, well lighted, and a number of smaller ones branching from them. According to the census of 1831, the population amounted to 10,000.

The principal manufacture is the cotton and wool hosiery. In 1810 the number of stocking-frames in the town was 800; and in 1833 there were 600. The wages averaged 12s. in the former year, and 7s. in the latter.

The number of men, aged 20 and upwards, employed in the stocking manufacture in 1831 was 300 (*Pop. Rep.*), and 44 were engaged in the lace manufacture. The silk-throwing formerly employed a considerable number, but in 1833 there were only 50 persons so occupied. (*Municipal Reports.*)

Tewkesbury was and is still the centre of the extensive carrying-trade on the Severn and Avon; but the improvement of the navigation of the Severn to Gloucester by means of a ship-canal, is said to have been injurious to Tewkesbury, and to the improved means of inland navigation in other towns in the same district is also owing to some decline in the attendance at the corn-market. A new bridge across the Severn, which opened a communication with Hereford and Wales, counterbalances on the other hand the effects of the above-mentioned improvements. There is a branch railway from Tewkesbury to Birmingham more than two miles in length, which joins the Birmingham and Gloucester Railway. The collegiate church of St. Andrew's monastery is now the parish church. It is an ancient and venerable structure, in the early Norman style, and consists of a nave, choir, and transepts, with a tower on the west end, supported on massive and lofty piers, and decorated with circular arches. The roof is finely groined and carved. There are several ancient chantry chapels in the east end of the church, which is hexagonal. Some of the monuments are in memory of persons who fell at the battle of Tewkesbury. The living is a vicarage, of the gross annual value of £1,000. A new church was opened in 1837. All the principal sects of dissenters have places of worship. There is a grammar-school with an endowment of £52 a year. The school is appointed by the corporation. When the commissioners visited Tewkesbury in 1833, the master of the school and one of the borough justices, and for many years the school had not been attended by more than four pupils. In 1833 there were, besides the above, 10 boarding-schools, 12 daily schools in the parish, 11 by 607 children, and several Sunday-schools, at which 88 children were instructed. The national school is supported by an ancient endowment for the instruction of 20 children, and a Lancasterian school is dependent on the same contributions. There are almshouses for 10 persons, and several medical and other charities of com-

paratively recent date. The town-hall was built in 1786: the upper part contains an assembly-room and a hall for the meetings of the corporation; and the lower part is appropriated to the borough courts. A gaol, house of correction, and penitentiary were erected under a local act passed in 1812. The market-house is a handsome building, with Doric columns and pilasters supporting a pediment in front. There is a small theatre and public library and news-room. The town is paved, lighted, and watched under a local act passed in 1786. The market-days are Wednesday and Saturday: the former for corn, sheep, pigs, &c.; and the latter for poultry and provisions. There are fairs in March, April, May, June, September, October, December; and a statute fair at Michaelmas.

(*Dyde's Hist. of Tewkesbury; Pop. Returns, 1831; Reports of Ecclesiastical Commissioners and of the Municipal Corporation Commissioners, &c. &c.*)

TEXAS. Since the publication of the article on Mexico [**MEXICAN STATES, THE UNITED**], Texas, which was then merely an insurgent province of that republic, has been recognised as an independent state by the leading powers of Europe and America. A succinct statement of the revolution by which this change has been effected is necessary.

A decree of the Constituent Cortes of Mexico, dated 7th May, 1824, declares that Texas shall be annexed to Coahuila until it possess the elements necessary to the formation of a separate state; but that as soon as it shall possess these elements, the connection is to be dissolved, and a separate state-constitution given to Texas.

At the time when this decree was published, Texas probably did not contain 4000 inhabitants of the European race. The district of Bexar, which in 1806 contained 6400 colonists from Mexico, was found in 1835 to contain only 3400 of that class, scattered over the settlement of San Antonio, the missions, and frontier military posts; and this process of depopulation had reached its lowest ebb for some time before the latter date. In the districts of Brazos and Nacogdoches there were, in 1824, no inhabitants of European descent, except at the military posts.

The government of Mexico had made efforts, both while the country was a Spanish colony, and after the recognition of its independence, to promote the settlement of Texas by the *Empressario* system of colonization, *i.e.* by granting tracts of land to individuals, who were to forfeit the grant unless they settled a specific number of colonists on them within a limited period. In furtherance of this policy, permission was given by the supreme government of the eastern internal provinces, on the 17th of January, 1821, to Moses Austin, by birth a citizen of the United States, to introduce into Texas from Louisiana 300 families, 'being Catholics, or agreeing to become so on entering the Spanish territory,' and also agreeing to take the oath of allegiance to the crown of Spain; and a tract of land in the vicinity of the Brazos river was granted them to settle upon. Some difficulties arose from the disturbed political state of Mexico at that time; but in 1824 colonising operations were begun by Stephen, the son of Moses Austin (his father having died in the interim); and on the 24th of March, 1825, a colonization law for Coahuila and Texas was promulgated. In the course of 1825 and 1826, seven more *Empressario* grants were made, and the parties obtaining them became bound to introduce about 2000 foreign families, under the same conditions as had been prescribed to the Austins.

Under these grants the colonising of Texas from the United States proceeded with such rapidity, that in 1835 Colonel Almonte, a commissioner of the Mexican government, reported the population of the province to be as follows:—In Bexar, 4000 inhabitants of European origin, of whom 3400 were Spanish Mexicans and 600 Irish settlers; in Brazos, 8000, of whom 1000 were negroes, almost exclusively colonists from the United States; in Nacogdoches, 9000, of whom 1000 were negroes, also Anglo-American colonists. In addition to these, Texas contained about 15,000 Indians, of whom 4000 were friendly to the European race and 11,000 hostile. About 10,000 of the hostile Indians haunted the district of Bexar, the rest were scattered over the district of Brazos. The Mexican commissioner remarked in his report that the part of Texas which presented the greatest difficulties to travellers was that which lay between the frontiers of Coahuila and San Antonio de Bexar: the province was

isolated from the rest of the Mexican provinces, and had an easy communication with New Orleans. The balance of commercial enterprise and wealth was also in favour of the two districts which lay nearest to the United States, and had been colonised from them. The whole trade of Texas in 1834 he valued at 1,400,000 dollars, of which 600,000 belonged to Brazos, 470,000 to Nacogdoches, 270,000 were invested in the smuggling trade of these two districts, and only 60,000 belonged to the Spanish Mexican district of Bexar.

Various incidents had concurred between 1824 and 1835 to excite repulsion and distrust between the Anglo-American colonists on the one hand, and the settlers of Spanish descent and the Mexican government on the other. It had been made one of the conditions of the *Empressario* grants that schools for teaching the Spanish language should be erected in all the new settlements. This had been entirely neglected. The wealthier settlers of Brazos and Nacogdoches sent their children to be educated at New Orleans, and the poorer gave theirs no education at all. The system of settling some hundreds of families of the new comers in the same neighbourhood, subject to a certain degree of control from the *Empressario*, further contributed to prevent their amalgamating with the Spaniards. They continued thoroughly English in their language and customs. Religion too became a means of increasing the mutual repulsion: the new-comers had no objection to call themselves Roman Catholics, but they were lax in their observance of religious duties, and this irritated the priests and brought the Spanish settlers to regard them as persons of indifferent character. On the other hand, the settlers from the United States were chafed by the stringent custom-house regulations and semi-military government of Mexico. The question of negro slavery, too, added to their sources of discontent. By the fifteenth article of the treaty of amity and commerce between Great Britain and Mexico, the government of the latter country engaged to prevent all its subjects from taking part in the external slave-trade. The rule was relaxed in favour of the colonists from the United States, so as to allow their bringing their slaves with them; but the restrictions under which this permission was granted occasioned constant collisions between them and the officers of the customs. The decree of 29th September, 1829, abolishing slavery throughout the Mexican dominions, occasioned great discontent in Texas.

The government viewed the increasing numbers and wealth of the Anglo-American colonists with jealousy, partly on account of their democratic propensities, partly on account of its suspicion that the government of the United States was bent upon acquiring Texas. The Scotch and New York masonic lodges at Mexico had become in a great measure mere instruments of the federal and centralising factions; and Poinsett, the American envoy at Mexico, had not only been instrumental in founding the New York lodge, but had persisted in taking a part in the internal political contests and intrigues of Mexico, which was quite inconsistent with his diplomatic character, and ultimately led the Mexican cabinet to insist upon his removal. The *Escoques*, the party attached to a centralised system of government, were then in the ascendant, and they not unnaturally regarded every American from the United States as a *Yorkino*, a democrat or adherent of a constitution which left each individual state more independent of the central authorities in Mexico. The settlers in Texas seem to have taken little concern in politics. When Heyden Edwards and his confederates made their mad attempt to establish an independent republic in Nacogdoches in 1826, Stephen Austin and his colonists rendered prompt and efficient assistance to the Mexican authorities. But on account of their origin they were viewed with the same suspicion as the rest of their countrymen.

The opinion that the United States were anxious to annex Texas to their territory had more appearance of foundation. Aaron Burr's project of revolutionising Spanish America in 1805 had not been forgotten. In 1825 the envoy of the United States at Mexico had been instructed to sound the government on the question of transferring the frontier between the two republics from the Sabine to the Rio Grande or the Colorado. In 1827 he had been authorised to offer the Mexican government a million of dollars for the frontier of the Rio Grande, and

half that sum for the frontier of the Colorado. He received directions to increase his offer to five millions for the frontier of the Colorado. This pertinacity of the government of the United States naturally drew the Mexican government to view with apprehension the growing strength of the Anglo-American colonies in Texas.

In 1830 the irritation on both sides was evidently increasing about a crisis. The military posts on the frontier were strengthened, and new posts were established in the districts and at the trading stations on the coast. The number of Mexican soldiers in Texas was about 1300, and placed under the command of local chiefs of Bexar, Brazos, and Nacogdoches, the latter being intrusted with the supreme command. On the 6th of April, 1830, Bustamante promulgated a decree prohibiting all citizens of countries adjoining the territories to settle as colonists in the territories immediately adjacent to these countries. He also decreed that the newly arrived settlers from the United States and those who were on their way were to be removed to serious inconvenience and loss. On the 10th of April, Colonel Austin, the enforcement of the decree was opposed by the local authorities: the colonists refused to take possession of their lands, but they retained their titles in only two of the seventeen settlements which were already established in Texas.

After the government had thus unsettled the minds of the most numerous and wealthy portion of the population, a revolution was inevitable; but as is generally the case, the first hostile collision between the citizen and government forces was occasioned by one of the more trivial grievances. An attempt made by the governor Anahuac to arrest an Anglo-American colonist, a military and the settlers of Nacogdoches, each other in June, 1832. The insurgents then captured the post at Velasco, intercepted the chief of Nacogdoches on his way to relieve Anahuac, and forced him to surrender, and the governor of that fort to fly from the country. The colonists who had a short time before promulgated a constitution called 'the plan of Vera Cruz,' and thus by the aid of a Federalist party around him obtained possession of the government, had on the first intelligence of the revolution in Texas dispatched Colonel Mexico with a detachment of that province, who was accompanied by Gomez Farias, representative of Texas in the Mexican legislature. He was satisfied with the explanation that the insurgents gave of their proceedings; and the tranquillity restored, the whole of Texas declared for 'the plan of Vera Cruz.'

In October, 1832, a convention assembled at San Antonio de Austin to frame a memorial to the Central Government for the separation of Texas from Coahuila and for the repeal of the law of 1830 which suspended the constitution. In 1833 another convention met at San Antonio to place to frame a state constitution to be submitted to the approbation of the Central Government. Gomez Farias was appointed commissioner for the province to present and support those memorials. At Mexico he found things in confusion; and on the 2nd of October he wrote to his constituents, advising them to organize a government. The contents of this letter had not reached the knowledge of Gomez Farias, the president was arrested on the 10th of December and carried back to Mexico, where he was imprisoned.

The Texans now attached themselves to the Federalists who had quarrelled with Santa Anna and his state convention of Coahuila and Texas was held at San Antonio, in November, 1834, but the apathy of the Spaniards of Coahuila nothing was done. The more energetic Anglo-American population of Texas began to feel themselves impeded by their connection with Coahuila, and a wish for separation gained ground. In April, 1835, a meeting of the joint legislature of Texas and Coahuila was brought about, and a petition in favour of a Federal constitution agreed to. Santa Anna then marched against Coahuila: the state authorities were tempted to retreat with the archives into Texas; the governor was taken prisoner, the government dissolved, and a military commission installed at Saltillo in Texas, which was virtually left without any government.

appeal to arms was precipitated by a custom-house attack was made under some pretext or another at the custom-house at Anahuac. Captain Thompson, sent by the Central Government, in June, 1835, on the request of the Ayuntamiento of that place, in the *Arcturion*, a schooner, to inquire into the affair, precipitated an attack and captured a Texan trading-vessel. The crew of the prize armed another trading-ship, took possession of it, and sent the captain to New Orleans under a flag of truce, piratically interrupting the trade between the States and Texas. In the month of August Santa Anna ordered the Texans to deliver up Zavala, a leader of the liberal party, who had been his friend and suppliant ally; but he remained faithful to the plan of Vera Cruz, and latterly his enemy. The request was refused, and Santa Anna soon after reached Texas that Santa Anna was about to invade it.

Affairs were in this position, Stephen Austin returned to Austin at a public dinner in Brazoria, on his return from his long captivity. Austin had, as long as he could, done his utmost to prevent the discontented settlers assuming a political complexion, and it was not until it was no longer possible, had steadily opposed measures that seemed to point at a separation from Texas.

The advice therefore which he gave on this subject was to organise committees of safety and vigilance in every part of the province, was at once and implicitly followed. He was himself appointed chairman of the committee for his own colony, to which a degree of control over other committees was tacitly conceded. Before the organisation of the country was completed hostilities commenced between the colonists and the military in consequence of which Austin, in the beginning of October, assumed the command of an army hastily raised at Gonzales, and Zavala was appointed chairman of the Austin committee in his stead.

On the 3rd of October, 1835, General Barragon issued a decree abolishing the legislative powers of the several counties and establishing a central republic in Mexico. A consultation of Texan delegates was, in consequence of this measure, held at Austin, which, on the 7th of November, issued a declaration in favour of state-rights; and a convention of delegates to be held at Washington, on the 1st of February next; and an interim government. Henry Smith was appointed governor and W. Robison lieutenant-governor; Houston was appointed major-general and commander-in-chief of the regular army of Texas; and Stephen B. T. Archer, and W. H. Wharton were appointed members to the United States.

The new commander-in-chief immediately established his headquarters at Washington. In January, 1836, Austin reported that he had concluded a loan at least of 200,000 dollars, and had hopes of raising 400,000. Volunteer troops in aid of the regulars were raising in Louisiana, Tennessee, Alabama, and Georgia. The Convention met at Washington on the 1st of February, and on the 2nd of March it published a declaration of independence, signed by fifty delegates, of which Lorenzo de Zavala was one. In the election of officers of state which immediately followed, Zavala was vice-president.

Santa Anna marched from Saltillo on the same day that the Convention met at Washington. He was successful in his encounters; but on the 21st of April he was defeated and taken prisoner by General Houston. On the 22nd of May he signed a convention for the evacuation of Texas, and soon after not a Mexican soldier remained in Texas. The constitution adopted by the new state is a modification of the state government of the Northern States, and, like its prototype, presents the anomaly of existing under laws which profess to regard all men as equal.

Texas was recognised as an independent republic by the President of the United States on the 3rd of March, 1837. It was made in congress for receiving it into the Union, and some discussion withdrawn. France recognised the independence of Texas and concluded a treaty with it on the 5th of September, 1839. A treaty of amity and commerce between England and Texas was signed in London, on the 6th of November, 1840, and ratified by the Texan government in February, 1841. The Mexican government expressed a determination to reconquer Texas; but it

is not likely that in the distracted and impoverished state of that country it will be able to reduce a population almost inaccessible by land from Mexico, possessed of better harbours and more shipping, in a position to receive constant support from the United States even against the will of the government at Washington, and on terms of alliance and amity with England, France, and the United States. Nor is it to be desired that Texas should on any terms be re-annexed to Mexico: its Anglo-American population never could assimilate with the Spanish Mexicans.

(*Texas*, by William Kennedy, London, 1840; Colonel Almonte's *Report on the Statistics of Texas*, Mexico, 1835; *Correspondence of the daily Papers of London and Paris*; *Debates in the British Parliament, the Congress of the United States*, and *French Chamber of Deputies*.)

TEXEIRA, or TEXERA, JOSEPH, was born of a good family in Portugal, about the beginning of 1543. After distinguishing himself at the University, he entered the order of St. Dominic in 1565, and obtained general respect for his learning and virtue. He was prior of the convent of Santarem in 1578, when King Sebastian undertook his expedition into Africa.

In the troubles which ensued, Texeira attached himself to the party of Don Antonio, and accompanied that prince to France in 1581, where he went to solicit assistance against Philip II. Texeira published at Paris, in the beginning of 1582, a compendium of the history of Portugal. The work is very scarce (it is described as a thin quarto of 70 pages), and appears to have been published for the purpose of supporting Don Antonio's claim to the throne of Portugal. The author was taken prisoner by the Spaniards in the naval battle off Terceira on the 26th of July, 1582, and carried to Lisbon, whence he contrived to make his escape and rejoin Don Antonio. Duard Nonius à Leone, a converted Jew, employed by Philip II. to refute the 'Compendium of Portuguese History,' asserts that Texeira, while a prisoner at Lisbon, denied to him that he was the author.

The partisans of the League having obliged Don Antonio to quit Paris, Texeira accompanied him as his confessor, first to Bretagne, and in 1586 to England. In 1588, having returned to France, he was introduced to Henri III. and the queen-mother: the former appointed him a court chaplain; the latter dispatched him on a confidential mission to Lyon, then in the possession of the League, believing that a Dominican friar was unlikely to be suspected of being an agent of the court. Texeira remained at Lyon from July, 1588, to January, 1589. During this interval he prepared for publication a reply to the attack upon his History by Nonius à Leone. This pamphlet, or some indiscreet expressions in conversation, having given umbrage to the Leaguers, he was obliged to fly; the papers left in his cell were seized, and the whole impression of his pamphlet (with the exception of one or two copies) destroyed.

He rejoined Henri III. at Tours, and after the murder of that prince, in August, 1589, was continued in his office of court-chaplain by Henri IV., to whose service he attached himself. After the entry of Henri into Paris, Don Antonio was enabled to return to that city, and Texeira appears to have resumed his office of confessor. In March, 1595, he published a new edition of the work which had been destroyed at Lyon, but his labour was in vain, for he was called, in the August following, to perform the last service of his church to the prince whose cause he had advocated with such fidelity.

In 1596 Texeira was a witness of the public abjuration of Calvinism by the dowager-princess of Condé at Rouen. The Papal legate selected him to instruct and confirm the princess in her new faith; and from that time till his death he continued attached to the service of the house of Condé. This engagement left him pretty much the command of his own time, and he employed it principally in his favourite study of genealogy. A list of his published works will be found at the end of this article: here it is only necessary to remark that to the second edition of his 'Genealogy of the House of Condé,' published in 1598, he added an account of the public ceremonial of the princess's reconciliation with the Roman Catholic church.

In 1601 he published a narrative of the adventures of Don Sebastian, 'from his expedition into Africa in 1578, till the 6th of January of this present year 1601.' We have

not been able to procure this work; but the following passage from Etoile's 'Journal of the Reign of Henri IV.' throws some light upon the expression quoted from its title-page:—'Friday, the 1st of June, 1601, comes the intelligence that the false or true Don Sebastian (for as yet one knows not which to call him) has been sent to the galleys by order of the viceroy of Naples. . . . The Portuguese maintain that he is the true Don Sebastian: they have solicited various courts to obtain his liberty, and published several works in his favour. Among others Joseph Texeira, a Dominican, has undertaken several journeys to Bavaria, England, Venice, and Rome, where he has disseminated his writings; and finally, he has caused to be printed at Paris a collection of prophecies current among the Portuguese, which foretold all that has happened to their king Sebastian.' That Texeira, whose writings show him to have been an accomplished scholar, whose confidential employment by Catherine de' Medici is a strong testimony in favour of his abilities, and whose high moral character is acknowledged on all hands, should have believed the individual here mentioned to have been the real Don Sebastian appears upon first thoughts a strong testimony in his favour. But L'Etoile's account of the nature of the book weakens the presumption, and Texeira's inveteracy against the Spaniards renders it probable that the account is correct. He is said to have declared from the pulpit, when preaching on the duty of loving one's neighbour, that 'we are bound to love all men, of whatever religion, sect, or nation—even Castilians.'

Texeira died in the convent of the Jacobins at Paris, on the 29th or 30th of June, 1604. L'Etoile, who mentions his death, says, 'He had just returned from England, whither he had been sent by the king, who gave him a hundred crowns for the expenses of the journey. While there he had seen the king of England, to whom he presented his "Genealogy" which he had compiled, and which was well received. He was on the eve of returning to England when he was taken ill.' Texeira's frequent visits to England, both in the time of Elizabeth and James, gave rise to suspicions of his attachment to the Romish Church. For these there does not appear to have been any reasonable ground: he was opposed to the ultra-Romanist party of the League in France, because it was allied with Philip II., but his religious opinions never appear to have varied.

The published works of Texeira are—1, 'De Portugalliae Ortu, Regni Initio, denique de Rebus à Regibus universo regno praeclare gestis Compendium,' Parisii, 1582, in 4to., 77 pp., very rare; 2, 'De Electionis Jure quod competit viris Portugallensibus in augurandis suis Regibus ac Principibus,' Parisii, 1590, 8vo.: this is a reprint of the answer to Nonius à Leone, printed and destroyed at Lyon in 1589: a third edition was published at Paris in 1595, with the title, 'Speculum Tyrannidis Philippi, Regis Castillae, in usurpanda Portugallia'; 3, 'Exegesis Genealogica, sive Explicatio Arboris Gentilitiae invictissimi ac potentissimi Galliarum regis Henrici ejus nominis IV.' This work was published at Tours in 1590; at Leyden, with additions, in 1592; again at Leyden in 1617, with the title, 'Stemmata Franciae item Navarrae Regum à prima utriusque Gentis Origine;' all the three editions are in 4to.; 4, 'Explicatio Genealogiae Henrici II., Condae Principis,' Paris, 1596. An edition in 4to., and another in 8vo., and a translation into French by Jean de Montlyard, all appeared in the same year. To the edition of 1596 was appended 'Narratio in qua tractatur de Apparitione, Abjuratione, Conversione, et Synaxi Illustrissimae Principis Charlotte Catharinae Timolliae, Principissae Condae;' 5, 'De Flammula, seu Vexillo S. Dionysii, vel de Orimphla aut Auriflamma Tractatus,' Paris, 1598, 8vo.; 6, 'Adventure admirable par devers toutes autres des Siècles passés et présents, qui contient un Discours touchant les Succès du Roi de Portugal, D. Sebastian, depuis son voyage d'Afrique, auquel il se perdit en la bataille qu'il eut contre les Infidèles en 1578, jusqu'au 6 de Janvier présent, an 1601;' traduit du Castillan, Paris, 8vo.

(This sketch has been compiled from the dictionaries of Bayle and Moreri, and Nicolaus Antonius; from the Prefaces to Texeira's 'Genealogy of Henri IV.,' and his Reply to Nonius à Leone; and from Pierre de l'Etoile's 'Journal of the Reign of Henri IV.,' vol. ii., pp. 559-61, and vol. iii., pp. 194-6, edition published at the Hague in 1761, in 4 vols, 8vo.)

TEXEIRA, or TEXERA, PEDRO, a native of Bagdad, one of the earliest cultivators of modern Persian literature. The place and date of his birth and death are unknown. The author of the notice of his life 'Biographie Universelle,' says that he was born in Bagdad, but does not mention the authority on which he states this.

Cotolendi, who translated Texeira's work into French, states that his author, 'instigated by a vehement desire to become acquainted with the history of Persia, spent several years in that country, and having become perfectly master of the language, devoted himself to the study of some able and enlightened Persians, to whom he gave the name of Mirkhond. [See the account of this history in the article PERSIA, under the head Literature.] Texeira himself has informed us that being at Malacca, in the month of January 1600, he embarked in the month of March for the Philippine Islands, whence he took shipping for Europe, and ultimately arrived at Lisbon on the 29th of August 1601. His correspondents in the East having transmitted to him some money which he had left in their charge, he was obliged to undertake a voyage to recover it. Disgusted with the sea, he resolved to go overland; and having in pursuance of his plan sailed from Goa, on the 9th of February, 1602, he arrived at Basrah on the 6th of August (being detained at Ormuz), he travelled by way of Meshed-Ali, and thence to Anna, Aleppo, and Scanderoun, whence he took shipping for Venice. After a short stay in Venice he made the tour of Italy, crossed the Alps, and then retired to Antwerp, where he spent the remainder of his life in compiling a book, which he published in 1603, and that event we again lose sight of him entirely.

His work, the first book of which, we are told, was by Antonio de Leon Pinelo, was composed in Persian, translated into Spanish, and the rest written in French, with a view to publication, is entitled 'Historia de los Reyes de Persia y Ormuz: Viage de la India y de la hasta Italia por Tierra el año de 1604,' Antwerp, 1603. Antonio says it was published in 4to.; Antonius says that it was published in 8vo. It consists of two parts: the first is a history of the kings of Persia, from Mirkhond with a brief continuation, down to the time of the compiler; the second is an abridgment of the history of the Ormuz, by Turan-shah, one of the kings of Persia. The work which appears to be known in Europe as Texeira's abstract, also with a continuation, is an account of Texeira's overland journey from Lisbon to Europe. Alfonso Lasor translated the work and inserted it in his *Orbe Universal* the first of which it was published; Schikhart, in his 'Geograph. Regum Persiae,' published at Tübingen in 1604, in the highest terms of Texeira's learning and industry; Van Lact appended a Latin translation of Texeira's history from Ormuz to Basrah and Bagdad to his *Geograph. Regum Persiae*, published at Leyden in 1633; Cotolendi published a French translation of the entire book at Paris in 1603, which the writer in the 'Biographie Universelle' characterises as 'assez mauvaise.' In short, down to the time of Tavernier and Chardin, Texeira appears to have been regarded as the principal authority respecting Persia. The historical part of his work is now of little value, but his voyage up the Persian Gulf, and his observations on Basrah to Meshed-Ali, Bagdad, Anna, Aleppo, Scanderoun, may still be studied with advantage.

Antonio and Leon Pinelo mention a book entitled 'Fragio de Jorge Albuquerque e Prosopopeia a seu rio de Bagdad,' published at Lisbon in 1601, by a Peter Texeira, but not identify him with our author. A 'Certificado de Descubrimiento de el Marañon,' by a Pedro Texeira, 'Capitan Maior del Pará,' is appended to the account of the discovery of that river, published at Madrid in 1601, by Christoval de Acuña: this was apparently a different person. A third geographer of the name of Pedro Texeira is mentioned by Antonio as alive at Madrid a few years previous to the publication of his dictionary (1672): one compiled a map of Portugal and a 'Descubrimiento de la Costa de España,' neither of which appear to have been published.

(*Voyages de Texeira, ou l'Histoire des Rois de Persie traduite d'Espagnole en Française*, à Paris, 1681. *Epitome de la Bibliotheca Oriental y Occidentale, y Geografica*, de Don Antonio de Leon Pinelo, en 2

thea Hispana Nova, Auctore D. Nicolao a, emendata, et aucta, Matriti, 1789, fol.; *ies Regum Persiæ ab Ardschir-Babekan, vrdem, a Chalifitii expulsum*, auctore rd, Tubingae, 1628, 4to.; *Persia, seu utus, Variæque Itinera in atque per Per-*, 1633, 24mo.)

ESSEL, is an island in the North Sea, at emity of the province of North Holland, divided by a channel called the Maas

Eierland, it is 12 miles in length and has a large and secure harbour, and a stead on the east coast. The northern called Eierland (*i.e.* Eggs-land, from the eggs laid by the sea-gulls), was a separate it is now joined to Texel by a sand-bank d for a breed of sheep (50,000) with a , and many thousand lambs are annually different provinces of Holland. The in- number, make great quantities of a sheep's milk; many of them are engaged erylery. Besides the petty town of Texel s in the island. Important naval battles off the coast of this island: in 1653, when teated the Dutch under Van Tromp; in

Dutch and the combined English and ch was a drawn battle; and in 1799, be- and Dutch fleets, when the latter, being e republican government, surrendered stance.

phy; Stein's *Lexicon*; Cannabich, *Geo-*

[r. Swainson's name for a subgenus of *us Ammiralis*. (*Mulacology*.)

EVER BIRDS.]

L. [FORAMINIFERA, vol. x., p. 348.]

Å. [MAROCCO.]

MEXICAN STATES.]

IZEL, JOHANN, a Dominican monk, re end of the fifteenth and the beginning ntury. His name would have been for- scandalous manner in which he carried ulgences, which roused the indignation f his contemporaries, and thus led to the rmany. He was a native of Leipzig, eology, and afterwards entered the order in the Pauliner Kloster. In the year ointed him preacher of indulgences for nverted this office into a most lucrative o have made use of the basest means f obtaining money. His conduct too he was condemned at Inspruck to be c and to be drowned, having been con- . But the interference of his superiors e to be changed into imprisonment for rdingly conveyed to Leipzig, and con- nch stood in that city near the Grimma- har) until the year 1834, when it was had however not been imprisoned long at liberty at the request of Albert, arch- and other ecclesiastical dignitaries. a pilgrimage to Rome, and acted the so well, that Pope Leo X. not only ab- sins, but appointed him commissarius rmany, in addition to which the arch- made him 'inquisitor haereticae pravi- city of papal commissary he now carried ulgences more impudently than ever. ny in an open carriage, accompanied by rying with him two chests, one of which lgences, and the other the money raised his latter chest is said to have had the on:—

! das geld im kasten klinget,
d die 'sel' gen himmel springt.'
on as the gold in the chest rings,
n the soul to heaven springs.)

r sanctity had become so great, that in population of towns met him in solemn s entry was accompanied with the ring- bells. He sold indulgences for all rjury, adultery, and not only for crimes i, but also for those which a person 1522.

might commit. At last, in the year 1517, Luther openly opposed him, in the celebrated theses which he fixed on the church-door of Wittemberg. Tezel made a reply in another set of theses, which however were immediately burnt by the students in the market-place of Wittemberg. Tezel seems to have acted contrary to the intention of his superiors, and to have gone beyond his instructions, for Karl von Miltitz, who was sent by the pope to settle the disputes which had arisen out of his conduct, reprimanded him severely. In the year 1518 however Tezel, notwithstanding all this, obtained the degree of Doctor of Divinity at Frankfurt on the Oder. After this event, he returned to Leipzig to his convent, where he died, in August, 1519, of the plague, shortly after the celebrated theological disputation of Eck and Karlstadt. He was buried in the church of his convent (the present chapel of the university); but there is now no trace of his grave, as that part of the church which contained his remains was pulled down in the seventeenth century to make room for some fortifications. [LUTHER.] Comparè P. Melancthonius, *Historia Vitæ M. Lutheri*, i., p. 153, &c.; Gieseler, *Lehrbuch der neuern Kirchengeschichte*, vol. iii., p. 20; Löscher, *Vollständige Reformations-Acta*, ii., p. 324; and more especially Hechtius, *Vita Tezelii*.

THAARUP, THOMAS, a Danish poet and dramatist, highly esteemed by his countrymen as one of the classics in their literature, was the son of an ironmonger at Copenhagen. He was born 21st August, 1749, the very same day as Edward Storm, another poet. This coincidence would hardly deserve notice, if something of the marvellous had not been founded upon it, it being said that Thaarup's mother dreamed that the wife of a clergyman at Guldbrandsdalen was delivered just at the same time of a son, who would be the rival of her own. If not great, both of them were popular and national poets; and though neither very numerous nor of very great extent, their productions, especially their lyric pieces, earned for them a reputation which does not always fall to the lot of writers of more ambition and of higher pretension. This was more particularly the case with regard to Thaarup, whose three little musical dramas, 'Høstgildet,' 'Peters Bryllup,' and 'Hiemkomsten,' are esteemed chefs-d'œuvre of their kind, and the songs and airs were known by heart by every one, and repeated all over Denmark. Their celebrity was not at all less than that of the 'Beggars' Opera' in this country. After the death of Storm [SCANDINAVIAN LITERATURE, p. 3], Thaarup succeeded him as one of the directors of the theatre at Copenhagen, in which situation he remained till 1800. But though he survived Storm a full quarter of a century, Thaarup's literary life did not extend much beyond that of Storm. If he did not entirely lay aside his pen at the commencement of the present century, all the productions by which he will be remembered had appeared in the preceding one. He continued to reside at Copenhagen, where he died in the summer of 1821. Some of his hymns have been translated into German by Voss.

(*Skilderie af Kiøbenhavn*, 1821; *Neue Bibliothek der Schönwissenschaften*, vol. lv.)

THA'BET BEN KORRAH, an eminent physician, philosopher, and geometrician, whose complete names, as given by Ibn Abi'Ossaibiah (*Fontes Relationum de Classibus Medicorum*, cap. 10, § 3), were Abú'l-Hasan Thâbet Ben Korrah. He was born at Harrân in Mesopotamia, A.H. 221 (A.D. 835-6), where he at first carried on the business of a money-changer; he afterwards however went to Bagdad to pursue his studies, which he carried on with so much zeal, that he became one of the most celebrated literary and scientific men of his age. He belonged to the sect of the Sabians, but got entangled in some religious disputes, and was expelled from their communion. In consequence of this he left Harrân, where he had been residing for some time, and went to Bagdad with the celebrated astronomer Mohammed Ben Mûsa. There he lived in his house, and was introduced by him to Mo'tadhed Billah, sixteenth of the 'Abbaside Khalifs (A.H. 279-289, A.D. 892-902), who appointed him one of his astrologers, and ever afterwards, on account of his acquirements and his pleasing manners, continued on terms of great intimacy with him. He died on the 26th of Safar, A.H. 288 (February 18, A.D. 901), aged sixty-seven lunar, or sixty-five solar years. His sons Senân and Ibrahim, and their descendants, practised physic with much reputation at Bag-

dad for more than a century after his death. Thâbet himself appears to have been a very learned man, and also a good practical physician, as he tells a story of the way in which he restored to life a man that was supposed to be dead. (Casiri, *Biblioth. Arabico-Hisp. Excur.*, tom. i., p. 389.) He was also a very voluminous author, as the bare titles of his works, as given by the anonymous author of the 'Arabica Philosophorum Bibliotheca,' take up about two folio pages in Casiri's Catalogue. They consist of mathematical, medical, and zoological treatises, written in Arabic, besides translations into that language of several of the works of Galen, Ptolemy, Autolycus, Euclid, &c. He wrote also several in Syriac, on the religious rites and ceremonies of the Sabians; but none either of these or of his Arabic works have (as far as the writer is aware) been published or translated, though several of them still exist in manuscript in some of the European libraries. (Wüstenfeld, *Geschichte der Arabischen Aerzte*; Casiri, *loc. cit.*; Nicoll and Pusey, *Catal. MSS. Arab. Biblioth. Bodl.*, pp. 257, 295; De Rossi, *Dizion. Stor. degli Autori Arabi.*)

THÂBET BEN SENA'N, the grandson of the preceding, whose names are given by Ibn Abî 'Ossaibiah (*Fontes Relationum de Classibus Medicorum*, cap. 10, § 5) as Abî 'l-Hasan Thâbet Ben Senân Ben Thâbet Ben Korrah. He was celebrated, like the other members of his family, as a physician, philosopher, and mathematician, and was superintendent of the hospital at Bagdad during the reign of Al-Motteia, the twenty-third of the 'Abbaside Khalifs, A.H. 334-363 (A.D. 946-974.) He expounded the writings of Hippocrates and Galen; but his principal work appears to have been a History of his Own Times, from the year A.H. 290 (A.D. 903) to the year of his own death, A.H. 363 (A.D. 973-4), which is highly praised by Abû 'l-Faraj (*Hist. Compend. Dynast.*, p. 208), and was continued after his death by his nephew Helâl, and by other writers. Dr. Sprenger, in the notes to his translation of El-Mas'ûdî's 'Meadows of Gold and Mines of Gems,' vol. i., p. 24, Lond., 8vo., 1841, corrects an anachronism of Haji Khalifa, who ascribes this work to his grandfather Thâbet Ben Korrah.

(Wüstenfeld, *Geschichte der Arabischen Aerzte*; Assemani, *Biblioth. Orient.*, vol. ii., p. 317.)

THALAMITA. [PORUNIDÆ, vol. xviii., p. 446.]

THALAMUS (from *θάλαμος*, the bridal chamber), a botanical term which was applied by Linnæus to the calyx or outer whorl of floral envelopes. Tournefort applied the term to a receptacle that is not fleshy, but surrounded by an involucre. In this sense it is used in common with the terms Clinanthium and Phoranthium. By some writers, as De Candolle, the term is applied to the receptacle of all plants or that point of the rachis or stem around which the floral envelopes are seated. Thus those plants in which the petals and stamens are inserted into the receptacle constitute the first subclass, Thalamifloræ, of the Exogens, in De Candolle's natural arrangement of plants.

Thalamus is also used in Cryptogamic botany, in common with Thallus, to express the bed of fibres from which many fungi spring up. It is also improperly used by some writers to indicate the shields or apothecia of lichens. In fact it is a term that has been applied in so many cases where others are used, that it is desirable it should be altogether dispensed with, or only used in a very obvious sense.

THALASSEMA, Cuvier's name for a genus of footless Echinoderms (*Echinodermes sans pieds*), placed by him immediately after BONELLIA, and thus defined by him:—

Body oval or oblong, with the proboscis in form of a reflected lamina or spoon, but not forked. The intestinal canal is similar to that of *Bonellia*. But one abdominal filament had been discovered.

The genus is divided by Cuvier into the following sections or subgenera:—

1. The *Thalassemæ* properly so called.

These have only two hooks placed very forward, and their posterior extremity has no bristle-like processes (soles).

Example, *Thalassema Neptuni*, *Lumbricus Thalassema* of Pallas, *Spicil. Zool.*, fasc. x., tab. 1, fig. 6.

2. The *Echiuri*,

whose posterior extremity is furnished with some transversal rows of bristle-like processes.

Example, *Echiurus Lumbricus*, *Lumbricus Echiurus*, Gm.,—Pall., *Miscell. Zool.*, xi. 1-6. Common on sandy

bottoms on the French coasts, where the fishermen use it as a bait. It is also found on the coasts of Europe generally, and is said to form part of the food of the cod-fish.

3. *Sternaspis*. (Otto.)

These, besides the bristle-like processes of the *Eri* have under their anterior part a slightly corneous dial rounded with cilia.

Example, *Sternaspis thalassemoides*, Otto, *Monog.*

N.B.—Cuvier states that a new examination of tomy of the *Thalassemæ* had demonstrated to him place which he had assigned to them was the true one.

THALASSEUS, Boie's name for one of the *TETRA* THALASSIANTHUS, M. Ruppel's name for a *ACTINIDÆ*, familiarly known as *animal-flowers*, with *fied tentacula*. [ACTINIA; ZOANTHARIA.]

THALASSIDROMA. [PETRELS, vol. xviii., p.

THALASSINA. [THALASSINIANS.] N.B.—The dent should be careful not to confound the c genus *Thalassina* with the echinodermatous *SEMMA*.

THALASSINIANS. The genus *Thalassina* of 1 consists of those macrurous decapods which four anterior feet terminated by two fingers; the of the lateral fins of the end of the tail narrow gated, without ridges; and the last segment of the intermediate piece, in the form of an triangle. Sometimes the four anterior feet, or 1 feet and one of the second, are terminated by two fingers, forming a claw perfectly. The two are the longest; the lateral foliations of the fin the tail are in the form of a reversed triangle, or the posterior border; the intermediate piece, trary, narrows from the base to the termination, in a point.

M. Milne Edwards arranges the family of *Thalass* or *Burrowing Macrura*, between the *Scyllarian* *Astaciens*.

The *Crustacea* of which this small but inter are composed resemble each other in appea remarkable for the extreme elongation of their and the small degree of consistence of their int

Family Character.—*Carapace* small, and compressed laterally; terminated, generally, in very short rostrum, but sometimes entirely with *Eyes* ordinarily very small. *Internal antennæ* by two multi-articulate filaments; the externa inserted externally and a little below the first; 1 duncle slender, cylindrical, and without a spinous lamina, carries at most only one very small spine, which represents that appendage. *Disposition* the parts of the *mouth* variable. *Sternum* nearly is throughout its length, and not constituting a *Anterior feet* large, more or less completely didactyl and triangular; the next pair raised on each side of thorax. *Abdomen* very long, and, in general, very rather depressed vertically than compressed laterally. lateral borders of the dorsal arch of its various ribs are but little prolonged, and do not incase the base of the feet as in the *SHRIMPS*, nor does the abdomen itself do much in size towards its posterior part. The structure its appendages varies. The disposition of the *respir apparatus* varies also; sometimes it only exists, as it rarely does in the Decapoda, as thoracic branchiæ, etc under the carapace in special cavities; sometimes, contrary, there are, besides those thoracic branchiæ sory branchial appendages suspended under the and affixed to the false feet. Upon this important M. Milne Edwards, who is the author of the on given above, founds his division of the family into tribes, the *Cryptobranchiids* and the *Gastrobranchiids*.

1. *Cryptobranchiids*.

Under this group M. Milne Edwards arranges all *Thalassinians* which are without respiratory apparatus suspended under the abdomen. Their *branchiæ* are a general composed of cylinders, united after the manner of brush. All the species whose habits are known the sand, in which they burrow deeply. The genera belong to this tribe:—*Glaucothæ*; *Azia*; *Gebia*; and *Thalassina*.

Glaucothæ. (Edwards.)

Generic Character.—*Carapace* nearly ovoid, and a any rostriform prolongation. *Eyes* projecting, large, nearly pyriform. *Internal antennæ* short, cylindrical,

rudées), as in *Pagurus*; the third joint of their longest, and carrying at its extremity two multiarticulate appendages, which are very short and stout, one of which is furnished with many long *External antennæ* inserted lower than the preceding peduncle bent, and presenting above a small vestige of a palp. *External jaw-feet* pediform.

Thoracic ring not anchylosed to the preceding. *Feet* terminated by a stout, didactylous, well-hand: they are of very different sizes. Second and first slender and very long: the two last pairs, ordinary, short and elevated against the sides of the thorax in the *Paguri*; the fourth pair are flattened, large, and imperfectly didactylous, the immovable hand being only formed by a slightly protuberance; the posterior feet, still smaller than the anterior, terminated by a small didactylous rather well-hand. The *abdomen* is narrow, elongated, and symmetrical: the first ring, much narrower than the succeeding ones, has no appendages; the four next rings, on the contrary, each give attachment to one or two large false natatory feet, formed by a cylindrical joint and two terminal blades, one of which is broad and obtuse, and the other large, pointed at the tip and bordered with long ciliary hairs. *Caudal fin* in size; the middle blade, formed by the seventh abdominal segment, is rounded and ciliated, and the external ones are much longer than the middle ones.

Milne Edwards observes that this genus establishes a difference between the *Pagurians* and *Callianassa*. The genus, *Glaucothoe Peronii*, the only species known. It has little solidity, its carapace is smooth, length 8 lines. M. Milne Edwards states that it inhabits the seas of Asia. He is of opinion that this genus *Prophylax* approximates closely to *Glaucothoe*, and ought not perhaps to be distinguished if so Latreille's name has the priority. The latter genus among the *Paguri*, but after the publication of Milne Edwards's *Glaucothoe*, was uncertain, and M. Edwards, whether these two generic kinds not be united.

Callianassa. (Leach.)

In this article: but the student should refer to the accurate and elaborate description and figures of M. Milne Edwards, who records two species:—*Callianassa subterranea*



Axia Stirhynchus:

a, intermediate antenna; b, external antenna.

and *uncinata*; and he adds that *Callianassa major* of Say seems to be distinguished from the two preceding species.

Axia. (Leach.)

Generic Character.—*Carapace* very much compressed, and terminated anteriorly by a small triangular rostrum. *Ocular peduncles* very small, cylindrical, and terminated by a hemispherical cornea. Terminal filaments of the *internal antennæ* nearly of the length of the carapace. Peduncle of the *external antennæ* having above a small moveable spine which represents the great lamellar palp observable in the *Shrimps*. *External jaw-feet* slender and pediform. *Anterior feet* compressed, and terminated by a well-formed claw; carpus small. Second pair of feet nearly lamellar, and equally didactylous. The three next pairs monodactylous. *Abdomen* slightly convex towards the middle, and terminating in a great fin, the five blades of which are nearly of the same length. First ring of the abdomen carrying a rudimentary pair of *false feet*, and the four succeeding rings provided each with a pair of very well-developed natatory false feet, each composed of a short and stout peduncle, which at its extremity carries a small styliform appendage within, and externally two great oval, very large blades, which are ciliated on the borders. (M. E.)

M. Milne Edwards observes that this genus much resembles *Callianassa* and *Gebia*, and he records the only known species, *Axia Stirhynchus*. Its length is about three inches, and it inhabits the coasts of France and England.

Gebia. (*Gebios* and *Thalassina*, Risso; *Gebia* and *Upogebia*, Leach.)

Generic Character.—*Carapace* terminating anteriorly by a triangular rostrum, and sufficiently large to cover the *eyes* almost entirely; on each side of its base is a tooth, which is continued with a crest, and forms the lateral border of the upper surface of the stomachal region. *Internal antennæ* very short, but nevertheless their terminal filaments are longer than their peduncle. *External antennæ* very slender, and presenting at their base no vestige of a moveable scale. *External jaw-feet* pediform. *Anterior feet* narrow, terminated by an elongated and imperfectly subcheliform hand: their moveable finger is very large, and in bending downwards its base is applied against the anterior border of the hand, the lower angle of which is prolonged so as to constitute a tooth performing the office of the immovable finger. The feet next in succession are compressed and monodactyle; the second pair have their penultimate joint large, widened, and ciliated below; the succeeding pairs are more slender. *Abdomen* long and much narrower at its base than towards its middle, depressed and terminating by a large fin, whose four lateral blades are foliaceous and very wide. First abdominal ring with two pairs of very small filiform appendages; the four next segments giving origin to three pairs of false natatory feet, composed of a stout and short peduncle, and two oval blades with strongly ciliated borders: the external one very large, and the other very small. *Branchiæ* brush-like and fixed on two rows, namely, one above the second foot, and two above the four anterior feet and the external jaw-feet. (M. E.)

Example, *Gebia stellata*. Length 1½ inch.

Locality.—Coasts of England. M. Milne Edwards states that this species comes very near to *Gebia littoralis*.

M. Milne Edwards observes that the *Gebia* establish the passage between the *Thalassinæ* and the *Axiæ*, which last they resemble in the general form of the body and disposition of the caudal fin, whilst they approach the first by the conformation of the feet.



Gebia stellata.

a, intermediate antenna; b, base of an external antenna.

Thalassina. (Latrelle.)

Generic Character.—*Carapace* short, narrow, and very much elevated. *Stomachal region* small and limited backwards by a deep furrow. *Cardial and intestinal regions* equally separated from the branchial regions, and representing by their junction a triangle, the apex of which is directed backwards. *Front* armed with a small triangular rostrum. *Eyes* small and cylindrical. *Internal antennæ* inserted above those organs; their peduncle of moderate size, and their terminal filaments slender and unequal, the longest about thrice the length of the peduncle. *External antennæ* very small, their peduncle cylindrical, hardly reaching beyond the rostrum, and presenting above no vestige of appendages. *External jaw-feet* moderate and pediform, their second joint armed with spiniform teeth on its internal surface, and nearly of the same form as the succeeding ones. First pair of *feet* narrow and moderately elongated, but rather robust; they are unequal, and the hand which terminates them presents at its anterior and lower angle a more or less strong tooth, which represents an immoveable finger, against which the base of the moveable finger, which is very large, is bent back. Second pair of feet very much compressed, and rather wide; their penultimate joint especially is large and ciliated below. The succeeding feet have nearly the same form, but they are narrower, and less and less compressed. *Abdomen* very long, narrow, semicylindrical, and nearly of the same size throughout its length. Terminal fin small; the two pairs of lateral blades, formed by members of the sixth ring, nearly linear. *False feet* fixed to the four middle rings of the abdomen; they are very slender, and composed of a cylindrical and elongated peduncle carrying two more or less ciliated multiarticulate filaments. (M. E.)

Example, *Thalassina scorpionides*. Length about six inches. Colour brownish.

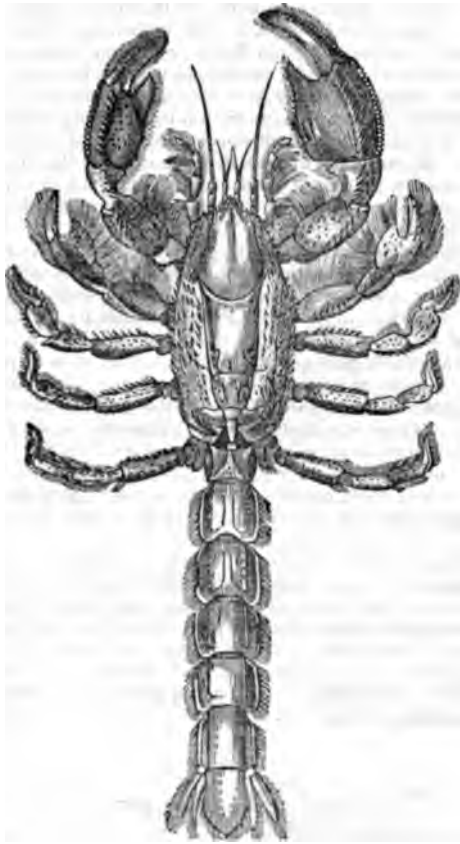

Thalassina scorpionides.

Locality.—Coasts of Chili.

M. Milne Edwards remarks that the abdomen of this species reminds the observer of the body of a *Scotopendra*.
2, Gastrobranchids.

M. Milne Edwards observes that this small division of the *Thalassinians* is very remarkable, for it establishes the passage between the *Callianassa* and the *Squilla*. In the general form of the body, the crustaceans forming this

division differ, he remarks, but very little from the first, the conformation of their thoracic branchiæ does not permit their separation from the macrurous decapoda, nor their distant removal from the Thalassinians; but they have respiratory appendages fixed to their abdominal false-feet, exhibiting the greatest analogy with the ramose branchiæ of the STOMAPODS.

The type of this group, according to M. Milne Edwards is a small crustacean, to which he gives the generic name *Callianidea*; but he also arranges in this same division a genus *Isea* of M. Guerin, under the name of *Callianassa*, for he thinks that he perceives in this last an analogous mode of organization. If, he observes, the character assigned to it by M. Guerin be exact, it would be proper to place this new genus here, and it ought to be appended to the *Pagurians*; but it appears very probable to M. Edwards that there has been some error of observation, that in reality the *Isea* and *Callianidea* differ but very little.

These crustaceans, M. Milne Edwards observes, have a very small oval thorax compressed laterally; the abdomen, on the contrary, is extremely long and slender. The disposition of the eyes and the antennæ is nearly as in *Callianassa*. The external jaw-feet are moderate and carry externally a slender and multiarticulate peduncle; the two first pairs of feet are didactylous; the anterior pair long, very unequal, and terminated by a stout compressed hand; the second are small and very delicate; the third are enlarged towards the end nearly as in *Callianassa*, and terminated by a very short tarsus, forming, with a tubercle of the preceding joint, an imperfect claw. The fourth pair of feet are slender and monodactyle; and the fifth pair, small in dimension, are thrown backwards. As in the *Cryptobranchids*, the abdomen is very long, sufficiently and composed of nearly equal rings, of which the first arch is not prolonged below so as to incase the base of the false feet. The caudal fin offers nothing remarkable; the false feet, inserted at its lower surface, are terminated with a multitude of branched filaments, which are very analogous to that of branchiæ, and which certainly must be destined to concur in the work of respiration.

M. Milne Edwards concludes by observing that this division comprehends two genera, one of which appears to be too imperfectly known to be conveniently characterized.
Callianidea. (Edwards.)

Generic Character.—*Body* very delicate, slender, and elongated. *Carapace* hardly a third of the length of the abdomen, and not covering the last thoracic ring; it is compressed and rather elevated, its lower border is directed exactly against the base of the four first pairs of feet; the rostrum, and the anterior border of the carapace are on each side of the median line for the reception of the base of the eyes, whose peduncles are very slender and formed as in the *Callianassa*. Four antennæ, slender, inserted nearly on the same transversal line; the first terminated by two filaments nearly equal in length, the second which however is the largest, and slightly convex to the end. Appendages of the *mouth* very small, occupying but little space; *mandibles* hardly differing from those of *Callianassa*; valvular appendage of the second pair very small; external *jaw-feet* slender and pediform, the second joint furnished internally with a row of distinct tubercles covered with hairs, and with their third joint very much elongated. *Sternum* linear throughout its length. First pair of *feet* long, and one of them very unequal with the terminating hand very large, and nearly of the same form as in *Callianassa*, except that the caudal joint is smaller. The two succeeding pairs of feet are flattened; the fourth pair nearly cylindrical, the fifth pair very small; the fifth pair very much enlarged. Fifth pair of feet as the fourth, and terminating in an imperfect claw. *Abdomen* composed as ordinarily of seven segments, nearly of the same size throughout, and carrying five pairs of *false-feet*: of these the first are reduced to simple narrow blades slightly ciliated at the end, but the four succeeding pairs have a very remarkable coloration. A peduncle is to be distinguished and three cylindrical, two of which are very large and one very small, the edge of the preceding ones; all round the border of the great laminae a kind of tufted fringe is found, composed of a row of cylinders, each of which gives origin to a row of filaments, which again in their turn are bifurcated in the same manner as the branchial filaments of the *Squilla* are divided. The five blades of which the c

posed are wide and rounded. The thoracic re enclosed as ordinarily in the carapace, and are posed of cylinders ranged in parallel order on a y as in the lobsters, only these organs and filaments numerous, and the branchiæ themselves very re are only ten on each side of the body. (M. E.) , *Callianidea typa*. Length about 10 lines. —Coasts of New Ireland, where it was found by and Gaimard.



Callianidea typa, magnified.

a, the first pair; *b*, external jaw-foot; *c*, extremity of one of legs; *d*, abdominal false feet, first pair; *e*, false feet of one of legs; *f*, marginal fringe of those false feet.

doubt exists relative to the genus *Isea*, Guerin, M. Edwards, that we think we should not be occupying space with the very long and elaborate of M. Guerin, and the acute criticisms of M. Edwards, who observes that *Isea*, having been pre-loyed to designate another crustaceous animal, is stained. M. Guerin's description will be found in 'Annales de la Société Entomologique de France,' vol. 10; and also in M. Milne Edwards's 'Histoire des Crustacés,' tom. ii., p. 322. But though our notes permit the insertion of the details, they are carefully perused by the student, for they are interesting and instructive.

FOSSIL THALASSINIANS.

Edwards states that the crustaceous fossil found in the formation of Maastricht, and figured by M. Edwards under the name of *Pagurus Faujasii*, belongs to the genus *Callianassa*.

SIO'RNIS, Mr. Eytton's name for one of the shells (Smith), subfamily *Erismaturinae*.

SIOPHYTES (literally 'sea-plants,' from *σιόφύτον*) is the name given by Lamouroux to designate the productions of the ocean and of its rocks.

It is equivalent to the term Hydrophytes of Lamouroux, and the plants described by Agardh as Marine Hydrophytes, and by Lamouroux as Marine Hydrophytes, a division of the vegetable kingdom comprehended in Lamouroux's system, six orders, viz., Fucaceæ, Dictyotaceæ, Ulvaceæ, Aphloimidæ, and Phloëales-WEEDS; ULVACEÆ.]

(Θαλῆς) was a native of Miletus, one of the cities of Ionia, and descended from a Phœnician named Apollodorus, as quoted by Diogenes Laertius, who says that he was born in the first year of the 35th century B.C. 640. Herodotus (i. 74) says that Thales predicted the year of the great eclipse which occurred while the armies of Cyaxares and Alyattes the Great were engaged in battle. Alyattes became king of Lydia in B.C. 617. Herodotus also says (i. 75) that Thales was in the army of Cræsus at the time of the eclipse between Cræsus and Cyrus B.C. 547 or 548, which he would be ninety-four years old, if his birth is correctly given by Apollodorus. The general tradition that he lived to a great age; states that Solon, Thales, and Pittacus all died at a hundred years old. (On the subject of the philosopher Thales, see the article ALYATTES, and Oltmanns, *Abhandl. der Akad. Berlin*, 1812-13.)

In the Life of Thales by Diogenes we find numerous traditions attached to his name, the value of which it is somewhat difficult to estimate. Thales is enumerated among the Seven Wise Men, whose wisdom was not the theoretical wisdom of philosophers, but the wisdom of actual life. [BIAS.] Accordingly we find that Thales took an active part in the political affairs of his native country. Before Ionia fell under the Persian yoke, he advised the Ionians to have one common council, and to establish it at Teos, for Teos was in the centre of Ionia; and he further suggested that all the other Ionian states should be reduced to the condition of parts dependent on the government at Teos. Such a scheme, if carried into effect, might have checked the progress of the Persian arms (Herod., i. 170.) Later writers say that he visited Egypt and Crete in order to improve his knowledge, and that he derived from Egypt his acquaintance with mathematics. There seems no reason for thinking that Thales left any writings. Aristotle at least was not acquainted with any philosophical writings by Thales. Various sayings of Thales are recorded: they are of that sententious character which belongs to the proverb, and they embody truths such as the general experience of mankind recognises; and for this reason they cannot safely be considered as the product of any one mind. Thales is generally considered the founder of the Ionian school; but it is perhaps hardly proper to consider him in any sense as the founder of a school. [IONIAN SCHOOL.] His traditional reputation rested on his physical discoveries and his philosophical speculations. He is said to have been the first astronomer (among the Greeks) who predicted eclipses; and to have discovered the passage (*παρόδος*) from tropic to tropic, or, in other words, to have laid down the sun's orbit; and to have fixed the length of the year at 365 days. He determined the magnitude of the sun to be 720 times that of the moon; which is apparently the true version of the corrupt passage in Diogenes. His knowledge of geometry was said to be derived from Egypt, and Pamphila attributes to him the discovery of the right-angled triangle of the circle (*πρῶτον καταγράψαι κύκλου τὸ τρίγωνον ὀρθογώνιον*), which probably means the demonstration that the angle in a semicircle is a right angle, a discovery attributed also to Pythagoras. Hieronymus says that he measured the height of the pyramids of Egypt by observing the shadow which an object cast when it was of the same length as the height of the object.

The philosophical speculations of Thales, like the earliest efforts of philosophers in all countries, were an attempt to solve the problem that admits of no solution—the real nature of the universe. He is considered by modern writers as the originator of the dynamic philosophy, the nature of which, as opposed to the mechanical, is explained in the article IONIAN SCHOOL. Aristotle (*Metaph.*, i. 3) has explained in a short passage the general doctrine of Thales: 'There must be,' observes Aristotle, 'some Nature (*φύσις*), either one, or more than one, to which all other things owe their origin, this one still subsisting. The number however and the character of such a first principle are not conceived by all in the same way. Thales, the founder of this philosophy, says it is water, and accordingly he taught that even the earth reposes on water, founding this notion probably on the observation that the nourishment of all things is moist, and that heat itself proceeds from water, and that animals live by it: but that from which things come is the origin of all things. He was thus led to this notion, and also by observing that the seeds of all things have a moist nature, and that water is the origin of their nature to all moist things.' Thus the universe contained an active principle by the power of which all things were developed. He considered that the magnet had life, because it attracted iron. The universe then was pervaded by life, or, as Thales expressed it, 'full of gods' (*πάντα πληρη θεῶν*).

The doctrine of Thales bears some resemblance to the systems that have been promulgated in modern times, which have been viewed as atheistical. The assumption of an active power, such as gravitation for instance (though it is not here meant to affirm that gravitation has ever been viewed as a power sufficient for the production and conservation of all things), which is sufficient to maintain all things in a permanent condition (changes such as we observe in limited portions of time and being only continued developments), may be viewed as an hypothesis

made for the purpose of getting rid of the necessity of admitting the existence of God. Those who propound such an hypothesis, without further explanation, certainly do not take much pains to avoid the imputation of atheism. It does not appear however that the doctrine of Thales was anything more than a pure physical theory; and the traditions recorded of him by Diogenes make him a believer in a Diety. 'The most ancient of things existing is God, for he is uncreated; the most beautiful thing is the universe, for it is God's creation.'—It was one of the maxims of Thales, that death did not differ from life. 'Why don't you die then?' said an objector, more witty than wise. 'Because there is no difference,' was the reply.

(Diogenes Laertius, i. 'Thales;' Ritter, *Geschichte der Philosophie*, vol. i.)

THALICTRUM (from the Greek *θάλιτρον*), the name of a genus of plants belonging to the natural order Ranunculaceæ. It consists of herbs which have usually a fetid smell like rue, and hence are called meadow rue. The species have perennial roots with annual stems. The flowers are corymbose, paniced, and somewhat racemose, of a green, white, or yellow colour. They have no involucre and no petals. The calyx is composed of 4 or 5 petal-like sepals. Carpels 4-15 in number. Upwards of 50 species are enumerated, which are mostly natives of the temperate and colder parts of the world.

Th. aquilegifolium, the Feather Columbine, has ovate stipules, placed at the base of the ramifications of the petiole; and a corymbose panicle. It is a native of Europe, in woody districts of Germany, France, and Italy. The stems and stamens of this plant vary in colour, sometimes being greenish-white and sometimes purple. A variety is found in Austria with dark purple stems and stamens, and is called *Th. a. atropurpureum*. Another variety, *formosum*, has the stamens dilated at the apex; whilst another has the stems green and stamens quite white, and is named *Th. a. album*.

Th. minus, Lesser Meadow-Rue, has the stem round, mealy, the flowers paniced, drooping, leaflets smooth, roundish, toothed at apex, glaucous, pericarps acute furrowed. It is a native throughout Europe. In Britain it is found in chalky pastures, and on the sea-coast where shell-sand abounds. The greater meadow-rue, *Thalictrum majus*, is also a native of Great Britain, though rare.

Th. flavum, Yellow Meadow-Rue, has an erect, branched, furrowed stem, fibrous roots, a somewhat corymbose panicle of cream-coloured flowers, with wedge-shaped, trifid acute leaflets. It is a native of all districts in Europe. In Britain it occupies wet meadows, the banks of rivers and ditches. It has a root of a yellow colour, and is said to resemble, both in appearance and properties, rhubarb. It yields a yellow dye, which may be employed for dyeing wool, and was formerly used as a remedy in jaundice. Like many of the family to which it belongs, it is very acrid, and produces blisters upon the skin, when applied to it.

Th. fetidum, Fetid Meadow-Rue, has a simple stem, naked at the base, leafy in the middle, and paniced at top; the leaflets are obtuse, toothed, and covered with a clammy pubescence. It is a native of France, Switzerland, Russia, &c., and is found in valleys and on hill sides, and in the fissures of calcareous rocks. It smells more powerfully than any of the species—hence its specific name.

Th. Cornuti has diœcious or polygamous flowers, with club-shaped filaments, obovate roundish leaflets, glaucous beneath. This is a North American species, and is found on the banks of rivers and in woody districts throughout the whole continent.

The character of the leaves of these plants and their thickly-flowered panicles render them favourites in gardens. They are readily increased by parting their roots and planting them out in autumn. They flourish best in moist shady situations, but are not particular; they are free-growing plants and well adapted for borders.

THALLEPUS, Mr. Swainson's name for a genus which he places among the *Aplysians*, apparently upon the authority of one of the late Rev. Lansdown Guilding's drawings.—Ex., *Thallepus ornatus*. (*Malacology*.)

THALLICERA, M. Quoy's name for a genus of Gastropoda, placed as the first subfamily (with a 2) of his *Turbidæ Turbinite*, we suppose, is meant, by Mr. Swainson. It is immediately followed by the subfamily *Ampullariæ*. (*Malacology*.)

THALLITE. [EPIDOTE.]

THALLUS is a botanical term used exclusively in cryptogamic botany, and is generally applied to the part of the plant which bears the reproductive organs and constitutes the principal part of its vegetation. In *Jmanniaceæ* the thallus or frond is either a leafy bract, as in mosses, with the cellular tissue large and the leaves frequently furnished with appendages at the base, called stipulæ or amphitria; or it is a flattened mass of vegetable matter upon the ground. In lichens the parts which bear reproductive organs, and which constitute the great part of the plant, is called thallus or blastema. In the term thallus is applied to the whole plant; while the fungi it is used synonymously with thalamus. *Thallosis* is the process of pressing the mass of fibres from which many of our plants arise. *Thallosis* is the adjective used to express arising from the thallus.

THAME. [OXFORDSHIRE.]

THAMES, the most important river in Great Britain, rises in the central part of England, and flows eastward into the German Ocean. Our description will comprehend a notice of its basin, course, and affluents, and commercial importance.

Basin.—The limits assignable to the basin of will depend on the place at which the mouth is opening between Sheerness in Kent and Shoel Essex, between five and six miles wide, is regarded as the mouth of the Thames; but it is some respects to consider as such the opening between Whitstable in Kent and the east extremity of Foreland in Essex, where the tideway has a breadth of eighteen miles. Here the Thames opens into a bay separating Kent on the south from Essex and the north, and having for its extreme points Foreland in Kent and Orford Ness in Suffolk, fifty distant from each other. Into this bay several rivers sides the Thames, open: as the Crouch, the Colne, and the Stour, from Essex; the Stour, which flows from Suffolk; and the Orwell, the Deben, and the Alde, from Suffolk.

The basin of the Thames, commencing at the high grounds which there run along the coast, and form the cliffs east of that town. The river runs in a very irregular line across the county of Kent the Weald district of Kent and Sussex to the high on the southern border of Ashdown Forest in the county. This part of the boundary is very irregular in the manner in which the basin of the Thames is connected with the basins of the Kentish Stour, the Sussex Ouse.

From Ashdown Forest the boundary runs west-north across the high ground of Tilgate and St. Leonard's to Leith Hill in Surrey, and thence west-south-west in a very irregular line, past the head of the Wey in Surrey Forest to the verge of the chalk downs near Hants. This boundary separates the basin of the Thames from the basins of the Sussex Ouse and the Arun; all the waters which rise along the boundary from the commencement to Tilgate Forest, flow into the Medway, from Tilgate Forest to Leith Hill, into the Mole; and from Leith Hill to Alton, into the Wey.

From the neighbourhood of Alton, the boundary basin is formed by the chalk downs which extend through Hants and Wilts by Basingstoke, Kingsclere, Hazeley, and Burbage near Great Bedwin; and from thence by the chalk downs which run north-westward to the neighbourhood of East Kennet and Abury. These chalk downs separate the basin of the Thames from the basins of the Anton and the Hampshire Avon: that part of the basin of the Thames which they bound is drained by the Lock of the Kennet.

From near East Kennet the boundary turns north-north-east along the green-sand hills by Compton, Cliffe Pipard, and Chadderton; and from thence north-west to the western extremity of the basin near commonly reputed head of the Thames amid the Cotswold Hills between Cirencester and Tetbury. The boundary between East Kennet and the Cotswolds separates the basin of the Thames from that of the Bristol Avon, or correctly of the Severn, of which the Avon is a tributary.

From the neighbourhood of Tetbury the boundary northward along the ridge of the Cotswolds, which separate the basins of the Thames and the Severn, to

Churn (or true Thames), about three miles Ilenham; and from thence north-north-east same hills to the head of the Windrush near d by Long Compton Hill and Edge Hill to ills near Daventry at the northern extremity

Here the basin of the Thames is conterminous part of the basin of the Severn which is affluent the Warwickshire Avon.

Arbury hills the boundary of the basin runs neighbourhood of Bicester, and thence east- Buckinghamshire, Bedfordshire, and Hertford- he Dunstable, Luton, and Royston downs, to tern corner of Essex; the basin of the Thames hout conterminous with that of the midland ise. This part of the basin of the Thames is ; affluents, the Charwell, the Thame, and the gular line drawn through the county of Essex -western corner, first south-south-east by Dun- stwood, and then east by Rayleigh and Roch- ast, will complete the boundary.

st extent of this basin from east to west is ith of the Thames to the neighbourhood of it 136 miles; the greatest extent from north n the neighbourhood of Daventry, Northamp- e neighbourhood of Alton, Hants, about 78 basin comprehends the whole or part of ; counties; its area may be estimated as

	Sq. Miles.
derably more than half the county ; rn part)	900
whole county with the exception small portions along the southern border)	700
small part along the northern border)	300
northern and north-eastern part)	350
whole county)	750
northern and north-eastern part)	450
(the south-eastern and eastern part)	450
re (a very small portion along the tern border)	50
shire (a very small portion along -western border)	50
whole county, with the exception of portions on the north-eastern and rn borders)	650
-nirds of the county; the central ern part)	500
ll portion at the southern extre- mity)	50
whole county except some portions north-eastern border)	550
the whole county)	300
ut one-third of the county; the nd southern borders)	550
Total	6600

ed round numbers, as in such an estimate an to the truth is all that can be attempted.

of the Thames is occupied wholly by the tertiary geological formations. The sources and the course of its upper waters are in the of the Cotswold hills. The valley through ames itself flows from above Cricklade to is occupied by the Oxford clay, and between oring (a little below Wallingford) the river formations (the coral rag, Aylesbury stone, y, and greensand and chalk marl) which inter- the oolitic and cretaceous groups. It traverses e between Ilsley Downs and the Chiltern Hills alley, in which it flows from Goring to Maiden- hich it enters the chalk basin of London, and nder of its course through it. The affluents Thames above Oxford have their course chiefly istrict; the Thame and the Ock flow through upied by the groups between the oolites and id of the remaining affluents, those which e north bank chiefly rise in the chalk hills, r course in the chalk basin of London: while hich join it on the south bank rise in the pied by the subcretaceous formations, and lk basin of London by openings in the chalk North Downs. Owing to the entire absence

of coal, the basin of the Thames has no manufactures ex- cept those of the metropolis; but it contains some of the richest agricultural districts in the whole kingdom.

Course and Affluents.—The spring which has com- monly been regarded as the head of the Thames is about three miles south-west of Cirencester, near a bridge over the Thames and Severn canal which is called ‘Thames- head bridge;’ but that which is to be regarded as the true head of the Thames is about three or four miles south of Cheltenham. Two streams rise, one from fourteen springs at what is popularly called The Seven Wells, and the other from four springs near Ullen Farm, the westernmost of which springs is the real (*i.e.* the remotest) head of the river: both streams rise on the south-eastern slope of the Cotswolds, and form by their junction, about a mile from their respective sources, the river Churn (a name the element of which is embodied both in the antient and modern name of the town of Cirencester (the Corin-ium of the Romans), by which it flows; and in the name of two villages, North and South Cern-ey, which are near it. At Cricklade, 19 or 20 miles south-east from its source, the Churn joins the commonly reputed Isis or Thames, the length of which above the junction is only about 10 or 11 miles.

From Cricklade the river flows 9 or 10 miles east-north- east to Lechlade, receiving on the way the Ray (11 miles long) and the Cole (14 miles long), both on the south bank. Just above Lechlade it receives on the north bank a more important tributary, the Colne (23 miles long) from the Cotswold hills east of Cheltenham; and just below Lechlade it receives the Lech, or Leach (19 miles long), which also rises in the Cotswolds, and gives name to the towns of North Leach and Lechlade. From Lechlade the Thames flows 14 miles eastward to the junction of the Windrush, receiving accessions of small brooks on each side. The Windrush rises in the Cotswolds between Winch- comb and Campden, and has a course of 34 miles by Bur- ford and Witney; it joins the Thames on the north bank. Below the junction of the Windrush the Thames makes a bend to the north and north-east, receiving on the north bank the Evenlode, which rises in the Cotswolds near Moreton in the Marsh, and has a course of 31 miles by Charlbury, and receives the Glyme which flows through Woodstock and Blenheim park. The Thames then turns south, and flows to Oxford, where it joins the Charwell. From the junction of the Windrush to that of the Charwell the length of the Thames is 18 miles. The Charwell rises in the Arbury hills near Daventry in Northamptonshire, and flows southward 44 miles by Banbury: it joins the Thames on the left bank.

From the junction of the Charwell the Thames flows 16 miles south-south-east to the junction of the Thame at Dorchester, making however a considerable bend westward to Abingdon, where it receives the Ock. This river rises at the foot of the chalk hills of Berkshire, between Comp- ton Beauchamp and Ashbury, and flows eastward 18 miles into the Thames, which it joins on the right or south-west bank: the Thame rises near Stewkley in Buckinghamshire, between Winslow and Leighton Buzzard, and flows 39 miles south-west by the town of Thame into the Thames, which it joins on the left or north-east bank. From Dor- chester the course of the Thames is south-east 22 miles in a winding channel by Wallingford to the junction of the Kennet near Reading. The Kennet rises near Broad Hinton, a village to the north of Marlborough Downs, flows south to East Kennet, and then turning eastward flows by Marl- borough, Hungerford, Newbury, and Reading into the Thames, which it joins on the right bank: its whole course is 53 miles. It receives the Lambourn and the Embourn or Auburn.

From the junction of the Kennet the Thames flows east- ward, though in a very winding channel, making first a considerable circuit to the north by Henley, Great Marlow, and Maidenhead to Windsor; and then a considerable cir- cuit to the south by Staines, Chertsey, Kingston, and Rich- mond to Brentford, from whence it proceeds by Hammer- smith, Putney, and Chelsea to the metropolis. The distance from the junction of the Kennet to London-bridge is 70 miles. In this part of its course the Thames receives several feeders. The Loddon, 24 miles long, rises in the chalk downs of North Hants near Basingstoke; the Coln, 38 miles long, rises, under the name of the Ver, in the chalk downs of Hertfordshire, and passes St. Albans, Watford, Rickmansworth, Uxbridge, and Colnbrook; the Wey, 36

miles long, rises near Alton, Hants, passes Farnham, Godalming, and Guildford, and joins the Thames at Weybridge; the Mole, 41 miles long, rises on St. Leonard's Forest, in Sussex, passes through Leatherhead, and joins the Thames at East Moulsey; the Cran and the Brent, two small streams, each about 18 miles long, rise on the borders of Middlesex and Herts, and join the Thames, the first at Isleworth, the second at Brentford; and the Wandle, a stream only 9 miles long, joins it at Wandsworth. Of these the Coln, the Cran, and the Brent fall into the Thames on the left or north bank; the others on the right bank. The name of the Ver appears as an element in the name of Ver-olanium, an antient Roman town close to St. Albans.

Below London, up to which sea-borne vessels ascend, the river flows eastward, but with various 'reaches' or bends, 56 miles to its mouth, or to the Nore Light (at the commonly reputed mouth) 48 miles. Between Deptford and Greenwich, about four miles below London-bridge, the Thames receives on the south or right bank the Ravensbourne, 10 miles long, from Keston, near Bromley in Kent; about two or three miles farther down, on the north or left bank, the Lea, 50 miles long, which rises in Bedfordshire, and passes Luton, Hertford, Ware, and Waltham Abbey; four or five miles lower, the Roding, 38 miles long, from near Dunmow, also on the north bank; and six miles lower, on the south bank, the Darent, 20 miles long, which passes Dartford, and receives the Cray. The only remaining feeder of the Thames which here requires notice is the Medway, above 60 miles long, which rises in Sussex, and flows by Tunbridge, Maidstone, Rochester, and Chatham. The principal arm of the Medway joins the Thames at Sheerness just above the Nore; but the smaller arm, called the Swale, which cuts off the Isle of Sheppy from the mainland of Kent, opens into the Thames just above Whitstable.

The whole course of the Thames, from its source to its mouth, is about 220 miles, which is the aggregate of the distances already given.

	Miles.
Length of the Churn	20
From the junction of the Churn and commonly reputed Thames at Cricklade to Lechlade	9
To the junction of the Windrush	14
To the junction of the Charwell	13
To the junction of the Thame	16
To the junction of the Kennet	22
To London-bridge	70
To the mouth	56
	220

The principal affluents of the Thames are more fully described elsewhere: the Colne under Gloucestershire; the Windrush, the Evenlode, the Charwell, and the Thame, under Oxfordshire; the Kennet, the Loddon, and the Ock, under Berkshire; the Colne, the Brent, and the Cran, under Middlesex; the Wey, the Mole, and the Wandle, under Surrey; the Lea with its tributaries, under Hertfordshire, Essex, and Middlesex; the Roding under Essex; and the Ravensbourne, Darent, Cray, and Medway with its feeders, under Kent. The Thames, in the first part of its course, belongs wholly to Gloucestershire, but below Cricklade is almost entirely a border river, dividing Gloucestershire from Wiltshire, Oxfordshire and Buckinghamshire from Berkshire, Middlesex from Surrey, and Essex from Kent. Some part of its course is therefore described in the articles on those counties.

Commercial Importance.—The navigation of the Thames commences at Lechlade, where the river is about 254 feet above low-water mark at London-bridge. Its importance was early appreciated, and there are acts of Parliament relating to it as early as the 2d Hen. VI. The Thames and Severn Canal, which follows the valley of the Churn and the Thames from near Cirencester, opens into the Thames at Lechlade, thus connecting it with the Severn and the western coast of the island. The navigation of the river formerly extended up to Cricklade, but since the opening of the canal the upper part, between Cricklade and Lechlade, has been abandoned. None of the tributaries above Oxford are navigable. At Oxford the Oxford Canal joins the Thames, and opens a communication with the great canal system of the central counties: it follows the course of the Charwell (which river is not navigable) from above Banbury. At Abingdon the Wilts

and Berks Canal joins the Thames, and, as well as the Kennet and Avon Canal, which joins the Kennet at Newbury where the navigation of that river commences, 20 miles above its junction with the Thames, opens a communication with the Somersetshire or Bristol Avon, and by it with the Severn. The Thame is navigable from the town of Thame, about 17 miles above its junction with the Thames; but neither the Loddon nor the Coln is navigable. The Wey is navigable from Godalming, about 17 miles from its junction; and is connected with the Wey and Arun Canal, and the Basingstoke Canal, the former of which opens a communication with the river Arun the Sussex coast. No other feeder above London-bridge is navigable; but the Grand Junction Canal, which unites with the Oxford Canal at Braunston in Northampton, opens into the Thames by the mouth of the Brent, the lower part of which is incorporated with the canal. London-bridge the Lea, which is navigable, chiefly by artificial cuts, for 25 miles, and has one of its feeders the Stort; also navigable, opens into the Thames; and just above the Lea, the Regent's Canal, which encircles the north and east side of the metropolis, and communicates with the Paddington Canal, and so with the Grand Junction Canal, also opens into the river.

The Medway is navigable below Rochester bridge for sea-borne vessels, and from Penshurst, above 43 miles from its mouth, for river craft.

The navigation of the Thames, in its upper part, is kept up by locks and weirs, the lowest of which is at Teddington, which is consequently the limit of the tide. Teddington is about 18 or 19 miles above London-bridge. High-water mark at Teddington is about one foot and a half higher than at London-bridge, and the time of high-water is about two hours later. Low-water surface at Teddington is about sixteen feet and three-quarters higher than at London-bridge.

At ebb-tide there is a depth of from 12 to 13 feet water nearly or quite up to London-bridge, and the rise of the tide is about 17 feet, or at the extreme springs about 22 feet.

Vessels of 800 tons get up to the St. Catherine's Docks, and those of 1400 tons to Blackwall, about six miles below bridge. No river in the world equals the Thames in its commercial importance. The river for some two miles or more below bridge is crowded with vessels, chiefly coasters, sea-boats, and colliers, which moor alongside the quays or in the stream; others are moored lower down, though in such numbers; and for larger vessels there are several excavated on the bank of the river. There is a dock for the navy (now little used) at Deptford, about four miles below London-bridge; one at Woolwich, nine miles below one at Sheerness, in the Isle of Sheppy, at the junction of the Thames and Medway; and one at Chatham, the important of the four, on the Medway. The fortifications at Sheerness defend the entrance to both rivers; the passage of the Thames is further protected by Tilbury Fort, and that of the Medway by Gillingham Fort.

The width of the river at London-bridge is nearly 700 feet. For nearly the whole way below London-bridge the river is embanked, and is almost throughout its lower course skirted with marsh-lands, which however have nowhere a great extent. The width of the river at Woolwich is about a quarter of a mile; at Gravesend, 26 miles below London-bridge, and opposite Tilbury Fort, it is more than half a mile; about four miles below Gravesend it is nearly a mile; and then gradually increases to the width of about six miles at the Nore, and to eighteen at the point where we have fixed the mouth.

It is a common opinion that this river in the upper part of its course is properly called Isis, and that it is only at the junction of the Thame that it is called Thames. This name is said to be formed by combining the two names Thame and Isis. But Camden observed long ago that this is a mistake; that the river was antiently called Tamesis, its upper as well as in its lower part; that the name never occurs in antient records, and was never used by common people, but only by scholars. Caesar writes the name Tamesis (evidently Tames or Thames, with the addition of a Latin termination. Tacitus writes it Tamesis and Dion Cassius *Tamisa*, which is the same name with the appendage of a different termination. Ptolemy has *Ἰάμυσα*, or in some MSS. *Ἰάμυσις*, and in some editions *Ἰάμυσα*; all which we suspect to be forms of the name, 'I' having been by the carelessness of some

substituted for T. In Richard of Cirencester it is.

Ice Survey; M'Culloch's *Statistical Account of the Empire*; Camden's *Britannia*.)

ES, a certain jurisdiction, though not undistinctive, appears to have been immemorially over both the fisheries and navigation of a portion of the Thames by the mayor and corporation of London. In early times, when fisheries were of much greater importance than they are at present, a kind of encroachments upon them by private persons which were so often made the subject of complotments of the kingdom were also practised in

In 1405 an order was issued from Sir John de Staines, then lord mayor, enjoining the destruction of nets from Staines to the Medway, in consequence of a jury which they did to the fishery and their navigation. By 4 Hen. VII., c. 15 the mayor of London and his successors were invested with the same authority as conservator of the fisheries, breaches, and ground overflowed as far as the water ebbed and flowed from out of the river as he had within the river itself. Before the river was artificially embanked and the adjoining lands his extension was probably of considerable importance.

During the reign of Elizabeth, in 1584, an order was granted by the mayor for the purpose of settling the boundaries in which various kinds of fish were to be prohibited fishing in certain parts of the river, and the taking of the white-bait or 'bloodbag.' The jurisdiction of the corporation however to the conservation of the river about this time was disputed by the lord-high-justice, and some litigation took place, in which the corporation were uniformly successful. James I. in the third year of his reign granted a charter to the city, in which the full right of the city to the office of bailiff and of the Thames is recited and confirmed. The charter is also confirmed and settled by various other acts of parliament. The result of them is to invest the corporation the conservation of the river, the port and harbour of London, and, as is stated in the actual property in the soil of the river, subject to the jus regium of the crown. By this is perhaps intended, that property with which the crown is held in trust for the purpose of securing to the public the river for the purposes of navigation, fishing, and other purposes. The portion of the river over which jurisdiction of the city extended seems to have been the same. It is described in the following article entitled 'Antient Prescriptive Jurisdiction of the Thames,' by Joseph Fletcher, Esq., in the *Journal of the Statistical Society of London*, vol. 104:—

The charters of James I. here quoted are all in one of the 14th of Charles I. They remain to this day the great record of the city's rights over the river, it is as such that they are recited in this statute. The jurisdiction of meter and conservator are asserted from the mouth of the Thames, the commencement of the city's jurisdiction being marked by a stone, with an iron nail, called London Stone, placed on the north side of the river, a short distance above the present village of Staines, and its termination on the south shore, at the formerly navigable creek of Yantlet, separating the parish of St. Dunstons from the mainland of Kent, and on the north side of the village of Leigh, in Essex, placed directly opposite and close to the lower extremity of Canvey Island, the shore of the Isle of Grain, which separates the parishes of the Thames and Medway, are thus wholly within the city's jurisdiction; notwithstanding that the jurisdiction of conservancy is still asserted in the waters of the Medway, from the southern mouth of Yantlet Creek, towards Rochester, as far as Cockham Wood, on the northern shore, opposite the marshy point of Hatham. At all events, the corporation of London has the right of the city of London to conservancy jurisdiction in the Medway below Yantlet Creek, as well as in the Thames; a limitation which appears to have arisen from this creek having antiently been the only channel of navigation between the two rivers, and the mouths of both. But the passage through the Medway being now completely stopped, so that the Isle of Grain is connected by a solid roadway with the parish of St. Dunstons, the mouths of these rivers are properly at the C., No. 1523.

lower extremity of this island, opposite the Nore and Sheerness, while the city's jurisdiction, more antient than this geographical change, is completely cut by it into two separate portions. About twenty years ago it was attempted by the city officers, under the direction of a court of conservancy, to reunite these portions, by cutting through the bank which prevents the navigation of fishing-boats through Yantlet Creek; but the final decision of the Court of King's Bench, given July 8th, 1825, on the motion for a new trial, was against this proceeding. The conservancy jurisdiction in the Medway extends a distance of only eight miles, but has little more than a nominal existence. In the Thames it extends a distance of eighty miles, over nearly the entire course of that river through the metropolitan valley; and this distance appears to be divided into thirty-four miles of inland navigation from Staines to Vauxhall Bridge, the towing-path ceasing at Putney; three of town thoroughfare, from Vauxhall to London Bridge; and forty-three of seaport, from London Bridge to Yantlet Creek.

In their character of conservators of the Thames the corporation have the control and regulation of the fisheries, and are empowered to seize prohibited nets, fish, &c. They have also the regulation and control of the watermen and of the shipping. They are entrusted with the cleansing of the river, the removal of obstructions, erection of stairs, licensing mills, and other such duties. The lord mayor, with the recorder and other civic officers, holds in person eight courts of conservancy in the year, two for each of the counties of Middlesex, Surrey, Kent, and Essex, and occasionally a court in London. The greater part of their functions are at the present time intrusted to a committee of the common council, called 'The Thames Navigation and Port of London Committee.' Various acts of parliament saving the jurisdiction of the city of London have been passed for the purpose of preventing and punishing offences committed on the river, and the maintaining of a police and magistrates to administer the law. The latest of these is 3 Wm. IV., c. 19.

(Griffiths' *Conservancy of the River Thames*; Pulling, *On the Laws, &c. of the City and Port of London*; Stow, *Survey of London*.)

THAMMUZ. [ADONIS.]

THAMNO'BIA, Mr. Swainson's name for a genus of birds (*Sylvia*, Vieill.) placed by Mr. G. R. Gray in his subfamily *Saxicolinæ*, of his family *Luscinidæ*.

THAMNOPHILINÆ, a subfamily of SHRIKES.

THAMNO'PHILUS, Vieillot's name for a genus of SHRIKES.

THAMNO'SIA. [SEA WEEDS.]

THANE, in Anglo-Saxon *Thegn*, from *thegnian*, or *thenian*, 'to serve,' the same word with the modern German *diener*, is frequently, in conformity with this origin, translated *minister* in the Latin charters of the Anglo-Saxon period. In other cases its equivalent is *miles*, or *fidelis miles*. So king Alfred, in his translation of Bede's 'Ecclesiastical History,' renders the king's minister, the king's thane, and uses thane wherever Bede has *miles*. In this general sense it may be considered as nearly the same with the Norman term liege or liegeman; and so it seems to have been sometimes used. The exact meaning of the term when employed as a title of honour is involved in considerable obscurity: the rank or dignity which it denoted was possibly not the same at different times, and there were also thanes of more than one kind. The king's thanes, in particular, are distinguished from the *medeme* (in Latin *mediocres*), or inferior thanes, who are otherwise designated the thanes of aldermen (the highest order of the Saxon nobility), earls, and other thanes, and who appear to have been very numerous. After the Conquest thanes (*thaini* or *taini*) are frequently classed with barons (barones): in the laws of Henry I., the two words are apparently used as synonymous; and where the Saxon Chronicler has thanes (*thegenas*), the Latin annalists have commonly *barones*. These were, of course, the superior or king's thanes. The class of common or inferior thanes, again, seems to have answered nearly to that of the barones minores, or landed gentry. One of the few things that are tolerably certain with regard to the rank of a thane is, that it implied the possession of a certain amount of landed property. Such a qualification indeed seems in certain circumstances to have conferred the dignity of thane. One of the laws of Athelstane declares that if a ceorl (or commoner) shall have obtained

five hides of land in full property, with a church, a kitchen, a bull-house, a burghate seat (or office of magistrate in a burgh), and a station in the king's hall (the meaning of which last expression is doubtful), he shall henceforth be a thane by right. Five hides of land was probably the amount demanded even for a thane of the highest order; although it appears from Domesday-Book that this was also the quantity which made the owner a miles, or liable to be called out on the king's military service. Many lands are mentioned in Domesday-Book as thane-lands (*terræ tainorum*); and it is probable that the dignity, like the oldest of the Norman baronies, was sometimes attached to a particular estate. Thanes were among the members of the Saxon Witenagemot, or parliament, but it is matter of dispute whether they sat in their own right or as elected representatives. The principal facts connected with this dignity in England have been collected by Mr. Sharon Turner, in his 'History of the Anglo-Saxons,' 8vo., London, 1823, vol. iii., pp. 81, 187-206, 227-231; and by Sir Francis Palgrave, in his 'Rise and Progress of the English Commonwealth,' 4to., 1832, i., 15, 577-579; and ii., cccclxxvi-cclxxxvi.

There is little mention of the thanes in England after the time of Henry II.; but Lord Hailes has shown (*Annals*, i. 28) that in Scotland thane was a recognised title down to the end of the fifteenth century: the 'Chartulary of Moray' mentions a thane of Cawdor in 1492. It appears from the first to have implied in Scotland a higher dignity than in England, and to have been for the most part synonymous with earl, which was a title generally annexed to the territory of a whole county. It has been commonly assumed that thane is the more ancient title, and that it began to be exchanged for earl in the reign of Malcolm Canmore; but, according to Pinkerton (*History of the House of Stuart*, i. 161), the title of thane was not introduced into Scotland till after the time of Malcolm. 'Yet,' he adds, 'the difference between a thane and baron is unknown; and some doubts arise that ignorance may have blended the Saxon *thane* and the Irish *tunist*.'

THANET, ISLE OF. [KENT.]

THANN. [RHIN, HAUT.]

THAPSACUS, or THAPSACUM, was a very ancient, populous, and commercial town in Syria, on the right bank of the Euphrates, about 24 miles west of the junction of the river Chaboras (the Araxes of Xenophon) with the Euphrates. Thapsacus, the Thipsach of the Bible (1 *King*, iv. 24), the Taphsa of the Vulgate, and the Thapsa of Josephus (*Antiq.*, ix. 11), was the most eastern town of the kingdom of Solomon after David had conquered the country as far as the Euphrates. At an equal distance from Tyr by land and from Babylon by water, Thapsacus became an emporium, where the Gerrhaei kept stores of the commodities and spices of Arabia, which they carried there on floats, or probably barks, and which were afterwards transported by land to Syria and Phœnicia and their commercial towns on the Mediterranean. (Strabo, xvi., p. 766, Cas.) Its military position was also of great importance. At the time of the expedition of the younger Cyrus (b.c. 401), there was a ford at Thapsacus, but no bridge; subsequently there was a bridge. This town was the most southern passage by which an army could penetrate, either from Mesopotamia into Syria and Cilicia, or from these countries into Mesopotamia and Persia, without being obliged to traverse the deserts of Arabia, which occupy the whole tract between Palestine and Phœnicia in the west and the lower part of the Euphrates in the east. The younger Cyrus crossed the Euphrates at Thapsacus (Xenophon, *Cyropæd.*, i. 4); Darius also crossed the river at Thapsacus when he was advancing against Alexander in Cilicia; and Alexander, when he was pursuing Darius into Assyria. (Arrian, 2, 13; 3, 7.) In the age of Strabo the bridge at Thapsacus existed no longer, and the passage of the river was made by the bridge at Commagena. (Strabo, p. 747, Cas.) The circumstance of Thapsacus being a town from which military and commercial roads run in every direction, was probably the cause why Eratosthenes chose it as the centre of his geographical measurements in Asia Minor and the adjacent countries, of which Strabo gives an account (iii., p. 77-91, Cas.). It has been said that the ancients did not agree on the situation of Thapsacus, Ptolemy (v. 19) putting it in Arabia Deserta, and Pliny (*Hist. Nat.*, v. 24) and Stephanus Byzantinus and Q. Curtius (x. 1) in Syria. But the town was too well known to allow any

such doubts, and the only fact which follows from these different statements is that the ancient geographers do not exactly agree as to the frontiers of Syria and Arabia Deserta which joined near Thapsacus. Pliny says that in his time this town was called Amphipolis, but this is very doubtful; nor is it true that Seleucus Nicator founded Thapsacus; he perhaps rebuilt it or adorned it with new buildings. According to Stephanus, the Syrians called it Turmeda; and D'Anville states that there is now a small town on the site of Thapsacus, which has the Arabic name of 'El-dar,' or 'the door,' in the *Lingua Franca* 'Porta Catena.'

(D'Anville, *Géographie Ancienne*, vol. ii., 141; Cellarius, *Notitiæ Orbis Antiqui*, vol. ii., p. 367, 368.)

THAPSIA, the name of a genus of plants belonging to the natural order Umbellifere. The species are perennial herbs, with doubly or trebly pinnate leaves, large compound umbels of many rays without involucre or involuella, and yellow flowers. The margin of the calyx is 5-toothed; petals elliptic, entire; fruit compressed from the back; mericarps with 5 primary filiform ribs, 3 of which are dorsal, and 2 lateral ones in the commissure, and with 4 secondary ribs, of which the 2 dorsal are filiform and the 2 lateral ones membranous and winged; vittæ in each furrow underneath the secondary ribs.

The species are mostly natives of the countries of the Mediterranean, and are known under the generic name Deadly Carrot.

T. villosa, Velvety Deadly Carrot, has a square glabrous stem; tri-pinnate leaves, many-parted leaflets, villos on both surfaces, lower ones deflexed. This plant is found in Portugal, Spain, the south of France, in Italy, and the northern coasts of Africa. Poiret states that when fresh the root is acrid and corrosive. In Barbary it is used as a remedy for some forms of cutaneous disease, but it appears to be a severe application and attended with inflammation and vesication of the skin.

T. silphium, Silphium Deadly Carrot, has a square glabrous furrowed stem; pinnate leaves, many-parted leaflets, all linear, hairy on both surfaces, with revolute margins. It is a native of the north of Africa, on the mountains of Cyrenaica, and is supposed to be the plant that produced the juice called *Silphium*, and which was held in so high repute by the ancients, that a district where it grew in abundance was called 'Silphifera.' (SILPHIUM.)

T. Garganica, Garganian or Greek Deadly Carrot, has a square glabrous stem; bi- or tri-pinnate stem segments linear, acute, elongated, quite entire margins; involucre with few leaves; fruit co base. This plant is a native of Calabria, Greece, Sicily, Sardinia, Spain, &c. Dr. Sibthorpe concludes that it is the *silphium* of Dioscorides, whose description it agrees better than any of the rest. It is one of the most stately plants of the family, and is introduced into the gardens of this country as early as the 16th century. There are seven other species of this genus referred to by the ancients, which possess the active properties of the above, seldom employed at the present day.

In their cultivation the species of Thapsia require but little care, as they will grow in any common garden soil. They may be propagated by seeds, which should be sown in autumn as soon as they are ripe.

THASOS (Θάσος), now Thaso, or Tasso, an island situated off the coast of Thrace, at a short distance from the mouth of the river Nestus or Karasou, and about 100 miles south-east of the Gulf of Kavallo. Volgaris, nearly in the centre of the island, is in 41° 40' N. 24° 40' E. long.

Five generations before the time of the Trojan War, Thasos was peopled by Phœniciana, who was sent by Tyre in quest of Europa, led by Thasos, son of Agenor, from whom the island is said to have taken its name (Herod., ii. 44; Pausan., v. 25.) It was also colonized by Æthria (Pliny, iv. 12); and Chryse, a Phœnician (Eustath., *Ad Dionys. Perieget.*, 617), who was distinguished by the epithet Ogygia. It was colonized by settlers from Paros (Thucyd., iv. 104), whom was Archilochus the poet, in 708 or 720 b.c. (Pausan., *Fasti Hellen.*, a. 708, who does not decide the date) Thasos was enriched in very early times by the discovery of gold-mines in the island, and at Scapee Hyle, on the opposite coast of Thrace. According to Herodotus, the most considerable were those

1 by the Phœnicians on the north-east side of the excavations for which were very evident Ierodotus further states that from the proceeds nes, and of their continental territory, which extended for some distance along the Thracian accrued to the Thasians in his time from 200 its yearly, of which sum the mines in Scepte iced 80 talents, and those in the island rather the remarks on this passage in Boeckh, *Public lithens*, ii. 21, Lewis's transl., who assigns the urces of the remainder of this revenue.)

umbered with any taxes on the produce of the Thasians were at this time very rich. 492 they were besieged by Histæus of Miletus ime, and employed their wealth in consequence ships of war and strengthening their fortifica- air independence and growing power excited y of Persia: they were reduced by Mardonius; afterwards, b.c. 491, being suspected of med- it, they were compelled by Darius to throw walls and surrender their ships of war. (Hero-) On the expedition of Xerxes into Greece, asome honour of receiving his army in their territory was imposed upon them, and on this nt they expended 400 talents of silver. (Hero- 8.) After the Persian war they became subject und having a dispute with that state about their ossessions, revolted, b.c. 465. (Thucy., i. 100.) r defeating them at sea, besieged their island, : in the third year of the siege, b.c. 463. The ere compelled to destroy their fortifications, to heir ships, to pay a large sum of money at the ibute for the future, and to give up their mines ents on the continent, among which must have

(Herod., vii. 108), Galepsus and Cæmye . 107), and Datos (Eustat., *Ad Diony.*, 517). scendency of the party of Pisander at Athens at the Peloponnesian war, Diotrefes was sent hasos, and established an oligarchy there. This policy furnished an immediate opportunity of m Athens; the Thasians fortified their city, icating with an exiled party, called in the Spar- ll. (Thucy., viii. 64.) Much internal dissen- ; the Spartan harmost Eteonicus and his party ed shortly afterwards, and the island, reduced by civil war, was finally restored to the Athenians ulus, b.c. 407 (Xenophon, *Hellen.*, 1-4), with ce of a party of the inhabitants under Ec- : Demosthenes, *Lept.*, 474, 25, Reiske, who es that these Thasians received in reward from ans exemption from taxes). Subsequently is appear to have regained some of their con- ssesions, and b.c. 359 they fortified Cre- bly as a frontier post for their Thracian terri- vas seized by Philip, son of Amyntas, king of ho placed a number of Macedonian settlers in : it the name Philippi; under his management nes were made much more productive than ttle more mention of the Thasians occurs in tory. When attacked by Philip V., king of hey submitted to him, with the stipulation that l retain their own laws and be exempt from ibute, or other burthens, b.c. 202 (Polyb., xv. were shortly afterwards released from his rule ans, b.c. 197. (Polyb., xviii. 31.) Under the hasos is styled Libera, or a free state. In the s of Hierocles it forms part of the Provincia and is placed by Constantine Porphyrogennetus ctire, and afterwards in the Theme of Thrace. . II., Them I., Bandur., *Antiqui. Constantin.*) as celebrated among the antients for its marble st., 86), its wine (Virg., *Georg.*, ii. 91; Athe- , which was exported to the Pontus Euxinus, er productions mentioned by Athenæus.

is of Thasos are very numerous. The silver be generally arranged under three classes: which the type is a satyr carrying off a nymph; on of these is very archaic; the limbs have a hair a globular appearance. But this pecu- eatment gradually disappears in the improved later specimens. To this archaic class also be- coins on which are two fish; 2, are a number of ins in a good but rather heavy style, with a head

of Bacchus on the obverse, and Hercules kneeling, shoot- ing an arrow on the reverse. The Thasians had a colossal statue of Hercules at Olympia, holding in one hand a bow. They originally worshipped the Tyrian Hercules, and after- wards the Grecian (Pausan., v. 25); 3, the broad tetra- drachms of the Macedonian period, with the head of the young Bacchus, and Hercules on the reverse: the inscription ΗΡΑΚΛΗΣ ΣΩΤΗΡ. These coins are abundant, and many of them with letters and type ill executed are found in Transylvania, and were probably the work of barbarous Thracians in imitation of the originals. The head of Ceres occurs on these coins (Dionysius Perieg., 523, calls Thasos Δημήτριος ἄκτῃ, the shore of Demeter or Ceres). The inscription ΘΑΣΙΩΝ ΗΠΕΙΡΟ on a gold coin implies, according to Eckhel (*Doct. Vet. Num.*, 'Thasos'), that it was coined from a continental mine, probably Crenides, which would account for the identity of its design with that of a coin of Philippi, on the supposition that a Thasian type was retained by the Macedonians, when they occupied that settlement. No imperial coins are ascribed to this place in Mionnet, except those of Hadrian, Caracalla, and Geta. The type of Perseus mentioned by Pollux (*Onomast.*, ix. 6) has not been discovered on any Thasian coin.



Coin of Thasos.

British Museum. Actual size. Silver. Weight, 117 $\frac{1}{10}$ grs.

The antient town of Thasos is situated on the North coast of the island, and occupies three eminences. On the site are remains of the Greek walls, mingled in picturesque confusion with towers built by the Venetians during their occupation of the island after the taking of Constantinople by the Latins, and overgrown with various timber. Near it is a large statue of Pan in a niche in the rock, and upwards of 50 sarcophagi of white marble. Some inscriptions found in the island are given by Boeckh (*Corpus Inscript.*, ii. 183). The longest, No. 2161, is written in the Ionic dialect, and speaks of the theori and hieromnemon of the place. The antient harbour appears to have been used by the Venetians. No remains of Ænyra and Cœnyra, and of the gold-mines situated between them on the east coast, according to Herodotus, now exist.

Thasos is about 40 Italian miles in circumference. (Carpacchi, *Isole del Mondo*.) Its greatest length is from north to south. In the northern and highest part of the island three peaks extend in a north-west and south-east direction. The inhabitants, amounting to 5000 or 6000, are all Greeks, and live in nine villages, Volgaro, Cassawith, Sotiro, Kai-karahi, Moriass, Kastro, Potamia, Liman, or Panagia, and Theolog, the largest situated nearly in the centre of the island. These contain in all 1020 houses. The chief produce of this fertile country is oil, maize, honey, timber; the last grows in great abundance and in picturesque variety everywhere, particularly on the southern and western sides, and forms the chief article of export; much of it was used for shipbuilding by Mehemet Ali, by permission of the Porte, and much is wasted by the inhabitants in the fires kindled for clearing the land; the plane-trees in particular are of great size. Little wine is made here, and some is imported from Tenedos; the principal food of the inhabitants is maize. Large herds of cattle and flocks of sheep are kept in the island; asses and mules are more used than horses on account of the steepness of the roads. The inhabitants are hospitable, industrious, and simple in their manners. They are governed by a Turkish Aga, whom they expelled during the late Greek revolution, but whom they speedily restored. They suffer from the invasions of pirates, to whom they pay a tribute.

(*Denkwürdigkeiten aus dem Orient, von Prokesh von Osten*, Stuttgart, 1837, iii., pp. 611-32; Cousinery, *Voyage dans la Macédoine*, ii. 85, p. 108.) For the antient history of Thasos, besides the authorities already quoted, see Raoul Rochette, *Histoire des Colonies Grecques*, iii. 228.

THATCH is a covering of straw, rushes, or reeds, as a substitute for tiles or slates for houses, barns, and princi-

pally for sheds for cattle. The increase of agricultural produce on a farm makes the stacking of corn out-of-doors a matter of necessity as well as convenience. The temporary thatching of these stacks, as well as of hay-ricks, has made it necessary that some of the regular servants of the farm should be capable of thatching in a neat and substantial manner, that there may be no delay from want of a regular thatcher. We will first describe the mode of thatching hay-ricks and corn-stacks, as the simplest.

The rick or stack having been formed into a proper shape, either with a roof slanting from a ridge, or conical, ending in a central point, the straw is prepared by moistening it, that it may more easily bend without breaking. It is then forked up in a loose heap, the straws lying in every direction, and somewhat matted. Portions are now drawn out from this heap in handfuls, which lays the straws again in a more parallel order: these are placed in a forked stick, which will hold several of these bundles or handfuls, and are thus carried to the thatcher on the top of the rick or stack. He seizes a handful, and bending one end into a kind of a noose, he inserts this into the hay or straw near the bottom of the roof, at one end if it be a square roof, or at any convenient part if it be a round one. He presses down the straw which he has thus inserted to about half its length, in order to form the eaves, which extend a little beyond the lower part of the roof. When he has thus laid several handfuls side by side so as to cover about a yard in width, that is as far as he can conveniently reach without moving his ladder, he begins another row a little above the place where he began, so that the lower end of the straw now inserted may cover the upper part of the first row, as tiles do each other. Thus he proceeds upwards till he comes to the upper ridge of the roof, or to the point of the cone in a round stack. In the latter case the covering diminishes to a point so as to form a triangle. The ladder is now shifted a yard to one side, and the same operation is performed, care being taken that each fresh handful put on shall be interwoven with that which lies beside it, so that no water can possibly pass between them. Thus the work proceeds till the roof is completed, and it only remains to secure the upper ridge in a square stack, or the point of the cone in a round one. In the first case the highest layer of straw is made to extend beyond the ridge on both sides, and the ends are brought together and stand up like the bristles on a hog. A rope of straw has been prepared, and many small rods, about two feet long, and cut sharp at the point: these are inserted just below the ridge, in a line with it, and about a foot apart; one end of the straw rope is inserted into the stack, and twisted firmly round the projecting end of the first rod; it is then wound once round the next rod, and so on the whole length of the ridge: this is done on both sides. The straws which form the ridge are now cut with shears horizontally, to give it a neat finish, and at each end a kind of ornament is usually made by winding a straw rope round a handful of the projecting straw, forming a kind of knot or bow, according to the taste of the thatcher. Rods and straw ropes twisted round them are inserted near the edge of the slanting side and all along the eaves, which prevent the wind from blowing off the thatch.

The only difference in the thatch of a round rick is, that it is brought to one point, where it is tied with straw rope wound round it, and formed into a kind of bow; the rods are inserted a little below in a circle, and a straw rope twisted round them, and likewise around the circular eaves. Barley is generally put into square stacks, and wheat in round ones. When the outside is neatly trimmed and cut smooth, so that no birds can lodge in it, wheat may be kept for years, without danger of injury or loss, much better than in a barn, or even in a granary.

In thatching sheds and buildings which are to last many years, the straw is prepared in the same manner, but the ends of the handfuls, as they are put on a lathed roof, are kept down by means of long rods, which are tied to the laths of the roof by means of strong tar twine. A much thicker coat of straw is put on; and rye-straw, which has a solid stem, is preferred, as more lasting, and less liable to be filled with water than hollow straw. Instead of straw ropes, split willow is used, and the rods which are inserted are much nearer each other and more carefully secured. As this kind of thatching is a peculiar trade, it requires a regular apprenticeship to be master of it. The thatching

of temporary ricks may be done from mere description, and a very little practice will enable any one to protect his stacks sufficiently by a thatched covering.

Thatching is usually paid by the square of 100 square feet. The thatcher takes a line and throws it over the stack; if it is square, the ends are pushed under the eaves on each side, to allow for the trimming, &c., and this length is multiplied by the length of the eaves, with the same allowance at the ends. The price varies from 2s. to 7s. or 8s. per square, according to the work. Round stacks are measured by taking the circumference at the eaves, multiplied by one-third of the slant of the cone, with a similar allowance.

THAUMA'NTIAS. [PULMOGRADA, vol. xix., p. 122.]

THAUMA'SIA. [SEA-WEEDS.]

THAXTED. [ESSEX.]

THEA, a genus of plants of the tribe Camellieæ and natural family of Ternströmiaceæ, which has been so named from the slightly altered Chinese name of the dried herb which now forms the almost universal beverage of the British Isles. Though now so extensively employed, the introduction of tea into Europe is of comparatively recent origin. Macpherson, in his 'History of European Commerce with India,' states that 'tea' is mentioned as the usual beverage of the Chinese by Sohman, an Arabian merchant, who wrote an account of his travels in the East about the year A.D. 850; and that he had been unable to find any mention of it prior to the times of the Jesuit Missionaries, who entered China and Japan a little before the middle of the sixteenth century. Anderson, in his 'History of Commerce,' vol. ii., p. 178, quotes Boter as giving the earliest account in 1590, when he says that 'they,' that is, the Chinese, 'have also an herb, out of which they press a delicate juice, which serves them as drink instead of wine.' Teixeira, a native of Portugal, about the year 1600, saw the dried leaves of tea at Malacca, and Olearius found them used in 1633 by the Persians, who obtained them from China by means of the Usbeck Tartar. Tsjuan, in his *Observ. Medicæ*, 1641, celebrates the virtues of tea. Anderson says that no mention is as yet made 1660 in the new book of rates, of tea, coffee, or chocolate, though they are all mentioned in an act of parliament of the same year, whereby a duty of eight-pence is charged on every gallon of chocolate, sherbet, and tea made for sale. But the use of it at that time must have been new, for Peps in his 'Diary,' writes, September 25, 1661, 'I sent for a cup of tea (a Chinese drink), of which I had never drunk before.' The Dutch East India Company probably first introduced it into Europe, and from Amsterdam it was brought to London. In the year 1662 King Charles II. married a princess of Portugal, whence, Waller says, 'the best of queens and best of plants we owe to that bold nation,' &c. But tea must have continued to be brought in small quantities only, for in the year 1664 the East India Company purchased, for the purpose of presenting to the king, two pounds and two ounces of tea, and in the year 1678 they imported 4713 pounds of tea, which was then for the first time thought worth their attention as a branch of their trade. (Macpherson, p. 131.)

Tea must have been used in China from very early times. It is differently named in different parts of China, as tsia, or cha, also tha, whence we have tsia, the, and tea. In Persian works in use in India, tea is called cha-khuni or tea of Cathay.

The genus *Thea* is characterised by having a calyx which is persistent, without bracts, five-leaved, leaflets imbricated, the outer ones smaller. Petals of the corol 6 to 8, hypogynous, imbricated, the inner ones the largest, all adhering together at the base. Stamens numerous, in several rows, adhering to the bottom of the petals; filaments filiform, anthers incumbent, 2-celled, oblong, with a thickish connectivum, cells opening longitudinally. Ovary free, 3-celled. Ovules 4 in each cell, inserted alternately into the central angle, the upper ones ascending, the lower pendulous. Style trifid, stigmas 3, acute. Capsule spheroidal, two to three lobed, three or by abortion 2-celled, with loculicidal dehiscence, or with the dissepiments formed from the turned-in edges of the valves. Seeds solitary or rarely two, in cells, shell-like testa, marked with the ventral umbilicus. Cotyledons thick, fleshy, oily. No albumen. Radicle very short, very near the umbilicus, centripetal.

The genus *Camellia* is usually considered to be very distinct from *Thea*; indeed by Cambessedes the two are sep-

each other by several intervening genera: they are too closely allied to allow of this separation. Distinctions have been made in the fruit of the two. That of *Thea* is three-lobed with obtuse corners opening along the middle of the lobes, that is, the dissepiments opposite to the valves, or, as modern botanists, having a loculicidal dehiscence. The other, on the contrary, is described as having its fruit triangular, without any tendency to become deeply indented, with the margins of the valves turned inward along the dissepiments, which thus alternate with the angles, and have what is now called a septicedal dehiscence. Mr. Griffith, on the contrary, who is well known to form a correct opinion, states, from examination of the Assamese tea-plant and of two species of *Camellia* from the Khosiya Hills, that there is no difference between *Thea* and *Camellia*. The dehiscence in both, he says, is of the same nature, that is, loculicidal, and the only difference is that does really exist is simply of specific value, in the fruits of the tea-plant being three-lobed, and of *Camellia* triangular.

Species of the genus *Thea* are few in number; some are of opinion that even these are varieties of a few species. Before proceeding to discuss the question of species which yield the teas of commerce, it is well to notice those which are usually described as a systematic works.

T. viridis is a large, strong-growing, almost hardy shrub with spreading branches, its leaves three to five inches long, thin, almost membranous, very broadly lanceolate, green and wavy, with large and irregularly serrated flowers large, usually solitary, mostly from the upper axil, with 5 sepals and from 5 to 10 petals. This species is figured by Dr. Griffith in his account of the tea-plant, t. 1, and by Dr. W. Hooker, *Bot. Mag.*, t. 3148, and in Loddiges' *Bot. Mag.*, t. 227, all from plants which have flowered in the country. Kämpfer supplies a very good figure, *Bot. Mag.*, p. 607, from a Japanese plant. This species is found both in China and Japan, and is supposed to be the one which yields the green tea of commerce. It was first introduced into this country; having been brought from Japan in 1687 to the Cape of Good Hope, and thence into Europe. Lettsom, in 1772, states that within a few years a few genuine tea-plants had been introduced into England, that the largest tea-plant was then at Kew, the first that ever flowered was at Sion House, and its seeds never germinated. Murray, *App. Medicam.*, t. 27, mentions that the green tea-plant was, in 1778, sold for ten shillings and sixpence, but the black tea-plant for one guinea. The green tea-plants are much more hardy than the black in this climate, being able to stand in the open air with little protection during winter, as at Kew, at Messrs. Loddiges, and even as far as Forfar.

Thea is a smaller plant than *T. viridis*: its branches are woody and straight, its stem erect, the leaves not above two-thirds of the size of the former species, elliptical, perfectly flat, more coriaceous, of a dark green with small and even serratures; they are numerous, have in their axils two or three flowers, of 5 sepals and 10 petals, these are smaller and have a slight fragrance, and are later in the season than *T. viridis*. The plant is much more tender than the green tea-plant, and unable to stand the cold of an English climate. It is supposed by some to yield the leaves which are converted into black tea, notwithstanding contrary statements, leaves similar to those of this plant may be recognised on infusing and adding out the leaves of some of the black teas of commerce. A variety of this is sometimes called *T. stricta*, described by Lettsom, ed. 2, p. 41, who considers it only a variety of the former. It is also figured by Loddiges, *Bot. Mag.*, t. 226, who, as well as Sir W. Hooker and Dr. Griffith, considers it to be a distinct species.

The Assam tea-plant, which has lately attracted so much notice, seems to partake of the characters of both the former. The Calcutta Tea Committee say, in 1836, they are now enabled to state with certainty, that not only is it a genuine tea, but that no doubt can be entertained that it is the identical tea of China, which is the exclusive source of all the varieties and shades of the tea of commerce. To this it may be replied, that there are considerable doubts whether the teas of commerce are all derived

from one species of plant. Mr. Griffith says, in the size both of the plant and of the leaves, as well as in the texture of these last, and in its stations, the Assamese plant approaches to the green tea-plant of China; in its geographical distribution, so far as latitude is concerned, it approaches to the black tea. The inflorescence of the Assamese plant varies, but perhaps its usual state is to have the flowers solitary in the axils of the leaves, but the number of flowers varies from one to five. The plants introduced into this country have their leaves much larger and thicker than those of the green tea-plant, and Messrs. Loddiges find that it requires a much greater degree of heat, in fact that of the hot-house, while the others are in the open air for a great part of the year.

Two other species, described by Loureiro, are little known, as *T. Cochinchinensis*, about eight feet high, having lanceolate leaves, flowers of 3 to 5 sepals and 5 petals, solitary, terminal; found wild in the north of Cochinchina, where it is also cultivated, being used medicinally by the natives as a diaphoretic. *T. oleosa* is also a shrub of eight feet high, found in the fields in the neighbourhood of Canton, and named from its seeds yielding a large quantity of oil, which is used for burning and as an article of diet. The leaves are lanceolate, the flowers of 6 sepals and 6 petals, peduncles 3-flowered axillary; fruit stated to be indehiscent, rather a berry than a capsule.

The species of *Camellia*, which are so closely allied to those of *Thea*, have already been mentioned under *CAMELLIA*, as *C. Japonica*, *maliflora*, *reticulata*. *C. Sasanqua*, and *Euryoides* are other Chinese species. *C. drupifera* is a native of Cochinchina; while *C. Kissi* and *Caudata*, with *oleifolia* and *Scottiana*, two doubtful species, are found in the mountains near Munnipore, Pundua, and Silhet, and in those surrounding the valley of Nepal. A third genuine species occurs on the Naga range, towards the eastern extremity of the valley of Assam. It is well known to the Assamese and Singphos by the name of Bun Fullup, or jungle tea, being used by them as a medicine. A fourth species was found by Dr. Wallich about Tingrei.

Besides the characters of the several species of *Thea*, we have to notice the parts of the country where the cultivated species are found, as many practical questions of considerable importance are connected with the subject. But here it is difficult to be precise in our statements, because we are without positive information from the tea districts of China, and also because it is still doubtful whether one or more species yield the teas of commerce in permanent varieties, or whether the differences in teas are owing solely to differences in manufacture. Tea is cultivated in China over a great extent of territory. Dr. Wallich mentions it as being cultivated in Cochin China, in 17° N. lat. We know it is cultivated in the southern provinces of Yunnan and of Canton. If we proceed north we find the principal cultivation of teas for the foreign trade is between 27° and 31° N. lat.: but tea is said to be produced in several places to the northward of 31°; even in 36°, and also in the Japanese Islands, which extend from 30° to 41° N. lat. It has been disputed whether the tea-plant is cultivated in plains or mountainous situations. It is generally stated to be cultivated in hilly situations. Grozier states that the songlo-tcha (our green tea) takes its name from the mountain Song-lo, situated in the province of Kiangnan, in 30° N. lat., while the bou-y tcha (bohea) takes its name also from a mountain called Bou-y, situated in the province of Fo-kien. Mr. Cunningham (when Chusan had formerly a British factory) collected specimens on the tops of mountains, where the tea-plant flourished along with pines. His specimens are still in the British Museum. The deputation sent into Assam to examine the sites of the tea, saw it growing in the valley of Assam, and were thus led to think that it must grow in similar situations in China: but even in Assam it is also found on hills; and there is no doubt it is found in both situations in China, and in many which must be moist. There is nothing improbable in a plant being so found which is so extensively diffused from north to south; but it is probable that the finest varieties of tea are cultivated in the drier soils, and in situations exposed to light and air: in fact, the Chinese tea-makers in Assam state that in China the teas from the sunny tracts are the best. Some soils in which the tea-plant is cultivated in China yielded, on analysis, in 200 parts—of silex, 135; alumina, 36; carbonate of magnesia, 6; carbonate of lime, 4; oxide of iron, 13; roots and fibres of

plants, 2; water of absorption, 4. Dr. Abel thought that the debris of granitic rocks would yield a fitting soil, and that the Cape of Good Hope would afford a suitable climate. The climate varies, no doubt, to a considerable extent in different parts of China, being warm in the southern and cold in the northern provinces. Snow is said to lie upon the ground for days together upon the green teas, and the green tea-plant is in this country able to bear a greater degree of cold than the black, which, in China, seems to be confined to the more southern provinces; but even in the Fokien hills M. Callery has mentioned to the writer of this article that he has walked on snow in the midst of the tea-plants. The culture of the tea-plant in China seems simple enough: the plants are raised from seeds, sown in the places where they are to remain. Several are dropped into holes four or five inches deep and three or four feet apart, shortly after they ripen; or in November and December, as they do not preserve well, from their oiliness. The plants rise up in a cluster when the rain comes on, and require little further care, except that of removing weeds, till they are three years old, when they yield their first crop of leaves. They are seldom transplanted, but sometimes four to six plants are put close together, so as to form a fine bush. After growing seven or ten years they are cut down, in order that the numerous young shoots which then spring out may afford a more abundant supply of leaves. In some districts the bushes grow unrestrained, in others they are regularly pruned, to keep them low. The gathering of the leaves is performed with great care: they are usually gathered singly, first in March or May (according to the district), when the young leaves are scarcely expanded; the second about two months later, or May and June; and the third in August, or about six weeks after the second; but the times necessarily differ in different districts, as well as the number of crops which are obtained, some avoiding the third, for fear of injuring the bushes. When the leaves are gathered they are dried in houses which contain small furnaces, on each of which there is a flat iron pan, and upon this, when heated, the leaves, partially dried by exposure to the sun, are thrown; the leaves require frequent shifting and turning. When all are properly dried, they are quickly removed either by the hand or with a shovel, and either thrown upon a mat or into baskets which are kept ready to receive them. They are then removed to a table where they are rolled and cooled, and the process is repeated; after which they are sifted and sorted into several varieties. The process has been very minutely described as practised in Assam and Java by the Chinese tea-makers. We may therefore refer to the accounts published by Mr. Bruce, as well as to those of the superintendent in Java, translated by Dr. Horsfield.

The most difficult part of this question is to determine whether the green and black teas are produced by one or two distinct species of plants, as the statements of apparently equally well qualified judges are not only contradictory, but directly the reverse of each other. The difficulty is owing to no competent person having visited the tea districts of China, and also to the Chinese in the neighbourhood of Canton being able to prepare a tea which can be coloured and made up to imitate various qualities of green tea, and large quantities are thus yearly made up. The Chinese tea-makers in Assam and those in Java alike state that the black and green teas may be prepared from the same plant. But as there are plants of the genus *Thea*, of which the leaves resemble some of the black and green teas of commerce, and as these differ very considerably from each other in their powers of resisting cold, and as there are green tea and black tea districts (the former to the north of the latter), it seems probable that different plants are preferred for preparing the finer qualities of these different teas. Whether these plants are one species or well-established varieties can only be determined by botanists who have an opportunity of visiting China, or by experiments made in the tea nurseries of Assam and of the Himalayas, by sowing the seeds of each kind in different soils, aspects, and elevations, and comparing the plants which are produced with one another.

Tea having become so extensive an article of commerce, and a source of considerable revenue, various attempts have been made to introduce it into other countries, but the climates are very different in which the several experiments have been made, as in Rio Janeiro

and the warm part of Brazil, and latterly in the hilly parts of Java and Brazil, in Penang, Assam, and the Himalayas. Dr. Abel recommended the Cape of Good Hope. It is requisite to have not only a suitable soil and climate, but also cheap and abundant labour. Many have been of opinion that tea could be cultivated in the Himalayas, but the first published opinions seem those of Dr. Royle. *Illustr. Himalayan Botany*, p. 5 and 107, and *Proc. Ind. Soc. sources of India*, p. 259), where, from a comparison of a similarity in latitude, climate, and vegetation, any information could be procured on those mountains was of opinion that tea could be successfully cultivated in the Himalayan mountains, 'for the different elevations allow of every variety of climate being selected, and the geographical distribution of this plant is sufficiently extensive and the natural sites sufficiently varied, to be being beneficially cultivated.' He recommended experiments being made in the tract of the Himalayas, extending from Almora nearly to the Sutledge, at various elevations from the valleys up to 7000 feet, and thought that about 5000 feet of elevation would afford a suitable climate. Dr. Falconer formed similar opinions at the same time in a report to government. The correctness of these opinions has been clearly proved by the lately received reports on the success of the tea plantations established in the Kumaon and Gurhwal districts of these mountains, which were formed when the tea nurseries were established in Assam, and the seeds and plants sent up which had been obtained from China. In this report, forwarded by the Indian government to the Agricultural Society of Calcutta, we find that at elevations of 5000 and 6000 feet there are some hundreds of strong and healthy-looking plants and seedlings, but none as yet of a growth to yield seed. At Almora, elevated 5000 feet, there are two gardens, one of three and the other of eleven and a half acres in extent, with 1500 full-grown trees yielding seed, and 700 layers, and upwards of 20,000 seedlings. At Bheemtal, lower in elevation and nearer to the plains, the results are equally favourable: 'On the whole the experiment, in as far as the possibility of rearing the tea-plant in the provinces of Gurhwal and Kumaon is in question, may be safely pronounced to have completely succeeded.' It is also said, 'Assam has doubtless a great advantage over Kumaon as to facility of export, but the latter province will probably be found to yield a produce of a superior quality.' The quality of the tea which can be prepared here can only be ascertained when the preparers have been sent there, as they no doubt will be sent, as soon as the plantations are sufficiently extended.

The value of these facts can only be properly estimated in connection with the success of the tea-culture in Assam, which is several hundred miles distant from Kumaon and Gurhwal, and it is probable therefore that the whole of the intervening part of the Himalayas will be favourable to this culture: probably also some of the mountains of the peninsula, as in the Wynnad district and in Travancore, will be found favourable.

The Assam tea-plant first attracted public attention in 1834, in consequence of replies to the circulars which had been addressed to several gentlemen. Captains Jenkins and Charlton, in May of that year, wrote that a kind of tea-plant was undoubtedly indigenous in Assam. Since then it has appeared that several gentlemen were well aware of the fact, and also that Mr. David Scott had, in June, 1834, sent leaves and seeds of a plant discovered originally by Major Bruce, which he said the Burmese and Chinese resorted to in stating to be wild tea. But the plant was thought to be a *Camellia*, and no further notice was taken of it. A scientific deputation, composed of Dr. Wallich and Messrs. Griffith and MacClelland, was sent for the proper investigation of Upper Assam. Some valuable information has been elicited, which was published in the 'Trans. of the Agric. Soc. of India,' and in the papers respecting tea cultivation in India, published by the House of Commons in 1838. Tea-plantations were subsequently established, and Mr. Bruce appointed their superintendent. At first only a few tea-tracts were discovered: Mr. Bruce in his latest reports notices them as being no less than 120, some of them extensive, both on the hills and on the plains. MacClelland states that they are found in Assam, first on the level plain and secondly on the hills and hillocks, that the former situations have a more humid atmosphere enables them to maintain a dry

ve moisture. As tea-plants are capable of considerable varieties of temperature, tea may be cultivated in a variety of situations, and as well as elsewhere, but it is probable situations and the more open and elevated Assam itself will be best suited for the production of the finer-flavoured teas. The tea which has been raised in Assam has now been sent for four years and in each year the quantities have increased and the qualities have improved. For the teas first sold on the excitement and competition created by the sale, extravagant prices were paid, as in 1834 a pound. In 1840 the prices realized were 6s. 10d. to 10s. 10d. The probable value of the produce of 1841 in Assam is estimated at 2s. 11d. to 3s. 3d. The produce of 1841 in Assam plantations has been sold in Calcutta, and the Assam Tea Company sent to this country. Valuable reports have been published by brokers of the value of this tea, and of the probability, from its nature that it may easily be improved as its nature is understood. Experimental nurseries continue to be established by the East India Company, and much useful information of a practical nature will no doubt be obtained and promulgated. So many authors have written on the subject of tea, that it is impossible to quote them. Mr. M. in his account of the tea-plant, has given a valuable account. More recent information may be found in the works of Abel, Staunton, Ellis, Barrow—and for scientific information see Royle, 'Illustr. of Himalayan Botany,' on the Productive Resources of India, also the Messrs. Griffith and MacClelland, in the 'Transactions of the Soc. of Calcutta,' which likewise contain the reports of the brokers. For practical information on the manufacture of tea, the papers of Mr. Bruce give much valuable information, derived from the China tea-makers; also the 'Cultivation and Manufacture of Tea in Java,' from the Dutch by Dr. Horsfield.

Medical and Dietetical Properties of Tea. This use of which was for a long time confined to the countries of the East, China and Japan, has within the last few hundred years become known and almost indispensable in every civilized country of the globe. It is interesting to enquire what are the properties of which it has induced so large a portion of the population to forsake other articles of diet, and what are the effects of its extensive consumption.

It is obtained from one species only of the genus *Camellia* on several, all the tea of China is in commerce under two distinct terms, *green* tea and *black* tea, and is also distinguished as *hyson* or *rown* tea.

The European name *tea* is borrowed from the language of the province Fu-kian (Fokien of China), where this article is called *Tiä* in their patois: it is called *Tscha* or *Tschai*. Black tea is called *tscha*, green tea *Lo-tscha*. The best sort of tea has been long known in commerce under the name of *Bou-ai-Tscha*; hence by a transposition of syllables, the *Thea bohea* of Linnæus, the *cha* of the Chinese, that is, tea from *Vou-y-Schan*, in the province of Fu-kian, in 27° 47' N. lat. chiefly obtained from Song-lo, which lies in the province of Kiang-nan, in 29° 58' N. lat.

The varieties owe their names to other circumstances, and of which is endless. Thus there occur in the province of the Chinese merchants at least one hundred names, many of which are synonyms of other names invented to impose on foreigners and obtain a high price. The distinguished Oriental scholar P. G. gives a list of about forty genuine varieties, and a planation of the terms applied to them. (*Journeé*, 1824, p. 121, and Abel Remusat, a Supplement, p. 186 of the same journal; or Fée, *Cours Naturelle Pharmaceutique*, i., p. 507.) Thus the tea which is exported to Pekoe, or even Pekin, merely means the first sprouts, or yet hairy leaf-buds of the plants, three years old, after their first flowering; and it is applied only to a black tea, but it is applicable to a green tea, and is by the Chinese an expensive kind called *Loong-tsing*, literally *cells of the dragon*, which is never brought to it is so delicate and slightly fired as to spoil by damp. (Davis.) The true imperial tea, also these, not that it is the flower-buds, as some

suppose, but merely the perfection of tea, never reaches Europe, as the damp of the voyage and a northern climate would soon impair its qualities. That which is sold under the name of Imperial is *Chulan*, or *Soulang*, flavoured with the *lan-hoa*, which is the Chinese name for the *Olea fragrans*, Lin.

Though it is stated that black tea may be cured as green tea, and green tea as black, certain it is that the preparation of the respective kinds is carried on in different parts of the empire, and different practices pursued with the leaves from the first stage. In the green teas the leaves only are taken, being nipped off above the foot-stalk or petiole, while of the black teas the foot-stalk is always collected. Thus black tea contains much of the woody fibre, while the green is exclusively the fleshy part of the leaf itself; which is one good reason why it should be dearer. (Davis, ii., p. 351.) Besides this, the constant removal of the young leaf-buds, by which the plant is prevented from being clothed with full-grown leaves, which alone can elaborate the sap, and contribute to the further growth of the shrub, causes it to perish earlier, and compels a more frequent renewal of the plantations. Indeed some cultivators restrict the gathering of the leaves to two harvests, instead of three, to save their plants.

Those of the third gathering are large and coarse, and often so rigid that they cannot be rolled. This yields a tea so inferior in quality that it is consumed only by the poorest of the natives, or, when very bad, is, as are some of the finer kinds when spoiled, used for dyeing.

Such are the pains taken to ensure the excellence of the finest sorts, that for two or three weeks before the harvest commences the collectors, who are trained to this business from a very early age, are prohibited from eating fish or other kinds of food reckoned unclean, lest by their breath they should contaminate the leaves. They are also made to take a bath two or three times a day, and not allowed to gather the leaves with the naked fingers, but always with gloves. The finest tea may, if the proper time for gathering it be neglected, be changed into an inferior tea in one night. It is necessary to roast the leaves the same evening that they are collected, for if kept till the following day they become black and lose much of their virtue. Previous to putting them into the iron pans or furnaces, which are heated by charcoal, some writers say that they are dipped for about half a minute into boiling water; others do not mention this. About half a pound or three-quarters of leaves are put into the pan at once, and diligently stirred, to prevent them from being burnt. They are then removed with a shovel and thrown on mats or into baskets, and while yet hot the soft leaves are rolled between the palms of the hands, during which operation a quantity of yellowish green juice exudes from them. This process of roasting and rolling is often repeated even to the sixth or seventh time. This method is called the *dry way*; but by the *wet way* the leaves are first exposed to the vapour of boiling water, after which they are rolled and dried on the iron pans like the others. Leaves prepared in the wet way have a bright green colour; those by the dry, a dark green verging to brown. From the green tea, when prepared in the dry way, less of the above-mentioned juice exudes, a circumstance to which the greater power of green tea is in some degree owing. The larger leaves are generally selected to be prepared in the wet way. By the process of roasting the leaves lose two-thirds of their weight; so that three pounds of fresh leaves dry into one pound of tea fit for preservation. It is by the process of roasting that the flavour is first developed, the leaves when fresh being as insipid as the bean of coffee before heat is applied. Siebold is of opinion that the agreeable violet-like flavour of tea is inherent in the leaves themselves, but most writers ascribe the different flavours of the choicer kinds of tea to the admixture of the flowers, leaves, or oils of a variety of different plants. The chief of these are the *Olea fragrans*, *Chloranthus inconspicuus*, *Gardenia florida*, *Aglaiia odorata*, *Mogorium (Jasminum) Sambac*, *Vitex spicata*, *Camellia Sasanqua*, and *C. oleifera*, *Illicium anisatum*, *Magnolia Yulan*, and the *Rosa Indica odoratissima*, as well as with the root of the *Iris Florentina*, and *Curcuma longa* or turmeric, and oil of *Biza Orellana*. A variety of tea called *Sonchi* is often found to contain a large quantity of ferruginous dust, but whether by accident, as Mr. Davis thinks (*Chinese*, ii., p. 462), or a fraud to increase the weight, is doubtful. Its

presence may easily be detected by passing a magnet into a suspected sample, when some of the particles of iron will adhere to it.

The Chinese annually dry many millions of pounds of the leaves of different plants, to mingle with the genuine, such as those of ash, plum, &c., as the name Mei-Pian, applied to one of the varieties of tea from the province of Kiang-nan, imports; so that all the spurious leaves found in parcels of bad tea must not be supposed to be introduced into them by the dealers in this country. While the tea-trade was entirely in the hands of the East-India Company, few of these adulterated teas were shipped for this country, as experienced and competent inspectors with large salaries were kept at Canton, to prevent the exportation of such in the Company's ships; but since the trade has been opened, all kinds find a ready outlet, and, as the demand often exceeds the supply, a manufactured article is furnished to the rival crews.

The object of the drying and rolling is both to diminish the bulk and to enable the leaves to preserve their flavour. No tea is thought fit for use till it is a twelvemonth old; and the rich and luxurious Chinese keep the fine tea in jars, made of the finest porcelain, some of which are thought to communicate an additional aroma to the tea, and all of which have very narrow mouths (as may be observed in those brought to Europe, and sold at a high price), to retain the peculiar odour. If the tea contracts damp, it is taken out and roasted again.

The taste of tea is more or less astringent, and, before it is infused, unpleasantly acrid. To make the infusion, the Chinese pour boiling-water on a small portion of the leaves, but do not allow it to stand or macerate, as is done in England, but instantly pour it off again, by which they obtain only the more volatile and stimulating portion of its principles. The poorer Chinese indeed boil the very inferior and coarse leaves, which alone are within their reach, and drink the decoction repeatedly during the day. This is done not only to extract such virtues as the tea possesses, but to qualify the water, as little good drinking water is met with in China. Travellers find a supply of tea a very valuable accompaniment on long journeys, as it improves the most brackish waters. The exciting effects of fresh tea are such that it is rarely used till it has been kept twelve months, as already stated; and where indulged in, it produces great disturbance of the mind, almost resembling inebriation, like the action of the Erythroxylon Coca among the Peruvians, and inducing a tremulous motion of the limbs. This property is diminished by repeated roastings, but as green tea is less exposed to heat than black, it retains more of this power. Besides, the green tea for exportation undergoes some process, which changes its colour, giving it a bluish-green hue. The Chinese themselves do not consume those kinds of green tea which are prepared for exportation. (Davis, *Chinese*, ii. 468.) It is altogether a mistake to suppose that the colour of green tea is owing to its being dried on copper pans, as none such are used, and the most searching chemical analysis is unable to detect a trace of copper unless as a constituent of the vegetable. The chemical analysis of tea does not shed much light on its action on the human system. Frank and Sir H. Davy found more tannin in black than in green tea; but the results of Mr. Brande's researches, conducted on a more extensive scale, give a different result. 'Some years ago I examined the varieties of tea in common use (*Quarterly Journal*, xii. 201), and found that the quantity of astringent matter precipitable by gelatine is somewhat greater in green than in black tea, though the excess is by no means so great as the comparative flavours of the two would lead one to expect. The entire quantity of soluble matter is also greater in green than in black tea, but the extractive, not precipitable by gelatine, is greater in the latter.'

The following table shows the respective quantities of soluble matter in water and in alcohol, the weight of the precipitate by isinglass, and the proportion of inert woody fibre in green and black tea of various prices. It is given, not as throwing any important light upon the cause of the different qualities and effects of tea, but as containing the results of actual experiments. It will be remarked that when tea-leaves have been exhausted by water repeatedly affused, alcohol is still capable of extracting a considerable quantity of soluble matter: the alcoholic extract infused in boiling water, furnishes a liquid which smells and tastes

strongly of tea, and which, were it not for the expense of the solvent, and the trouble attending its separation, might perhaps be profitably employed.

100 parts of Tea.	per lb.	Soluble in Water.	Soluble in Alcohol.	Free, with J. J.	Insoluble
Green Hyson	14s.	41	44	31	56
..	12	34	43	29	57
..	10	36	43	26	56
..	8	36	42	25	56
..	7	31	41	24	57
Black Souchong	12	35	36	28	64
..	10	34	37	28	63
..	8	37	35	28	63
..	7	36	35	24	64
..	6	35	31	23	65

(Brande's *Manual of Pharmacy*, 5th ed., p. 124.)

The fall in the prices of tea does not much affect these results, as the same relative proportions are preserved.

The alkaloid-like principle of tea can scarcely be considered the cause of the peculiar action of tea; but it is very interesting from the circumstance of the identity of its composition with that of coffee, and of the *gumma officinalis*, as shown by Liebig:—

	Caffeine.	Theine.	Guaraine.	Calab.
	Pfaff and Liebig.	Jobst.	Martius. C.	De Me.
Carbon	49.77	50.101	49.679	
Hydrogen	5.33	5.214	5.139	
Nitrogen	28.78	29.009	29.180	28
Oxygen	16.12	15.676	16.002	16

Bergma obtained an oil, but this, as well as the distilled water, he found to have little peculiar effect on animals: which is in opposition to the experiments of Lettsom, who represents the distilled water of tea as a powerful narcotic, paralyzing the limbs of frogs, and causing their death when applied to the exposed nerves.

Before attempting to estimate the action of tea on the human system, it is necessary to call to mind that some of the effects are due to the plants mixed with the real tea, several of which, such as the Chloranthus inconspicuus are stimulants of the highest order; and in other instances deleterious chemical compounds are used by the Chinese to convert damaged black teas into saleable green teas. (Davis, *Chinese*, ii. 466.) For the effects of these teas are not justly chargeable. A correct estimate of the action of tea is not easily formed; yet the most dispassionate inquirers regard it as a narcotic, the stimulating period of which is the most conspicuous and of longest duration. Tea has been preposterously praised by some writers, and unjustly accused by others as being productive of numerous diseases: above all it has been charged with causing an increase of nervous diseases. It would perhaps be more just to attribute the increase of such complaints to the more complicated state of our social relations, arising from an augmented population, and an advance in luxury, with the more frequent infringement of the natural law, particularly turning night into day, and not seldom day into night, as is the practice of the votaries of fashion. That the universal employment of tea has displaced some other kinds of food is certain, but if a diminution in the number of inflammatory diseases be one of the consequences, it is much to its credit, as however distressing nervous diseases may be, they are by no means so fatal as those of an inflammatory kind. That tea should not suit all constitutions or all ages is not remarkable. It is less suited for young children than for adults; indeed for very young children it is extremely improper, producing, like all narcotics, a morbid state of the brain and nervous system. It is also unsuited for those of an irritable nature, and likewise for those of a leucophlegmatic constitution. Such persons can ill bear much liquid of any kind, particularly in the evening, and prosper best on a very dry diet, to which growing children of this constitution should be strictly confined. [DILUENTS.] It may not be true that the use of tea, as alleged by Dr. Lettsom, has been a main cause of the increase of scrophulous diseases, as diseases of this class are the only diseases which are perhaps more frequent than others, whatever nervous power and ultimately the digestive powers of sturmount children should be avoided. His advice where he says, 'It ought by no means to be the

arding-schools; if it be allowed sometimes as a y should be at the same time informed that the use of it would be injurious to their health, and constitution.' Those to whom it is most : the plethoric and sanguine. Upon the same it is a proper article of diet and perhaps the best drink at the beginning of fevers and inflammatory s. In a peculiar state of brain, termed by Mr. 1 (*Observations on Medical and Dietetical Pro- Green Tea*) sthenic excitement, a state clearly on inflammation, especially if produced by alco- ulants, or by intense and long-continued applica- nd to any particular object of literary research, acts as a salutary remedy. On the contrary, in diminished excitement, morbid vigilance and isturbance follow its use. It is not an uncommon ith ardent students, when pushing their studies ie night, to resist the claims of nature for repose, themselves awake by the frequent use of tea. swers the purpose at the time cannot be denied, ject is often attained at a fearful price, the def- of health and vigour both of mind and body being ty. Less injury results in these cases from the fee. There is this difference between the morbid he nervous system produced by coffee and those from tea: that the former generally subside or entirely on relinquishing its use; those from the more permanent, and often incapable of being l. Nevertheless many persons have immediately ir health improved by entirely relinquishing the , or even omitting it only at breakfast, for which ; certainly less proper than for the evening be- Those for whom tea is unsuited will generally cocoa the most proper substitute.

of a gouty and rheumatic nature, above all, those alculous diseases of the lithic acid diathesis, find the least objectionable article of common drink. uld take it without sugar, and with very little out, *On the Stomach*, p. 217.) Where the water e addition of a little carbonate of soda not only the tea, but renders it a more proper beverage ersons. Tea should not be used till about four r any solid meal.

ical uses of tea are not many. In fevers it is in excellent diluent at the commencement, but of tea made by macerating tea in proof-spirit, a tea-spoonful of this to a small cup of water, at short intervals during the night, after the yptoms have subsided, is often of great service. epose, in hospitals and workhouses, the leaves ve been used for the ordinary infusion may be l in alcohol (as suggested above by Mr. Brande), it of sufficient strength for this purpose obtained) rate.

e forms of diseased heart tea proves a useful It is nearly as valuable an antidote to poison- ium as coffee is. Some cases of poisoning by d tartarized antimony have been prevented prov- by the immediate administration of tea in the very strong infusion. Here its power as an depends upon its tannin decomposing the poison- ances. [ASTRINGENTS.] But in poisoning by s useful only in combating the secondary symp- should not be administered till the stomach- other means have removed the opium from the (*Lancet*, 9th November, 1833.) Some cases of vrous headache are relieved by a cup of strong taken without milk or sugar. But this should y resorted to; it is a wiser plan to avoid the such headaches. Tea has been looked upon as means by which intoxication was to be banished, certain that to relieve the tremblings and other t effects of the abuse of tea, a little brandy or holic stimulant is occasionally added to the cup d so a habit is acquired which can never after- relinquished.

requently been denounced as a useless article the poor, as it is assumed to be devoid of nutri- l the milk and sugar which are added supposed : only beneficial ingredients. Dr. Lettsom has alculation, partly his own, and partly taken from 'Husbandry,' to show how much is, in his view, ily expended by them in this way. But the C., No. 1524.

observations of Liebig, if correct, and in all probability they are so, offer a satisfactory explanation of the cause of the great partiality of the poor not only for tea, but for tea of an expensive and therefore superior kind. 'We shall never certainly be able to discover how men were led to the use of the hot infusion of the leaves of a certain shrub (tea), or of a decoction of certain roasted seeds (coffee). Some cause there must be which would explain how the practice has become a necessary of life to whole nations. But it is still more remarkable that the beneficial effects of both plants on the health must be ascribed to one and the same substance, the presence of which in two vegetables belonging to natural families, and the produce of different quarters of the globe, could hardly have presented itself to the boldest imagination. Yet recent researches have shown, in such a manner as to exclude all doubt, that caffeine and theine are, in all respects, identical.

'Without entering minutely into the medical action of caffeine (theine), it will surely appear a most striking fact, even if we were to deny its influence on the process of secretion, that this substance, with the addition of oxygen and the elements of water, can yield taurine, the nitrogenized compound peculiar to bile:—

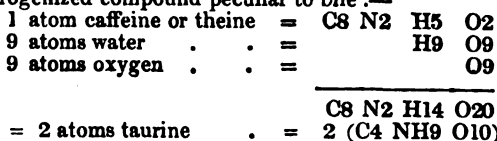

To see how the action of caffeine, asparagine, theo- bromine, &c. may be explained, we must call to mind that the chief constituent of the bile contains only 3.8 per cent. of nitrogen, of which only the half, or 1.9 per cent., belongs to the taurine. Bile contains in its natural state water and solid matter, in the proportion of 90 parts by weight of the former to 10 of the latter. If we suppose these 10 parts by weight of solid matter to be choleic acid, with 3.87 per cent. of nitrogen, then 100 parts of fresh bile will contain 0.171 parts of nitrogen in the shape of taurine. Now this quantity is contained in 0.6 parts of caffeine; or 2.3ths grains of caffeine can give to an ounce of bile the nitrogen it contains in the form of taurine. If an infusion of tea contain no more than the 1/10th of a grain of caffeine, still, if it contribute in point of fact to the formation of bile, the action, even of such a quantity, cannot be looked upon as a nullity. Neither can it be denied, that in the case of an excess of non-azotized food and a deficiency of motion, which is required to cause the change of matter of the tissues, and thus to yield the nitrogenized product which enters into the composition of the bile; that in such a condition the health may be benefited by the use of compounds which are capable of supplying the place of the nitrogenized substance produced in the healthy state of the body, and essential to the production of an important element of respiration. In a chemical sense—and it is this alone which the preceding remarks are intended to show—caf- feine, or theine, asparagine, and theobromine, are, in vir- tue of their composition, better adapted to this purpose than all other nitrogenized vegetable principles. The action of these substances, in ordinary circumstances, is not obvious, but it unquestionably exists. Tea and coffee were originally met with among nations whose diet is chiefly vegetable.' (*Liebig's Animal Chemistry*, p. 178.) These facts show in what way tea proves to the poor a substitute for animal food, and why females and literary persons who take little exercise manifest such partiality for it. They also explain why the attempts, and they have been numerous, to find among other plants a substi- tute for tea have invariably failed of success. The first tea-leaves were procured from the Chinese in exchange for those of the *Salvia officinalis*, or garden sage, but they, like others, soon found out its inferiority, and refused to part with their own precious leaf except in exchange for solid coin. The poor Chinese make use of the leaves of a fern, and also of those of the *Sagaretia* (*Rhamnus*) *theezans*; but to this their poverty, not their will, consents.

Tea Trade.—The period when tea was first introduced into this country has already been noticed. How little was it possible at the time to have foreseen that it would one day become one of the most important articles of foreign production consumed in England. The first im-

portation by the English East India Company took place in 1669 from the Company's factory at Bantam. The directors ordered their servants to 'send home by their ships one hundred pounds weight of the best *tey* they could get.' In 1678, as already noticed, 4713lbs. were imported, but in the six following years the entire imports amounted to no more than 410 lbs. The continuous official accounts of the trade do not commence before 1725 but, according to Milburn (*Oriental Commerce*), the consumption in 1711 was 141,995 lbs.; 120,695 lbs. in 1715; and 237,904 lbs. in 1720. The following is a

Table showing the Quantity of Tea retained for Consumption, and the Rate of Duty in each Year, from 1725 to 1834:—

Year.	lbs.	Rate of Duty.	
		Customs.—Per Cent.	Excise.
1725	370,323	13l. 18s. 7½d.	4s. per lb.
1726	360,377	"	"
1727	466,688	"	"
1728	543,024	"	"
1729	685,387	"	"
1730	810,110	"	"
1731	787,434	"	"
1732	647,551	"	"
1733	565,895	"	"
1734	632,374	"	"
1735	636,033	"	"
1736	752,745	"	"
1737	1,160,054	"	"
1738	1,142,637	"	"
1739	1,113,361	"	"
1740	1,002,929	"	"
1741	890,191	"	"
1742	870,420	"	"
1743	764,320	"	"
1744	751,800	"	"
1745	730,729	"	1s. per lb. and 25 per cent. on the price.
1746	2,358,569	"	"
1747	2,982,775	18l. 18s. 7½d.	"
1748	2,493,811	"	"
1749	2,768,807	"	"
1750	2,564,338	"	"
1751	2,774,809	"	"
1752	2,976,626	"	"
1753	3,131,866	"	"
1754	3,447,017	"	"
1755	3,556,146	"	"
1756	3,728,533	"	"
1757	3,961,799	"	"
1758	4,205,394	"	"
1759	3,957,744	23l. 18s. 7½d.	"
1760	4,072,148	"	"
1761	4,434,194	"	"
1762	4,236,408	"	"
1763	4,529,432	"	"
1764	4,719,479	"	"
1765	4,636,940	"	"
1766	4,606,513	"	"
1767	3,762,620	"	"
1768	6,892,075	"	25 p. ct. on gross price.
1769	6,965,899	"	"
1770	7,149,245	"	"
1771	5,912,245	"	"
1772	7,838,341	"	"
1773	4,427,646	"	1s. a lb. and 25 p. ct. on the gross price.
1774	6,285,113	"	"
1775	5,648,188	"	"
1776	5,138,218	"	"
1777	4,741,434	"	"
1778	4,642,066	"	"
1779	5,295,054	25l. 2s. 6½d.	5 per ct. additional on former duties.
1780	5,152,899	"	"
1781	4,915,472	25l. 16s. 3d.	5 per cent. additional
1782	4,691,060	27l. 0s. 10d.	5 per cent. additional
1783	5,282,209	"	"
1784	4,948,983	"	"
1785	10,856,578	12½ per cent.	Excise duty repealed.
1786	12,539,369	5 p. ct. on gross price.	7½ per cent. on gross price.

Year.	lbs.	Rate of Duty.	
		Customs.—Per Cent.	Excise.
1787	17,047,054	5 p. ct. on gross price.	7½ per cent on price.
1788	13,218,665	"	"
1789	14,534,601	"	"
1790	14,693,299	"	"
1791	15,096,840	"	"
1792	15,622,045	"	"
1793	15,244,931	"	"
1794	16,647,963	"	"
1795	18,394,232	"	"
1796	18,009,992	"	"
1797	16,368,041	5 p. ct. on gross price.	15 per cent.
1798	19,566,934	"	per lb.
1799	19,906,510	"	15 per cent.
1800	20,368,702	"	per lb.
1801	20,237,758	"	15 per cent., 45 per lb.
1802	21,848,245	"	"
1803	21,647,922	"	60 per cent. on price.
1804	18,501,904	"	"
1805	21,026,360	5l. 2s. 6d. on gross price.	"
1806	20,355,038	6l.	90 per cent. on all.
1807	19,239,312	"	"
1808	20,859,929	"	"
1809	19,869,134	"	"
1810	19,093,244	"	"
1811	20,702,909	"	"
1812	20,018,251	"	"
1813	20,443,236	"	"
1814	19,234,154	"	"
1815	22,378,345	"	"
1816	20,246,144	"	"
1817	20,822,926	"	"
1818	22,660,177	"	"
1819	22,631,467	Customs' duty repealed.	Under 2s. above
1820	22,452,050	"	"
1821	22,892,913	"	"
1822	23,911,884	"	"
1823	23,762,470	"	"
1824	23,784,838	"	"
1825	24,630,015	"	"
1826	25,238,067	"	"
1827	26,043,223	"	"
1828	26,790,336	"	"
1829	29,496,199	"	"
1830	30,047,079	"	"
1831	29,997,101	"	"
1832	31,548,409	"	"
1833	31,829,619	"	"
1834	34,969,651	Bohea, 1s. 6d.; Congou, Twankay &c., 2s. 6d.; Hyson, &c. 3s. per lb.	Excise duty
1835	36,574,004	"	"
1836	49,142,236	After 1st July, all sorts 2s. 1d. per lb.	"
1837	30,625,206	"	"
1838	32,351,563	"	"
1839	35,127,267	"	"
1840	32,252,626	Add. 5 per ct.	"
1841	36,681,877	"	"

For above a century and a half the sole East India Company's trade with the United Kingdom was enjoyed by the East India Company and were bound from time to time to send ships to provide for the consumption in their respective ports, and the Company were disposed of in London, where they were sold at quarterly sales, and the Company sell them to the public at one penny per lb.

was put up, which price was determined by adding ther the prime cost at Canton and the bare charges of ht, insurance, interest on capital, and certain charges mportation; but by the mode of calculating these and the heavier expenses which always attend every ment of a trade monopoly, the upset prices were lly enhanced. The prices realised at the Company's ere however in still greater proportion beyond the t prices, a result easily produced by a body who olized the sole supply, as it was only necessary that quantity offered for sale should not be augmented in ortion to the growing demand of a rapidly increasing lation. The 18 Geo. II., c. 26, passed immediately a large reduction of the duty had taken place, pro- for such a contingency as this, by enacting that if India Company failed to import a quantity suffi- to render the prices as low as in other parts of pe, it should be lawful to grant licences to other per- to import tea. This would have constituted a very nt check if it had been acted upon; but eventually ome of levying the duty gave the government almost e interest in a restricted supply as the East India y, the duties being collected *ad valorem* on the t realised at the Company's sales; and thus the very instance which enhanced the price raised the total nt of duty. The duty was nominally 90 and 100 per . *ad valorem*, but being charged on a monopoly price, fference on the cheaper teas consumed by the work- and middle classes amounted to above 300 per cent. e cost price of the same teas at Hamburg; and in the difference between the prices realised at the any's sales and the Hamburg prices amounted to a of 1,889,975*l*. The sales in the last year of the East y Company's monopoly are shown in the following

Account of the Quantity and Prices of several sorts ea sold in England from May 1st, 1833, to May 1st,

	lbs.	s.	d.
Bohea	6,170,963	..	1 10
Congou	18,653,835	..	2 1
Campoi	1,603	..	2 4
Souchong	354,515	..	2 9
Pekoe	514,811	..	2 10
Twankay	4,339,672	..	2 1
Hyson Skin	141,610	..	2 2
Hyson	987,052	..	3 6
Total	31,164,065		

Company's sales were in March, June, September, December, the latter being the largest. About 1,000 lbs. were offered belonging to the officers of the any, who were allowed to import a certain quantity a on their own account. In 1839 there were only 112 lbs. offered for sale by the East India Company; the change effected by the 3 & 4 Wm. IV., c. 93, h, on the 22nd of April, 1834, opened the trade to a, is now complete. The importation of tea is no er confined to the port of London. In 1839 eighteen rived inwards from China at different outports, of which were entered at Liverpool. In the four ending 1834 the average annual number of ships red inwards from China at the ports of the United om was 23, in the four following years the average d, and other commodities besides tea have been vely imported, and a corresponding increase in the ity and variety of the exports to China has taken e. The exports of tea from the United Kingdom, h formerly did not exceed a quarter of a million lbs. ally, amounted to 4,347,432 lbs. in 1841, and have aged above three million lbs. a year since the open- of the trade, a fact which shows that prices here are onger so much above those of the principal conti- al ports. The quantity retained for consumption has considerably increased, although accompanied by an ordinary increase in the use of coffee. e tea-duty produces about one-thirteenth of the total nue; and only three articles, spirits, malt, and sugar, l a larger sum. The tariff of 1842 has made no ation in the tea-duty. As it was foreseen that on opening of the tea trade there would be a considerable ction of price, and that an *ad valorem* duty would even with the increased consumption, be so pro- ive as formerly, a fixed duty per lb. was imposed,

whicn, from 1834, to July, 1836, varied according to the different kinds of tea; but as this mode of collection was attended with considerable trouble and difficulty, it was altered to an unvarying duty of 2*s*. 1*d*. per lb. on all kinds without distinction. Since March, 1836, the tea-dealers have been relieved from the vexatious interference of the excise, the duty being collected entirely as an import duty by the officers of the customs. Previously, each of the hundred thousand tea-dealers in the United Kingdom were visited once a month by the officers of excise, who took an account of their stock; and no quantity exceeding six pounds could be sent from their premises without a permit, of which above 800,000 were required in a year. In short, this system of supervision was very troublesome, costly, and answered no useful purpose. The number of tea-dealers in 1839 was 82,794 in England; 13,611 in Scotland; 12,774 in Ireland: total, 109,179. Tea is now sold by the importing merchants by public auction and private sales.

The following table shows the revenue which the tea duty has yielded in each year during the present century, and, to some extent, it is an index of the prices in each year:—

Net Amount of Duty collected upon Tea in the United Kingdom in each year from 1800 to 1841 inclusive:—

1801	£1,423,660	1822	£3,941,484
1802	1,632,467	1823	3,848,122
1803	1,929,613	1824	3,865,477
1804	2,599,738	1825	4,031,018
1805	3,336,523	1826	3,738,042
1806	3,446,670	1827	3,705,588
1807	3,525,173	1828	3,177,179
1808	3,905,295	1829	3,321,722
1809	3,592,705	1830	3,387,097
1810	3,647,737	1831	3,344,918
1811	3,752,111	1832	3,509,835
1812	3,822,979	1833	3,444,102
1813. Records burnt.		1834	3,589,361
1814	3,958,054	1835	3,832,432
1815	4,058,091	1836	4,674,535
1816	4,362,496	1837	3,223,840
1817	3,431,364	1838	3,362,035
1818	3,872,693	1839	3,658,803
1819	3,689,805	1840	3,473,964
1820	3,484,226	1841	3,978,198
1821	3,707,270		

Between 1831 and 1841 the population increased 14 per cent., and the increase in the consumption of tea was 16 per cent. The low prices of 1836, and the general prosperous condition of the country, raised the quantity which paid duty for consumption to nearly 50,000,000 lbs. In 1840 prices were about 25 per cent. higher, large classes of consumers were in a distressed state, and the consumption fell to 32,000,000 lbs. In 1841 the distress still continued, but prices were lower, and the consumption rose to above 36,000,000 lbs. On the 5th of Jan., 1840, the stock of tea in London, Liverpool, Bristol, Glasgow, and Leith was 35,478,490 lbs.; and at the corresponding period in 1841 the quantity was 46,545,610 lbs. The proportion of black to green teas consumed in England is about as 5 to 1; but in the United States the use of green tea is greatest. (*Papers issued by the Chinese and East India Association; Parl. Papers, &c.*)

The total export of tea from Canton to Europe and America exceeds 50,000,000 lbs. Russia is supplied with 6,500,000 lbs. *via* Kiakhta; the United States of America require about 8,000,000 lbs.; France about 2,000,000 lbs.; and Holland imports about 2,800,000 lbs. The green tea districts are about 700 miles, and those where the black tea is made about 200 miles from Canton. The article is brought from Canton by land carriage, chiefly by porters and by the canals; and the number of tea merchants who resort to Canton in the season when the trade is most active, that is, from October to March, is said to be about 700. The functions of the Hong merchants, through whom Europeans make their purchases, have been already explained. [CANTON.] The trade has not been interrupted in consequence of the present dispute between England and China, nor is it likely to be, as it is one of the greatest importance to the Chinese; and whenever, in former disputes, it has been temporarily suspended, no difficulty has occurred in obtaining the usual supply through the traders of other nations at Canton.

THEATINS, or TEATINS, an order of monks founded at Rome in 1524, principally by Giampietro Caraffa, who was then archbishop of Chieti, in Naples, the Latin name of which is Teate, and who afterwards became pope under the title of Paul IV. The institution was confirmed at the time of its foundation by the reigning pope, Clement VII.; and a final rule, or code of regulations, drawn up by a general chapter of the order, was authorised by Clement VIII. in 1604. The Theatins were principally established in Italy and in France, into which latter country, where they subsisted till the Revolution of 1789, they were brought in 1644 by Cardinal Mazarin, who bought them their house at Paris, near the Louvre, and at his death left them 800,000 crowns, with which they built a church. Their dress was a black cloak and cassock with white sleeves; and the principal peculiarity of their institution was that they affected to subsist not only upon alms, but upon alms bestowed upon them without being asked for. They procured however considerable support in this way, and they were at one time enabled to maintain missions in Georgia, Circassia, Mingrelia, and other parts of Asia. Their history has been written by John Baptist Tuffins, under the title of 'Annales Theatinorum.' There were also Theatin nuns (in French, *Theatines*), so called from having been placed by Pope Gregory XV. under the direction of the Theatin monks, their original and proper designation having been Sisters of the Immaculate Conception. They were divided into two classes: the one called Theatin nuns of the congregation, founded at Naples by Ursula Benincasa in 1583; the other, of later institution, called Theatin Nuns of the Hermitage. The latter were bound by vows of peculiar solemnity and strictness, professing to spend their whole time in solitude and prayer. The two societies however were intimately connected; their houses adjoined and communicated with one another, and the temporal concerns of those of the Hermitage were managed by those of the Congregation. In 1624 Urban VIII. withdrew these nuns from the jurisdiction or superintendence of the Theatin monks, and placed them under that of the Neapolitan nuncio; but the former state of things was restored by Gregory IX. in 1608. A notice of a controversy between the Theatins and the Jesuits, which was kept up for a great part of the seventeenth century, is given by Bayle, in a note to his article on 'Ignatius Loyola.'

THEATRE (from the Latin *theatrum*, which is from the Greek *θεάτρον*, 'a place for seeing'), a word adopted in all modern languages to signify a building appropriated to dramatic representations. The oldest edifices of this class are those of the Greeks and Romans, for it was with them that the European drama originated, and, in point of magnitude, they surpassed the most spacious of their temples. The enormous extent of many of them, and the prodigious solidity of their construction, are attested by the numerous remains of such edifices, which have been explored not only in Greece and Italy, but also in Asia Minor. Of some of them indeed little can now be traced, but others are sufficiently perfect to convey a clear idea of the arrangement and general appearance of the structure in its original state; that is, however, merely as regards the space appropriated to the spectators, for scarcely anything remains to explain what is most difficult, and, as regards the dramatic exhibitions, most important of all to understand, namely, the stage itself, including under that term the whole space requisite for the accommodation of the performers, and for the preparation of the exhibition before the audience. Owing to the want of any evidence of the kind afforded by the buildings themselves, and to the very little that can now be gathered from the scanty notices of ancient writers, we are ignorant of many things which can only be conjectured.

The very circumstances that are mentioned for our admiration, and in proof of the magnificence and sumptuousness of some of the ancient theatres, also prove how destitute of anything approaching to scenic illusion and stage effect the performances must have been. Whether it be at all exaggerated or not, it is evident from what Pliny (*Nat. Hist.*, xxxvi., c. 15) says of the theatre of Scaurus at Rome, that the *scena* was a mere architectural façade, unmeaning in itself, though lavishly embellished with marble columns and statues, with no fewer than 360 of the former, arranged in three tiers, and 3000 of the latter, a most incredible number, surpassing that of a modern audience; for it

is difficult to conceive how they could all have possibly been introduced. Pliny puzzles us still more when he says the middle of the *scena* meaning the second of the orders; was of glass. Without stopping to inquire what was meant by 'glass,' perhaps mosaic, we may remark, that a background to the stage could have been no better an extravagant absurdity, and that the actors appeared mere pigmies upon a stage of such enormous extent, with a number of statues behind them. This always have been in some degree the case, since moderate-sized ancient theatres the stage was everywhere in comparison with what it is in the very largest modern theatres. The *scena* too was always a permanent architectural erection, incapable of change, and having reference to the particular performance. It frequently have been at variance with it. It is proposed that, besides the permanent *scena*, the stage be employed, occasionally at least, moveable painted canvases capable of being let down before it. Yet while we can only vaguely infer, the presumption against such a plan is founded both on its impracticability and its improbability. How is it possible to have had a stage of 200 feet in width, especially where the *scena* itself was so shallow and confined at its sides, and to have had space for apparatus or machinery over it? If we had any such scenery, it would have given rise to a mode of painting of which the ancients appear to have been nearly altogether ignorant. They seem to have had no idea of other than figure-painting, with scenery at expressing background, whereas scene-painting excludes figures, consists entirely of background, landscape or architecture, and sky, and requires more a moderate proficiency in linear and aerial perspective in regard to both of which the ancients appear to have been deficient. If we may judge from those ancient paintings which have come down to us, they were scarcely to have aimed at general pictorial effect, more than representing figures alone, without any background to them. If, then, there had been anything resembling our modern scenery, more explicit mention probably have been made of it, if only on account of the enormous magnitude of such paintings, whose surfaces must sometimes have contained a much greater number of square feet than the sides of the largest temples. Vitruvius does indeed make mention, in the proem to his seventh book, of Agatharchus as a scene-painter, and of Democritus and Anaxagoras as writers on scenography and perspective; but it is with his usual dryness and obscurity, and with such vagueness of expression, that it is impossible to draw any conclusion from his words. Of the latter he merely says 'scenam fecit,' which probably means more than that he was one of the first who introduced a mode of decoration on the *scena*, or back wall of the stage, if there was at any time painting at all, it could only have been very partial, and as accessory embellishment to the general façade,—perhaps in such pieces as the 'Fetes' something was done to give to the centre door of the *scena* the appearance of an entrance to a cavity just sufficient to indicate the locality intended to be expressed. The fixed arrangement of the *scena* itself, with three distinct entrances assigned to the performers according to their rank in the piece, the centre one being for the principal characters, the others for those supposed to arrive on one side from the port, on the other from the country, was not only a puerile and awkward conventionalism in itself, but an expedient which shows how imperfect the ancient stage must have been, how destitute of all contrivance, notwithstanding its alleged magnificence. What there was of painted scenery at all must have been confined entirely to two *Versurae* (*επιπέδον*) at the sides or ends of the stage, which served as 'wings,' and which were upright triangular frames made to revolve upon a central pivot, so that any of the three sides could be turned towards the audience; a very scanty change of scenery at the best, and exceedingly limited in effect, it being no more than sufficient to *hint* where the action was supposed to take place; whereas the *scena* itself bore no more resemblance to the intended locality of the piece, than do the proscenium and stage-doors in those modern playhouses where the latter are sometimes made use of by the performers.

From the use of the term *Aulea* it has been generally

included that the whole stage was concealed by a curtain both previous to the commencement of the performance and whenever it was requisite to make any change in decorations. But we agree with Winckelmann, that could not possibly have been the case, because in the first it could hardly have been practicable, and in the second it was quite unnecessary as regarded the permanent scena or architectural façade. Whatever changes, however, were made at all could have been only in the scenes or *versurae*, and it was merely before them that the curtains or *aulæ* were drawn at such times; which Winckelmann says nothing in favour of what little stage scenery there was. The notion of there being painted scenes like ours, capable of being let down or rolled up at pleasure, is completely contradicted not only by the fact, but by every circumstance that can be mentioned. It is the possibility of having scenes of such prodigious size, how are we to reconcile with the use of them such a vast decoration upon the scena, or wall behind of the stage, behind them?—to what purpose were there been the entrances through that wall, for the actors to come upon the stage, if there had been a painted scene before it? The stage itself again is so exceedingly shallow, that it would hardly have been further contracted in depth, by other scenes let down before the permanent one; nor would there have been space for them and the *versurae* also. There must have been more explicit mention made of such a thing, and there would have been some particular term to distinguish them from what is now called the *scena*, if they had been used. What Vitruvius says upon the subject of stage decoration is not only very brief, but exceedingly obscure, and only his carelessness in omitting to describe even mention much that is of real importance, while he goes altogether out of his way to tell us in a chapter De Harmonica, and to speak of many matters that have no connection whatever with theatres as a distinct class of buildings.

Even admitting that there was painted scenery, and that it was not at all inferior to that of our modern theatres either in regard to truth of perspective or anything else, it still must have been very far short of the latter in effect, for the reason that the performances were given by daylight. At the best the illumination must have been but exceedingly imperfect—a strange mixture of the artificial with the real; and even what degree of effect there might have been, must have been more or less counteracted by the sun shining on some part of the stage and scene, while shadows would be thrown upon them, in others, by the sun at either end or side. Or if the stage itself was at any time roofed in, all the upper part of the scene must have been thrown into shadow. The natural lights and shadows and the painted ones must frequently have been in strange contradiction to each other; nor was it possible to manage any effects of light, as in our theatres, by either increasing or diminishing it, or by concentrating it on any particular part of the scenery. The only thing of our of the antient stage in this respect, is that there were no 'foot-lights,' and consequently the faces of the performers were not lighted from beneath. Yet even this comparatively unimportant advantage was nullified by the use of masks, some of them so extravagantly grotesque as to bear scarcely any resemblance to the human countenance. The most natural masks were in some degree discoloured, and a fixed expression of countenance was substituted for what could properly be only a momentary one. Hence one great excellence in acting was entirely suppressed: the face was as rigidly inanimate as in wax-work. It is true this was of no very great consequence, because, owing to the vast extent of the theatres, the faces of the actors could hardly have been distinctly seen, or seen at all by the great majority of the spectators, more especially such aids to vision as opera-glasses were then unknown. The whole space was so great, that in regard to it the actors could have been no more than as the figures put by a painter into a landscape. Neither does what is said of their *cothurni*, or thick-soled buskins, being intended to make the actors appear taller, give us any very high

idea of the effect so produced; for while the increase of stature could have been scarcely perceptible—or if it had, it would have caused the limbs to appear strangely disproportioned—the means employed for it were ill calculated to give ease and gracefulness to the performer's movements.

On considering the audience part, and the accommodation provided for the spectators, although there the arrangement of an antient theatre was nearly perfect, and in some respects preferable to that of modern ones, it was not free from many inconveniences. The most obvious one is, that as there was no roof, there was no shelter from the weather, on which account awnings were sometimes made use of to screen from the heat of the sun, while in case of sudden and heavy rain the spectators were obliged to take shelter in the corridors behind and beneath the seats, where there were any, and in the porticos at the back of the theatre. Besides interruption to the performance, this must have occasioned considerable confusion in so numerous an assemblage of persons. Beautiful too as the arrangement of all the seats in concentric rows is in itself, it is attended with some disadvantage, as will be perceived on referring to the annexed plans, for instead of being placed, as in the pit of a modern theatre, parallel to and immediately facing the stage, a considerable portion of the audience must have sat sideways to it, with part of it behind them; and those at the ends of the further or upper benches could hardly have had any view of the *scena* at all, at least not in the Greek theatre.

The Greek and Roman theatres so very nearly resemble

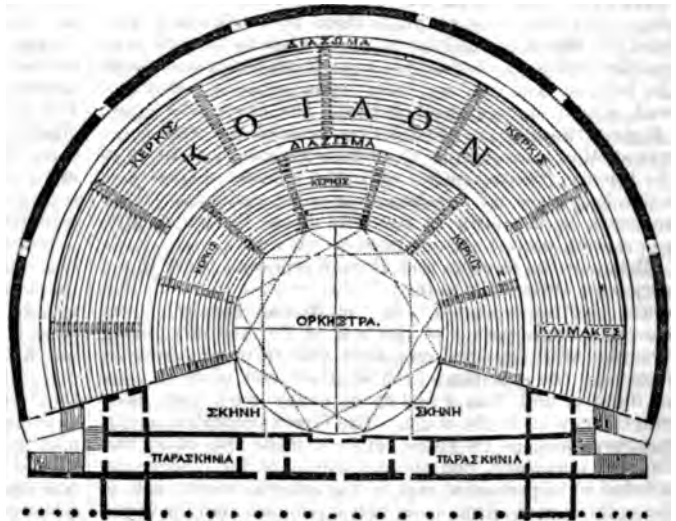

Greek Theatre.

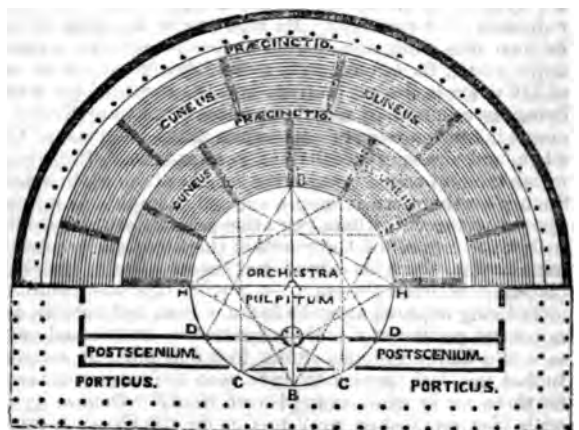

Roman Theatre.

each other in their general form and principal parts, that it is only by comparing the plans, for the purpose of seeing wherein they vary, that the difference between them can be clearly understood. Such difference however is ex-

ceedingly slight, the general arrangement and the essential parts being the same in both,—the *Coelum* (Κοῖλον), *Orchestra* (Ὀρχήστρα), and *Scena* (Σκηνή) in the one, and the *Cavea*, *Orchestra*, and *Scena* in the other. The *cavea* was the general term for the whole of the space appropriated to the seats of the spectators, which were all concentric with the orchestra, and which were intersected, in one direction, by ascents or flights of steps (κλίμακες) dividing the seats into so many compartments, termed *κερκίδες*, or *Cunei*, and separated into two or more 'flights' or 'tiers' by broader spaces or landing-places, called *Διαζώματα*, or *Præcinctiones*. The number of the κλίμακες, or ascents, and that of the Διαζώματα, or Præcinctions, and also the breadth of the latter, appear to have been regulated entirely according to the extent of the theatre and other circumstances. In general there seems to have been only one Præcinction between the seats, dividing them into two 'flights,' not however so as to give an equal number of rows of seats to each. In the theatre near Epidaurus, for instance, there were 54 rows of seats, divided by a single Præcinction, and 34 of them formed the *first* or lowest tier nearest the orchestra; while in that at Syracuse there were 62 rows, with only a single Præcinction between them, and 41 were given to the *second* or upper flight, furthest from the orchestra. In the theatre at Dramyessus, again, there were two Præcinctions, dividing the entire number of rows, 54, into 18, 16, and 20 respectively, reckoning from the orchestra. As regards the distinct 'flights,' or series of seats, there were two modes of disposing them: the more usual one was to break into separate slopes, retiring from each other, like the 'flights' in an ascent of steps; the other was to place them in a continued slope from the lowest to the highest seats, whereby at each præcinction the next 'flight' was considerably elevated above the level of that landing, being raised upon a podium or wall, which showed itself between the lower and upper 'flight.' Besides the præcinctions between the seats, there was another surrounding the whole *coelum*, or auditory of the theatre, forming either an upper uncovered terrace as a standing-place for spectators, or a covered gallery with columns, as is shown in the plan of the Roman theatre, where such portico was assigned to females.

Between the Grecian and Roman orchestra there was a very wide difference as regards the purpose to which that space was appropriated. In the Roman theatre it was merely a continuation of the rest of the auditory, being occupied with seats and spectators, with no other difference than that the spectators were senators and other persons of dignity, and that benches or chairs must have been ranged parallel to the stage. The Greek orchestra, on the contrary, was, as its name imports, made use of for the dancers, musicians, and singers, whose performances constituted so important a part of the entertainment; and so far nothing could have been better planned than the Greek theatre, for the orchestra was visible from every part, whereas the *scena* could not have been distinctly seen, or hardly seen at all by those on the upper seats at either extremity of the *coelum*. By referring to the plans it will be seen that while the Roman orchestra does not exceed half a circle, the Greek forms three-fifths of one, or an arc of 216 degrees, its proportions and the depth of the stage being ascertained by merely inscribing a square within a circle, taking one side of that square as the boundary of the stage, and drawing parallel to it a tangent to the circle, which tangent coincides with the *scena* or back of the stage. Such plan therefore is simple enough, complex as it may appear in the cut, where two other squares are also drawn within the circle, and the points of the three squares determine how far the seats extend, and the situation of the steps (κλίμακες) between the seats,—a fanciful operation, nothing more being required after the first one than to divide the arc or curved portion of the orchestra into as many equal parts as would be requisite according to the number of ascents. In fact this last appears to have been the mode practised, for there are as many examples which differ from as agree with that established by Vitruvius for the Greek theatre. According to that, the divisions, the number of cunei and steps between them, would be uniformly the same, viz. seven of the former, and eight of the latter, including those next the stage, as shown in the cut. This however is so far from being the case, that very material differences occur in that respect. At Epidaurus, for instance, there are ten cunei in the lower tier, and eleven ascents, consequently an

even number of the former and an odd one of the latter. At Dramyessus again there are nine cunei and ten ascents, and at Syracuse and Tauromenium the same. The *orchestra* and *scena* were also defined by a circle, which was inscribed an equilateral triangle, one of whose sides DD formed the *scena*, while the diameter HH of the circle, parallel to the *scena*, formed the boundary between the pulpitum or stage and the orchestra, being always a perfect semicircle. The other parts of the orchestra are merely for the purpose of determining the position of the *scenæ*, or steps between the cunei, are to be determined, nothing more is requisite than to divide the diameter of the orchestra into as many equal parts as there are cunei, whether the number be six or any other; the diameter of the orchestra HH being given, the position of the *scena* from it would be ascertained by making it to be one-fourth of that line. After all, as has been remarked by Wetter in his work on theatres, there is some advantage in such a whimsical than rational in such an arrangement. The advantage is, or what particular harmony of position is intended by the front of *scena* exactly coinciding with one of the sides of an equilateral triangle inscribed within a circle, only one-half is visible, while the triangle itself is not visible at all. These arbitrary architectural fancies were defects, and they show how imperfect the art of scenic presentation must have been. In addition to the defects already pointed out, as regards the want of variety in scenery, it was no slight inconvenience that the *scena* never be occasionally extended in depth, shallow as it was. Taking 70 feet as the diameter of the orchestra, which dimensions are equal to the whole of the stage in our modern theatres, the depth of the stage in a Roman theatre would be a little more than 10 feet, or one-fourth of that diameter; and in a Roman one 17½ feet, or one-fourth. While so confined a space would admit of very little dramatic action, it would scarcely admit of any change of scenery. Yet shallowness of the stage was some measure matter of necessity, that the *scena* might be as near to the front of the stage as possible, and separated as they were, in the Grecian theatre from the audience by the intervening orchestra.

Strict as were the rules for proportioning the stage to the size of the orchestra, the relation of the orchestra to the *coelum* or whole auditory appears to have been subject to any regulations, and considerably in different theatres, being in some one-half, in others only one-fifth, or even little more than one-sixth of the entire diameter of the interior of the theatres of Epidaurus and Dramyessus, or Janina.

When it is said that the Grecian orchestra was larger than the Roman, there is some ground in the expression, for it might be inferred from the above that the Grecian was larger than the other in proportion to the stage, whereas the meaning is that the orchestra of the Grecian formed a larger portion of a circle, extending 216 degrees, while the Roman was only 180 degrees, or a semicircle. In the Greek theatre, therefore, the stage cuts into the stage, and renders that part termed the *pulpitum* by the Greeks, and *Pulpitum* by the Romans, correspondingly narrower than the extremities, whereas in the Roman theatre the stage was of the same depth as the *pulpitum* being a mere technical distinction of that portion corresponding with the orchestra, and the actors confined themselves, in order that they might be better seen and heard by the whole of the audience than would otherwise have been the case. The above given are not drawn to any particular scale, supposing them to be upon the same scale, and the diameter of the orchestra in the Greek plan to be the diameter of the *coelum* or whole auditory 100 feet, the width of the stage and *scena* 19½, and the depth of the *logeion* only 15 feet, while in the other the dimensions will be, orchestra 100, auditory 270, *scena* 15½, stage and *pulpitum* 25.

Another point of difference between the Grecian and Roman theatre is, that in the former the stage was

* The ancients also were obliged to have recourse to what was an expedient for transmitting the actors' voice to the furthest part of the theatre, namely, that of placing in cavities for the purpose beneath the seats, metal or earthen vases, termed *Echeia* (ἤχη), that is, sounding vessels, which augmented the sound. Mr. W. Bankes discovered several of these kind in the theatre of Nebythopolis in Syria, but what effect such had on the metallic mouth-pieces of the masks worn by the actors really just is not possible now to judge.

bove the orchestra, 12 feet or upwards, was a wall of that height at the back of which was given the name of Hypodochia, or Lower Scena, and which formed a basal basement to the stage, and was decorated with columns and statues. This however is little known, for what is known relative to this part of the stage is derived not from any discovery in ancient structures of any kind, but solely from such mention of the terms as are to be found in a few ancient writers and explanations are all more or less obscure and uncertain. We shall not therefore attempt to give an account of either the Greek or Roman stage as they have already done. It seems to have been a simple structure, because the theatres themselves were not so lofty and solidly in their construction— they were columns, and marble, and stables, and habitations also must have been in the rear of those in the comparatively small theatres. Yet the truth is, that capacious theatres were, being intended to accommodate a large population of a city at each performance, were not at all in proportion to the rest. The space attached to it either behind or at the sides, by means of a double aisle and scenic contrivance and effect almost impossible: when therefore we see the remains of an ancient compilation of a city descended with the divinities of Olympus, we do not doubt the fact of there being something down performers from above—in the case of the theatre, the stage itself must have been at a great height, the question the ‘magnificence,’ and the contrivance must have been some effect almost ridiculous.

As lately been made (November, 1841) a new palace at Potsdam, towards a dramatic performance, with rigorous effect. The piece selected for the purpose was of Sophocles, and the theatre and all were made to conform as nearly as possible to the Grecian model, and it was here that the chorus remained until they descended the stage, when they ascended to it in silence, and descended again in the same manner as was all the ancient practice observed. A precedent was shown in comparatively small instances, instead of the curtain being let down, as was supposed to have been in ancient theatres, a circumstance which has been mentioned by us; and it is said that the part of the scene being disclosed before is little striking. Indeed, if we may believe the Berlin journals have reported of this, it perfectly realized its prototype, and surpassed it, if it were only because it took height, and the actors did not wear masks. It is to be said on the subject of ancient theatres, that the form of the orchestra was not of the exterior of the building; while therefore did not exceed a semicircle, but a greater curve. In the Greek theatres the orchestra was not always extended beyond a semicircle, but sometimes the curve being continued, but sometimes right angles to the chord (or parallel to the Roman theatre, whose general form was an external semicircle being prolonged by Grecian theatres were almost invariably on the side of a hill, so that, as regards the elevation, it was necessary to shape it out, and erect entirely there was no other architectural ornament formed by the Parascene (Παρασκήνη) behind the stage; for which reason the theatres did not manifest itself. The Roman theatres, on the contrary, were erected on level ground, and the curved part of the exterior was confined to a narrow space which unites better with the rectilinear straight lines.

The theatre of Athens (called that of Bacchus) was by no means as many others, its diameter being only one-third of the orchestra 72, which are very much in comparison with those of some of the

Asiatic theatres. The Odeion of Regilla, also at Athens, though similar in its general plan to the usual theatre, was a music-hall, and was covered in with a tent-like roof, with a semicircular eye or opening for light. Both structures were situated at no great distance from each other on the south side of the Acropolis [ATHENS, Plan]; therefore the scena of the theatre had a northern aspect, and must have been in shadow while the performances took place.

The following is a list of such ancient theatres as are known, together with the respective dimensions of their general diameter and of their orchestra; which we have for the most part taken upon the authority of a similar table given by Col. Leake, in his ‘Tour in Asia Minor,’ to which several other examples are here added.

	Diam.	Orchestra.
Anemurium	197 feet.	
Aspendus	400	25 rows of seats.
(scena Ionic and Corinth.)		
Athens, Theatre of Bacchus	250	72 ft.
„ Odeion	90	36
Cnidus	400	
Delos	175	
Dramyassus, or Joannina	440	78
Ephesus	660	240
Epidaurus	370	55
Herculaneum	180	16 rows of seats.
Hierapolis	346	100
Laodicea, Great Theatre	364	136
Limyra	195	not known
Mantineia	227	not known
Miletus	474	224
Myra	360	120
Nicopolis (in Epirus)	360	120
Orange (scena only remaining, 336 ft. wide, 114 ft. high.)		
Patara	285	96
Perga		25 rows of seats.
Phellus	400	Scena 150.
Pola, about	200	68
(destroyed 1636, but plan preserved by Scamozzi)		
Pompeii	190	62
Pompeiiopolis	219	138
Rome, theatre Marcellus	517	172
Sardes	396	162
Selinus (in Cilicia)	114	
Sicyon	313	100
Side	390	120
Sparta	453	217
Stratonicea	390	108
Syracuse	440	
Tauromenium	330	width of scena 132
Teos	285	70
Tralles	540	150

Of some of these theatres scarcely anything remains, little more than their general shape and extent being now distinguishable; accordingly the statements of their dimensions are not to be strictly relied upon, though they are sufficient to enable us to estimate their comparative size.

Fortunately the ancient theatre was not taken as a model for modern structures of the kind. The revival of theatrical representations took place before anything was known relative to that branch of architectural archæology, and under very different circumstances. Dramatic entertainments were then either partly religious, and performed within churches, convents, and colleges; or were acted for the amusement of princes and nobles on occasions of state and festivity, in halls merely temporarily fitted up for that purpose; consequently spacious and permanent structures, as public theatres, were not required until long afterwards, when the drama had become a distinct profession. In the meanwhile a taste for scenic display had developed itself, which required a very different arrangement of the stage and its apparatus from that of the ancients. Imperfect as they were in many respects, the dramatic pageants and recitations performed before Leo X. were ‘got up’ with great magnificence, and some of the greatest artists were employed upon the decorations; among others Baldassare Peruzzi [PERUZZI], whose skill in architecture and perspective carried scene-painting almost to perfection at once. Even in the preceding century dramatic exhibitions had been produced at Florence in a style then unprecedented; and we are told that the first Italian theatre

was one erected in that city by Bernardo Buontalenti in 1581; but it does not appear to have been a public theatre, nor could it have been very spacious, as it now forms merely a saloon in the building called the Uffizi. Theatres on the present system were not built until the early part of the seventeenth century: just before which time an attempt had been made to restore the form of the antient theatre and stage, with the permanent architectural scena and its entrances, by Palladio, whose celebrated Teatro Olimpico at Vicenza is one of those things which have gained a traditional reputation far beyond their real merits. Admired at first, because then superior to anything of the kind, it has continued to be admired since, partly on account of the character attached to it, which few care to dispute; and partly perhaps on account of its singularity, and because it shows the peculiarities of the antient theatre. By no means however is it a very accurate imitation, though its chief merit lies in being a mere imitation; it is semi-elliptical instead of semicircular, with the stage on the longer axis of the ellipse; wherefore it looks too much squeezed up one way, and stretched out the other, and produces the same kind of disagreeable effect as would arise from placing the stage on the longer side of a parallelogram of the same extent (96 x 45 feet). It is said that the space to which the architect was restricted compelled him to adopt that form, yet it hardly appears so from the published plans of the building, for it would not be difficult to show how a semicircle might have been brought in. With regard to the scena, for which unlimited admiration is claimed, nothing can be more tasteless: it abounds in almost as many architectural barbarisms and solecisms as could well be brought together. Even Robert Adam spoke of it as mere 'gingerbread'; and another architect, Woods, says, 'The scena, which is the part most admired, borders upon trumpery'; and that although the building is too celebrated to be omitted, for him it might have slept in oblivion.' It is not however so much the scena or *facciata* itself, as the avenues seen beyond it through the centre arch and other openings which attract notice, and have been extolled by some as greatly superior to the 'flimsy' painted decorations upon canvas used in modern theatres. Those avenues represent as many streets, the fronts of the buildings being modelled or carved in relief, and attempted to be shown in perspective by the floor and ceiling sloping very much upwards and downwards, and the other horizontal lines accordingly, and by the passages themselves being narrower at the further end. The contrivance is puerile at the best; and instead of being more deceptive or natural than painted scenery, the imitative perspective becomes distorted when viewed from any other situation than the centre of the theatre and the level of the stage. It is also difficult to understand how these narrow enclosed passages could have been properly lighted at the time of a performance; and although they are, in stage language, 'practicable,' hardly could they have been made use of, at least not for their whole extent, because at their further end an actor would appear gigantic. This structure is nevertheless entitled to notice as an example of a very defective and faulty system, and because it has been frequently mentioned for the purpose of recommending, on the imposing authority of the name of Palladio, what ought not to be imitated.

We are not aware of more than one other attempt to revive the antient theatre in all its strictness, which was that built in 1588 at Sabbionetta, for the Duke Vespasiano Gonzaga, by Scamozzi, who completed the Teatro Olimpico after Palladio's death. Temanza, who gives a description of the structure, speaks of it as then no longer remaining; but Tiraboschi points this out as a mistake, saying that the building still existed, though very much out of repair. How far the theatre at Sabbionetta differed from that at Vicenza in size, Temanza has not stated; but it was superior to the latter in its plan, the spectator being semicircular, and the orchestra somewhat more. There was likewise, as at Vicenza, a Corinthian loggia or colonnade around the upper part above the seats, but in much better taste, all the intercolumns, except one at each end containing a niche, being open; whereas in the other building the centre intercolumns are closed. Yet whatever improvement Scamozzi may have made upon his predecessor's work in these respects, he attempted none where it was most of all wanted, but copied the permanent scena, with its avenues of mock perspective in relief. We do not say

that the antient theatre offers nothing for imitation capable of being applied to modern ones. On the contrary, the general form of the spectator is the elegant and commodious that can be devised: the stage, lay in adopting, together with that, the antient stage, than which nothing can be more ill-confective, and inconvenient. In fact the antient theatre plies no stage at all in comparison with what is required for one, but merely a proscenium; and such a scene, with merely a stationary architectural 'drop' [PAINTING], would answer every purpose of dramatic presentation, just as well as the Logeion of the Pulpitum of the Romans, and Palladio's architectural background, which will not even in the slightest comparison with the drop-scene at Covent Garden. For the plan of a complete theatre, the modern system of its extensive and complex scenery and mechanical contrivances, be combined with the form and arrangement of the antient theatre, though not without very considerable modification. This was done by Quarenghi in the theatre at the Hermitage at St. Petersburg; in another theatre in Prince Besborodko's palace, and in a public theatre intended to be erected at Bassano. In all such plan and disposition of the seats are by no means well adapted for a modern public theatre and audience: unless many inconveniences were to be incurred, to great loss of space, or what would be a great expense would be incurred, and the number of spectators much less in proportion to the width of the 'house' stage. On the other hand, the form of the antient theatre may be applied to a concert-room with such a modification, that it is rather surprising it should not have been taken as a model for public rooms of the kind, for a permanent scena, either of painted or real architecture behind the orchestra and singers, would be a great advantage not intended to have any immediate effect upon the performance itself.

In claiming a decided superiority for the modern over that of the antients, we speak only as regards the respective systems; and as Ugoni, in his *Life of Michelangelo*, to prefer the Grecian theatre, with all its imperfections, and the awkward expedients resorted to in it, to the more classical and dignified character than the modern theatre, relatively small and fragile yet greatly improved, the kind, is to wish to limit art and science to their first bounds. There certainly was good reason at that time for exclaiming against modern theatrical architecture as very defective in regard to the audience part of the 'house.' Till within a comparatively late period, any study was bestowed on beauty and convenience of plan. The accommodations were hardly so good in many very ordinary playhouses, where for want of space, there are no other seats than what directly face the stage. The 'house' was usually an oblong, either rectangular or elliptical, so that the greater part of the audience,—at least those in the boxes,—were placed on the sides. Where the 'house' contracted towards the proscenium, as was frequently the case, the side-aisles actually turned from the stage; and whether the case or not, they were allowed to encroach upon the stage itself in such manner, that when the actors came to the front of the stage or beyond the line of the boxes they may be said to have mingled with the audience those in the boxes on the *avant-scene* were actually behind them. If we may judge from the plans and drawings of them, the two principal theatres in London were, even less than a century ago, both as inconvenient and as ugly as can well be imagined. The apparatus, used formerly to be exceedingly bad; not only narrow and inconvenient, but in many places most dangerously narrow. Such is strikingly the case in most of the modern Roman theatres, for instead of the box-curve following the curve of the 'house,' and being of equal width throughout, they are so contracted where the width is widest, that more than two persons cannot pass.

Very great reforms have now taken place, yet there is still room for further improvements, obvious, though likely to be adopted so long as it is considered necessary, of course that the space before the curtain must be so arranged as to contain as many persons as can possibly be packed in, and that an audience must be piled up around the whole house to the very ceiling. We do not say that modern theatres are too lofty; the error does not lie

n carrying up the boxes, tier after tier, to such a monstrous height that the uppermost box is several feet above the top of the curtain or stage-openings, and the seats of the upper-gallery are actually on a level with the ceiling over the pit. Such accumulation of successive stories gives a crowded appearance to the whole, and leaves no space for architectural decoration around any part. No doubt a very striking appearance of a different kind presents itself from the pit and from the side when the house is entirely filled to the very top; if we consider merely the coup-d'œil from such points, they may be allowed to be imposing. But then, as regards the view of the audience who occupy the upper part of the house, the arrangement is bad. From the seats which are placed above the level of the top of the curtain, there is only a bird's-eye view of the stage and the scenery, and only from the front seats, and also facing the stage, can those on the side of it be able to obtain at all that they ought to have; when they come forward towards the foot-lights, they should be no seats at a greater height than midway of the curtain, or the level of what is now the second tier of boxes in our large theatres; for, as the scenery is painted only to one horizon,—generally that of the ceiling itself,—its perspective effect is more or less impaired when it is seen from either very much above or below that level.

No less preposterous is the practice of continuing the side-boxes up to the proscenium, and sometimes (as in the Opera-house at London) quite up to the very curtain, so that there is no proscenium at all, unless the floor of the stage, between the curtain and the foot-lights can be so called. While those so seated lose the scenery altogether, they have the disadvantage of being between the wings on the side opposite them; and though the positive inconvenience resulting from such an arrangement is felt only by a portion of the audience, the effect occasioned by it extends to the whole theatre. It ought therefore to be a distinct proscenium, serving as an architectural frame to the stage and its scenery, and being that part of the theatre from the rest, but it ought to be of much ampler proportions than are now given it.

It should extend so far as to leave some interval—a sort of neutral ground—between the curtain and the boxes, so as to remove the nearest spectator in them to a tolerable distance for properly viewing the stage as a picture; for it is possible to be as inconveniently near the stage as it is from it. Where, in order to contract the stage, and to render the pit and general diameter of the house considerably greater than what is required for the width of the curtain, the plan is made to approach a circle (as is the case in nearly every theatre built within the last fifty years), the boxes should be confined to the semi-circular space on each side between them and the curtain, and should be made to contribute very much to the architectural appearance of the whole house. This would not diminish anything from the pit, and if it materially diminished the number of the boxes and seats in them, it would be only where there ought to be nothing of the kind.

The banishing of boxes from such situations, and the abridging also no more than two tiers, would certainly abridge the present capacities of theatres: a theatre of the same size would not contain the same number of persons as at present, when a large part of the audience are put where they cannot well see the performance.

It is likely, therefore, to be objected that such a plan would be too expensive, since a large house would be requisite for a comparatively moderate audience; but alterations might very well be made elsewhere, for at present the whole building is frequently very much larger and more costly than actual necessity requires, the 'house' being its dimensions what they may, taking up a comparatively small area of the entire plan, while the rest is occupied by stately approaches and saloons, which, where they are rendered it expedient, might be greatly abridged, much plainer in style, and some of them omitted altogether as superfluous appendages.

Some of the modern continental theatres, the pomp displayed in such accessory parts of the building far exceeds anything of the kind in this country. In that at Berlin, besides several other spacious apartments, is a music-saloon set high, 44 wide, and 106 feet in length in its upper part, where there is a screen of six Ionic columns at each

end; the whole highly decorated, and forming one of Schinkel's richest pieces of interior architecture. The theatre at Munich has two staircases to the boxes, with flights of marble steps 13 feet wide; and besides two saloons for the public (each 82 x 31 feet), there is a very magnificent one communicating with the royal box—not a mere ante-room, but what would be termed a noble room even in a palace, its dimensions being 46 x 44 feet, and 25 in height. In both these theatres, and in that of Genoa, the royal or state box is itself a room of some size, about 15 by 16 feet, more or less; and according to the general custom of the continental theatres, this box (which occupies the height of two tiers, and is adorned with caryatides in front) is directly in the centre of the house, facing the stage, consequently in the very best situation of all; whereas the situation assigned to royal visitors in our theatres is almost the very worst, as far as seeing the stage and the performance is concerned.

In regard to the form of the 'house,' a decided improvement has taken place of late years; and the circular plan, or one approaching to it (either extended by the curtain being a tangent to the circle or somewhat beyond it, or reduced by the curtain intersecting and forming a chord to the segment), may now be considered the one established as being the most pleasing and commodious—that which is best adapted for affording a distinct view of the stage to the majority of the audience. But there is considerable difference of opinion as to its being the best form in regard to hearing. In fact, the science of acoustics is not yet brought to exactness as regards practical purposes in building: it is easy enough to ascertain beforehand how much of the stage will be visible from different parts of the theatre, but not so what will be the result as to sound, since that will depend upon a variety of circumstances, some of them counteracting each other, and not every one of them to be guarded against or foreseen. The shape of the house is but one of them out of many: much will also depend upon size, much upon the depth of the boxes and galleries, and also upon accidental and such trivial matters, that any defect or advantage so occasioned is not likely to be traced to them. Here the chief guide is experience; and experience seems at present to be in favour of, at least not at all against, the circular form; for the new theatres at Mayence, Dresden, and other places where it has been adopted, are said to be perfectly satisfactory in regard to the actors being distinctly heard in every part.

While in their internal embellishment and fitting up theatres afford very great scope to the architect, though not so much as they might do, they also afford opportunity for accomplishing much in regard to characteristic external design. Magnificent as are the exteriors and façades of the theatres at St. Petersburg, Berlin, Munich, Bordeaux, and Nantes, with their porticos and colonnades, there is nothing in them that very clearly expresses their particular purpose, because nothing that corresponds with or indicates the form of the 'house' itself within. Moller, we believe, was the first who made the internal plan discover itself from without, by making the auditory, at least the corridors and saloon surrounding it, project out as a spacious semi-circle, in the façade of the theatre at Mayence. The same form of exterior has been given by Semper to the new theatre at Dresden, which is also remarkable for the display it makes of sculpture.

After all it is the stage itself, with its multifarious contrivances and complex mechanism, its scenery and pictorial effects, which manifest the extraordinary perfection to which the moderns have carried the scenic, if not the dramatic art; nor can we exclude the latter, unless we choose to blot out the name of Shakspeare. It does not enter into our purpose however to speak of stage mechanism, which is a subject and study by itself, and not otherwise connected with theatres and their architecture than as being made use of in the former. Those who seek for information of the kind will meet with many plates showing the stage construction and mechanism of Plymouth theatre, in Foulstone's 'Public and Private Buildings;' and, with more general and complete instructions, in Stephenson's work on the machinery of theatres. Neither can we make any additions here to what has been already said on the subject of SCENE-PAINTING. We will only observe that very great improvements and numerous contrivances for producing stage and scenic effects had been introduced into theatres at the commencement of the seventeenth century.

Table of Modern Theatres.

ITALY.

	Architect.	Date.	Width of Curtain.	From Curtain to Back of Pit.	Greatest Breadth of Pit.	Height from Floor of Pit.	Stag.	
Bologna	Ant. G. Bibbiena		49 ft.	77 ft.	59 ft.	62 ft.		
Genoa	Carlo Barabino	1826-8	46	88½	64	59	82 ft. deep 69 ft. wide	Entire building 314 by 1 Hexastyle, Doric portico of boxes, royal box, ova two tiers in height, with 21 by 13½ feet, and 16 46½ feet, and 39 ft.
Imola	Cos. Morelli	About 1780	22	68	42	38	24 deep 68 wide	Remarkable for similitude ment of proscenium with separate openings.
Milan, La Scala	Gius. Piermarini	About 1775	44	90	67	75		Six tiers of boxes. Saloon 24 feet.
Naples, San Carlo	Gior. Metrano; restored, &c. Ant. Niccolini	1735 1817	50	83	73	80	88 deep 110 wide	Burnt 1816, rebuilt 1817. of boxes, in all 181. 2800.
Parma, Great Theatre	Giam. Aleotti, Bernini	1619	36	148	50	85		On the first floor of the Palace. Not used since 18
Parma, New Theatre	Canonica and Nic. Bettolli	1822-3	30	75 to back of boxes				
Rome, T. Aliberti	Ferd. G. Bibbiena		39	66	52		46 by 72	Shape very corridors
Rome, La Argentina	Marq. Teodoli		39½	66	54	43	54 deep 79 wide	No other proscenium rated pilaster facade and curtain. Six Pit floor quite level
Rome, Teat. della Valle		Restd. 1766	30	47	40		13 deep	No proscenium, the quite up to curtain. usually small and capable of being e: more in depth.
Rome, T. Tordinona	C. Fontana, but since altered		43	51	56		75 deep 72 wide	Six tiers of boxes.
Turin, Opera-House	Ct. Bened. Alfieri	1740	40	78	53	53	105 deep 78 wide	
Venice, La Fenice	Ant. Selva	About 1790	42	76 to back of boxes	62	49	46 deep 91 wide	Burnt down 1835, t Five tiers of boxes.
Vicenza, T. Olimpico	Palladio	About 1580	78 width of scene	56	115 greatest width of salle	49	22 depth of stage before scene.	

FRANCE.

Paris, L'Odéon	Baraguey, restored	1820	42½	62		51	66 deep	An insulated x 118 De Wailly
Paris, Français	Louis, partly rebuilt by Fontaine	1780	39	59		54		
Paris, Académie Roy. de Musique, or Opera	Debret	1822 Opend. Augt. 1821	52½	67		61	95 deep	Saloon 98 by 21, and 21 feet
Paris, Ventadour	Huvé		49	57		64		re. 172 by 114
Paris, Feydeau	Legrand and Molinos	About 1790	48	48			32 deep 78 wide	Front
Versailles, in Palace			34	60	50	44	70 deep 48 wide	

	Architect	Date.	Width of Curtain.	From Curtain to Back of Pit.	Greatest Breadth of Pit.	Height from Floor of Pit.	Stage.	
. . .	Louis	Fin. 1780	39½ ft.	64 ft. includ. boxes	62½ ft. ditto	57½ ft.	70 ft. deep	This splendid theatre restored and refitted up by Bonfin, 1832.
. . .	Ledoux	About 1777	49	64		52	36 deep 65 wide	Insulated, about 124 × 100 feet.
. . .	Soufflot	1754-6	32	63 to back of boxes	36	35½	68 deep 50 wide	Insulated building, 180 × 130 feet. This theatre has been rebuilt after a different design.
. . .	Crucy	About 1810	37½	62	49	51	47 × 65	Portico, Corinthian octastyle before tetrastyle in antis.

GERMANY AND BELGIUM.

era-house	Von Knobelsdorff	1740-3	29	64	42	58	50 deep 52 wide	An insulated building, 214 × 78 feet. Principal front, Corinth. portico, hexastyle monoprostyle, on low basement.
t Theatre	Schinkel	1816	43	62		44	66 deep 86 wide	A magnificent structure, with Grecian Ionic hexastyle portico on a lofty flight of steps.
. . .	Semper	1837-1841						
. . .	Schinkel	1828-7	40	69 to back of boxes	50	56	60 deep 80 wide	Plan of auditory nearly circular, i.e., a circle of 66 feet diameter, to which the curtain is a tangent. Four tiers of boxes, and amphitheatre formed by a colonnade of 22 pillars.
. . .	Ant. G. Bibbiena		30	46			71 deep	
. . .	Moller	Fin. 1833	54	74		60	56 deep 80 wide	Insulated, about 250 × 140 feet, with semicircular projection, 140 feet diameter on one of longer sides or facade.
. . .	K. von Fischer	Open. 1818	39	78	62	64	91 deep 94 wide	Burnt Jan. 14, 1823; restored 1824-25. Octastyle Corinth. portico, including boxes, the auditory, a circle 72 feet diameter, between which and curtain is a space of 9 feet. Five tiers of boxes.
tel, in the	Ottmer	1836-7	28	44 includ. boxes	29	27	36 deep 56 wide	Private theatre, fitted up in Gothic style, but detail in poor taste.
. . .	Roelandt	1837-9	37	59	42		60 deep 78 wide	Facade 300 feet. Oval saloon 91 × 59, making, with smaller saloon and concert-room, an extent of 270 feet.

RUSSIA.

urg, Great	Tischbein;Thomond	1782-3 1803	52	60	50	52	95 deep 70 wide	Insulated building, 150 × 270 feet, with octastyle Ionic portico. Saloon 125 × 30 feet.
theatre of stage	Quarenghi	1780	36	60	60	42	70 deep 70 wide	Theatre a semicircle, without boxes, but surrounded by a Corinthian colonnade of 13 intercolumns, with seats.

ENGLAND.

Opera-	Novosielsky	1790	40	84	80	51	85 deep 80 wide	No proscenium. Corridors, &c. very mean.
t-garden	Sur R. Smirke	1809	32	66	51	54	55 deep 86 wide	The whole building about 209 × 160 feet. Saloon 56 × 19 feet.

	Architect.	Date.	Width of Curtain.	From Curtain to Back of Pit.	Greatest Breadth of Pit.	Height from Floor of Pit.	Stage.	
London, Drury-lane	Ben. Wyatt Beazley	1811-2 1822	32 ft.	64 ft.	56 ft.	60 ft.	48 ft. wide 80 deep	The whole 240 x 145 feet 90 x 26 feet.
„ English Opera	Beazley	1831-4	32	50½	39			The inner hall, with its screen of columns at a pleasing part of the
Birmingham . . .	Beazley		28	44	45			The 'house' or auditor, circle, 48 feet diameter; the boxes occupy ab- fourths. Pit 33 feet
Plymouth . . .	J. Forlstone	begun 1811	28	43	33	35 deep 60 wide		

Several theatres, all more or less worthy of notice, have been erected within the present century, but are omitted in the table, as we cannot specify the respective dimensions. The subjoined list of them, with their architects' names, may however be useful:—

Brescia; Canonica.

Ferrara; Ant. Foschini.

Florence, Teatro Goldoni; Gius. del Rosso, 1817.

„ Theatre after antient plan; Anton. Corazzi.

Mantua; Canonica.

Trento; Ducati, 1823.

Baden; Weinbrenner.

Breslau; Langhans, opened November, 1841.

Cannstadt; Ludw. Zanth, begun 1839.

Carlsruhe; Weinbrenner, 1807-8.

Coblentz; Von Krahe.

Darmstadt; Moller and Heger, 1818-19.

Gotha; Semper, 1837-9. Opened May, 1840.

Münich, Isar-thor Th.; Dericoyen, 1811.

St. Petersburg; Alexandrinsky Theatre; Rossi. Opened August, 1832.

THEATRE. Before the reign of Elizabeth theatrical representations appear to have been subject to no legal restraint beyond the liability of those who conducted them to the vagrant laws. Until the middle of the seventeenth century, players were always attached to the establishment either of the court or of some wealthy subject, whose badge and livery they wore, and whose superintendence was presumed to control any excesses which might be injurious to the public; but when their services were not required by those to whom they especially belonged, it was usual for such persons to wander about the country, exhibiting their performances for gain, and thus becoming strollers, and even mendicants. In the reign of Henry VII. an instance is recorded of a gratuity given by that king to some 'players that begged by the way.' The chief restrictions to which such persons were liable previously to the statute of Elizabeth in which they were expressly mentioned, were measures of police for preventing tumults and breaches of the peace by the assemblage of large numbers of people at their representations. Occasionally however these popular exhibitions attracted the animadversion of the government by holding up matters of state to public censure or ridicule. Thus in 1556, when the unpopular marriage of Queen Mary with Philip of Spain had created great excitement throughout the country, the council direct the attention of the lord president of the North to 'certain lewd persons naming themselves to be servants of Sir Francis Lake, and wearing his livery or badge on their sleeves, have wandered about these north parts, and representing certain plays and interludes reflecting on the queen and her consort and the formalities of the mass.' (Strype's *Ecclesiastical Memorials*, vol. iii., Appendix, p. 185.) Excesses of a similar character, occurring at the beginning of the following reign, and directed against the Protestant religion, were checked by the stat. 1 Eliz., c. 2, s. 9, which inflicted a penalty of 100 marks upon 'persons who in plays or interludes declared or spoke anything in derogation, depraving or despising of the Book of Common Prayer.'

But although players, as such, were in those days subject to no general legal restrictions, it is probable that the practice of granting licences from the crown to such persons prevailed as early as the reign of Henry VIII. It appears too, from a curious paper published by Malone, in his 'Historical Account of the English Stage,' that in the

reign of Elizabeth strolling players, though be some great person, usually applied for a licence local authorities of any town in which they form. 'When players of interludes come to Gloucester,' says this document, 'the manner like corporations, that they first attend the man him what nobleman's servants they are, licence for their public playing.' The licence from the crown now extant is Queen Elizabeth, in 1574, to James Burbage and persons, 'servants to the earl of Leicester,' which a proviso that the performances thereby authorised they are publicly represented, shall be seen and by the queen's master of the revels; a stipulation to the licence of the lord chamberlain under the Act at the present day. These licences from were originally nothing more than authorities to which exempted strolling players from being proceedings taken under the laws or procl vagrants, and also superseded the necessity of local magistrates. The statute 39 Eliz., c. 4, farther, and by implication authorised nobl players, by enacting that 'all common playe wandering abroad, other than players of in ing to any baron of this realm, or any ou personage of greater degree, to be auth under the hand and seal of arms of such sonage, should be adjudged rogues and vagab statute has been frequently misrepresented as all players as rogues and vagabonds (Prynne's *masix*: Howell's *State Trials*, vol. iii., p. 567); is obvious that the enactment applies only to players.

Although theatrical representations bec general in the reigns of James I. and Charles were expressly enacted for their regulation, with exception of the stat. 1 Car. I., c. 1, which sup performance of 'interludes and common plays Lord's Day. An ordinance of the Long Parli was directed to the suppression of all stage-terludes, but though occasionally enforced w rigour, it failed to abolish these entertainments. 12 Ann., stat. 2, c. 23, in general terms, classed interludes as rogues and vagabonds; but the stat II., c. 28, s. 1, expounded the former statute by that 'every person, who should for hire, gain, or act, represent, or perform any play or other ente of the stage, or any part therein, if he shall not legal settlement where the offence should be c without authority by patent from the King. the Lord Chamberlain, should be deemed a vagabond within the stat. 12 Ann.' But this p now repealed by the stat. 5 Geo. IV., c. 83, and p such, whether stationary or itinerant, are at the day not amenable to the law as rogues and vag By the 2nd section of the above statute, 10 Geo. I which, with the exceptions just mentioned, is full operation, and forms the law of the me tan theatres, it is enacted generally, that 'every who shall, without a patent or licence, act or entertainment of the stage for hire, gain, or re forfeit the sum of 50l.' By the 3rd section it is that 'no person shall for hire, gain, or re i form, or represent any new interlude, t opera, play, farce, or other entertainment w any parts therein; or any new act, scene, or

ny old interlude, tragedy, comedy, opera, play, other entertainment of the stage, or any new pro- plogue, unless a true copy thereof be sent to the Chamberlain of the King's household for the 3, fourteen days at the least before the acting, ng, or performing thereof, together with an ac- he play-house or place where the same shall be, time when the same is first intended to be first resented, or performed, signed by the master or

The 4th section authorizes the Lord Chamber- bishit the performance of any theatrical enter- and subjects the persons infringing this prohibi- a penalty of 50*l.* and the forfeiture of their patent .

The 5th section provides, that 'no person authorized by patent from the Crown or licence Lord Chamberlain to act, represent, or perform r reward any interlude, tragedy, comedy, opera, e, or other entertainment of the stage, in any eat Britain, except in the city of Westminster and e liberties thereof, and in such places where the l personally reside, and during such residence e 7th section enacts, that 'if any interlude, comedy, opera, play, farce, or other entertain- ne stage, or any act, scene, or part thereof, shall represented, or performed in any house or place ne, ale, beer, or other liquors shall be sold or he same shall be deemed to be acted, repre- d performed for gain, hire, and reward.' Within rs after the passing of this act of parliament, the ich restricted the power of granting patents by 1 to theatres within the city of Westminster and royal residence, was found to be productive of ence; and special acts of parliament were passed g several large towns, in which such entertain- e desired, from the operation of that clause, and ig the King to grant letters for establishing thea- h places. Instances of statutes of this kind occur ect to Bath in stat. 8 Geo. III., c. 10; with respect ool in the stat. 11 Geo. III., c. 16; and with Bristol in the stat. 18 Geo. III., c. 8.

er relaxation of the rule established by the stat. I., c. 28, for the regulation of theatrical perform- is effected by the statute 28 Geo. III., c. 30, in 'places which could not be expected to bear the of a special act of parliament. By this latter he justices of the peace at general or quarter re authorized to license the performance of any edies, comedies, interludes, operas, plays, or farces presented at the patent or licensed theatres in ter, or as have been submitted to the Lord Cham- t any place within their jurisdiction not within f London, Westminster, or Edinburgh, or 8 miles tent or licensed theatre, or 10 miles of the king's . or 14 miles of either of the universities of Ox- mbridge, or 2 miles of the outward limits of any ing peculiar jurisdiction.

nalties imposed by the stat. 10 Geo. II., c. 28, and in practice insufficient to prevent the per- of theatrical entertainments without licence, and s being experienced from the resort of the lower London to such entertainments, the legislature r 1839 gave additional powers to the metropoli- e for their prevention. By the 46th section of 2 and 3 Vict., c. 47, 'the Commissioners of police were to authorize a superintendent, with such s as he may think necessary, to enter into any oom, kept or used within the metropolitan police for stage-plays or dramatic entertainments into mission is obtained by payment of money, and ot a licenced theatre, and to take into custody ns who shall be found therein without lawful The same clause enacts that 'every person keep- g, or knowingly letting any house or other tene- the purpose of being used as an unlicenced hall be liable to a penalty of 20*l.*, or, in the dis- of the magistrate, may be committed to the House tion, with or without hard labour, for two calen- hs; and every person performing or being therein awful excuse shall be liable to a penalty of forty

be desirable in this article to refer to a statute s passed in the year 1833 for the protection of dra- ery property, and which placed such property

upon the same footing as the copyright of published books. The stat. 3 & 4 Will. IV., c. 15, enacts that the author of any tragedy, comedy, play, opera, farce, or any other dra- matic piece or entertainment, shall have as his own pro- perty the sole liberty of representing the same at any place of dramatic entertainment; and that the author of any such production, published within 10 years before the passing of the act, or his assignee, shall, from the time of publication until the end of twenty-eight years, and, if the author be living at the end of that period, during the residue of his natural life, have as his own property the sole liberty of representing such production. The infringe- ment of this right is forbidden under a penalty of 'forty shillings for every unauthorized representation of such production, or the amount of the benefit derived from such representation, or of the injury sustained by the author therefrom, whichever shall be the greater damages.'

THEATRE, ENGLISH, FRENCH, &c. [ENGLISH DRAMA.]

THEATRE, HINDU. [SANSKRIT LANGUAGE AND LITERATURE.]

THEBAIA. [PARAMORPHIA.]

THEBAID, or THEBAIS (Θηβαι, sc. χώρα, *Thebais*), sig- nifies the territory or district belonging to Thebes, and is consequently applied to the whole territory subject to the city of Thebes in Boeotia. [THEBES IN BOEOTIA.] In a similar, though a much wider sense, the name was given to the whole of Upper Egypt, the modern Said, of which Thebes was the principal city. This territory extended from Hermopolis Magna southward as far as the first cataracts of the Nile, or to Philæ; or, according to others, as far as Hiera Sicamina. This great province was, according to Strabo (xvii., p. 787), originally divided into ten nomes (*νομοί*); but Pliny (*Hist. Nat.*, v. 9) enumerates eleven, and others mention fourteen—the nomos Lycopolites, Hypseliotis, Aphroditopolites, Timites, Diospolites, Tentyrites, Phatu- rites, Hermonthites, Apollinopolites, Antaeopolites, Pano- polites, Coptites, Ombites, and the nomos Dodecaschoenus. Respecting the nature of these nomes and the physical features of the Thebaid, see EGYPT.

THEBES (Θηβαι, *Thebæ*). Towns and cities of this name occur in several parts of the antient world, but the two which are most renowned in history are the Egyptian and the Boeotian Thebes, of which we shall speak separately, and subjoin a list of the other places of this name.

THEBES IN EGYPT, in the Bible called No, or No Am- men, was situated in the central part of Upper Egypt, which derived from this city the name of Thebais. [THE- BAID.] This city consisted of two main parts, which were divided by the Nile, one occupying the eastern, and the other the western bank of the river, and each extending from the river to the foot of the hills which enclose the valley of the Nile. This gigantic city, whose ruins still excite astonishment, was believed to be the most antient town of Egypt, and the original metropolis of Egypt. Its foundation was ascribed by some to Osiris, who named it after his mother (Diodorus Sic., i. 15), and by others to the last king of the house of Busiris. (Diodorus Sic., i. 45.) According to other authorities, Thebes was an Ethiopian colony. Its original circumference is stated to have been 140 stadia. Its most flourishing period appears to have been about 1600 B.C., when it was the capital of all Egypt, and when, according to Herodotus and Aristotle, the whole country of Egypt bore the name of Thebes (Θηβαι). During that period, which probably comprises several cen- turies, Thebes was the residence of the Egyptian kings, whose tombs are still extant in the rocks on the western side of the city, and extend even to the borders of the desert. (Strabo, xvii., p. 816, ed. Casaub.) Homer (*Iliad*, ix. 381, &c.) speaks of the splendour, greatness, and wealth of Thebes, and calls it 'the city with a hundred gates,' each of which sent out two hundred men with horses and chariots. During the invasion of Egypt by the Persians under Cambyses, Thebes, like other towns, suffered very severely, especially the private dwellings, which were for the most part constructed of wood, while the great archi- tectural works defied the flames as much as they have defied the slower influence of time. (Diodorus Sic., i. 46; Herodotus, iii., 25; Pliny, *Hist. Nat.*, xxxvi. 9.) After this catastrophe the city appears never to have recovered her former greatness. During the time of the Ptolemies, when the seat of government was in the northern extremity of the country, Thebes appears to have been neglected by

the Egyptian kings. In the reign of Ptolemy Lathyrus, about B.C. 86, it revolted, and after a siege of three years it was taken and plundered by the Greeks. As early as the time of Strabo, when its name Thebes had been changed by the Greeks into Diospolis (Διὸς πόλις, Diospolis Magna, that is, the great city of Jove), and the circuit of the city, which could still be traced, amounted to eighty stadia, the place consisted of a number of villages, and what remained of the ancient city consisted chiefly of temples. Under the Roman dominion something appears to have been done to restore or preserve the venerable city; but new calamities broke in upon it when Christianity was introduced into Upper Egypt, and the Christians in their religious zeal destroyed and appropriated to themselves as much as they could of the works of the ancient idolaters. At present the site of the city is occupied by four principal villages, Luxor and Carnac on the eastern, and Gournou and Medinet-Abou on the western side of the river. The buildings and sculptures still extant are the most ancient of any that exist in Egypt, and are the best and most genuine specimens of Egyptian art and architecture, for we have every reason to believe that by far the greatest part of them were executed before Egypt had yet experienced the influence of the Greeks, that is, long before the Persian invasion. (B.C. 525.) The ruins, chiefly consisting of temples, colossi, sphinxes, and obelisks, occupy nearly the whole extent of the valley of the Nile, a space of six miles from east to west; and on the western side, where the ruins of the city end, there begins, as it were, the city of the dead, the tombs in the rocks, with their paintings, which are still as fresh as if they had been made only a few days ago. For an account of these remains, see the articles EGYPT, CARNAC, LUXOR; and more especially the British Museum, 'Egyptian Antiquities,' 2 vols.; and Wilkinson's 'Topography of Thebes,' in his work 'On the Manners and Customs of the Ancient Egyptians,' chap. v.

THEBES IN BOEOTIA, one of the most ancient and most important cities of Greece, was situated in the plain between Lake Hylicæ on the north, and a range of low hills on the south. The Acropolis of the city, built upon an eminence in this plain, was said to have been founded by Phœnicians under Cadmus, whence it was called Cadmea (Καμμία; Strabo, ix., p. 401; Pausanias, ix. 5, 1; Stephanus Byz., s. v. Καμμία). Around this citadel the city arose at a later time, and was so disposed, that the greater portion of it occupied the part north of the citadel. According to an ancient legend, the city was fortified by Zethos, and Amphion, the wonderful lyre-player, who, by his music, made the stones move and form the walls round the city. (Pausanias, ix. 5, 4, &c.; Homer, *Odys.*, xi. 262, &c.) Previous to the Trojan war the city was destroyed by the Epigoni, that is, the descendants of the seven Argive heroes who had been defeated by the Thebans, and from this destruction it does not appear to have recovered before that war, as it took no part in the expedition against Troy. In the time of Homer however, who calls it 'a city with seven gates (ἑπτὰ πύλαι), and gives it the attribute of εὐρύχωρος, on account of the extensive plain which formed its territory, it appears to have again been in a flourishing condition. The names of the seven gates of Thebes are still preserved in Æschylus, Pausanias, Apollodorus, and Statius. In 335 B.C. Thebes was destroyed a second time, by Alexander the Great. On his accession to the throne of Macedonia it had revolted, and attempted to shake off the Macedonian yoke. Of the lower city nothing was left on this occasion except the gates, the temples, and the house of Pindar the poet: 6000 inhabitants were killed, and 30,000 sold as slaves. Cassander rebuilt the city in B.C. 316, with the generous aid of the Athenians, Messenians, and Megalopolitans. (Pausanias, ix. 7.) The city suffered a third time in B.C. 291, under Demetrius Polioretetes. (Plutarch, *Demetr.*, 39, &c.; Diodorus Sicul., *Fragm.*, xxi., p. 273, ed. Bip.) Dicaearchus, who saw Thebes about this time or shortly after, has left us an interesting description of it. This city, says he, is about seventy stadia in circumference; its form is nearly circular, and its appearance somewhat gloomy. It is plentifully provided with water and pastures, and the gardens around it are better than any in Greece. It is most agreeable in summer, on account of the plentiful supply of cool and fresh water, and the beautiful gardens; in winter however it is very unpleasant, because it is destitute of fuel, and exposed to floods and cold winds. At this season heavy falls

of snow were frequent, and the city was very dirty. (Dicaearchi Messeni, *Quæe supersunt*, p. 143, *æc.* ed. Fuhr.) Its population about this time is supposed to have been between fifty and sixty thousand. After the Macedonian time however the city declined still more, and Sulla seems to have given it the last blow by depriving it of half of its territory, which he assigned to the Delphians (Pausanias, ix. 7, 4); and Strabo remarks that in his time it had scarcely the appearance of a village (ix. p. 403, ed. Casaub.). In the time of Pausanias the citadel, then called Thebes, was still inhabited, but the lower city was entirely abandoned; and he only saw the walls, gates, and temples, of which he gives a description. The plain which now occupies the ancient Cadmea is called Theba, or Pheba, and in Turkish, Stiva; and here, as well as in the surrounding plain, there are many remains of ancient buildings, sculptures, and inscriptions. The inhabitants of ancient Thebes were distinguished above all the other Greeks for rusticity, fierceness, and passion. Hence a Theban was always ready to settle any dispute, either with a fellow-citizen or with a foreigner, by fighting rather than by the ordinary course of justice. The women were celebrated for their gentleness and beauty. (Dicaearchus, as above.)

In early times Thebes was governed by kings, who play a more prominent part in the mythical traditions of Greece than the chiefs of any other part of the country. The last of these kings, Xanthus, was slain in single combat by Andropompus. After this event the government of Thebes became an aristocracy, or rather an oligarchy. (Pausanias, ix. 5, 8.) This form of government, although it was frequently restored for a short time, gave way to a democracy. When we read that no one was allowed to be any public office unless he had, at least for ten years, been engaged in any trade, this rule seems to belong to the oligarchic period. (Aristot., *Polit.*, iii. 3, § vi. 4, p. 209, ed. Götting.) During the time of Asian invasion, the government is again called an oligarchy, but it is added that this was not the constitution which the Thebans had inherited from their fathers. (Aristot., iii. 62; Plutarch, *Aristid.*, 18.) The democracy, which must have been restored soon after, was again abolished after the battle of Oenophyta, in B.C. 480. (Aristotle, *Polit.*, v. 2, p. 155.) In the Peloponnesian war we again find mention of an oligarchy at Thebes, (Aristot., iv. 76; v. 31; Diodorus Sic., xii. 69); but this refers only to the influence of the magistrates, so far as that time, as well as afterwards in the time of Agesilaus and Pelopidas, it was the assembly of the people which decided the most important political questions as those relating to war and peace. (Xenophon, *Memorab.*, iii. 5, 8.) Henceforth the democratical constitution appears to have continued at Thebes down to the time when Greece fell into the hands of the Romans, and a part of it remained even afterwards. Along with the constitution of Athens (Polybius, vi. 44), Thebes also had a senate and the magistrates, who were elected annually by the people, but bore the name of polemarchs. As a state Thebes was not confined to the city and its immediate neighbourhood, but comprised the whole territory between the eastern coast of Lake Copais and Mount Citæon, which empties itself in the sea between Eubœa and the mainland. This whole territory was called Thebæ, and contained a great number of towns which were confederate states with Thebes. Among the fourteen confederate states Thebes was the first, whence it is generally called the capital of Boeotia, which, in the strict sense of the word, it certainly was not. [BOEOTIA.]

Besides the Egyptian and Boeotian Thebes, the following towns of this name are mentioned by ancient writers:

1. Thebes in Phthiotis in Thessaly (Θῆβαι αἰ τῆς Φθιώτιδος) Thebæ Phthioticæ, or Thebæ Phthiæ) was an important commercial town with a good harbour. (Strabo, l. p. 431, 433, 435; Livy, xxxix. 25; xxxviii. 7, &c.)

2. Thebe (Θῆβη) in Troas in Asia Minor was celebrated as a fortified place as early as the Trojan war. It was situated north of Adramyttium, and taken and destroyed by Achilles. The plain in which the town had been situated was known down to the latest times as the Plain of Thebe (τὸ Θῆβης πεδῖον; Homer, *Iliad*, i. 386; vi. 387; Strabo, xiii., p. 564, &c.; Herodotus, vii. 42).

es, in that part of Arabia Felix which was country of the Cinædocolpites. es in Lucania in Italy. (Pliny, *Hist. Nat.*, iii. nanus of Byzantium (s. v. $\Theta\alpha\beta\epsilon\alpha$) mentions seven towns of this name, of which however nothing

, a term in vegetable anatomy. It was applied to that part of the stamen which contains the ve granules and which is now generally called . [ANTHER.] It is also extensively employed in ic botany. Among the ferns, it is applied, n with the terms capsule, conceptacle, and a [SPORANGIUM], to those little granules which the 1 called sori. In the Equisetaceæ it | *causa* e of cases, which are attached to *causa* in a comical manner.

t 1 is used to indicate the kidney-shaped s that contain the reproductive matter of ceæ and also the urn-like organs that enclose the f mosses. It is by some writers still further ex- d used to express the parts that contain the Lichens and Fungi.

(in Anatomy) is a term commonly applied to fibrous sheaths in which certain soft parts of the enclosed. Thus the *theca vertebralis* is the tura 1 ter in which the spinal chord is enclosed ; through which many of the long tendons tes of the hand and foot run are called thecæ. are always lined by a synovial membrane, and ll quantity of fluid [SYNOVIA], by which the tis tendons is facilitated.

DACTYLS, Cuvier's name for those *Gechos* s the toes enlarged throughout their length, and l w with transverse scales, which are divided a al furrow, where the claw may be entirely .]

LEA, of THECIDIUM. [BRACHIOPODA, vol. 1. Mr. J. E. Gray arranges the *Thecideidæ* as ily of the *Brachiopoda*, placing it between æ and the *Craniadæ*, and making it consist nus *Thecidea*.

OSAURUS. [THECODONT.] S. Professor Owen, in his 'Report on piles,' observes that among the inferior ans there are two leading modifications le u attachment of the teeth, the base of which her anchylosed to the summit of the alveolar the bottom of an alveolar groove, and supported al wall. These modifications are, he remarks, epectively by the terms 'acrodont' and 'pleu- third mode of fixation is presented by some rians, which, in other parts of their organiza- e to the squamate or lacertine division of the teeth being implanted in sockets, either loosely nt with the bony walls of the cavity: these wen has, in his 'Odontography,' termed the *Lacertians*, the most antient of all saurians be- this group.

icing with the *Thecodontosaurus* of Dr. Riley utchbury, described by them in the 'Geological ne' of 1836, from remains found in the dolomitic at of Redland, near Bristol, the oldest or lowest the new red sandstone series, Professor Owen at this reptile is allied to the typical *Varanian* but differs from them in having the teeth im- distinct sockets; but that the *Varani*, among te saurians, approach to this condition in the vities containing the base of their teeth along of the alveolar groove.

he extinct genus now under consideration, the , he states, deeper, and the inner alveolar wall s high as the outer one; the teeth are arranged set series, slightly decreasing in size towards the art of the jaw; each branch of the lower jaw l to have contained twenty-one teeth, which are ther slender, compressed and acutely pointed, nterior and posterior finely serrated edge, the being directed towards the apex of the tooth, as er's genus *Rhopalodon*; the outer surface is ex than the inner one; the apex is slightly ren- the base of the crown contracts a little to ube cylindrical fang. He then goes on to remark pulp-cavity remains open in the base of the

crown; that, in their microscopic structure the teeth of the *Thecodontosaurus* closely correspond with those of *Varanus*, *Monitor*, and *Megalosaurus*; that the body of the tooth consists of compact dentine, in which the calcigerous tubes diverge from an open pulp-cavity at nearly right angles to the surface of the tooth; that they form a slight curve at their origin, with the concavity directed towards the base of the tooth; then proceed straight, and, at the periphery, bend upwards in the contrary direction. The diameter of the calcigerous tube he gives as 1-30,000th of an inch, and the breadth of the interspace of the tube as 1-8000th of an inch. The crown of the tooth is invested with a simple crown of enamel. This microscopic examination, which Professor Owen was enabled to make by the kindness of Mr. Stutchbury, satisfactorily estab- lishes, in the Professor's opinion, the distinction between the saurian of the Bristol conglomerate and *Labyrinthodon*. [SALAMANDROIDES.]

Of PALÆOSAURUS Professor Owen states that its tooth is compressed, pointed, and with trenchant serrated margins; but that its breadth, compared with its length, is much greater than in *Thecodontosaurus*. The vertebræ associated with these teeth were biconcave, with the middle of the body more constricted, and terminal articular cavities rather deeper than in TELEOSAUREUS; but, the Professor adds, they are chiefly remarkable for the depth of the spinal canal at the middle of each vertebra, where it sinks into the substance of the centrum, and thus the canal is wider vertically at the middle than at the two ends of the vertebra: an analogous structure, he observes, but less marked, obtains in the dorsal vertebræ of the *Rhynchosaurus* from the new red sandstone of Shropshire.

Professor Owen then points out that besides deviating from existing lizards in the thecodont dentition and biconcave vertebræ, the antient saurians of the magnesian conglomerate also differed in having some of their ribs articulated by a head and tubercle to two surfaces of the vertebra, as at the anterior part of the chest in *Crocodyles* and *Dinosaurs*. The shaft of the rib, he tells us, was traversed, as in the Ichthyosaur and Rhynchosaur, by a deep longitudinal groove; and some fragmentary bones indicated obscurely that the pectoral arch deviated from the Crocodilian, and approached the Lacertian or Enalioeu- rian type in the presence of a clavicle, and in the breadth and complicated form of the coracoid. The humerus, he observes, appears to have been little more than half the length of the femur; and to have been, like that of the *Rhynchosaurus*, unusually expanded at the two extremities.

After quoting the description of the femur by the discoverers of the present thecodont reptiles, Professor Owen remarks that the tibia, fibula, and metatarsal bones manifest, like the femur, the fitness of the thecodont saurians for progression on land. The ungual phalanges, he observes, are subcompressed, curved downwards, pointed, and impressed on each side with the usual curved canal.

The Professor draws the following conclusions from the knowledge at present possessed of the osteology of *Thecodontosaurus* and *Palæosaurus*, whose antiquity the discoverers of these genera regard as being greater than that of any other vertebrated animals, excepting fishes:—

In their thecodont type of dentition, biconcave vertebræ, double-jointed ribs, and proportionate size of the bones of the extremities, they are nearly allied to the *Teleosau- rus*; but they combine a lacertian form of tooth and structure of the pectoral and probably pelvic arch with these crocodilian characters, having distinctive modifica- tions, as the moniliform spinal canal, in which however the almost contemporary Rhynchosaur participates.

Professor Owen adds that it would be interesting to ascertain whether the caudal vertebræ are characterized, as in the Thuringian Protosaur, by double diverging spinous processes.

Cladodon, Owen.—'In the new red sandstone (keuper?) of Warwick and Leamington,' says the Professor, 'there occur detached, pointed, trenchant, recurved teeth, the crowns of which are sometimes 1 inch 4 lines in length, and 5 lines across the base: they have been found in the same quarries as those containing the remains of *Labyrin- thodon*. In their compressed form, anterior and posterior serrated edges, sharp points, and microscopic structure, these teeth agree with those of the Saurian reptiles of the

Bristol conglomerate. In their breadth, as compared with their length and thickness, they are intermediate between the *Thecodontosaurus* and *Palæosaurus platyodon*; but they are larger, with longer and more recurved crowns, and thus more nearly approach the form characteristic of the teeth of the *Megalosaurus*. From these teeth however they differ in their greater degree of compression, and in a slight contraction at the base of the crown; I therefore indicate the genus, of which, as yet, only the teeth are known, by the name of *Cladyodon*, and the species from the Warwickshire sandstones by the name of *Cladyodon Lloydii*, in testimony of the friendly aid of Dr. Lloyd of Leamington, to whose zealous co-operation I owe the materials for the description of the teeth of the present genus, and the still more remarkable ones of the British species of *Labyrinthodon*, with which the teeth of the *Cladyodon* are associated.

In conclusion, Professor Owen refers to a tooth of *Cladyodon* figured by Mr. Murchison and Mr. Strickland in their paper on the Warwick sandstones. (*Geol. Trans.*, 2nd series, vol. v.)

THECOSOMATA, M. de Blainville's name for his first family of *Aporobranchiata*, the first order of his second section of his second subclass (*Paracephalophora Monoica*).

The *Aporobranchiata*, according to M. de Blainville, consist of those *Malacozeria*, or Mollusks, which have the body of a slightly variable form, but constantly provided with natatory appendages which are equal and lateral, without any foot properly so called, and which often have the organs of respiration but little evident.

The following genera are arranged by M. de Blainville under the family of *Thecosomata*:—

Hyalæa: *Cleodora*, divided into two sections; 1, depressed species, Ex., *Cleodora Brownii*; 2, conical and not depressed species (genus *Vaginella*, Daud.), Ex., *Vaginella depressa*; *Cymbulia*: and *Pyrgo* (fossil).

The principal forms of this family are treated of under the article HYALÆIDÆ.

Mr. J. E. Gray, who makes the *Thecosomata* the first order of the class (4th) PTEROPODA, divides the forms which, in his opinion, should be arranged under that order, into the following families and genera:—

Fam. 1. Cleodoridæ.

Genera:—*Hyalæa*; *Diacria*; *Cleodora*; *Balanium*; *Pleuropus*; *Vaginella*; *Creseis*; *Brochus*; *Psyche*; *Euribia*.

Fam. 2. Limacinidæ.

Genus, *Limacina*.

Fam. 3. Cuvieridæ.

Genera:—*Cuvieria*; *Tripterea*.

Fam. 4. Cymbuliadæ.

Genus, *Cymbulia*.

THEDEN, JOHANN CHRISTIAN ANTON, a celebrated German surgeon, was born Sept. 13, 1714, at Steinbeck, a small village not far from Wismar, in the duchy of Mecklenburg. His family had been ruined by the disasters of war, and his father died when he was young, which two melancholy events had an unfavourable influence upon his education and his first entrance into life. He had hardly received the bare elements of education, when, at the age of thirteen, he was reduced to the necessity of hiring himself out as a servant; but this occupation was so revolting to his feelings, that he determined to learn a trade. Accordingly his elder brother, who was a tailor, received him as an apprentice; but Theden did not find this employment more suited to his taste and talents than his former one, and, as he got nothing but reproofs from his brother, he finally determined to devote himself to the study of medicine. He was first placed by his friends with a surgeon at Butzow, where he spent four years in a barber's shop without any real advantage; and as soon as his apprenticeship was finished, he went to Rostock, Hamburg, Lübeck, and Danzig. In this last city he at length succeeded in obtaining some employment in the troops of the king of Prussia, and was attached as surgeon to a squadron of cuirassiers. The zeal and punctuality with which he performed all his duties in this post soon gained him the esteem and friendship of his superior officers: the jealousy however of the chief surgeon (*chirurgien-major*) prevented his profiting by the good-will shown him by king Frederick William I. at a review at Riesenburg, and the death of this prince put an end to all the hopes of promotion which he had at first entertained. In 1742 he went

to Berlin, where the celebrated Schaaerschmidt, who appreciated his talents, honoured him with his favour and procured for him the post of chief surgeon on second war in Silesia. At the end of three years he returned to Berlin, and devoted himself with attention to the study of anatomy and surgery. Seven Years' War afterwards furnished him with many opportunities of displaying the skill that he had, and also the excellent qualities of his heart. Frederick Great raised him gradually from one post to another, became at last his chief military surgeon. The eminent position, improved all the branches of anatomy and displayed an activity which contributed to gain him the good opinion of his sovereign. The king of Prussia honoured him equally with his confidence and Theden continued to enjoy to the end of his life the esteem and respect for which he was indebted to his real merit and eminent services. He died, Oct. 1797, at the age of eighty-three. The commotion and agitation of war did not prevent his drawing up in order the observations which an opportunity of action had given him an opportunity of making. His works are not numerous, but they bear the stamp of experience, and one recognises in them the touch of a man who did not venture to take any thing for granted after thirty years of most extensive practice. In this eulogium we must however except all the errors of his writings, which, unfortunately, have a place in them, and which are only based upon the tradition of the antiquated principles of the art. The following is the list of his works:—*Journal de la Biographie Médicale*, par Theden, par la preceding account has been taken:—*Ueber die Kunst und Erfahrungen zur Bereicherung der Heilkunst und Medicin*, Berlin und Stettin, 1774, 8vo., and 1782, 8vo.; *Sendschreiben die neu erfundenen Catheter aus der Reine treffend*, Berlin, 1777, 8vo.

THEFT. [LARCENY.]

THEIN, or Theina, the peculiar principle of opium was procured and analysed by M. Jobst of Stuttgart prepared it by boiling tea-leaves in water, and concentrating the solution, and adding to it a solution of lead as long as precipitation occurred; after the excess of lead was precipitated by sulphuric acid, and by subsequent evaporation crystals were deposited which possessed the following properties: they were soft, acicular, more soluble in hot than in cold water, alcohol, or they dissolved readily in acids, and were decomposed when heated either in sulphuric or nitric acid. It has no effect on vegetable blues; alkalis do not decompose it from solution in acids, and when boiled in a solution of potash it is decomposed, and ammonia is evolved; it contains water of crystallization, which is lost when Thein may be sublimed.

According to the analysis of Jobst, the composition is as follows:

Hydrogen	5.22
Carbon	49.60
Oxygen	16.27
Azote	28.91

100

It is to be remarked that this analysis very closely agrees with that of Caffein as given by Liebig.

THELICONUS, Mr. Swainson's name for a subgenus of *Conus*. Ex., *Conus nussatella*. (*Malacology*.)

THELIDERMA, Mr. Swainson's name for a subgenus of *Unio*. (*Malacology*.) [NALADES.]

THELIDOMUS, a form placed by Mr. Swainson in his family *Trochidæ*, in the subfamily *Rotellina*. The generic name at the head of this article.

Example, *Thelidomus Braziliensis*.

Mr. Swainson thus describes it. 'We have placed *Trochidæ* next to the *Helicidæ* under the belief that they followed each other, although the links of connection are wanting. It is clear that of all the types of the *Trochidæ* the nearest approach to *Helix* is that which by its general form makes the nearest approach to *Helix*; while the thickening of the inner lip, which spreads over the umbilicus, is found but in a less degree, in many of the land volutes, and

But a singular discovery recently made has thrown entirely new light upon this interesting question. Finding a considerable number of freshwater *Planorbis*, all of one species, which were sent to us from Zil, we picked out two helix-looking shells, so precisely the same olive-brown colour, and of the same size, as others, that none but a conchologist would have been to examine them. They appeared in fact like two land-snails of the subgenus *Zonites*, that had fallen the water where the *Planorbis* (sic) had been found, outside being discoloured, and covered with little scales of dirt and sand. On placing them however in the magnifier, a conchologist alone can judge of our mishap at finding that the whole of the shell was only composed of little stones and grains of sand only, cemented together, yet with so much skill by the animal that the regular turns of the volutions of the spire, the form of the umbilicus, were most accurately preserved: they were, in short, freshwater carriers—absolute parts of their marine brethren, *Onustus*. As we found no notice nor even allusion to such an extraordinary class of shells in any writer, we have considered it affixed to it the name of *Thelidomus*. In regard to its affinity, we suspect that it fills the same situation as the *Rotellina* which *Onustus* does among the *Trochidae*: this will make it the most aberrant type and consequently that which comes nearest to the *Helicidae*, whose it actually possesses. The annexed figures are taken from the only two specimens, in our cabinet, which we either seen or heard of. Thus, there is ground for supposing that the passage from the marine *Trochidae* to terrestrial snails is marked by one or more fluviatile forms; just as is the passage, on the other side, of the *Helicidae* to the *Limnæinæ*. The accidental discovery of this extraordinary shell will probably induce naturally to a more accurate examination of the fossil turrid univalves; for it is clear that although *Thelidomus* the path to the *Helicidae*, there must be several other forms between the two, either extinct or undiscovered. *Malacology: Cabinet Cyclopædia*, 1840.)

This so-called shell, which is twice figured and described in the work of a mollusk in the work quoted, is the case of an act.

We notice the error, that a mistake in a useful booking the authority of a name so generally known and reverently respected as Mr. Swainson's, may not mislead. **HELIDON'TA**, a genus of pulmoniferous gastropods, described by Mr. Swainson apparently places among the *Lucernæ*, or *Land Volutes*, as he terms them: but we do not fit it in the 'Natural Arrangement' at the end of his *Malacology*, unless *Thelidomus*, which appears for the third time, following *Pusiodon* at the end of the family *Lucernæ*, be a misprint for it.

THELLUSSON, PETER. He was the son of Isaac de Thellusson, ambassador from Geneva to the court of Louis

He fixed his residence in London about the middle of the eighteenth century, and accumulated an immense fortune as a merchant. He died on the 21st of July, 1797. His name has been rendered remarkable by the extraordinary nature of his will. The capricious and extensive use of the power of disposing of his property, which the law then existing, placed in his hands, led to the restraints frequently imposed upon testamentary dispositions.

His property which was the subject of his will consisted of a landed estate of about 4000*l.* a year, and of personal property to the amount of about 600,000*l.* This property was bequeathed to trustees upon trust for accumulation and investment in the purchase of lands during the lives of his sons, grandsons, and the issue of sons and grandsons living, or *in ventre sa mere*, at the time of his death, and the lives of the survivors and survivor of them; after that period, to be conveyed to the lineal descendants of his sons in tail male.

It had been long understood to be the rule of law that the absolute ownership of property might be suspended, consequently the property rendered inalienable, during its being at the time of the creation of the trust, or where the trust is created by will, at the time of the death of the testator. This period was afterwards extended so as to allow for the cases of infancy, and of a child *in ventre sa mere*; but it was for some time questioned whether a term of twenty-one years should in all cases be added to the period of suspension. P. C., No. 1526.

tion, though it has since been determined that it may. [SETTLEMENT.] Restraint on the accumulation of income was unknown to the common law, except in so far as the rule against perpetuities necessarily prevented accumulation from being carried beyond its limits; and Mr. Thellusson's will, by confining the restriction to existing lives, escaped the question which then existed as to the allowance of an absolute term of twenty-one years in addition to a life or lives in being at the time of the creation of the trust.

This will, which, in the events that happened, had the effect of postponing the usufructuary enjoyment of the bulk of the estate till the expiration of nine lives in being at the time of the testator's death, was, after many hard struggles, occasioned rather by the immense value of the property implicated (which it was computed would have amounted, with the expected accumulations, to upwards of 18,000,000*l.*), than by any new difficulty in the principle, finally established by the decision of the House of Lords on the 25th of June, 1805. (*Thellusson v. Woodford*, 11 Ves., 112.)

The case of *Thellusson v. Woodford* gave rise to the act of the 40 Geo. III., c. 98, 'for restraining all trusts and directions in deeds or wills whereby the profits or produce of real or personal estates shall be accumulated and the beneficial enjoyment thereof postponed beyond the term therein limited.' By the provisions of this act no person can settle or dispose of property by deed, will, or otherwise, so as to accumulate the income thereof, either wholly or partially, 'for any longer term than the life or lives of any such grantor or grantors, settlor or settlors, or the term of twenty-one years from the death of any such grantor, settlor, devisee, or testator, or during the minority or respective minorities of any person or persons who shall be living or *in ventre sa mere*, at the time of the death of such grantor, devisee, or testator, or during the minority or respective minorities only of any person or persons, who, under the uses or trusts of the deed, surrender, will, or other assurances directing such accumulations, would for the time being, if of full age, be entitled to the rents, issues, and profits, or the interest, dividends, and annual produce so directed to be accumulated. And in every case where accumulation shall be directed otherwise than as aforesaid, such direction shall be null and void, and the rents, issues, profits, and produce of such property so directed to be accumulated shall, so long as the same shall be directed to be accumulated contrary to the provisions of this act, go to and be received by such person or persons as would have been entitled thereto, if such accumulation had not been directed.' Sect. 2 provides, 'that nothing in this act contained shall extend to any provision for payment of debts of any grantor, settlor, or devisee, or other person or persons, or to any provision for raising portions for any child or children of any person taking any interest under any such conveyance, settlement, or devise, or to any direction touching the produce of timber or wood upon any lands or tenements; but that all such provisions shall be made and given as if this act had not passed.' Sect. 3 provides that the act shall not extend to dispositions of heritable property in Scotland.

It has been sometimes thought that periods specified in the act might be taken accumulatively, and that accumulation might be directed for them all successively. The language of the statute however is disjunctive, and therefore seems to give the option of selecting one only of the designated periods. (9 Ves., 136.) And it has been determined that the clause respecting the minority of persons entitled under the limitation in the instrument does not authorize a trust for accumulation extending over the minority of an unborn person to whom at majority the accumulated fund with the principal from which it arose is given. (4 Madd., 275.)

It is now settled upon this statute that a trust for accumulation reaching beyond the allowed period is good for the period allowed by law. (12 Ves., 295; 4 Russ., 403., THELPHU'SA. [THELPHUSIANS.]

THELPHU'SIANS, M. Milne Edwards's name for a tribe of brachyurous crustaceans belonging to his family of *Catometopes*, having, as he observes, considerable analogy with the *Cancerians*, and evidently forming the passage between them and the *Gecarcinians*, or Land Crabs. [GECARCINUS.] The general form, in fact, he remarks, of many of the *Thelphusians* differs but little

from that of *ERIPHIA*, and the disposition of the organs of generation is the same as in the two preceding families*; but the structure of their respiratory apparatus and other characters place them at a distance from those natural groups, and do not permit their separation from the *Catometopes*. Thus, he observes, each of the branchial cavities occupies about a third of the carapace and is elevated into a vault at a very considerable distance from the branchiæ. Sometimes the lining membrane is covered with spongy vegetations. The branchiæ are, it is true, nine on each side, namely, two reduced to the state of vestiges and fixed to the jaw-feet, and seven lying on the vault of the sides as in the *Cyclometopes*; but their texture is softer, and they are directed backwards so as to cover nearly the whole of the vault of the sides, a disposition which is only met with in the family of the *Catometopes*.

The carapace of the *Thelphusiens* has but little or no convexity, and is wider than it is long: its anterior border is straight, and occupies about two-thirds of its transversal diameter: its lateral borders describe a regular curve. The front is remarkably wider than the buccal frame, and more or less curved downwards. The eyes have a stout and short peduncle, the length of which is never more than double the diameter, and its lower surface is occupied by the cornea for about half its length. The orbits are oval, and always present at their internal angle a narrow gap filled by the external antenna. The internal antennæ are horizontal, and, in general, nearly entirely hid by the front. The basilar joint of the external antennæ penetrates into the gap which occupies the internal angle of the orbit and separates this cavity from the antennary fossets; it is but little developed, and the moveable stem which springs from it in the same gap is very small. The epistome is nearly linear, and placed on the same level as the lower border of the orbit. The buccal frame is nearly as large before as behind, and the fourth joint of the external jaw-feet is inserted sometimes at the internal angle, sometimes at the middle of the anterior border of the preceding joint, and sometimes at its external angle. The anterior feet are much stronger and nearly always longer than the succeeding ones; they are but little, if at all, compressed. The third pair of feet are the longest of all, but they are not twice the length of the post-frontal portion of the carapace, and they terminate, like the others, in a styliform tarsus. The second joint of the abdomen of the male covers the corresponding portion of the sternal plastron throughout its width, and extends to the basilar joint of the posterior feet. The abdominal appendages of the second pair in the male are filiform towards the end, and at least as long as those of the first pair. (M. E.)

Habits of the Tribe.—These are very remarkable. All the known species live in the earth near the banks of rivers or in humid forests; bearing a strong analogy to the Land-Crabs. (M. E.)

M. Milne Edwards divides the tribe into three sections:—

1. Third joint of the external jaw-feet nearly square, and giving insertion to the succeeding joint by a notch in its internal angle.

Genus, *Thelphusa* (Latreille).

Generic Character.—Carapace wider than it is long, narrowed behind and very slightly convex above. The regions generally scarcely separated, but the stomachal region, when it is distinct, is extremely wide forwards. The fronto-orbital or anterior border of the carapace occupies about two-thirds of its transversal diameter, and its lateral borders are very much arched in their two anterior third portions: the posterior border is equal in width to the half or two-fifths of its transversal diameter. The front is very little inclined, nearly straight, and wider than the buccal frame. The orbits are oval; they present no fissures above, and are furnished with a large vertical tooth which rises from their lower wall near the internal canthus of the eye. The antennary fossets are very narrow. The basilar joint of the external antennæ varies in its form, but only reaches a little, or not at all, beyond the tooth of the lower orbital wall against which it is applied. External jaw-feet elongated, and their third joint, nearly quadrilateral, carrying the succeeding joint at its internal angle, which is truncated: Sternal plastron nearly as long as it is wide, and approaching in its form that of the *Cancerians*.

* These appear to be the *Cryphynchi* and *Cyclometopes*.

Cancerians. Anterior feet always much longer than the pair, and unequal in size: the hands slightly curved forwards, and the claw which terminates them points much elongated, and finely denticulated. Succeeding all slightly channelled above; their tarsus is quadrate and armed with very strong horny spines; the second are much shorter than the third, the length of which does not quite equal twice the length of the first. Abdomen composed of seven joints in both sexes.

There are several species, and the *Geographical Distribution* appears to be wide. The form is found in Greece, Egypt, and Syria. On the Coromandel coast the Cape of Good Hope; and at Pondicherry.

Example, *Thelphusa fluviatilis*. Length 2½. Colour yellowish.

Localities.—South of Italy, Greece, Egypt, and Syria. This species is generally considered to have been known to the ancients, and to be that noticed by Pliny, Crates and Aristotle: these *Thelphusæ* are supposed to be the Heracleotic Crabs (οι Ηρακλειωτικοί καρκίνοι of the *Hist. Anim.*, iv. 2); and to be those represented on the medals.

Thelphusa fluviatilis burrows in the earth on the banks of rivers.



Thelphusa fluviatilis (reduced).
a. External jaw-foot of same.

2. Third joint of external jaw-feet nearly square, and giving insertion to the succeeding joint by a notch in the middle of its anterior border.

Genus, *Boscia* (Edwards; *Potamia*, Latreille).

Generic Character.—General form nearly the same as some of the *Thelphusæ*; but the front, which is bent downwards, is vertical, and the third joint of the external jaw-feet, instead of being square and having the ordinary form existing in the *Cancerians*, is narrow and carries the succeeding joint on its anterior border. (M. E.)

M. Milne Edwards remarks that this genus is like the *Thelphusæ*,* and inhabits also the banks of rivers. He states that a dissection of an individual was made in spirit by M. Andouin and himself, discovered a very remarkable disposition in the branchial region of this crustacean: the cavities which enclose the respiratory organs are elevated far above the upper surface of the branchiæ, and present a great vacant space, into which the water which is lined with a tomentose membrane covers the organs with spongy vegetations.

Example, *Boscia dentata*, the only known species. Length about 2 inches.

Localities.—The Antilles and South America.

3. Third joint of the external jaw-feet having the form of a reversed triangle, and giving insertion to the succeeding joint by its external angle.

Genus, *Trichodactylus* (Latreille).

Generic Character.—Carapace nearly horizontal and much less wide than in *Thelphusa*. Front nearly lamellar, and simply inclined; orbits nearly circular, lateral borders of the carapace curved. Antennæ nearly as in *Thelphusa*; but the form of the external antennæ is very different, their third joint is nearly triangular with its summit directed inwards, and it is articulated to the succeeding joint by its anterior and external

* But see page, p. 307.

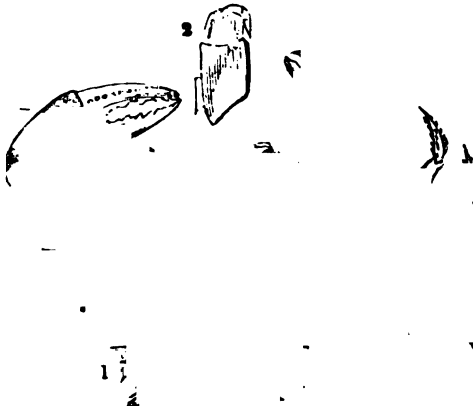

Bocca dentata, reduced one-third.

1, Antennary region; 2, external jaw-foot.

ly of the same form as in the preceding genera.

le, *Trichodactylus quadratus*, the only known Length about 1 inch.

y.—Brazil.

ine Edwards is of opinion that this species estab- passage between the preceding genera and the *trapezoidians*. [GRAPSUS.]

. S. MacLeay, in his interesting paper 'On the ous Decapods of the Cape' (Smith's *Illustrations logy of South Africa*), in a note to the sixteenth *Thelphusa perlata*, M. E.), remarks that this crab n in all the rivers of Southern Africa, and grows e of nearly three inches long. 'The male,' says MacLeay in continuation, 'has a much more con- than the female, and in aspect resembles much a us. The pearly tubercles of the anterior margin ell are also still more small and evanescent than

le. I may take this occasion to observe, that I separate those species of *Thelphusa* which, p nt, have a transversal crest in front of the l them *Potamonautes*. They are easily disd from true *Thelphusæ*, of which the type is the species *Thelphusa fluviatilis*.

WALL, JOHN, son of Joseph Thelwall, a silk- as born on the 27th July, 1764, in Chandos-street, arden, London. He was the youngest of three two sons and a daughter. At an early age he d so much talent for drawing, that he was in- r an artist, but his father's decease changed his before he had completed his ninth year. He the ordinary education of a tradesman's son, but rather slow in acquiring knowledge and was reom school at thirteen years of age, his attain- st necessarily have been limited.

dow continued to carry on her deceased hus- iness, and placed her son John in the shop, remained three years, but spent his time chiefly g, which was of a miscellaneous character, con- poetry, history, the drama, moral philosophy, ics, and divinity. A distaste for the business, family discord, induced him to leave it, and ale earnestly desired to be an artist or an actor, l to his mother, who apprenticed him to a tailor, m however he remained only a short time. At stion of Mr. Holt of the Chancery bar, who had is sister, he turned his attention to the law, but eral years' study he abandoned it in consequence arising in his mind on the morality of a hired pleading to support a cause rather than to dis- truth; and now, in his 22nd year, he embraced as a profession.

he published by subscription poems on several n 2 vols., which introduced him to some valuable s and to the editorship of a magazine. He was ing and prosperous man, and on the 27th July, married Miss Susan Vellum, of Rutlandshire, hen 17 years of age. He took a house near the hospitals, and ardently studied anatomy, phy- nd chemistry, under Mr. Cline, Dr. Haighton, abington.

an his career as an orator, before he was twenty

years of age, at the Society of Free Debate held at Coach- makers' Hall. He had been educated a churchman in religion and a tory in politics, but on both subjects his opinions were changing, and he now joined in the political struggles of the period by becoming a member of the Corresponding Society, where his boldness and fluency of speech attracted the notice of the leading men of the day. With Thomas Hardy and John Horne Tooke [HORN TOOK] he was tried for high treason, and acquitted. Thelwall's trial lasted five days. On his acquittal he lectured on politics and political history for several years, when, after a retirement of two years in Wales, made in order to disconnect himself from public affairs and to escape from extra-judicial persecution, he began his career in 1801 as a lecturer and tutor in elocution, and in the application of elocutionary science to the cure of stammering and other impediments to speech. His knowledge of anatomy and physiology, his habits of recitation, his practice of public speaking, and his accuracy of observation, eminently qualified him for his new profession, and his success was great. He communicated papers to the 'Medical and Physical Journal,' on defective and difficult utterance, and to the 'Monthly Magazine,' on elocution and its kindred sciences.

In 1816 Mrs. Thelwall died, leaving a family of four children, two of whom are sons, and both are in the church. Mr. Thelwall afterwards married Miss Cecil Boyle, by whom he has left one son. He died at Bath after a few hours' illness, of disease of the heart, to which he had been long subject, on the 17th February, 1834, in his 70th year.

The researches of Steele, Herries, and Walker, on human speech, had left little room for new and brilliant discovery, although much accurate observation was yet necessary to give exactness and fulness to their knowledge. Thelwall, unaware of Steele's researches, found himself anticipated on rhythmus. Steele had given the inquiry a musical direction, which Thelwall ardently followed out, and the extent and precision of his observations may be estimated by the fact that he anticipated nearly all that is new and valuable in Dr. Rush's 'Philosophy of the Human Voice.' Mr. Thelwall's immature ideas were first sketched out in the syllabus of his lectures on elocution.

Thelwall was of a mild and amiable disposition, of domestic habits, open-hearted and generous, of high moral feeling, and of inflexible integrity. His sentiments were exalted by poetic feeling, and he was buoyed up by hope.

Besides magazine contributions and pamphlets, he wrote poems on several subjects, in 2 vols., already mentioned; 'Poems written in the Tower and in Newgate,' 1 vol.; 'The Tribune,' 3 vols., and 'Political Miscellanies,' 1 vol.; 'A Letter to Mr. Cline, on Stammering,' 1 vol.; 'The Peripatetic,' 3 vols.; and a novel, entitled 'The Daughter of Adoption.'

THEMEON. [FORAMINIFERA, vol. x., p. 348.]

THEMIS (Θέμις), a Greek divinity, was, according to Hesiod and Apollodorus, a daughter of Uranus (Heaven) and Gaea (Earth), or, according to Tzetzes, a daughter of Helios. She was a favourite of Zeus, and bore him several daughters,—the Horæ, Eunomia, Dice, Eirene, and the Moerae. (Hesiod, *Theog.*, 135, 901, &c.; Apollodorus, i. 3, 1.) These personified abstractions, which are represented as her daughters, show the ideas which the antients had formed of her character, and consistently with these ideas she appears in Homer as a personification of the order of things sanctioned by usage or by law, and as the goddess who rules in the assemblies of the people. (Homer, *Odys.*, ii. 68, &c.) According to the same poet she lived with the other great gods in Olympus, was on good terms with Hera, and occasionally assembled the gods at the command of Zeus. (Homer, *Iliad*, xv. 87, &c.; xx. 4, &c.) Diodorus (v. 67) states that she was believed to have made men acquainted with the will of the gods, the mode of their worship, and to have instituted laws, religious as well as civil. As a deity revealing the future she was believed to have been in possession of the Delphic oracle after her mother Gaea, and previous to the time that it came into the hands of Apollo, whence the act of giving an oracle was, even in later times, frequently called by a word derived from her name (θεμορεβίω). She was worshipped as the goddess of law and order in various parts of Greece, as at Thebes, Olympia, Athens, Tanagra, and Troezen. She is frequently represented on coins in a form

resembling that of Athena, but carrying the horn of plenty in one hand and a pair of scales in the other.

THEMISON (Θεμισών), an antient physician, who is probably best known to most persons from Juvenal's somewhat equivocal line (*Sat.*, x., v. 221)—

'Quot Themison aegros auctumno occiderit uno;

but who was in reality the founder of a celebrated medical sect, and one of the most eminent physicians of his time. He was born at Laodicea in Syria, in the first century before Christ, and, from Juvenal's line above quoted, may be conjectured to have practised at Rome. He was a pupil of Asclepiades, from whose opinions however he afterwards dissented, and finished by founding a new medical sect, called the Methodici. (Pliny, *Hist. Nat.*, lib. xxix., cap. 5, ed. Tauchn.; Galen, *Introd.*, cap. 4, tom. xiv., p. 683, 684, ed. Kühn; Cramer, *Anecd. Gr. Paris.*, vol. i., p. 395, l. 26.) The following is the analysis of the opinions of this school, which is given by Celsus in the historical introduction to his work:— They assert that the knowledge of no cause whatever bears the least relation to the method of cure; and that it is sufficient to observe some general symptoms of distempers; and that there are three kinds of diseases, one bound, another loose,† and the third a mixture of these. For that sometimes the excretions of sick people are too small, sometimes too large; and sometimes one particular excretion is deficient, while another is excessive. That these kinds of distempers are sometimes acute, and sometimes chronic; sometimes increasing, sometimes at a stand,‡ and sometimes abating. As soon then as it is known to which of these classes a distemper belongs, if the body be bound, it must be opened; if it labours under a flux, it must be restrained; if the distemper be complicated, then the most urgent malady must be first opposed. And that one kind of treatment is required in acute, another in inveterate distempers; another when diseases are increasing; another when at a stand; and another when inclining to health. That the observation of these things constitutes the art of medicine, which they define as a certain way of proceeding, which the Greeks call *method* (μῆθοδος), and affirm it to be employed in considering those things that are common to the same distempers: nor are they willing to have themselves classed either with the rationalists (*i.e.* the Dogmatici), or with those who regard only experiments (*i.e.* the Empirici): for they dissent from the first sect, in that they will not allow medicine to consist in forming conjectures about the occult things; and also from the other in this, that they hold the observation of experiments to be a very small part of the art. (Futvoje's *Translation*.) What we know of his mode of treating diseases does not give us a very high idea of his skill in therapeutics. He thought he could cure the most violent attacks of pneumonia by means of oil and baths; in pleurisy he permitted the use of wine mixed with sea-water (Cael. Aurel., *De Morb. Acut.*, lib. i., cap. 16, p. 62, 63); he recommended also violent exercise in several acute diseases. (Id., *ibid.*, lib. ii., cap. 29, p. 144.) He is said by Sprengel (*Hist. de la Méd.*) to have been the first person who made use of leeches. (Id., *De Morb. Chron.*, lib. i., cap. 1, p. 286.) He is also said to have been himself attacked with hydrophobia, and to have recovered. (Id., *De Morb. Acut.*, lib. iii., cap. 16, p. 232; Dioscor., *Theriac.*, cap. 1, p. 423.) He wrote several medical works, of which nothing but the titles remain. (Cael. Aurel., *De Morb. Chron.*, lib. i., cap. 1, p. 285; i. 4, p. 323; ii. 7, p. 387, &c.) His followers were very numerous, of whom the most eminent were Soranus [SORANUS], Thessalus [THESSALUS], Caelius Aurelianus, whose work 'De Morbis Acutis et Chronicis' is one of the most valuable of antiquity; and Moschion, author of the work *Περὶ τῶν Γυναικῶν Παθῶν*, 'De Mulierum Passionibus.'

(Sprengel, *Hist. de la Méd.*; Fabricius, *Biblioth. Græca*; Haller, *Biblioth. Medic. Pract.*; Biogr. *Médicale*; *Dict. of Greek and Roman Antiq.*, art. 'Methodici.')

* In this last passage the name is written *Μεθίσων*, which error is left unnoticed by the editor, but may readily be accounted for by recollecting that the vowels ε and η have in Romance exactly the same sound, and that for many centuries past Greek words have been pronounced by the Greeks according to the accent and not according to the quantity; so that a transcriber might easily confound two names so much alike as Themison and Methison.

† The word in the original is *σπαστά*, that is, a disorder attended with some discharge.

‡ Our author means here the *ἀκμή* of a disease, after which it increases no more.

THEMISTIUS, of Paphlagonia, was a dist orator in the fourth century after Christ, and named Euphrades, on account of his skill in fession. He was much favoured by the Roman Constantius made him a senator; Julian apprefect of Constantinople in 362, and corresponded him by letters; and although he was a heathen intrusted by Theodosius the Great with the education of his son Arcadius. In the year 384 he was a for the second time, prefect of Constantino during a period of almost forty years he was employed in embassies and other state business was the teacher of Libanius and Augustin, and a friendly intercourse with Gregory Nazianzen calls him in his letters 'the king of arguments' (ἀργύριον).

Themistius had deeply studied the writings of Aristotle; and he taught the Peripatetic philosophy well as rhetoric, at Rome and Constantinople.

Of thirty-six orations composed by him well known to Photius, thirty-three have come down the original Greek, and one in a Latin translation have reference for the most part to public affairs; several of them are panegyrics upon the emperor, the orator was patronised.

Editions of some of the orations were published by Aldus (fol. 1534), H. Stephens (8vo. 1562), R. 1605), Petau (8vo. 1613, and 4to. 1618). The complete edition is that of Harduin (Paris, 1684), which contains thirty-three orations, thirteen of which have been printed before. Another oration was discovered by Angelo Mai, and published by him at Milan. W. Dindorf also published, in 1830, two orations of Themistius, corrected from a Milan MS.

The philosophical works of Themistius consist of commentaries, in the form of paraphrases, on Aristotle's works, in Greek, and two Latin translations, one upon the work 'On Heavens' and other upon the twelfth book of the 'Metaphysics'. Paraphrases were first published in a Latin translation by Hermolaus Barbarus, 1481, which has been several times reprinted: the Greek text of them forms part of an edition of Themistius. The two commentaries were printed at Venice in 1558, 1570, and are some letters by Themistius in the collection of Stephens, 8vo. 1577.

(Schöll, *Geschichte der Griech. Litt.*, iii.)

THEMISTO, M. Guerin's name for a genus of podous Crustaceans, placed by M. Milne Edwards in the tribe of Ordinary Hyperines, the second tribe of the Hyperines.

Example, *Themisto Gaudichaudii*.

Locality.—Found by M. Gaudichaud at the Islands.

N.B.—M. Milne Edwards distinguishes from *Themisto Gaudichaudii* of Ross (*Suppl. to Sir J. Ross's Voyage*), naming it *Themisto arctica*. Capt. J. R.N., found the northern species near the western peninsula of BOOTHIA.

THEMISTOCLES (Θεμιστοκλῆς) was born about B.C. 514. He was the son of Nicocles, an Attic moderate fortune, who however was connected with a priestly house of the Lycomedæ; his mother, Euterpe, according to others, Euterpe, was not an Athenian citizen; and, according to most authorities, not a Greek, but either a native of Caria or of Thrace, education which he received was like that of all Athenians of rank at the time, but Themistocles had no taste for the elegant arts which then began to form a prominent part of the education of Athenian youths; he applied with much more zeal to the pursuit of practical knowledge. This, as well as the numerous anecdotes of his youthful wilfulness and waywardness, together with the sleepless nights which he is said to have passed in gazing on the trophies of Miltiades, are more or less symptoms of the character which he subsequently displayed as a general and a statesman. His mind was bent upon great things, and was incapable of being contented from them by reverses, scruples, or difficulties. The object of his life appears to have been to make himself great, in order that he himself might be great, and powers with which nature had endowed him were not less of perception, an accurate judgment of the

was to be taken on sudden and extraordinary emer- and sagacity in calculating the consequences of actions; and these were the qualities which Athens her wars with Persia stood most in need of. His n was unbounded, but he was at the same time per- that it could not reach its end unless Athens was among the Grecian states; and as he was not very ous about the means that he employed for these e came into frequent conflict with Aristides the ho had nothing at heart but the welfare of his ; and no desire of personal aggrandizement. In r 483 B.C., when Aristides was sent into exile by m, Themistocles, who had for several years taken an part in public affairs, and was one of the chief of the banishment of his rival, remained in the undivided possession of the popular favour, and the r, B.C. 482, he was elected archon eponymus of The city was at that time involved in a war with which then possessed the strongest navy in Greece, h which Athens was unable to cope. It was in this t Themistocles conceived and partly carried into e plans by which he intended to raise the power of

His first object was to increase the navy of ; and this he did ostensibly to enable Athens to with Aegina, but his real intention was to put his in a position to meet the danger of a second Per- asion, with which Greece was threatened. The in which he raised the naval power of Athens was hitherto the people of Athens had been accustomed e among themselves the yearly revenues of the ines of Laurion. In the year of his archonship venues were unusually large, and he persuaded his nen to forego their personal advantage, and to ese revenues to the enlargement of their fleet. His ras followed, and the fleet was raised to the number sail. (Herodot., vii. 144; Plutarch, *Themist.*, 4.) probably at the same time that he induced the ns to pass a decree that, for the purpose of keep- her navy, twenty new ships should be built every B5ckh, *Public Economy of Athens*, p. 249, Engl. 2nd edit.) Athens soon after made peace with as Xerxes was at Sardis making preparations for z Greece with all the forces he could muster. At

time Themistocles was actively engaged in allay- disputes and hostile feelings which existed among eral states of Greece. He acted however with erity towards those who espoused the cause of the , and a Greek interpreter, who accompanied the of Xerxes that came to Athens to demand earth er as a sign of submission, was put to death for nade use of the Greek tongue in the service of the enemy. After the affairs among the Greeks were r settled, a detachment of the allied troops of the was sent out to take possession of Tempe, under nd of Themistocles of Athens and Euaenetus of out on finding that there they would be over- l by the host of the barbarians, they returned to the an isthmus. When Xerxes arrived in Pieria, the eet took its post near Artemisium, on the north

Euboea, under the command of the Spartan ad- urybiades, under whom Themistocles condescended in order not to cause new dissensions among the although Athens alone furnished 127 ships, and the Chalcidians with twenty others; while the contingent was incomparably smaller. When the fleet, notwithstanding severe losses which it had l by a storm, determined to sail round the eastern hern coasts of Euboea, and then up the Euripus, to cut off the Greek fleet at Artemisium, the vere so surprised and alarmed, that Themistocles t difficulty in inducing them to remain and main- r station. The Euboceans, who perceived the ad- of the plan of Themistocles, rewarded him with of thirty talents, part of which he gave to the Eurybiades and the Corinthian Adimantus to in- m to remain at Artemisium. (Herodot., viii. 4, 5 ; l, *Themist.*, 7.) In the battle which then took e Greeks gained considerable advantage, though ry was not decided. A storm, and a second en- t near Artemisium, severely injured the fleet of ans, but the Greeks also sustained great losses, as their ships were partly destroyed and partly ren- fit for further service. When at the same time

they received intelligence of the defeat of Leonidas at Thermopylæ, the Greeks resolved to retreat from Ar- temisium, and sailed to the Saronic gulf. Xerxes was now advancing from Thermopylæ, and Athens trembled for her existence, while the Peloponnesians were bent upon seek- ing shelter and safety in their peninsula, and upon fortify- ing themselves by a wall across the Corinthian isthmus. On the approach of the danger the Athenians had sent to Delphi to consult the oracle about the means they should employ for their safety, and the god had commanded Athens to defend herself behind wooden walls. This oracle, which had probably been given at the suggestion of Themistocles, was now also interpreted by him as referring to the fleet, and his advice to seek safety in the fleet was followed. He then further moved that the Athenians should abandon the city to the care of its tutelary deity, that the women, children, and infirm should be removed to Salamis, Aegina, or Troezen, and that the men should embark in the ships. The fleet of the Greeks, consisting of 380 ships, assembled at Salamis, still under the supreme command of Eurybiades. When the Persians had made themselves masters of Attica, and Athens was seen in flames at a distance, some of the commanders of the fleet, under the influence of fear, began to make preparations for an immediate retreat. Themistocles and his friend Mnesiphilus saw the disastrous results of such a course, and the former exerted all his powers of persuasion to induce the commanders of the fleet to maintain their post: when all attempts proved ineffectual, Themistocles had recourse to threats, and thus induced Eurybiades to stay. The example of the admiral was followed by the other commanders also. In the meantime the Persian fleet arrived in the Saronic gulf, and the fears of the Pelopon- nesians were revived and doubled, and nothing seemed to be able to keep them together. At this last and critical moment Themistocles devised a plan to compel them to remain and face the enemy. He sent a message to the Persian admiral, informing him that the Greeks were on the point of dispersing, and that if the Persians would attack them while they were assembled, they would easily conquer them all at once, whereas it would otherwise be necessary to defeat them one after another.

This apparently well-meant advice was eagerly taken up by the enemy, who now hastened, as he thought, to destroy the fleet of the Greeks. But the event proved the wisdom of Themistocles. The unwieldy armament of the Persians was unable to perform any movements in the narrow straits between the island of Salamis and the main- land. The Greeks gained a most complete and brilliant victory, for they only lost forty ships, while the enemy lost two hundred; or, according to Ctesias, even five hundred. Very soon after the victory was decided, Xerxes with the remains of his fleet left the Attic coast and sailed towards the Hellespont. The battles of Artemisium and Salamis occurred in the same year, 480 B.C. [SALAMIS.]

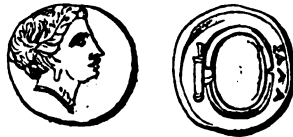

Coin of Salamis.

British Museum. Actual Size. Silver

When the Greeks were informed of the departure of Xerxes, they pursued him as far as Andros without gain- ing sight of his fleet, and Themistocles and others pro- posed to continue the chase. But he gave way to the opposition that was made to this plan, and consented not to drive the vanquished enemy to despair. The Greek fleet therefore only stayed some time among the Cyclades, to chastise those islanders who had been unfaithful to the national cause. Themistocles, in the meantime, in order to get completely rid of the king and his fleet, sent a mes- sage to him, exhorting him to hasten back to Asia as speedily as possible, for otherwise he would be in danger of having his retreat cut off. Themistocles availed him- self of the stay of the Greek fleet among the Cyclades for the purpose of enriching himself at the cost of the islanders, partly by extorting money from them by way of punish- ment, and partly by accepting bribes for securing them impunity for their conduct. His fame, however, spread over all Greece, and all acknowledged that the country had

been saved through his wisdom and resolution. But the confederate Greeks, actuated by jealousy, awarded to him only the second prize; at Sparta, whither he went, as Herodotus says, to be honoured, he received a chaplet of olive-leaves,—a reward which they had bestowed upon their own admiral, Eurybiades,—and the best chariot that the city possessed, and on his return 300 knights escorted him as far as Tegea in Arcadia.

When the Persian army had been again defeated at Platææ and Mycææ, in B.C. 479, and when the Athenians had rebuilt their private dwellings, it was also resolved, on the advice of Themistocles, to restore the fortifications of Athens, but on a larger scale than they had been before, and more in accordance with the proud position which the city now occupied in Greece. This plan excited the fear and jealousy of the rival states, and especially of Sparta, which sent an embassy to Athens, and under the veil of friendship, which ill concealed its selfish policy, endeavoured to persuade the Athenians not to fortify their city. Themistocles, who saw through their designs, undertook the task of defeating them with their own weapons. He advised his countrymen to dismiss the Spartan ambassadors, and to promise that Athenian envoys should be sent to Sparta to treat with them there respecting the fortifications. He himself offered to go as one of the envoys, but he directed the Athenians not to let his colleagues follow him, until the walls, on which all hands should be employed during his absence, should be raised to such a height as to afford sufficient protection against any attack that might be made upon them. His advice was followed, and Themistocles, after his arrival at Sparta, took no steps towards opening the negotiations, but pretended that he was obliged to wait for the arrival of his colleagues. When he was informed that the walls had reached a sufficient height, and when he could drop the mask with safety, he gave the Spartans a well-deserved rebuke, returned home, and the walls were completed without any hindrance. He then proceeded to carry into effect the only thing which remained to be done to make Athens the first maritime power of Greece. He induced the Athenians to fortify the three ports of Phalerum, Munychia, and Piræus, by a double range of walls, and to connect the Piræus by long walls with the city of Athens. [ATHENS.]

When Athens was thus raised to the station on which it had been the ambition of Themistocles to place it, his star began to sink, though he still continued for some time to enjoy the fruits of his memorable deeds. He was conscious of the services he had done to his country, and never scrupled to show that he knew his own value. His extortion and avarice, which made him ready to do anything, and by which he accumulated extraordinary wealth, could not fail to raise enemies against him. But what perhaps contributed more to his downfall was his constant watchfulness in maintaining and promoting the interests of Athens against the encroachments of Sparta, which, in its turn, was ever looking out for an opportunity to crush him. The great men who had grown up by his side at Athens, such as Cimon, and who were no less indebted to him for their greatness in the eyes of Greece than to their own talents, were his natural rivals, and succeeded in gradually supplanting him in the favour of the people. They also endeavoured to represent him as a man of too much power, and as dangerous to the republic. The consequence of all this was, that in 472 B.C. he was banished from Athens by the ostracism. He took up his residence at Argos, where he was still residing when, in the same year B.C. 472, Pausanias was put to death at Sparta for his ambitious and treacherous designs, and his fate involved that of Themistocles. [PAUSANIAS.] The Spartans, in their search to discover more traces of the plot of Pausanias, found a letter of Themistocles, from which it was evident that he had been acquainted with his plans. This was sufficient for the Spartans to ground upon it the charge that Themistocles had been an accomplice in his crime, and ambassadors were forthwith sent to Athens to demand that he should suffer the same punishment as Pausanias. This charge was no less welcome to his enemies at Athens than the discovery of his letter had been to the Spartans. Orders were consequently issued to arrest and convey him to Athens. But he had been informed in time of the proceedings at Athens, and foreseeing that his destruction would be unavoidable if he should fall into the hands of

his enemies, he fled to Coreyra, and thence to the coast of Epirus, where he took refuge at the court of Admetus, king of the Molossians. On his arrival, the king was absent, but his queen Phthia received him kindly, and pointed out to him in what manner he might win the sympathy of Admetus. When the king returned home, Themistocles, seated on the hearth and holding the child of Admetus in his arms, implored the king not to deliver him up to his persecutors, who traced him to the court of the Molossians. It is stated that Themistocles was here joined by his wife and children. The king not only granted his request, but provided him with the means of reaching the coast of the Ægean, whence he intended to proceed to Asia, and seek refuge at the court of the king of Persia. From Pydna he sailed in a merchant ship to the coast of Asia Minor. At Ephesus he received such part of his property as his friends had been able to wrest from the hands of his enemies at Athens, together with that which he had left at Argos. A few months after his arrival in Asia, Xerxes was assassinated (B.C. 465), and was after a short interval succeeded by Artaxerxes. Various adventures are told of Themistocles before he reached the residence of the Persian king. On his arrival he sent him a letter, in which he acknowledged the injuries he had inflicted upon his predecessor, but at the same time claimed the merit of having saved him from destruction, and offered him his timely advice. He added that his presence at Athens was only the consequence of his great zeal for the interests of the king of Persia. He did not ask for an interview with the king, as he was yet unacquainted with the language and the manners of the Persians, to acquire which he requested a year's time. During this period, he himself so zealously and with such success to these ends that at the close of the year, when he was presented to the king, he is said to have excited the jealousy of courtiers, and was most kindly received by the king, whom he held out prospects of conquering Greece with his assistance. The king became so attached to Themistocles he was always in his company. After he had spent several years at the court, he was sent to the coast of Asia Minor, to wait there for an opportunity of carrying his promises into effect. A pension was now granted to him after the Oriental fashion: three talents were given him, of which Magnesia on the Maeander was to supply him with bread, Myus with meat, and Lampsacus with wine. He took up his residence in the first of these cities, where he lived with a sort of princely rank. Darius overtook him at the age of sixty-five, before any of his plans were carried into effect. Most of the ancient writers state that he put an end to his life by poison, or, according to another strange story, by drinking the blood of a bull, because he despaired of being able to fulfil his promises to the king. The motive for his suicide is questionable. Reflections on his past life and upon the glory of his former rivals at Athens are much more likely to have rendered him dissatisfied with life. Before he died he is said to have requested his friend to bury his remains secretly to Attica, and in later times a tomb which was believed to contain them existed in the market-place of Magnesia a splendid monument was erected to his memory, and his descendants in that place continued to be distinguished by certain privileges down to the time of Plutarch.

(Herodotus, vii. 143, &c.; viii. 4, &c.; Thucyd. i. 14, 135, &c.; Plutarch, *Themistocles*; Diodorus Siculus, ii. 2, 12, &c.; C. Nepos, *Themistocles*; Pausanias, i. 1, &c.; compare Thirlwall, *History of Greece*, vol. ii.)

THEMISTOGENES. [XENOPHON.]

THENARDITE.—*Anhydrous Sulphate of Soda*—crystallized. Primary form a right rhombic prism; age parallel to the primary planes; colour white to greyish; transparent; translucent; opaque; soluble in water; effloresces on the surface; specific gravity 2.73.

It occurs in crystalline coatings at the bottom of lakes, at a place called Les Salines Espartines, a league from Madrid; it is used in the preparation of carbonate of soda. According to the analysis of C.

Sulphate of soda	99.78
Carbonate of soda	0.22

100-

THIENUS, Dr. Leach's name for a genus of

ins, formed at the expense of *Scyllarus* of authors. RIANs, vol. xxi., p. 134.]

BALD, LEWIS, was born at Sittingbourne, in Ve have no record of the date of his birth. His is an attorney, and he was bred to his father's

His first literary production was 'Electra,' a which appeared in 1714. As the writer of twenty fferent plays, he is utterly forgotten. Those belong to an age in which the true spirit of draetry was for the most part lost, and Theobald none of those brilliant qualities which could lengthened existence to his attempts in porhe manners of his age. But he has attained a of another description. He is most commonly the unhappy dunce whom Pope assailed with the eterate ridicule; but, after a century of prejudice is name, he is now pretty generally acknowledged eserved an honourable reputation as an editor of a, having brought to that task diligence, knowid judgment, beyond comparison superior to the lents of his rival the author of the 'Dunciad.' eminence' as the original hero of that poem was a pamphlet in which he pointed out many of of Pope's Shakspeare. 'Shakspear Restored, or s of Blunders committed and unamended in lition of this Poet,' was published in 1726. The e which Pope took of this pamphlet was in his dition of Shakspeare, which appeared in 1728. e publication of our first edition, there having e attempts upon Shakspeare published by Lewis (which he would not communicate during the rein that edition was preparing for the press, by public advertisements, did request the assistll lovers of this author), we have inserted in this n as many of 'em as are judged of any the least to the poet; the whole amounting to about e words.' In the same year came out the . The revenge of Theobald was the severest l be inflicted, and it was unexceptionable. In roduced an edition of Shakspeare which utterly that of Pope. It has been asserted that of 's edition, which was in seven volumes, 8vo., rteen thousand copies were sold. (Steevens's ear,' 1793, vol. i.) In his preface Theobald thus e attacks of his distinguished rival: 'It is not secret pleasure that I so frequently animadvert pe as a critic, but there are provocations which ver quite forget. His libels have been thrown so much inveteracy, that, not to dispute whether ld come from a Christian, they leave it a quesher they could come from a man. I should be ubt, as Quintus Serenus did in a like case,

"Sive homo, seu simillix turpissima bestia nobis
Vulnere dote dedit."

nation, perhaps, for being represented a blockbe as strong in us as it is in the ladies for a re- to their beauties. It is certain I am indebted to me flagrant civilities; and I shall willingly det of my life to the honest endeavour of quitting with this exception, however, that I will not se civilities in his peculiar strain, but confine least, to the limits of common decency. I shall it better to want wit, than to want humanity; rtial posterity may perhaps be of my opinion.' feared that it was rather a new hatred than a justice, however tardy, which induced Pope in dethrone Theobald from the heroship of the 'setting up Colley Cibber in his place. In the t year both Pope and Theobald were at peace; for ever silenced their controversy. Theobald ptember, 1744. On the 20th of the following his library, which included 295 old English sold by auction. He had collected these pronow so rare and highly valued, at a time when drama was neglected, if not despised; and he dicious use of them in his edition of Shakspeare. speak of his edition with commendation, we of k at those things which are of permanent value we pass over those ebullitions of offended pride, self in self-commendation and acrimonious obhich were natural to one who had been so hunted is Theobald had been. Dr. Johnson says that 'by the good luck of having Pope for his

enemy, has escaped and escaped alone with reputation from this undertaking [the undertaking of editing Shakspeare]. So willingly does the world support those who solicit favour against those who command reverence, and so easily is he praised whom no man can envy.' This, we think, is mere phrase-making, and does not represent the world's opinion of any man at any period: reputations are not made upon the compassion of the world. Johnson has, a little before, stated the case with greater correctness, although not wholly correct. 'Pope was succeeded by Theobald, a man of narrow comprehension, and small acquisitions, with no native and intrinsic splendour of genius, with little of the artificial light of learning, but zealous for minute accuracy, and not negligent in pursuing it. He collated the ancient copies, and rectified many errors. A man so anxiously scrupulous might have been expected to do more, but what little he did was commonly right.' The great merit of Theobald as an editor is that he did not attempt too much, that he did not 'do more,' and that *therefore* he was 'commonly right.' The great fault of nearly all the editors of Shakspeare has been that they set themselves up above their author; that they would exhibit their own 'native and intrinsic splendour of genius' in the improvement of what they did not understand, and the adaptation of the verse of Shakspeare to the standard of another age. The most happy emendations of Shakspeare, almost the only admissible ones, have been produced by the caution of Theobald. In his own preface he says, 'I have not by any innovation tampered with his text, out of an ostentation of endeavouring to make him speak better than the old copies have done;' and then he adds, 'Where, through all the former editions, a passage has laboured under flat nonsense and invincible darkness, if, by the addition or alteration of a letter or two, or a transposition in the pointing, I have restored to him both sense and sentiment, such corrections, I am persuaded, will need no indulgence.' All subsequent editors have a debt to Theobald which has not always been acknowledged. Johnson himself says, 'I have sometimes adopted his restoration of a comma, without inserting the panegyric in which he celebrated himself for his achievement.'

There is a curious matter connected with the history of Theobald, which needs here only a slight mention. In his edition of Shakspeare in 1728, he printed a play, 'The Double Falsehood,' as an original by William Shakspeare, it having been a short time before produced on the stage. The play was stated to have been found in manuscript. One passage, which is certainly not in the manner of Shakspeare, is said to have been particularly admired:—

'Strike up, my masters;
But touch the strings with a religious softness:
Teach sound to languish through the night's dull ear,
Till melancholy start from her lazy couch,
And carelessness grow covert to attention.'

The admiration was too much for the vanity of Theobald: he came forward to state that he certainly had written those lines, but that all the rest was genuine Shakspeare. Dr. Farmer holds that 'The Double Falsehood' was not Shakspeare's because the word *aspect* was wrongly accented, that is, not as *aspèct*, according to the usage of Shakspeare and of his time; and he holds the play to be Shirley's. It is not worthy even of that writer. The probability is that Theobald had a greater hand in the matter than he was subsequently willing to acknowledge. The restless vanity and love of notoriety which, according to his own account, impelled Psalmanazar to his impostures, has perhaps in nearly every case been the great motive to literary forgery. Theobald was the author of a Life of Sir Walter Raleigh; and he also wrote the greater part of the periodical papers entitled 'The Censor,' which appeared as a separate work in 1717, having been previously published in Mist's 'Weekly Journal.'

THEOBALDUS, a bishop who probably lived in France, and whose name is sometimes written *Tebaldus* or *Tybal-dus*, the reputed author of a didactic and theological poem entitled 'Physiologus de Naturis Duodecim Animalium.' It is written in hexameter, sapphic, and other kinds of verse, and describes first some one or more of the natural habits of twelve different animals, and then draws from each some moral and religious reflections. The twelve animals chosen are the lion, eagle, serpent, ant, fox, stag, spider, whale, siren and centaur, elephant, dove, and panther; and the whole poem appears to be borrowed in a great measure

from the little work in prose by Epiphanius on the same subject. The poem begins thus:—

Tres leo naturas et tres habet inde figuras,
Quas ego, Christe, Tibi bis seuo carmine scripsi.
Altera divini memorant animalia libri,
De quibus apposuit quis rursus mystica novi,
Tentans diversas si possem scribere metris.
Nec numerum nostrum complent simul addita solum,
Nam leo stans fortis super alta cacumina montis,' &c.

And ends thus:—

Coelos ascendens ubi regnat cum Patre praesens
Quem gentes cunctas sic sunt credendo secutas
Aut fugit atque latet nec in ipso tempore parat
Serpens antiquus, qui nobis est inimicus:
Namque palam nullos licet audeat fallere multos
Nos hinc defendet, qui secula per omnia regnat.
Carmine finito sit laus et gloria Christo,
Cui si non alii placeant haec metra Tibaldi.'

The last two verses are not to be found in the old editions, but only in Beaugendre's edition of the works of Hildebert. With respect to the author of the poem, as it is found in a Paris manuscript of the thirteenth century, containing the works of Hildebert, archbishop of Tours (who lived in the twelfth century), and has also been ascribed to Hildebert himself, he may be supposed to have lived some time in the twelfth century, or even as early as the eleventh, if he is the person meant in an epitaph on *Magister Theobaldus Dervensis*, written by Hildebert. (Hildebert, *Opera*, p. 1322, edit. Beaugendre.) The first edition of this work to which a date is attached is that of Antwerp, 1482, 4to., but five others are enumerated by Choulant (*Handbuch der Bücherkunde für die Aeltere Medicin*), which were probably printed before this year. The last edition, in a separate form, was published at Leipzig, 1510, 4to.; but it is inserted in 'Hildeberti Cenomanensis Episcopi, Turonensis Archiepiscopi, Opera,' edit. Ant. Beaugendre, Paris, 1708, fol., and erroneously attributed to Hildebert. The *Prooemium* and the chapter *De Elephantis* are inserted by Freytag in the 'Analecta Litteraria de Libris Rarioribus,' Lips., 1752, 8vo. In some of the old editions there is appended to the poem a theological commentary, written in the style of the scholastic philosophy of the middle ages: the author is unknown, but it was not composed by Theobaldus himself. (Choulant, *loco cit.*)

THEOBROMA (from *θεός* and *βρώμα*, the food of gods), the name of a genus of plants belonging to the natural order Sterculiaceae, the species of which yield the cocoa of commerce. They are trees with large simple leaves and with the flowers in clusters. The calyx is composed of 5 sepals; the petals are 5, lengthened into a strap-like form at the apex; the stamens are 5, each with double anthers and a horn-like appendage between each filament; the style is filiform, with a 5-parted stigma; fruit a 5-celled capsule without valves; seeds embedded in a soft pulp; no albumen, and thick oily wrinkled cotyledons.

T. Cacao, Common Cacao or Chocolate-nut tree, has entire, elliptic, oblong, acuminate, quite smooth leaves, and oblong smooth fruit. This tree is indigenous in South America, and is generally found at a height of 600 feet above the level of the sea. It is however extensively cultivated in the West Indies, and in the tropical parts of Asia and Africa. The Mexicans call the tree *chocolatl*, hence our word chocolate for the prepared seeds. The capsules of the fruit are large, and contain each about 25 seeds; the pulp in which these are enveloped has a sweet and not unpleasant taste, and is frequently eaten where the tree is grown. The trees are evergreens, and bear fruit and flowers all the year through, but the usual times for gathering the fruit are in June and December. The cotyledons of the seeds contain a large quantity of oily albumen, which has an agreeable flavour, and on this account they are not only used as a principal article of diet by the natives of the countries in which they grow, but are now used for the same purpose throughout the civilized world. The composition of these seeds, in which amylaceous matter is combined with oil, and a principle probably similar in its constitution to Thein and Caffein, is well adapted, when combined with sugar, to form a valuable article of diet. The consumption of them for this purpose is already on the increase, and under the present greatly decreased rate of duty will probably go on in a greater ratio. The following are the quantities consumed in this country since 1836:—

1836	.	.	1,130,168 lbs.
1837	.	.	1,416,613
1838	.	.	1,601,747
1839	.	.	1,606,900
1840	.	.	2,045,478
1841	.	.	1,930,764

Before the alteration of the tariff in 1842, the cocoa from British possessions was 2*d.*, and from other countries 6*d.* per lb.; now reduced to 1*d.* per lb. husks and shells the duty was $\frac{1}{2}$ *d.* and 1*d.*, and remained unaltered. The duty on cocoa paste and chocolate was 4*d.* per lb. from British possessions, and 4*s.* 4*d.* from foreign countries, has been reduced in the former to 2*d.*, and in the latter to 6*d.* per lb. The duty cocoa under the old tariff was nearly prohibitory.

The chocolate of different countries varies according to its mode of preparation and the ingredients employed. The most common form however in which they are consumed in this country is what is called cocoa. It consists of the seeds pressed into flakes or reduced to a paste. It is to this paste whilst hot that the honey, and other things are added, which constitute it chocolate. The paste is frequently adulterated. Hogs' lard is added to make up weight, and red lead to give it a red colour. On this account the flake-cocoa is the best to be used.

The largest quantity of the seeds that are imported into this country are brought from the West Indies. The seeds of the Trinidad nuts are considered the best. In 1841, 1,600,000 lbs. of cocoa consumed in 18 months came from the West Indies, 375,000 from the West Indies, 186,000 from Brazil, and 133,000 from Chili.

The oil contained in the seeds is sometimes obtained separately, and called cocoa butter. It may be obtained easily by expression, especially if hot water is used. It is said to be very nutritive, and to act as an anodyne. It is particularly recommended for making ointments. (Gruber, *Allgem. Encycl.*, art. 'Cacao'.)

In the cultivation of the Cacao a wet soil must be selected, as, wherever planted, if it has not a sufficient quantity of water it perishes. The plants also require on this account in Trinidad and other islands of the West Indies the seeds are placed between rows of *T. umbrosa*, one, two, or three rows of the latter being planted between the *Erythrinas*. In sowing the seeds are placed two or three together in the rows, and two yards distant in the rows; and when the plants are about two feet high, all except the strongest are removed. In rearing them the only further care necessary is to remove the weeds. If this be not attended to, the plants will not flourish.

There are several other species of *Theobroma* which possess the properties of the above, but are not cultivated or employed to the same extent. All of them natives of South America, and used by the inhabitants where they grow as food. The *Guazuma* of Linnæus, the Bastard Cedar or Orange-tree, now the *Guazuma ulmifolia*, is a native of the West Indies, and is a handsome tree resembling the *Theobroma*. It has ovate, oblong leaves, smooth on both sides. The Jamaica cattle eat its leaves when fodder is scarce. The pods have a sweet flavour like green figs, and are frequently eaten in the West Indies. Its wood is used by coachmakers on account of its lightness. The bark yields a mucilaginous decoction, which is of much value in elephantiasis and in diseases of the skin. (Don's *Miller's Dictionary*; *Dictionnaire des Sciences Naturelles*; *Parliamentary Reports*.)

THEOBROMA. (*Cocoa and Chocolate*.) This genus consists of 10 species, 7 of which yield articles of commerce. The natives of South America and the West Indies also found in the Philippine Isles. It is the source of the cocoa to the species described by Linnaeus, *Theobroma Cacao* (*Theobroma sativa*, Lamour.). It yields only a small portion of this most valuable article, and none of that used in Mexico, where *Theobroma Cacao* does not even grow. Besides this species, the following furnish some of the different kinds, viz.: *T. sum*, Willdenow; *T. subincanum*, Mart.; *T. ovalifolium*, Mart. The Mexican cocoa is conjectured by Don to be yielded by *T. angustifolia* and ovalifolium from some undescribed species. That yielded by a species called by the natives of the

on, which is cultivated like the *T. Cacao*. The of Guiana is yielded by the *T. Guianensis*. (Aublet.) fruits are collected both from wild and cultivated ; from the latter two harvests are obtained, from the former one only. The cultivation is easy and unexpensive. The tree begins to bear about the age of seven or eight years, and one slave can superintend a thousand trees, the produce of which however is not more than from 1000 to 1600 lbs. of seeds. The statement of Labat is exaggerated—that a tree in full vigour will produce 1000 lbs. of seeds. Notwithstanding the small return from the tree, it is a very lucrative branch of culture. The yield is always greatest after the greatest floodings of the rivers. The seeds from the wild plants are termed by the native Brazilians *cacao bravo* or *cacao do Mato*.

The seeds of the different species vary in size, form, and number of the seeds they contain. The seeds, which are the only part employed, vary in size and quality according to the species from which they are obtained. The smallest number is from twenty-five to thirty in each fruit, but is more abundant, as well as of better quality, in the wild than in the cultivated plants. They vary much in richness and in the quantity of oil they yield, not only according to the species from which they are obtained, but in the manner in which they are treated after being separated and taken out of the pulpy fruit. In some instances they are buried in the earth in heaps, and allowed to ferment for thirty or forty days; a process which greatly ripens them, and destroys the germinating power of the seeds.

The different kinds met with in commerce derive their names either from the place where they grew or from the corruption of the native designation. The average value of good beans is that of a sweet almond, but somewhat thicker. The most esteemed of the known sorts is termed *Socconuzco*, or Mexican, with very small beans, of a remarkably fine flavour, and scarcely any acrid taste.

These beans are always buried. This sort never comes to Europe. The next most valuable comes from the *Saldas*, and has a very agreeable flavour: the chocolate prepared from it has a golden colour; it is seldom met with out of Mexico. The Guatemala cocoa consists of large beans, very convex, often angular, and very hard pointed at the one end. They contain much oil, and are mild, with a pleasant flavour. The beans from the *Aquil*, which are three times as large as those of *Socconuzco*, are less prized than those of Guatemala.

The Caracas or New Granada cocoa, which is among the most highly prized kinds that reach Europe, is obtained from the *Theobroma bicolor* (Humboldt, *Pl. Aequin.*, p. 100), called by the natives *Bacao*, and cultivated at Caracas. The beans are of medium size, and very oily. But the plate made of these alone is not very agreeable, and the other kind is commonly mixed with them, which are smaller and harder. Berbice cocoa beans are not so frequently mingled with those of Granada. These are smaller and thinner, but in other respects difficult to distinguish; the shell separates very easily from the kernel, which is reddish-brown, and has a strong smell, but a pleasant flavour.

The Surinam and Essequibo cocoas are not unlike that of New Granada, but are harder, thicker, and not so

as the foregoing are earth-dried: the following are sun-dried, being merely collected in heaps, and turned over in the sun; they are consequently much more per-

razilian, called also of Para, and of Maranham, is very extensively employed: the beans are small, smooth, long, somewhat flattened, externally reddish-brown, with a bitter pungent taste: it is only worth half the amount of the West Indian.

The West Indian, called *Cocao des Iles* or *des Indes*, is still less valuable, and is employed to form the cheapest cocoas and chocolates.

Amplius has analyzed the West Indian kernels, and found them to consist of, in the 100 parts, besides water, 10 of fat or oil, 16.7 of an albuminous brown matter, 10.9 contains all the aroma of the bean, 10.91 of starch, 1.5 of gum or mucilage, 0.9 of lignine, and 2.01 of a dye-stuff, somewhat akin to the pigment of cochineal.

These proportions vary very much in the different West Indian kinds containing far more of the butter of cocoa than the kind from New Granada. It is therefore most advantageous to employ the latter to P. C., No. 1527.

form cocoa or chocolate for nutriment, and the other to yield this solid oil, to form candles, soap, or pomades. This oil contains a large proportion of stearine, and is therefore solid at the ordinary temperature of the air, but it melts at 122° Fahr. When purified by long boiling in water, it is perfectly white, and does not readily become rancid. It is perfectly soluble in æther, a means of detecting adulterations with beef-fat, suet, marrow, or almond oil, wax, &c. It is however less employed in this country than in France. Nevertheless it is a most valuable material, and a soap made with it and soda, which is preferable to potash, forms an article for the toilet of great service to those who are troubled with a rough harsh skin or chapped hands. The soap sold in this country under the name of *cocoa-nut oil* must not be confounded with that just spoken of, as this is obtained from the *Cocos nucifera*. The cocoa-nut-oil candles are likewise prepared from the latter.

The kernels of the *Theobroma* are used as an article of nutriment either in the natural state as they are received from America or prepared in various ways. The simplest and best form is that of the seeds roughly crushed, termed *cocconibs*, which however require two hours boiling, as, owing to the peculiar nature of the endosperm, or inner seed-coat, which passes down into the substance of the cotyledons, the prolonged application of heat and moisture is necessary to dissolve the contents. Flake cocoa is merely the seeds crushed between rollers. When chocolate is to be made, the beans, after being carefully picked so as to free them from mouldy or worm-eaten ones, are to be gently roasted over a fire in an iron-cylinder, with holes in the ends to allow the vapour to escape. When the aroma begins to be well developed, the process is considered complete. The beans are then turned out, cooled, and freed by fanning and sifting from their husks. The husks, which often amount to 20 or 25 per cent. of the beans employed, should not be thrown away, as they contain half their weight of soluble matter of a mucilaginous nature, which furnishes a tolerable nutriment for the poor. The seeds are then to be converted into a paste, either by trituration in a mortar heated to 130° Fahr., or now almost universally by a machine impelled by steam. (See *Ure's Dictionary of Arts, &c.*, p. 293.) The paste is then put into moulds and sent into the market. It always improves by keeping. The colour is said to be owing to the addition of annatto, but this is probably a mistake, for if the South American contain as much colouring-matter as the West Indian, any extraneous pigment is unnecessary. When the kernels alone are used, or only a little sugar added, the chocolate is termed '*Chocolat de santé*.' But vanilla, cloves, cinnamon, and other aromatics are frequently added; as are also rice, almonds, starch, &c. Simple chocolate is mostly preferred in Britain, the perfumed sorts in France, Italy, and Spain, in which countries the consumption is immense. For invalids the plain chocolate is best, the perfumed being too heating. Where tea and coffee disagree, cocoa or chocolate is the best substitute. It is complained that it proves heavy and disturbs the stomach, and not unfrequently causes headaches. In almost all instances this arises from making the beverage too strong. The printed directions order far too much of the substance to be employed. Half the quantity is sufficient. The Spaniards do not reckon chocolate very nutritious, and even permit the priests, who should fast for many hours before saying mass, to drink it. But this is a very convenient mistake. Schrader, who analyzed cocoa, regarded the bitter principle as similar to *caffein*. The analysis of Theobromine by Woskresensky shows how nearly he was correct, and also that this article, being one of the most highly azotised vegetable compounds, must be highly nutritious. Liebig considers that this principle contributes to the formation of bile, like thein. [THEA; THEIN.]

THEOCRACY (*Theopatria*, a government by God) is a term applied to the constitution of the Israelitish government, as established by Moses, on account of its being under the direct control of God. Michaelis enumerates the following particulars as those in which the theocratic form of government is most remarkable:—1. The laws of the Israelites were given by God. 2. The judges are represented as holy persons, and as sitting in the place of God. 3. The judges were usually taken from the tribe of Levi, and the chief expounder of the law was the high-priest. 4. In difficult cases of law, relating both to

government and war. God was to be consulted by Urim and Thummim. 5. In matters which concerned the welfare of the state, God often made his will known by prophets, and the people were of course bound in duty to obey their voice. 6. God bound himself by promises and threatenings to reward them with prosperity, victory, and plenty, if they kept the law of Moses, and to punish them with defeat, and other public calamities, if they disregarded it.

In fact, in the earliest form of the Israelitish constitution, *God was their king*; and the desire of the people to have a king at the time when Saul was raised to that office is expressly declared to be an act of rebellion on their part. (1 *Sam.*, viii. 7.)

The theocracy did not supersede the establishment of a visible human government, consisting of judges and other officers, but all these officers were considered as subordinate to God as the only supreme ruler of the state. [Compare *Moses*, p. 439-441.]

(Michaelis, *Commentaries on the Laws of Moses*, sec. 35, Eng. trans.)

THEOCRITUS (Θεόκριτος) was a son of Simichidas, or, according to others, of Praxagoras and Philinna. He was a native of Syracuse, where he also spent the greater part of his life. He is said to have been connected with Philetas of Cos and Asclepiades of Samos, and to have been their pupil, whence we may infer that he visited these islands. He was on very intimate terms with Aratus the poet, and it is highly probable that he formed this acquaintance in the island of Cos. (Wüstemann, *Argument. ad Theocrit. Idyll.*, vii.) His exact period is not known, and we can only say that he lived in the reign of Ptolemaeus, the son of Lagus, and Ptolemaeus Philadelphus, and that the time of his greatest reputation was about the year B.C. 277. Some years before this time, probably about B.C. 284, he had visited Alexandria, and the influence of the court of that city is manifest in several of his poems. It has further been supposed that he spent some time at Croton in Southern Italy, because the scene of three of his poems is laid in that place. Beyond these circumstances, which are little more than probabilities, we know nothing of the life of Theocritus. The Alexandrine grammarians valued his works very highly, and assigned to him the second place in the pleiad of the seven miscellaneous poets, which comprised Lycophron, Theocritus, Callimachus, Aratus, Apollonius Rhodius, Nicander, and one Homer, the son of Moero of Byzantium. Several Greek grammarians also wrote commentaries on the works of Theocritus, some fragments of which are still extant in the scholia on his poems. There is extant by Theocritus a collection of various poems, which are written in what the Greek grammarians call the new Doric dialect, which is softer than the old Doric, and the softness of this new Doric is still increased in the poems of Theocritus by the admixture of epic and Ionic or Aeolic forms. The particular species of poetry by which he has acquired most celebrity are the Bucolics (μυθη βοσκοτικά). This pastoral poetry was very popular in Sicily, and having been originally cultivated by shepherds and rustics, was raised to a really artistic rank by several poets before Theocritus. He however brought this kind of poetry to perfection, and the ancient critics regard him as the model of bucolic poetry, and Virgil for this reason calls this poetry Syracusean (*Eclog.*, vi. 1). But the number of real bucolic poems still extant in the collection which bears the vague name of Idyls (ἰδέλλια), is only ten; the remaining twenty poems are either epic poems (such as idyl xiii., xxii., xxiv., and xxv.), or imitations of mimes (such as idyl ii. and xv.), or are of a mixed nature, and belong either to the lyric kind, or are mere exercises of a poetical imagination. Nine of these poems, xiii., xvii., xviii., xix., xx., xxvi., xxvii., xxix., and xxx., and some portions of others, have been considered by modern critics not to be the work of Theocritus: as to some there can be no doubt that they are spurious, though they are not without great poetical merit, if we except idyl xxx. Besides these thirty idyls, there is a fragment of one poem called 'Berenice,' and twenty-two epigrams, which are ascribed to Theocritus.

All the poems which are genuine productions of Theocritus show him to have been a perfect master of his art. His power over the language is not less wonderful than his taste for the simple beauties of nature, and the skill with which he handled his subjects. His poems are indeed

founded upon the national shepherd songs of Sicily in the form of dialogues, but he has added features of his own, and idealized his persons, without depriving them of their natural simplicity. We do not know whether Theocritus himself ever published a collection of his poems, but from an epigram in the 'Anthologia Graeca' iv. n. 267, we might rather suppose that the collection was made by Artemidorus, the author of that epigram. It is however a curious fact that none of the MSS. of Theocritus contain all the poems which are published in our modern printed editions under his name. The editio princeps, which appeared at Milan in 1493, fol., only contains eight poems of Theocritus, with the works of Hesiod and Isocrates. The most important among the subsequent editions are that of J. J. Reiske, with a Latin translation, the Greek scholia and notes, Leipzig, 1765, 2 vols. 4to.; Thomas Warton with additional scholia and notes, Oxford, 1770, 2 vols. 4to.; Valckenauer, Leyden, 1779 and 1781. The edition of Valckenauer, which also contains the poems of Bion and Moschus, is still valuable. In 1773 Valckenauer had published an excellent edition of select idyls of Theocritus. His complete edition was reprinted at Berlin, 1810, 2 vols. 8vo., with additional notes by Brunck and Toup. After these followed the editions of Schaefer, Leipzig, 1810; Kiessling (Leipzig, 1819) and J. Geel, Amsterdam, 1821, 8vo. The last edition, which is very useful to students, is by E. F. Wüstemann, Götting and Erfurt, 1844, in 2 vols. 8vo. The introductory essay gives a good account of the literature of Theocritus. The works of Theocritus have been translated into all the languages of modern Europe. There is an English translation by Fawkes, 1767, and a translation, including Bion and Moschus, by Polwhele, 4to., 1786, and in 2 vols. 12mo., 1811. The best French translation is that of J. B. Gail, with explanatory and critical notes, Paris, 1808, 3 vols. 4to. The best German translations are those of J. H. Voss (Tübingen, 1808, 8vo.) and Witter (Hildburghausen, 1819, 8vo.). Respecting the character of the poems of Theocritus see Eichstädt, *Alumbratio Quaestionum de Carminum Theocriteorum ad Genera sua Revocatorum Indole ac Virtutibus*, Lipsiae, 1793, 4to.; and Reinhold, *De Theocriti Carminibus Genuinis et Supposititiis*, Jena, 1819, 8vo.

THEODOLET, or **THEODOLITE** (the word is found in both forms), is the name generally given to the instrument used for measuring horizontal angles. In its simplest form the theodolite consists of a divided circle, which is to be set parallel with the horizon, and a telescope which has so much motion in a vertical plane as to enable the observer to view any object which he may require above or below the horizon. The derivation of the word is obscure, although the instrument and its name are comparatively of recent date. The earlier observers did indeed use divided circles, which they called astrolabes, armillas, &c., for the purposes of surveying, but these were generally speaking, very rude. The quadrant was employed in all accurate surveys up to the latter half of the last century, although Roemer had shown by reason and example the superiority of the entire circle. [CIRCLE.] The first instance of a survey conducted with an entire circle, on a considerable scale, was, so far as we recollect, the Survey of Zealand by Bugge,* in 1762-8. The horizontal circle was two feet in diameter, and constructed by the Danish artist Ahl.

Ramsden finished his great theodolite in 1785, the circle of which is three feet in diameter. This was used for a triangulation, to connect the Observatories of Greenwich and Paris. A very full description of it is given in *An Account of the Operations carried on for accomplishing a Trigonometrical Survey of England and Wales*, London, 1799, pp. 107-130, with four plates: a reprint, as a great measure, from the 'Phil. Trans.', vol. 80 et seq. The principal triangles of the English, Irish, and Indian surveys have been observed with this instrument or with those nearly identical in size and construction; and though several minor additions and improvements have been made, the great theodolite is still considered by the officers of the survey as a most efficient and almost infallible instrument. We believe that the high reputation of the great theodolite depends in a great degree on the superstitious case with which it has been used and preserved: it is undoubtedly a very fine, well-divided

* See Bugge's 'Observationes Astronomicae,' p. 54, where he gives a description of this instrument in Danish, and p. 61, where he states its

, but in common hands its want of solidity and would probably have been felt. It would be le as well as useless to give an account of the constructions of different artists at home and

The general properties of a theodolite, that it e firm, well balanced, &c., will be easily recog- a person who knows how to make good use of iment, and we shall advert in the course of this) some of the qualities which are, and to others e not, essential.

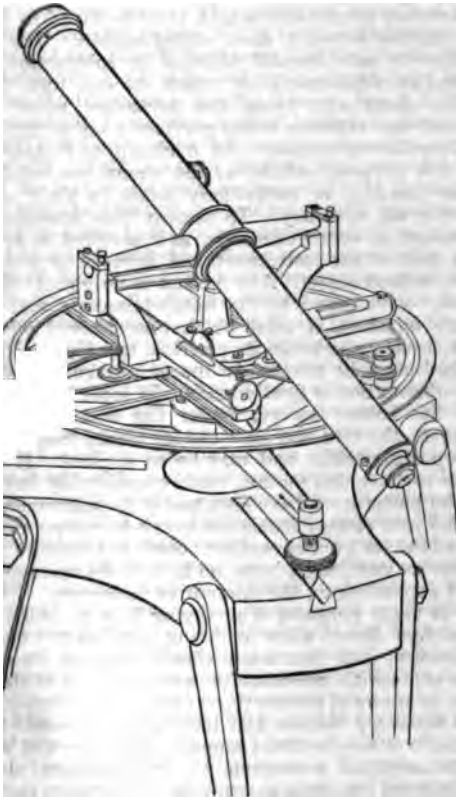

ive given here a sketch of the theodolite in its form, such as would be proper for the secondary tion of a national survey, or for the most accurate survey. The tripod which carries the instrument i three foot-screws in brass notches let into the wooden stand. The legs of the stand are not fully ed, but the two parts of which each is composed w in a strong and sharply-pointed metal socket. le is fixed, and the upper works, telescope, ver- els, &c., turn on a centre, which may be seen just e cross of the telescope. The adjustments are ple. The wooden stand is first set down with a ning of the legs, and the top nearly horizontal. -screws are placed in their notches, the plumb- ; from its hook, below the centre of the circle, and ope turned round till one level is parallel to the ng two foot-screws, while the other level is in a i the third foot-screw to the centre. Bring the f the first-mentioned level into the middle by ne of the two foot-screws and depressing the other, adjust the cross-level by raising or depressing the t-screw alone. Now turn the telescope round if the bubbles are not in the middle, bring them there by touching the foot-screws, and the other rews which adjust the levels themselves. When been nicely done, the bubbles will remain in the e every position of the telescope. If the objects erved lay all in the horizon, or in a plane parallel above adjustment would be sufficient; but when ts are out of the horizontal plane they must be to it by a perpendicular, that is, the plane de- y the telescope must be a great circle, and must through the zenith. There are generally two least in the focus of the telescope, one horizontal other vertical. Place the eye-piece to give sharp the wires, and turn the milled screw, seen towards

the object-glass, until the objects you are going to ob- serve are distinct. Place the vertical wire on any well- defined object, making the bisection near the crossing of the wire; raise or depress the telescope until the object is nearly at the bottom or top of the field; if it is still bisected, the wire is rightly plac- ed, but if not, twist the tube carrying the eye-piece so as to effect a bisection. To make the telescope describe a *great* circle, select some well-defined object near the horizon, and bisect it: now take the telescope *very carefully* out of its Y's, reverse it, and look again at the object. If it is still bisected, there is no error; but if not, the bisection is to be effected half by the tangent-screw of the instrument and half by the screws which carry the wire-plate, screwing up one and releasing the other. Restoring the telescope to its first position, it will be seen whether the adjustment is correct, and if not, the process must be repeated until the bisection is the same in both positions of the telescope, the clamp and tangent-screw remaining fixed. For the adjustment of the axis of the telescope a level would be convenient, but in this instrument the axis is supposed to have been correctly placed by the maker, and the only mode of correcting any error is by filing the Y's. It may be ascertained whether the axis is tolerably correct as follows:—Bisect an object, as far above or below the horizon as the motion of the telescope will allow. Reverse the telescope, and if the object is still bisected, the pivots of the telescope are the same size: if not, the observer must deduce the difference of the pivots from the altitude and the error observed, which is not difficult. When this has been satisfactorily executed, bisect, as in the last instance, an object as far as possible from the horizon, and read off the verniers. Turn the instrument round 180°, return the telescope *end for end*, bisect the object again, and read off the verniers. If the mean readings differ exactly 180°, the axis is hori- zontal; but if they do not, the observer will have sufficient data from this, and the altitude or depression, for deter- mining the quantity and direction of the error, which he may correct by the file or by calculation, according to his pleasure. There is a much easier method of examining the position of the axis by observing an object directly and as seen by reflexion from a fluid, as mercury, oil, or water. The axis is truly horizontal when the vertical wire bisects the object and its reflected image without moving the tangent-screw. It must be recollected that the ad- justments of the horizontal circle already described must be previously and very scrupulously performed before attempt- ing the examination or adjustment of the cross-axis.

As the objects in a survey are at very different dis- tances, an adjustment is required for forming the image exactly on the wires. The use of the milled screw, seen towards the object-end of the telescope for this purpose, has already been mentioned.

In use, this theodolite should be placed on a repeating table or tripod, such as is to be found figured and described in REPEATING TABLE, and the repeating-tripod upon the stand. This was not done in the present plan for the sake of clearness. To adjust the repeating tripod, place the levels as described in the first adjustment, and clamp the theodolite. Bring the foot-screws of the theodolite over the foot-screws of the repeating-tripod by the motion of the tripod, and then by touching the foot-screws of the tripod or theodolite set the level-bubbles in the middle. Turn the upper plate of the tripod half-round, and again bring the bub- bles into the middle, half by the tripod foot-screws, half by those of the instrument, and repeat the operation until the revolution of the repeating-table does not alter the position of the level-bubbles. The repeating-stand is now clamped, and the instrument itself is to be adjusted exactly as we have described above.

The course of observation after the instrument is ad- justed is very simple. The problem is to measure the horizontal angle between two objects. Turn the telescope two or three times round in the direction in which you intend to observe, then bisect one of the objects, read off the verniers, and take a mean; bisect the second object, read the verniers, and take a mean. The difference be- tween the two means is the angle required. This is all that can be done by the instrument as usually mounted; but with a repeating-table the operation is continued thus. Bring the telescope back on the first object, by the motion of the repeating-table, using its clamp and tangent-screw, and by the motion of the instrument bring

the telescope on the second object. It is clear the motion of the repeating-table has merely restored the telescope to its original direction, without altering the readings of the circle; and that if the telescope be turned on the second object by its motion alone, without distributing the circle, the difference between the mean of these new readings and the preceding mean will also be the angle required. By continuing the process, the angle may be measured as often as the observer pleases. It is evident that all readings-off, except the first and last, are superfluous, save as checks, or as giving the means of estimating the accuracy of the final result. The series should terminate after a whole number of revolutions as nearly as possible, when the eccentricity of the repeating-table will be eliminated, a matter of possible importance if the objects are near and the repeating-table carelessly made, or, if the objects are pretty distant and this caution superfluous, when the verniers are nearly at the divisions at which you set out, which gets rid of or at least diminishes any errors of division. The latter condition is however rather a speculative than a practical one. As the error of division is divided by the number of observations, and the casual error of observation only by the square-root of the same number, it is evident that a moderate number of repetitions in our excellently-divided circles will reduce the error arising from mal-division to a much smaller quantity than that which belongs to the class of casual error of observation.

The essential condition of repetition is, that the motion of the theodolite shall not disturb the repeating-table. The motion of the latter therefore should be as heavy as will admit of nicety in the tangent-screw, while the motion of the parts which move with the telescope should be as light and free as is consistent with firmness. There is, we believe, no difficulty whatever in effecting both these points; but lest any error should arise from repetition, we should recommend a careful observer to determine his angles by two series,—one by always moving the telescope and its tangent-screw forward, and the repeating-stand and its screw backwards; and another, by reversing the process. If the two results agree, as they should do within the limits of casual observation, the mean is probably free from all other error; and if they do not, the observation should be repeated and varied until the quantity and probable law of the error is ascertained. We should then be able to say decidedly where, when, and under what precautions repeating was a safe as well as a convenient and economical process, which at present is rather a *reçuta quæstio*, unless the decision be supposed to be against all repetition, to which we do not bow.

The foregoing description has been confined to a form of theodolite which is not in ordinary use, though from its simplicity and power it is well adapted to the purpose of explanation. The common theodolite is generally carried by a pair of parallel plates, fixed on a three-legged staff. The lower of these circular plates is screwed upon the staff, and has an aperture above the screw. The upper plate has a strong descending shank which passes loosely through this aperture. A button of a spherical form is fixed on the end of the shank, the curvature uppermost, and rubs against the under surface of the lower plate, which is dome-shaped to fit it. Four strong screws pass through the upper plate and abut with their lower ends against the lower plate. When the screws are turned the plates are separated until the button and the spherical surface on which it rubs are brought into squeezing contact. To level the theodolite, set the levels each parallel to a diagonal pair of screws of the parallel plates. Then screw one pair until you come to a bearing, and by releasing one screw and screwing up the other, but not very tight, set the corresponding level horizontal; leaving this pair and taking hold of the other pair set the second level also right, and if the first level is deranged, as it probably will be a little, restore its position by screwing up the proper screw. Turn the telescope half round and correct the error, half by the parallel plate-screws, and the other half by the level-adjustments themselves. It is desirable that, when the final adjustment is made, the screws should bite pretty hard, otherwise there is a great chance that the upper plate will turn a little during the observation. This objection would seem fatal to the use of parallel plates where great nicety is required: they are

however very convenient and of very ready use, and perhaps if the screws are strong and the observer is careful to give the telescope three or four turns round in the direction he means to observe, before starting, and always to move the telescope the same way, serious error may be avoided. The first object observed should always be observed at the end of the service, in order to see whether there has been any change in the original position. If one of the screws rest in a notch, perhaps the tendency to twist may be wholly overcome.

Another contrivance which is to be found in almost all theodolites is much more objectionable. The surveyor wishes to save himself addition or subtraction, and requires an adjustment by which he can turn the whole circle about and bring the telescope upon the first object, the verniers being previously set to zero. There is therefore a motion with a clamp and tangent-screw for this purpose, which, as the clamp has usually a very short bearing, is particularly liable to yield and so to destroy all accuracy. To remedy this unnecessary evil, a second or watch telescope, as it is called, is attached to this part of the instrument and brought to bear upon a well-defined object. Any motion or wriggling of the zero-clamp is betrayed by the watch-telescope, and when an angle is taken, it must be first ascertained whether the watch-telescope keeps its position, and the position if disturbed must be restored to the zero tangent-screw, before the observation is finally made. In some theodolites made for the Indian survey, under the direction of Colonel Everest, the zero and slow-motion clamp take the form of a repeating-table, and may be so applied. It would be safer to have this motion made considerably heavier than in the patterns we have seen, and if the instrument is likely to fall into clumsy hands the watch-telescope might easily be added for greater caution. Such a theodolite would, so far as we can judge, have no limit to its accuracy, except that depending on the diminutive telescope.

For many purposes of surveying it is desirable that the telescope should allow of being considerably elevated or depressed, and that means should be given for measuring this angle with considerable accuracy. A circle, or portion of a circle, is then fixed upon the telescope axis, and the necessary verniers and level may be secured by a tail-piece or otherwise to the support. If the vertical angles are to be measured as accurately as the horizontal angles, the instrument becomes an altitude and azimuth circle. [CIRCLE.] But such instruments are rarely applied to the measurement of terrestrial angles. The direction of the meridian was determined in the Ordnance Survey by observing Polaris at its greatest elongations E. and W., and taking the middle of the two readings for the direction of the north. Hence the telescope required all the transit adjustments except that for azimuth [TRANSIT], and was considerably elevated above the circle. Though the results were upon the whole satisfactory, yet we greatly doubt the prudence of ascertaining this fundamental and delicate point from such an instrument, or of risking the steadiness of the telescope supports by raising them so much above the body of the instrument. It would have been better, we conceive, to have determined the direction of the meridian by a series of careful transit observations, using more optical power with greater steadiness, and to have kept the theodolite to its proper office, that of measuring horizontal angles, greatly reducing the height of the telescope supports. The great theodolite had originally a semicircle fixed to the axis of the telescope, for measuring altitudes and depressions. This has since, very properly, been removed, and a whole circle substituted.

Where a theodolite is merely used for surveying, the telescope requires only a moderate vertical range. Mr. Troughton fixed a portion of a circle (which may be more properly called a slice than a sector) to one or two of his 12-inch theodolites, and this construction is often found in other makers. The telescope is thus kept lower, the instrument is firmer, and the larger radius gives the portion of the circle a seeming advantage over the entire circle of smaller radius. There is however something very faulty in a portion of a circle, and we should prefer a sort of compromise, giving the supports such an elevation as would allow a vertical circle of about half the diameter of the horizontal circle: if the direction of the meridian is to be determined by this instrument, the telescope must be at least so high as to see 2° or 3° above the

e of the place, and the vertical circle may be increased accordingly.

It is perhaps requisite to give some description of the mode of adjusting the vertical circle. Where the supports are high enough to allow the telescope to pass when turned round in a vertical plane, all the adjustments are the same as in the altitude and azimuth circle.

[CIRCLE.] When the telescope is too long for this, the circle must be lifted out of its Y's in order to bring the line of sight again upon the object to be bisected, then set down again. The operation is in fact the same whatever be the nature of the vertical arch, and the adjustment is to be effected either by altering the level or the horizontal wire until the reading is the same in both positions of the telescope. If the observer has a Y level collimator, he can set the cross of his level-wires horizontal, and this being bisected by the telescope of the theodolite, the vernier must be made to read zero, and the bubble of the level be brought to the middle by its proper screws. Or if the observer possess two stands (and there is a great convenience in having more stands than one in surveying), he may place the stands at a considerable distance from each other, and, fixing the instrument on one stand and a mark of exactly the same height as the telescope-axis on the other, observe the mark, noting its elevation or depression. Now exchanging the instrument and mark, he must reobserve the depression or elevation exactly before. On drawing the figure, it will be seen that if light were in a straight line, $90^\circ - \text{elevation at lower station} = 90^\circ - \text{elevation at higher station} + \text{the angle between perpendicular to the earth's surface at each station, which last angle is known from the distance between the stations, may be easily calculated, i.e. depression} - \text{elevation} = \text{a given angle}$. But if the zero is wrong, depressions will be increased while elevations are diminished, and *versed sine*, so that depression observed - elevation observed = the known angle, instead of being = 0, will be ± 2 or of the vernier, which may be corrected accordingly by the adjustment of the level or of the horizontal wire. Or, lastly, if the telescope has so much motion as that a star can be observed directly and by reflexion from mercury or any other fluid, the index-error of the vertical circle may be most accurately determined thus. Take any star in the meridian, and having observed it directly, observe it immediately after by reflexion. If great nicety is required, the observations should be repeated alternately several times, and the partial results reduced to the meridian. The mean reading between the meridian altitude and meridian depression is the reading which corresponds to the horizon, and the difference of this from 0, 90° , according as the circle reads altitudes or zenith distances, is the error of the instrument, which may either be corrected or allowed for. This method, though very accurate, requires some knowledge of the time, and is rather affected by the choice of stars. It is nearly as safe to observe a star not far from the east or west point, first directly, then by reflexion, and lastly directly, making the observations at following whole minutes, or at even or odd minutes if the interval of a minute is not sufficient. As the stars rise nearly uniformly in this part of the heavens, the difference of the first and third observations should give an altitude equal to the depression observed midway; the discrepancy between these results will be the double index-error as before, which may be corrected or allowed for. In some of these methods, the index-error of the vertical circle or sector is to be found.

In some of the older theodolites the telescope rides in Y's at the top of the vertical arch, and is reversible as a level. The horizontal position of the telescope Y's can therefore be found as in any other level, and the verniers of the vertical circle set to zero when the telescope is horizontal. The vertical angles measured by these instruments are not however to be greatly depended on. They are usually greatly out of balance in all positions of the telescope, except the horizontal position, and therefore they make better levels than altitude instruments. This error may be partially got rid of by having a second level fixed to the instrument which is parallel to the plane of the vertical circle, and adjusted to the telescope level when that is horizontal. If this supplementary level is pretty well graduated, it will show the tilt which is given the plane of the instrument by want of balance, and so give the correction required.

It may be as well to mention here that the principal adjustment being that of setting the plane of the theodolite horizontal, or, more correctly speaking, the principal axis vertical, any horizontal level anywhere placed is sufficient for the purpose, though the cross-levels are a little handier. A box-level is convenient, if a stand and repeating-table are used, to bring the planes nearly horizontal, and to make both ends of the bubbles visible at first.

Many surveyors give themselves and the instrument-maker a great deal of unnecessary trouble by being very difficult on the chapter of excentricity, which they confound with error of division. The English dividing-engines, up to the present time, do not divide the circles upon their centres; and therefore it frequently happens that the point round which the circle turns is not the point round which it is divided. When this error is not absolutely monstrous, the only effect is that one vernier gains what another loses, and that the mean of two opposite, or of three, four, or more equidistant readings, is precisely the same as if there were no excentricity. The advantage of a little excentricity is, that it gives you the benefit of an unbiassed reading at every vernier as well as the first: again, if all the verniers are recorded, it is a check on the dishonest observer, who might read one vernier and set down the rest. The instrument-maker must please his ignorant customer, and so either hammer his circle after it is divided, which may deform his work, or have an adjustment, which injures its solidity.

In Ramsden's great theodolite, and several others which have been made, the circle is read off by micrometer microscopes. Sometimes the microscopes revolve with the telescope (as the verniers do in our figure); sometimes the microscopes are fixed, and the circle revolves with the telescopes, as in Ramsden's theodolite.

Ertel of Munich has made several astronomical theodolites in which the rays entering into the telescope are reflected along the horizontal axis by a prism. The observer therefore looks in at the end of the horizontal axis, whatever the position of the star may be. The eye and body of the observer are more satisfactorily placed, and the supports are kept close and snug to the horizontal circle. The instrument is well adapted to one of its principal objects, observing stars at their passage over the prime vertical [TRANSIT]; but there is some trouble in finding an object when you have no better direction to look for it than your eye affords. Excellent latitudes have been determined by instruments of this class used in the prime vertical, and even the small vertical circle seems from some accounts to possess more power than from its dimensions we should have thought probable. As a general rule, the greater the number of readings, the less the effect of bad division, but beyond a limited number, the trouble and difficulty of reading-off is found in practice to counterbalance the advantage. Two opposite readings annul the effect of excentricity; three or four equidistant readings destroy such an error as would arise from the circles becoming elliptic after it was divided, or any error which follows the same law. In small stoutly-made theodolites we think two the most convenient number, and they can be much more conveniently read off than a larger number. When the circle is so much as 8 inches in diameter and the telescope good, we should prefer three or four readings. The vertical circle or sector may have two opposite readings. For many matters connected with surveying on the most extensive and accurate scale, see the memoirs published and to come of the English, Scotch, and Irish Trigonometrical Survey; and the 'Base Métrique,' or account of the French measurement of an arc of the meridian, although that survey was conducted by a different instrument. Similar operations have been carried on in many countries during the last half-century, and the memoirs which relate to these surveys contain the best information which can be had on the subject.

THEODO'RA. [JUSTINIAN.]

THEODORE OF CORSICA. [CORSICA.]

THEODORE, or THEODORUS, of Mopsuestia, a learned bishop of the Oriental church. He was descended from a rich and distinguished family at Antioch, and was the brother of Polychronius, who became bishop of Apamea. He studied rhetoric, together with his friend John Chrysostom, under Libanius, who resided at Antioch from the year A.D. 354. His teacher of philosophy was Andragathus. After having finished his studies, he intended to marry a

lady of Antioch (about 369); but his friend Chrysostom, who was then a monk, persuaded him to choose the monastic life. Theodore was for some time a priest at Antioch, and afterwards bishop of Mopsuestia, an ancient town of Cilicia (394). In the same year he was present at the council of Constantinople. He died in 429, at a very advanced age, and after he had discharged his episcopal functions during thirty-five years. During fifty years he was known as one of the most distinguished writers of the Greek church, especially by his works against the Nestorians, Pelagians, and other sectarians. His zeal however for the Catholic faith did not save him from the charge of being an adherent of the doctrines of the Nestorians, and he was obliged to make a public apology. After his death the Nestorians continued to quote his works, and to call him the support of their faith; and this was the cause of his works, or perhaps only part of his works, being condemned by the fifth Council (553). Theodore of Mopsuestia is said to have written largely on divinity and morals. Few of his writings have come down to us: others exist in Syriac and Latin translations, and of the greater part there are only fragments. A treatise on the Magi of the Persians, and his commentaries on the Psalms, the Book of Job, and the Song of Solomon, are lost: his commentary on the twelve greater prophets is preserved in MS., according to Fabricius, under the title of Θεοδώρου Ἀντιοχείως ἱερουργία εἰς τοὺς Προφήτας. A catalogue of the works which contain fragments of him is given in Fabricius, and the Syriac translations are mentioned in Assemanus's 'Bibliotheca Orientalis.' Theodorus of Mopsuestia is still one of the first theological authorities among the Syriac Christians.

(Fabricius, *Bibl. Græca*, x., p. 346-362; 346, note a; 347, note o; 352, note gg; 355, note kk; p. 748: Tillemont, *Memor. Eccles.*, vol. xii.; Cave, *Script. Eccles.*, vol. ii.)

THEODORETUS, or THEODORITUS, a theologian and church historian, was born about 393 A.D. He was brought up under the care of a pious mother, to whom he acknowledges his obligations in his writings; and he had instruction from Theodore of Mopsuestia and John Chrysostom in a monastery, to which he was sent to receive his education when not quite seven years old, and where he had for his fellow-pupils Nestorius and John, who were afterwards patriarchs of Constantinople and Antioch. Theodore became a deacon in the church at Antioch, and in the year 423 he was chosen bishop of Cyrus, a city in Syria, near the Euphrates. His diocese abounded with Marcionites and persons who held heretical opinions concerning the Trinity. Against the opinions of these heretics he directed his efforts with so much success, that, according to his own statement, he baptized ten thousand Marcionites.

In the year 431 Nestorius was condemned by the council of Ephesus [NESTORIANS], whose decision gave great offence to many of the Oriental Christians, who, without being avowed followers of Nestorius, were supposed to be not unfavourable to his opinions. Among these was Theodore, who was a personal friend of Nestorius; and he was one of those who assembled after the council of Ephesus had broken up, and condemned its proceedings. A reconciliation was however effected between Cyril, patriarch of Alexandria, the great enemy of Nestorius, and John, patriarch of Antioch, the leader of the Oriental party, who signed an agreement by which Cyril approved of John's statement of the controverted point of doctrine, while John gave his approval of the sentence passed on Nestorius. With this agreement Theodore and others of the Council party were greatly dissatisfied. Theodore appeared before the whole of the doctrinal statements in the agreement, and he warmly protested against John's consent to the condemnation of Nestorius, as an act of unmitigated injustice. He expressed these feelings in a letter to Nestorius. But when John, armed with an imperial edict, proceeded to take measures against the more decided partisans of Nestorius, Theodore considered himself bound to submit, both for the sake of the peace of the church, and because of his own approval of the doctrine which it was John's object to enforce. He therefore used every means in his power to induce the friends of Nestorius, namely, Meletius, bishop of Mopsuestia, Alexander of Hierapolis, and Helladius of Tarsus, to submit to John; and, upon their rejection of his advice, he offered no op-

position to their being deposed. But when, in the year 435, new and severe edicts were issued against the Nestorians, Theodore refused to carry his submission any further; and, by his firmness he incurred the hatred of Cyril, to whom he had already been opposed in this controversy, and between whom and Theodore such a bitter feeling existed, that when Cyril died, in 444, Theodore made no secret of his joy at the event.

If, as we are bound to conclude from the character of the man and from the Christian spirit with which he elsewhere speaks of Cyril's death, Theodore's joy on this occasion sprung from a belief that the divisions which had been kept alive by Cyril would die with him, and peace be restored to the church, he was doomed to bitter disappointment. Cyril was succeeded by Dioscurus, a man so haughty and impetuous as himself, and quite as unscrupulous. The new bishop followed up his predecessor's plan of enforcing upon the whole Eastern church the doctrine of the coalescence of the Deity and humanity into one nature in the person of Christ; and perhaps he also kept in view the object of obtaining a kind of supremacy for the see of Alexandria. Determined to admit of no compromise, he made his first attack upon the moderate party in the Syrian churches, which was headed by Theodore. Dioscurus was supported by a large party in Syria, chiefly consisting of monks, whose leader was an abbot named Theodosius; and at Constantinople many monks, the most remarkable of whom was the abbot Eutyches, were strongly in favour of the Cyrillian doctrine, on the ground that it alone was consistent with the simple letter of Scripture, 'the Word became flesh,' and other similar expressions.

These Constantinopolitan monks were a most important party in the dispute, partly from their close connection with the anti-Nestorian monks of Syria, and still more their great influence with the emperor Theodosius, whom they had induced from the very first to espouse the party of Cyril. Theodore was, as usual, slow to the controversy. He wrote to Dioscurus in the hope of effecting a reconciliation between the two parties. This attempt he failed; and then, looking upon the trine of Dioscurus and his allies as the sure road to various heresies which denied the true humanity of Christ, he wrote a book against them in the year 447, entitled 'Beggars, or the Many-shaped,' ἱεραμιστῆς, or τὰ πολλὰ μορφῆς. By this title he meant to imply that the Eutychian doctrine (as the views held by Cyril, Dioscurus, Barsilae, Eutyches, and the monks, are generally named for sake of brevity) was borrowed from a variety of other heresies. The work consists of three dialogues: first, entitled ἀρρετρος, he treats of the impossibility of divine essence undergoing a change; in the second, ἀδύχνητος, of the impossibility of the two natures (divine and human) being mingled into one; and in the third, ἀκαθής, of the impossibility of the divine suffering or dying. This work displayed great learning and power, together with a moderation which drew Theodore the reproaches of the zealots of his own party. His opponents, however, saw in his doctrines nothing more than a revival of Nestorianism; and Dioscurus sent him before Domnus, the patriarch of Antioch, of the one Lord Jesus Christ into two sons of God, and also a severe letter to Theodore, making the same charge. Theodore replied with great mildness and conceding as much of the disputed doctrine as he could conscientiously, and praying Dioscurus to consult for the peace of the church rather than for the views of a party. This letter only the more incensed Dioscurus, who permitted monks publicly to anathematize Theodore in church, while he himself confirmed their anathemas. He also sent ambassadors to Constantinople to accuse the whole Eastern church of Nestorianism before the emperor. Domnus also sent deputies to clear his church of the charge, and Theodore wrote with the same object some of the most powerful ecclesiastical treatises. No immediate decision of the dispute took place, but emperor ordered Theodore, as a troubler of the church, to confine himself within the limits of his own diocese. Theodore bitterly complained of being thus confined and unheard.

In the meantime the two parties grew more violent, and the imperial court itself became the scene of their disputes. In the year 448 Eutyches, in his zeal against Nestorianism,

he charge of an opposite heresy, of which he was condemned by the synod held by Flavianus at Con-
 stantinople, but again acquitted by the second Council of
 Ephesus under the presidency of Dioscurus (A.D. 449).
 [ANS.] In convening this council every care was
 taken to exclude the anti-Eutychian party. With respect
 to Theodoret, the emperor commanded that he should only
 be present in case his presence should seem good to the
 emperor. The hint was taken, and he was ex-
 cluded. The emperor carried his dislike to Theodoret still
 further, and intimated to the council that such men as
 he should not only have no voice in it, but that they
 were to be visited with its censures. Accordingly
 he deposed Theodoret from his bishopric, and he
 was expelled, by an imperial edict, to retire into the
 desert where he had been educated. As he had been
 moderate in prosperity, so he was resigned
 and firm in adversity: indeed his amiable spirit, and
 his success in obeying the dictates of his conscience, form
 a valuable relief to the strife and ambition which
 characterized most of the ecclesiastics of the age.
 A check to the triumph of Dioscurus and the
 influence of Leo the Great, the then
 pope of Rome, who had been already appealed to by
 Theodoret after his condemnation by the synod of Con-
 stantinople, and whose aid was now sought by the oppo-
 sition.

Flavianus and Theodoret wrote letters to him,
 to submit the whole controversy to an œcumenical
 council to be convened in Italy. To this arrange-
 ment emperor (Theodosius II.) refused his consent,
 although in the following year (450) changed the state

of affairs. In the next year (451) an œcumenical council
 was held, first at Nicæa, but very soon removed to
 Chalcedon, to which Theodoret was summoned, and in
 which he was received by his friends with the greatest en-
 thusiasm.

He petitioned the council for restoration to
 his bishopric: at the eighth sitting his petition came on
 the agenda; he rose to plead his cause; but the party of
 Nestorius exclaimed that he must first condemn Nestorius.

Theodoret had never been a Nestorian, but had all along
 pursued a middle course between the parties of Nestorius
 and Cyril; but he hesitated to pronounce the required
 sentence till some clear definition of Nestorianism
 was given. The bishops of the opposite party in-
 sulted him with the shout 'He is a heretic: he is a
 Nestorian: thrust the Nestorian out!' Upon this Theo-
 doret answered:—'Anathema on Nestorius and on every
 one who denies Mary to be the mother of God, and who
 says that she has begotten Son into two sons. I have sub-
 scribed the confession of faith, and the letter of the bishop
 of Alexandria in my faith—Farewell.' He was pronounced
 orthodox, and the unanimous vote of the council
 restored him to his bishopric.

From this transaction we perceive that Theodoret's firm-
 ness and length given way before the furious zeal of the
 party; and his courage appears never to have re-
 sisted his latest work, which was a history of here-
 sies (*ἱστορία κακοῦνδίας ἐπιτομή*), he speaks of his former
 torments in the harshest terms.

At the council of Chalcedon, Theodoret returned to
 his bishopric, where he devoted the rest of his life to literary
 pursuits. He died in the year 457. Even after his death
 he was looked upon as a formidable enemy by the Mono-
 thelites; the Origenists, who procured the condemna-
 tion of his writings against Cyril by the council of Con-
 stantinople (A.D. 553).

His works were:—1, 'A History of the Church,' in five
 volumes, to the death of Theodoret of Mopsuestia
 (Theodoretus), a Latin writer, at the end of the fifth
 century; he says that Theodoret's history consisted of ten
 volumes, but came down to the year 457, but no other writer
 mentions more than five books. It is a work of great
 value and impartiality. 2, *Φιλότητος ἱστορία*, an account
 of thirty celebrated hermits, ten of whom were
 contemporaries and in some degree personally known
 to Theodoret. 3, The work against the Eutychians, already
 mentioned.

4, 'The History of Heresies,' also mentioned
 above, is sometimes entitled, 'Against all Heresies,
 a refutation of falsehood and truth' (*κατὰ πᾶσῶν
 ἡρέσεων ἢ ψεύδους καὶ ἀληθείας διάγνωσις*). It consists
 of three books, and relates almost exclusively to the heresies
 of the person of Christ. 5, 'Ten Orations against
 heresy;' an 'Apology for Christianity;' besides 146

letters and commentaries on most of the books of the Old
 Testament and on all the epistles of Paul.

The best edition of his works is that of Schulze, in 5
 vols. 8vo., Halle, 1768-74.

(Mosheim's *Ecclesiastical History*, by Murdock and
 Soames, i., p. 443; Neander's *Geschichte der Christl.
 Relig. und Kirch.*, ii., passim; Schöll's *Geschichte der
 Griech. Litt.*, iii. 318.)

THEODORIC or THEODERIC I., king of the Visi-
 goths, was the elected successor, but was not the son, of king
 Wallia, who died A.D. 419. During the latter years of the
 reign of the emperor Theodosius II., Theodoric invaded
 Gaul, and in 425, just after the accession of Valentinian
 III., he laid siege to the city of Arles. Aëtius however
 relieved this town, and made peace with the Goths, who
 were obliged to come to terms because they were threat-
 ened by the Vandals, and they marched against the Van-
 dals together with the Romans. After a peace of ten
 years, a new war arose between the Romans and Theo-
 doric, who in 436 besieged the city of Narbonne, which
 was only relieved in the following year, 437. The issue
 of this war proved unfortunate for the Romans, the in-
 habitants of their provinces in Gaul being reduced to
 despair by heavy taxes and other kinds of oppression, and
 the Goths being superior to the Romans in courage.
 Aëtius therefore enlisted several thousand Huns, in order
 to employ them against the Goths; but these auxiliaries
 were more destructive to the inhabitants than their ene-
 mies. A body of the Romans, together with these Huns,
 commanded by Litorius, the best of the generals of
 Aëtius, having made some progress, laid siege to Toulouse
 in 439. Theodoric proposed to conclude a peace, but
 Litorius, remembering his former victories over the Ar-
 moricans, refused all terms. Upon this the Goths made
 a sally; the Romans were entirely beaten, and Litorius
 himself was made a prisoner, and carried in triumph
 through the streets of Toulouse.

The whole country as far as the Rhône was now open to
 the Goths, and the inhabitants being well-disposed, Theo-
 doric made fresh conquests. The remainder of the Roman
 army was disorganized and in the greatest consternation.
 Nevertheless Avitus, who was then Præfectus Prætorio in
 Gaul, found means to make peace, which was certainly
 favourable to the Goths, though the conditions are not
 known. In 450 Gaul was invaded by Attila with his
 Huns and a numerous body of Teutonic auxiliaries. At-
 tila pretended that his object was only to attack the Visi-
 goths, but the Romans also took arms, and the united
 forces of Aëtius and Theodoric met the Huns at Châlons-
 sur-Marne (451). Theodoric commanded his army in per-
 son, and he was accompanied by his two sons, Thorismund
 and Theodoric. The battle was short, but bloody and disas-
 trous for Attila, who fled on the following day, and thus
 escaped total destruction. King Theodoric was killed at
 the beginning of the battle. Prince Thorismund was pro-
 claimed king in the camp of his father, whom he caused
 to be interred on the field of battle with great pomp.
 [ATTILA.] (Mascov, *History of the Antient Germans*,
 ix. 11, 14, 27, 28.)

THEODORIC, or more correctly THEODERIK, sur-
 named 'the Great,' king of the Ostro-Goths, was the son
 of king Theodemir by his concubine Ernieva (Ehrlieb).
 He was born in 455, and he was seven years old when he
 was sent to Constantinople to the court of the emperor
 Leo Magnus (457-474) as a hostage, peace having just
 been concluded between this emperor and Theodemir, who
 had engaged to assist the Romans for an annual payment
 of two thousand pounds of gold. Theodoric received his
 education at Constantinople, and returned to his father
 in 472.

Without any orders from his father, he attacked and
 subjugated some Slavonian tribes on the Danube, and he
 afterwards accompanied Theodemir in his expedition to
 Thessaly, which was undertaken for the purpose of obtain-
 ing a larger territory for the Goths. This happened at
 the same time as the death of Leo (January, 474); and
 Zeno Isauricus the elder, who became emperor in the
 month of February, hastily made peace with the Goths,
 and ceded to them the country of Pautalia, that is, the
 south part of Pannonia and the south-west part of Dacia
 (474). Theodemir died in 475, and Theodoric became
 king of the Ostro-Goths.

Zeno having been deposed by another Theodoric, the

son of Triarius, a Gothic prince who had great influence in the Byzantine empire, king Theodoric marched to his assistance, and by his aid Zeno was again acknowledged as emperor (476-477). It seems that Zeno did not show himself so grateful as he ought, for serious differences broke out between him and the Goths. Theodoric, on the contrary, was loyal and generous, and he continued to be a faithful ally when the emperor had satisfied his just claims. He proved so serviceable, that Zeno created him *Patricius* and *Magister Militiæ Præsentis* in 483, and subsequently promoted him to the consulship in 484, a year which is still distinguished in the annals by his name. Jornandes affirms that Zeno adopted him as his son, and caused an equestrian statue to be erected in honour of him before the imperial palace. (*De Rebus Gothicis*, c. 57.)

Notwithstanding the honours which Zeno conferred upon the king of the Goths, Zeno showed his insincerity wherever he saw an opportunity. To avenge himself, Theodoric invaded Thrace (in 488), dispersed the imperial troops, and besieged Zeno in Constantinople. It is said that Zeno saved himself by ceding to his adversary Italy, or his right to Italy, which was then in the hands of Odoacer, the chief of the Rugians. Perhaps he ceded only his claims on this country, hoping thus to get rid of a neighbour and friend whom he had charged by his own misconduct into a dangerous enemy. However this may be, the conditions of agreement are obscurely known. The Greeks afterwards pretended that Zeno had sent the Goths to Italy to re-annex that country to the empire: the Goths, on the contrary, affirmed that he surrendered Italy to their king. (Procopius, *De Bello Gothico*, i. 1.) Theodoric had certainly formed the plan of conquering Italy, and he was bent on carrying it into execution. If therefore he found it advisable to use the name of Zeno, he probably did so for the purpose of gaining those among the Romans who, although they detested foreigners, would submit to any conqueror whom they could consider as a delegate of the antient legitimate authority.

Theodoric assembled his nation (489), that is, that part of the Ostro-Goths which obeyed the kings of the house of the 'Amali,' of which Theodoric was a descendant. Some Gothic tribes only remained in Thrace and in the Tauric Chersonese. A whole nation, men, women, and children, carrying all their moveable property with them, left their homes and took the road to Italy, following the Danube as far as the tract which lies between that river and the lake of Balaton in western Hungary. Trapstila, the king of the Gepidæ, appeared with an army to prevent them from passing through his dominions; but he was routed by Theodoric on the river Ulca (the present Szala), which flows into the western corner of the lake of Balaton. Enduring hardships of all kinds, and fighting their way through the armed inhabitants, the Goths traversed the western part of Pannonia, crossed the Julian Alps, and reached Isonzo, where they met with the army of Odoacer, who was beaten in three battles—on the Isonzo, at Verona, and on the Adda (490). Odoacer, who fled to Ravenna, was forsaken by his best general, Tufa, and Frederik, a prince of the Rugians, and Epiphanius, bishop of Pavia, also came to Milan to pay homage to the king of the Goths. Odoacer was blocked up in Ravenna by one part of the Goths, and Theodoric, with another part, took possession of the whole peninsula of Italy, leaving Sicily, Sardinia, and Corsica to the Vandals. The siege of Ravenna lasted three years; but at last Odoacer surrendered to Theodoric, who, notwithstanding his oath to spare the life of his prisoner, ordered him to be put to death in his own palace (493). Odoacer's son and his whole family shared the same fate.

Theodoric was now acknowledged as king of Italy by the emperor Anastasius, the successor of Zeno, who gave him the furniture of the palace at Ravenna, which Odoacer had sent to Constantinople. Theodoric did not assume the imperial title although he adopted the name of Flavius. In 500 he went to Rome and celebrated a triumph; he convened the senate 'ad palmam auream,' confirmed the immunities of the Romans, and gained the affection of the lower classes by his liberality and by the exhibition of magnificent spectacles.

Theodoric had already confirmed his power by alliances with the neighbouring kings. Gundobald and Godegisel, the kings of the Burgundians, having made an invasion into Italy and carried away many of the inhabitants,

Theodoric sent Epiphanius, bishop of Pavia, and Vigilius, bishop of Turin, as ambassadors to Burgundy. They succeeded in delivering the captives, and concluded an alliance between these kings and Theodoric, who gave his daughter Ostrogotha in marriage to Sigismund, the son of Gundobald. He likewise kept peace with the Vandals, and gave his sister Amalfrida, then the widow of a noble Goth, in marriage to their king Thrasimund. His eldest daughter, Theodichusa, was married to Alaric II., king of the Visi-Goths; and his niece, Amalaberga, became the wife of Hermanfrid, the last king of the Thuringians. Theodoric himself took for his second wife Amalaberga, the sister of Clovis, king of the Franks.

In 504 Theodoric was at war with Thrasaric, king of the Gepidæ, who, after many defeats, ceded his southern provinces as far as Sirmium, now Mitrowicz on the Save, near its junction with the Danube. The inhabitants of the eastern part of the Alemannian kingdom, which had been destroyed by Clovis [ALEMANNI; TETTONIC NATION—*Alemanni*,] acknowledged Theodoric as their protector, and summoned Clovis to desist from any further violence against the Alemanni. (His letter is contained in Cassiodorus, *Variar.*, ii. 41.)

Meanwhile a war had broken out between Clovis and Alaric II., king of the Visi-Goths. Alaric fell in the battle of Vouglé in 507, in consequence of which the greater part of the dominions of the Visi-Goths in Gaul came into the hands of the Franks. Alaric's only legitimate son was a child named Amalaric, whom he had by his wife Theodichusa. As there was danger of all Spain being invaded by the Franks, the Visi-Goths intrusted the guardianship of their young king to Theodoric, who thus became the ruler over the Ostro-Goths and the Visi-Goths, or over Spain, southern Gaul, Italy with the dependent province of Illyricum, and parts of Rhetia, Noricum, and Pannonia. Theodoric had previously sent an army into Gaul, commanded by Iba, who delivered Arles, which was besieged by the Franks (508); and the same general made a prisoner of Gesalic, the natural son of Alaric II., was a dangerous rival of young Amalaric. Clovis pressed to content himself with the northern and western part of the Visi-Gothic dominions in Gaul. From this year, 511, is dated the regency of Theodoric in the kingdom of the Visi-Goths, who however styled himself king, and the councils which were held during his government are dated according to the years of his reign. He took possession of the cities of Provence, perhaps under the pretext of the expenses which he had been put to in saving the Visi-Gothic kingdom. He appointed Liberius his lieutenant in Gaul, and Theudis in Spain.

The relation between Theodoric and the emperor of Constantinople was maintained to the satisfaction of both parties, until Justin published a severe edict against all who were not of the Catholic church (523), and soon after deprived the Arians of their churches. About the same time this emperor had engaged with some members of the Roman Senate in designs against the Gothic dominion in Italy. Boëthius, then one of the first men in Italy, was charged with being a principal conspirator. He was imprisoned in 522, and during his captivity he wrote his *Treatise on the Consolation of Philosophy*. The conspiracy proved abortive, Boëthius was put to death in 524, and Symmachus, his father-in-law, shared the same fate in the following year at Ravenna. With regard to religious affairs, Theodoric, who was an Arian, like all the Goths, ordered Pope John with several bishops to go to Constantinople and to obtain better conditions for the Arians in the Eastern empire. The pope reluctantly obeyed, but it seems that in Constantinople he spoke rather according to his conscience than in favour of the Arians; for he was imprisoned at his return, by order of Theodoric, and died not many days after, on the 18th of May, 526. On Theodoric's recommendation, Felix was elected pope, and his election confirmed by Athalaric, the successor of Theodoric.

The fact proves the great influence which Theodoric had in the affairs of his time. Not having obtained favourable conditions for the Arians in the East, Theodoric was obliged to retaliate on the Catholics in his dominions, when he died suddenly on the 26th of August, 526, in the 72nd year of his age. His contemporaries have invented many fables about the sudden death of this great king. Procopius (*De Bello Gothico*, i. 1) says that the head of a large fish being served up at table, he fancied it to be

head of Symmachus, whom he had put to death, and whose participation in the conspiracy against Theodoric had not been proved; it is added that he was so terrified by his imagination, that he fell into a fever and shortly afterwards died. Others pretend that his death was the consequence of a divine judgment, because he had leposed and imprisoned Pope John: this story savours of its origin. Others dreamt that the ghosts of Pope John and Symmachus had cast the soul of Theodoric into the burning crater of a volcano. The ashes of Theodoric were leposited in a porphyry urn, which still exists in the wall of the castle of Ravenna, and under it is an inscription on marble, bearing the date 563, which states that the urn once contained his remains. Theodoric having left no male issue, Athalaric, the son of his daughter Amalawinth, succeeded him on the throne of Italy, and Amalaric became king of the Visi-Goths.

Theodoric generally kept his court at Ravenna, as the man emperors had done after the time of Honorius, and thus Ravenna became a centre of the arts and sciences, of no less importance than Rome. Among the high officers of Theodoric there were several very distinguished men, such as Cassiodorus, who was his private secretary, and Boetius, who has written a eulogy of his master, which however is far from containing all the truth. He was celebrated as a hero in the old Teutonic songs, and in the *Nibelungen-Lied* he appears as Diederich of Bern, that is, Verona.

Theodoric was not only a conqueror; he was also a legislator. [TEUTONIC NATIONS, *Goths*.] It is his greatest glory that he was a friend of peace, of toleration, and of justice; a glory, however, which is somewhat obscured by his acts of rashness and violence. Whenever a war between Teutonic kings was threatening, he tried to prevent it by mediation; a fact which is proved by his letters to the kings of the Franks, of the Visi-Goths, of the Thuringians, of the Burgundians, of the Heruli, and of the Warni. He always reminded them that they were of one common origin, and that they ought to maintain peace and friendly intercourse. Theodoric was especially vigilant in preventing Clovis from invading the states of his neighbours; he protected the Thuringians and the remnant of the Alani, and he saved the kingdom of the Visi-Goths from extinction.

Manodius, *Panegyricus Regis Theodorici*, ed. Chr. Cellarius, 1703, 8vo.; and also in his *Opera*, ed. Jac. Sirmondus, Paris, 1611, 8vo.; Jornandes, *De Rebus Gothicae*; Cassiodorus, *Chronicon Gothorum*. &c.; Procopius, *De Bello Gothico*; Cochlaeus, *Vita Theodorici Reg. Ostrogoth.*, 1. Peringskjöld, Stockholm, 1699, 4to. Cochlaeus has written without any just criticism; and Peringskjöld has shown no historical ability in his additions, which however are a very interesting matter relative to the language and antiquities of the Goths. Manso's *Geschichte des Gothischen Reiches in Italien*, Breslau, 1824, 8vo., is a very valuable work.)

THEODORIC, a bishop and celebrated surgeon of the thirteenth century, was a pupil of Hugo of Lucca. He at first belonged to the order of the Preaching Friars (*Frères Prêcheurs*); afterwards he became chaplain to the Bishop of Valentia, and penitentiary to Pope Innocent IV.; and he was at last made bishop of Bitonti and Cervia successively. Towards the end of his life he settled at Bologna, where he died in 1298. He was especially distinguished from his contemporaries by not resting content with imitating his predecessors; on the contrary, he appears to have carefully studied the cases that presented themselves to his notice, and to have recorded in a great measure the results of his own observations. He also introduced several useful innovations in the practice of surgery, and was the first person who ventured to lay aside the cumbrous and frightful machines which had hitherto been used in the reduction of fractures and luxations. He left behind him a surgical work, entitled '*Chirurgia Secundum Medicationem Hugonis de Luca*,' which was published at Venice in 1490 and 1519, in folio. (Haller's *Biblioth. Chirurg.*; Sprengel's *Hist. de la Méd.*; *Biographie Médicale*.)

THEODORUS (*Θεόδωρος*), a native of Cyrene, was a philosopher of the Cyrenaic school, who lived towards the end of the fourth century B.C. He was a pupil of Arete, the daughter of Aristippus, and afterwards became the successor of Anniceris. His philosophical system, which

was a kind of medium between that of Aristippus and Anniceris, appeared so dangerous to his fellow-citizens, among whom he had been held in very high esteem, that they banished him from their city. Theodorus went to Athens, where he would have experienced worse treatment if Demetrius Phalereus had not interposed and saved him; for here too his doctrines soon came into disrepute, and a public accusation was brought against him of moral and religious indifference. After the fall of Demetrius Phalereus, Theodorus thought it advisable to withdraw from Athens, and he went to Egypt, where he soon gained the confidence of Ptolemaeus Soter, who, on one occasion, sent him as his ambassador to Lysimachus. On this mission Theodorus is said to have shown much courage and a strong feeling of independence towards Lysimachus, who taunted him for having been obliged to leave Athens. The time of his death is unknown.

We do not possess a complete view of the philosophical system of Theodorus, but he appears to have been one of the forerunners of Epicurus. His ideas of the deity were explained in a book which he wrote on the gods (*περὶ θεῶν*), and which earned him the name of atheist, though it is doubtful whether this opprobrious name was given him because he really denied the existence of gods, or merely because he was above the common prejudices of his countrymen. The following doctrines are especially mentioned as characterising his views of human affairs:—wisdom and justice are desirable, because they procure us the enjoyment of pleasure; friendship, on the other hand, has no real existence; for, in a person who is not wise, it ceases as soon as he ceases to feel the want of it, and a wise man is in want of nothing beyond himself. Patriotism is not a duty, because it would be absurd to make it incumbent upon a wise man to sacrifice himself for the ignorant, who form by far the majority of a state. His followers, who constituted one of the three branches into which the Cyrenaic school was divided, were called Theodorians. (Diogenes Laert., ii. 86; vi. 97; Cicero, *Tusculan.*, i. 43; v. 40; *De Natura Deorum*, i. 1, 23, 43; Suidas, s. v. *Θεόδωρος*.)

From the philosopher Theodorus of Cyrene we must distinguish Theodorus the mathematician, who was a native of the same place, and is mentioned among the teachers of Plato. (Xenophon, *Memorab.*, iv. 2, 10; Maximus Tyrius, *Dissertat.*, 22.)

THEODORUS PRISCIANUS, the author of a Latin medical work, which is still extant, and which sometimes goes under the name of *Octavius Horatianus*. He was a pupil of Vindicianus, and is supposed to have lived at the court of the emperors of Constantinople in the fourth century after Christ. He belonged to the sect of the Empirici, but appears to have also mixed up some opinions of the Methodici, and even of the Dogmatici. His work, which is not of much value, is entitled '*Rerum Medicarum Libri Quatuor*,' and is written in a barbarous Latin style. The first book treats of external disorders, the second of internal, the third of female diseases, and the fourth of physiology, &c. It was first published in 1532, fol., at Strassburg, and also in the same year at Basle, 4to.; of these two editions, the former is the more complete, the latter the more correctly printed. A new edition was undertaken by J. M. Bernhold, of which the first volume was published in 8vo., without place or date, at Ansbach in 1791; but which, in consequence of the editor's death, has never been completed. Another work, entitled '*Diaeta, seu de Salutaribus Rebus Liber*,' has been attributed to Theodorus Priscianus, but (as Choulant thinks) incorrectly. It was first published together with '*Hildegardis Physica*,' Argentor., 1533, fol. It first appeared in a separate form at Halle, 1632, 8vo., edited by G. E. Schreiner, and was afterwards inserted in Rivinus's collection of ancient physicians, Leipzig, 1654, 8vo. (Haller's *Biblioth. Medic. Pract.*; Sprengel's *Hist. de la Méd.*; Choulant's *Handbuch der Bücherkunde für die Aeltere Medicin*.)

THEODORUS, or DIODORUS, OF TARSUS, of a noble and very distinguished family, lived in the fourth century of our æra, and was most probably born at Antioch. He studied under Sylvanus Tarsensis; and after having taken orders, he first became priest, and then Archimandrita at Antioch. The Catholic churches of this town having been shut up by order of the emperor Valens (A.D. 364-378), who was an adherent of Arianism, Theodorus

preached in the fields round the town, and he was always surrounded by a numerous congregation of Catholics. He also defended the orthodox faith with great intrepidity against the attacks of the Arians and the tyranny of Valens. Immediately after the death of Valens, he was appointed bishop of Tarsus 378, Gratianus, the successor of Valens, being a zealous Catholic. In 381 Theodorus was at the Council of Constantinople. The year of his death is not known, but as Phalerius was chosen bishop of Tarsus in 384, it is probable that he died in this year. Theodorus was much esteemed by his contemporaries for his plain and lucid eloquence, but though he was known as the most zealous defender of the Catholic faith, he was accused of having shown himself favourable to the heretical doctrines of Nestorius. The same charge was made against his contemporary Theodorus of Mopsuestia. Theodorus of Tarsus wrote numerous works on theology and morals, none of which have come down to us. It is said however that one of his works on Politics, which Fabricius believes to be identical with another work on Providence, exists in a Syriac translation.

(Cave, *Script. Eccles. Historia Literaria*, vol. ii., p. 266, 267; Fabricius, *Bibl. Græca*, p. 380, 381.)

THEODORUS I., a native of Greece, and son of Theodorus, patriarch of Jerusalem, was elected bishop of Rome after the death of John IV., A.D. 641. Constans II. was then emperor of Constantinople, and Rotaris was king of the Longobards in Italy. The heresy of the Monothelites was disturbing the church, and it was supported by the emperor Constans, and by Paulus, patriarch of Constantinople. Theodorus held a council at Rome in 648, in which Paulus was excommunicated. It does not seem proved however that Theodorus condemned, as some have asserted, the *typus* or edict of the emperor Constans, in which he forbade all his clergy from disputing on the subject of the two wills in Christ, the Monothelites asserting that there was only one will in him. [EUCYCHIANS.] Theodorus built several churches at Rome. He died in 649, and was succeeded by Martin I. (Muratori, *Annali d'Italia*; Panvino, *Vite dei Pontefici*.)

THEODORUS II., a native of Rome, was elected pope after the death of Romanus, in August, 897, and died three weeks after his election, and was succeeded by John IX.

THEODORUS LASCARIS, emperor of Nicaea, was descended from an ancient and noble Byzantine family, the early history of which is unknown. In 1198 he married Anna Angela-Comnena, the widow of Isaac Comnenus Sebastocrator, and the second daughter of the emperor Alexis III., Angelus-Comnenus, who usurped the throne of Constantinople, after having blinded and thrown into a prison the emperor Isaac Angelus (1195). Alexis, the son of Isaac, fled to Italy and implored the protection of the Western princes, who, in 1203, were assembled at Venice for the purpose of a new crusade. They promised him assistance, and sailed to Constantinople with a powerful fleet, commanded by Dandolo, the doge of Venice. They laid siege to Constantinople, but although Theodore Lascaris prepared a vigorous resistance, Alexis III., who was of a mean and cowardly character, secretly left his capital and fled to Conrad, marquis of Monteferrato, in Italy, who had married his sister Theodora. Assailed by bold and experienced troops, and abandoned by their emperor, the Greeks were struck with alarm: they surrendered their capital, and did homage to the blind Isaac and his son Alexis IV. (19th of July and 1st of August, 1203), who reigned together under the protection of the Latin princes. However, Alexis Ducas Murzuphlus had made a party among the Greeks, who were enraged at the haughtiness of their foreign protectors. He murdered Alexis IV., Isaac died of grief, and Murzuphlus was proclaimed emperor under the name of Alexis V. (28th of January and 8th of February, 1204). The Latins immediately laid siege to Constantinople, to avenge the murder of their ally and friend; and although the new emperor, assisted by Theodore Lascaris, defended the capital with skill and energy, the fall of this city became imminent. Suddenly Alexis V. fled with his treasures (April, 1204), and the consternation which had reigned after the flight of Alexis III. once more discouraged the Greeks, and led to anarchy. During a period of six months, four, and as Isaac reigned twice, five emperors successively occupied the throne; and such was the passion for ruling among the

Greek nobles, that in this critical moment, when the very existence of the empire was at stake, two candidates presented themselves to the people for the purpose of obtaining the crown.

These candidates were Theodore Lascaris and Theodore Ducas, who was of Imperial descent. Lascaris was proclaimed emperor, but fearing some sudden opposition from the adherents of the fugitive emperors, he declined the Imperial title, and declared he would content himself with that of 'despote' until he had re-established tranquillity. However, while he encouraged the people to resist the besiegers, the Latins made an assault and succeeded in taking the town, the Greeks having cowardly abandoned their posts. During the confusion of plunder and violence, Theodore Lascaris escaped with his wife Anna, and fled to the opposite shore of Asia. The Latins chose Baldwin, count of Flanders, emperor of Constantinople, and gave him the capital and one-fourth of the empire; the remaining three-fourths were divided between Venice and the Frankish barons.

Meanwhile Theodore succeeded in raising troops in Asia, and, assisted by the Turks of Koniah, or Iconium, he made himself master of the important town of Nicaea and the greater part of Bithynia, proclaiming that he acted only as despote, and in the name of his father-in-law, the fugitive emperor Alexis III. (Autumn, 1204). His conquests were soon taken from him by Louis, count of Blois, who, in the division of the empire, had received Bithynia, and who defeated Theodore at Paemanene, on the frontiers of Mysia and Bithynia (6th of December, 1204). Theodore retired to Brusa, one of the few towns which had not fallen into the hands of the count of Blois; but he was pursued and obliged to fight with Henry, count of Flanders, the brother of the emperor Baldwin, who defeated him.

Theodore would have been ruined but for the assistance of the king of the Bulgarians and the revolted troops of the emperor, who was obliged to call to his assistance the count of Blois and the Latin troops of Bithynia. Theodore again became master of the town, and his father-in-law, Alexis III., being then prisoner by the marquis of Monteferrato, he himself assumed the title of emperor. He styled himself *Βασιλεὺς Ἀβροκράτωρ Ρωμαίων*, which was the title of the emperor of Constantinople, and he thus showed that he considered himself as the only legitimate emperor of the East, having a right to the crown by his wife Anna, the daughter of Alexis III., who was prevented from ruling on account of his captivity, and all the other emperors of Greek extraction being then dead. In order to solemnize his accession to the Imperial throne, Alexis convoked a general assembly of the Greek bishops, who met at Nicaea. The new patriarch, Michael Autorienus, presided, who had been chosen for the special purpose of crowning Theodore, the patriarch Didymoticus having resigned.

Meanwhile several Greek nobles, profiting by the hatred of the Greeks against the Latin conquerors, made themselves independent in Asia. Theodore Morotheodorus, reigned at Philadelphia, and Michael Comnenus, supported by Ghaiyâth-ed-dîn, sultan of Phrygia; but they were both overthrown by the emperor of Nicaea, as Theodore Lascaris called. A third and more dangerous adversary was the emperor of Trebizond, Manuel Comnenus, who had reigned as emperor at Trebizond the year 1204, and whose brother David overran as far as the Propontis and the Ionian Sea. David and Manuel were equal in military skill, but unequal in perseverance: neither of them was distinguished by any great feats, nor made less vigilant by sudden success. In their first encounter, David, appreciating the character of his adversary, concluded an alliance with Henry, brother of Baldwin. Theodore however defeated Manuel, and some time afterwards David was again defeated and beaten by Guido Andronicus, the general of the emperor of Nicaea. After the truce between Theodore and Manuel in 1210, David, who had hitherto carried on the war with various results, was compelled to give up all idea of keeping the field any longer. He lost all his possessions, and his brother Alexis was obliged to cede them to Manuel (1214), who thus became master of the greater part of Paphlagonia.

The truce between Theodore and Henry was the end

ce of various victories obtained by Theodore over the Franks. In 1207 the emperor of Nicaea, besieged by the Franks in Nicomedia, but in a sally de prisoner Count Thierry de Los, or more cordierik van Looz, a powerful baron from the Lowies, and a descendant of the first dukes of Lower ie. Henry ransomed the count by surrendering fortified towns to the emperor of Nicaea, and arments were made which led to the truce of 1210. In ar the old emperor Alexis III., who had escaped he marquis of Monteferrato, fled to Asia, to the of Sultan Ghaïyâth-ed-dîn, and persuaded him to t his claims to the throne of Nicaea, or of any other the Eastern empire. The sultan summoned Theo- restore his father-in-law to the throne, and left at the head of 20,000 men. He was attacked in gighbourhood of Antioch by Theodore, who had only ten, but who charged the Turks with such impe- that their lines were broken, and they were entirel d. Ghaïyâth-ed-dîn himself was killed by Theo- old Alexis was made a prisoner (1210). He was d to a monastery at Nicaea, where he died some sterwards. Although Theodore had acted in his n-law's name while he was only despot, he had d the throne in his own name and at his own risk. re's wife, Anna, the daughter of Alexis, was then

said that in 1214 Theodore fell into the hands of lîn Key-kaus, the successor of Ghaïyâth-ed-dîn : but n error, and Fallmerayer, in his work cited below, wn that it was Alexis of Trebizond who was made r by the sultan. Except one short campaign against n 1213, which was followed by a truce in 1214, re reigned the last ten years of his life in peace, by his friends and respected by his enemies. After th of Anna he married Philippa, an Armenian prin- om he repudiated after she had borne him a son ; 1220 (?) he chose for his third wife Maria, the of Peter of Courtenai (Kortryk), emperor of Con- ne after Henry, who was sister to Robert, the son cessor of Peter. Theodore wished to give his er Eudoxia in marriage to Robert, who was of a ild and amiable character, but this marriage was r opposed by the Greek patriarch Manuel, because r emperors were brothers-in-law, and it was not car- o effect.

ore died in 1222, being between forty-five and fifty ld, in the same year with Alexis I. of Trebizond. gh he left a son, his successor was his brother-in- in Vatatzes. One of Theodore's daughters, Maria, ied to Andreas, king of Hungary.

as, *Alex. Comn.*, and *Balduinus*; Acropolis, espap. vi.; *Historia Franco-Byzant.*, lib. iii.; Gibbon, and *Fall*; Le Beau, *Histoire du Bas Empire*; ryer, *Geschichte des Kaiserthums Trapezunt.*)

ODORUS, Sculptor. [SCULPTURE.]

ODORUS of Bithynia or of Tripolis in Lydia, for it that both these descriptions are applied to him t there is another Theodosius of Tripolis, the author scure poem), was a mathematician, of whom there question whether he lived about fifty years before or some centuries after. Strabo and Vitruvius both t a Theodosius : the latter speaks of him as the in- of a dial for every climate (or latitude) : if this be ject of our article, he must have lived before Christ.

the other hand, Ptolemy does not mention him t this tells little either way) ; and Suidas, enumerat- ler the head of Theodosius the works we shall pre- ntion, adds that he was also a commentator on arts of Theudas : if this be the case, he must have ter Christ. The balance of authorities seems to our of the former supposition : if the writings only oved at, there would be little reason to doubt that re composed before the time of Ptolemy.

have left of Theodosius—1, *Σφαιρικά*, Spherics, in ooks ; 2, *περὶ νυκτῶν καὶ ἡμερῶν*, in two books ; *οὐρανίωνων*. The first is a profound and accurate work t we should now call spherical geometry ; the and third simply describe astronomical phenomena appear in different parts of the world. It is hardly r of certainty that the three works have the same : the second and third add nothing to the fame of hor of the first.

The Spherics were translated by the Arabs, and from their version a Latin one (of little worth) was made at Venice in 1518, but whether it was published is not stated (Heilbronner). Another Latin version, probably also from the Arabic, was published by Vogelinus at Vienna, 1529, with scholia. John Pena gave the first Greek text, with Latin, Paris, 1557 ; and Barrow gave a Latin edition in 1675. But the best edition is the Oxford one, Greek and Latin, 8vo., 1707. The other works were published by Dasypodius, in Latin, Straasburg, 1572, 8vo. Joseph Auria published the third work in Latin, Rome, 1587 ; and (*Biogr. Univ.*) the second, also in Latin, Rome, 1591 (1587, according to Fabricius) ; but Heilbronner does not mention this last. (Wedler ; Heilbronner ; Delambre.)

THEODO'SIUS I., FLA'VIUS, surnamed the Great, was the son of the general Theodosius who had signalled himself greatly during the reign of Valens and Valentinian in Britain and Africa, but was put to death in A.D. 376 at Carthage through the envy of the courtiers. The Theodosii were an illustrious family of Spain, of the town of Italica, near the modern Seville. The great Theodosius was born in A.D. 345, and was educated by the ablest men of the time, while his father, himself one of the greatest generals, instructed his son in the art of war, and accustomed him to the strictest and severest discipline. He took him with him in his campaigns in Britain, Germany, and Africa, and made him acquainted with all kinds of warfare, so that the boy became early accustomed to the endurance of hardship. The various occasions on which he distinguished himself were not overlooked, and he was raised to the rank of duke of Moesia, with an independent command. Here again he distinguished himself above all the other military commanders. He vanquished the Sarmatians, and it was only owing to his intrepid character that the province was not lost altogether. (Ammianus Mar- cel., xxix. 6 ; Zosimus, iv., p. 219, &c.) After the death of his father, in A.D. 376, he obtained permission to withdraw from public affairs, and retired to Cauca in Spain, where he devoted himself to agricultural occupations on his extensive estates, and won the affection and esteem of all who came in contact with him, for he possessed no less the virtues of social and domestic life than the talents of a general. But he did not remain long in the enjoyment of his quiet happiness : his virtues and talents had made too deep an impression to be forgotten in the hour of need ; and on the 16th of January, 379, the emperor Gratian raised Theodosius at Sirmium to the dignity of Augustus, with the command over Illyricum and all the eastern provinces of the empire. The immediate object of this elevation was the hope that he would save the empire from the Goths, who in the preceding year had totally defeated the Roman army near Adrianople, and were now ravaging the country. Theodosius established his head-quarters at Thessalonica in Macedonia, strengthened the garrisons in those parts of the empire, and restored discipline among the troops ; but he only ventured upon partial engagements with the enemy, and only on such occasions when he was sure of success. He thus convinced his soldiers that the barbarians were not invincible, and revived their courage and their confidence. The Visi-Goths were thus gradually and without any great battle driven out of Thrace. While at Thessalonica, Theodosius was seized with a severe illness. He was of a Christian family, but had not yet been baptized, and he now celebrated this solemnity by the advice of his friends, in the hope that it would contribute to his recovery. When his illness had disappeared, he went to Constantinople, and the first acts of his administration were to expel all the Arians from the capital, to assign the churches they had occupied to the orthodox Christians, and to appoint Gregorius Nazianzenus archbishop of Constantinople (A.D. 380). His persecution of the Arian sect was conducted with such zeal, that orthodoxy was soon restored throughout his dominions. He then held a council at Constantinople of 150 bishops to complete the system, the foundation of which had been laid at the council of Nicaea, and a number of edicts were successively issued, inflicting the severest punishments upon all kinds of heretics. The example of these rigid persecutions was imitated in the west by Gratian, and subsequently in the north also by the usurper Maximus.

As regards his Gothic enemies, Theodosius was indebted as much to his good fortune as his military talents ; for

after the death of Fritigern dissensions and hostilities broke out among the Gothic tribes themselves, and he succeeded even in engaging some of their chiefs in the service of the empire. The greater part however of the subjects of Fritigern, tired of their state of anarchy, made Athanaric their king, who concluded a treaty with Theodosius at Constantinople (A.D. 381). Athanaric indeed did not long survive the conclusion of this peace, but his subjects, who were pleased with the kind treatment they had received from Theodosius, willingly submitted to him, and numbers of them enlisted under the Roman standard. The treaty of the king and the submission of his army was followed by successive separate treaties of the Visi-Gothic chiefs, who promised to become the faithful allies of the Romans. Lands were then assigned to the Visi-Goths in Thrace and Lower Moesia (A.D. 382). The Ostro-Goths on the banks of the Danube were conquered several years later (A.D. 386), and received settlements in Phrygia and Lydia. The conditions on which the Goths became subjects of the Roman empire are imperfectly known: thus much only is certain, that they acknowledged the sovereignty of Rome without submitting to her laws or the jurisdiction of her magistrates; their chiefs also still continued to have the command of their respective tribes in peace and war, and an army of 4000 Goths was maintained for the perpetual service of the empire. Theodosius, although he had felt obliged, for the safety of his dominions, to make several concessions, yet succeeded in persuading the Goths that all were the voluntary acts of his own sincere friendship towards them. The conduct of the emperor, certainly the wisest that he could adopt under existing circumstances, was praised by some and blamed by others. There was certainly every reason for placing little confidence in the professions of the barbarians, although they called themselves the confederates of the Romans. Their whole nation soon became divided into two parties: the one, faithful to the empire, was headed by Fravitta; the other, which was only waiting in secret for an opportunity to revolt, was headed by Priulf, who, after he had disclosed his secret in the presence of Fravitta, was slain by him. Had it not been for the firm but temperate character of the emperor himself, the indomitable spirit of the barbarians could not have been restrained. On him alone the public safety depended.

In the year 383 Theodosius raised his son Arcadius to the rank of Augustus: in the same year his benefactor Gratian was murdered in a rebellion. Maximus, supported by the troops in Britain, had set himself up as emperor, and had conquered Gaul. Theodosius, who for the present was unable to carry on a war, concluded a peace with him, and left him in possession of the countries which he was occupying north of the Alps, on condition that he should not disturb Valentinian, the brother of Gratian, in his rule over Italy, Africa, and western Illyricum. The empire was thus divided among three emperors. But Maximus had no intention to keep the peace, and his ambition stimulated him to make himself master of Italy also. In A.D. 387 he broke in upon Italy, and took Milan, the residence of Valentinian, by surprise. The young emperor, his mother Justina, and his sister Galla, fled to Thessalonica, to implore the protection of Theodosius. The emperor of the East received the fugitives kindly, and as his own wife Flacilla had died, he married Valentinian's sister Galla, and thus established a direct interest for himself in protecting the exiled family. The opportunity of chastising the faithless Maximus was very welcome to him, and preparations for war were made throughout the whole extent of his dominions. In order to secure his empire on its south-eastern frontier, a treaty was concluded with Persia. A large fleet assembled in the ports of Epirus and Greece, and Theodosius placed himself at the head of a well-disciplined army, with which he marched into Pannonia to meet the enemy, who had pitched his camp in the neighbourhood of Siscia, on the Drave. A battle was fought, in which the Huns, Alani, and Goths, who served in the army of Theodosius, greatly distinguished themselves. Maximus was defeated and put to flight. Theodosius, determined to get possession of his enemy either alive or dead, pursued him as far as Aquileia, in which town Maximus shut himself up. The usurper, who had no hold on the affections of the people, was dragged forth from his palace into the hands of the

conqueror, who gave him up as a victim to the rage of the soldiers. Victor, the son of Maximus, was killed by the hand or at the command of Arbogastes, the Frank, who made himself master of Gaul (A.D. 388).

After having thus easily and quickly terminated a war which had threatened the empire with long and serious calamities, Theodosius stayed for three years in Italy to regulate the state of the western provinces, and it was in this period that he showed his great and amiable character in the most brilliant light. He not only spared the lives of the friends and relatives of Maximus, but afforded them every support in their misfortunes, while, on the other hand, he restored to the oppressed people of the west their lands, and gave them compensation in money for the losses that they had sustained. In the year 389 he entered Rome in triumph, together with his son Honorius and Valentinian.

During the period of his stay in Italy an insurrection broke out at Antioch, in which the people demanded redress of several grievances, especially a diminution of their heavy taxes. When these demands were haughtily refused by the imperial officers, the populace destroyed the statues of Theodosius, his wife Flacilla, and of his sons Arcadius and Honorius. The insurrection however was soon put down, and when Theodosius was informed of the occurrences, he sent Hellebrius and Caesarius to inflict the most severe punishment upon the city. But when messengers came soliciting a milder treatment, and assuring the emperor that the people sincerely repented of their crime, he generously granted them a general pardon. But this generous act was followed by another which was as rash as it was cruel. In A.D. 390 another insurrection broke out at Thessalonica, in which Botheric, the commander of the garrison, and several other officers, were cruelly murdered by the people, because they refused to give up a handsome boy to the unnatural lust of some dissolute favourite of the people. Theodosius was at first uncertain whether he should take vengeance upon the city or exercise clemency as he had done towards Antioch. Rufinus induced him to do the former, and commissioners were accordingly sent to punish the criminal inhabitants. Theodosius however soon regretted his step, and countermanded his orders; but it was too late: a general and indiscriminate massacre took place in the devoted city, in which no less than 7000 lives were sacrificed to the manes of Botheric. When Ambrose, the archbishop of Milan, was informed of this cruel massacre, he was seized with indignation and grief: and eight months later, when the emperor, on Christmas-day, wanted to attend the service in the great church of Milan, he was stopped in the porch by Ambrose, and was not admitted until he had promised to do public penance for his monstrous cruelty. [AMBROSE.] It was not till after the lapse of eight months from that day that the emperor, who had performed all the acts of public penance which the archbishop had imposed upon him, was restored to the communion of the faithful. An edict was at the same time issued that no capital punishment should henceforth be inflicted on any one till thirty days after it had been pronounced. During his stay in Italy Theodosius acted as a kind of guardian of the young emperor Valentinian, whom he might have deprived of his empire with the greatest facility and perfect impunity if he had been less magnanimous. When he left Italy for Constantinople in A.D. 391, he left Valentinian in the apparently secure possession of the western part of the empire. It was one of the characteristic features of Theodosius to carry into effect his great plans with the utmost vigour and energy, but when the object was attained he sank into a state of indolence, and gave himself up to the enjoyment of pleasures which, although harmless in themselves, in many cases prevented him from deriving all the advantages from his successful undertakings that he might have done. This was also the case after his return to Constantinople. The most important occurrence in the year of his arrival there was the final and total abolition of paganism throughout the Roman empire. In the following year 392 Valentinian was murdered at Vienna, in Gaul, by Arbogastes, who raised Eugenius, a rhetorician, to the imperial throne, whose name he himself hoped to wield the sceptre. Theodosius, who had allowed himself to be deceived by the professed faithfulness of Arbogastes, was deeply moved when he heard of the fate of his brother-in-law and of

e elevation of Eugenius. But he was at that moment prepared for a civil war, and the ambassadors of Eugenius were consequently received with apparent favour & dismissed in a friendly manner. Preparations for war were, which lasted for almost two years, were immediately commenced, and Stilicho and Timasius were charged with recruiting and disciplining the forces. In the spring of the year 394 Theodosius set out from Constantinople against Eugenius. The armies met in Pannonia, and, after a long and dubious contest, Eugenius was defeated on the banks of the Cold River, near Aquileia. Eugenius was put to death, and Arbogastes in despair put an end to his own life. Theodosius was now sole emperor of the Roman world, and was cheerfully acknowledged by all the provinces, even by those which had recently paid tribute to Eugenius. The empire might now look forward to a period of peace and happiness under the administration of Theodosius. But he was suffering from gout, and his health was rapidly declining. He died on the 17th of January, 395, at Milan, whence his body was conveyed to Constantinople, and buried there. His two sons, Arcadius and Honorius had been raised to the rank of caesars, and the father had shortly before his death divided the empire of the West, while Arcadius occupied the throne of the East. The Roman empire from that time forth remained divided into the Western and the Eastern empires. [ROME, p. 110.]

10. Aurelius Victor, *Epitome*, c. 48; Orosius, vii. 34, 35; Zosimus, vii. 2; Paulus Diacon., ii.; Compare Gibbon, *History of the Decline and Fall*, c. 26, 27, and 28.)

THEODO'SIUS II., or the Younger, was the son of Arcadius, and grandson of Theodosius the Great. He was born on the 10th of April, 401. His father died in 408 at Constantinople, and left his son, then a child seven years old, at the head of the Eastern empire. There is a tradition that Arcadius in his will made Jezdegerd, king of Persia, the guardian of his son and regent of the empire during his minority. (Jornandes, *De Bell. Pers.*, i.) This isolated account however scarcely deserves credit, and it is a fact that Anthemius, the præfectus prætorio, was the very first assumed the government of the Eastern empire in the name of the young prince, and carried it on in a praiseworthy manner down to the year 414, when he voluntarily resigned it to Pulcheria, the sister of Theodosius, who was only two years older than her brother, and died shortly before received the title of Augusta. This woman continued to exercise the sovereignty in the name of her brother, not only after he had grown up to manhood, but down to his death, but even three years later, until she herself died. During the early part of Theodosius's reign Pulcheria herself conducted and superintended his education; but the prince seemed to possess no ambition, and to aspire to the glory of a monarch: he passed his life in a perpetual infancy, surrounded by women, eunuchs, and he idled away his time in hunting, painting, carving, and making elegant transcripts of sacred books. The whole government was carried on in his name; but whether its acts deserve praise or blame, he had no share in either, as he blindly acquiesced in all that his sister did. She also persuaded him, in A.D. 414, to marry Eudocia (before her baptism her name was Helenais), the daughter of Leontius, an Athenian sophist. Eudocia, a woman, who was no less distinguished for her beauty and intellectual powers, soon gave birth to a daughter, Eudocia, after which she was raised to the rank of Augusta. She lived with her husband till the year 444, when, having drawn upon herself suspicion of some immodest conduct, she was obliged to quit the court, and retired to Jerusalem.

In 421 a war broke out with Varanes, king of Persia, which was successfully concluded by Ardaburius, a general of Theodosius, and a peace was concluded for a hundred years, which lasted at least for thirty. With this exception the long reign of Theodosius was one of almost unbroken peace. It was only during the last years of his reign that the European parts of the empire were harassed by Attila and his Huns. [ATTILA.] The Asiatic provinces, on the other hand, continued to enjoy a quiet and permanent repose. Theodosius died on the 17th of July, 450.

11. Paulus Diacon., iv.; Zonaras; Socrates, *Histor. Eccles.*, i. 1, &c. Compare Gibbon, *History of the Decline and Fall*, c. 32, 33, 34.)

The reign of Theodosius II. is memorable in the history of jurisprudence through the collection of laws that was made in it, and bears the name of Codex Theodosianus.

THEODO'SIUS III., surnamed Adramytenus, emperor of Constantinople. He succeeded Anastasius II. in the year A.D. 715, being proclaimed emperor in the fleet of his predecessor near Adramyttium in Troas. He was a man of obscure birth, and accepted the throne with reluctance. He is praised for his unblemished conduct, and for the protection he afforded to the orthodox faith. He had not enjoyed his elevation much more than one year, when Leo III., a man of superior abilities, was proclaimed emperor. Theodosius willingly withdrew, and spent the remainder of his life, together with his son, in a monastery. (Theophanes, *Chronographia*; Georgius Cedrenus, *Compendium Historiarum*; Zonaras.)

THEODOSIAN CODE. In the year A.D. 429 Theodosius II. appointed a commission of eight persons, at the head of whom was Antiochus, to form a code out of all the constitutions and other laws which had been promulgated since the time of Constantine the Great. The code was to be formed on the model of the private compilations respectively called the Codex Gregorianus and the Codex Hermogenianus. Either nothing was done by this commission, or, for some reason, a renewal of it was thought necessary, and this renewed commission received its instructions in the year A.D. 435. This second commission consisted of sixteen members, with the same Antiochus at its head. In remodelling their materials the commission was empowered to omit the superfluous, insert the necessary, change the ambiguous, and reconcile the incongruous.

The code was completed and promulgated as law in the Eastern empire in the year A.D. 438; and it was declared that the laws enacted since the time of Constantine should only be in force so far as they were incorporated into this code. It was further declared, as it had been on the occasion of naming the first commission, that all the general constitutions which were made by the emperors of the East and West should be sent from the one to the other, but that each of them should have full power to adopt for the use of his own subjects, or to reject, what the other sent. The code was forwarded in the year 438 by Theodosius to his son-in-law Valentinian III., who confirmed it and laid it before the Roman senate, by whom it was received. In the year 448 Theodosius forwarded to Valentinian other constitutions which he had made since the completion of the code, as circumstances had arisen; and these new constitutions were promulgated in the Western empire in the same year. The new constitutions were called Novellæ, and all such new constitutions which were interchanged between the East and West, and had reference to the code of Theodosius, were called by the name Novellæ. This interchange subsisted as long as the empire of the West continued: the last constitution of the kind that we know is one of Anthemius, who was contemporary with Leo I. in the Eastern empire: it belongs to the year 468, and relates to Bona Vacantia.

This code consists of sixteen books, which are divided into titles, and the titles are subdivided into sections. The arrangement of the matter differs from that in the subsequent compilation of Justinian, also called the Code. The code of Theodosius treats of Jus Privatum in the first part, and especially in the second and fourth books, both included, and in the beginning of the fifth: the following books treat chiefly of Jus Publicum. The first book treats of offices, and the sixteenth book treats of matters pertaining to the Christian church. The code of Theodosius was the first great compilation of the kind, and it was much used in the compilation of the code of Justinian. It also forms the basis of the code of the Ostrogoths, called the Edictum Theoderici: it was incorporated into the code of Alaric II., commonly called the Breviarium, in an abridged form, accompanied by a continual interpretation or explanation; and it was used in the compilation of the Lex Romana of the Burgundians, which is often incorrectly called Papiani Liber Responsorum.

The greater part of the Theodosian code and of the Novellæ Constitutiones exist in their genuine state: the first five books of the code and the beginning of the sixth are chiefly found only in the Breviarium. The excellent edition of J. Gothofredus (6 vols. fol., Lyon, 1665, re-edited by J. D. Ritter, fol., Leipzig, 1736-1745), and also the edition of the Jus Civile Antejustinianum, Berlin, 1815,

have followed the text of the Breviarium for the first five books and the beginning of the sixth. But Clossius and Peyron have subsequently made additions to the first five books, and particularly to the first; the former from a Milan MS. of the Breviarium, and the latter from a Turin palimpsest of the Theodosian Code. (*Theodos. Cod. Genuina Fragmenta, &c.*, W. F. Clossius, Tüb., 1824, 8vo.; *Cod. Theodos. Fragment. inedit., &c.*, Amad. Peyron, 1823, 4to.) Hänel has also added to the later books. (Zimmern, *Geschichte des Röm. Privatrechts.*)

THEODOTIION, of Ephesus, the author of a Greek version of the Old Testament, was an Ebionite, and lived in the former part of the second century after Christ. He is quoted by Justin Martyr, in his dialogue with Tryphon (A.D. 160), and by Irenæus (A.D. 177). His version appears to have been undertaken for the purpose of furnishing the Ebionites with a more exact translation of the Hebrew text than that of the Septuagint, and one therefore which would render them more service than the Septuagint in their disputes with the Jews. It agrees almost exactly with the Septuagint, except that it supplies the deficiencies of that version, and omits those parts of it which are not in the Hebrew text. Theodotion had not a competent knowledge of Hebrew. He has retained certain Hebrew words which appear to have been in use among the Ebionites. Theodotion's version of Daniel was substituted by the ancient church for the Septuagint version of that book.

This version occupied one column of Origen's 'Hexapla.'

[ORIGENES.]

THEODOXIS, or THEODOXUS, Montfort's name for a division of the genus *Nerita*, type *Theodoxus Lutetianus*; *Syn. Nerita fluviatilis*, Felix de Roissy.

THEOGNIS (Θεογνης), an elegiac poet of Megara, the capital of the small state of Megaris, was living at the close of the sixth century B.C.; and it appears from his own writings that he lived to the date of the battle of Salamis, B.C. 480. In one of those revolutions which frequently occurred in the small Grecian states, the democratic body at Megara overpowered the aristocratic, to which Theognis belonged. Theognis, who was then absent from his country, lost his landed property in this revolution, which, with the rest of the Megarian territory, was partitioned among the successful party. It appears that he lived in exile at Thebes. The fragments of Theognis abound in allusions to the revolution by which he had suffered, and he expresses in bitter language his complaints against that base class which had usurped the station and property of the body to which he belonged. He had also the mortification of seeing a rich rival of mean birth preferred to him by the parents of a girl whom he courted. Yet he was in some measure indemnified for his loss by retaining the affections of the girl after she had married his ignoble rival.

It appears from his verses that he had been in Sicily, Euboea, and Sparta; and it was in Sicily that he wrote one of his elegies which was addressed to the Sicilian Megarians, who were a colony from his native state. There seems no reason to doubt that his elegies were composed on various occasions and on particular subjects, and that so far they resembled the elegies of Tyrteus, Archilochus, and Solon. But as these elegies contained numerous general maxims or lessons for conduct, it is conjectured that in the course of time nearly everything was omitted from them which had a particular application, and thus the elegies of Theognis were formed into that general collection of gnomæ such as we now have it, consisting of above fourteen hundred hexameter and pentameter verses. It is observed that nearly all the passages in this collection which have a political reference are addressed to a person named Cynrus, the son of Polypas. Cynrus appears to be a youth of noble family for whom Theognis has a tender regard, and whom he exhorts to the practice of virtue, to prudence in conduct, and to the enjoyment of life.

The verses of Theognis contain many allusions to the symposia, or entertainments, of the Greeks, in which it was usual, after the libation had been duly performed, for some of the guests to sing a poem, accompanied by the flute. This poem, or elegy, was addressed either to all the company, or, as appears to have been always the case with the elegies of Theognis, it was addressed to a single person.

The fragments of Theognis have been often printed.

They were first printed in the Collection of Gronov by Aldus, Venice, 1495; and they are also in Gaisford's 'Poetæ Minores Græci,' Oxford, 1814. Of the latest and best editions is by F. T. Weiske fort-on-the-Main, 1826. They were translated into German verse, with short notes, by G. Thudichum and also by W. E. Weber 1834.

(Müller, *History of the Literature of Antient vol. i.*; Hoffmann, *Lexic. Bibliograph.*; Fabricia *theca Græca*, vol. i.)

THEOLOGY (Θεολογία, the science which regards God).

In order to guard against any misconception of the subject of this article, it seems advisable to state in the first place that it is designed to treat the subject of theology purely in a scientific and historical point of view, and not in a doctrinal one. The object of the present discussion is to frame a system of Christian theology, which shall be consistent with the plan of this work.

I. DEFINITION OF TERMS.

All that men know of the nature of God, considered absolutely, of the relations between God and the world, and themselves and other beings on the earth, with the consequences resulting from those relations, and the duties arising out of those relations:—all this knowledge is described by the word *religion*. To reduce this knowledge to a systematic form, is the province of *theology*; and the truths of religion, when arranged in a scientific form, constitute a *system of theology*. Theology stands to religion in the same relation in which every other science stands to its subject matter, as natural philosophy to matter, metaphysics to mind, philology to language. By many writers the words *theology* and *religion* are used as synonymous terms; but such a usage of them is incorrect. [RELIGION.]

The above definition applies to the word as it is understood for some centuries; but its earlier signification was somewhat different from this. The *Θεολογία* of the ancient Greeks was φιλοσοφία πρὸς τῶν θεῶν, the philosophy of divine existences; and it included all questions relating to the origin, the nature, and the service of the gods. Aristotle uses the verb *θεολογῶ* *Μεταφυσ.* i. Cicero the noun *theologus* (*De Nat. Deor.* iii. 2). The wider signification of the word is used by Varro (*De Civitat. Dei*, vi. 5; compare Eusebius, *Præpar. Evang.* iv. 130), who distinguishes three different theologies: (1) *μυθικόν*, or *fabulosum*, mythical or legendary; (2) *φυσικόν*, or *naturale* (physical, or relating to the nature of the gods); (3) *πολιτικόν*, or *civile* (political or civil). Of these the first is the theology of poets, the second that of philosophers, the third that of the people. Varro expresses it, 'The first is chiefly adapted to the theatre, the second to the universe (*ad mundum*), the third to the city.'

In the New Testament the word is not used. It is used of the Apocalypse, in which the word *θεολογία* is applied to the author, is much later than the book itself. [CALYPSE.] The simpler terms *knowledge* and *faith* (πίστις) are those which approach most nearly to the meaning of the word *theology*; but the fact that the word *theology*, as a system, is not taught in the New Testament, there is nothing surprising in the absence of the word.

In the early Christian church the word was not used in the general etymological sense of the word, which relates to God and divine things; but it was employed at a very early period in a peculiar sense, in the controversies respecting the nature of Christ, the orthodox party adopted as a kind of motto the words of the Evangelist, *θεὸς ἦν ὁ λόγος* (the Word was God, *John*, i. 1), and the meaning which they attach to that sentence was transferred by them to the word *θεολογία*, which therefore, in this use of it, may be defined as the doctrine concerning the divinity of Christ. [LOGOS.] It is in this sense that the epithet *θεολογία* is applied to the author of the Apocalypse. In a still later period the word acquired a meaning somewhat more extensive, and was used to describe the whole teaching of the church concerning the Trinity.

Lastly, the modern usage of the word, as expressed

above definition, was first adopted by Peter Abailard (1142), who drew up a system of scholastic divinity, to which he gave the title of 'Theologia Christiana.' It should be remarked that instead of the Greek word *logos*, the Latin word *divinity* is often used to describe the science of religion.

II. FOUNDATIONS OF THE SCIENCE.

In every other science, theology consists in the application of the human reason to certain ascertained truths. The truths are, as is plain from the definition, the truths of religion. If therefore the existence of God, of attributes pertaining to him, and of relations subsisting between him and other beings can be proved, the foundations of theology are laid. Now all mankind, with the exception of a most insignificant minority (if indeed, which has been doubted, the existence of a real *atheist* be possible), believe either that these subjects are within the compass of human knowledge, or that some kind of revelation respecting these subjects has been made by God. [RELIGION; REVELATION.] Therefore, according to the general sense of mankind, theology is a possible science, founded upon knowledge derived from nature, or from revelation, or from both these sources.

It is true that attempts have been sometimes made to form a system of theology entirely out of the religious truths which may be learned from natural sources, that is, the constitution of the human mind, and from the phenomena of the mental and material universe. Such a system constitute *Natural Religion*, and form the subject-matter of the science of *Natural Theology*. But the vast majority of religious systems are founded on the supposed revelation of a divine revelation; and for this reason the science of theology is generally understood to have reference to *Revealed Religion*. Moreover, if it be true that a divine revelation has been given from God to man, it follows that that revelation cannot possibly be contrary to any of the truths of natural religion: also many might be urged to show that such a revelation, if completed, would contain in itself at least all the truths of natural religion, and, as a matter of fact, all the revealed religions in existence claim to teach everything which might be learned from nature concerning God; and the theology which is founded on revelation must therefore be within itself the theology which is founded on natural religion. For this reason the grand foundation of theology is usually understood to be revelation, to which natural religion is a valuable but not necessary auxiliary; and has even been disputed whether it is an essential part of a theologian's duty to establish the consistency between the doctrines of natural and revealed religion. In accordance with reference to the Christian religion, theology is founded entirely upon the canonical books of the Old and New Testament.

III. DIVISIONS OF THE SCIENCE.

With reference to its foundation, it is divided, as explained in the preceding paragraph, into *Natural* and *Revealed*, or *positive*. The latter word is used to indicate the foundations of revealed theology are the *expressed* will of God; just as we speak of *positive* laws.

The term *positive theology* is also used to describe any system of theology which rests upon authority, as, for example, the system embodied in the formularies of a particular church. See below, under the head of *Dogmatic Theology*.

According to the method of treating the subject, it is divided into *popular* or *biblical*, and *systematic* or *scholastic* theology.

According to the part of the subject which is treated, it is divided into *theoretical* and *practical* theology. Of the former includes—(1) The knowledge of the doctrines which contain the revelation, the proof of their truth, and the explanation of their meaning, that is, *Theoretical Theology*; (2) the investigation, arrangement, discussion of the truths so revealed, that is, *Systematic Theology*; (3) the workings and changes of religion among those who have professed it, or *Historical Theology*. *Practical Theology* has for its subjects the duties of practical religion, and the various modes of enforcing them; and with reference to the latter, it is divided into *liturgical*, or preaching; (2) *Catechetics*, or teaching; (3) *Liturgics*, or worship and the administration of the

sacraments, and (4) *Pastoral theology*, or the care and government of a church.

IV. OF DOGMATIC THEOLOGY, OR DOGMATICS.

This is a very useful term, which is chiefly employed by German writers. It may be defined as the science of exhibiting clearly, and of tracing to their results, the doctrines taught by revelation. It means more than the term *systematic theology*. The province of the latter is simply to give to the scattered truths of revelation the scientific form of a connected system, in whatever manner may seem most convenient to the framer of the system; but dogmatic theology aims at forming a system which shall be accepted as binding by a large body of religionists, and then views all religious truth in the light of that system: it is systematic theology, with the idea of *authority* superadded.

This may perhaps be made clearer by a reference to other branches of science. The natural philosopher, for example, observes certain phenomena, which he soon finds to have in them some points of connection or similarity; and by arranging the phenomena with reference to those points, he has reduced his knowledge of natural philosophy to a sort of system. He may have been deceived in his observations; the analogies he thinks he has detected may not really exist: but still the system he has framed may be for him a convenient classification of the observed phenomena: his system is a *theory*. But suppose him to proceed further, and to detect (in his own opinion) the real causes of the observed phenomena, and to trace them to further results: suppose that he frames a system of natural philosophy upon the principles which he has thus detected; and that this system is received by a number of men as furnishing a true explanation of the observed phenomena: then his theory has gained the element of *authority*, and it may be called a *dogmatic theory*. The former kind of theory may serve as an illustration of what is meant by *systematic theology*; the latter, of what is meant by *dogmatic theology*.

Now, in the case of the Christian revelation, it is a remarkable fact that the documents which contain it present no systematic form. The truths revealed in them, considered separately, may be called *dogmas*, since they all contain the element of authority; but as they are not systematically arranged, they do not form a *system of dogmatic theology*. But to such a system they might be reduced by a person who fully understood them in all their bearings; and supposing his qualifications for the task complete, his system would be a perfect system of dogmatics: absolutely true if the revelation were a true one; and therefore absolutely binding on all who accepted the revelation as true. Now, as a matter of fact, such an attempt has been made again and again: many systems of theology have been framed, each claiming to give an exposition of the word of God at once true and scientific. It is also a matter of fact that these systems have presented different and contradictory results: but many of them have been accepted as true by bodies of Christians; and they therefore form, to those who accept them, systems of *dogmatic theology*: and in many cases these systems are embodied in creeds, or confessions of faith, which then become for all future time the *dogmatics*, or *positive theology*, of those who accept them.

It has very naturally been usual for persons adopting a system of dogmatics to look upon their system not only as probably true, but as absolutely true; and hence they have given to it the title of *orthodoxy* (*ὀρθοδοξία*, the right belief), applying to every other system the name of *heterodoxy* (*ἑτεροδοξία*, another belief, i.e. than the right one). But it is deserving of notice that there are some subjects upon which a particular opinion has prevailed so extensively among Christians, that the word *orthodoxy* is applied to that opinion, for the sake of convenience, by persons who do not intend thereby to give their assent to the absolute truth of that opinion. Such a use of the word is found very convenient in ecclesiastical history. [HERESY.]

Illustrations of these remarks are furnished by the manner in which we commonly speak of the dogmas of the Roman and English churches, of Calvinistic and Arminian dogmas, of the orthodox and heterodox doctrines respecting the person of Christ.

Out of *Dogmatic Theology* springs *Controversial Theology*, or that mode of treating the subject of religion in

which some particular system of dogmatics is defended, or some other system attacked.

V. HISTORY OF THEOLOGY.

It is by no means intended to give under this head a sketch of the history of the Christian church, considered with reference to the development and diversities of theological opinions within it. Such a statement would be, properly speaking, a history of theology, and indeed such a history is at present a great desideratum in our literature. But the information which would be given on this head will be found for the most part already scattered through this 'Cyclopædia' in separate articles, to which therefore the reader is referred. All that will be attempted here is to point out the characteristic elements out of which the prevailing theology of different periods has been formed. The first thing to be done, then, is to classify those elements.

In the widest sense of the word Theology, including both natural and revealed theology, we have among theologians who reject revelation the systems of (1) *Atheism*, or that doctrine concerning God which rejects his existence altogether; (2) *Deism*, or the system which teaches that God is the Creator of all things, but that having once created them and impressed upon them certain laws for the regulation of their future existence, commonly called the *laws of nature*, he has left them to the government of those laws, and concerns himself no more with his creation; or in other words, this system acknowledges the existence of God, but denies his providence. (3) *Theism*, the system which differs from Deism by acknowledging the providence of God. The systems of Deism and Theism suppose the existence of an Almighty Creator, whose existence is independent of the universe (*principium extramundanum*); but there is another system according to which the laws of nature are in themselves the eternal self-existent causes of all the phenomena of the universe, and there is no causative principle external to nature. This system takes two different forms: *Materialism*, which makes all the phenomena of nature to result from the physical constitution of matter itself; and the various shades of *Pantheism*, which suppose an intelligent principle (*anima mundi*) to be inseparably connected with everything that exists, and to pervade the whole creation.

There is another system which stands apart both from Naturalism and Revelation, namely *Scepticism*; the leading principle of which is that in metaphysical inquiries, or in short in all subjects which do not admit of mathematical demonstration, certainty is unattainable, and consequently that neither from nature nor from a supposed revelation can we derive a sure religious belief nor a rational system of theology. [SCEPTICISM.]

These systems deserve notice in connexion with the history of theology, inasmuch as they relate to the same class of subjects as those which are embraced in theology; and they belong particularly to the history of Christian theology, inasmuch as at every period these systems have been brought more or less into direct collision with Christianity itself. But according to our more restricted definition of theology, as the science which is founded upon a divine revelation, and more especially as the science which has for its subject the religion of the Old and New Testaments, it will be found that the principal varieties in theological systems have arisen out of different opinions concerning that revelation itself, either with reference to the degree of its authority or to the mode of its interpretation.

1. With reference to the former point, the *authority of the Scriptures*, it would seem an axiom that every person who accepts them as a divine revelation must receive them as of full authority in matters of faith, and consequently that every system of theology must rest upon the admitted and unquestionable authority of the Scriptures. For this reason it would appear that all questions respecting the authority of the Scriptures are rather introductory to theology than a part of the science. But in point of fact different opinions are held on this matter by those who profess to receive the Christian religion, and therefore such opinions are considered to form a part of Christian theology.

Now with reference to this point every possible variety of theological opinion may be included under the two great divisions of *Supranaturalism* and *Antisupranatu-*

ralism or *Rationalism*; the former word being that theology which rests professedly on a special, natural revelation from God, and the latter for that which rejects all that is supernatural in such a revelation. The terms *Rationalism* and *Natural Theology*, etymologically meaning the same thing, are employed to describe different theological systems. Both make foundations of theology to rest upon the knowledge concerning God which may be learned by mere natural means but in natural theology the idea of a revelation is entertained, while rationalism (in the modern sense of word) professes to regard the Scriptures as possessed in some degree of authority, and indeed as upon the whole containing in some form or other the elements of truth.

The great question between supranaturalism and rationalism relates to the inspiration of the Scriptures. The adherents of the former system, though they differ respecting the mode in which supernatural information was conveyed to the minds of the sacred writers, agree in a great principle that they did receive such information to preserve them from all error in the statement of religious truth. Rationalists, on the other hand, either reject the dogma of inspiration altogether, or understand by it nothing more than that by the ordinary providence of God the natural faculties of the writers were brought into the best state for exercise while they were composing the Scriptures. Generally speaking, the rationalists as writers of the Scriptures to have had better information on the subjects they wrote about than any persons could acquire; and therefore, while reserving themselves the liberty of choosing what they will and what they will disbelieve, they upon the whole accept the facts and opinions contained in the Scriptures as the basis of their theology. [REVELATION.]

There is also a difference between supranaturalism and rationalism respecting the mode of interpreting the Scriptures: the former holding that the aid of the Spirit is vouchsafed to the humble inquirer into religious truth, the latter denying the existence of any other means of understanding the Scriptures than the natural powers of the human mind.

Some of the many forms which rationalism has assumed during the last century are almost indistinguishable from some of the forms of naturalism. [RATIONALISM.]

2. Supposing the Scripture to be received as strictly a divine revelation, the questions arise:—By whom, and on what principles, are they to be interpreted?

The opposite opinions on this point may be called the *Protestant* and *Catholic*, or the *biblical* and *positive* systems of theology. The fundamental principle of the Protestant or biblical system is that the Scriptures are to be interpreted by each individual reader according to the ordinary laws by which the meaning of any other book is ascertained; while the Catholic or positive system supposes the existence of a positive mode of interpretation, handed down by a tradition in the visible church through all ages of Christianity, and forming in fact a system of dogmatic theology, from which no individual is at liberty to differ upon the evidence derived from his own research. The Protestant theology may be supranaturalistic or rationalistic, according as it admits or rejects the dogma of the divine assistance granted to the inquirer; and it also branches out into two great divisions, which may be called *popular* and *critical* theology. The popular theology professes to be derived from the obvious meaning of the letter of Scripture, without any external aid: the critical theology is based upon the principle that, although God has granted to every humble and diligent inquirer the power of learning from the Bible itself all religious truth which it may be necessary for his safety that he should know, yet that there is a body of religious truth in the Bible which can only be discovered by applying to its interpretation all the resources of human learning and of critical investigation, and therefore that these means must be employed in order to the construction of a complete system of theology.

One important difference between the Protestant and Catholic systems is in the use they make of the body of historical testimony to the doctrines of Christianity.

The Catholic system esteems it the privilege of the true church to be the certain possessor and the authorised expositor of religious truth. In many of the ancient Chris-

ian writers it recognises members of the true church and uthorised teachers in it; and therefore it regards the octrines taught in their writings as the true doctrines of hrist. The obvious difficulty presented by the different pinions of various writers is removed in various ways. incent of Lirin has stated the Catholic dogma in the ollowing form:—'That which has been held always, every- here, and by all, is true.' (*Quod semper, quod ubique, &c.*) ut who are the *all*? All the orthodox: and it is the rovince of the church to determine who are orthodox nd who are heretics; and if the decision of the church n this point be doubtful, the appeal lies first to its autho- d teachers individually, and then to their collective vice as given in the decrees of a general council.

On the other hand the Protestant system recognises in : early Christian writers nothing more than persons of ous degrees of ability and information, whose state- ents and opinions are to be accepted or rejected entirely pon the grounds of ordinary criticism, and neither their achings nor those of any other person whatever are llowed to have any authority beyond that due to their insic worth and to their agreement with Scripture.

The application of these principles to the canon of Scrip- is an important point of difference between the Roman atholic and Protestant systems. The former rests upon e authority of those books which have been declared onical by the voice of the church as expressed in gene- councils; the latter looks to historical and critical evi- ence to determine the genuineness and authenticity of e books of Scripture, and then it finds the evidence of eir inspiration, and consequently of their authority, in e statements and claims of the writers themselves, which st not merely on the established honesty of the writers, at chiefly on the attestation of the miracles they wrought. ANON; MIRACLES.]

3. Another mode of interpretation leads to the systems f theology which are embraced under the name of *mys- icism*, the great principle of which is, that within the ind of the true believer there exists a sense of truth hich will always lead him to a surer and higher know- dge of religion than he could ever gain from his own itical inquiries or from the teaching of other men. XOSTICS; MYSTICS.]

4. To trace the relation of one set of truths to another, nd to show the coincidence of the same truths when roved by different trains of reasoning, is one of the high- t objects of true philosophy: and, on the other hand, an unwillingness to renounce a cherished belief when it is und opposed to a newly discovered truth, is one of the rongest tendencies of the human mind. Hence have

umerous theological systems according as men e brought the tenets of Judaism, the systems of heathen igion, and the reasonings of philosophy, into comparison ith the statements of the New Testament. From the first f these processes arose the Judaizing sects of the first two hree centuries, from the second many of the early riesies, such as Manichæism [HERETICS; MANICHEES], nd from the third the theology of the New Platonists and hers of the early Alexandrian school, and that of the hoolmen of the middle ages.

5. Besides the classification, which we have thus at- ted, of systems of theology, according to the funda- tal principles on which they rest, there is another ortant division of them according to their actual dif- nences of doctrine. On this subject, for the reasons above d, the reader is referred to the several articles in which account is given of the tenets and history of the prin- ipal doctrinal sects.

It only remains to give a slight sketch of the influence of se different systems in the history of Christianity. At the of Christianity the *popular biblical* system was that h naturally prevailed, with a partial intermixture of the *ive* system, arising out of the great deference always d to the first teachers of a new religion by their dis- pes, and more especially out of the authority with which e apostles were invested. The novelty and simplicity of e religion impressed its truths clearly on the minds of e first believers, who had no historical difficulties to lve, no contending sects to decide between, and no ure to speculate on the ultimate consequences of the octrines they received, or on their relations to other sup- ed truths. If a difficulty arose, their teachers were at d to solve it. And accordingly the language of the P. C., No. 1529.

apostolic epistles invites the believers to examine the truth for themselves and to receive it in its simplicity, though it also gives hints of the existence of a consistent system of truth, and claims on the part of the apostles to be the teachers of that system. But they did not teach it *as a system*, and it is only in the later books of the New Testa- ment, the writings of John and some of those of Paul, that any tendency to reduce Christian truth to a system be- comes apparent. The degree of freedom thus left to be- lievers was abundantly used, and before the close of the apostolic age different opinions had sprung up, exempli- fying nearly all the principles above described. [HERETICS.] To restore unity to the church, and especially to settle the orthodox doctrine respecting the person of Christ, was the object of the Council of Nice, in the creed of which we find the first appearance of a system of *positive* theology. [NICE, COUNCIL OF; NICENE CREED.] The immediate consequence of this Council however was to exasperate the very controversy which it professed to settle, and which continued to rage during the following centuries. [ARIANS; NESTORIANS; THEODORETUS.] These and other controversies led to the frequent meeting of councils [ŒCU- MENICAL COUNCILS], and to the settlement of the canon of Scripture about the end of the fourth century [CANON]; while at the same time the episcopal system became more and more firmly established; and from all these causes theology acquired more and more the form of a *positive* system, the most complete development of which is pre- sented by the Greek and Roman churches. [CATHOLIC CHURCH; GREEK CHURCH.]

The positive system evidently leaves little liberty to the speculations of an active mind, or to the practice of scrupulous or turbulent individuals. Those of the former class sought for satisfaction in the scholastic philosophy; those of the latter made repeated attacks on the ruling system, which at last produced the Reformation in Germany and England. The scholastic philosophy was at its height from the 11th century to the 14th. It was for the most part a revival of the philosophy of Aristotle. The schoolmen were in profession firm believers of the Catholic doctrine, and generally succeeded in gaining rather praise than censure from the rulers of the church. But within the limits thus prescribed for them they pushed the application of their philosophy to theology to the utmost extent, and occupied themselves especially with the most subtle ques- tions on the nature of God and angels, and on points of casuistry.

The Reformation was far from abolishing the positive system in Protestant countries. To hold their ground against the power of the church of Rome, the reformed churches strove to make for themselves a visible and united constitution, and for this purpose they adopted symbols of faith and worship, which constituted for them respect- ively bodies of positive theology. The various dissenters from these reformed churches, though generally leaving them on the ground that their theology was not purely Protestant, still preserved much that was positive in their theology, either by a tacit consent or by a formal confes- sion of faith. And thus it has happened that, to the present day, theology is far less a system based upon and continuing to challenge scientific inquiry, than the exposition of a body of positive law.

Still there have always arisen individuals and parties who have claimed for themselves the utmost latitude of that right of private judgment which is the basis of the Protestant principle. Since the Reformation there has always existed, especially in England, a large amount of *biblical* theology, which has been chiefly of the *popular* school, but which, since the middle of the last century, has continually gained more and more of the *critical* element, both here, and still more in Germany; and it may be now safely affirmed, that with an admixture of the mystical theology, the adherents of which have always formed a considerable minority among Christians, the prevailing theological systems of the present day are the *catholic* and the *critical*.

It would be impossible within the limits of this article to give a list of even the best writers on theology. The following are taken at random as among the best, and as directing to other sources of information. The 'Institutes' of Calvin; the works of Turretin, Maestricht, Pictet, Doddridge, Bishop Watson, Richard Watson, Dwight, Ernesti, Bertholdt, Schleiermacher, Bretschneider, Nitzsch, and

other recent German writers, among which may be especially mentioned, as having been used in the composition of this article, Hahn's *Lehrbuch des Christlichen Glaubens*, Leipzig, 1828.

THEON, an eminent Greek painter, who was a native of Samos, and appears to have lived in the time of Philip and Alexander of Macedonia. He was reckoned one of the first masters of his age, on account of his powers of invention and the gracefulness of his execution. (Quintilian, xii. 10, 6.) We know the subjects of only a few of his works, but the execution is spoken of in such a manner that the excellence of the artist cannot be doubted. Pliny (*Hist. Nat.*, xxxv. 40, § 40) mentions two of them, the one representing Orestes in the act of killing his mother (compare Plutarch, *De Audiendis Poet.*, p. 18, ed. Frankf.), and the other Thamyris playing the cithara. A description of a splendid painting by Theon representing a youthful warrior, who, animated by a martial spirit and eager to fight, is hastening to meet the enemy, is given by Aelian (*Var. Hist.*, ii. 44).

THEON, AELIUS, a rhetorician and grammarian of Alexandria, who, according to some critics, lived about A.D. 500, but, according to a more probable opinion, about A.D. 315. According to Suidas he wrote a commentary on Xenophon, on the orations of Demosthenes and Isocrates, a work on rhetoric, one on the structure of language, *Progymnasmata*, and several other books. With the exception of the *Progymnasmata* (*προγυμνάσματα*), or practical rules on rhetoric, derived from the examples of the best Greek orators, there is no work extant that can be ascribed to him with certainty. Theon's *Progymnasmata* excel those of Aphthonius in elegance, precision, and clearness, and were, like those of Aphthonius, long used as a text-book in schools. The first edition appeared at Rome, 1520, 4to.; that of D. Heinsius at Leyden, 1626, 8vo. Scheffer's edition, Upsala, 1670 and 1690, is incorrect. The best edition of the text, accompanied by Greek scholia, is in Walz's *Rhetores Græci*, vol. i., p. 145-202.

Kuster (on Suidas, ii., p. 182) ascribes to Theon also the still extant scholia on Aratus, Apollonius Rhodius, Lycophron, and Theocritus. The *ἱστορικοὶ τόποι* which are contained in Aldus's and Cujacius's collections of epistles, are likewise attributed by some writers to Theon, while others assign them to Libanius or Proclus. A separate edition of them appeared at Leyden, 1614, 12mo.

(A. Westermann, *Geschichte der Griech. Beredsamkeit*, p. 230, &c.)

THEON. Theon, the Elder, of Smyrna, was the contemporary of Ptolemy (who cites one of his observations), but a little older. Theon, the Younger, of Alexandria, the commentator on Ptolemy, and father of Hypatia, lived in the latter half of the fourth century.

Of Theon the Elder, or Theon of Smyrna, we know nothing but that he was a follower of Plato, and has left a work entitled *τῶν κατὰ μαθηματικὴν χρῆσιν ἰσχυρῶν εἰς τὴν τοῦ Πλάτωνος ἀνάγνωσιν*, or, on the parts of mathematics which are useful towards a knowledge of Plato. Other works have been mentioned written by some Theon (there are many of this name), but they are lost. This work consisted of four parts, treating on arithmetic, music, astronomy, and the harmony of the universe (*περὶ τῆς ἐν κόσμῳ ἁρμονίας*). Bouillaud *Gr. Lat.*, Paris, 4to, 1644, published the first two of these parts, or what he found of them, from a manuscript which came from De Thou's library; together with what he supposed to be a fragment of the third, from the King's library. Isaac Vossius assured Bouillaud that the third part was to be found in the Ambrosian library at Milan, but it has never appeared. Professor de Gader, of Leyden, has recently (*Gr. Lat.*, 8vo., Leyden, 1827) published the arithmetic, with ample notes and dissertations.

Of the private life of Theon the Younger (who was also a Platonist) we know nothing, except that he professed the ancient heathen doctrines, which led to the memorable fate of his daughter Hypatia (A.D. 415), a crime which will excite disgust and indignation to the end of time. The words of the ecclesiastical historian Socrates, from Wells's translation (1700) of the Latin of Valerius Henry of Valois, are as follows; and his simple manner of narrating, in all its enormity a circumstance which it was so much the interest of his party to conceal, or at least to soften, might have been a lesson to his successors in the task of writing history: 'There was a woman at Alexandria by name

Hypatia. She was daughter to Theon the philosopher. She had arrived to so eminent a degree of learning that she excelled all the philosophers of her own times, and succeeded in that Platonic school derived from Plotinus, and expounded all the precepts of philosophy to those who would hear her. Wherefore, all persons who were studious about philosophy flocked to her from all parts. By reason of that eminent confidence and readiness of expression wherewith she had accomplished herself by her learning, she addressed frequently even to the magistrates with a singular modesty. Nor was she ashamed of appearing in a public assembly of men, for all persons revered and admired her for her eximious modesty. Envy armed itself against this woman at that time. For, because she had frequent conferences with Orestes, the prefect of Alexandria, for this reason a calumny was framed against her among the Christian populace, as if she hindered Orestes from coming to a reconciliation with the bishop. Certain persons therefore, of fierce and over-hot minds, who were headed by one Peter, a reader, conspired against the woman, and observed her returning home from some place: and having pulled her out of her chariot, they dragged her to the church named Casarium, where they stripped her and murdered her with shears, or broken crockery. And when they had torn her piecemeal, they carried all her members to a place called Cinaron and consumed them with fire. This fact brought no small disgrace upon Cyrillus, the bishop [Cyril], and the Alexandrian church. Damascius (the author of the *Life of Isidore*, in Photius) says, that Hypatia was the wife of this Isidore, and that Cyrillus was the instigator of the murderers. Some particulars are added in Suidas. Ysaac, who states that Hypatia was beautiful, and adds an anecdote which it is not desirable to repeat, but which, if true, entitles her to be called the most singularly straightforward of women. He says she wrote commentaries on Demophantus, and the Conics of Apollonius, and also an astronomical canon. A fuller account of her may be found in Ménage's *Lives of the Female Philosophers*.'

Theon of Alexandria is known as the commentator of Ptolemy and the editor of Euclid. There is a commentary on Aratus which is said to have been his, but Grotius is of opinion that it is the work of several hands, for which he gives good reasons. The whole of the commentary on the Syntaxis is preserved, except one or two books. A full account of it is given in Delambre's *History of Astronomy*, who observes that it helps but little understanding of the Syntaxis, and gives none additional information which is usually expected from a commentator. This commentary was first printed in Greek, in the Basle edition of Ptolemy, 1534. [S. PROLEMAIC.] J. Baptist Porta published two books (Latin, Naples, first book 1588, first and second) and Halma gave an edition of these same books and French, Paris, 1821, 2 vols. 4to. Besides the commentary, we have the *κατὰ πρόχειρον*, or manual described by Delambre from the manuscript, published by Halma (Greek and French, Paris, 1821, 2 vols. 4to.). They contain a description of the astronomical calculation in use at the time.

It only remains to speak of Theon as a commentator of Euclid, a character which some still persist in giving. The fact is, that Theon, as he himself informs us in his commentary on Ptolemy, gave an edition of Euclid's works, and there an additional proposition. [Grotius, p. 155.] Some manuscripts of Euclid call this additional proposition a commentary, and our fathers of the middle ages generally held that all the demonstrations were commentaries supplied by Theon, only the enunciations of the propositions being Euclid's. For instance, in the folio of 1516 (St. Petersburg) which the propositions are given twice, namely, once in the translation (called Campanus's) from the Arabic, and once in the Greek, in this work the enunciations are headed *Euclides ex Campano* and *Euclides ex Zamberto*. Again, in 'I quindici Libri degli Elementi di Euclide, di Greco tradotti in Lingua Toscana,' we find nothing but the enunciations of the propositions of Euclid's: had he meant to give demonstrations, the title would have been 'Euclid, with Theon's Commentaries.' Many editions professing to give Euclid in Greek, and Latin have the enunciations only in Greek, and a

arriving to a person who wishes to buy Euclid in the original. Hence arises the pertinacious continuance of the assertion that Theon commented Euclid: so late as the title 'Theon' in the 'Biographie Universelle,' we find this statement made; and even more, namely, that the commentary by Theon was published at the end of the 16th edition of 1533, in Greek, that it was translated into Latin by Commandine, and has been often republished. Any one who looks into the Basle edition will see that the commentary at the end is by Proclus, not by Theon.

Robert Simson, and other editors who alter according to their own ideas of perfection, and then swear that they have restored Euclid, always lay the blame of the supposed alterations upon Theon: Simson's phrase is, 'Theon, some unskilful commentator.' There is no reason to suppose that Theon altered Euclid: all that is known is, he added occasionally, and, if we look at those additions which it is certain he made, judiciously.

THEOPHANES, a native of Mitylene, was a contemporary and friend of Pompey the Great. During the war between Rome and Mithridates, when the Mitylenæans supported the king and delivered up to him the Roman general Manius Aquilius, Theophanes, who refused to take part in the revolt, was expelled, and went to the camp of Sulla. (Velleius Pat., ii. 18.) In Italy Theophanes became acquainted with Pompey, formed an intimate friendship with him, and henceforth accompanied him in all his expeditions. After the termination of the war against Mithridates, Theophanes endeavoured to perpetuate the exile of his friend. His history, which is now lost, appears to have been a work of no mean order, for Strabo calls Theophanes the most distinguished Greek of his age. Although he is not charged with having sacrificed the king, yet he was undoubtedly anxious to wipe off any stain that was attached to the family of his friend. Pompey is said to have been so delighted with the performance, that he procured Theophanes the rights of a Roman citizen. (Cicero, *Pro Archia*, 10.) Although Theophanes had been banished from Mitylene, he bore no grudge against his country, and on the return of Pompey from Asia he vaunted himself of his influence with the conqueror, and induced him to restore to the Lesbians their liberty and the privileges of which they had been deprived for having supported the king of Pontus. In B.C. 59 Theophanes was sent by the senate of Rome as ambassador to Ptolemy Auletes of Egypt, to carry to him the decree of the senate, which guaranteed him the sovereignty of his country. His conduct on this mission is blamed, because he is said to have endeavoured to direct events according to the secret wishes of Pompey. During the civil war Theophanes continued faithful to his friend, and supported him with his advice, and it was on his well-meant suggestion that after the battle of Pharsalus Pompey fled to Egypt, where he was murdered. After this event Theophanes returned to Rome, where he appears to have spent the last years of his life in retirement. After his death the Lesbians paid divine honours to his memory for the services which he had conferred upon them. His son, M. Aquilius Macer, held the office of praetor in the time of Augustus, and was afterwards appointed governor of Asia; in the reign of Tiberius he and his daughter put an end to their own lives, in order to avoid the punishment which was decreed to which they had been condemned.

Theophanes was the author of several works, both in prose and in verse, but very little of them has come down to us. Plutarch's Life of Pompey is chiefly based on the historical work of Theophanes, and we may thus possess more of it than we are aware; but besides this we have only a few fragments of it in Strabo, Plutarch, and Stobaeus. The 'Anthologia Graeca' (xv., n. 14 and 35) contains two epigrams of Theophanes, and Diogenes Laertius (ii. 104) mentions a work of his on painting, but of its contents nothing is known. Theophrastus, in the *Mémoires de l'Académie des Inscriptions et Belles-Lettres*, vol. xiv., p. 143, &c.)

THEOPHANES NONNUS. [NONNUS.] **THEOPHILUS**, a Constantinopolitan jurist, who lived in the reign of the emperor Justinian (A.D. 527-565). He was a distinguished teacher of jurisprudence at Constantinople (antecessor), and, at the command of the emperor, was employed among those who compiled the 'Digest'; afterwards he undertook, along with Dorotheus and Theophrastus, to compose the 'Institutes,' that is, the elemen-

tary treatise on jurisprudence, which was part of Justinian's plan. This Theophilus is generally supposed to be the author of the Greek paraphrase of the 'Institutes,' though it is maintained that the paraphrase is not the work of Theophilus himself, but was taken down from his lectures by some pupils. It was discovered in the beginning of the sixteenth century by Viglius ab Aytta Zuichemius at Louvain, who published and dedicated it to the emperor Charles V. (Basle, 1534, fol.). The work was frequently reprinted during the same century, but the last and best edition is that of W. O. Reitz, in 2 vols. 4to., Hagæ, 1751. It contains a Latin translation and the notes of previous editors, together with those of Reitz; and also a very interesting dissertation on the obscure and much disputed history of Theophilus. Theophilus also wrote a commentary on the first three parts of the 'Digest,' which however is now lost, with the exception of a few fragments which are incorporated in Reitz's edition of the 'Paraphrase of the Institutes.' The value of the paraphrase of Theophilus in establishing the text of the 'Institutes' may be estimated by an examination of the edition of the 'Institutes' of Gaius and Justinian by Klenze and Bücking, Berlin, 1829. (*Institutionum D. Justiniani Sacrat. Princip. Prooemium*; P. B. Degen, *Bemerkungen über das Zeitalter des Theophilus*, Lüneburg, 1808, 8vo.; Zimmern, *Geschichte des Röm. Privatrechts*.)

THEOPHILUS PROTOSPATHEARIUS (Θεόφιλος Πρωτοσπαθάριος), the author of several Greek medical works, which are still extant, and some of which go under the name of 'Philotheus' and 'Philaretus.' Everything connected with his name, his titles, the events of his life, and the time when he lived, is uncertain. He is generally styled 'Protospatharius,' which seems to have been originally a military title given to the colonel of the bodyguard of the emperor of Constantinople (*Spatharii*, or *σπαθαροφύλακες*). Afterwards however it became also a civil dignity, or at any rate it was associated with the government of provinces and the functions of a judge; they possessed great authority, and were reckoned among the Magnifici. (Further information respecting this office may be found in *Brisson, De Verb. Signif.*; Calvinus, *Lex Jurid.*; Du Cange, *Gloss. Med. et Inf. Graecit.*; id., *Gloss. Med. et Inf. Latinit.*; Carpentier, *Gloss. Nov. ad Script. Med. Aevi*; *Goar, Note on Georg. Codin.*, p. 29; *Guidot, Note on Theophr.*, *De Urin.*, pp. 142, 143, 145; *Meursius, Gloss. Graeco-Barb.*; *Prateius, Lex Juris Civ. et Canon.*; *Suicer, Thes. Eccles.*) In some manuscripts however he is called 'Philosophus' (Lambec., *Biblioth. Vindob.*, lib. vii., p. 352, ed. Kollar.); in others, 'Monachus' (id., *Ibid.*, lib. vi., p. 244, 494); 'Archiater' (Codd. MSS. *Theoph. De Puls.* ap. Ermerins, *Anecd. Med. Gr.*); or 'Iatrosophiasta' (ἰατροσοφιστῶν περὶ ὄρων, ed. Fed. Morell., Paris, 1608, 12mo.)

Of his personal history we are told nothing; if, as is generally done, we trust the titles of the manuscripts of his works, and so try to learn the events of his life, we may conjecture that he lived in the seventh century after Christ; that he was the tutor of Stephanus Atheniensis (Lambec., *Ibid.*, lib. vi., pp. 198, 223 492; lib. vii., p. 352), who dedicated his work, 'De Chrysopeia,' to the emperor Heraclius (Fabricius, *Biblioth. Graeca*, vol. xii., p. 695, ed. vet.); that he arrived at high professional and political rank, and that at last he embraced the monastic life. It must however be confessed that all this is quite uncertain, for, in the first place, Freind, in his 'History of Physic' (*Opera*, pp. 448, 449, ed. Lond., 1733), after remarking how little credit is sometimes due to the titles prefixed to manuscripts, doubts whether Theophilus was ever tutor to Stephanus, and thinks, from the barbarous words that he makes use of (such as *φιδλιον*, *σπομομάνικον*, *De Corp. Hum. Fibr.*, p. 177, l. 1, 2, ed. Oxon.; *ἰσοχῆ*, *γράνα*, *Ibid.*, p. 181, l. 11, 12; *ἀπακία*, *Ibid.*, p. 193, l. 11; *χυμίνη*, *δμὸβραστας*, *De Urin.*, c. 6, p. 266, l. 34, ed. Ideler), that he probably lived later. And, secondly, even if Theophilus was the tutor of a person named Stephanus, still it seems probable that this was not the alchemist of that name. [STEPHANUS ATHENIENSIS.] His date is equally uncertain. Some persons ('Chronologia inconsulta,' as Fabricius says, *Biblioth. Graeca*, vol. xii., p. 648 n., ed. vet.) think he was the person mentioned by St. Luke; others place him as early as the second century after Christ, and others again as late as the twelfth. He is generally supposed to have lived in the time of the emperor Heraclius, who reigned from A.D. 610

to 611; but this opinion rests only on the conjecture of his having been the tutor of Stephanus Atheniensis. The Oxford editor thinks, from the barbarous words quoted above, that he may possibly be the same person who is addressed by the title Protospatharius* by Photius (*Epist.*, 123, p. 161, ed. Montac., Lond., 1651), and who therefore must have lived in the ninth century. He was a Christian, and a man of great piety, as appears from almost all his writings: in his physiological work especially, he everywhere points out with admiration the wisdom, power, and goodness of God as displayed in the human body. (See *De Corp. Hum. Fabr.*, pp. 1, 2, 25, 89, 127, 153, 185, 272; *De Urin.*, Præf., p. 262; c. 10, p. 273; c. 23, p. 283; *De Excrem.*, c. 19, p. 408; *De Puls.*, in fine, p. 77.) He appears to have embraced in some degree the Peripatetic philosophy. (*De Corp. Hum. Fabr.*, pp. 2, 3, 4, 103, 105, 222, &c.; Mart. Rota, Pref. to Philothei *Comment. in Hippocr. Aphor.*.)

Five of his works remain, of which the longest and most interesting is an anatomical and physiological treatise, in five books, entitled *Περὶ τῆς τοῦ Ἀνθρώπου Κατασκευῆς, De Corporis Humani Fabrica*. It contains very little original matter, as it is almost entirely abridged from Galen's great work, 'De Usu Partium Corporis Humani,' from whom however he now and then differs, and whom he sometimes appears to have misunderstood. In the fifth book he has inserted large extracts from Hippocrates, 'De Genitura,' and 'De Natura Pueri.' He recommends in several places the dissection of animals, but appears never to have examined a human body; in one passage he advises the student to dissect an ape, or else a bear, or, if neither of these animals can be procured, to take whatever he can get, 'but by all means,' adds he, 'let him dissect something.' The work was first translated into Latin by J. P. Crassus, and published at Venice, 1536, 8vo., together with Hippocrates, 'De Purgantibus Medicamentis.' This translation was frequently reprinted, and is inserted by H. Stephens in his 'Medicæ Artis Principes,' Paris, 1567, fol. The manuscript from which Crassus made his translation is probably lost; but, though defective, it was more complete than that which was used by Guil. Morell in editing the original text, which was published at Paris, 1555, 8vo., in a very beautiful type, but without preface or notes. This edition is now become scarce, and was reprinted, together with Crassus's translation, by Fabricius, in the twelfth volume of his 'Biblioth. Græca,' p. 783, sq., Hamb., 1724 and 1740. Two long passages which were missing in the fourth and fifth books were copied from a manuscript at Venice, and inserted by Andr. Mustoxydes and Demetr. Schinas in their collection entitled *Σύλλογὴ Ἀποσπασμάτων Ἀνεκδότων Ἑλληνικῶν μετὰ Σημειώσεων*, Venet., 1817, 8vo. The last and best edition of this work is that by Dr. Greenhill, which has lately been printed at the Oxford University press, Gr. and Lat., 8vo., 1842. The editor says in the preface that he has taken as the basis of his edition the manuscript at Venice mentioned above, as being more complete than any other that he had met with; that three other manuscripts at Paris have been collated; that several passages have been corrected by referring to the original parts of Galen and Hippocrates from which they were copied: that Crassus's Latin version has been retained, as representing the readings of a manuscript no longer in existence: and that the notes are intended rather to illustrate and explain the Greek technical terms, than to correct all the anatomical errors and supply the deficiencies of the author.

Another of the works of Theophilus is entitled *Ἐπιτομή τῶν τοῦ Ἱπποκράτους Ἀφορισμῶν, Commentarii in Hippocratis Aphorismos*, which also seems to be taken in a great measure from Galen's Commentary on the same work. It was first published in a Latin translation by Ludov. Coradus, at Venice, 1549, 8vo., under the name of 'Philotheus.' The Greek text appeared for the first time in the second volume of F. R. Dietz's 'Scholia in Hippocratem et Galenum,' Regim. Pruss., 8vo., 1834.

His treatise *Περὶ Οὔρων, De Urinis*, contains little or nothing that is original, but is a good compendium of what was known by the ancients on the subject, and

* In *Epist.*, 193, p. 292, he is called Ἀσπαθίριος, but this is merely a mistake of the transcriber, and means Πρωτοσπαθίριος: for Du Cange tells us (*Gloss. Med. et Inf. Græc.*, in v. πρῶτος, that the word πρῶτος, when prefixed to titles, and signifying the first or chief, is generally expressed in manuscripts by the letter α, with a short line above it, thus ᾱ.

was highly esteemed in the middle ages. It first appeared in a Latin translation by Pontius (or Ponticus) Virunius (or Virminus), in several early editions of the collection known by the name of the 'Articella.' It was first published in a separate form at Basle, 1533, 8vo., translated by Albanus Torinus, together with the treatise 'De Pulsibus;' and this version was reprinted at Strassburg, 1535, 8vo., and inserted by H. Stephens in his 'Medicæ Artis Principes.' The Greek text was published without the name of Theophilus, under the title 'Iatrosophistæ de Urinis Liber Singularis,' &c., at Paris, 1608, 12mo., with a new Latin translation by Frid. Morell, which edition was inserted entire by Charter in the volume of his edition of the works of Hippocrates, Galen. The best edition is that by Thom. Guidot, Bat., 1703, 8vo., Gr. and Lat.; and again with a new page, 1731. The text is much improved by adopting the readings of a manuscript in the Bodleian Library at Oxford: there is a new Latin version by the editor, and also copious and learned prolegomena and notes. The Greek from Guidot's edition, is inserted by J. L. Ideler, 'Physici et Medici Græci Minores,' Berol., 1841, 8vo.

A short treatise, *Περὶ Διαχωρημάτων, De Entis Alvinis*, was first published by Guidot, in Greek, a Latin translation by himself, at the end of 'De Urinis' mentioned above: the Greek text inserted by Ideler in his 'Physici et Medici Græci'

The last of the works of Theophilus that is a treatise, *Περὶ Σφυγμῶν, De Pulsibus*, which first appeared in a Latin translation, under the name of 'Philaretus,' in several of the old editions of the 'Articella.' It was first published in a separate form at Basle, 1533, 8vo.; later by Albanus Torinus, together with the treatise 'De Urinis' mentioned above. It was reprinted at Strassburg, 1535, 8vo., and inserted by H. Stephens in his 'Medicæ Artis Principes.' The Greek text was first published by F. Z. Ermerin in his 'Anecdota Medica Græca,' Bat., 8vo., 1840, together with a new Latin translation. The text is taken from one manuscript at Leyden at Paris, and differs very considerably from the translation going under the name of Philaretus.

(Guidot's Notes to Theoph. *De Urinis*: *Fabr. Biblioth. Græca*; *Freind's Hist. of Physic*; *Haller's Anat. and Biblioth. Medic. Pract.*; *Spriengel's Méd.*; *Dietz's Preface* to the second volume of *in Hippocr. et Gal.*; *Ermerin's Preface* to his *Gr.*; *Choulant's Handbuch der Bücherkunde für Aeltere Medicin*; *Greenhill's Notes* to Theoph. *De Urinis*.)

THEOPHRASTA, the name of a genus of plants named after Theophrastus. It was originally called Plumier, but afterwards altered by Linnæus to the natural order Mlysinaceæ, and is a small simple unbranched stem, furnished with a tuft of evergreen leaves at top, giving it a resemblance to a tree. The flowers are of a white colour, and are in terminal racemes, which are very short, and hidden by the leaves of the plant. The calyx is cartilaginous. The corolla is also cartilaginous, short tube, and has a dilated throat, girded by an angularly-lobed, fleshy, arched ring: the limb of the stamens are five, combined with the tube of the corolla; anthers horned. The fruit is a crustaceous berry, about the size of a crab-apple, with the seeds immersed in the placenta. There is but one species after Jussieu, *T. Jussieu*. This plant is the *T. Americana* of Linnæus. It is a native of the island of St. Domingo, and is much cultivated on account of its long handsome holly-like leaves. It may be propagated by cuttings, and grows well in a soil of peat, loam,

THEOPHRASTUS was born at Ereus, in the island of Lesbos, but the year of his birth is uncertain; writers state it to be B.C. 371; others place it at B.C. 350. According to Hieronymus (*Epist.*, 2, ad Nestor), he died in the year B.C. 285, and, as some say, in B.C. 285 (Diogenes Laert., v. 40), or, according to Pliny, at the age of 106 years. These different accounts of his life leave the date of his birth uncertain. When a young man his father Melantus sent him to Athens for the purpose of studying. Here he was first a pupil of Plato, and an intimate friend of Aristotle, who, charmed with his talents and his beautiful pronunciation, is said to have given him the name of Theophrastus (one who speaks

: his real name was Tyrtamus. (Quintilian, x. Cicero, *Orator.*, 19.) After the death of Plato, Theophrastus, with a number of the former pupils of Plato, left the Academy. Plutarch has preserved a bare account of an event in the life of Theophrastus which must perhaps be assigned to the time when he spent away from Athens after his withdrawal from the Academy. Plutarch says that he and Phidias fled their country twice from the oppression of tyrants. After the battle of Chaeronea, Theophrastus returned to Athens from which he had been absent for many years; Aristotle had then just opened his school (the Lyceum), Theophrastus ranged himself among the hearers of Aristotle, and cultivated most zealously all the departments of philosophy and science of which Aristotle was the great master. When Aristotle himself withdrew, Theophrastus became his successor in the Lyceum, and acquired great reputation in his new sphere, not because he introduced any new system of philosophy, but because he added to the knowledge and profundity of Aristotle with the commanding eloquence of Plato. The number of his disciples on one occasion is said to have amounted to two thousand (Diogenes Laert., v. 37), who flocked around him from all parts of Greece. This popularity, and the practical character of his philosophy, roused the indignation and envy of those who saw in him an obstacle to their designs. The consequence was that Agno, who probably acted on behalf of many others, brought against him a charge of impiety. Theophrastus defended his own cause before the Areopagus with his usual eloquence, and convinced that court of his innocence. He would have fallen a victim to his own calumny, had not his friends had not generously interfered and saved him. After this event he enjoyed undisturbed peace for many years, and he saw his school, which was visited by the most eminent men of the age, daily increase. The popularity which he enjoyed was however chiefly owing to the influence of Demetrius Phalereus, who had himself been a pupil of Theophrastus. After the fall of Demetrius the tyrants began afresh; and, in 305 B.C., Sophocles, Amphicliides, carried a law which forbade all philosophers, under pain of death, to give any public instruction without the permission of the state. (Diogenes Laert., Athenæus, xiii., p. 610; J. Pollux, ix. 5.) Theophrastus left Athens; but in the following year, the law was abolished, and the mover condemned to pay a fine. Theophrastus and several other philosophers fled to Athens, where he continued his labours without interruption until his death. The whole population is said to have followed his body to the grave. His library, in which he disposed of his literary and other property, is preserved in Diogenes Laertius. His library was very valuable, as it contained the works of Aristotle, which his philosopher had bequeathed to Theophrastus. Theophrastus bequeathed them, together with his other property, to Neleus of Scepsis. Theophrastus, as already observed, did not develop a new system of philosophy, but he confined himself to extending that of his master Aristotle. With this view he wrote numerous works on various branches of philosophy and natural history. His philosophical works may be divided into works on philosophy, in the narrower sense of the word, works on historical subjects, and works on certain departments as oratory, poetry, and the like. It is to be lamented that most of his writings on these departments are lost, and more especially those on politics (*Πολιτικά*), laws (*παρα νόμοις*), on laws, a work of which he made great use, and his works on oratory, of which Theophrastus himself was so distinguished a master. A list of the best books of Theophrastus is given in Fabricius's *Graeca*, iii., p. 445, &c.). Andronicus of Rhodes, a Peripatetic philosopher of the time of Lucullus, made a collection of the works of Theophrastus, and arranged them in systematic order. The following philosophical works of Theophrastus are still extant:—

Characteres, or *ἠθικὸν χαρακτήρες*, consisting of thirty books, according to Schneider's arrangement, of thirty chapters. In this work the author gives thirty characteristic descriptions of vices, or rather, of the manner in which they show themselves in man. The descriptions are mere sketches, and form a gallery of bad or

ridiculous characters. Many modern critics have maintained that the work in its present form is not to be regarded as a production of Theophrastus, but that it is either an abridgement of a greater work of this philosopher, or a collection of descriptions of vicious characters, compiled either from the writings of Theophrastus, or from those of others. Neither of these opinions is incompatible with the statement of Diogenes Laertius, Suidas, and other late writers who mention *ἠθικὸν χαρακτήρες* among the works of Theophrastus; for the 'Characteres' which we now possess may have been compiled and published under the name of Theophrastus long before their time. Either of these hypotheses would also account for the fact that nearly all the definitions of the vices that occur in the book contain some error, which, it must be presumed, would not have been the case if the work had been written by Theophrastus. Other critics, on the contrary, have vindicated the 'Characteres' as a genuine work of Theophrastus, and have attributed all its defects and inaccuracies to the bad MSS. upon which the text is based. This opinion has received considerable support from the discovery of a Munich codex, part of which was published by Fr. Thiersch in 1832, in the 'Acta Philologorum Monacensium' (vol. iii., fasc. 3). This MS. contains the titles of all the thirty chapters, but the text of only twenty-one. The first five chapters and the introduction, which were edited by Thiersch, are considerably shorter than the common text, the language is perfectly pure, and there is very little doubt that this is the genuine text of the work of Theophrastus, and that the common one is only a paraphrase, made perhaps by Maximus Planudes, who is known to have written a commentary on the 'Characteres' of Theophrastus. The editio princeps of the 'Characteres' is by Wilibald Pyrcckheimer, Nürnberg, 1527, 8vo. This edition, which contains only fifteen chapters, was reprinted with a Latin translation by A. Politianus, Basle, 1531, 8vo., and 1541, fol. Chapters 16 to 23 were first added by Camotius, who published the works of Theophrastus in the sixth volume of his edition of Aristotle (Venice, 1551-52). These twenty-three chapters were increased by five new ones from a Heidelberg MS. in the excellent edition of Casaubon, of 1599 (reprinted in 1612 and 1617, 8vo.). The last two chapters were added in the edition which appeared at Parma, 1788, 4to. A still more perfect, and in fact the first complete edition, is that of J. P. Siebenkees, which was edited by Goetz, Nürnberg, 1798, 8vo. In 1799 there appeared two new editions, the one by Coraes (Paris, 8vo.), and the other by Schneider (Jena, 8vo.). The last edition, which is very useful, is that of Fr. Ast, Leipzig, 1816, 8vo. The 'Characteres' have been translated into French by Jean de la Bruyère (Paris, 1696, 12mo., often reprinted, and lastly edited by Schweighäuser, Paris, 1802), and by Levesque (Paris, 1782, 12mo.). The best German translations are those of C. Rommel (Prenzlau, 1827, 12mo.), and of J. J. Hottinger (München, 1821, 8vo.). The reare several English translations: the latest is by F. Howell, London, 1824, 8vo. That by Eustace Budgell, London, 1713, 8vo., is generally called the best. There is also a translation into modern Greek by Larbaris, Vienna, 1815, 8vo.

2. A fragment of a work on Metaphysics, which consists of one book entire (*Τὸν μετὰ τὰ φυσικὰ ἀποσπασμάτιον ἢ βιβλίον ε*). This book was not mentioned by Andronicus of Rhodes in his catalogue of the works of Theophrastus, but it is ascribed to him by Nicolaus Damascenus. It is printed in all the early editions of the works of Theophrastus in connection with those of Aristotle, as in those off Venice (1497), Basle (1541), Venice (1552), and in that off Sylburg (Frankfort, 1587). The last edition is that of Ch. A. Brandis, who annexed it to his edition of Aristotle's 'Metaphysics' (Berlin, 1823, 8vo.).

3. A Dissertation *περὶ αἰσθήσεως*, that is, on the Senses and the Imagination. There is a paraphrastic commentary on this work by Priscian, the Lydian, who lived in the sixth century of our æra. It was first edited by Trincavelli, Venice, 1536, fol., with Priscian's paraphrase, and 'Quæstiones' by Alexander Aphrodisiensis. It is also printed in the above-mentioned collections of the works of Theophrastus, and in that published by Schneider, Leipzig, 1818-21.

The fragments of other philosophical works are too brief and numerous to be noticed here.

The 'History of Plants,' by Theophrastus, *περὶ φυτόων*

Isoropiac, is one of the earliest works on botany that was written with anything like scientific precision. The work is divided into ten books, of the last of which only a fragment is preserved. The matter is arranged upon a system by which plants are classed according to their modes of generation, their localities, their size as trees or shrubs and herbs, and according to their uses as furnishing juices, potherbs, and seeds which may be eaten. The first book treats of the organs or parts of plants; the second of the reproduction of plants, and the times and mode of sowing. Here he mentions the sexes of plants, and describes the mode of reproduction in palms, and compares it with the caprifigation of figs. The third, fourth, and fifth books are devoted to a consideration of trees, their various kinds, the places they come from, and the economical uses to which they may be applied. The sixth book treats of undershrubs and spiny plants; the seventh of potherbs; the eighth of plants yielding seeds used for food; and the ninth of those plants that yield useful juices, gums, resins, or other exudations. In this work there is much original and valuable observation, but at the same time it is intermixed with many absurd statements with regard to the functions and properties of plants. It is probable that much of the valuable matter recorded in this work was the result of his own observation, as he is known to have travelled about Greece, and to have had a botanic garden of his own, whilst he was probably dependent on the statements of soldiers and others connected with the armies of Alexander for his information on Indian, Egyptian, and Arabian plants.

Theophrastus wrote also another work, 'On the Causes of Plants,' *περὶ φυτῶν αἰτιῶν*. This work was originally in eight books, six of which remain entire. It treats of the growth of plants; the causes which influence their fecundity; of the times at which they should be sown and reaped; the modes of preparing the soil, of manuring it, and of the instruments used in agriculture; of the odours, tastes, and properties of many kinds of plants. In this, as in the history of plants, the vegetable kingdom is considered more in reference to its economical than to its medical uses, although the latter are occasionally referred to. In both works there is much valuable matter that deserves the attention of the botanist, and a very little knowledge of botany will enable the reader to separate the chaff from the wheat. Both Haller and Adanson complain of the errors which translators and editors of these works have fallen into for want of botanical knowledge. Both works have gone through several editions; they were printed together by the sons of Aldus at Venice, in 1552, 8vo.; and again by Heinsius at Leipzig, in 1613. The 'History of Plants' has been published separately more frequently than the 'Causes.' The best edition is that of Bodæus à Stapel, which was published by his father after his death. It contains a preface by Corvinus; the Greek text, with various readings; the commentaries and remarks of Constantinus and J. C. Scaliger; the Latin translation of Gaza; very careful commentaries by Stapel; a very copious index, and the whole is illustrated by woodcuts. The cuts however are very inferior, and are copies of those in the works of Dodonæus, which seem to have been copied into nearly all the works published on botany at this period. It appeared at Amsterdam in 1644, folio. The latest edition of this work was published at Oxford, in 1813, by Stackhouse. This edition is accompanied with a Syllabus of the genera and species of the 500 plants described by Theophrastus, also a glossary, and notes, with a catalogue of the editions of the botanical works of Theophrastus. The 'History of Plants' was translated into German by Kurt Sprengel, and published at Altona, in 1822, 8vo.

Besides his botanical works Theophrastus wrote many others on various subjects of natural history, which are enumerated with his philosophical works in Diogenes Laertius (v. 42, Sec.). One of them, on Stones (*περὶ λίθων*), from which Pliny, in his account of stones, derived the greatest part of his information, is still extant. De Laet has prefixed it, with a Latin translation and notes, to his work, 'De Gemmis et Lapidibus,' Leyden, 1647, 8vo. A separate edition, with an English translation, was published by Hill, London, 1746, 8vo.; another, with a French translation, appeared at Paris, 1754, 8vo.; and a third, with a German translation, by Baumgärtner, Nürnberg, 1770, 8vo. The last edition is that of Schneider, Freiburg, 1807, 8vo.

Of his two books on Fire (*περὶ πυρῆς*), only one is now extant; of his other works on natural history, which now lost, we possess a considerable number of ments.

The editio princeps of all the works of Theophrastus that of Aldus, Venice, 1495-98, printed, together with works of Aristotle, in 5 vols. fol. Theodorius Gaza published a Latin translation, which was made from the MS. from which the Aldine text was taken. The edition of this translation is without date or place. A second appeared at Tarvisium in 1483. The third edition is that of Link and Schneider, Leipzig, 4 vols. 8vo.

(Haller, *Bibliotheca Botanica*, tom. i., p. 31; *Geschichte der Botanik*; Adanson, *Familles des Plantes*; Bischoff, *Lehrbuch der Botanik*; Stackhouse, *Hist. Plant.*; Fabricius, *Biblioth. Græc.*, iii., p. 11; Ritter, *History of Philosophy*; Krug, *Geschichte der Philosophie*, § 99.)

THEOPHYLACTUS SIMOCATTA, of Locri, a Sicilian, sophist, and natural philosopher, who was born about 610-629 A.D. He wrote a 'Univ. (ἱστορία οὐρανοῦ καὶ γῆς), in eight books, from the emperor Tiberius II., in 582, to the murder of his children by Phocas, in 602. This work is the Latin title of 'Historiae Rerum à Mauricio Libri VIII.' It was printed, with a Latin translation by J. Pontanus, at Ingolstadt, 1604, 4to. An edition was published by Fabrotti, Paris, 1648, 10 vols. 4to, 1729. It is also contained in Niebuhr's collection of Byzantine writers.

He also wrote 85 short letters, 'Epistolae Morales, Iustitiae, et Amatoriae,' which were published in the collections of Aldus, Cujacius, and Henry Stephens; and a work entitled 'Problems in Natural History' (*Ἰστορίας Quaestiones Physicae*), which was published at Paris, 1596, and at Leipzig, 1653. The two last works have been recently edited by Boisot, Paris, 1835.

(Fabricius, *Bibliotheca Græca*; Schöll, *Gesch. Griech. Litt.*)

THEOPHYLACTUS, a native of Constantinople, archbishop of Achris, the chief city of Bulgaria, a year 1070 or 1077. He wrote a work on the 'Education of Princes' (*καταδία βασιλική*), for the perusal of the young Porphyrogenetus, the son of Michael VII. empress Maria. This work forms a part of the works of Byzantine writers.

Theophylactus is better known by his valuable commentaries on the twelve minor prophets and the treatise of the New Testament, which are chiefly copied from the works of Chrysostom. He also wrote 75 several tracts. These works were printed in Latin, at Venice, 1754, fol.

(Fabricius, *Bibl. Græc.*, vii., p. 763; Larner's *Critical Edition*, pt. ii., c. 163; Schöll, *Geschichte der Griech. Litt.*, iii., 286.)

THEOPOMPUS, an eminent Greek historian, native of the island of Chios, son of Damasus, brother of Caucalus, the rhetorician. He was born about B.C. 380, and was instructed in rhetoric by Isocrates during his stay in Chios. (Plutarch, *Vit. dec. Orat.*, p. 10; Photius, *Cod.* 260, p. 793.) Photius in another place states that Damasistratus and his son were obliged to leave their native island on account of their political opinions: this seems to have occurred about B.C. 340. Chios was distracted by two parties, the most powerful one being in favour of Thebes, while the number of aristocrats supported the interest of the latter belonged Theopompus and his father. The influence of the instruction of Isocrates on Theopompus appears to have been very great, for although he never applied his oratorical powers to politics or to speak in the courts of justice, yet he wrote, like his master, a considerable number of orations, which were recited at rhetorical contests, and in which he is said to have excelled his master. When he was obliged to leave his native island he went with his father to Asia Minor, and spent several years in travel and study, and acquired a high degree of his eloquence. At the age of 40 he obtained leave to return to his country, and was distinguished by the preference of Alexander the Great. After the death of Alexander he took an active part in the political affairs of

lents he became one of the principal supporters of the party. So long as Alexander the Great's armies could not venture anything openly but no sooner had the king died than he again expelled Theopompus. He now took refuge under the protection of Ptolemaeus, the king during whose reign he remained unmolested. Ptolemaeus Philadelphus was ill disposed and if Theopompus had not been advised by some one to quit the country, he would have been put to death; but he now fled, and what were his subsequent adventures where he died, are questions to which no answer is given, though it is highly probable that he died shortly after 308 B.C.

The works of Theopompus, of which we now possess numerous fragments, is one of the greatest literary monuments which history has sustained. The following list contains what he is known to have written:—

1. An epitome of the work of Herodotus (*Ἐπιτομή Ἱστοριῶν*). This epitome is mentioned by several other grammarians. Modern critics judge it improbable that Theopompus should have undertaken such a task, and that it was probably the work of a later grammarian, who published it under the name of Theopompus.

2. The reasons adduced for this opinion are, that it is not improbable that Theopompus made this abridgement as a first attempt at history.

3. An important work was a history of Greece from the foundation of the city (*Ἱστορία, or Σύνοσις Ἑλληνικῶν*). It took up the events down to the battle of Cnidus, B.C. 411, and consisted of twelve books, and many fragments preserved.

4. A history of Philip of Macedonia and his time (*Ἱστορία*). It contained in 58 books the history of Greece from the accession of Philip, or from the foundation of Philippi, down to the death of Philip. Five books of it were lost as early as the time of Cicero (xvi. 3), and they were probably the work of Theopompus. Photius (*Cod.*, 176, p. 390) mentions as being preserved, viz. books 6, 7, 9, 20, and 30. This volume not only embraced the history of Greece in the use of the word within the period mentioned, but also of those earlier parts of Greek history and of such barbarous nations as he had occasion to mention.

5. These things formed numerous and long works, and of their extent we may judge that Philip III. of Macedonia, after cutting off Theopompus, reduced the work from 58 to 16 books (*Cod.*, 176.) We still possess many fragments, which the ancient writers refer to and

in these historical works, Theopompus wrote many works. We know that he also composed Panegyrics on Philip, and Alexander. As regards his character as a historian, the ancients praise him as a lover of truth; they also state that he was extravagantly censured, and unbounded in his praise. His vehement temper did not allow him to pre-eminence which becomes the historian. He is reproached with having been too fond of the marvellous, and for this reason dwelled too much upon the stories of Greece wherever he had occasion to mention them.

6. Fragments of Theopompus have been collected by Theopompus Chii Fragmenta, collegit, disposuit, et eisdemque de Vita et Scriptis Commentaris, &c., Lugduni Batavorum, 1829, 8vo. They are contained in C. and J. Müller's 'Fragmenta Græcorum' (Paris, 1841), p. 278-333. Consult, *Prolegomena ad Theopompum Chium*, 4to.; A. J. E. Pflugk, *De Theopompi Chii Fragmentis*, Berlin, 1827, 8vo.; Aschbach, *Dissertatio de Theopompi Chii Historico*, Frankfurt, 1823, 4to.

7. A musical instrument of the lute kind, which he introduced into disuse. The latest employment of it was in Handel's oratorio of *Esther* (1720), introduced, with the harp, as an accompaniment to the 'Watchful Angels.' This instrument has been called *Cithara Bijuga*, its two heads having been considered as two necks: and it was commonly

known under the name of Arch-lute on account of its magnitude. The upper and middle strings were attached to the lower head or nut; the lower, or base strings, to an upper or additional one. According to *Maister Mace* (1676), the Theorbo was the old English lute very much enlarged, and used chiefly, if not only, as an accompaniment to the voice. [LUTE.]

THEOREM (*Θεώρημα*) means properly a thing to be looked at or seen; and is used in mathematics to signify any proposition which states its conclusion or makes any affirmation or negation; as distinguished from a PROBLEM, which demands or requires a conclusion to be arrived at, without so much as stating whether that conclusion is even possible. Thus, 'Required to draw a tangent to a circle at a given point,' is a problem; but 'If a straight line be drawn at right angles to a diameter from its extremity, that straight line is a tangent to the circle,' is a theorem. The problem asks discovery both of method and demonstration; the theorem asks demonstration only.

This distinction, as noticed in detail in PROBLEM, was not made by the older Greek geometers; Theodosius is the first, as far as we know, who uses the word theorem, but none of his propositions are problems: Pappus is the first who uses both terms in the distinctive sense.

THEORIES OF MOLECULARITY. This important branch of science is directed to connect the known mechanical, dynamical, and hydrodynamical laws with those which govern the crystallization of solids, the operation of heat in producing liquidity and gaseity, the action of capillary tubes on fluids, and several other phenomena of constituted matter. The laws which regulate the motions of great masses taken as continuous bodies have been explored with success to an astonishing degree by the genius and labours of such men as Newton, D'Alembert, and Laplace. On the contrary, those laws which govern the constitution or elementary arrangement of such bodies are to a great extent absolutely unknown. The ordinary senses of sight, touch, &c. are sufficient to take cognizance of the facts from which the former laws are deduced; but for the latter it is necessary to apply the most delicate instruments supplied by nature, namely, heat, light, and electricity. The minute world is of more difficult research than the great, the plane sections of a crystal than the elliptic orbits of the planets, the infinitely small than the infinitely great.

It is not therefore wonderful that this branch of science, which should connect on one uniform basis the phenomena of chemistry, of crystallography, and of the mechanical action of masses, should have attracted the attention of the most able philosophers from the sixteenth to the nineteenth century; from Boyle to Berzelius, from Newton to Navier and Poisson; and the present unsatisfactory state of our knowledge on this subject must to a great degree be attributed to the neglect of the inductive method, to the substitution of hypotheses for the results of observation.

The first theory on this subject may be thus stated, that the particles of matter possess the attraction of cohesion, but are repulsed by the action of heat or caloric: when the former preponderates, the body is solid; when both are equal, it is in a fluid state; and when the latter exceeds the former, the body is a gas, and prevented from total dispersion only by the action of gravitation. This is purely hypothetical, and forms no more ground for mathematical calculation in relation to the phenomena alluded to above, than does the definition of a straight line in Euclid's Elements for the properties established in geometry. The second hypothesis, which of late has been more generally received both by chemists and mathematicians, is that the particles of matter are mutually attractive by a law analogous to that of gravitation, but are surrounded by atmospheres repulsive one of the other, in the same manner as the particles of elastic fluids. From this hypothesis the equations of equilibrium and of progressive and rotatory motions are deducible; but as the constitution of such atmospheres may be modified very much at the will of the calculator, so as still to obtain the same mechanical results (in the manner in which the distribution of the fluid of light in crystallized bodies has been by those analysts who have developed the undulatory theory), it seems probable that it will be long before the phenomena of crystallization, liquefaction, &c. will from this hypothesis be explained, and the absence of all external action in solids, with the exception of gravitation. The difference of the calculations of Navier and

Poisson show how much this hypothesis may be adroitly stretched. A third method of viewing the phenomena of matter is more strictly inductive, and is similar to that employed in the investigation of the distribution of latent electricity, in Mr. Murphy's 'Treatise on Electricity,' &c. Here we start from the fact that forces sufficiently powerful to prevent the penetration of solids by other solids, and which prevent their being torn asunder without great force being employed, are yet insensible to bodies at very minute distances from them. Here we have ample data for analytical calculation, the chief difficulty lying in the imperfect state of analytical calculation relative to definite integrals; nevertheless enough can be deduced to show the distribution of attractive and repulsive forces within the variously-formed bodies. It however requires the highest strength of analysis of a nature somewhat similar to that employed by Laplace on the figure of the earth and the tides.

The best test of the truth of any theory on this subject is that which, with the forces supposed to exist, shall show that the locus of the points of least resistance, commencing from a given point, shall be a plane surface, or several plane surfaces, as exhibited by crystals.

(Dr. Young's *Lectures on Natural Philosophy*; Various Papers in the *Mémoires de l'Institut*; and Poisson's *Traité sur l'Action Capillaire*.)

THEORY, THEORY AND PRACTICE. If articles upon the mere meaning of words be admissible, it is the consequence of the manner in which they are used. Of all the fallacies which infest society, the most common is that of applying to one sense of a word ideas or associations derived from another; and of all the words in use, there are few which are more often subjected to such process than those which stand at the head of this article.

By theory, properly speaking, is meant the mode of making seen and known the dependence of truths upon one another: a theory is a connected body of such truths belonging to one or more common principles. The use of this word has enlarged with the boundaries of the sciences. For example, before the discovery of universal gravitation, all that was known of any one planet was the empirical formula for one or two of its inequalities. This constituted the theory of the planet (then so called): thus the theory of the moon consisted in the statement of the laws of the inequalities called the equation of the centre, the evection, &c. In our day the point of view is changed; it is no longer the mere exhibition of these inequalities which constitutes the theory, but the deduction of them, as necessary consequences, from the principle of gravitation. The theoretical astronomer now starts from this principle, and, taking only one position and velocity for his numerical data, finds out every inequality of the planetary motions, those which were previously known from observation and more, and shows how to form them into tables. The practical astronomer makes these tables, computes places from them for the current year, compares these places with the results of observation, and returning the comparison into the hands of the theorist, enables him, if need be, to correct the original numerical data to which he applied his methods. The process is now deductive; but before the time of Newton it was the other way. The observer had the first task; the inequalities were to be collected from comparison of observations, and their laws, reduced to their simplest form, were the data for future tables.

Again, before the introduction of the undulatory hypothesis, the theory of light consisted in the exhibition of the laws of reflexion and refraction, with a certain extent of explanation from the emanatory hypothesis of Newton. Since that time the theory of light has become, though at a distance, a resemblance of the theory of gravitation in its character: prediction has commenced, that is to say, the phenomena which would appear under certain new circumstances have been announced before any experiments were made to discover them: and correctly announced. This is the end to which theory ought to be constantly tending; namely, the discovery of laws of action in so complete a manner that the necessary consequences of these laws never fail to make their appearance, so that every thing which is seen is found to be a consequence of the laws when examined, and every consequence of the laws is seen in phenomena when looked for. Whatever fulfils these conditions may be called a perfect theory, or a perfect mathematical theory.

The next step in the chain of discovery is one in most cases be incapable of attainment. For nothing is more certain than that the assumption of a particle of matter attracting every other particle according to the Newtonian law, leads to the complete prediction of the celestial motions, and gives the complete prediction just alluded to. But whether this does actually take place, or whether any agent is employed, though it matters nothing to the mathematical theory, is the next object. Could this point be ascertained, it is more than that the knowledge of the constitution of matter it would lead, would open hundreds of importances even in the application of science to [CAUSE; HYPOTHESIS.]

Before coming to the distinction between practice, we must observe that theories may be divided into two classes, the more perfect and the less perfect; we cannot say that any theory is absolutely perfect, but are some of which the defects are hardly perceptible, others in which the contrary is the case. For example, the theory of the statics and dynamics of rigid bodies is probably perfect; but that of bodies composed of particles acted on by molecular forces is in its infancy. A great deal more of the connection of the principles with each other than we do of the particles when connected together, form a bar of iron or of steel, we know that the bar is not perfectly rigid; that it breaks: and the degree of bending which a given force causes, and the amount of pressure necessary to produce fracture, must be sought for in experiments, and imperfect as they are, the laws which would be deduced from a good theory, if we had one, are to be deduced from a subject our theory, instead of being an aid to it, is only a help, the services of which are not to an extent which discrimination derived from observation and experience must point out. Many a person who is proceeding upon experience only, is misled by the use of a mixture in which there is theory, though the knowledge of the process he uses, and of its consequences, is not be sufficient to inform him of it.

A person who uses an imperfect theory with confidence due only to a perfect one, will naturally be the subject of abundance of mistakes: his predictions will be the result of disturbing circumstances of which his theory does not take account, and his credit will be lowered by the frequent failure of his predictions. And inasmuch as more theories are imperfect than perfect, and of those who attend to anything, the acquirement of very sound habits of judging is small, and that of those who do not get so far, it must have been as it has happened, that a great quantity of error has been made by those who do not understand the difference between an imperfect theory and a perfect one. Hence much discredit has been brought upon theory in general; and the schism between the theoretical and practical men has arisen. Fortunately, many of the former who attend properly to the distinction between theory and practice; and many of the latter who are themselves practical who seize with avidity all that can do for them, and who know that step by step has been making her way with giant strides into the domain of practice for the last century and a half.

By practice, as distinguished from theory, is meant the application of that knowledge which comes from experience only, and is not sufficiently connected with general principles to be entitled to the name of theory. The distinction of labourers in the field of science into theoretical and practical is not strictly a just one; there is no theorist whose knowledge is all theory, and there is no practical man whose skill is all derived from experience. But the terms will do well enough to distinguish two classes whose peculiarities it might be difficult to define exactly.

The practical man, when he is really nothing more than a workman who can just do what he has been taught to do, has acquired skill and judgment in a small range of operations. All who pride themselves upon the title of practical man will be displeased at this definition, and we readily understand why many of them are entitled to a higher character because the name by which they delight to describe themselves is a wrong one. They desire, under the name of practical man, to claim the qualities of a master. The theoretical man, on the other hand, is contemptible, as one of contempt, to de-

of which they disapprove ; and as there never is any which is not carried to a fool's-cap extent by the order of users, it would not be difficult to make a amusing selection of instances of the manner in the distinction has been worked by the large number at the bottom of the class, and in whose heads it runs their own *ignorance* is practical, and others' *knowledge* theoretical. We remember seeing a theorist, as he was called, vowing to make the managers of a certain understand that their profits could not exceed the of the gross returns over the outlay, after they had rying to cheat the equation by inventing names for they would have liked to have, but which the it assured them they would not get, for the preceding . The answer was, 'That is very true *theoretically*, w let us look at it *practically*.' We shall say no of the gross abuse of the terms, except to remark ere it worth while really to make a contest between and practice, it would be difficult to say on which e balance of absurdity would incline ; or whether an who is too confident in his theory, or too con- in his experience, has done most mischief for the eing.

ing now to the higher class of practical men, and ng as of the balance between two methods, the of both of which is admitted, we observe that there vious faults to which both parties are subject, both duct, and in argument respecting their pursuits. care is necessary to secure the theorist from pushing perfect theory too far, and neglecting causes of dis- ce ; but at least as much is necessary to prevent ictical man from generalising into theory from im- : experience, or from restraining inquiry by a notion l from practice. This is his besetting sin, to such ent that we should almost be inclined to say that ult of a practical man is a tendency to form false , as that of the theorist is to make false applications. ve often been surprised at the boldness with which mer assert generalities, upon evidence which would ike a pure theorist look for further information. gies are of all things the most deceptive.

argument there is one mode which is common to arties, and which is exceedingly detrimental. It is ction of instances from the very highest minds of o orders, to illustrate the effects of theory or prac- on the general mass of understandings : minds the or calibre of which, and their power of adapting lves to circumstances, and making the most of hey have, render them exceptions to all rules, and per examples of the most advantageous course of g. Every one likes, no doubt, to draw consequences and concerning his own self from a contemplation: minds and methods of the Newtons or the Galileos gher sphere of intellectual existence, or the Arks- or Telfords of a better state of power of adaptation. is your theory good for ?' says the tongue attached e head which holds about the same weight of that Telford's did of sagacity ; 'Telford knew no- of it, and I may do without it too.' The answer is, l. The opinion of Bacon was, that 'the root of *all chief* in the sciences is, that, falsely magnifying and ng the powers of the mind, we seek not its real a maxim full of meaning, and a lesson to him ites theory too highly, and also to the one who that the only use of his mind is to arrange the of experience, his own or others. What are the y of men, that they should look down upon any of training, theoretical or practical ?

her fault of argument, but almost peculiar to the al world, who have the force of numbers on their le, is the habit of claiming all who are success- application as instances of their own method ights of their own order. Suppose that one indivi- ould discover a mine, work it with his own hand, the ore, and beat the metal into a horse-shoe ; is he, a geologist, miner, furnace-man, or black-

He has done the work of all, but the community ksmiths would hardly be allowed to claim him as rly belonging to themselves. When a person who ndered the difficulties of theory has also success- plied them, he is free of both corporations ; but ho attend to application only, never fail to appon- nis merits. WATT is a striking instance ; he was a P. C., No. 1530.

highly accomplished theorist on every point on which he worked : and yet his name has been frequently cited as a proof that theory could be dispensed with. And his career, when compared with that of Telford, will illustrate theory applied to practice, as distinguished from practice alone, however acute. It is impossible to contemplate the career of Telford without a feeling of high interest, created by the comparison of his apparently inadequate education with his startling successes. Looking at the individual himself, there is everything for his age to admire ; and as long as his structures last, each of them is the *monumentum*, but not *cere perennius*. The time will come when his name shall be like that of the builder of the old London bridge, who was no doubt the Telford of the day, a stimulus to his contemporaries, useful and honoured, but not the remembered of succeeding ages. On the other hand, the discoveries of Watt, though equally startling in what is called the practical point of view, have the mind of the discoverer impressed upon them, and have been, and must be, the guide of his successors, not merely to repetitions of what he did himself, but to enlargement of ideas, and to the conversion of principles into forms useful in art. Take away the honourable qualities which enabled the two men to outstrip their contemporaries, each in his line, qualities which are the properties of the individual minds, and consider what is left, namely, their modes of proceeding : consider the effect of these two modes upon men in general, and there is nothing in that of Telford which would raise the workman above a workman, while in that of Watt there is the vital principle to which we owe all the mechanical triumphs of civilization and all the theoretical successes of philosophy.

This country has been long and happily distinguished for the great attention which has been paid to application ; but it is a mistake to suppose, as some do, that our supremacy in practical matters has been coordinate with, still less owing to, neglect of theory. It would be easy to show that though the comparative neglect of theory alone, as a pursuit, added to its diligent cultivation on the Continent, has given to foreign countries a decided preponderance of theoretical inquirers and writers, yet that there has been no country in Europe in which a competent knowledge of the mathematics and their applications has been spread over so large a mass, or raised to so high an average. At any time since the beginning of the seventeenth century the total amount of theory in Britain has been larger than in any other European country, on account of the numbers who have possessed a useful amount of knowledge : the diffusion of education in Germany may have altered our position, but of this we are not sure. For ourselves we are perfectly satisfied, however little those most concerned may know it, that this greater diffusion of theory has been the original moving cause of the practical excellence to which we have alluded. If those who have become known for splendid achievements in the former are few, the same may also be said of the latter ; but a country owes its excellence in either department, not to one or two of the highest, but to the mass of those who have competent knowledge, producing good habits of thought and action. It is a new thing to hear one branch set against the other, and would make our writers of a century back think that posterity had lost its senses. The only addition wanted has been some means of systematically nurturing the growth of theory, so that, well as we have done with what we have, we may do better with more. The efforts which are making on every side to extend education will, it may be hoped, do what is wanted in this particular ; they will at least have the effect of making it clear that, whatever the force of genius may do for an isolated exception, the mass of mankind must place their best hope of progress in the union of theory and practice.

There is also a mode of viewing what we may call the action of theory, which is absolutely necessary to a true conception of the value of their labours who employ their time in its advancement. Watch the arguments of a person who calls himself, distinctively, a practical man, and it will be always found that a well-established theory, fifty years old, is practical knowledge, so called. To this there cannot be the slightest objection in the non-distinctive sense : a well-established theory, which has been shown to be sufficient, is practical, as opposed to one of which

the investigation is more recent, and the completeness not so well ascertained. But when the question is theory, as theory, against practice, as practice, the advocates of the latter frequently find it convenient to assume, for their own share of the matters in contest, all the best theories *plus* the most recent practical knowledge, leaving to the other side the onus of supporting theory upon the most imperfect part of the mass of doctrines which it contains, being that part which is not yet off the anvil. Suppose a merchant going into the bail court to prove his being worth a certain sum: he is asked whether his business, all debts and risks allowed for, would produce that sum: he replies, that his ventures must be beyond record unsuccessful, if it would not be so, over and over again. 'So then,' he is further questioned, 'you cannot positively swear that your business will make you worth the sum in question.' 'I cannot,' he replies, 'positively swear any such thing; but I have enough not employed in business, in land and mortgages, and in the funds, to pay twenty shillings in the pound five times over, upon every risk which I am liable to.' What would be thought of counsel who should retort, 'That is nothing to us; you are described as a merchant, and your solvency must be tried by the state of that part of your property which is now undergoing the fluctuations of trade?' Such is and always must be the state of theory: the amount which is actually realised is enormously greater than the floating balance which is being worked out. Those who are engaged in producing fixed capital from the latter, have a right to the credit which arises from the interest of the former: their labours for the time being are not to produce their return at the instant.

We have, in compliance with common notions, not adverted to the consequences of theory upon the mind and thoughts of men, but have treated it as if its sole object were to advance the mechanical arts and better the physical condition of society. But this is under protest that even if it could not be proved that rational investigation of nature had added one single atom to the physical comfort of life, there would remain such an enormous mass of social ameliorations which can be traced to that source as would outweigh even the triumphs of steam.

THEORY OF COUPLES. The two motions of which any rigid system is susceptible are those of TRANSLATION and of ROTATION. Each of these has this peculiarity, namely, that one particular case of its application yields the other kind of motion. Every motion of a system can, for any one instant, be resolved, at most, into a motion of translation of the whole system, combined with a motion of rotation about an axis; and every application of a system of forces to any rigid body, produces, generally speaking, this compound of translation and rotation. Also, if equal and opposite forces, such as would produce simple translation, be applied at the same point, or if equal and opposite forces, such as would produce rotation, be applied about the same axis, the result is that the equilibrium, or previous motion, of the system remains undisturbed.

But if the equal and opposite forces of translation be applied at different points, the result is rotation only, for the first instant; and if the equal and opposite forces of rotation be applied about axes not coinciding, but only parallel, the effect, at the first instant, is translation only. And though the doctrine of motion is now properly excluded from statics, yet the preceding theorems, together with others mentioned in ROTATION, should be well understood, and viewed in connexion with the science of equilibrium, which is always illustrated, though it may not be demonstrated, by such considerations.

It was for a long time a curious but barren exception, that though any two forces acting in the same plane may, generally speaking, have their joint effect supplied by one single third force, yet if the two forces be equal in magnitude, and opposite in direction, no such single third force will do. If indeed they be applied in the same line, as O P and Q R in the first figure, they equilibrate each other: but if not in the same line, as O P and Q R in the second figure, no

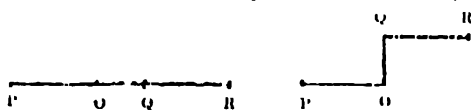

one single force can be found which will either equilibrate

them, or produce their effect. About twenty years ago, M. Poinso, already mentioned for his beautiful theory of ROTATION, applied a remarkable theorem connected with such pairs of forces to the establishment of the theory of the statics of rigid bodies, in a manner which has made his system rapidly take its place among the fundamental bases of the science. We shall in this article point out the manner in which this can be done, without much demonstration, with a view to draw the attention of those who have learned the doctrine of equilibrium in the old way: we cannot make it intelligible without too great length: except to those who have learned the principles of analytical statics.

M. Poinso called a pair of equal and opposite forces, not equilibrating each other, by the name of a *couple*; too general a term perhaps: by it is to be understood a couple which cannot be made anything but a couple, or cannot be replaced by one force: an *impossible couple*. The *plane* of the couple is the plane drawn through the parallel forces: the *arm* of the couple is any line drawn perpendicular to the forces from the direction of one to that of the other: the *axis* of the couple is any straight line perpendicular to its plane. And if we consider any axis, it will be apparent that the moment or leverage of the couple [LEVER] to turn the system about that axis is represented by the product of one of the forces and its arm. For if, with reference to the axis, x be the arm of one of the forces, $x \pm a$ is that of the other, a being the arm of the couple. Hence if P one of the forces, the united leverage is $P(x \pm a) = Px$ or $\pm Pa$. This product Pa is called the *moment* of the couple.

The last-mentioned property will give a high probability of itself to the following theorems, which are the basis of the theory of couples, and can be proved, the first by the principle of the composition of forces only, the second by the principle of the lever. Any couple may have the direction of its arm changed, and consequently of its forces, in any manner whatsoever, either in its own plane, or in any plane parallel to it, provided only that the direction in which it tends to turn the system remains unaltered. Secondly, any couple may be replaced by another which has the same moment, the plane and direction of turning remaining unaltered; that is, the arm may be shortened or lengthened in any manner, provided the forces be increased or diminished in the same proportion. If the system were in equilibrium before, it will remain in equilibrium, however its couples may be altered, in any manner described in the above theorems. Hence it follows that a couple is entirely given when there are given—1. Its axis or any line perpendicular to its plane, which is perpendicular to any of the planes into which it may be removed. 2. The moment of the couple: specified two or arms are unnecessary for its description, so long as their product is given. 3. The direction in which it tends to turn the system. The easiest way of describing a couple is then as follows: suppose for example a horizontal axis. Take any vertical line for the axis of the couple, and let the axis lay down a line proportional to its moment, and agree that vertical lines drawn upwards shall represent moments tending to turn the system from west to east, and downwards, those tending to turn the system from east to west. But a sign must also be agreed upon: positive moment must consist in tendency to turn in one direction, and negative in the other.

The composition and resolution of couples is best shown to be done in a manner which perfectly resembles that of ROTATIONS. When the couples can have a common axis, act in the same plane or parallel planes, the moment of the resultant is, in sign and magnitude, the sum of the moments of the components, with their proper signs. To find the resultant of two couples which cannot have a common axis, take axes to them which pass through the same point, and on these axes lay down lines representing the moments of the couples in their proper directions. On those lines complete a parallelogram: the direction of the diagonal is the axis of the resultant couple, and its length represents the moment of the couple. Care must be taken to lay down the directions of the moments properly on the axes: the best rule is, when reference is not made to distinct directions, the rule is as follows: let the parts of the plane of the couples which lie in the angle made by the lines representing the moments be turned by the two couples in opposite directions.

the student to whom such a direction would be useful would say, appeal in all cases to the perceptions derived from ROTATION.

Apply the preceding theorems to the statics of a rigid body, we first take the following conventions:—Assume an origin and three rectangular axes of co-ordinates, as usual. The forces which act at each point of the system be resolved into three, parallel to the axes of x, y, z . Let each force be called positive, when it acts towards the positive part of the axis to which it is parallel; for instance the axis of z be vertical, and if its positive end upwards, all forces in the direction of z , wherever they act, are called positive while they act upwards, and act when downwards. As to couples, let their moments be called positive when, acting in the planes of x and y, z and x, z and y, z , they tend to turn the positive part of the first-named towards the positive part of the second (yz, zx). Let P_1 be the first point of the system: let its co-ordinates be x_1, y_1, z_1 ; let the forces in the three directions acting at that point be X_1, Y_1, Z_1 . Let P_2 be the second point; x_2, y_2, z_2 , its co-ordinates; X_2, Y_2, Z_2 , forces there applied: and so on. All co-ordinates and forces have their proper signs. At the origin apply the opposing pairs of equilibrating forces, X_1 and $-X_1, Y_1$ and $-Y_1, Z_1$ and $-Z_1; X_2$ and $-X_2, Y_2$ and $-Y_2, Z_2$ and $-Z_2$; and so on: which of course do not affect the equilibrium, and are over and above those already applied. At the extremity of x_1 , in the axis of x , apply the equilibrating forces $Y_1, -Y_1$; at the extremity of y_1 , in the axis of y , apply $Z_1, -Z_1$; at the extremity of z_1 , in the axis of z , apply $X_1, -X_1$, and so on for the other points. Let r_1, r_2 , let the points of application of the original forces X_1, Z_1 , be changed so that each shall act at the projected point of application made by its co-ordinate: the same for the other points. Nothing is done but the application of mutually destroying forces, or the change of point of application of a force to another point in the same direction, and the following figure will show the present arrangement for one point. The original forces, transferred, are marked X, Y, Z ; the original point of application, a , and the other forces, equilibrating two and two, great and small letters at their extremities.

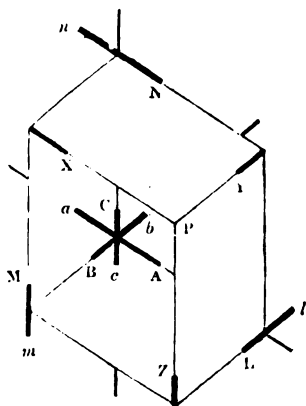

now see that the forces X, Y, Z , are equivalent to the forces X, Y, Z (marked A, B, C) applied at the

A pair of couples to the axis of z (L, b) (X, a), the positive with the moment Yx , the second negative the moment Xy . These two are equivalent to one pair with the moment $Yx - Xy$.

A pair of couples to the axis of x (M, c) (Y, l), the first with the moment of which is $Zy - Yz$.

A pair of couples to the axis of y (N, a) (Z, m) the first with the moment of which is $Xz - Zx$.

Apply this to every point in the system, and let ΣX for $X_1 + X_2 + \dots$, and so on: hence it appears that the whole of the forces are equivalent to forces $\Sigma X, \Sigma Y, \Sigma Z$, applied at the origin in the directions of x, y , and z , and with couples in the planes of xy, yz, zx , of which the moments are—

$$\Sigma(Yx - Xy), \Sigma(Zy - Yz), \Sigma(Xz - Zx).$$

$$\text{Let } A = \Sigma X, \quad L = \Sigma(Yz - Yz)$$

$$B = \Sigma Y, \quad M = \Sigma(Xz - Zx)$$

$$C = \Sigma Z, \quad N = \Sigma(Yx - Xy)$$

$$V = \sqrt{(A^2 + B^2 + C^2)}, \quad W = \sqrt{(L^2 + M^2 + N^2)}$$

Then it appears that all the forces can be reduced to one force, V , acting at the origin, making angles with the axes whose cosines are $A : V, B : V, C : V$; and one couple having a moment W , and whose axis makes with the axes of co-ordinates angles whose cosines are $L : W, M : W, N : W$. But when there is equilibrium, both the force and the moment of the couple must vanish, for the single force cannot equilibrate a couple. Consequently the conditions of equilibrium are $V = 0, W = 0$, which give $A = 0, B = 0, C = 0, L = 0, M = 0, N = 0$, the six well-known conditions of equilibrium.

The forces will have a single resultant when V falls in the plane of the couple whose moment is W ; that is, when the direction of V is at right angles to the axis of the couple. This takes place when $AL + BM + CN = 0$, a well-known condition.

For further information we may refer to Poinso's *Eléments de Statique*; or, in English, to Pratt's *Mathematical Principles of Natural Philosophy*; or Pritchard's *Theory of Couples*.

THEORY OF EQUATIONS. Under this term is expressed all that part of algebra which treats of the properties of rational and integral functions of a single variable, such as $ax + b, ax^2 + bx + c, ax^3 + bx^2 + cx + e$, and so on: a, b, c , &c., being any algebraical quantities, positive or negative, whole or fractional, real or imaginary. Unless however the contrary be specified, it is usual to suppose these co-efficients real, not imaginary.

The great question of the earlier algebraists was the finding of a value for the variable which should make the expression equal to a given number or fraction: as what must x be so that $3x^2 + 2x$ may be 11, or $x^3 - x^2 + 6x$ may be 40, and so on. In modern form it would be asked what value of x will make $3x^2 + 2x - 11 = 0$, or $x^3 - x^2 + 6x - 40 = 0$, and so on. To find values of a variable which should make an expression vanish, or become equal to nothing, was then the first desideratum; and these values are now called *roots* of the expression. Later algebraists made the finding of these roots subservient to the discovery of other properties of the expressions.

The Hindu algebraists communicated to the Arabs, and through them to the Italians, the complete solution of equations of the first and second degrees. The Italians added the solution of equations of the third degree, and of the fourth imperfectly. These last two degrees have been completed in more recent times, so that it may be now said that the equations of the first four degrees have been completely conquered: that is to say, having given the equation $ax^4 + bx^3 + cx^2 + ex + f = 0$, an algebraical expression can be found, having four values, and four values only, and being a function of a, b, c, e, f , which being substituted for x on the first side of the equation, shall make that first side vanish. But the student would look in vain through the books of algebra to see this expression: it is both complicated and useless, and it is more desirable to indicate how it is to be found, than to find it.

The equation of the fifth degree was attempted in all quarters, without success: means were found of approximating to the arithmetical value of one or another root in any one given equation; but never a definite function of the co-efficients which would apply in all cases. A proof was given by Abel, in Crelle's Journal (reprinted in his works), that such an expression was impossible, but this proof was not generally received: it was admitted by Sir W. Hamilton, who illustrated the argument at great length in the 'Transactions' of the Royal Irish Academy, vol. xviii., part ii.; but the singular complexity of the reasoning will probably prevent most persons from attending to the subject. We do not mean in this article to enter into the history of the theory of equations, but only to place its general state before the reader by an exhibition of the principal theorems, mostly without proof. For works on the subject we may refer as follows:—Hutton, *Tracts*, vol. ii., Tract 33, which contains a full account of the earlier algebraists; Peacock, 'Report on certain Parts of Analysis,' in the *Report of the Third Meeting of the British Association*; or the recent works of Murphy, Young, or Hymers; all of which are good, and written on such different plans that any one who makes a particular study of the subject will find it advantageous to consult them all. In French the standard works are those of Budan, Lagrange, and Fourier, which however all treat of particular topics; the

algebraical treatises of Bourdon and Lefebvre de Fourcy take it more generally.

The particular points relative to equations of the first four degrees are as follows:—

1. The expression of the first degree can be reduced to the form $ax+b$; it vanishes when $x = -b:a$, and has only this one root. And $ax+b$ is of the same sign as a or not, according as x is greater or less than the root.

2. The expression of the second degree is more important. It can always be reduced to the form ax^2+bx+c , and its properties are best developed by transforming the preceding into

$$\frac{(2ax+b)^2+4ac-b^2}{4a}$$

There are three distinct cases, according as b^2 is greater than, equal to, or less than, $4ac$.

When $b^2 > 4ac$, the expression ax^2+bx+c has two real and differing roots, contained in the formula*

$$\frac{-b \pm \sqrt{(b^2-4ac)}}{2a}$$

and has always the same sign as a , except when x lies between those roots. Every change of signs in passing from a to b and from b to c indicates a positive root, and every continuation a negative root: and when one root is positive and one root negative, the positive or negative root is numerically the greater, according as (a, b) shows a change or continuation. When $x = -b:2a$, the expression is at its numerical maximum between the two roots, its then value being $(4ac-b^2):4a$.

When $b^2 = 4ac$, the expression ax^2+bx+c is a perfect square with respect to x , and absolutely so if a be a square. The two roots become equal, and each equal to $-b:2a$. The expression now never differs in sign from a .

When $b^2 < 4ac$, the two roots become imaginary, the expression always has the sign of a , and is numerically least when $x = -b:2a$, being then $(4ac-b^2):4a$.

3. The equation of the third degree (or cubic) has been separately considered in the article IRREDUCIBLE CASE.

4. Nothing belongs particularly to the equation of the fourth degree (or biquadratic) except the recital of the various modes in which the solution is reduced to that of a cubic. The various modes are distinguished by the names of their inventors.

Ferrari. Let $x^4+ax^2+bx+c=0$. This can be transformed into

$$(x^2+r)^2 = (2r-a)x^2 - bx + r^2 - c:$$

make the second side a perfect square; that is, find r from $b^2 = 4(r^2 - c)(2r - a)$,

or $8r^3 - 4ar^2 - 8cr + 4ac - b^2 = 0$; the extraction of the square root then reduces the biquadratic to a couple of quadratics.

Des Cartes. Let $x^4+ax^2+bx+c = (x^2 + \sqrt{p}.x + f)(x^2 - \sqrt{p}.x + g)$, which gives

$$g + f - p = a, (g - f)\sqrt{p} = b, fg = c,$$

or $p^3 + 2ap^2 + (a^2 - 4c)p - b^2 = 0$:

find a positive root of this equation (it certainly has one), and from it find g and f ; then the roots of $x^2 + \sqrt{p}.x + f = 0$, and $x^2 - \sqrt{p}.x + g = 0$, are those of the given equation.

Thomas Simpson gave a modification of Ferrari's method, and Euler one of that of Des Cartes. (Murphy's Theory of Equations (L. U. K.), pp. 54, 55.)

The theory of equations of all degrees is to be divided into two distinct parts; the numerical solution, and the general properties of the roots and the expressions themselves. The numerical solution must be carefully distinguished from the general solution; the former term applying to any mode of approximating to a single root, the latter to any mode of exhibiting a general expression for the roots. We shall begin by the general properties of the roots: the expression in question being ϕx , or

$$a_n x^n + a_{n-1} x^{n-1} + a_{n-2} x^{n-2} + \dots + a_{n-1} x + a_n.$$

1. If r be a root of ϕx , or if $\phi r = 0$, then ϕx is divisible by $x-r$, and the quotient is another such expression of the $(n-1)$ th degree, every root of which is also a root of ϕx , and every number which is not a root of r excepted: is

* This formula should be committed to memory, and quadratic equations always solved by it. Nothing is more amusing than the vitality of the old method of completing the square and extracting the root in every particular case. No doubt a student should have some training in this last mentioned process; but his ultimate method should be that of remembering, once for all, the formula in the text.

not a root of ϕx . Hence ϕx cannot have more than it has dimensions, or cannot have more than n

2. When the expression ϕx is divisible by $(x-r)$ said to have m roots each equal to r ; and when this case, the substitution of $r+y$ for x would give an equation in which y^m is the lowest power of y .

3. Every expression has as many roots as it has dimensions. This proposition is one which has only been demonstrated in elementary works, and we give a demonstration with the view of extending knowledge of a remarkable theorem of M. Cauchy, is just such a theoretical victory over the difficulty finding how many roots in general lie between limits, as Sturm's theorem is relatively to real roots shall assume the extended algebra explained in § &c.

Take any rectangular axes, and let x and y be the ordinates of a point, and consider the expression $(x+y\sqrt{-1})$ which can be reduced to the form $P+Q$ where P and Q is each a real function of x and y . Let the point move round the contour ABCD in the direction of revolution, and let the fraction $P:Q$ be for all the points in the contour; or a sufficient number in succession. Examine every case in which $P:Q$ through 0 and changes sign: let it change sign l times, k times and from $-$ to $+$, l times. Next, when x and y have such values that $x+y\sqrt{-1}$ is a radical expression, or $\phi(x+y\sqrt{-1})=0$, let the point P whose ordinates are x and y be called a radical point. The theorem to be proved is as follows: number of radical points which lie within the contour ABCD is $\frac{1}{2}(k-l)$, neither more nor fewer. It is understood that the contour is so taken that point lies upon it.

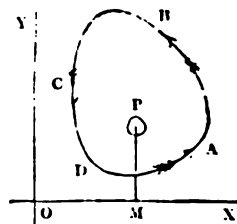

Take any point P within the contour, and round it an infinitely small contour, round which a point is first carried. Four cases arise: neither P nor Q vanish within nor on this contour; P vanishes, but Q does not; Q vanishes, but not P; or both vanish.

If neither P nor Q vanish, there is never a change of sign in either (for being integral functions, they come infinite for any finite values of x and y). The theorem is true for the infinitely small contour; for k and l are both = 0, and there is no radical point.

If P alone vanish, the curve $P=0$ resembles a function of x and y passes through* the contour some other even number of times. The fraction $P:Q$ may vanish and change sign as often as the curve through the infinitely small contour: but there be as many changes from $+$ to $-$ as from $-$ to $+$. Suppose P to be positive at the commencement of revolution: it is therefore positive at the end. Down the sign $+$ twice, and between it write any whatever, as

$$+ - - + + - + - +;$$

it will always be found that $+$ and $-$ occur numbers of times. Hence the theorem is true in every case; for $k=l$, and there is no radical point.

If Q alone vanish, the curve $Q=0$ passes through the point, and everything is as in the last, except that $P:Q$ always becomes infinite when it changes sign. The theorem is true; for k and l are each = 0, and there is no radical point.

Lastly, let there be a radical point within, but not on the infinitely small contour: which may be supposed to contain not more than one distinct radical point. Let the radius vector drawn from the origin to the point of the contour whose co-ordinates are x and y ; so that, using

* Prevent the curve $P=0$ from touching the contour by enlarging it a little if necessary.

algebra, $Z = x + y\sqrt{-1}$. Again, let μ and ν be lines of the radical point, and A its radius vector at $A = \mu + \nu\sqrt{-1}$. Let R be the radius drawn radical point to the contour, so that $Z = A + R$, infinitely small. By hypothesis $\mu + \nu\sqrt{-1}$ is $\phi z = 0$; let there be m equal roots belonging to the radical point (m being $\cdot 1$, or some other integer): $\phi(A + R)$ be capable of expansion into the $+ B_1 R^{m+1} + \dots$, of which, R being infinitely small the first term need be considered. Now let ρ (taking the most general forms) be $b(\cos \beta / -1)$ and $r(\cos \rho + \sin \rho\sqrt{-1})$, whence BR^m

$\{ \cos(m\rho + \beta) + \sin(m\rho + \beta) \cdot \sqrt{-1} \}$, will be $\cot(m\rho + \beta)$, its remaining terms being small. Let R make a complete circuit, or let ρ from 0 to 2π , whence $m\rho + \beta$ will go m times over right angles. In each revolution $\cot(m\rho + \beta)$ will be from $+$ to $-$ twice, passing through nothing: from $-$ to $+$ except by passing through infinity. It is then true: for $k = 2m, l = 0, \frac{1}{2}(k-l) = m$, are m radical points (or one radical point between m equal roots) within the contour. The theorem is then true for every infinitely small contour, let the whole contour $ABCD$ be divided into n number of infinitely small figures, with no more than that no radical point is to fall upon the lines of division. Let a point move round the contour in infinitely small figures in the positive direction. It is clear that the expression $\frac{1}{2}(\Sigma k - \Sigma l)$ will not be altered if we remove all the internal lines and leave only the external contour $ABCD$: the internal line is described by two points moving in opposite directions, and wherever one point adds a unit to the sum, the other adds one to Σl . Hence the value of $\frac{1}{2}(\Sigma k - \Sigma l)$ can be found by finding that of $k-l$ for the boundary, and the theorem is proved.

$AZ^n + A_1 Z^{n-1} + \dots$, and if we make the construction a circle with the origin as a centre, and A great that the highest term AZ^n need be the least, we can immediately prove that ϕZ has not less than n roots. For, Z being $z(\cos \alpha - 1)$, and A being $a(\cos \alpha + \sin \alpha \cdot \sqrt{-1})$, we have that $P:Q$, or all of it that need be $\cot(n\alpha + \alpha)$, whence $k = 2n, l = 0$, and $\frac{1}{2}(k-l)$

may now refer to STURM'S THEOREM, to FOURIER'S given in the article just cited), to Des Cartes' very limited particular case of Fourier's, and to adaptation of, and addition to, the old method of solution by VIETA (an account of the history of the problem is given in the 'Companion to the Algebra' for 1839). We have then, since the beginning of the century, a complete theoretical mode of determining the number of roots, real or imaginary, between any two numbers; both exceedingly difficult in the complications which they require. Also, a mode of approximation, though not theoretically perfect, of the limits between which the real roots lie; and the numerical solution which places that upon the same footing as the common extraction of the cube, &c. roots: making those extractions, except only in the case of the square root, or than before.

Newtonian method of approximation is in the theorem. If a be nearly a root of $\phi x = 0$, and δ be small, then

$$a - \frac{\phi a}{\phi' a}$$

is nearly a root. See APPROXIMATION for the use of HUYGENS'S THEOREM, p. 129, for a more extensive use of the use of Horner's method is very much more than that of Newton: the former, in fact, is a more systematic method. But this remark only applies to algebraical equations: for all others Newton's method remains practically unamended.

See the article ROOT for the solution of

1. The following equation, $x^{2n} \pm 2 \cos \theta \cdot x^n$

$+ 1 = 0$, admits of complete solution on the same principles.

7. If ϕa and ϕb have different signs, one or some other odd number of roots of ϕx lies between a and b : but if they have the same signs, either no one or an even number of roots lies between a and b . Every equation of an odd degree has at least one real root, negative or positive, according as the first and last terms have like or unlike signs. Every equation of an even degree having the first and last terms of unlike signs has at least two real roots, one positive and one negative.

8. If all the coefficients of ϕx be real, and one of the two, $a \pm b\sqrt{-1}$, be a root, so is the other: and if all the coefficients be rational, and one of the two, $a \pm \sqrt{b}$, a and b being rational, be a root, so is the other. If there be a rational fractional root, its denominator must be a divisor of the first coefficient, and its numerator of the last, as soon as the equation $\phi x = 0$ is cleared of fractions. N.B. Among the divisors of a number we reckon 1 and itself.

9. In the equation $a_0 x^n + a_1 x^{n-1} + a_2 x^{n-2} + \dots + a_{n-1} x + a_n = 0$, the sum of all the roots is $-a_1/a_0$, the sum of the products of every two is a_2/a_0 , that of the products of every three is $-a_3/a_0$, and so on. Finally, the product of all the roots is $\pm a_n/a_0$, according as n is even or odd. And if r_1, r_2, \dots, r_n be the roots, then $a_0 x^n + \dots$ is the same as $a_0(x-r_1)(x-r_2)\dots(x-r_n)$.

10. If the preceding expression be called ϕx , and $n a_0 x^{n-1} + (n-1) a_1 x^{n-2} + \dots$, its derived function, be called $\phi' x$, we have

$$\frac{\phi' x}{\phi x} = \frac{1}{x-r_1} + \frac{1}{x-r_2} + \dots + \frac{1}{x-r_n};$$

and if ψx be any rational and integral algebraical function of x , the sum $\psi r_1 + \psi r_2 + \dots + \psi r_n$ is the coefficient of the highest power of x in the remainder of the division of $\phi' x \times \psi x$ by ϕx .

11. If S_n in all cases stand for the sum of the n th powers of the roots of the equation, we have

$$S_0 = n, a_0 S_1 + a_1 = 0, a_0 S_2 + a_1 S_1 + 2a_2 = 0, a_0 S_3 + a_1 S_2 + a_2 S_1 + 3a_3 = 0,$$

and so on up to

$$a_0 S_n + a_1 S_{n-1} + a_2 S_{n-2} + \dots + n a_n = 0$$

after which, in all cases,

$$a_0 S_{n+k} + a_1 S_{n+k-1} + \dots + a_n S_k = 0.$$

Hence also the coefficients of the expression may be found in terms of S_1, S_2, \dots, S_n , as soon as a_0 is given.

12. All rational symmetrical functions of the roots may be easily expressed in terms of S_1, S_2, \dots , and thence in terms of the coefficients of the expression.

13. If it be required to find a function ψy the roots of which shall be given functions of those of ϕx , so that in all cases $y = Fx$, proceed as in finding the highest common divisor of ϕx and $Fx - y$, and take for ψy the final remainder. But if this final remainder should be of a higher dimension than, from the known number of its roots, it ought to be, it will be a sign that some of the factors introduced in the process have affected the remainder, and these must be examined and removed. The treatment of this case belongs to the general question of elimination, but the following particular cases are almost all that are necessary.

14. To decrease all the roots of ϕx by a given quantity, or to make $y = x - a$, or $x = y + a$, observe that the resulting equation must be

$$\phi a + \phi' a \cdot y + \frac{\phi'' a}{2} \cdot y^2 + \dots + \frac{\phi^{(n)} a}{2 \cdot 3 \cdot \dots \cdot n} y^n = 0;$$

where the coefficients $\phi a, \phi' a, \frac{1}{2} \phi'' a, \dots$ may be most readily found by the process described in INVOLUTION (p. 7). The same process may be applied, by using $-a$ instead of a , to increase all the roots of ϕx by a given quantity. It is by this process that the second term of an equation is taken away: thus, the equation being

$$a_0 x^n + a_1 x^{n-1} + \dots = 0, \text{ assume}$$

$$y = x + \frac{1}{n} \frac{a_1}{a_0}$$

the sum of the roots of the equation in x being $-a_1 : a_0$, that of the equation in y will be 0.

15. To multiply all the roots of an equation by m , multiply its successive terms, beginning from the highest, by 1, m , m^2 , m^3 , &c. And to divide all the roots of an equation by m , multiply all the terms by the same, beginning from the lowest. N.B. Terms apparently missing in an equation must never be neglected. Thus $x^7 - 2x^4 + 3x - 1 = 0$ ought to be written

$$x^7 + 0x^6 + 0x^5 - 2x^4 + 0x^3 + 0x^2 + 3x - 1 = 0.$$

This caution is of the utmost importance: in fact no process ought to be applied to any equation without a moment's thought as to whether all the terms are formally written down, and if not, whether the process about to be applied will not require it.

16. To change the signs of all the roots of an equation, change the signs of the coefficients of all the odd powers, or of all the even powers, as most convenient.

17. To change an equation into another whose roots shall be reciprocals of the former roots, for every power of x write its complement to the highest dimension. Thus in an equation of the seventh degree, for x^0 write x^7 , for x write x^6 , for x^2 write x^5 , and so on; lastly, for x^7 write x^0 . N.B. Consider the independent term of the equation as affected by x^0 . From the reciprocal equation can be found the sums of the negative powers of the roots of the original.

18. The old methods of finding limits to the magnitude of the positive and negative roots of an equation are so rapid that they can hardly be said to be superseded by those of Sturm or Fourier. In enunciating them we speak of coefficients absolutely, without their signs, when mentioning any increase or decrease they are to receive.

If A be the greatest of all the quotients made by dividing the co-efficients by the first co-efficient, no root, positive or negative, is numerically so great as A+1. And if B be the greatest of all the quotients made by dividing the co-efficients by the last co-efficient, no root, positive or negative, is numerically so small as 1:(B+1). Better thus: if L be the first co-efficient, M the greatest, and N the last, signs not considered, then all the roots, numerically speaking, lie between

$$\frac{M+L}{L} \text{ and } \frac{N}{M+N}$$

19. If L be the first co-efficient, and M the greatest coefficient which has a different sign from that of L, no positive root is so great as (M+L):L. And if L be the last co-efficient and M the greatest which has a different sign, no positive root is so small as L:(M+L). And to apply this to the negative roots, change the signs of all the roots of the original (§ 16), and find limits to the positive roots of the new one.

20. If L be the first co-efficient, M the greatest which has a different sign, and if the first which has a different sign be in the m th place from the first term exclusive, or belong to the $(m+1)$ th term; then no positive root is so great as

$$1 + \sqrt[m]{\left(\frac{M}{L}\right)}$$

21. If each co-efficient which differs in sign from the first term, be divided by the sum of all which precede and agree with the first term (the first term itself included), the greatest resulting fraction, increased by unity, is greater than any positive root of the equation.

22. Newton's method of finding a limit greater than the greatest positive root of any equation now merges in Fourier's theorem. It consists in finding ϕ by inspection and trial, so that ϕa , $\phi^2 a$, $\phi^3 a$, &c. shall all be positive.

23. Any mode of ascertaining a limit greater than the greatest positive root of an equation may be thus treated. Apply it to the reciprocal equation (§ 17), and the reciprocal of the result attained is less than the least positive root of the original. Apply both to the equation of roots with signs changed, and the results give limits for the negative roots of the original.

24. A celebrated mode of examining the roots of equations, but too complicated for ordinary use, consists in forming the equation whose roots are the squares of the differences of the roots of the original. Any quantity being found less than the least positive root of this new equation, its square root is less than the difference of any two roots of

the original. If such a quantity could be readily & theoretically imperfection of Fourier's theorem is greatly diminished, and, practically speaking, much more would be gained in numerical solution. It is wanted to add to both Fourier's and Horner's the ready mode of finding out when two roots are equal.

25. Lagrange's mode of approximation is as follows: Having found that a root of an equation lies between integers a and $a+1$, diminish all the roots of that equation by a , and take the reciprocal equation to the result; a root of the last lying between the integers b and $b+1$, diminish all the roots by b , and take the reciprocal of the result. Find a root of this last between c and $c+1$, and proceed in the same way. Then the fraction

$$\frac{1}{a+} \frac{1}{b+} \frac{1}{c+} \text{ &c.}$$

is a root of the original.

26. When an equation has equal roots, they can be found by an equation depending entirely on the constant sets of equal roots. If ϕx have m roots, $\phi^2 x$ has $m-1$ of them, $\phi^3 x$ has $m-2$ of them, &c. finally, $\phi^{(m-1)} x$ has one of them. If then ϕx be found to have a common measure, every root common measure enters in ϕx one time more than in $\phi^2 x$ one measure itself.

27. When an equation has an integer root, which is one of the divisors of the last co-efficient, it can be covered by successive trial, as follows:—Suppose $x^2 + a_2 x + a_1 x + a_0 = 0$, a_0, a_1, a_2 being integers, k a divisor of a_0 , and let $a_1 = k l$, an integer. If k be a root, we have $a_0 k^2 + a_1 k + a_2 + l = 0$, an equation divisible by k , giving m , an integer. Hence $a_0 k + m = 0$, and $a_2 + m$ divided by k gives an integer. Hence $a_0 k + a_1 + n = 0$, and $a_1 + n$ divided by k gives an integer. If all these conditions be fulfilled, k is a root. If all these conditions be fulfilled, k is a root. If all these conditions be fulfilled, k is a root. If all these conditions be fulfilled, k is a root.

28. If the co-efficients of an equation read $a, b, c, d, e, f, g, h, i, j, k, l, m, n, o, p, q, r, s, t, u, v, w, x, y, z$ and forwards the same, both in sign and magnitude, the root has its reciprocal also among the roots. It is to the form

$$p + q \left(x + \frac{1}{x}\right) + r \left(x^2 + \frac{1}{x^2}\right) + \dots = 0$$

which can always be done by division, when the dimension is even, and assuming $y = x + x^{-1}$, an equation of the 2nd degree can be reduced to one of the 2nd degree. But when the dimension is odd, $x + 1$ must be a root, and the equation can be reduced to an even degree by division by $x+1$ or $x-1$.

The student who is acquainted with the principles of algebra, namely, such as are either stated or referred to in this article, will find no difficulty either in reading or in its application. It is a subject on which selection should be made by the beginner.

Thera (Θήρα), an island in the Grecian Archipelago and the chief of the group known by the name of Sporades, although called by some ancient writers one of the Cyclades. Its modern name is Santa Thira, which is a corruption of the ancient name Therasia, which is mentioned and usually written Santorini. It is mentioned by Strabo (x. 481, Casaub.) to be 200 stadia in circumference, but by modern travellers thirty-six miles, and is exactly like a horse-shoe. It is opposite to the island of Dia, and distant from Crete 700 stadia, and from the island of Ios, which lay to the north of it, 200 miles. (Pliny, *Hist. Nat.*, iv. 23.) When it first appeared from the sea, it is said to have been called Callistria, a small island to the west, and called at present the same name, was torn away from it, according to the volcanic action seems at one time to have been at work in this part of the sea. Strabo is of opinion that on one occasion flames burst forth from between Thera and Therasia, which lasted for five days, and that an island was formed in consequence of 200 stadia in circumference. The same phenomenon has taken place in modern times, and is particularly mentioned by J. Thévenot in his 'Travels in the Levant'. Pliny also speaks of an island which arose between

erasia, to which he gives the names of Hieria and Te, and of another which appeared in his own age, Chia. The former is now called Aspronisi, or 'the land'; the latter Kaimeni, or 'the burnt.'

was originally inhabited by the Phœnicians, who to have been left there by Cadmus. It was subsequently colonized by Theras with a mixed colony of Dorians and Spartans (Herod., iv. 147, 148), and always remained faithful to its mother-city Sparta. This island was the only island of the Cyclades that remained faithful to Sparta at the beginning of the Peloponnesian war. (Thucyd., ii. 9.) But Theras has acquired its importance from having founded the colony of Cyrene in Africa, under the guidance of Battus, in B.C. 631. (Diod. Sic., iv. 150, &c.)

Doric dialect was spoken at Theras, as we learn from inscriptions, and the government was in the hands of the Dorians and Spartans, who first settled there. We find mention in inscriptions of a senate and an assembly.

There are extant belonging both to the time of the independence and that of the Roman empire. The former kind bear the letters ΘΗ, with the figure of a youth on one side and three dolphins on the

other. At the present day the island is covered with pumice-land though the soil is dry and barren, it produces a quantity of cotton and wine. The wine is strong, and is exported to all parts of the Archipelago. There is no vine in the island; and as it has to be imported, and is not produced by the inhabitants hardly ever have new bread, but eat that composed of wheat and barley, which they make once or four times a year. They have hardly any other very little fruit except grapes, and there is only one vine in the island. It contains a few castles, surrounded by some houses; but the majority of the inhabitants live underground in caves cut out of the pumice-land, which are arched over with very light stones of a reddish colour. The island has a very desolate appearance, the soil being craggy and rugged, and the rocks burnt and reddened. It has only one harbour, in the shape of a bay, but no ship can anchor in it, as no bottom has been found by the plumb-line.

At the beginning of the eighteenth century, when Tournefort visited the island, there were 10,000 inhabitants, of whom there were two bishops, one of the Greek and the other of the Latin church. About two-thirds of the inhabitants belong to the Greek church. (Tournefort, *Voyage into Sicily*, vol. i., p. 202, &c.)

Theramenes (Θηραμένης) was a native of Ceos, and the adopted son of Hagnon, or Agnon, an Athenian. He was a very prominent part about the close and after the end of the Peloponnesian war. He first appears in the history of Greece as taking a part in public affairs in B.C. 410, in conjunction with Antiphon, Phrynichus, and others, he endeavoured to upset the democratical constitution of Athens. In B.C. 410 he took part with Thrasybulus in the battle of Cyzicus, and, in B.C. 406, in the sea-battle of Arginusæ. On this occasion, on which the Athenians gained a glorious victory, many lives were lost, and the wrecks of their ships, which it was thought ought to have been saved if proper care had been taken, were left to rot. Theramenes and Thrasybulus had been commissioned by the Athenian generals to take care of the wrecks and to bury the dead, but they were prevented by a storm from doing this object. The generals in their defence at Athens concealed the commission they had given them, and Theramenes and his colleague, as it was clear that they would be severely punished for their apparent negligence.

After the first report, the generals themselves returned to Athens, and in self-defence were compelled to give an accurate account of the facts, and the more so as they had reason to believe that Theramenes and Thrasybulus were instigating the Athenians against them. That their suspicion was not unbecame evident afterwards, for when six of the generals were actually brought to trial, Theramenes was the first to appear foremost among their accusers. The other generals defended themselves; and the late hour of the day rendering it impossible to take the votes of the assembly, the business was adjourned to another day. In the interval, Theramenes and the other enemies of the democracy exerted themselves to excite the indignation

of the people. On the day appointed for the next meeting a number of persons hired by Theramenes appeared in the assembly dressed in mourning, to rouse the sympathies of the people for the loss of their friends and exasperate them against the alleged authors of their misfortune. After various debates eight of the generals were condemned to death, and six of them, who were present at Athens, were executed immediately. The blame of this act of cruelty falls mainly upon Theramenes, who had taken advantage of the uncommon forbearance and candour of his victims, and of his own reputation, which had never before been stained by any atrocious crime, to effect their destruction.

Soon after the execution of the generals, the eyes of the Athenians were opened, it is said, by Thrasybulus, to their innocence, and it was decided that those who had misled the people should be proceeded against, and that they should give security for their appearance at the trial. Theramenes, however, either by his skill or by accident, not only avoided the prosecution, but retained his place in the popular favour. In the following year (B.C. 405), shortly after the battle of Aegospotami, when an Athenian embassy had been rejected by the Spartan ephors, Theramenes, who, though he belonged to the oligarchical party, yet kept up the appearance of a friend of the people, offered to go as ambassador to Lysander, who was blockading the city, while famine was raging within. Theramenes promised to procure favourable terms, if the people would trust him. The majority readily acceded to his proposal, and he went to the camp of Lysander. Here he stayed for upwards of three months, hoping that in the meantime the city would be reduced to such a state of weakness as to accept any terms, or that in the interval the oligarchical party would gain the ascendancy. There is moreover no doubt that he made Lysander acquainted with the plans of the oligarchs. When he returned to the city, he declared that he had been detained by Lysander, who himself had no power to decide upon the terms of peace with Athens, and that at last he had been directed by the Lacedæmonian general to apply to the government at Sparta. He was accordingly sent thither with nine colleagues, and invested with full power to negotiate peace on any terms. Deputies of the Spartan allies met the ambassadors, and several of them insisted upon the total destruction of Athens; but the Spartans, with an air of generosity, declared themselves willing to grant peace on condition that the long walls and the fortifications of Piræus should be demolished, that all ships of war with the exception of twelve should be delivered up to them, and that Athens should join the Peloponnesian confederacy, and follow Sparta both by land and sea. (Xenophon, *Hellen.*, ii. 2.) When Theramenes and his colleagues returned to Athens with these tidings, the famine had reached its height, but there were still some who refused to submit to the humiliating conditions. Theramenes and his party, anxious to get rid of these few before the report was laid before the assembly, gained over a man of the name of Agoratus to bring accusations against them and get them all arrested. The plan succeeded, and the assembly was held in the theatre of Piræus, where Theramenes urged the necessity of concluding peace on the terms proposed. Notwithstanding the opposition of some citizens to the treaty, and the taunts of others, who saw through the plans of Theramenes, peace was ratified, and Lysander entered Piræus. [LYSANDER.]

After the withdrawal of the Spartan general from Athens, Theramenes, Critias, and their associates, who had assumed the supreme power, wishing to upset the democratical constitution, but to maintain some appearance of decency, invited Lysander to attend the assembly in which alterations in the Attic constitution were to be discussed. Theramenes undertook the management of the business, and proposed that the supreme authority should for the present be placed in thirty persons who should draw up a new code of laws. The presence of Lysander and the neighbourhood of the Peloponnesian troops overwhelmed all attempts of the friends of the people to maintain their constitution, and the proposal of Theramenes was adopted. Theramenes himself was one of the Thirty, and he nominated ten of the others. The outrages and atrocities committed by these Thirty spread general alarm in Attica, and the future was looked to with fearful apprehensions. Theramenes, perceiving the state of feel-

ing at Athens, remonstrated with Critias, the most cruel among his colleagues. This was not from a feeling of humanity, but simply because he saw that the measures of the Thirty would ruin them. Critias was unconcerned about all consequences, and Theramenes gave way. Repeated warnings on his part created some fear lest he should betray them and join the popular party, for he was notorious for his political inconstancy, from which he is said to have received the nickname of *Cothurnus* (the shoe which fits either foot). At the same time the Thirty became sensible of their dangerous position, and in order to strengthen themselves they made out a list of 3000 Athenians on whom a kind of franchise was conferred, while all the remaining Athenians were treated as outlaws. Theramenes again was dissatisfied with these proceedings, but the tyrants insisted upon disarming the Athenians, with the exception of the three thousand and the knights. The reckless cruelty and avarice of the Thirty grew worse every day, and it was determined that each of them should select out one rich alien who was to be put to death, and whose property should be taken by his murderer. Theramenes refused to have any share in this crime. This refusal increased the fears of his colleagues, and excited their hatred against him, and they resolved to get rid of him before he could become a dangerous enemy. An accusation was brought against him in the name of the Thirty by Critias before the council. He was charged with being hostile to the existing government, and with betraying its interests. Theramenes defended himself, and made such an impression upon the council, that it appeared willing to acquit him. Critias perceiving this, called into the council-chamber an armed band of his followers, whom he had kept in readiness outside, and conversed for a few moments with his colleagues. Hereupon he declared that with the consent of his friends he crased Theramenes from the list of the Thirty and of the three thousand, and that he might now be condemned to death without trial. Theramenes rushed to the *Hestia* (the altar of *Vesta*), and conjured the members of the council to protect him, and not to allow Critias to dispose of the lives of citizens; but the herald of the Thirty called in the Eleven (the executioners), who apprehended Theramenes and led him away to punishment. The council was struck with amazement at this bold movement, and Theramenes was hurried across the *Agora* by *Satyrus* and the Eleven to prison. When he had drunk the poison which was administered to him, he dashed the cup with the last few drops to the ground, and said, 'This is to the health of my dear Critias.' This happened in B.C. 401.

The manner in which Theramenes died has been admired by ancient and modern writers. But his fortitude was not based on the consciousness of a virtuous life, and he no more deserves admiration than a criminal to whom death is a matter of indifference. *Thucydides* (viii. 68) says of him that he was not wanting in eloquence and alidity. Whether he wrote any orations is uncertain. (*Cicero, De Orat.*, ii. 22; *Brut.*, 7.) He is said to have instructed *Isocrates* (*Dionysius Hal.*, *Isocrat.*, i.), and to have written on rhetoric. If may be true therefore, as *Suidas* says, that he wrote declamations; but it is much more probable that *Suidas* confounds him with a late sophist, Theramenes of *Coos*. (*Eudocia*, 231; *Fabrieius, Biblioth. Græc.*, ii. 748; *Ruhnken, Hist. Crit. Orat. Græc.*, p. 40, &c.)

Xenophon, Hellen., ii. 3; *Plutarch, Nicias*, 2; *Scholiast on Aristoph. Nub.*, 360; *Roman.*, 47, 546; *Diodorus Sic.*, xiii. 38, &c.; *Thirlwall, History of Greece*, vol. iv.; *E. Ph. Harriehs, D. Theramenes, Critias, et Thrasyluli Rebus et Logico*, Hamburg, 1820, 4to.

THERAPEUTICS constitute that department of medical science which relates to the composition, the application, and the modes of operation of the remedies for diseases. Its chief objects are the *materia medica*, or medicines properly so called (*MATERIA MEDICA*); but it includes as subordinate parts hygiene and dietetics, of which the particular purpose is the application of diet and atmospheric and other ordinary non-medical influences, to the preservation or recovery of health.

THERESIENSTADT (*Maria-Theresienstadt, Maria-Theresienopol, Szent Maria Szabolcs, Szabolcsza*) is a very large town in the county of *Bacs*, in Hungary, 24 miles from *Segedin*, in a plain called *Telecska*, on the high road to *Semlin*, in 46° 0' N. lat., and 19° 40' E. long.

After the battle of *Molacs* in 1526, the Turks built on the place where the town now stands. The town was totally defeated at *Zenta*, in 1696, by *Prince Eugene*. The place was, by the emperor's order, surrounded with redoubts, and the defence of the frontiers toward confided to the inhabitants. In 1743, as a reward for eminent military services, it was made a free town or borough, by the name of *Szent-Maria*, with privileges; and the population continually increased by the immigration of Roman Catholics and schismatics from *Dalmatia* and *Bosnia*, and this borough distinguished itself by its loyalty to the empress *queen Theresa*, it was raised to the rank of a free city in January, 1779.

Next to *Pesth* and *Debreczin* *Theresienstadt* is the town in Hungary; yet it is not properly a town, rather an assemblage of villages. It is new and built without any regularity, and so scattered that houses might be erected in the vacant sandy streets. *Pirch* says it is a good quarter of an hour's walk from one end of the market-place to the other, though new and clean, it has a melancholic appearance. There are a few considerable churches, the principal parish church of *St. Theresa*, the Greek church, and the handsome *Greek church*, the *G* the town-house, and the barracks. The town has a more extensive territory than any other town in the county, the area being 556, or, as some say, 560 square miles in extent. (*Stein* makes it only 400 miles.) The whole population does not exceed 35,000 of whom 35,000 are in the town; so that the town is very thinly peopled, there being only three persons in it. The southern part of the territory produces barley, oats, and maize; the northern part is but trees of various kinds have been planted in the direction of a competent person. The breeding of sheep is very flourishing, and numerous herds and flocks of studs of horses, constitute the riches of the town, who carry on a brisk trade in wool, cattle, horses, and raw hides. There are no manufactures, the people work at their own houses, chiefly for the town itself. Many follow the business of weavers, and the women make linen and carpets, they are peculiarly skillful in the art of dyeing; they dye from a large weed or herb, the name of which is known, the red, green, and black dyes for which their carpets are made.

(*Thiele, Das Königreich Ungarn; Blumenbach, Oesterreichische Monarchie; Die Oesterreichische Encyclopædie; Zerny, Handbuch*.)

THERIACA (*Θηριακά*) was the name given to the antidotes to all those medicines which were as antidotes to the bite of venomous animals; those which counteracted poisonous drugs were called *ἀντιφάρμακα* (*Galen, Comment. in Hippocr. De lib. iii., cap. 7, tom. xv., p. 279, ed. Kühn; id. in Hippocr. De Morb. Vulgar. VI., lib. vi., cap. xvii., pt. ii., p. 337*; afterwards however the word to have been somewhat restricted in its significance, least *θηριακή* in the singular number is applied to particular compound, while at the same time it was considered to be a safeguard not only against the bite of venomous animals, but also against poisonous and unwholesome food. *Galen, De Antid., lib. i., c. xiv., p. 1.* Many of these old preparations are mentioned in the writings of the ancient physicians, but it will be enough to mention here the two most famous, the *Mithridatium* (*Μηθριδάτιον*, or *Αντίδοτος Μείζων*) and the *Theriacal Andromachi*.

The *Mithridatium* received its name from *Mithridates*, king of *Pontus*, who had a strong constitution of superior skill in the powers of simple tried the effects of these upon condemned men, and, finding that different drugs counteracted different poisons, he thought that, by putting all of them together, he should be able to make a compound which would render him secure against any poison that could be given him. *Galen, De Antid., p. 2.* According to a commonly said to have so fortified his own body by constant use of this antidote, that he afterwards was able to put an end to his life; but this is, probably, as *Dr. H. Berden* says, *Antither., p. 10*, 'due to the strength of his antidote than to the weakness

However, Pompey seems to have been possessed of vulgar opinion; and, after he had conquered this look uncommon care to secure his writings, in some mighty treasures of natural knowledge. He is convinced of what he might easily have foreseen; presented as laughing at the disappointment of redudity, when, instead of those great arcana, he had one or two trifling receipts:

* Antidotus vero multis Mithridatica fertur
 Consociata modis: sed Magnus, serinus regis
 Quam raperet victor, villem deprendit in illis
 Synthesin, et vulgata salis medicamina risit:
 His denum rutac folium, salis et brevis granum.
 Juglandisque duas, totidem cum corpore fecus:
 Hæc oriente die puro conspersa Lyæo
 Sumebat, metuens delectat quæ pocula mater.
 (Seren. Samon., *De Medic.*, cap. de *Venen. Prohib.*)

ter, however, there was published at Rome a most medicine under the name of Mithridates, which needed to have been found among his papers: its virtue was made to consist in its being a most preservative from all kinds of venom; and who—a proper quantity of it in a morning was insured by poisoning during that whole day. (Galen, *De J.*) By these representations it gained so great on that some of the Roman emperors prepared it themselves with their own hands: several physicians and antients employed their studies upon it in order to make it more perfect; and it has been the subject of disputes among the moderns, as well as the occasion of innumerable accountless medicines made in emulation of it. Notwithstanding the supposed improvements of the original Mithridatum continued for a long time prepared according to a receipt of Servilius, written in a short Greek iambic poem, which is attributed by Galen (*De Antid.*, lib. ii., cap. ii., tom. xiv., p. 100), and which has been published, together with poems, Greek and Latin, Bonnæ, 1833, 4to., edited Harless.

Asclepiades the Elder (who was physician to the Nero, and the first person who is known to have received the title of *Archiatr*) made considerable improvements in the Mithridatum by omitting some of the ingredients, adding others (especially the dried flesh of the viper) and by increasing the proportion of opium. His Mithridatum is embodied in a Greek elegiac poem, in order to be the more easily preserved without alteration. This has been inserted by Galen in two of his works, *De Antid.*, lib. i., cap. vi., et *De Ther. ad Pison.*, has been frequently published in a separate form. It has likewise changed the name of the Mithridatum, reformed to γαλήνη; but in Trajan's time it obtained the name of 'Theriaca,' either from the vipers in it, or from the good effects in curing the bites of venomous animals. (Galen, *De Antid.*, lib. i., cap. 6; *De Ther. ad Pison.*, tom. xiv., pp. 32, 232.) The reputation of this drug was immense, and surpassed even the Mithridatum. The emperor Marcus Aurelius was in the habit of taking a small quantity of it every morning, and was imitated in this practice of his courtiers (Galen, *De Antid.*, lib. i., cap. 4, et at last, finding that it made him drowsy and he left out the juice of the poppy. (Id., *ibid.*, lib. i., cap. 4.) From that time to the present it has more maintained its credit, though upon no principle of reason can this heterogeneous sarrago be vindicated; and it has scarcely ever continued the same for a century together. Celsus is the first who describes the Mithridatum (*De Medic.*, lib. v., cap. 23); and according to his receipts consists of thirty-eight simples. Before Nero's time, these were struck out, and twenty others added. Andromachus, leaving out six ingredients, and twenty-eight, increased the sum total to seventy-five, in the fifth century after Christ (*Tetrab.*, iv., cap. 87, sq., p. 648, ed. H. Steph.), and Nicolaus of Lemnos, in the twelfth (*De Compos. Medicam.*, sec. xxii., p. 639, ed. H. Steph.), give us very different descriptions of it; and since that time it has been in a state of continual fluctuation, the alterations that it has undergone being as great as those which have been made in it. For of the simples that antiently made it, several are utterly unknown; others are only known with great uncertainty, and some very erroneously described; and were so even in Pliny's time (*Hist. Nat.*, lib. xxiv., cap. 1). In the Pharmacopœia of the London College of Physicians both the Mithridatum and the Theriaca Andromachi retained their places certainly as late as the year 1771; and the edition of 1788 is the earliest in which the writer has found it to be omitted. Its rejection was proposed by the late Dr. Heberden (who wrote a little work on the subject, entitled '*Αντιδοχιακὰν*: an Essay on Mithridatum and Theriaca,' 1745, 8vo., pp. 19); and upon the College dividing on the question, there were found to be thirteen votes for retaining and fourteen for rejecting it. (Dr. Paris's *Pharmacologia*, vol. i., p. 49, 6th edit.) In the '*Codex Medicamentarius*, sive *Pharmacopœia Gallica*,' published at Paris, 4to., 1818, this preparation appeared under the appropriate title of '*Electuarium Opiatum Polypharmacum*.' It consisted of seventy-two ingredients, which were arranged under thirteen heads, viz.: 1, *Acria*, of which there were five species; 2, *Amara*, of which there were eight; 3, *Saporis Styptici*, vulgo *Astringentia*, five in number; 4, *Aromatica Exotica*, fourteen; 5, *Aromatica Indigena*, ten; 6, *Aromatica ex Umbelliferis*, seven; 7, *Resinosa et Balsama*, eight; 8, *Graveolentia*, six; 9, *Virosa*, 'seu quæ Narcosin inducunt,' of which there was only one species, viz. Opium Thebaicum; 10, *Terra insipida et inertia*, consisting also of only one species, viz. Terra Lemnia; 11, *Gummosa, Amylacea, &c.*, four in number; 12, *Dulcia*, consisting of Succus Glycyrrhizæ and Mel Narbonense; and, 13, Vinum, or Sherry. An analysis of two ounces of this compound, by M. Guilbert, is given, pp. 324, 325, note; and we are told that one drachm of it contains rather less than one grain of opium. In the last edition of the '*Codex, Pharmacopée Française*,' published at Paris, 4to., 1837, under the authority of a *commission de rédaction*, of which M. Orfila was the president, the medicine still appears, and under its old name *Theriaca*: and this, notwithstanding the many improvements that have been introduced, and the number of similar compounds that have been expelled. (Préface, pp. xvi., xvii.) The composition appears to be very nearly if not exactly the same as in the previous edition, but the ingredients are not divided into heads as before. In some parts of Europe the mode of preparing this drug was reckoned among the mysteries of the state, which it was forbidden to divulge: and for some centuries that which came from Venice was particularly valued.

For further information see Heberden's *Antitheriaca* (from which work great part of these observations are taken); Paris's *Pharmacologia*; and also Barth. à Maranta, *De Theriaca et Mithridatio Libri Duo*, &c., Francof., 1576, 12mo.; Nic. Stelliola, *Theriace et Mithridatia*, Neap., 1577, 4to.; Jo. Bapt. Sylvaticus, *De Compositione et Usu Theriaca Andromachi*, Heidelberg., 1597, 8vo.; Anton. Bertholus, *Idea Theriaca et Mithridatii*, Venet., 1601, 4to.; El. Bonvinus, *De Theriaca liber ex Andromachi Senioris Mente*, Vratislav., 1610, 8vo.; J. Assuerus Ampzing, *De Morborum Differentiis, et de Theriaca Senioris Andromachi*, Rostock, 1623, 8vo.; Angel. Bolzetta, *Theriaca Andromachi Senioris*, &c., Patav., 1626, 4to.; Charas, *Traité de la Thériaque*, Paris, 1668, 12mo., quoted by Choulant, *Handbuch der Bücherkunde für die Aeltere Medicin*.

ANTHERISTICUS, Wagler's name for a genus of birds.

TANTALUS, Gm.

THERMÆ. [BATHS; ROMAN ARCHITECTURE.]

THERMO-ELECTRICITY is a name given to the fluid excited by heat in conducting substances, as wires or bars of metal, generally of different kinds, when they are placed in close contact with each other, end to end, and disposed so as to form a periphery or continuous circuit. Since the effects of heat applied to the ends, or junctions, of the bars are made manifest by a magnetized and balanced needle deviating from its usual position in consequence of the application, thermo-electricity is considered as a branch of electro-magnetism; and it may be said to be connected with the electricity which is excited by heat in tourmaline, boracite, and some other minerals. The discovery of the principle was made in 1822, by Dr. Seebeck of Berlin, while engaged in researches concerning electro-magnetism, which but two years before had been discovered by Professor Oersted of Copenhagen; and the name was given to the fluid by the latter philosopher in order to distinguish it from that which is produced by the usual galvanic apparatus, which he proposed to call hydro-electricity.

Some of the most simple experiments by which the effects of thermo-electricity may be illustrated are those which, soon after the discovery, were made by Professor Moll of Utrecht. (*Edinburgh Philosophical Journal*, No. xvii.) A slip of copper bent in the form of a semicircle was attached (in close contact), at its extremities, to the ends of a bar of antimony about fifteen inches long; and the bar being laid in the direction of the magnetic meridian with the wire above it, a small compass needle was suspended, or supported on a pivot between them. On heating the northern extremity of the bar by the flame of a lamp, the north end of the needle was observed to deviate towards the west. Again, when a slip of zinc and one of copper were bent so that, on the extremities being applied together, there was formed a parallelogram having the junctions of the slips in the middle of the shorter sides, and a compass needle was suspended within the circuit, on placing the apparatus in a plane coinciding with the magnetic meridian, with the longer sides parallel to the horizon (the copper slip being uppermost) and heating the northern point of junction, the needle deviated towards the west: the apparatus being inverted so that the zinc slip was uppermost, on heating the northern junction as before, the needle deviated towards the east. It follows from these experiments that the fluid current, if such it be, which affects the magnetism of the needle, circulates about the copper slip in such a manner that when the latter is in a horizontal position its direction is from west to east, passing above the slip, in a plane perpendicular to its length: this effect is similar to that which takes place, though in a contrary direction, when a magnetized needle is brought near a conducting wire joining the poles of an ordinary galvanic apparatus; for if the conducting wire be placed in a horizontal position in the direction of the magnetic meridian, with the copper, or the negative end of the apparatus towards the north, and the needle be below the wire, the north end of the needle deviates towards the east; if above the wire, towards the west.

Effects similar to those which result from the application of heat take place when one extremity of the bar of antimony, or one of the junctions of the zinc and copper, is made colder than the other by means of ice.

When both ends of the bar were heated, no deviation was produced in the needle; and after deviation had taken place by heating one end only of the bar, in proportion as the heat tended to a uniform diffusion, the needle gradually returned to the direction of the magnetic meridian.

Thermo-electric circuits may be formed in a ring consisting of two curved bars of different metals, as bismuth and copper, each being in the form of a semicircle, and the two being attached together in the direction of a diameter; or they may be produced in a rectangle made by placing in close contact four bars of metal, of two different kinds, following one another alternately. M. Oersted formed a hexagonal circuit with six pieces, three of bismuth and three of antimony, which were disposed in alternate order: on heating, by means of a spirit-lamp, one of the places of junction in the ring, or in the rectangle of four pieces, a compass-needle placed within or below the plane of circuit was found to deviate; and it deviated still more when the opposite angles of the rectangle were heated. In the experiment with the hexagonal circuit the deviation was greater in proportion to the number of alternate joints which were heated. Similar effects were produced when the alternate joints were artificially cooled; but the deviation was the greatest when the alternate joints were heated and the others were cooled.

By doubling the lengths of the bars in a rectangle composed of four, the deviation was less than that which was produced by the smaller rectangle; but when the larger rectangle was composed of eight pieces, the deviation was greater.

In this country the subject of thermo-electricity has been diligently pursued by Professor Cumming of Cambridge, who appears to have entered upon it without any other knowledge of the discovery of Seebeck than the simple fact that electro-magnetical action was produced by heating one end of a bar of antimony, to the extremities of which were made fast those of a brass wire; and the details of his researches are contained in a memoir which is published in the 'Cambridge Philosophical Transactions'

for 1823. From these it appears that all conductors of electricity, on being heated or cooled, exhibit in general magnetical phenomena: but the direction of the action, which is indicated by the deviations produced in a magnetized needle, is not the same in all substances, and with some the direction of the current is contrary to that which is produced. When a single bar, of symmetrical form, is heated in the middle, it produces no effect on the needle, precisely because the opposing currents counteract each other. In a ring formed of two metals, when heated at points of junction, the fluid seems to pass from the one to the other; so that one loses positive electricity and becomes negative, while the other becomes positive.

Professor Cumming having ascertained the effects of heat on bars of bismuth, which were made alternately hot and cold, and were placed in contact with each other at one pair of the hot and cold parts, and also the two ends of the whole compound bar, being connected by two wires, that the action of the whole bar was greater than that of any two portions, one hot and the other cold, was led to the discovery that electricity may be exhibited by the mere juxtaposition of a finite number of small plates. He was also enabled to determine the thermo-electric relations of various metals by merely placing in contact with each other a portion of each of the two kinds of metal to be examined, and touching first one of them, and then the other, with the one end of a silver or copper wire which was heated with the heated bar. When the metals were antimony, the former, on being touched, caused the compass-needle to deviate so as to indicate positive electricity, and the latter so as to indicate negative electricity. In the memoir above quoted there is given a table of the electrical relations of metals in several combinations. In the same memoir there is also a list of several curious anomalies which were observed in the magnetic action: one of these is, that when a wire is used to touch the metals examined, if the wire is iron, the needle deviates a certain number of degrees in the positive direction; then, as the heat of the wire is increased, the deviation in that direction gradually diminishes till it becomes zero; after which the needle places in a negative direction, and it becomes still more so in this direction when the wire acquires a red heat.

If two parallel bars of bismuth are connected at one extremity of each by a bar of antimony, and the other extremities of each by a bar of antimony, so as to form three sides of a square, and the opposite extremities of bismuth are connected with the two sides of the bent wire forming an electro-magnetic circuit [ELECTRO-MAGNETISM, p. 342, vol. ii.], the multiplier deviates very little; but when those two bars are connected by means of a fourth bar, the needle is considerably deflected. Now the effect of a galvanic or hydro-electrical current, when produced by zinc and copper, with common water as a conductor, is very great, and hence it is inferred that the thermo-electricity gives rise to a large quantity of that which is the cause of the magnetic action, the power being however in a state of intensity.

THERMOMETER (from the Greek words *thermos*, and *metron*, a measure) is an instrument by which the temperatures of bodies are ascertained. It consists of a tube with a capillary bore containing in general air or mercury, which expanding or contracting by the change in the temperature of the atmosphere, or of the object being immersed in the liquid or gas which is examined, the state of the atmosphere, liquid, or solid, with respect to caloric is indicated by a scale which is applied to the tube or engraven on its exterior.

The end proposed by a thermometer is to measure the temperature of any body with relation to the temperature of some other substance, as of water at the point of freezing: but the measure so obtained must be understood to express the absolute quantity of caloric in any body, it being well known that different substances, though exhibiting the same apparent temperature, contain very different quantities of caloric to their capacities for that element.

The thermometer must have been in use long before the seventeenth century, but it is generally ascribed to Galileo, and more precisely, to whom the honour of the invention is given, to a physician of Padua named Santorio, and Cornelius

in Holland, are the persons to one of whom, with most probability, ascribed, and the 'Commentaries on Avicenna' (1626), actuator himself: it may however have happened with other scientific discoveries, that the idea occurred to two persons or more at the

thermometers were intended to indicate the temperature of the atmosphere and the most simple of them consisted of a glass-ball at one extremity of which was open at the opposite extremity within the ball and tube being heated by a lamp, and the tube in the vertical position, the open end was a vessel containing a coloured spirit of the atmosphere on this to ascend in the tube till the pressure of the air in the ball and the weight of the tube became equal to the weight of the atmosphere.

In this state, an increase of the pressure of the atmosphere caused the spirit to expand and press down the tube; on the other hand a diminution, by causing that air to contract, caused the external pressure to raise the spirit. This instrument was adapted to the tube in which the degree of temperature by the graduation at the upper extremity of



Original Air-Thermometer.

was made to render the instrument portable the lower part of the tube upwards and terminated also with a ball; and a small aperture in the latter in order that the external air might pass to the lower surface of the spirit. Mr. Boyle modified the air-thermometer by making it quite straight and open at both ends; it was immersed in a small glass vessel containing coloured spirit, and the vessel being hermetically sealed, the variations in the pressure of the atmosphere caused the air in the ball to contract, and thus to press with more force on the surface of the spirit; the latter was made to ascend or descend in the tube.

The thermometer invented by Amontons (1702) consisted of a tube nearly 4 feet long, open at both ends and containing a column of mercury about 29½ inches high at the bottom, where it terminated in a ball: the air in the ball was compressed by the weight of the atmosphere. A light body, in the upper end of a wire, floated on the upper surface of the column of mercury in the tube; and near the wire was an index by which the height of the mercury on a scale was shown. The variation of the temperature of the air in the ball caused the mercury to ascend or descend in the tube; and the corresponding movements in the index. It was proposed to measure high temperatures whose length was only half of that used with the simple air-thermometer.

As the expansion of the air is not proportional to the force of heat, that the length of the column of mercury varies with the temperature of the atmosphere the air which is in contact with the surface of the open vessel, in the first kind of instrument the top of the column of the spirit or mercury, exerts more or less pressure according to the force of heat, and thus the indications afforded by the instrument are rendered erroneous, or require corrections to be applied. The air-thermometer possesses some advantages above those which are possessed by the simple air-thermometer; but not being portable, it has never

been used. A column of mercury in a tube, like that of the simple air-thermometer, but hermetically sealed at the upper end, and inclined at about 45 degrees to form a short branch inclined at about 45 degrees at part of the tube; this branch terminating in a ball. The mercury occupies the straight part of the tube to the height of about 29½ inches above this bend it terminates without entering

into the ball, which, by the construction, is a little above the bend. The part of the tube which is above the column of mercury is free from air, and when the bend is plunged in boiling water the tube is to be in a slightly inclined position, so that a vertical line may pass through the two extremities of the mercurial column: then, upon the ball becoming cool, and the elasticity of the air in it being diminished, the weight of the mercury will cause it to descend in the long branch and rise in the other. The mercury is to be prevented from entering the ball by making the tube decline farther from the vertical position, so that the lower extremity of the mercury may remain in the vertical line before mentioned; and the temperature of the air is to be determined by the height of the top of the column of mercury above a horizontal line passing through the lower extremity, that is, by the cosine of the declination of the tube from the vertical. Since the air in the ball preserves constantly the same volume, the elasticity communicated to it by the calorific in the atmosphere, or by the fluid in which the instrument is plunged, is always in equilibrio with the pressure of the column of mercury, which is the force acting against it, and is proportional to the vertical height of that column.

About the middle of the seventeenth century the members of the Accademia del Cimento caused thermometers to be constructed in which, instead of air, alcohol or spirit of wine was employed. The fluid was introduced, as at present, into a glass tube terminating at bottom in a hollow ball, from which the air had been expelled by heat: the opposite extremity of the tube was then hermetically sealed, and a scale was applied for the purpose of expressing the temperature of the atmosphere, or of the liquid which was to be examined. Alcohol dilates and contracts considerably with the variations of temperature to which it may be subject, though not in so great a degree as air. It is also capable of measuring very low temperatures, but as it is brought to a boiling state sooner than any other liquid, it cannot be employed to ascertain a high degree of heat. Spirit-thermometers were introduced into this country by Mr. Boyle, and they are still used both here and on the Continent.

Sir Isaac Newton, being dissatisfied with the smallness of the range of spirit-thermometers, employed linseed-oil in tubes for the purpose of measuring degrees of heat: this liquid has nearly the same amount of expansibility by increments of caloric as alcohol; and it is capable of bearing very high degrees of heat and cold without either boiling or freezing; but from its viscosity it adheres so much to the interior side of the tube as to render accurate observations quite impossible, and on this account it has not since Newton's time been employed for thermometers.

The thermometer which is now in general use is a slender tube of glass terminating in a ball containing mercury, the air having been expelled and the tube afterwards hermetically sealed. The idea of employing this fluid for the

purpose of measuring degrees of heat by its expansion is supposed to have first occurred to Dr. Halley; and the reason why it was not employed by that philosopher appears to have been that the range of its expansion is much less than that of alcohol. According to Boerhaave (*Elementa Chæmiæ*, 1732), the honour of having been the first to recommend a mercurial thermometer is to be ascribed to Römer, the discoverer of the motion of light, who is said to have invented it in 1709; but it was not till the year 1724 that such a thermometer was known in this country. In that year an account of a mercurial thermometer which had been invented by Fahrenheit, of Amsterdam, in 1720, was read before the Royal Society, and was published in the 'Philosophical Transactions' (vol. xxxiii.). The advantages of mercury over alcohol and air, as a measure of temperature, are that its expansions are more nearly proportional to the increments of caloric than those which take place in either of the other fluids; it is easily deprived of air, and its power to conduct heat being considerable, the changes of its volume by changes of temperature in the surrounding medium take place more rapidly than those of any other fluid except the gases.

At first the scales for measuring the degrees of heat were

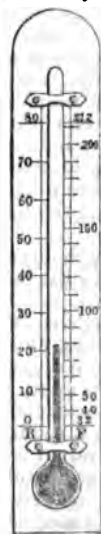

Fahrenheit's Thermometer.

arbitrary, and consequently no two thermometers could be compared together: the scale of the Florentine thermometer was determined by marking the place where the top of the spirit column stood in the tube when the latter was immersed in snow, and the place at which it stood at the time of the greatest heats in Florence: the interval between the points was divided into 60 parts. Subsequently in this country, Mr. Boyle and Sir Isaac Newton formed scales for determining the expansion of the spirit or oil by making the space included in each degree of the tube equal to a certain portion of the whole volume: thus, supposing the ball of the thermometer and part of the tube to be divided into ten thousand equal parts, and to be wholly occupied by the oil when the instrument is plunged in melted ice, Sir Isaac found that by the heat of the human body the oil expanded 256 such parts, and by that of boiling water, 725 parts; then, considering the point at which the top of the column stood in the tube, when the latter was placed in ice, as the zero of the scale, he divided the interval between this point and that at which the top of the column stood when the ball of the thermometer was placed under the arm of a man, into 12 parts. Afterwards by proportion he found that the distance from the ice-point to that of boiling water was equal to 34 such parts (*Phil. Trans.*, vol. xxii.): this method, being of difficult execution, was soon abandoned.

The scale which has been in general use in this country since the year 1724, is supposed to have been invented by Fahrenheit. It is quite unknown on what ground he made choice of the fixed points on his scale, or of the number of graduations between them; but it is thought that one of the fixed points was that of boiling water, and that the other, which is the zero of the scale, was that at which the top of the column stood when the instrument was exposed to an intense cold in Iceland, in 1709. The extent of the scale between this last point and that of boiling water is divided into 212 parts, and the point of freezing water is at the thirty-second division from the zero point. See the scale on the right of the tube in the above figure.

M. Réaumur constructed a thermometer in which spirit of wine was employed, and he formed a scale in a manner nearly similar to that which had been put in practice by Sir Isaac Newton. He computed the volume of the glass ball, and graduated the tube so that the space between two divisions was equal to one-thousandth part of that volume: he then found the zero of the scale by marking the place where the top of the column stood when the thermometer was placed in water just freezing; and afterwards, plunging the instrument in boiling water, he observed whether or not the spirit rose exactly eighty divisions. If not, he strengthened or diluted the spirit till it did so; and the point at which the top of the spirit stood became the point of boiling water. Of this instrument an account was published in the 'Mémoires' of the Academy of Sciences for 1730, but the construction has been long since abandoned; for, besides the difficulty of giving a proper degree of strength to the spirit, it is well known that the latter cannot be made to take the temperature of boiling water, so that the determination of the upper point in the scale must be very erroneous. That which is now called Réaumur's thermometer is an improvement on the former, by M. Deluc, who determined the points of freezing and boiling water by experiment, and divided the distance between them into eighty parts, the zero of the scale being at the former point. See the scale on the left of the tube in the above figure.

A third scale, called 'Centigrade,' has been much in use among the philosophers of the Continent within the last fifty years: it was invented by Celsius, a Swede, and it differs from that of Réaumur or Deluc, only in the distance between the points of freezing and boiling-water being divided into 100 parts. The length of each degree in this thermometer, as well as in that of Réaumur, is greater than in the scale of Fahrenheit; and consequently the indications of temperature, when the top of the spirit or mercury is between the lines of division, are rather uncertain, from the difficulty of estimating them accurately by the eye: also, the temperatures required to be determined being often below the point of freezing-water, the employment of negative signs is of more frequent occurrence with these thermometers than with those of Fahrenheit.

The following formulæ will serve to convert any given

number of degrees on Fahrenheit's scale into the corresponding number of degrees on Réaumur's and the grade scales, and *vice versâ*.

Let F, R, and C express any corresponding numbers of degrees on the three scales respectively: then—

$$(F - 32^\circ) \frac{4}{9} = R, \text{ and } (F - 32^\circ) \frac{5}{9} = C:$$

$$\frac{4}{9} R + 32 = F, \text{ and } \frac{9}{5} C + 32 = F:$$

$$\text{also, } \frac{4}{5} C = R, \text{ and } \frac{5}{4} R = C.$$

N.B. When F is between zero and 32°, the R and C are negative, and express the required degrees below zero on Réaumur's and the Centigrade scale. Also, when F, R, or C expresses any given number of degrees below zero on its proper scale, it is considered as negative.

The scale invented by De l'Isle of St. P. 1733, being still occasionally in use, it may be mentioned that it is formed by making the space in each degree equal to one hundred-thirtieth of the whole volume of the mercury: the zero of the scale is at the point of boiling-water, and between this point and that of freezing-water the space is divided into 100 parts.

It may be observed that the situation of the point on the scales of thermometers can be determined with great accuracy if the ball and part of the tube are immersed in pounded ice; for it is known that the remaining ice and snow remains of the same temperature as long as the ice is entirely dissolved, every accession of water being employed in promoting the melting. But the point of boiling water is far from being so precisely known, since it varies with the density of the atmosphere at the time of making the determination. If the water in an open vessel, and under a given pressure of the atmosphere, boils at an invariable temperature, it is not so in a vessel kept as far as the nature of the vessel may be different; for if the heat communicated to the water is increased, the only effect produced is that of driving off a greater quantity of steam in a given time: if the air is exhausted of the air the water will boil at a temperature expressed by 98° or 100° of Fahrenheit's scale. A vessel constructed so as to prevent the steam from escaping it will remain in a liquid state at a temperature of 400°. In order therefore that the points indicated by different instruments may agree, it is recommended that this point should be found by boiling in the open air at a time, if possible, when the height of the mercurial column in the barometer is 30 inches, and when the temperature of the air is by 55° of Fahrenheit's scale.

This effect of the pressure of the atmosphere on the boiling of water was noticed by Fahrenheit in 1724. M. Deluc, in his 'Recherches sur les Modifications de l'Atmosphère,' has investigated a formula for determining the height of the boiling-point above the zero of the scale in terms of the height of the mercurial barometer; but the English artist Bird was the first who applied a correction on account of the state of the atmosphere, for the purpose of fixing the point of boiling on the scales of thermometers.

The Royal Society having, in 1776, appointed a committee to consider the best means of adjusting the points of thermometers, the formula of Deluc was adopted, and reduced to English measures for the benefit of the public in the event of their being obliged to make the corrections under different states of the atmosphere with respect to density and temperature; and the following are the corrections which are given by Sir George Shuckburgh for determining the true place of the boiling-point of water. The first column contains the height of the

Inches.	
26	- 7.09
27	- 5.27
28	- 3.48
29	- 1.72
30	0
31	+ 1.69

meter in inches; and the second, the correction to be applied with its proper sign to the Fahrenheit's scale, in order to give

ees at which the water will boil under the pressure expressed by the height of the mercurial column. The committee observe that in trying the heat of liquors, theicksilver in the tube of the thermometer should be ated to the same degree as that in the ball; or if this not be done, a correction should be applied on that count. (*Phil. Trans.*, vol. lxvii.)

Thermometer-tubes should have their bores very slender, and, if possible, perfectly equable in the whole of r length. When there is any inequality in the trans-sections, the best artists make the graduations of the vary so that they may correspond to the equal divi-ve of a cylindrical tube; and in order to ascertain the ve dimensions of the sections, they cause a small ity of mercury, about an inch in length, to slide the interior of the tube, measuring its length in dif-places; then, since the lengths are inversely prop-rtional to the areas of the sections, the variations of the per will immediately show the corresponding variations he latter. It is usual to give to the bore an oval form he broader side towards the front, in order that the ecury or spirit may be easily distinguished at a certain nce, as by approaching very near the instrument, the of the observer's person may affect the length of the ann.

It is of course essential that the extent of the thermo-eter-scale should be great enough to comprehend all e temperatures at which the substances generally re-ved to be examined exist in a state of fluidity; and this ent may be obtained when mercury is employed. Ac-ng to the experiments of Mr. Dalton, mercury does oil till it has acquired a temperature equal to 660° of heit's scale; and it does not freeze till it is subject a degree of cold expressed by 39 divisions below the of that scale, or 71° below the freezing-point of water. re alcohol, on the other hand, has never been frozen, ough it has been exposed to a degree of cold exceeding it which is expressed by 91° below the zero of Fahren-it; and therefore a spirit-thermometer is to be preferred one of mercury when it is intended to ascertain the nperature of the air in high northern or southern lati-les: but since the spirit boils in air with a degree of at expressed by 175° of Fahrenheit, it is unfit for many e purposes for which a thermometer is required. For truments capable of measuring very high temperatures,

PYROMETER.

In the construction of a thermometer, the air should be efully expelled from the tube, and even from the mery or spirit within it: the variations in the density of atmosphere cannot of course affect the instrument, ce the tube is hermetically sealed. It must be ob-ved however that the indications of temperature are precisely expressed in terms of the dilatation of the rcury or spirit only, but in terms of the excess of that ation above the dilatation of glass. The apparent di-

n of mercury in a glass tube is equal to $\frac{1}{64.8}$ of its ume, between the temperatures of freezing and boiling ter; and its true dilatation between the same limits is ; of its volume.

A perfect thermometer would be one in which the ex-nsions of the fluid in the tube were exactly proportional he increments of heat which it might receive from the stance whose temperature is to be determined; but it not be said that any of the fluids which as yet have en employed in the construction of thermometers strictly sses this property. Mercury is the fluid in which it ists in the greatest degree; but from the accurate ex-iments of Deluc it has been ascertained that, between e points of freezing and boiling-water, the temperature licated by the mercurial thermometer is lower than the e temperature, the greatest difference, which however ly equal to 1°.4 of Réaumur's scale or 3°.15 Fahren-it, being in the middle between those two points on the le. From the same experiments it is also found that en thermometers are regulated so as to agree at the ints of freezing and boiling water, whether the liquid oil, spirit, or water, the indications are always below se of mercury; the difference being the greatest at the lle between those points. With oil of olives the dif-erence is 1° of Réaumur's scale (2°.25 Fahr.); with highly tified alcohol, 4°.9 Réaumur (11°.02 Fahr.); with half

alcohol and half water, 6°.7 Réaumur (15°.07 Fahr.); and with water, 19°.5 Réaumur (43°.87 Fahr.). It must be ob-erved that great irregularities take place in the expansion of all fluids when near their boiling state, and that mery contracts very suddenly when at the point of its con-gelation. The deviations of the spirit-thermometer from the true indications of heat are known to be rather greater than those of the mercurial thermometer: it may be added that the alcohol in a thermometer-tube loses, in time, part of its strength; and that in consequence, the degree of expansion by a given increment of heat is not the same as when the instrument was made. The expansion of alcohol for temperatures greater than about 175° Fahr., at which the spirit boils, cannot be ascertained practically, because the spirit at that temperature passes into a state of vapour; and the comparison between the mercurial and the spirit thermometer ought not to be carried higher than that temperature; or the scales for mercury and spirit ought to be regulated so as to agree with one another at the freezing-point of water and at the temperature of 175° Fahrenheit: if this were attended to, the differences between the indi-cations of the mercurial and spirit thermometers, above that point, would be less than they appear to be by the tables of Deluc.

Water, like other substances, suffers a diminution of volume by the abstraction of caloric, but when it is cooled to a temperature between 39° and 40° of Fahrenheit's scale, it seems to have attained the maximum of density; and if the process of cooling be continued, it then increases in volume till it is converted into ice. Therefore if a thermo-meter were made with water, and the top of the column were at 50° Fahr., it would be impossible to know whether the temperature were 50° or 30°, the expansion being nearly equal at equal distances within ten degrees above and below 40° of the scale. The cause is uncertain, but it is probably owing to a partial crystallization, which may begin to take place in water when at a temperature ex-pressed by about 8 degrees above its freezing-point.

The mercurial and spirit thermometers, regulated as be-fore said, differ very considerably at temperatures below that of freezing water; and at 39° below the zero of Fahren-heit, or 32° below the zero of Réaumur, when the mery is frozen, the difference has been computed to be about 10° Réaumur (22°.5 Fahr.), by which the spirit stands too low. By observations made during Sir Edward Parry's second voyage, the differences between the indi-cations of the spirit and mercurial thermometers varied from 3°.05 to 8° Fahr. between the temperatures +58° and -30°, the alcohol being always too-low.

Register Thermometers.—It is of great importance in meteorology that the observer should be able to ascertain the highest or lowest point of a thermometer scale at which the column of mercury may have stood during his absence; and several contrivances have been adopted by artists in order to obtain this end. Of these, one, which is still preferred, was invented by Mr. Six, whose name the instrument bears, and is described in the 'Philosophical Transactions' for 1782. It consists of a long tube bent so as to form three parallel branches, A, B, and C: the part A is an elongated bulb, and the rest of the tube has a capillary bore. The lower portion, *b*, contains mercury, which rises in B and C to certain points, as *a* and *c*; and the bulb is filled with spirit of wine, which passing over the bend at *d*, descends to the upper extremity of the mercury in B: above *c* the branch C is also filled with spirit to near the upper extremity, which is hermetically sealed.

Two small indices of steel coated with glass, which are represented at *m* and *n*, are introduced in the branches B and C: these are capable of being forced upwards by the rising of the column of mercury in either tube, and they have about them a fine wire or a thread of glass; so that they will remain stationary where they happen to be when the heads *a* and *c* of the columns recede from

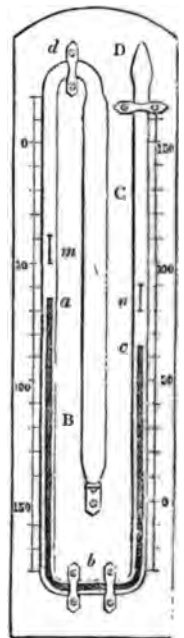

Six's Register Thermometer.

them. Their lower extremities consequently indicate the points at which the ends of the columns may have stood before such recess.

It is evident that the expansion of the spirit in A by increments of heat, will cause that which is in B to press down the column of mercury in that branch and force up the extremity *c*, moving the index *n* before it, while by its friction the index *m* is prevented from descending. On the other hand, the contraction of the spirit in A allows the elasticity of the air in the ball D to force the column in C downwards, the index *n* remaining at the highest point to which it had been previously raised; the mercury in B then rises up, carrying the index *m* before it, till an augmentation of temperature causes the spirit in A to expand, and again force the mercury in B downwards.

The graduations on the scale belonging to the branch C are numbered upwards; while the graduations on the scale belonging to B are numbered downwards. The points *a* and *c* should always indicate the same degree on the two scales; and by means of a magnet the indices *m* and *n* may be brought down to those points: from thence afterwards the former ascends by a decrease, and the latter by an increase of temperature.

An instrument of this kind is generally used for ascertaining the temperature of the ocean at considerable depths, or of the atmosphere at great heights.

Differential Thermometer.—This instrument, which was invented by M. Sturmius, of Altdorf, before the year 1676, and was revived by Professor Leslie in 1804, consists of two thermometer tubes, terminating, at one extremity of each, in a hollow glass ball, and containing coloured sulphuric acid: the opposite extremities are united by the flame of a blow-pipe, and an enlargement of the bore is made at the place of junction. The tube is then bent so as to form three sides of a rectangle, the two balls, which are of equal diameter, forming the upper extremities of two sides; and the instrument is on a stand with the branches of the tube in vertical positions. When the temperature of the air in the two balls is the same, the acid occupies one side and the base, and rises a little way up the other side of the rectangle. To the latter side is attached a graduated scale, with the zero of which the upper extremity of the acid in that branch should coincide. In the event of this adjustment being deranged, it may be restored by causing a small quantity

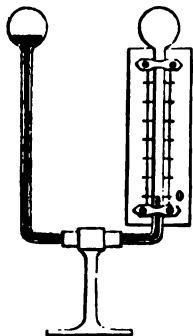

Differential Thermometer, invented by M. Sturmius, of Altdorf.

of air to pass from one ball to the other, which is done simply by the warmth of a hand applied to that ball from whence the air is to be driven.

The variations of temperature in the apartment will evidently have no effect on the instrument, since the action upon the two balls will be equal: but if one ball alone be heated, the rise of the acid in the other will immediately indicate the difference between the temperatures of the media about the two balls by the excess of the expansion of the air in one ball above the expansion in the other. The delicacy of the instrument is such that the least difference of temperature is immediately made sensible by the movement of the acid.

Radiating Thermometer, or Actinometer.—For the purpose of measuring the intensity of solar or terrestrial radiation, an instrument, called an Actinometer, has been used. It consists of a hollow cylinder of glass, which is united at one end to a thermometer-tube, the latter being terminated at the upper extremity by a ball, which is drawn out to a point, and broken off so as to leave a very small orifice: this is stopped up with wax, which is to be removed when the instrument is to be cleaned. The other end of the cylinder is closed by a silver cap furnished with a screw of the same metal, which turns tightly in a collar of waxed leather. The cylinder is filled with a deep blue liquid, and is enclosed in a box, which is blackened on three sides interiorly, and has a thick glass in front. The use of the screw is to diminish or increase the capacity of the cylinder if necessary, driving a portion of liquid into the ball, or withdrawing some from thence so as just to fill the cylinder and the whole stem of the thermometer with the liquid

in an unbroken column. When the instrument is used, it is placed in a horizontal position with face of the box upwards.

In making the observations, the instrument is so that the sun may shine directly upon its face, liquid will mount rapidly in the thermometer should be allowed to do so for three or four minutes, which, by turning the screw, the extremity of must be brought to the zero of the scale. At before a complete minute is indicated by the sun shining on the instrument, the observer below with his eye the top of the rising column of counting by his ear the beats of the watch, when the twentieth second has beat, he registers in a book the of the graduation corresponding to the top of the then, waiting till the watch is at ten seconds of the next minute, the observer follows the rising of the liquid before, and, counting the beats by his ear, at the minute he registers separately the height of the column of liquid. The instrument being then shaded, or covered with a screen, a pair of observations at the interval of one minute, are made and before, the liquid descending in the tube between two observations. The instrument is again placed so that the sun may shine on it, and afterwards in the two other pairs of observations are made, and a mean of the two differences between the two nearest observations while the sun shone on the instrument, added to the difference between the two intermediate observations while the instrument was shaded, is taken as a measure of the intensity of radiation at the middle time between the first two observations; and a mean of such results for all the observations is considered as the general result.

An approximation to the measure of solar radiation may be obtained by simply exposing a register tube with a blackened ball to the direct action of the sun. [RADIATION.] The thermometer should be placed six inches above the ground, and be screened from the wind by a screen of air; and the graduations should be made on the stem of the thermometer, in order to avoid the error of the expansion or warping of the scale.

The force of terrestrial radiation may be measured by the minimum temperature of a register tube whose ball is placed in the focus of a parabolic mirror the face of the mirror is to be turned towards the sky, but away from the rays of the sun.

THERMOMETER, DIFFERENTIAL. [THERM.]

THERMO'PYLÆ. [ZEITOUN, GULF OF.]

THERMOSTAT, or *heat-governor*, an apparatus invented and patented in 1831 by Dr. Ure, for regulating the temperature in the processes of vaporization and condensation, in heating baths and hothouses, in the draft of stoves and furnaces, in ventilating, &c. It acts upon the principle that, when two metallic bars, of different degrees of expansibility, or soldered together side by side, any change of temperature will cause a sensible flexure in the compound bar, the side consisting of the least extensible metal being concave, and the other convex. By this flexure a movement is effected, which, by the intervention of levers, may be made to open or close stop-cocks, ventilators, or any description of valves, and to regulate the flow of heated liquids or the admission or emission of air. The compound bars frequently consist of thin pieces of steel and hard hammered brass, riveted together; but various other metals may be employed in some cases wood may be used for one part of the bar. The principle of the thermostat may be applied in different ways, of which the following may be given as examples. In Fig. 1, *a* is the compound bar, firmly fixed at *b*, and, when exposed to the ordinary temperature of the atmosphere, remains in the straight horizontal position shown in the cut. To the other end of the compound bar, is attached, by means of a connecting rod, the short end of a lever mounted on the axis of a circular revolving valve, or vent, which, from the longer end of the lever is suspended, by means of a valve, or damper, *d*. By increasing the temperature of the chamber or vessel in which the thermostat is placed, the compound bar will assume the cur-

ed lines, by which means the position of the be altered, the valve *c* will be turned on its ne damper will be raised. *Fig. 2* shows another

Fig. 1.

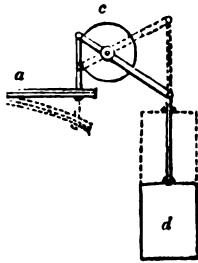
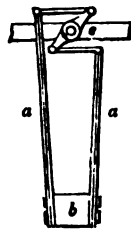

Fig. 2.



it, in which two compound bars, *a, a*, fixed at *a* to open and close a valve *c*, in a pipe through water, or any other fluid is passed. By in-creased temperature of the apparatus, the upper or ends of the bars would recede from each other, and consequently, alter the position of the valve. A trivance may be placed in a chimney, to modify the draught of a damper-plate moving upon its axis, and regulate the draft. The application of such an apparatus to the admission of water-bath is described in the article DISTILLATION, 26. *Fig. 3* shows the principal part of a thermostat in which three pairs of compound bars, *a, a*, are used to give motion to a sliding-rod *d, d*, with which kind of valve may be connected by a rack and chain and pulley, or otherwise. *b, b*, in this case, is a straight guide-rod, which is fixed at one end to a wall; *c, c*, a milled head being added for the purpose of adjusting the apparatus, so that it may act at any temperature. The thermostatic bars, in this case, are of the same form as in the previous cases, are nearly or quite straight, and become more or less curved by the action of the fluid in some modifications of the thermostat the

Fig. 3.

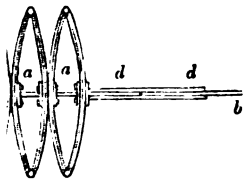
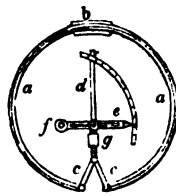

Fig. 4.



is always curved, and the action of the apparatus upon the increase or decrease of the ordinary temperature. *Fig. 4*, for example, represents a thermostatic apparatus which may be immersed horizontally beneath the water-bath of a still. The hoop is fixed to its free ends are attached short links *c, c*, which give longitudinal motion to the rod *d*. *e* is a lever moved by the sliding-rod, and turning a valve on the rod. The outer end of this lever carries an index, which presses against a graduated scale. *g* is a screw-nut, which, upon the sliding-rod, to adjust the apparatus adjusting the scale or arc traversed by the index. The forms of the apparatus are given in Dr. Ure's *Encyclopædia of Arts, &c.*, pp. 1237-1239; and on p. 643 the work is described a contrivance in which the real principle is differently applied.

THE THERMOSTAT. [PAS DE CALAIS.]

THE TEMPLE OF THESEUS (Θησεϊον), the temple of Theseus at Athens, situated in the north-west part of the city, at no great distance from the gate which led to Eleusis, and immediately to the gymnasium of Ptolemy. It was built in the time of Theseus, soon after his bones had been brought out of Athens by Cimon, B.C. 469. (Plutarch, *Life of Cimon*, 8; Diod. Sic., iv. 62.) It possessed the character of a public asylum, where runaway slaves in particular were admitted to take refuge, and was equalled in sanctity by the Parthenon and Eleusinium. (Plutarch, *Life of Theseus*, p. 607 A; Hesychius, and *Etymolog. Mag.*, s. v. Θησεϊον.) Its sacred enclosure was so large as to be sometimes used as a place of military assembly. (Thucyd.,

The temple of Theseus is in a state of greater preservation than almost any of the ancient monuments of Athens, and is used in the present day as a Christian church, dedicated to St. George. It is built entirely of Pentelic marble, and stands upon an artificial foundation formed of large quadrangular blocks of limestone. Its architecture is of the Doric order. It is a peripteral hexastyle, or surrounded by columns, having six in each front. There are thirteen columns on each side, including those at the angles, which are also reckoned among the six belonging to each front, so that the whole number surrounding the temple is thirty-four. It consists of a cella forty feet long, having a pronaos to the east and a posticum to the west. The pronaos and the portico are together thirty-three feet in depth, and the posticum with its portico twenty-seven feet. The breadth of the temple is forty-five feet. The columns are three feet four inches in diameter at the base, and rather more than eighteen feet and a half high, with an intercolumniation of five feet four inches. The height of the temple from the summit of the pediment to the base of the columns is about thirty-one feet. The platform upon which it is built, and which consists of only two steps, is about two feet four inches in height.

The eastern front of the temple was the principal one. This is shown not only by the greater depth of the pronaos, but still more decisively by the sculpture. In the eastern pediment only are there any traces in the marble of metallic fastenings for statues; and the ten metopes of the eastern front, with the four adjoining ones on each side, are exclusively decorated with sculpture, all the others on both sides and on the western front being plain. The only other parts of the temple adorned with sculpture are the friezes over the entrance of the pronaos and the posticum. In the British Museum there are casts of the greater portion of these friezes, and also of three of the metopes from the northern side, being the first, second, and fourth, commencing from the north-east angle. They were made at Athens, by the direction of the earl of Elgin, from the sculptures which then existed upon the temple, where they still remain. The marbles have been greatly injured since the time when Pars made the drawings for Stuart, but enough remains to show that they belong to the highest style of Grecian art: they are almost equal, and, by some, considered even superior, to those of the Parthenon. The relief is bold and salient, approaching to the proportions of the entire statue, the figures in some instances appearing to be only slightly attached to the table of the marble. It appears that all the sculptures were painted, as was the case in many other Grecian temples. Col. Leake says that vestiges of brazen and golden-coloured arms, of a blue sky, and of blue, green, and red drapery, are still very apparent.

The subjects of the sculptures are the exploits of Theseus, and those of his friend and companion Hercules. The metopes in front of the temple relate to the labours of Hercules, and those on the two sides to those of Theseus. On the frieze of the posticum is represented the combat of the Centaurs and the Lapithæ, in which Theseus was engaged; but the subject of the frieze of the pronaos is very doubtful, owing to the mutilated condition of the sculptures. Stuart supposes that it represents part of the battle of Marathon, and especially the phantom of Theseus rushing upon the Persians. Col. Leake thinks it probable that the pannel over the pronaos relates to the exploits of Hercules, in the same way as the other frieze relates to those of Theseus; and he supposes it to represent the battle of the giants, who are said to have been subdued chiefly through the exploits of Hercules. Müller (*Denkmäler der alten Kunst*, p. 11) conceives it to represent the contest of Theseus against the Pallantidæ, who wished to destroy him when he was acknowledged by Ægeus as his successor. Mr. Hawkins (*Description of Antient Marbles in the British Museum*, part ix.) however is of opinion that not one action alone is intended to be represented, but three or four achievements are here recorded, the subjects being separated from one another by groups of seated divinities.

The interior of the temple originally contained three paintings on the walls by Micon, which Pausanias saw and describes (i. 17, § 2). One represented the battle of the Athenians with the Amazons, the second that of the Centaurs and the Lapithæ, and the third an action of Theseus in Crete. The stucco upon which these paintings were

executed is still apparent, and shows that each painting covered the whole wall from the roof to two feet nine inches short of the pavement.

There was also a sanctuary of Theseus in the Peiræus, as appears from an inscription. (Böckh, *Corp. Inscr.*, No. 103.)

(Stuart's *Athens*, vol. iii.; Leake's *Topography of Athens*; *Description of Ancient Marbles in the British Museum*, part ix.; Forchhammer, *Topographie von Athen*, Kiel, 1841.)

THESEUS (Θησεύς), the great national hero of Athens, is said to have been born at Træzen, where his father Ægeus, king of Athens, slept one night with Æthra, the daughter of Pittheus, king of the place. Ægeus, on his departure, hid his sword and shoes under a large stone, and charged Æthra, if she brought forth a son, to send him to Athens with these tokens, as soon as he was able to roll away the stone. She brought forth a son, to whom she gave the name of Theseus, and when he was grown up, informed him of his origin and told him to take up the tokens and sail to Athens, for the roads were infested by robbers and monsters. But Theseus, who was desirous of emulating the glory of Hercules, refused to go by sea, and after destroying various monsters who had been the terror of the country, arrived in safety at Athens. Here he was joyfully recognised by Ægeus, but with difficulty escaped destruction from Medea and the Pallantids, the sons and grandsons of Pallas, the brother of Ægeus. These dangers however he finally surmounted, and slew the Pallantids in battle.

His next exploit was the destruction of the great Marathonian bull, which ravaged the neighbouring country; and shortly after he resolved to deliver the Athenians from the tribute that they were obliged to pay to Minos, king of Crete. Every ninth year the Athenians had to send seven young men and as many virgins to Crete to be devoured by the Minotaur in the Labyrinth. Theseus volunteered to go as one of the victims, and through the assistance of Ariadne, the daughter of Minos, who became enamoured of him, he slew the Minotaur and escaped from the Labyrinth. He then sailed away with Ariadne, whom he deserted in the island of Dia or Naxos, an event which frequently forms the subject of ancient works of art. The sails of the ship in which Theseus left Athens were black, but he promised his father, if he returned in safety, to hoist white sails. This however he neglected to do, and Ægeus seeing the ship draw near with black sails, supposed that his son had perished, and threw himself from a rock.

Theseus now ascended the throne of Athens. But his adventures were by no means concluded. He marched into the country of the Amazons, who dwelt on the Thermodon, according to some accounts in the company of Hercules, and carried away their queen Antiope. The Amazons in revenge invaded Attica, and were with difficulty defeated by the Athenians. This battle was one of the most favourite subjects of the ancient artists, and is commemorated in several works of art that are still extant. Theseus also took part in the Argonautic expedition and the Calydonian hunt. He assisted his friend Pirithous and the Lapithæ in their contest with the Centaurs, and also accompanied the former in his descent to the lower world to carry off Proserpine, the wife of Pluto. When Theseus was fifty years old, according to tradition, he carried off Helen, the daughter of Leda, who was then only nine years of age. But his territory was invaded in consequence by Castor and Pollux, the brothers of Leda; his own people rose against him; and at last, finding his affairs desperate, he withdrew to the island of Scyros, and there perished either by a fall from the cliffs or through the treachery of Lycomedes, the king of the island. For a long time his memory was forgotten by the Athenians, but he was subsequently honoured by them as the greatest of their heroes. At the battle of Marathon they thought they saw him armed and bearing down upon the barbarians; and after the conclusion of the Persian war, his bones were discovered at Scyros by Cimon, who conveyed them to Athens, where they were received with great pomp, and deposited in a temple built to his honour. [THESEIUM.] A festival also was instituted, which was celebrated on the eighth day of every month, but more especially on the eighth of Pyanepsion.

The above is a brief account of the legends prevailing respecting Theseus. But he is moreover represented by

ancient writers as the founder of the Attic constitution and even of its democratical institutions. It is a waste of time to inquire whether there was an personage of this name who actually introduced the political changes ascribed to him: it will be more profitable to adhere to the ancient account in describing the work of Theseus.

Before his time Attica contained many independent townships, which were only nominally united. These incorporated the people into one state, removed the courts for the administration of justice to Athens, and enlarged the city, which had hitherto covered less than the rock which afterwards formed the citadel. He cemented their union he instituted several festivals, and finally changed the Athenæa into the Panathenæa, or festival of all the Atticans. He encouraged the nobles at Athens, and surrendered a part of his kingly power to them, for which reason he is perhaps represented as the founder of the Athenian democracy, although the government which he established was, and continued to be after him, strictly aristocratical. For he divided the people into the tribes or classes of Eupatridæ, Geomori, Demiurgi, of whom the first were nobles, the cultivators, the third artisans. All the offices of those connected with religion were exclusively in the hands of the first class. Each tribe was divided into three phratræ, and each phratry into thirty gentes (γένεαι). The separate phratræ and gentes had their own festivals peculiar to themselves, which were afterwards lost after these communities had lost their political independence by the democratical changes of Cleisthenes. [Cleisthenes.]

(Plutarch's *Life of Theseus*; Meursius, *Theseus et ejus Vita Rebusque Gestis Liber Postumus*, 1684, where all the authorities are quoted; *History of Greece*, vol. ii., p. 8, &c.)

THESMOPHORIA (Θεσμοφορία), a festival in honour of Demeter (Ceres), to which the institutions of civilized life, especially of civil laws, were attributed. The festival of the Thesmophoria especially referred to this part of the character of Demeter, as is clear from several of the ceremonies in its celebration, and from the surname of the goddess, 'Thesmophoros,' from which the festival derived its name. It was celebrated in various towns in Greece, in the Greek colonies, as Sparta, Thebes, Eretria, Epizephyriæ, Agrigentum, and others. But the place where it was held with the greatest solemnity, and where the details of its celebration are best known, was Athens. It was introduced at Athens, according to some writers, by Danaus from Egypt. Its celebration was confined to women, especially married women. It continued for a year on the 11th of Pyanepsion, and lasted for some writers for four, and according to others for three days. The discrepancy in this case, as well as in other Greek and Roman festivals, seems to arise from the circumstance that the real festival consisted of several instances preceded by one or more days devoted to preparations and purifications, and that some writers have considered these days as belonging to the festival. Now the Thesmophoria were preceded by such preparatory days, as is expressly stated, and during these days the women underwent various kinds of purification. The account in his little work cited below, has rendered it probable that the festival itself did not last more than three days.

Previous to its celebration the women of each tribe were selected from among themselves two matrons to preside over the solemnities, whose husbands, provided they had not a dowry of not less than three talents, had to pay the expenses of the festival as a liturgy. (Isæus, *De Heredit.*, p. 208.) The first day of the festival was the *ἀνοδος* or *κάθοδος*, that is, the procession, because the women went from Athens to Eleusis in a procession, which they carried on their heads certain laws written either in books or upon tablets. During the interval between the first and second day the women solved their mysteries at Eleusis. The second day, called the *ἵστασις* or 'the Fast,' was a day of mourning, on which the women were not allowed to take any other food than sesame and honey, and the greater part of it was spent in mournful attitudes on the ground

e of the goddess. Meursius and others think that the procession to the Thesmophoria (the temple of Demeter Thesmophoros) at Athens, which is alluded to by Aristophanes (*Thesmophor.*, 276, &c.), and in which the women went behind a waggon laden with baskets containing corn and symbols, took place in the afternoon of this day, the whole of which was a sacred day at Athens, on which neither the senate nor the people were allowed to hold usual meetings. The third day was called *καλλιγίνεια*, the name of Demeter, by which she was invoked on this occasion. (Aristoph., *Thesmophor.*, 296, with the Scholiast.) On this day the women made up for the day of mourning, indulged in various kinds of merriment in imitation of Demeter, who was believed to have created a smile on the face of the goddess during her grief. Hesychius mentions a sacrifice called *Zemia* (*ζημία*) in connection with the Thesmophoria, which was offered to propitiate the goddess in case of neglect or fault that might have been committed during the celebration of her festival; but whether this sacrifice was offered at the close of the third day or after the festival, cannot be decided.

Meursius, Graecia Feriata, s. v. *Θεσμοφόρια*; *Dictionary of Greek and Roman Antiq.*, s. v. *Thesmophoria*; *Weld's De Thesmophoriis*, Breslau, 1820, 8vo.)

ESPE'SIA (from *ἔσπεσιος*), the name of a genus of trees belonging to the natural order Malvaceæ. The trees are trees with large entire leaves. The calyx is five-lobed, and girdled by a 3-leaved deciduous involucre; the fruit is a capsule with 5 cells, each cell is semi-parted, and contains 1 seed at the base.

Populnea, Poplar Thespesia, has roundish, cordate, 3- to 5-7-veined leaves, with dot-like scales beneath, and the peduncles equal in length to the petioles. This is a native of the East Indies, Guinea, and the Society Islands; and is known, where it grows amongst British Colonists, as the umbrella-tree. It attains a height of 40 feet, and has large yellow flowers with a dark centre. In the tropics it has gained for itself a sacred character, and is planted about monasteries and convents; and is the name Thespesia (divine). There are two species of South America: they are all trees, with some showy flowers. In their cultivation they will strike well in a mixture of loam and sand, and cuttings strike freely in sand or mould under a hand-glass in a hot bed. (*Don's Miller*, vol. i.)

IESPIS (*Ἰέσπις*), a native of Icaria in Attica, who in the time of Solon and Pisistratus, about 535 B.C. ancient traditions unanimously represent him as the inventor of tragedy. The manner in which this invention is said to have originated is stated differently. According to the account, which is also adopted by Horace, it arose from his travelling during the festival of Dionysus through a country upon a waggon, on which he performed comic plays. This tradition however is based upon a confusion of tragedy with comedy, the invention of which is not ascribed to Thespis by any ancient authority. The invention of Thespis consisted in nothing else than in introducing a person who at the Dionysiac festivals in the city of Athens entered into conversation with the chorus, or related a story to it. The designation of this actor was Hypocrites (*ὑπόκριτης*), that is, the 'answerer,' because what he said was answered or corresponded with the songs of the chorus. By means of masks, the invention of which was ascribed to Thespis, he was enabled to act different characters one after another. Some writers who considered Thespis himself as a second actor, speak of two actors in the invention of Thespis, and consequently state that Æschylus introduced a third actor. (Themistius, *Orat.*, xxvi., p. 382, Dindorf.) Whether Thespis wrote his plays is not certain, although Donatus (*De Comoed. et Tragœd.*, Donatus's *Thesaurus*, viii., p. 1387) expressly says so, the tragedies bearing the name of Thespis in the time of the Alexandrines cannot be considered as genuine. It is a historical fact that Heraclides Ponticus forged tragedies under the name of Thespis; and the few fragments of Thespis quoted by ancient writers are unquestionably the work of such supposititious works. The tragedies of Thespis must have fallen into oblivion and have perished long before the time when the Attic drama reached its perfection: some of his choral songs however appear to have been preserved as late as the time of Aristophanes, as we may infer from the concluding scene of the 'Wasps.' We know the titles of four of his tragedies: 'Pentheus,' 'The Funeral

P. C., No. 1532.

Games of Pelias or Phorbas,' 'The Priests,' and 'The Youths;' but of their construction nothing is known, except that each seems to have commenced with a prologue. (Themist., *Orat.*, p. 382.)

Respecting the history of Thespis very little is known. Solon was present at the performance of one of Thespis's plays, and highly disapproved of dramatic performances, as tending to lead men to falsehood and hypocrisy. Towards the end of the career of Thespis tragic contests were introduced at Athens, and Thespis probably contended for the prize with Choerilus and Phrynichus, who is called his disciple. Thespis is also said to have distinguished himself in orchestric, or the art of dancing (Athenæus, i., p. 22), which however can only refer to his skill in instructing the chorus.

(Bode, *Geschichte der Dramat. Dichtkunst der Hellenen*, i., pp. 40-57; Müller, *Hist. of the Lit. of Greece*, i., p. 292, &c.)

THESPROTIA (*Θεσπρωτία*), a district of the antient Epirus, around the river Acheron. Its boundaries are not distinctly stated by antient writers, but the district seems to have included the coast from the mouth of the Ambracian Gulf northwards to the river Thyamis, and the country inland as far as Mount Tomarus. The south-eastern part of Thesprotia, south of the river Acheron, was called Cassopæa, and is sometimes reckoned as a distinct district; but the other statement appears more correct, since Herodotus makes the Thesproti neighbours of the Ambraciots and Leucadians. (Herod., viii. 47.)

Thesprotia was one of the chief abodes of the Pelasgi. This is intimated by the legend which makes Thesprotus the son of Lycaon. In Thesprotia was the oracle of Dodona (Herod., ii. 56), the chief seat of the old Pelasgic religion. [DODONA.] In Thesprotia Aristotle found the Hellenes under their antient name of Graeci (*Γραικοί*, Aristot., *Meteorolog.*, i. 14.) From this country the Thesali migrated to take possession of Thessaly, about sixty years after the Trojan war, having previously left their original seats in Thessaly, and proceeded into Thesprotia, about eight generations before the Trojan war. (Herod., vii. 176; Thucyd., i. 12; Plutarch, *Pyrrh.*, c. i.; Velleius, i. 3; Clinton's *Fasti Hellen.*, i. 19-20, 28.)

Its chief cities were Nicopolis, built by Augustus on the peninsula opposite the promontory of Acte, or Actium, in commemoration of his victory over M. Antonius; Charadra, on the west of the Charadrus; Bucheta, or Buchetima, on the coast. The above are on the south-eastern side of the Acheron. Above the Acheron were,—Cichyrus, formerly Ephyra, on the Acherusian Gulf; Pandosia, higher up the Acheron; Elatria or Elatia, and Batiae, inland; Chimerium, on a promontory of the same name, west of the mouth of the Acheron; north-west of this, Sybota: the positions of Bolurus and Torone are unknown. [EPIRUS.]

(Leake; Pouqueville; Cramer; Hoffmann's *Griechenland*.)

THESSALONIANS, *Epistles of St. Paul to the*. Christianity was introduced among the Thessalonians in A.D. 50, by St. Paul, when he first passed over from Asia Minor into Europe to preach the gospel. According to the account in the *Acts of the Apostles* (ch. xvi.), St. Paul was engaged in communicating to the churches in Asia Minor the decree of the first council of the 'Apostles and elders which were at Jerusalem,' when on his arrival at Troas a vision appeared to him in the night, in the figure of a man of Macedonia, 'who prayed him, saying, Come over into Macedonia, and help us.' In obedience to this call, St. Paul, together with Silas and Timothy, visited the cities of that country, and among the rest Thessalonica, which was at that time the residence of the Roman governor of the province of Macedonia, and a city of great resort. St. Paul found there a synagogue of the Jews, 'and went in unto them, and for three Sabbath days reasoned with them out of the Scriptures,' endeavouring to convince them that Jesus was the Christ or Messiah expected by them. Though some of them believed, his success with the Jews does not appear to have been great: but a considerable number of the 'devout Gentiles' were converted, and many women of distinction: so that the Christian church at Thessalonica was composed both of Jews and Gentiles, of whom the latter were the more numerous. The *Acts of the Apostles* (ch. xvii.) informs us that St. Paul only spent three Sabbath days in preaching to the Jews; but from some expressions in

his own letters to the Thessalonians, coupled with the fact of his receiving money from Philippi more than once while he was at Thessalonica (*Philipp.*, iv. 16), it would seem that he remained for some time in that city. Still he was unable to carry his designs into execution: the unconverted Jews stirred up a persecution against him, so that himself and his companions 'were sent away by night by the brethren' to the neighbouring city of Berea. Here again the Jews of Thessalonica stirred up a tumult against St. Paul, so that he was obliged to retire to Athens, leaving however Silas and Timothy at Berea. At Athens he was subsequently joined by them, and being naturally anxious about his recent converts at Thessalonica, and 'when he could no longer forbear' (1 *Thes.*, iii. 1), he sent Timothy from Athens 'to establish them, and to comfort them concerning the faith.' St. Paul then visited Corinth, and on the return of Timothy with 'good tidings of their faith and charity, and that they had a good remembrance of him always' (1 *Thes.*, iii. 6), he wrote his first epistle to them, A. D. 52, from Corinth, and not from Athens, as the subscription of the epistle imports.

It was one of the earliest, if not the very first, of all St. Paul's epistles, and in chap. v., ver. 27, he expresses his desire that it should be read not at Thessalonica only, but in all the churches of Macedonia. Its genuineness has always been admitted: together with the second epistle, it is quoted and recognised as the work of St. Paul, by Irenæus, Clement of Alexandria, Tertullian, Origen, and all subsequent ecclesiastical writers. (Lardner, as quoted in Horne's *Introduction*, vol. iv., p. 372.) The immediate occasion of St. Paul's writing this Epistle was the favourable intelligence brought by Timothy of the steadiness with which the Thessalonians adhered to Christianity in spite of the persecution with which they were assailed by their own countrymen. Besides being exposed to direct persecution, there can be little doubt that they were also in danger of being moved by the reasonings of their religious adversaries, to which the sudden disappearance of St. Paul from Thessalonica, and his apparent desertion of them at a critical moment, might give some plausibility and apparent confirmation. To counteract the natural result of all this was one of the chief objects of Timothy's mission, and the First Epistle to the Thessalonians was written with the same design. Accordingly in chap. i., after a short introduction, in which he couples the names of Timothy and Sylvanus (the Roman form of Silas) with his own, he expresses his thankfulness for their 'work of faith and labour of love, and patience of hope in our Lord Jesus Christ,' and then (vers. 5-10) reminds them of the proofs 'of power and of the Holy Ghost' with which the preaching of the gospel among them was accompanied, as evidences of its truth, and commends them for the constancy of their faith.

In chap. ii., iii., as a further confirmation of the truth of the gospel, he reminds the Thessalonians of the conduct and character of himself and the other preachers of Christianity. That as a missionary and apostle of Christ, 'he had suffered, and been shamefully entreated'—that in preaching the gospel, he had sought neither temporal profit, nor favour, nor honour. He also explains and vindicates his own conduct in leaving them, and says that although taken from them in presence, he was not in heart,—that he had endeavoured to see them again with great desire, but had been hindered; till at last, when he could no longer forbear, he sent Timothy to them, at whose good tidings of them he expresses the greatest satisfaction and joy.

In chap. iv. St. Paul exhorts them to persevere in the observance of the duties and practical virtues of Christianity, in conformity with the commandments he had given them at first: and further enjoins them not to sorrow or lament over those that were dead, but rather (even as they believed that Jesus died and rose again) to look forward to their resurrection, when the day of the Lord Jesus, that is, the day of judgment, should come.

In chap. v. (1-5) St. Paul warns the Thessalonians of the uncertainty of this event, and concludes the epistle with a variety of precepts and admonitions addressed partly to the whole church, partly to its pastors and teachers, coupled with some reproofs, which, as we may suppose, were called for by the irregularities and failings from which the Thessalonians were not yet exempt.

The undesigned coincidences between this Epistle and the 'Acts of the Apostles' are commented upon by Paley in his *Horæ Paulinæ*, pp. 293-311.

The Second Epistle to the Thessalonians was written soon after the first, and from the same place. Sylvanus and Timothy being joined with the apostle in the inscription of this Epistle, as well as of the former; and as in chap. ver. 2, he requests the prayers of the Thessalonians for deliverance from wicked men, it is not improbable that he wrote it soon after the insurrection of the Jews at Corinth when they dragged him before Gallio, and accused him for persuading men to worship God contrary to the law.

This Epistle seems to have been occasioned by the information which St. Paul received on the state of the church at Thessalonica from the messenger who conveyed his first letter to the elders of the church, and his report of the effect produced by its contents. From some expressions in that Epistle (iv. 15; v. 4-6), compared with chapter ii. of the Second, it would seem that a number of Thessalonians had come to the conclusion that the day of judgment was at hand, and would happen in their generation. To correct this misapprehension, and to prevent the anxiety and the neglect of secular affairs which resulted from it, appears to have been the main object and design of St. Paul in writing this Second Epistle to them.

Accordingly, in chap. i., after a short introduction, the apostle proceeds to commend the growing faith and charity of the Thessalonians, and to express his joy at their patience under tribulation, of which he had heard from the messenger who carried his first letter, and he assures them of his constant prayers for their welfare.

In chap. ii. he rectifies their mistake about the day of judgment, and warns them against those who might attempt to deceive them on that subject. By way of setting their minds at rest about it, he assures them that that event would not come to pass until 'a great apostasy' should overspread the church, and the revelation of 'the man of sin, the son of perdition,' should have taken place. These phrases have been variously interpreted, but the general sense of Protestant commentators have agreed in referring to the Roman pontiffs and the Romish church. Some indeed understand them to apply to the rise of Mohammedanism, and others to the revolt of the Jews for Romans. The Romish church contends that one only is meant, and not a series or succession of persons.

Whatever the apostle meant by these phrases, he informs the Thessalonians that this mystery of iniquity was already secretly at work, though its full operation was prevented by a restraining power 'καταχρον', which the Fathers of the Church generally understood to be the Roman emperors and empire. (Tertullian, *de Resurrectione*, p. 31.)

In chap. iii. the apostle desires their prayers for himself and his fellow-labourers, and then reproves some of the Thessalonians for their idleness and irregularity, and concludes with his apostolic benediction, and with a salutation with his own hand, which, as he informs them, was a token of the genuineness of that and other epistles similarly authenticated.

This Second Epistle to the Thessalonians is the shortest of all St. Paul's Epistles, but not inferior to any of them in style or spirit, and it is also remarkable as containing a distinct prophecy of the corruptions and delusions which were to arise in the Christian church.

The undesigned coincidences between this Epistle and the 'Acts of the Apostles' are given in Paley's *Horæ Paulinæ*, pp. 312-322.

(Macknight, *On the Apostolical Epistles*, vol. i. 124; Horne, *Introduction to the Critical Study of Scriptures*, vol. iv., p. 372; Collyer, *Sacred Inquiries*, vol. ii., p. 275; Percy's *Key to the New Testament*, On the *New Testament*.)

THESSALONICA (now *Saloniki*), an ancient city of Macedonia, in the district of Mygdonia, was formerly called Therme or Therna: it is in 40° 38' N. lat. and 22° 56' E. long., about ten miles east of the ancient city of Echedorus, at the head of the modern Gulf of Saloniki, formerly called the Thermaic Bay, from the ancient name of the city. It was at first an inconsiderable place under its old name of Therme, by which it was known in the days of Herodotus and Thucydides, Æschines, and Strabo, who, in his 'Periplus,' makes mention of the Thermaic Gulf. Herodotus, in his 'History' (vii. 128), speaks of it as a place where Xerxes made some stay on his march into Greece, and from which he had a commanding view of the mountains of Olympus and Ossa in Thessaly. A

previous to the commencement of the Pelopon- (B.C. 432) it was taken and occupied by the but it was soon afterwards restored to Perdicas, of Macedonia. According to an account in *it.*, vii. 330), the name of Thessalonica was by Cassander, the son of Antipater, in honour Thessalonica, who was the daughter of Philip, cedon, and the sister of Alexander the Great. v to its aggrandisement, Cassander collected out B.C. 315) the population of several adjacent to make it one of the most important cities of reece. (Strabo, *l. c.*, p. 330.) After the battle s.c. 168), in which the Romans defeated Per- en king of Macedonia, Thessalonica, with the lonian towns, surrendered to the Romans, and e capital of the second of the four regions into donia was divided by them. (Livy, lib. xlv., i; lib. xlv., c. 29.) Livy speaks of it as being celebrated city, to which its admirable position ontributed. It possessed an excellent harbour, vell situated for commercial intercourse with ont and the Ægean; and it had the additional f lying on the great Roman military road, the a, which, commencing at Dyrrachium, on the e of Greece, and extending to Byzantium, e easiest land communication with Thrace, and the shores of the Euxine. In St. Paul's much frequented by people of different nations ial and other purposes, as appears from the being a synagogue of Jews there; and it was t of the Roman government. Pliny (iv. 10) e city; and Lucian (*Asin.*, 46) speaks of it as of the Macedonian towns. In later times, mpire, it continued to be so flourishing and city, that it was selected as the residence of of Illyricum, and the metropolis of the Illyrian (Theodoret, *Hist. Eccl.*, v. 17.) In the reign r Theodosius it was the scene of a deplorable t was then protected against the assaults of the rong fortifications and a numerous garrison. andant, Botheric, with his principal officers, anly murdered by the people of the town, in e of his having thrown into prison one of the aracters of the circus, to the games of which onians of that time (A.D. 390) were passionately tion, gave orders for the punishment of the l, according to the most moderate accounts, no 000 persons were massacred by barbarian sol- promiscuous carnage, which lasted for three on, *Roman Empire*, c. xxxvii.), a deed, the ch, as Gibbon observes, was aggravated by the quent residence of the emperor at Thessalonica. s; AMBRONE.]

count of the ruins and antiquities of Thessa- Clarke's and Holland's *Travels*, vol. ii., p. 50; *Four in Greece*, vol. ii., c. 19, p. 190; Cramer's *recc.*, i. 238.

ALUS (Θεσσαλός), an ancient Greek physician, celebrated Hippocrates, appears to have lived t of Archelaus, king of Macedonia, about 360 e Christ. He was one of the founders of the Dogmatici, who also took the name of the Hip- hool, because they professed to follow the doc- at great man. However, both he and his brother d his brother-in-law Polybus, are accused by everal passages of not only mixing up with the f Hippocrates the principles of later philoso- also of altering and interpolating his writings. e works that go under the name of Hippo- y many critics supposed to have been written is. viz. 'De Morbis,' the second, fifth, sixth, and oks 'De Morbis Vulgaribus,' and the second 'Prædictiones,' or 'Promthetica;' but this con- cernain.

c. *Hist. de la Méd.*; Fabricius, *Biblioth. Græca*; blioth. *Medic. Pract.*; Sprengel, *Hist. de la kermann, Hist. Literar. Hippocr.*; Choulant, *der Bücherkunde für die Aeltere Medicin.*)

ALUS (Θεσσαλός), one of the founders of the dical sect of the Methodici, was born at Tralles nd lived in the reign of the emperor Nero, in ntury after Christ. He was the son of a weaver,

and followed the same trade himself during his youth, by which means he lost the opportunity of receiving a good education, and was never afterwards able to overcome this disadvantage. He appears however to have soon given up this employment, and applied himself to the study of medicine, by which he acquired a great reputation, and amassed a large fortune. His whole character however, both intellectual and moral, is everywhere represented by Galen in a very unfavourable light; but it must be confessed that Galen himself appears to very little advantage in these passages, and goes beyond all bounds in his abuse of him.

Thessalus adopted the principles of the Methodici, but modified and developed them so much that he attributed to himself the invention of them. In fact on all occasions he appears to have tried to exalt himself at the expense of his predecessors; lavishing upon the antients the most insulting epithets; calling himself by the title *ιατρονικης* (conqueror of physicians), because he thought that he himself surpassed all his predecessors as much as medicine is superior to all other sciences; boasting that he could teach the art of healing in six months; and telling the emperor Nero, in the dedication of one of his works, that none of those who had been before him had contributed anything to the advancement of medical science. By his boasting he attracted a great number of pupils, whom he took with him for six months to visit his patients; but most of them are said to have been common artisans and persons of very low extraction. Galen accuses him of knowing nothing of the action of drugs, though he had written on the subject. He did not care for inquiring into the causes of diseases, and was satisfied with certain problematical analogies; nor did he admit the value of prognostic signs. He did not recommend tapping in cases of ascites. A further account of his opinions may be found in Le Clerc, *Hist. de la Méd.*; Haller, *Biblioth. Medic. Pract.*; Sprengel, *Hist. de la Méd.*

THESSALY (Θεσσαλία), one of the principal divisions of Northern Greece, and the cradle of many of the inhabitants of Greece in general, is an extensive and generally unbroken plain, about 80 miles in extreme length and 70 in breadth, comprising an area of about 5500 square miles, and forming an irregular sort of square. This description applies only to what may be called Thessaly Proper, which is bounded on the west, towards Epirus and Athamania, by the range of Pindus; on the north, towards Macedonia, by the Cambunian Mountains; on the south by the range of Mount Othrys; on the east by a range of mountains running along the coast nearly parallel to Pindus, and including the summits of Pelion and Ossa. The basin of Thessaly is thus surrounded by mountain-barriers, broken at the north-east corner only by the valley and defile of Tempe (or the Cut), which separates Mount Ossa from Olympus, and presents the only road from Thessaly to the north which does not lead over a mountain-pass. At the eastern base of the mountain-range which runs from Tempe to the bay of Pagasæ, now the Gulf of Volo, there is a narrow strip of land called Magnesia, between the hills and the sea, interrupted in several places by lofty headlands and ravines, and without any harbour of refuge from the gales of the north-east. South of Othrys, the southern boundary of Thessaly Proper, lies a long narrow vale, through which winds the river Spercheus, and which, though generally considered as a part of Thessaly, is separated from it by the range of Othrys, and is very different from it in physical features. It is bounded on the south by the range of Ceta, which runs from Pindus to the sea at Thermopylæ in a general direction nearly parallel to the Cambunian Mountains; and on its eastern side by the shores of the bay of Malia, now the Gulf of Zeitoun. According to Greek traditions, Thessaly was known in remote times by the names of Pyrrha, Æmonia, and Æolis. The two former names belong to the age of mythology; the last refers to the time when the country was inhabited by the Æolian Pelasgi, previous to the occupation of any part of it by the Thessalians, who, according to Herodotus (vii. 176; Strabo, ix., p. 444), originally came from Thesprotia, a region in the west of Epirus, and settled in the country, which from them derived its future name. At what time it received the name of Thessaly cannot be determined. The name does not occur in the poems of Homer, although the several principalities of which it was composed at the time of the Trojan war are there enumerated, together

with the different chiefs by whom they were governed: it is from Homer (*Iliad*, ii. 700) that we derive the earliest information about this part of Greece.

From very early times Thessaly was divided into four districts, or tetrarchies. These tetrarchies were, according to Strabo (ix., p. 430), Hestiatotis, Pelasgiotis, Thessalotis, and Phthiotis: and the division, though it was a very ancient institution, existed in the Peloponnesian war (B.C. 404).

The first of these tetrarchies, *Hestiatotis*, was the mountainous country between Pindus and Olympus; having generally for its southern limit the river Peneus, though this river did not form an exact boundary through all its course. Herodotus (i. 156) applies this name to the country in the neighbourhood of Ossa and Olympus, the original abode of the Dorians before they settled in Peloponnesus. From a statement in Strabo (ix., p. 437), it would seem that the name of Hestiatotis was derived from a district in Eubœa, whose inhabitants were transplanted to this part of Thessaly by the Perrhæbi. The Perrhæbi themselves however only occupied a small part of the territory, and as they are said to have been the original inhabitants of the country of the Lapithæ, they must at one time have been established in the lower valley of the Peneus. (Strabo, p. 441.) In historical times they dwelt in the valley of the Titaresius under Olympus, where they had shrunk into a small mountain-people. The north-western part of Hestiatotis was in ante-historical times (Homer, *Il.*, ii. 774) occupied by a mountain-tribe of uncertain origin, called the Æthices. In the time of Strabo (ix., p. 434) scarcely any trace remained of them.

The most remarkable towns of Hestiatotis were as follows:—Phaleria, or Phaloria, the first town of any importance on entering Thessaly from Epirus by the passes of Pindus (Liv., xxxii. 15); Oxyneia and Æginium, the latter of which Livy describes as a place of great strength, and almost impregnable. Gomphi (the Wedges), an ancient fortress, situated on the Peneus to the south of Phaloria: it was a place of great strength, and might be said to be the key of Thessaly on the side of Epirus to the north: it commanded the communication by the gorge of Clinovo, between this part of Thessaly and the Ambracian Gulf. In the time of Cæsar (*Bel. Civ.*, iii. 80) it was a large and opulent city: it is supposed to be represented by the modern Stagous. Tricca, now Trikhala, on the left bank of the Peneus, about 12 miles south of Gomphi: it is celebrated by Homer (*Il.*, ii. 729), and placed by him under the rule of the sons of Æsculapius, who was said to have been born in the neighbourhood. According to Strabo (ix. 437), there was a temple of Æsculapius there, which was held in great veneration: about 12 miles to the north of it is now situated the convent of Meteora, whose name (the Hanging) is descriptive of its situation upon lofty columns of rock. Metropolis, a town to the north of the Peneus, which contained within its territory the lands of three other places not so famous, but more ancient, and which contributed to the formation of the new city. Metropolis, with Gomphi to the north-west, Tricca to the south-west, and Pelinna to the south-east, formed a square of fortresses, in the middle of which was the ancient Ithome, called by Homer the 'precipitous.' Pelinna, more commonly Pelinæum, was an important city on the north of the Peneus, and about 10 miles east of Tricca. Ithome has been supposed to have occupied the site of the convents of Meteora: but it seems to have been farther south. Cæchalia, a city celebrated in mythology, is coupled by Homer with Tricca and Ithome. Gonnus, or Gonni, was a town of considerable importance and antiquity. It was situated on the left or north bank of the river Peneus, about 20 miles from the great city of Larissa, and close to the entrance of the gorge of Tempe. Gonnocondylon, a stronghold in the windings of the valley, was situated in the defile above Gonnus, probably not far from the fortress of Roman construction called Horæo-Castro. The Pelagonian Tripolis, also, a district which included the three towns of Pythium, Azorus, and Doliche, was situated in the north-east of Hestiatotis, and is also reckoned under Perrhæbia by Livy.

Pelasgiotis was in the southern part of the lower valley of the Peneus, and includes the Pelasgian plains which stretch from Larissa to Pheræ, near Pelion, having for its boundary on the east the range of Pelion and Ossa. According to Strabo (ix., p. 441, this part of Thessaly was originally occupied by the Perrhæbi, an ancient tribe of

apparently Pelasgic origin. It was however wrested from them by the Lapithæ, another Pelasgic nation, whose original abode was in Magnesia. They forced some Perrhæbi to retire northwards and across Pindus; those who remained in the plains were incorporated themselves, under the common name of Pelasgiotis. The principal towns of Pelasgiotis were as follows:—Larissa, which was one of the most ancient and flourishing in Thessaly, though not mentioned by Homer; it was in the most fertile part of the old country of the Peloponnesus. The constitution of the city was democratical, the citizens being elected and removable by the people (Aristot., *Politic.*, v. 6.) Accordingly in the Peloponnesian war, the Larissæans supported the Athenians against the Lacedæmonians. The Aleuadiæ, mentioned by Herodotus as princes of Thessaly at the time of the invasion, and one of the most distinguished and powerful families of the country, were natives of Larissa. The territory of this city was extremely rich and fertile, and frequently suffered by the inundations of the Peneus. Modern travellers are of opinion that the present site of the city stands on the site of the old town. The name of Cranon, or Crannon, to the south of Larissa, was one of the most ancient and considerable towns of this part of Thessaly. The inhabitants of this town are supposed by the commentators to be designated by Homer (*Il.*, ii. 301) as the Ephyri. The Scopadæ, a distinguished princely family of Thessaly, belonged to it. The Scopadæ supported the Athenians in the Peloponnesian war, and therefore they may be supposed to have been of a democratical form of government. Scotussa, or Scotussa, of Cranon, though noticed by ancient authors, does not appear to have been known to Homer. (Strabo, ix. 441.) Within its territory was the hill of Cynoscephalæ, or Dogs'-Heads, where a victory was gained by the Romans over Philip of Macedon (B.C. 197). It is one of the most fertile of which separate the plain of Larissa from that of the Peloponnesus. According to some authors, the Thessalian Dolichæ also within the district of Scotussa. Pheræ was situated at the southern extremity of the lake Boebeiis. In the Peloponnesian war the Pheræans assisted the Spartans, whence it is probable that they then had a republican form of government. Subsequently Jason made himself master of Pheræ, his native town, and was succeeded in authority by his brothers. In later times it fell into the hands of Alexander, who continued for eleven years the scourge of his native city, and the whole of Thessaly he was checked by the Thebans, under Pelopidas and Epaminondas. He was at last assassinated by his wife and her brothers, who continued to tyrannise over the country till it was liberated by Philip of Macedon (B.C. 336, dorus, xvi. 517.) After many changes of fortune, taken by the Romans under the consul Acliax (B.C. 146, xxxvi. 14.) Strabo says of it, that the continued misfortune under which it had laboured hastened its decay. Pheræ, according to Polybius (xviii. 2), was most fertile, and the suburbs were surrounded by gardens and walls. Its port was Pagasæ, about 11 or 12 miles from the city. With respect to its modern features, 'Pheræ,' says Gell, 'has hardly preserved any traces of antiquity: a few scattered blocks of stone and some Doric fragments are the only antiquities remaining.' The fountain Hypereia, mentioned by Homer (*Iliad*, vi. 457), 'is in the suburbs of the town of Belestina, at the foot of the ancient Acropolis, a small lake of about 100 yards in diameter, and as clear as crystal, bubbles up out of the ground.' Gell adds, that it runs through a coffeehouse. The Dotius Campus is also in Pelasgiotis, on its eastern side: it is a considerable plain encircled by hills to the north, and terminated to the south by the lake Boebeiis, the most extensive in Thessaly, and included within the territory of Pelasgiotis.

Thessalotis was so called, according to Strabo, because it having been first occupied by Thessalians, who called the country Thesprotia, and inhabited the plains below Hellespontus, having the district of Pelasgiotis on the east. The tetrarchy contained towards the south-east the city of Larissa, celebrated for the battle fought in its plains between Pompey and Cæsar. It is situated not far from the mouth of the Enipeus and the Apidanus, and was of a great size and importance, though no mention is made of it previous to the Persian invasion of Greece. In the Peloponnesian war, the Pharsalians generally fought

enians. Xenophon (*Hellenic.*, vi. 1) speaks of it independent republic, but it afterwards fell into the hands of Jason, tyrant of Pheræ. There is a modern town Pheræ not far from, if not on, the site of the old city; but there are only a few antiquities there. West of it there is a hill surrounded with ancient ruins on a lofty rock above it are other ruins of great magnitude, showing a considerable portion of the remains of an ancient Acropolis and remains of the Propylæa. The principal towns of Thessaliotis were—Cierium, supposed by some to be identical with the ancient Arne, the chief town of the Æolian Bœotians; Ichneæ, or Achneæ, where the goddess Themis was especially worshipped; Proerna, from Pharsalus, mentioned by Strabo (ix., p. 434). Gell observed between Pharsalia and Thaumakos the remains of an ancient city, which he supposed might be Proerna. They are situated upon the projecting summit of a mountain, where there are many vestiges and

remains of the city, according to Strabo, included all the southern

part of Thessaly, stretching lengthwise from the Maliac Gulf to Dolopia and Pindus on the west, and inland from Mount Cœta on the south as far as Pharsalus. The Thessalian plains on the north, an average distance of 30 miles. Homer comprised within its limits the regions of Phthia and Hellas properly so called, and the dominions of Achilles. Its inhabitants were the Achæans (*Ἀχαιῶται*), a double name under which they were enumerated in the lists of the Amphictyonic Council. The principal cities of Phthiotis were Halos or Halon, on the west side of the Gulf of Pagasæ, usually called Ithiote or Achaian, to distinguish it from a city of the same name in Locris. It contained a temple sacred to Jupiter Ithioteus, which was visited by Xerxes as he passed by the city; some remains of the town are thought still existing. Iton, about six miles west of Halos, on the river Cuarius (Strabo), celebrated for a temple of Itonis, who was worshipped under the same name in Thessaly. The district of Arne, from which the Æolianians were expelled by the Thessalians, is by some supposed to have been near these towns and on the eastern side of the Pagasæan Bay; but Müller (*Dorians*, ii. 24) adduces satisfactory reasons for believing that the district which the Thessalians first occupied, lay to the west in Thessaliotis, and that it was identical with the ancient Pierium. North of Halos and Iton lay Thebes, the most important town of this part of Thessaly. It was called Phthiotic, to distinguish it from the Thebes of Boeotia. In a military point of view it possessed considerable importance, as it commanded the avenues of Thessaly and the upper parts of Thessaly. It was once occupied by the Ætolians, but was wrested from them by Philip, the son of Demetrius, who changed its name to Philippopolis. According to Livy (xxix. 25) it was a city of great commercial importance. Some authorities between the modern towns of Armiro and Volo are ascribed by Sir W. Gell to be those of Thebes. They contain an Acropolis, with very ancient walls constructed of very large blocks; some towers also are still standing. The site of Thebes appears to have been Pyrasus, about three miles and a half distant. A little south of Thebes is the town of Cremaste, or the Hanging, so called from its situation on the side of a hill; it was also called the Pelasgic. It lay in the dominions of Achilles, whence he is called Larissæus by Virgil (*Æneid*, ii. 198). The ruins of Thebes are described by Sir W. Gell says of it, 'The form of Larissa is like that of many very ancient Greek cities, a citadel, with its citadel at the highest point. In the ruins are the fragments of a Doric temple; and from the magnificent prospect of the Maliac Gulf, the range of Cœta, and over it Parnassus.' Melitia was situated at the foot of Mount Othrys, on the river Spercheus. Its ancient name was Pyrrha, and it boasted of containing the tomb of Hellen, the son of Deucalion. It was a whole day's march from Pharsalus. (Thucyd., ii. 102.) To the north-west of Melitia lay the town of Ceteans or Thomoko, so called (the Wonderful) from the singularity of its position on a lofty and perpendicular cliff. It was on the great road leading from Thermopylæ to the north of Thessaly. 'After a rugged and steep hill and dale,' says Livy (xxiii. 4), 'you suddenly open on an immense plain like a vast sea, which extends below as far as the eye can reach.' Dodwell

says of it, 'It is about five hours from Pharsalia. It must always have been a place of importance. The view from it is one of the most wonderful and extensive I ever beheld.'

On the west of Phthiotis, and close to it, but still separated from it, lay the territories of the Dolopians. According to Homer (*Il.*, i. 480), Dolopia was at the extremity of Phthiotis; but it does not follow that it was included in that district; nor are the Dolopians in early times ever mentioned as the vassals of the Thessalians. They occupied the extreme south-west angle of Thessaly, formed by the chain of Tymphrestus, a branch of Pindus, on one side, and Mount Othrys on the other. They were a very ancient nation, as appears from their sending deputies to the Amphictyonic council. At a later period they were subjects of Jason, the tyrant of Pheræ. (Xenophon, *Hell.*, vi. 1.) Afterwards the possession of Dolopia was frequently contested between the Ætolians and the kings of Macedon, but it was finally conquered by Perseus, the last king of that country. The limits of Dolopia were different at different times. Thucydides (ii. 102) seems to have extended it to the west of Pindus. It was a rugged mountainous district, with few towns of note. Ctemene, or Ctimene, was perhaps the most important.

The Ænians lived in the upper valley of the river Spercheus, being separated from the Dolopes by the hills of Tymphrestus and Othrys. They were also called Ceteans from their position on the slopes of Mount Cœta. They were a tribe of great antiquity and of some importance, as appears from the fact of their belonging to the Amphictyonic council. Their origin is uncertain, and they made many migrations from one part of Thessaly to another. Plutarch says of them that they occupied in the first instance the Dothian plain; after which they wandered to the borders of Epirus, and finally settled to the south of the Dolopes, with Mount Cœta for their boundary on the south. In Strabo's time they had nearly disappeared, having been exterminated by the Ætolians and Athamanes, their neighbours on the west. Their chief town was Hypata, on the banks of the Spercheus.

The Malians, or Melies, as they were called in the Attic dialect, were the most southern tribe connected with Thessaly. They occupied principally the shores of the Maliac Gulf (the Bay of Zeitoun), from the Pass of Thermopylæ on the south to the northern boundary of the valley of the Spercheus. Their country is generally flat; the plains in some parts are extensive, in others narrow, where they are confined on one side by the shores of the Maliac Gulf, and on the other by the mountains of Trachinia. Thucydides divides them into three tribes, the Paralii or Shore-men, the Hierenses or Sacerdotal, and the Trachinians. The second of these classes probably dwelt near the Amphictyonic temple at Thermopylæ; the third on the rocky declivities of Mount Cœta. They were always a warlike people, and those persons only who had served as heavy-armed soldiers were admitted to a share of the government. (Aristot., *Polit.*, iv. 100.) The Amphictyonic council was held in their country, and the Malians are included in the lists of the Amphictyonic states. They always maintained friendly relations with the Dorians of Lacedæmon. The principal towns of the Malians were as follows:—Anticyra, at the mouth of the Spercheus: it was said to produce the genuine hellebore, considered by the ancients as a cure for insanity. Lamia, four or five miles north of Anticyra: it was celebrated as the scene of the Lamian war, carried on between the Athenians and their confederates against the Macedonians under Antipater. It is generally supposed to have occupied the site of the modern Zeitoun. Trachis, or Trachin (the 'rough'), was so called from the mountainous character of the surrounding country: it was once the chief town of the Trachinians, who were in such close alliance with the Dorians that Diodorus (xii. 59) speaks of Trachis as the mother-town of Lacedæmon. The friendship between Ceyx, a Trachinian hero, and Hercules, together with that of his sons, is the mythological expression for this connection. In later times Heraclea was the most important town of Trachinia. It was a colony from Lacedæmon, founded (b.c. 426) at the request of the Trachinians, about three miles from the sea. Their object in making the request was to gain additional strength against the Ænians, or Ceteans, with whom they were at war: there was also an old enmity between the Ceteans and the Lacedæmonians.

who were on this account the more readily induced to found the colony. It soon became an object of jealousy with the other Thessalian tribes, who frequently harassed it, and the Lacedæmonians often sent reinforcements to its support. It was seized by Jason of Pheræ, who caused the walls to be pulled down; but it again became a flourishing city under the Ætoliæ, who sometimes held the general council of their nation there. It sustained a long siege from the Roman consul Acilius Glabrio, after the defeat of king Antiochus at Thermopylæ (B.C. 191). The surrounding country was marshy and woody, but the vestiges of the city itself, according to Sir W. Gell, are observable on a high flat on the roots of Mount Ceta. On the coast of Trachis, close to the mouth of the small river Asopus, which runs through a gorge in the mountain enclosing the Trachinian plain, was the village of Anthele, near to which was the temple of the Amphictyonic Ceres, and the place of meeting of the Amphictyons. This locality was also famous for the celebrated Pass of Thermopylæ.

Magnesia is a country physically distinct from Thessaly, but in historical times was subject to it, and politically included within it. It is a narrow strip of country between the mouth of the Peneus and the Pagasæan Bay on the north and south, with the chain of Pelion and Ossa on the west, and the sea on the east. The people of this district were called Magnetæ, and they were in possession of it from very early times. (*Iliad*, ii. 756.) They were an Amphictyonic state. In the time of Thucydides they were dependent on the Thessalians, but they subsequently, with the rest of that nation, became dependent on the kings of Macedonia, and continued so till the battle of Cynoscephalæ, when they were declared independent by the Romans. The extreme northern point of Magnesia was Mount Homole, a limb of Ossa, celebrated by the poets as the abode of the antient Centaurs and Lapithæ, and a favourite haunt of the god Pan. (Virgil, *Æneid*, vii. 674.) To the south, at the foot of Ossa, was Melibœa, a town on the coast, ascribed by Homer (*Iliad*, ii. 716) to Philoctetes. Still farther south was the promontory of Sepias, off which the fleet of Xerxes was wrecked. Beyond the southern promontory of Magnesia, now called Hagios Georgios, the coast takes a south-westerly direction to the entrance of the Pagasæan Bay, the Gulf of Volo. Among the principal towns of Magnesia were Iolcos, Demetrias, and Aphieta. The first of these was a place of great antiquity, and the birth-place of the mythological hero Jason and his ancestors. It was situated at the foot of Pelion, near the small river Anaurus: it was once a powerful city, but according to Strabo, its downfall was hastened by civil discord and bad government: its ruin was completed by the foundation of Demetrias in the neighbourhood. The adjoining shore was still called Iolcos in the days of Strabo, though the town no longer existed. Pagasæ, the port of Iolcos, and afterwards of Pheræ, was famed in Grecian story as the harbour from which the ship Argo set sail on her voyage to Colchis: the name, according to Strabo (ix., p. 436), was derived from the number of springs (*Παγαι*) near it. The site is nearly occupied by the present castle of Volo. Demetrias owed its name and origin to Demetrius Polioretetes. It was founded about B.C. 290, and the first population was derived from the neighbouring towns of Nelia, Pagasæ, &c., all of which were eventually comprised within its territory. It soon became a flourishing city, and was one of the most important fortresses in Greece, being well situated for defending the approaches to the Pass of Tempe, both on the side of the mountains and of the plains. Its maritime position also contributed to its importance, Eubœa, Attica, and Peloponnesus being easily accessible from it. After the battle of Cynoscephalæ it became the chief town of the Magnesian republic, and the seat of government: subsequently it was attached to the house of Macedonia, until the battle of Pydna, when it fell under the Romans. (Livy, xlv. 13.) In the time of Strabo it had lost much of its splendour, but it was still the most considerable town of that part of Thessaly. Sir W. Gell thus speaks of its modern state:—"Pass the ruins of a gate and the walls of an antient city. Many other ruins mark the site of a large place Demetrias." The Magnesia of Asia Minor was a colony from the Thessalian Magnesia. [ANATOLIA.]

The principal mountain-ranges of Thessaly were—the Cambunian, on the north; Pindus, on the west; the ridges of Othrys and Ceta, on the south; and those of Pelion and Ossa, on the east.

The Cambunian range was a branch from Mount Pindus running in a direction nearly at right angles to the separating Thessaly from Macedonia. Herodotus mentions this chain under the name of Olympus. The principal road between the two countries over the mountains was by the Pass of Volustana, marked in modern maps as Voloutza. Another important defile, leading from Thessaly into Macedonia, passed by Pythium, a village on the coast, the site of a temple sacred to the Pythian Apollo, situated on Mount Olympus, at the north-east extremity of the range.

Through this latter defile many armies marched in antient times. Thus Xerxes is said by Herodotus (i. 132) to have crossed over Mount Olympus from Macedonia into the country of the Perrhæbi in Thessaly. The road which led through Thessaly to this Pythium was called the Via Pythia; and, as Pouqueville states, the shrine of Apollo may have been succeeded by a chapel erected on the highest summit of Olympus A.D. 1100, and dedicated to the prophet Elias. The defile is still much frequented by travellers going to Larissa from the north-western parts of Macedonia. Mount Olympus itself is one of the most celebrated mountains of Greece, especially in mythology, the stories of which represented it as being the habitation of the Gods, where Jupiter sat shrouded in cloud and mist from the eyes of mortals. It divides the north-east of Thessaly, or Perrhæbia, from Pieria, the extremity of Macedonia on the south-east. It rises to the height of about 6500 English feet, and the highest parts of it are scarcely ever entirely free from snow. The part of the Cambunian range which lies to the west of Olympus was called Mount Titarus, an outlier or limb of which, Mount Cyphus, rises in the upper valley of the Peneus.

Mount Pindus, the western boundary of Thessaly, was part of the range of mountains which issues from the Thracian Scamius, and forms what may be called Greek Apennines. On the north it joins the Elysiac Macedonian ranges, and to the south it is connected with the branches of Ceta and the Ætolian and Achaean mountains. It separates the waters which fall into the Ionian Sea and the Ambracian Gulf (now the Gulf of Ambracia) from those which empty themselves into the northern part of the Ægean. The most frequented pass over Pindus into Epirus lay over a part of it called the Pass of Cerecius, probably not far from the modern town of Parga. One of the highest points of Mount Pindus was Tymphrestus, forming its southern extremity. From this point branched the ridge of Mount Othrys, closing the gulf of Thessaly on the south, and separating the waters which flow into the Peneus from those which run into the southern Spercheus. Its eastern extremity separated the Malian from the Pagasæan Gulf, sinking gently to the coast. It is often celebrated by the poets of antiquity. It is now known by the different names of Hellevo, Hellebovo, and Goura. To the south of Othrys lay the mountain of Ceta, which however has no connection with Pindus. It is a huge pile of mountains stretching from Pindus to the sea, which it meets at the Pass of Tempe. It forms the inner barrier of Greece, as the Cambunian range does the outer, to which it is nearly parallel in position and equal in height. On the west it branches into the country of the Dorians and into Ætolia, south-east, beginning from Mount Callidromus, the summit of the range, it is continued without intermission along the coast of the Eubœan Sea, till it sinks into the valley of the river Asopus. By means of another branch to the south-west, it is connected with Parnassus, skirting the Corinthian Gulf under the name of Parion, and Helicon, it forms the northern boundary of Ætolia under the names of Cithæron and Parnes.

Pelion is a chain of some extent, running from the north-east extremity of the lake called Boebeis to the extreme south of Magnesia, forming a part of the boundary of Thessaly on the east. Homer (*Iliad*, ii. 743) alludes to it as the seat of the Centaurs, and it was associated with many remarkable events in Grecian story. A fragment of Dicaearchus contains a description of Mount Pelion, and its botanical productions, which appear to have been very numerous. It was exceedingly well wooded. To the north of Pelion and following the line of the coast lies the chain of Ossa (now Kissovo), the roots of which unite with one of the branches of Mount Pelion. At its northern extremity it towers into a steep conical peak, and according to the songs of the country, rivals its neighbour Olym-

the depth and duration of its snows, though it is not so great in height. Between Ossa and Olympus lies the celebrated Vale and Pass of Tempe (or the Cut), the name of which is Bogaz (or the Pass). [ΤΕΜΠΕ.]

Two principal rivers of Thessaly into which the other streams fall are the Peneus and the Spercheius. The Peneus rises in the north-west of Thessaly under Pindus, on the lower ridges of which and the outliers of the Cambanian range its upper valleys are confined. Near Larissa, not far from the rocky Ithome of Homer, its basin somewhat towards the south. At Tricca it makes a bend to the east, and its valley expands into a vast plain to the south-east, on the right of the river, though it is confined by the hills on the left, till within about 10 miles from Larissa, where there is a considerable flat to the north, the soil of which is said to be alluvial. Leaving Tricca the course is generally north-east, and along the Vale of Tempe, the only outlet for the Peneus of Thessaly, it empties itself into the Ægean Sea. It is fed by the most considerable rivers of Thessaly, the Enipeus, a very small stream, and generally sluggish and shallow, except after the melting of the snows, when it sometimes floods the surrounding plains. The Marsh or Lake of Tricca, on the road between Larissa and Gonnus, is said to be caused by the floods of the river. The principal affluent of the Peneus on the north is the Titaresius, now called the Poros. It was said to rise in Mount Titarus, of the Cambanian range, and it joins the Peneus a short distance above the Vale of Tempe. The waters of the two did not however mingle; those of the Titaresius impregnated with a fat unctuous substance, which is said to be like oil on the surface. (Strabo, ix., p. 441.) This stream was also called the Eurotas, and supposed to be a branch of the Styx, one of the rivers of the Infernal Regions. In the present day the inhabitants of its banks are remarkable for their healthy complexion, while the Peneus is surrounded by a sickly population. Its waters also are said to be clear and dark-coloured, while those of the Peneus are white. (Müller, *Dorians*, b. i., c. 1, s. 6.) On the other hand the affluents of the Peneus were more numerous. The principal of them were, the Pamisus, the Onochonus, the Enipeus, and the Apidanus. The Pamisus joins the Peneus to the east of Tricca, and is probably the modern Enipeus. The Enipeus, rising in Mount Othrys, flowed from the north-west of Phthiotis and fell into the Apidanus. It is now called the river of Goura. The Apidanus is now the Enipeus. Herodotus describes it as one of the largest rivers of Achaia, but still inadequate to the supply of the Persian army with water.

The second great river of Thessaly was the Spercheius, which flows into the Ægean Sea. It flows from Tymphrestus, a branch of the Cambanian range, and after winding through a long narrow vale in the ridges of Othrys and Ceta, it falls into the Ægean Gulf. It was much celebrated by the ancient poets, Homer mentions it as belonging to the territory of the Phocians round the Maliac Gulf. Its bed and mouth have undergone one many changes from the deposit of alluvial matter. (Gell, *Itiner.*, p. 246.)

Highways of Thessaly.—The principal road was that which runs from Larissa to Thermopylæ, by Pharsalus, Thaumakia, and Lamia. From the same point another road branched off to the west, through Crannon, Pheræ, Demetrias, and along the shores of the Ægean and Maliac bays, terminating likewise at Thermopylæ. From Larissa again there was another route to the west, by the valley of the Peneus as far as Gomphi, the general name of which was from east to west. From Gomphi the chain of Pindus by the Pass of Clinovo to the west, to the Ægean coast and Nicopolis.

The islands connected with Thessaly are very few. They consist of a group lying off the Magnesian coast, and extending in a north-easterly direction towards Mount Athos, and the isle of Lemnos.

The plains of Thessaly, with the exception of those of the Thessalian mountains, were amongst the most fertile and productive of any in Greece, in wine, oil, and grain, but more especially in wheat, of which it exported a considerable quantity. The Thessalians consequently became very rich, and luxurious in their mode of life (*Athen.*, xii. 624); and so notorious for their intemperance, that they were charged with having invited the Persians to invade Greece, with a view of making them in sensuality and extravagance. Thessaly was so famous for its cavalry, the best in Greece: its supplies of such abundance of forage for horses.

The lands of Thessaly were not cultivated by the Thessalians themselves, but by a subject population, the Penestæ. The account given of them is, that they were the descendants of the Æolian Bœotians, who did not emigrate when their country was conquered by the Thessalians, but surrendered themselves to the conquerors on condition that they should remain in the country and cultivate the land for the new owners of the soil, paying, by way of rent, a portion of its produce. Many of them were richer than their lords. (Athenæus, vi., p. 264.) They sometimes accompanied their masters to battle, and fought on horseback as their knights or vassals. They formed a considerable portion of the population, and frequently attempted to emancipate themselves.

History of Thessaly.—The earliest information about the history of Thessaly is given by Homer (*Iliad*, ii. 710), who describes the country as divided into several independent principalities and kingdoms, and enumerates the chiefs to whom they were subject at the time of the Trojan war. This arrangement however was not of long continuance, and a new constitution, dating probably from that epoch, was adopted, as it would seem, by the common consent of the different states. They agreed to unite in one confederate body, under a president or Tagus, elected by the members of the confederacy. Strabo (ix. 429) informs us that this confederacy was the most considerable as well as the most ancient society of the kind established in Greece. Whether it was in any way connected with the Amphictyonic body cannot be determined with certainty, but it is deserving of remark that the majority of the Amphictyonic states were either Thessalian or in some way connected with Thessaly. It does not however seem that this confederation was productive of any great benefit to the country; for, except during a very short period, under Jason of Pheræ, Thessaly never assumed that rank among the states of Greece to which it was by its position and extent entitled. Many of the cities moreover were from time to time in the power of usurpers, or under the sway of powerful families, so that the nation had no means of acting as a body. One remarkable instance of this occurred at the time of the Persian war, when the Thessalian house of the Aleuadaæ, the princes of Larissa (Herodotus, vii. 6, calls them kings of Thessaly), either because they thought their power insecure, or with a view to increase it by becoming vassals of the Persian king, invited Xerxes to the conquest of Greece. That the Thessalian nation was in general opposed to their schemes appears from the fact that the Thessalians applied to the other states of Greece for assistance against Xerxes, and wished them, in conjunction with themselves, to oppose him at the Pass of Tempe. The confederate Greeks did not think it expedient to do this, believing it impossible to make any effectual resistance to the north of Thermopylæ; and the Thessalians, being left to their own resources, submitted to the invaders, to whom they proved active and zealous allies. A few years before this they had sustained a severe defeat from the Phocians, which aggravated the rancour of an old enmity. The Thessalians, who were eager to take vengeance for this defeat, availed themselves of their influence with Xerxes to direct his march through Phocis, and to stimulate his fury against the inhabitants (B.C. 480). After the Persian invasion, the Greek historians take little notice of the affairs of Thessaly, except on the occasion of the expedition undertaken by the Athenians for the purpose of reinstating Orestes, son of Echekratidas, a king of Thessaly, as Thucydides (i. 111) calls him, who had been banished from his country. The Athenian general Myronides marched on that occasion as far as Pharsalus; but he was checked in his progress by the Thessalians, who were superior in cavalry; and he was forced to retire, without having accomplished the objects of his expedition. In the Peloponnesian war the Thessalians did not as a nation take any part, though several of the towns were in favour of the Athenians, between whom and the Thessalians there was an old alliance. It would seem moreover that the bias of the nation was in favour of the Athenians, for Brasidas, the Spartan general, was obliged to march through Thessaly (B.C. 424) with secrecy and dispatch when traversing that country on his march towards Thrace. (Thucyd., iv. 78.) Not long afterwards, some troops which were sent out by the Lacedæmonians to reinforce their army in that quarter, were so vigorously opposed by the Thessalians,

that they were compelled to return home without having reached their destination. In B.C. 394 the Thessalians were in league with the Bœotians and their allies, who had formed a hostile confederacy against Sparta. The Spartans thought it necessary to recede from Asia their great commander Agesilaus, and on his way home he had to march through Thessaly. The Thessalians, with their cavalry, endeavoured to harass and obstruct him on his march. His skilful manœuvres however thwarted their designs, and Agesilaus gained considerable credit by defeating on their own ground, with horsemen of his own training, the most renowned cavalry of Greece. But while Sparta was struggling against the coalition of which Thebes was the head, Thessaly was assuming a new position among the states of Greece. To explain this we must observe, that though a kind of political and national unity was nominally acknowledged among the states of Thessaly, still the country had very seldom been united under one government. A few great families, such as the Scopadæ and the Aleuadæ, were sometimes able to extend their influence even beyond the cities of Larissa, Crannon, and Pharsalus, about which their possessions lay. Occasionally one of them was raised to the dignity of Tagus; but their power was always liable to be overthrown, even in their own cities. Towards the close and after the end of the Peloponnesian war, most of the cities acknowledged the ascendancy of Pharsalus or Pheræ, the latter of which was, about B.C. 400, under the dominion of Lycophron. This prince endeavoured to extend his power over all Thessaly; and Xenophon (*Hellen.*, ii. 4) mentions a victory which he gained over the Thessalians of Larissa as one of the events which happened in the year of the fall of Athens (B.C. 404); but he does not state what were the results of it. Ten years afterwards Lycophron was still engaged in a contest with Larissa, then subject to Medius, who was probably one of the Aleuadæ. Lycophron was supported by Sparta, and Medius by the Bœotian confederacy, by the assistance received from which he was enabled to make himself master of Pharsalus, then occupied by a Lacedæmonian garrison.

The success of Agesilaus on his return from Asia produced some change in the affairs of Thessaly, for Pharsalus soon recovered its independence, and rose to such eminence as to become a rival of Pheræ. It did not however continue, as of old, under the power of the Scopadæ: it was divided between contending factions, which, for the sake of peace, agreed to place themselves under the power of a person named Polydamas, whose character and virtue had gained the confidence of all parties. (*Thirlwall, Hist. of Greece*, vol. v., p. 56.) Polydamas was accordingly entrusted with the citadel and the administration of the revenues of the city, a trust which he discharged with the strictest integrity.

At Pheræ the supreme power passed into the hands of Jason, who was probably the son of Lycophron, and certainly the inheritor of his ambitious views, which however he enlarged into more comprehensive schemes, and, with superior energy and talents, possessed greater means of realizing. He kept a standing army of 6000 mercenaries, all picked men; and, notwithstanding the opposition of Pharsalus, he compelled most of the principal Thessalian cities to enter into alliance with him: moreover, his sway was acknowledged by several of the neighbouring tribes. The leading states of Greece were wasting their strength in a protracted warfare, and whichever way he turned his eyes he perceived, or imagined that he perceived, facilities for gaining the objects of his ambition, namely, the supremacy of Greece, and the overthrow of the Persian empire in the East; the same schemes in fact as were subsequently executed by Alexander, king of Macedon. The first objects which he had to gain were the title of Tagus, and the union of Thessaly under his authority. To accomplish the latter project it was necessary to gain by persuasion, or overpower by force, Polydamas, the governor of Pharsalus. Jason adopted the former method, and, after a frank statement of his views, prevailed upon Polydamas to second them. A compact was then made between them; and Polydamas exerted his influence so successfully in Jason's behalf, that the Pharsalians were induced to enter into an alliance with him, and to join in a general pacification, which immediately followed. Not long afterwards Jason was either elected Tagus, or assumed the title, without any opposition, and, by his influence and

talents, several important cities were induced to join confederacy. He then fixed the contingents of infantry and cavalry to be furnished by the different states, raised them to a greater amount than they had ever before. The army which he could bring into the field consisted of 8000 cavalry and more than 20,000 armed infantry; and his light troops, as Xenophon (*vi. 1, 6*) observes, were enough to oppose the war. For their maintenance he revived the tribute which had been imposed on the subject tribes of the Thessalians by Scopas, one of his predecessors. The extensive coasts of Thessaly, its forests of excellent ship-timber, and his large revenues, also enabled him to raise a considerable fleet, which he had no difficulty in manning from the Penestæ, or subject population of the country. His resources in fact were in every respect so great, that Thessaly seemed destined under him, to become both by sea and land the leading power of Greece, and even his projected conquest of Persia no longer impracticable. But these schemes were too vast for the ordinary duration of a human life, though he kept them constantly in view, and made all his actions subservient to them. An instance of this occurs in his conduct after the battle of Leuctra, in which the Thebans defeated the Lacedæmonians, and then invited him to join them in overpowering Lacedæmon. Jason joined them with his forces, but he did not comply with their request. His policy was to keep an even balance between the two states, so as to ensure the dependence of both on himself, and therefore, instead of annihilating the power of Sparta, he offered his services as a mediator between the contending states, and obtained a truce for the Lacedæmonians, under favour of which the remnant of their forces decamped by night (B.C. 371). In the following year Jason's career was terminated. He had made preparations for an expedition to the south of Greece, and had ordered a levy of troops, declaring at the same time his intention of marching to Delphi and presiding over the Pythian games: but before the time came he was assassinated by seven young men; and the honours which were paid in many of the Grecian cities to the assassin showed the alarm which his ambition had excited. The death of Jason, Thessaly relapsed into its former state of insignificance, though his dynasty survived him, and two of his brothers, Polydorus and Polyphron, for a short time shared his authority between them. Polydorus was soon assassinated, and Polyphron became sole Tagus. By his administration the office was changed into a tyranny, and he put to death Polydamas and eight other principal citizens of Pharsalus. After a reign of one year, he was murdered by his nephew Alexander, who thus gained the government, in which he became infamous for his cruelty. The atrocities which he committed filled all his subjects with terror, but especially the ancient families, who were likely to be the objects of his jealousy. The Aleuadæ of Larissa accordingly applied to Alexander, the then king of Macedon, who, on being thus invited by the Thessalians, complied with their request. He defeated the tyrant, and took possession of Larissa and its citadel, and afterwards of Crannon, and garrisoned both with his troops. The affairs of his own kingdom however obliged him to withdraw from Thessaly, and the Thessalians, being thus exposed to the vengeance of Alexander, solicited aid from the Thebans, who accordingly sent Pelopidas to assist them. The tyrant granted him an interview, which ended in Pelopidas settling the affairs of the country on an apparently firm footing. But the order which he had established was soon deranged by the conduct of Alexander; and the Thebans, on being applied to again, sent out Pelopidas with his friend Ismenias, but simply in the character of ambassadors, and without troops. They imprudently put themselves into the power of the tyrant, who threw them into prison. To rescue them and avenge the insult, Thebes sent out an army, which however was reduced to such a strait by his cavalry, that it was obliged to retreat, and but for the interference of Epaminondas, who accompanied it, though not as general, it would have been destroyed.

In the following year (B.C. 367) an army was again sent out under Epaminondas, through fear of whom the prisoners were released. Subsequently Alexander renewed his attacks on the liberty of the Thessalian cities, and greatly extended his dominion in the tributary districts. The Thessalians again appealed to the Thebans, and Pelopidas was sent out to aid them (B.C. 364), who fell in his

battle, in which however Alexander was defeated. The campaign ended in the tyrant being obliged to resign his conquests, withdraw his troops from Phthiotis and Magnesia, and enter into alliance with Thebes. Still Alexander not cease to be an object of hatred and dread to his subjects and foreigners, by his cruelties and piracies, and at his wife Thebe conspired with her three half-brothers to murder him. (B.C. 359.) They effected their purpose, and of them, Tisiphonus, under the direction and with the sanction of Thebe, assumed the government. But his reign lasted a very short time: for towards the end of B.C. 356 we find Lycophron, another of the brothers, at the head of affairs. The new dynasty however seems to have been as unpopular with the Thessalians as the old one, and accordingly, with the Aleuadæ at their head, they applied to Philip, king of Macedonia, and requested his assistance. Lycophron applied to his allies, the Phocians, the antient enemies of the Thessalians, at that time under the command of Onomarchus. Philip invaded Thessaly, and, after gaining some success, was obliged to retire; but he shortly afterwards returned at the head of a large army, and made himself master of the whole country, Lycophron withdrawing to Phocis. Philip wished to be considered as a monarch; and accordingly he restored popular government at Pheræ (Diodorus, xvi. 38), though he kept possession of its port Pagasæ, and garrisoned Magnesia with his troops. The important services which he thus rendered to the Thessalians secured their attachment to his interests, and, in addition to this, afforded him the opportunity of gaining a strong footing in the country, of which he did not fail to avail himself. It would appear however from Thirlwall, *Hist. of Greece*, vol. vi., p. 12 that about B.C. 356, either the tyrants of Pheræ or their party there had invaded their ascendancy, and Philip was again invited to dislodge them. This he effected with ease, and then availed himself of the opportunity to make Thessaly entirely subservient to his interests, and in fact to render it really a province of Macedonia. After expelling the tyrants, he garrisoned the citadel of Pheræ with his own troops, to prevent, as he gave it out, any chance of their restoration to power. He also strengthened his own authority by effecting what was professedly a return to the antient order of things in Thessaly. This consisted in the revival of the tetradarchies as political divisions of the country, for though this antient division into four districts still subsisted, it had long been rather a geographical than a political arrangement. At the head of these governments he placed his devoted adherents, the chiefs of the Aleuad party, so that they were in reality his proxies or deputies. The result is described by Demosthenes (*Olynth.*, i. 23) as amounting to a total subjection of the land to Philip, whom it supplied with excellent and numerous troops; besides which, he not only received the public duties and customs of the country, but also appropriated to himself the tribute which had always been paid to Larissa by her subject Perrhæbian cantons. (Strabo, p. 440.) On his death the states of Thessaly passed a decree confirming to his son Alexander the supreme station which Philip had held in their councils, and also notified their intention of supporting his claim to the office of commander-in-chief of the whole Grecian confederacy. Immediately after the death of Alexander (B.C. 336), a confederacy was formed against the Macedonians by the Athenians and other states of Greece, which the Thessalians were induced to join. Antipater, the viceroy of Macedonia, was unable to raise an army sufficiently large to cope with the confederacy, and after a battle, in which some Thessalians deserted him and caused his defeat, he retired to Lamia, a town of Thessaly, where he was besieged for some time by Leosthenes, the Athenian general. The siege was however raised by Leonnatus, an eminent Macedonian general, and some additional reinforcement under Craterus enabled him to bring to a successful issue what was called the Lamian war, in which the Thessalians took a very prominent part, and which early proved fatal to the Macedonian influence not only in Thessaly, but over the whole continent of Greece. Thessaly was thus preserved to the Macedonian crown till the reign of Philip, son of Demetrius, from whom it was taken by the Romans after the battle of Cynoscephalæ (B.C. 197). All Thessaly was then declared free (Liv., xiii. 32) by a decree of the Roman senate and people, and from that time it may be considered as under the

dominion of Rome, though its possession was disputed by Antiochus (Liv., xxxvi. 9), and again by Perseus, son of Philip, between whom and the Romans it was the arena of more than one conflict. It was already a Roman province when the fate of the empire of the universe was decided by the battle between Pompey and Cæsar on the plains of Pharsalus.

The slave-merchants of Greece were generally Thessalians. (Aristophanes, *Plutus*, 517.) Their chief slave-market was Pagasæ, the port of Pheræ.

(Clarke, Dodwell, and Gell's *Travels*; Leake's *Travels in Northern Greece*; Thirlwall, *History of Greece*; Cramer, *Antient Greece*, vol. iii., p. 343; Wachsmuth, *Hellenische Alterthumskunde*, vol. i., p. 65.)

THETFORD, a small parliamentary borough, partly in the hundred of Grimshoe, in the county of Norfolk, partly in Lackford hundred, in the county of Suffolk, 88 miles from London by the Norwich mail-road through Woodford, Epping, Bishop Stortford, Newmarket, and Bury St. Edmunds; and 30 miles from Norwich by Attleburgh. It has been confidently asserted that Thetford existed in the time of the Romans, or even antecedent to their arrival; but it cannot be identified with any of their towns that have been mentioned in antient records. Plot and Blomefield attempted to fix here the Sitomagus of the 'Antonine Itinerary'; others have proposed to fix here the Iciani of the 'Itinerary,' but without any solid ground for their opinion. The Ikeneld or Icknield Street or Way, and a road called the Peddar or Ieddar Way, crossed the Little Ouse above Thetford, but not very near it. Blomefield describes some traces of fortifications as existing in his time, but it is not clear that they were Roman. Some coins of the earlier emperors, from Claudius to Antoninus Pius, have been found. Under the East Angles it was a place of importance: a synod was held here A.D. 669. When the Danes invaded England in the reign of Ethelred I., they fixed their head-quarters, A.D. 870, at Thetford (called in the Saxon Chronicle, Theotford, Theotford, and Theotforda; and by other old writers Tedford and Thedford), which they sacked; and it is likely that the battle in which they defeated Edmund, king of the East Angles, was fought not far off. There appears to have been an abbey near the town at an early period, for king Edred, the grandson of Alfred the Great (A.D. 952), 'ordered a great slaughter to be made in the town of Theotforda, in revenge of the abbot, whom they had formerly slain.' (*Saxon Chronicle*; Florence of Worcester.) In the reign of Ethelred II. the town was burnt by the Danes (A.D. 1004) under Sweyne, but on their return to their ships they were intercepted by the Anglo-Saxons under Ulfkytel, and did not make good their retreat without serious loss. They burnt the town again A.D. 1010. In A.D. 1075 the bishopric of the East Angles was transferred from North Elmham to Thetford, but remained there not twenty years, being transferred (A.D. 1094) to Norwich. At this time Thetford was a town of considerable size and importance; it was a burgh with 944 burgesses in the time of Edward the Confessor; but at the time of the Domesday Survey there were only 720 burgesses, 224 houses being uninhabited. It gave name to the hundred in which it stood. After the removal of the bishopric to Norwich, or perhaps before, a Cluniac priory was founded here, the revenues of which at the dissolution were 418*l.* 6*s.* 3*d.* gross, or 312*l.* 14*s.* 4*d.* clear. There was also a house of canons, which was afterwards a nunnery, a Dominican friary, and several smaller religious houses or hospitals. Thetford was the seat of one of the suffragan bishoprics established by Henry VIII. There have been as many as twenty churches; thirteen are mentioned in Domesday.

The borough of Thetford, according to the Population Returns for 1831, comprehends three parishes, with an area of 8270 acres, and a population of 3462. The parishes of St. Cuthbert and St. Mary are very much intermingled, and are partly in Suffolk and partly in Norfolk: the whole of the other parish (St. Peter) is in Norfolk. The town is chiefly on the north-east or Norfolk bank of the Little Ouse; a smaller part is on the opposite or Suffolk bank. The town is irregularly built, and is neither paved, watched, nor lighted, but has a neat and clean appearance. It has no manufactures, but there is a good deal of malting, and the trade of the place is favoured by the river being navigable up to the town, by means of which an export of agricultural produce and

an import of coal are carried on. St. Peter's church consists of a nave with two aisles, chancel, and tower; the last rebuilt A.D. 1789. The antient part is built chiefly of flint, whence it has obtained the name of 'the black church.' St. Cuthbert's church is of ordinary structure: it has an embattled tower. Both these churches are in Norfolk. St. Mary's is on the Suffolk side of the river, and is meanly built. There are meeting-houses for Wesleyans, Independents, and Quakers; and a Roman Catholic chapel. Considerable remains of the Clunian priory, especially the antient gateway, still exist on the north-west side of the town. There are also some considerable remains of the nunnery, comprehending the chapel and the ruins of some other parts, at what is called Thetford-place Farm, on the Suffolk side of the river, south of the town; and some relics of other religious structures of the middle ages. The grammar-school is an antient building.

The borough, as we have seen, is as old as the time of Edward the Confessor: under the Municipal Reform Act it has four aldermen and twelve councillors, but is not to have a commission of the peace, except on petition and grant. It first sent members to parliament in the time of Edward VI., and still returns two: the borough limits were not altered by the Boundary Act. There were 156 voters in 1835-6, and 160 in 1839-40.

The livings of St. Mary and St. Peter are rectories, of the clear yearly value of £37. and 55*l.* respectively; that of St. Cuthbert is a perpetual curacy, of the clear yearly value of 50*l.*: all are in the rural deanery of Thetford, and the archdeaconry and diocese of Norwich. There were in the borough in 1833, thirteen day-schools, with from 357 to 367 scholars, namely, 123 boys, 69 to 79 girls, and 165 children of sex not stated; and three Sunday-schools, with 393 scholars, namely, 180 boys and 213 girls.

(Blomefield's *History of Norfolk*; Martin's *History of Thetford*; *Parliamentary Papers*.)

THETIS, Mr. Sowerby's name for a genus of fossil shells, said to resemble *Mastra*, but not to have the internal ligament. It is described as having several small acuminate teeth, but no lateral teeth; so that it in some degree resembles *Tellina* without the posterior plication.

THÉVENOT, MELCHISEDEC, is said by all his biographers to have died at the age of 71; and as his death happened in 1692, this places his birth in the year 1621. An entry in the printed catalogue of Thévenot's library informs us that he was uncle of the traveller Jean Thévenot, but beyond this we know nothing of his family or circumstances. It is probable however, from the respectable missions to which he was appointed at an early age, from the large library he collected, and from his being able to devote himself to literary pursuits while apparently in the receipt of no pension, that his family was wealthy and well connected.

It is stated that in his youth he visited several countries of Europe, but the earliest incidents of his life concerning which we have positive and authentic accounts are those mentioned in the brief autobiographical sketch prefixed to the printed catalogue of his library. He tells us that on his return from travelling in 1647, he was nominated resident at Genoa, but that the troubles of the Fronde interfering to prevent his taking possession of the post, he continued to follow the court till 1652. He was then sent to Rome, where he continued nearly three years; and being there at the commencement of the conclave which elected Alexander VII., the royal instructions respecting the part France intended to take on that occasion were addressed to him till the time of M. de Lionne's arrival. Thévenot alludes in mysterious phrase to a delicate and dangerous commission with which he was intrusted after the termination of the conclave, which he says he discharged to the perfect satisfaction of Mazarin and the other ministers. He attended Mazarin during the campaign in Flanders, 1655.

On his return to Paris, Thévenot devoted himself entirely to study. Frenicle, a mathematician, and Stenon, a naturalist, resided with him; and in the house adjoining his own he entertained a person to conduct chemical experiments. The meetings of scientific men which had been held in the houses of Père Mersenne and Montmort were transferred to Thévenot's mansion. The expenses thus incurred proved too heavy for his means, and he proposed to Colbert the establishment of a public and permanent association of scientific men under the patronage of

the king. The suggestion accorded with the minister's inclinations, and a grand academy was projected, intended to embrace every branch of knowledge. The king's library was to be the place of meeting: the historians were to assemble there on the Mondays and Thursdays of every week; the amateurs of the belles-lettres on the Tuesdays and Fridays; the mathematicians and natural philosophers on the Wednesdays and Saturdays; and general assemblies of all the three classes were to be held on the first Thursday of every month. The historical class was allowed to drop, it being feared that its inquiries might occasion dangerous discussions: the Académie Française, instituted by Richelieu, remonstrated against the foundation of another literary academy; and the only part of Colbert's plan that was realised was the 'Académie des Sciences,' which commenced operations in the month of June, 1666. Thévenot did not become a member of the Academy till 1685.

He had in the mean time however been diligently prosecuting his favourite studies. 'Each of our company,' he says, 'had his task and occupation: mine was to collect and publish in French whatever useful arts were practised among other nations. About this time I invented an ar-level, of which I caused the description to be printed, and it is now acknowledged to be the most accurate that has yet been tried. To render geography more perfect, I collected and published three large volumes of a collection of voyages, upon which I had been working for some time I had the honour to present them to the king, who examined them for nearly half an hour, and, after asking several questions, commanded me to continue the work. M. Colbert informed me that he had his majesty's orders to furnish me with everything necessary to carry out the design.' This distribution of tasks took place about 1680, before the Academy had received its definitive constitution. The first volume of Thévenot's Voyages was published at Paris, in 1662. The author's preface announces a translation of the Voyages and Travels published Hakluyt and Purchas, with the addition of relations from the Oriental languages. The second volume appeared in 1664: the preface intimates that for the of the numerous trading companies that have of late been formed in the kingdom, he has added an account of the present state of the Indies, noting the principal commercial establishments and places of resort of the Dutch and Portuguese; a report from one of the factors of the Dutch East India Company to the directors; and an extract of a letter from the governor-general of the East India Company of France. The third volume was published in 1666, and the fourth in 1672. In the preface to the fourth volume Thévenot informs the reader that the constant discovery of travels which had escaped his research has obliged him to abandon the attempt to classify the voyages inserted in his collection, so that all relating to one quarter of the world should appear together. These four volumes were in folio; and during the remainder of his life Thévenot published in the same form a number of separate accounts of voyages, which, together with some left half printed at his death, were bulky enough to form a fifth volume. The edition of his collection printed after his death at Paris, in 1696, professes to contain all these miscellanea, but a complete copy is rarely to be met with. In 1683 Thévenot published a small book in 12mo., entitled 'Recueil de Voyages de M. Thévenot.' It contains 'A Discourse on the Art of Navigation, with some Problems which may supply in part the deficiencies of this useful art.' Among these problems he has inserted an account of the level above alluded to. The same volume contains an account of the museum of Swammerdam, with some memoirs by that naturalist, said on the special title-page to be 'Extracted, together with the travels which precede it, from the Transactions of the Society which met at the house of M. Thévenot.' It will be advisable to consult the narrative of Thévenot's life before attempting to pronounce judgment on the merits of his publications.

Colbert died in 1683, and Louvois succeeding to the office of superintendent of buildings, succeeded likewise to the management of the royal library, which was regarded as belonging to that minister's department. Louvois appointed his son, afterwards known as the Abbé Louvois, who was then only nine years of age, librarian. It was necessary to find a deputy for so juvenile an officer: the Abbé Varés was first appointed, but he dying in Septem-

4, the office was conferred upon Thévenot, on the understanding that such of his books as were not already in the royal library were to be purchased for it. The zeal Colbert had manifested at the outset of his ministerial office for the augmentation of the royal collection had for some years before his death: from 1673 till his death, important acquisitions had been made. Thévenot's library extremely deficient in English, German, French, and works, and he obtained permission to make arrangements for procuring from those countries their histories, laws, and accounts of their customs; in short, every thing calculated to convey information regarding governments and transactions. The inquiry after MSS. in the Levant, begun by Colbert, continued by Louvois; and Thévenot, by that minister's directions, prepared and transmitted instructions to Girardin and Galland and the Père Beulier for the prosecution of the search. It was also at his suggestion that the Emperor, who had brought some Chinese books to France, was induced to visit Paris, and his books acquired for the king's library. On the death of Louvois a new arrangement was made for the management of the king's library, and about the same time Thévenot resigned his office from his appointment. There is reason to believe that he had given satisfaction as librarian: the notice of his life found in his own writing in the memoirs of his life, has very much the appearance of a defensive statement of his own merits. He did not long survive the termination of his office with the king's library: he died on the 29th of 1692.

Thévenot, in addition to most European languages, was conversant in Hebrew, Syriac, Arabic, Turkish, and Persian. He commenced a series of observations on the variation of the magnetic needle in 1663, and prosecuted them with perseverance till 1681. He suggested, in 1669, the invention of several degrees of the meridian along the coast of Bothnia: he invented his air level about 1660, and recommended its adoption to facilitate observations of the height of mountains at sea, and he endeavoured to discover a natural linear measurement for all nations. He possessed rather the taste than the talent for strict scientific observation and reasoning, and this peculiarity was the cause of the greatest part of his anxiety to have men of science visit him, and of his eagerness to collect books, printed or in MS., such works being calculated to afford him which, without a capacity for severe labour, he could acquire knowledge. In books of travels he was particularly conversant, and his information regarding statistics, history, commerce, and the arts, and science; and he could relish all these subjects, and he could not task himself to master any one of them. He took to publish a systematic collection of voyages, and as the task best suited to his turn of mind; but he required more continuous effort than he was capable of, and the fourth volume the systematic arrangement was not published, and only some fragments of the fifth part were published at long intervals. Thévenot was one of those men who promote science by imparting a contagious spirit of inquiry to others more than by anything they accomplish themselves. His taste for collecting books has been the cause of supplying the king's library at Paris with some of the most valuable MSS., some of which have yet remained unaccounted for. His collection of voyages too, was the means of preserving some curious and valuable MSS. If he did not make a good practical use of his knowledge, he at least pointed out the way in which the science might be rendered more complete; and besides his collection of materials for geographers to work upon, he directed attention to the means of rendering the science more perfect. Some of his suggestions mentioned above, and without their influence in promoting the application of mathematics and astronomy to geographical science; and he was the first, by directing attention to the communication between the Caspian and China, to open a literature of China, to commence that series of investigations which has been so brilliantly carried on by the Jesuits of the seventeenth, and by the Remusat and others of the past and present century.

From which this sketch has been compiled:—

1, 'Mémoire sur la Collection des grands et petits Voyages, et sur la Collection des Voyages de Melchisedec Thévenot,' par A. G. Camus, Paris, 1802, 4to. Owing to the incomplete condition of most copies of Thévenot's collection, this work is necessary to enable the reader to know what he has published. 2, 'Bibliotheca Thevenotiana sive Catalogus Impressorum et Manuscriptorum Librorum Bibliothecae viri clarissimi D. Melchisedecis Thevenot, Lutetiae Parisiorum, 1694, 12mo. This volume contains the autobiographical sketch above referred to: the catalogue of Thévenot's library throws light upon his studies. 3, 'Recueil de Voyages de M. Thévenot,' Paris, 1681. This volume contains the discourse on navigation, in which there are some incidental notices of Thévenot's pursuits. 4, 'Relations de divers Voyages curieux qui n'ont point été publiées ou qui ont été traduites de Hakluyt,' &c., Paris, 1663-1672. The 'Avis' prefixed to the different volumes of this edition contain matter for the biography of Thévenot. 5, 'Histoire de l'Académie des Sciences,' Tome i. contains a corroboration of Thévenot's assertions regarding his share in the institution of the Académie des Sciences. 6, 'Catalogue des Livres Imprimez de la Bibliothèque du Roi: Théologie, première partie,' à Paris, 1739: supplies the dates of Thévenot's appointment as librarian, and of his demission of the office. 7, Le Long et Fontette; 'Bibliothèque Historique de la France,' iv. 66.

THEVENOT, JEAN, was born at Paris the 7th of June, 1633. In the dedication of the first volume of his travels to his mother, he attributes to her exclusively the great care bestowed upon his education; and from this circumstance it may be inferred that his father died while he was a child. Thévenot distinguished himself as a student at the college of Navarre. The author of the sketch of his life, prefixed to the second volume of his travels, states that his attainments in the languages, physics, geometry, astronomy, and all the mathematical sciences, were respectable, and that he had studied with particular attention the philosophy of Descartes. But it is doubtful whether all these are to be understood as having been his college studies.

He left the college of Navarre before he had completed his eighteenth year. Possessing an independent fortune, his attention was for some time afterwards engrossed by the many exercises which were then deemed indispensable accomplishments in a gentleman; but having contracted a taste for reading books of travels, he caught the contagious spirit of adventure, and commenced travelling himself in 1652. He visited in succession England, Holland, Germany, and Italy; and, making a prolonged stay at Rome (1654-55), witnessed the solemnities of the installation of Alexander VII. He had taken the pains to prepare an account of his observations during this tour, but judiciously resisted all persuasions to publish it, partly on account of his youth and partly on account of the want of novelty in the subject.

At Rome he became acquainted with the celebrated Orientalist d'Herbelot, who, being a good many years his senior, and already distinguished for his learning, acquired considerable influence over him. D'Herbelot freely communicated to his young friend the information he had collected regarding the East and its inhabitants, and the result of their conversations was that Thévenot determined to devote himself to exploring Asia. D'Herbelot proposed at one time to accompany him, but being prevented by some family matters, Thévenot set out alone.

Thévenot began his first journey from Malta on the 1st of November, 1655: he arrived at Leghorn, on his return, on the 8th of April, 1659. Having reached Constantinople in the beginning of December, 1655, he remained there till the end of August, 1666. Travelling through Brusa and Smyrna, and visiting Chio, Samos, and Rhodes, he arrived at Alexandria on the 29th of December. He proceeded without loss of time to Cairo, which he made his head-quarters for two years, making in the course of that time two excursions, the first to Suez and Mount Sinai, the other to Jerusalem and some of the adjoining districts of Syria. During his stay at Constantinople and Cairo he made himself master of the Turkish and Arabic languages. On his way from Egypt to Italy he touched at Tunis.

From Leghorn Thévenot visited several parts of Italy which he had not previously seen, and in particular resided for a short time at the court of Savoy, before he returned to France. The first volume of his travels, he says, was

prepared for the press to gratify his friends, and especially his mother; and these were not with him mere words of course, for he was more intent upon travelling and observing than publishing. Before his book had passed through the press, and without giving his friends any warning of his intention, he left Paris to renew his researches in the East, and sailed from Marseille on the 6th of November, 1663.

This time his object was to visit Persia and the Indies. He arrived at Alexandria on the 4th of February, 1664: from Alexandria he sailed in a few days to Sidon; and from Sidon he visited Damascus. After a stay of twenty-four days in that city he went to Aleppo, where he remained two months; and then, travelling by Bir and Orfa to Mosul, descended the Tigris to Bagdad. From Bagdad he travelled to Ispahan by the way of Hamadan. Having remained five months at Ispahan, he left it, in company with Tavernier, for Schiraz and Gombroon, intending to sail for India from that port, but the jealousy of the Dutch agents obliged him to return to Schiraz. After examining the ruins of Tahelminar (Persepolis) he proceeded to Basrah, and embarked at that port for Surat, where he arrived on the 12th of January, 1666. Surat continued his head-quarters till February, 1667, during which time he made excursions to Guzerat, the court of the Mogul, and to the Deccan. On his return to Persia he spent five months at Ispahan. He had several attacks of illness in India, and having been wounded by the accidental discharge of one of his own pistols at Gombroon, his cure was tedious. His constitution was probably undermined; for, attacked by fever on his way from Ispahan to Tabriz, he died at Miana, on the 28th of November, 1667. During this journey he had acquired a knowledge of the Persian language.

The narrative of Thévenot's first journey to the East was prepared for the press by himself, but was not published till after his departure from Persia. The account of his travels in Persia, and that of his travels in India, were published (the former in 1674, the latter in 1684) by an editor who is called, in the 'Privilège du Roi,' the Sieur Luisandre, and who states that he was Thévenot's executor, and employs expressions which would lead us to believe that he had married the traveller's mother. The editing of these two volumes has been respectably performed.

Thévenot possessed a natural talent for observation, and the power of expressing himself accurately and unaffectedly. Nothing of importance appears to have escaped his notice: his manner of telling his story impresses the reader with a confidence in his good faith, and his statements have been corroborated on many material points. His mastery of the Turkish, Arabic, and Persian languages gave him an advantage that scarcely any other Oriental traveller of his day possessed. His practice of residing for some time in the principal towns of the countries he visited familiarised him with the customs of the natives. His descriptions of external objects are distinct, and his routes accurate. He had collected a *Hortus Siccus* in India, and had laid beside each specimen an account of the habitat and characteristics of the plant, along with its name in the Portuguese, Persian, Malabar, and (what his biographer terms) the Indian and Banian languages. This collection came into the possession of Melchisedec Thévenot, and is mentioned in the printed catalogue of his library. Jean Thévenot had also made a collection of Persian and Arabic manuscripts, of which Tavernier says the *cadi* of Miana kept the best to himself. The matured judgment, and talent for observation and description, displayed in Thévenot's works, are astonishing in one who had been a wanderer from his twentieth year, and who died in his thirty-fourth. His travels, originally published in three volumes, in quarto, which appeared respectively in 1665, 1674, and 1684, were reprinted at Amsterdam, in five duodecimo volumes, in 1689, and at the same place, in the same form, in 1705, 1725, and 1727. A Dutch translation of them was published in 1681, an English translation in 1687, and a German translation in 1693.

This sketch has been compiled from the account of Thévenot's life prefixed to the second volume of his travels, from the travels themselves, and from some incidental notices in Tavernier.

THEW, ROBERT, was the son of an innkeeper in the small town of Patrington, in the East Riding of Yorkshire,

where he was born, in the year 1758. E neglected, and at a suitable age he was bound up to a cooper. After the expiration of his apprenticeship he continued for a time to work at the business to which he was brought up; and Chalmers states that, during the American war of independence, he served as a private in the Northumberland militia. According to the 'Gentleman's Magazine,' his attention was first directed to engraving about the age of twenty-six; when, it is stated, he happened to see an engraver at work, and although he had never practised drawing, he procured a copper-plate, and engraved an old woman's head, from a picture by (Douw, with such extraordinary skill that he was, on the recommendation of Charles Fox, the Duchess of Devonshire, and Lady Duncannon, appointed historical engraver to the Prince of Wales. Whatever foundation there may be for this story, it must be received with some allowance, because a considerable degree of mechanical dexterity is indispensable for the production of a good copper-plate engraving. A more probable account is that about 1783 he settled at Hull, and became an engraver of shop-bills, cards, &c. Chalmers states that he engraved and published a plan of Hull, which is dated May 6, 1784; and that shortly afterwards he solicited subscriptions for two views of the dock at that place. The latter are large aquatint prints, drawn and engraved by Thew, with the assistance of F. Jukes in the aquatinting department; and they were published in London by Thew himself, in May, 1786. Copies of them are preserved in the collection of George III., now in the British Museum. In 1788 Thew was introduced to Alderman Boydell by the marquis of Carmarthen (afterwards duke of Leeds), whose patronage he had obtained by the construction of a camera-obscura on a new principle; and Boydell immediately commissioned him to engrave Northcote's picture of the interview between the young princes, from 'Richard III., act iii., sc. 1. This plate was published in 1791, at which time Thew held the appointment above alluded to, of engraver to the Prince of Wales. He subsequently engraved eighteen other plates for the Shakspere Gallery, and part of a nineteenth. Several of these are among the best in the collection, and display a high degree of mechanical skill, as well as an unusual amount of spirit and expression. That of Cardinal Wolsey entering Leicester Abbey ('Henry VIII., act iv., sc. 2), from a picture by Westall, is particularly and deservedly celebrated as a fine specimen of the style known among artists as stipple engraving; and in consequence of its superior beauty, proof-impressions of it were, according to the 'Gentleman's Magazine,' charged double the price of any other in the whole work. Thew died in July, 1802, at Stevenage (or Roxley, according to the 'Gentleman's Magazine') in Hertfordshire. *Gent. Mag.*, Oct., 1802, p. 971; Chalmers's *Biog. Dict.*

THIA, Dr. Leach's name for a genus of crustaceans, placed by M. Milne Edwards under the tribe *Coryseta*, in the family *Oxytomes*.

Generic Character.—*Carapace* nearly cordiform, a good deal narrowed behind; its upper surface very smooth, and nearly horizontal from before backwards, but much curved transversely, and presenting no distinct regions. *Front* wide, lamellar, and rather advanced; the lateral borders of the carapace delicate and arched. *Orbits* very small. *Internal antennæ* bent transversely under the front; *external antennæ* inserted in the gap which separates the front from the floor of the orbit, large and strongly ciliated. *Disposition of the buccal apparatus* nearly the same as in *Atelecyclus*, a genus which immediately precedes it in the arrangement of M. Milne Edwards. *Third joint of the external jaw-feet* advancing to the base of the internal antennæ, but much less elongated, and giving insertion to the succeeding joint by a large notch at its internal angle. *Sternal plastron* very narrow. *Anterior feet* short and compressed, but less than in *Atelecyclus*; the succeeding feet still shorter, and terminated by a straight and very sharp point. *Abdomen* nearly of the same form in both sexes; only that of the male is rather narrower, and the three joints which precede the last are ankylosed together. (M. E.)

Habits of the Genus.—*Thia* lives buried in the sand at a small distance from the shore. M. Milne Edwards states that but one species is known with any certainty, namely—

Thia polita.—Colour rosy; length ten lines; localities the British Channel and the Mediterranean.

Edwards remarks that the aspect of these crustaceans is very peculiar, and approximates them to the *Anurous* section. In other respects, they obey bear a strong analogy to *Atelecyclus*, and, as that genus, establish a passage between the *Oxy-* and the *Cancerians*.



Thia polita.

N SHAN MOUNTAINS. [SONGARIA.]

N SHAN NANLU is the name of a Chinese govt situated nearly in the centre of Asia. European writers generally call it Eastern or Chinese Turkistan, Little Bucharia. The name of Turkistan is applied because the bulk of the inhabitants in that part is composed of Turkish tribes; and as these tribes are generally designated by the collective name of Buharians from the town of Bokhara, Eastern Turkistan is called Little Bucharia, or rather Bokharia, to distinguish it from Western or Proper Turkistan, which is called without any epithet. Thian Shan Nanlu, in Chinese signifies the 'southern road of the Thian Shan Mountains,' and has been applied to the countries south of the Thian Shan system, because they are traversed by the two of the two great commercial roads which connect the Thian Shan with the countries of Western Asia, whilst the northern road of the Thian Shan are traversed by the commercial road, and on that account are called Thian Shan Pelu, 'the northern road of the Thian Shan.' The mentioned countries constitute the government of Songaria. They have been described under Songaria.

Shan Nanlu lies between 36° and 44° N. lat., and from 71° to 96° E. long. From west to east it extends 1250 miles, and its width from north to south between 550 and 300 miles. Its area probably exceeds 3,000,000 square miles, so that it is ten times as large as Great Britain, and twice and a half as large as France.

It is mostly surrounded by countries belonging to the Chinese empire: on the north is Songaria, or Thian Shan, east the province of Kansu, and south Tibet. The western side is enclosed by countries independent of China. On the south-west is Ladakh, on the west including Badakshan and Bokhara, and on the east the Khokan. The three last-mentioned countries are in Western Turkistan, or Great Bucharia.

Shan Nanlu is a country entirely isolated from the rest of the world. On the north, west, and south it is enclosed by mountain-ranges of such extent and elevation, and in places which are permanently inhabited can only be reached by passing for several days over mountains, and is not inhabited except for two or three months in the year when they are visited by a few families of wandering tribes of mountaineers. On the east of Thian Shan is an extensive desert, which appears to be uninhabited. The country enclosed by the three ranges and does not receive an abundant supply of water from the mountains, a considerable portion of which is always covered with snow, and the numerous rivers which descend from the mountains form a large river, called the Tarim, which empties into the Danube, but which does not reach the sea; it terminates in an extensive lake situated on the eastern edge of the desert. The basin of the river is the largest closed river-basin on the globe, if the Caspian Sea and the rivers falling into it is included.

Mountains.—At the south-western angle of Thian Shan stands an extensive mountain-knot, called Push-tikhour, which occupies the space between 36° and 37° N. lat. and between 71° and 74° E. long. From its western

side issues that elevated chain which is known in Afghanistan by the name of Hindu Kush; from its northern edge another range, called the Tartashling, or Bolor Tagh, which extends northward; and in the eastern part there begins a third range, which traverses the whole of Central Asia, and extends through China Proper to the shores of the Pacific. This last-mentioned range is called by the Chinese Kuenlun, but that portion of it which is contiguous to the mountain-knot of Pushtikhour goes by the name of Thsungling.

The Thsungling may be considered as that portion of the Kuenlun range which extends from the Pushtikhour on the west (72° E. long.) to the mountain-pass of Karakorum on the east (between 76° and 77° E. long.), and occupies nearly the whole of the space between 35° and 37° N. lat. Very little is known of this mountain-region, which cannot surprise us, when we learn that, according to an intelligent Mohammedan traveller, an eternal mass of snow occurs in these parts, which occupies 200 cos (equal to more than 300 English miles) in length. An extraordinary phenomenon is stated to occur on the northern declivity of the mountains, where the Thsungling and Pushtikhour are contiguous—the continuance of rain for three successive months. That portion of the Kuenlun range which is east of the Pass of Karakorum is still less known. As far as the Keriya Pass (84° E. long.) its snow-covered summits lower towards the north with a moderate descent, and a hilly tract of moderate width extends along their base, which is fertilized by the rivers descending from the range; but east of the Keriya Pass no watercourses are found along the base, which leads to the supposition that the declivities of the mountains are extremely steep, and that they are in immediate contact with the sandy desert which extends north of them. Two roads traverse the Kuenlun range. The most western leads through the Karakorum Pass from Hindustan and Cashmir by the way of Leh in Ladakh, to Khoten in Thian Shan Nanlu. The road runs from Leh north-north-east over a mountain-chain, and descends to the valley of the river Shayuk, the course of which it follows upwards between the mountain-masses of the Kuenlun nearly to the source of the river. It passes by a narrow valley over the highest part of the mountains (between 36° and 36° 30'), and descends on the north into the valley of the river Misar, which is a tributary of the Tarim. In the narrow valley of the Misar the road runs to Khelasten (north of 37° N. lat.), where the mountains disappear, and cultivation begins to be general. This mountain-road certainly does not rise to such an elevation as those which traverse the Himalaya Mountains, for it is quite free from snow in summer, and, with the exception of the highest portion, it does not rise above the line of permanent vegetation, or even that of trees, as may be inferred from the fact that fire-wood and fodder for beasts of burthen are generally abundant, and permanent habitations are met with in the valleys of the Shayuk and Misar up to the immediate vicinity of the mountain-pass. The highest part of the pass probably does not exceed 12,000 feet above the sea-level. This road however is much more frequented in winter than in summer, because the melting of the snow on the mountains adjacent to the road renders travelling in summer almost impossible. We have no account of the eastern mountain-road that traverses the Kuenlun range. We only know that it connects the town of Lhasa in Tibet with Khoten in Thian Shan Nanlu, and that it traverses a very mountainous country of great extent, passing near the large lake of Tengri-Nor, and issuing from the mountains by the narrow valley in which the town of Keriya is built. From Keriya it runs north-west through a hilly country to Khoten.

The western districts of the Thian Shan Nanlu are occupied by several ranges, belonging to the Tartashling or Bolor Tagh. This mountain-system extends north of the mountain-knot of Pushtikhour, from 37° to near 41° N. lat., where it descends with long slopes towards the valley of the river Sihoon or Jaxartes. Its extent from south to north therefore does not much exceed 260 miles. It is difficult to determine its extent from east to west, as nearly the whole country from 69° to 74° between the upper courses of the Sihoon or Jaxartes and that of the Jihoon or Oxus, is almost entirely unknown, and appears to be occupied by widely-spread rocky masses of mountain-ranges, between which only narrow valleys occur, that are visited by the wandering tribes of the Kirghis only

during the summer. It does not appear that any of the sovereigns of the contiguous countries have extended their authority over this extensive mountain-region, or over any part of it, which may be considered as a certain proof that no portion of it is cultivated; and this supposition is supported by the fact, that it is not traversed by any commercial road, and that the two roads which connect Thian Shan Nanlu with Western Turkistan run along the southern and northern base of the Tartashling in the upper valleys of the two rivers Jihoon and Sihoon. We have some account of the mountains enclosing these valleys, which penetrate upwards of 200 miles into the mountain-region, but as these portions of the region are within Turkistan, they are noticed under that head. We shall only observe, that in the interior of the mountain-region, and within the boundary-line of Thian Shan Nanlu, an extensive elevated plain occurs, which is called the Table-land of Pamir. According to Marco Polo it takes ten days to traverse it from west to east; and, according to a Chinese traveller, it is 1000 li (equal to about 350 miles) long, and in some places 100 li (or 35 miles) wide, whilst in others it narrows to 10 li (or between 3 and 4 miles). The elevation of this table-land is so great, that no trees are found on it, and travellers feel their respiration rendered difficult by the rarefaction of the air. The nomadic Kirghis, who visit this elevated region in summer on account of its excellent pastures, keep herds of camels and sheep, and of kashgaw or yaks, which latter are to the Kirghis what the rein-deer is to the Laplander of Northern Europe, serving them as animals of burden, and supplying them with food. Their milk is richer than that of the common cow, but the quantity which the yak yields is less. The tail is the well-known chowry of Hindustan. On the table-land of Pamir its hair, which is clipped once a year in the spring, is made into ropes, which for strength do not yield to those manufactured of hemp. It is also woven into mats, and into a strong fabric which makes excellent riding-trowsers. Among the wild animals peculiar to this region are the kutch-kar and the rass. The kutch-kar, or wild sheep, attains the height of a two-year-old colt, and has two fine curling horns: it congregates in herds of several hundreds, and is hunted by the Kirghis for its hide and flesh. The rass is a different animal, having straight spiral horns; it is less numerous than the kutch-kar, but equally prized as food.

The Thian Shan range extends along the northern boundary-line of Thian Shan Nanlu, which is separated by it from the government of Ili. This mountain-range has been noticed under *SONGARIA*, vol. xxii., p. 242, where also the range is described which forms the southern border of the Sihoon river-basin, and connects the Thian Shan Mountains with the Tartashling range, and where also the road is mentioned which, leading over the Thian Shan Mountains, connects Thian Shan Nanlu with the government of Ili.

Rivers.—The largest supply of water is derived from the Tartashling, in which three of the great branches of the Tarim river rise. The principal branch originates within the mountain-region in a large lake, called Karakol, which is situated near 39° N. lat., and receives the drainage of a considerable country which surrounds it on all sides. The river issuing from this lake runs eastward, and is called Yaman-yar. It leaves the mountain-region below Tash-bahk, near 73° 30' E. long., and is soon afterwards joined from the north by the Kashgar Daria, which brings to it the drainage of the north-eastern part of the Tartashling. Near the point of confluence the rivers are met by a third river, which flows in a direction from east to west, and brings down the waters collected on the mountain-chain which unites the Tartashling to the Thian Shan. This river, which is called Kezyl Daria, runs about 200 miles. After the union of these three branches the river continues to be called Kashgar Daria, and to flow eastward for 300 miles, without receiving any supply of water, until, between 80° and 81° E. long., it is nearly at the same point joined from the north by the Aksu Daria, from the west by the Yarkiang Daria, and from the south by the Khotan Daria. The Aksu Daria brings down a large volume of water, collected on the southern declivity of the western portion of the Thian Shan, and runs about 200 miles. The sources of the Yarkiang Daria are near those of the Jihoon, or Oxus, south of 37° N. lat., and the upper course of the river is within the mountain-region of the

Tartashling, where it runs eastward, but it about 70 miles above the town of Yarl course. Its course in the plain is first north-east, below the town of Yarkiang nearly due east, and to the Kashgar Daria for nearly 200 miles. At 80° E. long. it turns northward, and soon afterwards joins the Kashgar Daria. Its course exceeds 400 miles; among its numerous tributaries is the Misar river, which brings down water derived from the northern declivity of the Thungling. The Khotan Daria collects its waters from the northern declivity of the Kuenluen range, east of 74° and west of 80° E. long., and runs more than 300 miles in a general north direction. In this river, and the mountains which are drained by its upper branches, the red-stone or oriental jasper is found, which is held in great esteem in China, and exported in large quantities: it is mostly bought by the court of Peking, as the wearing of this stone distinguishes the higher classes of the mandarins from the lower.

After the confluence of these several branches the river is called Tarim, or Tarim-gol, and continues to flow in a nearly due east direction for 400 miles more, when, near 88° E. long., it is lost in an extensive lake, Lop Nor, which is surrounded by still more extensive swamps. It appears that this lower part of its course is skirted by swamps, which extend to a considerable distance from its banks. The extent of Lop Nor from west to east is said to exceed 70 miles, but its width does not appear to be half these dimensions. No river joins the Tarim from the south, east of 81° E. long., but it receives a considerable supply of water from the Thian Shan Mountains, by two rivers, the Ukiat, or Chagar Daria, and the Barun Yulduz, or Kaidu River. The Ukiat Daria, which rises in that part of the Thian Mountains which encloses Lake Issukul on the eastern side of *SONGARIA*, runs more than 200 miles in a south-east direction, and joins the Tarim near 84° E. long.

Kaidu River is probably the largest of the contributors to the Tarim, as it collects the drainage of the Thian Mountains between 80° and 87° E. long. Its upper course about 100 miles is in an elevated valley, from which the Thian Shan range from east to west: issuing from this valley it turns abruptly to the east, and draining a parallel valley about 200 miles long by an eastern side it falls into a large lake, which is called Bostu Nor or Bostu-teng Lake, the dimensions of which are stated to be hardly inferior to those of Lop Nor. This lake is surrounded on the north and south by chains of high hills, but on the east by a sandy desert. In the hills which enclose the lake on the south is a break by which the Bostu Nor discharges its waters into the Tarim. The channel by which this is effected is also called Kaidu, and reaches the Tarim about 80 miles above its influx into Lop Nor. The extensive swamps surrounding Lop Nor seem to begin at the conflux of these two rivers. The whole course of the Tarim amounts, according to the estimate of Ritter, to nearly 1200 miles in a straight line, and if its windings are taken into account, and the Yarkiang Daria considered as its principal branch, it cannot fall short of 1500 miles. The upper parts of this river and its tributaries are probably too rapid for navigation, and the lower parts of most of the tributaries of the Tarim, and of this river itself, be through countries which are probably uninhabited. It is also probable that during the latter part of the summer and in autumn and winter, the quantity of water is very small, the rains being very scanty, and the whole supply of water being derived from the melting of the snow on the mountains on which its branches originate. But the water of all these branches is used for irrigation, though that of the Tarim itself is not.

The Plain is of great extent, measuring on an average more than 300 miles from north to south, and about 800 from west to east. Its elevation is not known; but considering the peculiarities of its climate and its productions, it is presumed that it can hardly be less than 2000 feet above the sea-level. The largest portion of it is quite unfit for cultivation, and cannot even be used as pasture-ground. This is especially the case with the eastern districts, which are a complete desert. This desert occupies the whole country east of 88° E. long., and surrounds the lakes of Lop Nor and Bostu Nor on the east. South of the river Tarim it extends westward to the banks of the Khotan Daria (81° E. lat.), so that it covers about one-half of the plain. The worst part is that which lies

, and is called Han-hai, or the Dry Sea: accord-
 ypothesis of the Chinese, it is the bed of a lake,
 dried up at some remote period. Its surface is
 ith a very fine sand, which is frequently raised
 by the wind, so that the traces of the caravans
 pear, except where they are marked by the
 ie beasts of burden which have perished in this
 ough which the nearest road leads from China
 1 Thian Shan Nanlu. It is however asserted
 are a few places, generally two days' journey
 nother, in which drinkable water is found by
 That part of the desert which lies west of 88°
 e Tarim river and the Kuenlun range, is called
 of Lop. Though equally unavailable for agri-
 as a pastoral country, the surface is in many
 ersified by large tracts of rocky and stony
 ich a few animals, as wild horses and wild
 id a scanty subsistence, and which are over-
 low shrubs. Water however is scarce, except
 ime. On the north, where it approaches the
 range, this vast extent of desert is skirted by
 act of hilly ground, which is fit for cultivation
 pasture-ground. Its width may vary between
 iles, and it is in many places abundantly watered
 hich descend from the mountains on the north,
 as soon as they have traversed the hilly region
 he sand of the Han-hai. Only a small portion
 can be irrigated, but it is cultivated with the
 . It produces rice, wheat, millet, and several
 egetables, especially pulse: it is famous all
 for its excellent fruits, especially pomegranates,
 aches, plums, but above all for its melons and
 ch are sent in large quantities to Peking. In
 es cotton is grown on a large scale. The
 t of this tract however is used as pasture-
 horses, camels, cattle, and sheep.
 erty west of 88° E. long., and between the Tarim
 the Thian Shan Mountains, contains a much
 on of cultivable ground, especially in the valleys
 in Yulduz, or Kaidu river. The upper valley,
 river runs from east to west, is probably very
 is mostly used as pasture-ground for cattle and
 uch thrive exceedingly well. The pure and
 f this valley is much commended. The lower
 ere the river flows from west to east, is more
 and a large portion of it is under cultivation,
 rice, wheat, millet, and sesamum, and contain-
 plantations of fruit-trees. The hills enclosing
 ise probably more than 1000 feet above their
 re used as pasture-ground. Along the base of
 n ridge of hills are also considerable tracts of
 land which are irrigated by the streams that
 m the hills, but at the distance of a few miles
 are lost in the sandy plain which extends along
 of the Tarim river.
 west, between 84° and 80° E. long., the hilly
 not so wide, extending only to the distance of
 iles from the Thian Shan Mountains. The hills
 as elevation, and yield only a scanty supply of
 igation. The country is only well cultivated in
 of the great mountain-chain, and grows more
 recedes from it, except along the banks of the
 ia, or Ukiat River, where cultivation extends to
 les from the Thian Shan. A large portion of it is
 re-ground, but in approaching the Tarim the
 occurs. Farther west (between 80° and 77°
 the valley of the Aksu Daria, which is enclosed
 ls, and in its upper part contains very extensive
 tile land, which are cultivated with great care.
 ce every kind of grain, especially wheat, millet,
 , lentils and beans, also cotton, melons, and
 ds of vegetables. The orchards yield peaches,
 ars, pomegranates, grapes, and mulberries, and
 stures feed herds of horses, sheep, camels, and
 e lower course of the Aksu Daria however lies
 e desert and the swamps, which extend along
 iver and along the lower course of its principal
 A few tracts are cultivated on the banks of the
 u Daria.
 lain, west of the Aksu Daria, which extends
 c Kashgar Daria and the Thian Shan Mountains,
 ed land seems to be almost entirely limited to
 of the Kezyl Daria, where considerable tracts

produce rice and other grain in abundance, as well as rich
 crops of cotton. The uplands, which are north of the
 river, have a stony and rocky soil, covered with a thin layer
 of earth, sufficient to produce abundance of grass during
 some parts of the year, and consequently they are used as
 pasture-grounds by the Kara Kirghis, or Black Kirghis,
 who go in summer with their herds of horses and camels
 to the Thian Shan Mountains. The uplands between the
 Kezyl Daria and the Kashgar Daria have a sandy soil,
 which for the greater part of the year is quite destitute of
 vegetation, and can only be used as pasture for a few weeks.

The western districts of the Thian Shan Nanlu, or those
 which extend at the base of the Tartashling, are not
 more favourable to cultivation than the northern districts
 which we have just noticed. Though the general direc-
 tion of the Tartashling is from north to south, it seems
 that the ranges which compose it generally extend in
 the direction from west to east, and their wide rocky
 masses advance far into the plain, leaving only narrow
 and elevated valleys between them, which do not admit of
 cultivation. These high ranges extend much farther to
 the east near the Kuenlun, than in the vicinity of the Thian
 Shan Mountains, and terminate rather abruptly in the
 plain, so that only a very narrow hilly tract separates them
 from the level country. Cultivation is limited to this
 narrow tract, and even here to the banks of the several
 rivers which drain it. The cultivated grounds are most
 extensive on the Kashgar Daria and Yarkiang Daria, where
 these rivers issue from the mountains, and always yield an
 abundant supply of water for irrigation, especially in the
 countries surrounding the towns of Kashgar and Yarkiang.
 Farther down the country is not cultivated, the soil being
 sandy, and the means of irrigation scanty and uncertain.
 The principal objects of agriculture are rice, wheat, barley,
 and millet, with beans and vetches. Several plants are
 raised from which oil is extracted, among which is
 sesamum. The mulberry plantations are very extensive,
 and large quantities of silk are collected at Yarkiang,
 which is partly exported, and partly used in the manu-
 factures of the country; cotton, hemp, and flax are also
 cultivated. Fruit-trees are abundant, and their produce,
 consisting of grapes, pomegranates, quinces, peaches,
 apricots, and apples, constitutes an article of internal
 commerce. Melons and cucumbers are of excellent
 quality. The greater part of the country, though unfit
 for agricultural purposes, is covered with grass, especially
 those tracts which are mountainous, and accordingly it
 abounds in domestic animals, among which the horses and
 sheep are distinguished. The wool collected in these
 parts is hardly inferior to that of which the shawls of
 Cashmir are made. There are also numerous herds of
 cattle and camels.

We are less acquainted with the productive powers of
 the countries which extend along the base of the Tsung-
 ling, where our knowledge is limited to the tracts that
 surround the town of Khotan, where a large district is
 under cultivation, and produces rice, wheat and millet,
 cotton, hemp and flax; large quantities of silk of the first
 quality are collected. The vineyards are extensive, and
 the grapes grown here are much prized. Some plants
 are raised, which yield dyeing-stuffs, which are exported to
 China. Among the domestic animals the yak is numerous,
 and also the horses and sheep; cattle are rather scarce.
 North of this cultivated tract is a desert, in which many
 bare rocks occur, but whose surface is mostly covered with
 sand. This desert, which extends westward to the vicinity
 of Yarkiang, and northward to the banks of the Yarkiang
 Daria, is known by the name of Kara-kitai or Rikistan.
 From this rapid survey of the productive powers of Thian
 Shan Nanlu it is evident that probably not more than one
 hundredth part of its surface is available for agricultural
 purposes. The deserts, and those tracts which are de-
 scribed as such, cover at least three-fourths of the area,
 and the remainder is mainly occupied with high mountains,
 which produce a few trees and good pasture. The utter
 sterility of the Han-hai seems to depend on the soil, but
 that of the other desert tracts appears partly to be the
 effect of climate.

Climate.—The climate of the Thian Shan Nanlu is dis-
 tinguished by that dryness which is characteristic of all
 table-lands which are considerably elevated above the
 sea. As its elevation perhaps does not differ much
 from that of the table-land of Castile in Spain, there

would probably be a great similarity between the climates if the table-land of Spain was not surrounded by a sea, which is not far distant from it, whilst the Thian Shan Nanlu is 1500 miles from the Pacific, which is the nearest sea. The climate of Thian Shan Nanlu is consequently much drier than that of Spain. Though abundant rains are experienced in the mountain-ranges which enclose the plain, and snow falls every winter to the depth of several feet, the quantity of snow and rain which descends on the plain is very small. In the deserts no rain occurs, and it is observed that when the atmosphere is charged with vapour, and distant objects are indistinctly visible, it does not produce any other effect than that of generating extremely heavy gales, which are often so strong as to throw down travellers and their beasts of burden. In the Han-hai they raise a large quantity of sand to a considerable height above the surface. Along the Thian Shan Mountains only two or three showers of rain are annually experienced, and generally they do not continue above an hour. The rain is very minute, and it hardly moistens the surface of the ground. A little snow falls in the western districts, but seems never to occur east of the valley of the Kaidu river. The moisture required for the growth of plants is therefore entirely derived from the mountains. The supply of water from this source is indeed very abundant, but only for about two or three months of the year, and it would only be sufficient for a very limited agriculture, if the inhabitants had not acquired a peculiar art in husbanding this supply. In the districts south of the Thian Shan Nanlu Mountains very large reservoirs have been made, which are filled by the watercourses after the melting of the snow, and from these reservoirs the greater part of the supply is taken, by which many tracts are enabled to produce abundant crops. The western districts do not materially differ from the northern, except that a larger quantity of snow falls, though it is moderate in the plain. The temperature of these districts however is much colder in winter, and it is a remarkable fact that at Yarkiang the river is for three months covered with thick ice, and caravans pass over it with their beasts of burden. The heat in summer is very great all over the country, but the cold of the winter seems to decrease as we proceed from west to east, as frost is hardly known at Hami. The Chinese however state that the difference between the temperature of the summer and winter is very considerable. The country is subject to earthquakes, and several districts suffered greatly from them in 1832, when they were felt on both sides of the Tartashling Mountains. It is probable that this phenomenon also occurs along the Thian Shan Mountains, as an extinct volcano exists in that range, and traces of volcanic action are frequently met with.

Productions.—It is remarkable that Thian Shan Nanlu, though without doubt considerably elevated above the sea-level, produces all the grains and fruits which are cultivated in the most southern parts of Europe, which are situated at the same distance from the equator, and are less elevated. The olive-tree however has not been noticed as growing there. Sesamum, which is cultivated in most parts to a great extent, supplies the place of the olive-tree. The plain, as well as the mountains which surround it, are almost entirely destitute of trees, and even of shrubs. In a few places only some species of trees cover a small extent of surface, but they are short and crooked, and only good for fire-wood. It is not certain, though it is so stated by some travellers, that the true rhubarb-plant grows on the mountains of the Tsungling.

All the domestic animals of Europe abound, with the exception of hogs, which are only kept by the few Chinese settled in the country; all the other inhabitants, being Mohammedans, hold this animal in abhorrence. Camels are kept in the plains and on the mountains. The ranges of the Tartashling are considered the native place of the double-humped camel. In the same mountains the yak is reared by the Kirghis; the larger species of the domestic animals are found in a wild state in the deserts of Thian Shan Nanlu. This is expressly stated of the horse, the camel, black cattle, and the ass; the last is probably the *dshikketei*, or *Equus hemionus* of Pallas; of the wild sheep there appear to be several kinds, but the species have not yet been ascertained. On the Thian Shan Mountains the argali is found, and on the Tartashling the kutch-kar and the *mass* above mentioned. The jackal is found in great

numbers, and there are also tigers, wolves, lynx, foxes. On account of the want of natural forest are not numerous, except water-fowl, which abounds in the lakes of the desert and the swamps of the plain. On the Thian Shan Mountains a black eagle of a species is met with, and on the Tartashling a still larger one called *syrym*.

Gold is said to be found in the affluents of the Daria, where some quantity is stated to be collected also, according to the account of the Chinese eastern portion of the Thian Shan Mountains, where ever it is not collected. Copper and iron are also found at several places, and are worked, but the mines are not known. From the volcanic portion of the Thian Shan Mountains sulphur and sal-ammoniac are obtained, and near the same places asbestos and saltpetre. Diamonds are said to exist in the eastern part of the last range. Several other precious stones are abundant, two of them, the yew and the agate, form common articles of commerce to China. The agate is abundant in the eastern districts of Thian Shan Nanlu.

Inhabitants.—The bulk of the population is of Chinese origin, and it seems that this nation must be derived as the aboriginal stock of the country, as Thian Shan Nanlu constituted the principal portion of the empire of the Hiongnu, which was destroyed by the Chinese in the first century after Christ, and as the of almost all the different Turkish tribes, however spread over Asia and Europe, may be derived from the country. Travellers generally call the people of Thian Shan Nanlu, Uzbeks, as they resemble exactly in the formation of their body (BOKHARA, p. 71), and speak the same language. It is however served, that the Turkish language of Thian Shan is not intermixed, as that of the other Turkish dialects derived from the Persian and Arabic, and it is therefore considered the purest of the dialects. The Memoirs of Sultan Baber state that the people in this language. The Turks of Thian Shan are decidedly superior in civilization to the people of Bokhara. They exhibit no less industry than the cultivation of the land, and the articles made in their manufactories are of good quality and prized. Many of them are also engaged in commerce.

They are at present divided into two tribes, Ak-Kara-tak, which hate one another, and frequently war on each other, which circumstance is the principal reason of their inability to resist the invasions of the Olöths and of the Chinese. Each of the two tribes was governed by hereditary chiefs, who were independent of one another. When the Chinese entered the country, they left the internal affairs in the hands of these chiefs, reserving for themselves only the department of the police, as far as regarded the neighbouring independent states. The army which they keep in the country, and which amounts to between 20,000 and 30,000 men, is commanded by Mantchou, and the places through which the caravan routes pass to foreign countries the custom-officers are composed of Chinese and half of Turks. But all the other offices are appointed by the Hakim Begs, as the chiefs are called, the Hakim Begs themselves are chosen or confirmed by the court of Peking. The tribute which the Chinese government levies upon the inhabitants is small, but is increased by the duty on the merchandise imported, and which, according to the latest information, amounts to 10 per cent. The inhabitants however are much oppressed by their native chiefs, as the Chinese government take no notice of the way in which they are governed. For this reason they are ill-disposed against the Chinese, and this hatred is still increased by the extensive taxes which have lately been erected by the Chinese labour of the natives. The Chinese merchants settled here are not permitted to go to the neighbouring countries which are independent of China, and the commerce is therefore carried on partly by the Turks, and mostly by the Tajicks. The Turks are Mohammedans.

The Tajicks, or Tadjicks, are that nation which speak the Persian as its native language, and which is spread over all the central countries of Asia, but only a few mountain valleys exclusively. In other countries their industry is mostly directed to the cultivation of the soil, but in Thian Shan Nanlu they are chiefly engaged

rade, and therefore many of them are met with in all commercial places. They are known to Europeans by the name of Bokharians, as the merchants from Bokhara visit the fairs of Nishnei Novogorod and other places Tajicks. They are permitted even to trade in the term provinces of China Proper, in Shensi and Shansi, some of them visit Kiachta. They conform in their and costume to the Turks, but preserve their language. They are Mohammedans.

Though Thian Shan Nanlu was subject to the Khalkas and Ngols for a considerable length of time, no traces exist of his nation ever having formed settlements in the country.

The Olöth Calmucks, when governed by the Galdan and his successors [SONGARIA, vol. xxii., p. 245], occupied it a short time, and as they expelled the Khalkas wherever they met them, the total absence of Mongol colonies may be ascertained. There are however in the eastern districts, especially in the town of Hami and its vicinity, a considerable number of Olöth Calmucks, who after the defeat of the Galdan were finally submitted to the sway of the Mantchoos. The number of Chinese is not large. Besides the officers of government, a small number are established in the large commercial towns as merchants; some of them also exercise other trades; but it does not appear that agricultural settlements have been made by them in this country, as in Songaria.

In the mountains at the north-west corner of Thian Shan Nanlu is a tribe of Kirghis, called the Kara Kirghis, and another tribe of that nation is met with in the deserts of the Tartashling. Both are nomadic tribes, occupying during the summer the highest portion of the mountain-region with their herds of camels, yak, horses, and sheep, and descending in winter to the lower regions.

Commerce, Towns, and Manufactures.—Nearly 1800 years ago a commercial road was established, which traverses this country in its length from east to west, and by which the commerce between China and Western Asia has been carried on nearly without interruption. After the fall of the empire of the Hiongnu under the dynasty of the Han, when the dominion of the Chinese extended to the west of the Caspian Sea, and nearly met the eastern boundary of the Western or Roman empire, this road was used for the purposes of commerce, and silk and other articles were thus brought to Western Asia. This road passes through the countries which lie along the base of the Thian Shan Mountains. Another road, which has probably been used for an equal length of time, connects Thian Shan Nanlu and China with the northern parts of the country, especially with Cashmir, and is also much used at the present day. As almost all our knowledge of the history of this country and their manufactures is derived from the accounts of the merchants who have passed along these roads, we shall follow their track in noticing them.

The caravans of China, bound for the western countries, are, as they are called there, after leaving the town of Sheou and the gate of Kia-yu-kooan [TANGUT, vol. ii., p. 32], pass through the desert of Han-hai and after 20 days' journey at Hami (42° 53' N. lat. and 107° E. long.). Hami, or Khamil, as it is called by the Chinese, is a fortified place, being surrounded by high walls, and enclose a space about two miles and a half in circumference.

The town is surrounded by large suburbs, where the caravans stop before they proceed for the west, and is populous. The streets are straight and regular, but the houses are low and built of dried clay. The country which surrounds the town is not distinguished by fertility, but is cultivated with extraordinary care and industry. Wheat, melons, and other fruits are sent to China in great quantities.

About 240 miles west of Hami is Pidshan, a fortress which is nearly two miles in circuit, and near which the caravan road passes. About 60 miles farther is Turfan, a fertile place, which however suffered much in the course of the last century. Karashar is 290 miles west of Turfan. Its fortress is not large, not exceeding one mile in circuit. The town is rather populous, and built on the banks of the Kaidu river, which is said to be navigable in his place. Its commerce is considerable, but manufactures are not mentioned, except that the inhabitants excel in the art of embroidery. Kurli, or Kurungli, is situated at that portion of the Kaidu river which connects the town with Lop Nor, and contains a population of about 4000 individuals. The country round the town is described in P. C., No. 1534.

very fertile. The town is 50 miles distant from Karashar to the south-west. Bukur or Bugur, nearly 200 miles distant from Kurli, contains 2000 families, or 10,000 individuals, and has a considerable commerce in copper, oil, sheep-skins, butter, and furs, especially lynx-skins.

Kutshe, which is 100 miles distant from Bugur, is a large town which is three miles in circumference, and contains a great population, of which 6000 are Turks. The mountains north of the town contain several mines, from which copper, saltpetre and sulphur, and sal ammoniac, are obtained. At this town begins the road which leads across the Thian Shan Mountains to Kuldsha in Ili, by the mountain-pass called Mussur Dabahn. Before it reaches the mountain-pass, it runs through the town of Sailim, which is built in an elevated valley, and near some mines. South-west of Kutshe is the town of Shayar, in a district producing abundance of rice, melons, and fruit. It contains a population of 4000 individuals.

In the valley of the Aksu Daria are the towns of Aksu and Ushi. Aksu is a large commercial and manufacturing town, which, according to one statement, contains 6000 houses, and, according to another, a population of 20,000 families. It is not fortified. Its commercial importance is not only derived from its being one of the largest places of depôt on the great caravan-road from China, but also from another road, which leads in a north-eastern direction to the mountain-pass of Mussur Dabahn, by which it communicates with Kuldsha, the capital of Ili, and by which it not only receives the produce of that country, but also several articles brought from Russia. [SONGARIA, vol. xxii., p. 245.] Bucharian merchants from Tobolsk sometimes proceed as far as this place, and it is likewise visited by traders from Khokand, Tashkend, and Bokhara. Its manufactures are numerous, especially those of cotton-stuffs, among which one called *bumaseya* is in great request in Siberia and Turkistan, and a kind of stuff, half silk and half cotton. Several articles made of leather, especially those of deer-leather, as harness and saddles, which are embossed with great art, are also highly valued, and exported to distant places. There are also some potteries, and many persons are employed in cutting and polishing precious stones. The Chinese garrison, consisting of 3000 men, inhabits a separate quarter of the town. Ushi, which lies higher up in the valley of the Aksu Daria, is built in the centre of an extensive country of great fertility, and is stated to contain 10,000 families. This place has a mint, in which copper coin is made, and it appears to carry on a considerable commerce.

The town of Kashgar is situated in the north-western angle of Thian Shan Nanlu, and at the commencement of the mountain-road which, traversing the chain that connects the Thian Shan with the Tartashling, leads to Fergana and the towns of Khokand and Tashkend. This road runs in a north-north-western direction. At this place also begins the other caravan-road, which, running south-east and passing along the eastern declivity of the Tartashling, and passing through the towns of Yarkiang and Khotan, leads over the Karakorum Pass to Leh, Gertope, and Cashmir. Besides these two lines of communication and the great caravan-road to China, a fourth road, commencing at Kashgar, runs north-east over the Thian Shan Mountains by the Rowat Pass, and, skirting the western shores of Lake Issokol, leads to Kuldsha and the banks of the Irtish river. This last road appears to be much frequented by Russian merchants. The advantages derived from all these roads concentrating at Kashgar render this town one of the most commercial in the interior of Asia. It is said to contain 15,000 houses, and a population of 80,000 individuals. In the Chinese geography the population is said to consist of 16,000 persons paying a capitation-tax, which would carry it to rather more than is stated by Russian travellers. The Turkish and Bucharian merchants of Kashgar visit the countries north of Hindustan, Bokhara, and Tobolsk; and numbers of merchants who are settled in the neighbouring independent states are always found in the town. All those who are of Turkish origin have free access to it; but the entry of Europeans is prevented by the Chinese authorities. In the middle of the town is a large square, from which four extensive bazars branch off. The Chinese garrison consists of 8000 men, who are stationed here to repress any invasion from the side of Khokand, and are quartered in a strong fortress, which is con-

tiguous to the town. The manufactures are numerous and extensive: the largest are those of silk, in which several kinds of stuffs, as satin, damask, &c., are made, and some of them are interwoven with gold and silver thread. The manufactures of cottons are less important, but their colours are much praised. The jewellers are very expert in cutting the yew and in working gold. Many articles are exported to China. The latest accounts however state that Kashgar and its commercial and manufacturing industry had suffered much by the invasion and rebellion of the Kodjas (1827), and that Yarkiang had become a much more commercial place than Kashgar. It is very probable that the town has recovered its former importance. South-west of Kashgar is the town of Tashbalig, which seems to be an important place, built on the banks of the Yaman-yar river, where it issues from the mountain-region of the Tartashling. On the road leading from Kashgar to Yarkiang is Yengi Hissar, a place of considerable extent.

Yarkiang, or Yarkand, may be considered the capital of Thian Shan Nanlu, as the Chinese military governor generally resides here. It consists of the city or fortress, which is surrounded by a high wall of stone, and is more than three miles in circumference, and numerous suburbs which lie round it. In the fortress a garrison of 7000 men is kept. The houses are mostly built of sun-dried bricks; but as rain is very rare in this country, they may be considered substantial. The river Yarkiang Daria is divided into two arms, and numerous canals have been made from them, by which all the streets are abundantly supplied with water. There are numerous public buildings, especially mosques and medrasses, or colleges: the number of the medrasses is stated to exceed ten. There are two large bazars, one in the city and the other in the suburbs, which are more than three miles long, and contain a great number of shops, well supplied with various articles of merchandise. Most of the shopkeepers are Chinese. There are also several large caravansaries. The country surrounding the town supplies it with three important articles of commerce, silk, fine wool, and horses, of which last great numbers go to other places, and as far as China. These horses are mostly of the Kirghis breed, rather small, but very strong, and much prized. The commerce with the countries north of Hindustan and with Tibet is very considerable. It is stated that there are several kinds of manufactures, but only cotton-stuffs are specified. The number of inhabitants who pay capitation-tax is stated to be between 30,000 and 40,000, which would give a population of between 180,000 and 240,000. Many foreigners are settled in this place. The number of Chinese merchants is only 200, but there are many others engaged in trade and manufactures. A great number of merchants from Shensi and Shansi visit Yarkiang. There are also a considerable number of natives of Cashmir settled here; but only a small number of Hindus, and no Jews or Armenians. The foreign merchants, who are met with in considerable numbers, are from Ferghana, Tibet, and Cashmir.

Khotan appears to have been formerly the name of the town which at present is called Ilitsi or Eelchi, whilst the name of Khotan is applied to the country which extends along the northern base of the Thungling. This country contains, according to the latest information, 700,000 persons who pay capitation-tax, which would give a population of between 3,500,000 and 4,000,000 individuals. Thus it appears that this country is by far the most populous and important part of Thian Shan Nanlu. A large number of the inhabitants are Buddhists, and it appears that among them are numerous descendants of Chinese, who settled there at a very early period. The town of Ilitsi is described as large and populous; but we have no peculiar account of it. It derives its commercial importance partly from the productions of the country, and partly from the circumstance that the great roads meet at this place. The eastern road passes from Ilitsi to Keriya, and through the pass of Keriya into Tibet, and seems to be the principal line of communication between the last-mentioned country and the northern provinces of China. The western road joins the great caravan-road which leads from Yarkiang to Leh and Cashmir. The principal articles which the country supplies for exportation are the yew-stone and silk, the last of which is grown in large quantities. It seems also that there are mines of copper in the neighbourhood, as vessels of copper are named among the articles manufac-

tured in this place. Silk and cotton stuffs are also to a great extent, and there are glass-houses. Every year a fair is held, which is sometimes attended by thousands. Horses are exported in great numbers, and are less prized than those of Yarkiang. Near the town of Keriya, through which the road passes to Tibet, are gold-mines.

The articles which are sent from Yarkiang to Cashmir are silver, goats' and sheep's wool, leather tanned in the manner of what is called Russian leather, embroideries of gold and silver, rice, and some few articles of Chinese manufacture; there are taken in return shawls of different qualities, cotton stuffs, sheep-skins and goat-skins, and some minor articles.

Only one caravan goes annually from Yarkiang to Badakshan, which carries a large quantity of tea and some silver, and brings back slaves and precious stones, especially rubies. It appears from Wood's 'Journey' that this intercourse has of late been interrupted by the unsettled state of Badakshan and of Wakhan. [TERRITORIES.]

The intercourse with Khokand, which had also been interrupted for several years, has lately been re-established. The articles exported to that country are silver, china-ware, tea in boxes, and pressed tea, of which large quantities are consumed by the inhabitants of Turkistan. The imports from Khokand are raw silk and different kinds of cotton stuffs.

The Bucharian merchants settled in Russia have succeeded in advancing as far as Kutah, Aksu, and Kashgar, to which places they bring broad-cloth, brocade, silver, gold coin, copper, iron, steel, and fur; and they take back several kinds of cotton stuffs, tea, rhubarb, and sal ammoniac.

We are very imperfectly acquainted with the actual intercourse between China Proper and Thian Shan Nanlu. It does not however appear that the latter puts any difficulties in the way of it, and it is stated that the commerce of Yarkiang with the northern provinces is active. The principal articles which are sent to China are raw silk, great numbers of horses and cattle, and other precious stones, and some dyeing stuffs; in return there are sent to Yarkiang tea, china-ware, and manufactured articles.

History.—The country of Thian Shan Nanlu has never in any way been connected with the political events of Europe and Western Asia, but frequently with those of Proper China, and it is only from the Chinese and Mongol historians that we learn the political changes to which it has been subject. Thus we are informed that before and at the beginning of our æra this part of Central Asia formed a portion of the powerful empire of the Hiongnu, a Turkish race, which for more than two centuries made war on China, and sometimes laid waste the northern provinces; but in the first century after Christ was overthrown by the dynasty of the Han emperors. It seems that the Chinese first for the first time got possession of the country, and they soon afterwards succeeded in extending their conquests over Ferghana and the deserts lying round the Aral, so that at that period their empire extended to the Caspian Sea. But in the fifth century after Christ the Chinese were dispossessed of this country by the Tang-hiang, a Tibetan race; and this and other races of the same origin continued to govern Thian Shan Nanlu up to the time of Gengis Khan. From the tenth to the thirteenth century it formed a part of the extensive empire of the Hiongnu of Tangut [TANGUT, p. 33], the overthrow of which, in 1227, was the last of the numerous and great exploits of the Mongol conqueror. [GENGIS KHAN, vol. xi., p. 117.] As the Mongols soon afterwards got possession of China, Thian Shan was again united to that country, and remained so as long as the descendants of Gengis Khan were masters of China. But when the Yuan dynasty was overthrown, in the fourteenth century (1368), by the Ming dynasty, and the Mongol empire was split into several states, Thian Shan became independent, and several small sovereignties arose under chiefs of Turkish origin. The Ming emperor would probably have succeeded in subjecting them, but for the conquests of Timur Beg, or Tamerlane, who entered the country towards the end of the fourteenth century, and brought it under his dominion. After his death the Turkish chiefs gradually resumed their independent station, and preserved it to the middle of the sixteenth

, when the Galdan or emperor of the Olöth Cal- who subjected to his sway all the tribes north of the than Mountains, began to extend his conquests to th of that range. The petty Turkish sovereigns, not ble to make resistance, yielded, and became tri- to the Olöth Calmucks. When the Galdan had efeated by the Chinese, and had died (1697), the passed from the Olöth Calmucks to the Songares KIA, vol. xxii., p. 245], who soon established their ty among the Turkish princes in Thian Shan Nanlu, n subjected Tibet. They kept it until their widely d empire was destroyed by the Chinese in 1756, and vereign, Amursana, fled to Tobolsk, where he died

The most powerful of the Turkish princes, the of Yarkiang and Kashgar, considered this event ble to the establishment of their independence, as ough it impossible that the Chinese could send an fficiently numerous for the subjection of Thian anlu through the wide desert which separates Pro- ia from their country, and they refused to submit to ority of the Mantchoo emperor. But the emperor o armies from Ili over the Thian Shan Nanlu ins. The first was only partly successful, and took ; but the other, under the command of Tshaohoei, d the whole of the country, and in 1759 the Kodjas liged to retire to Badakshan.

5 an insurrection broke out in the town of Ushi, s soon put down. In 1826 the descendants of the having insinuated themselves into the favour of the Khokand, and obtained from him the support of a ny, entered Thian Shan by the Terek Pass, and d in taking Kashgar, Aksu, Yarkiang, and Khotan; inese army of 60,000 men being sent against them, e defeated in three battles, and again retired to an, where Wood, in his journey to the source of r Oxus, found one of these Kodjas living in

alde's *History of China*; Mailla's *Histoire Gé- de la Chine*; Klaproth's *Magasin Asiatique*; s *Memoir on Chinese Tartary and Khokan*, in of the *Asiatic Society of Bengal*, vol. iv.; Wood's *ve of a Journey to the Source of the River Oxus*; *Erdkunde von Asien*, vol. i., ii., and v.)

AUT V., count of Champagne, and first king of of that name, occupies a respectable rank among badours. It has been pretty satisfactorily shown nt writers on the subject that the scandalous old of this king by Matthew of Paris and others n no satisfactory evidence. They have however re successful in disproving the tales of their pre- than in substituting anything in their place. ve rendered Thibaut's biography in a great mea- ative.

is born about the beginning of the year 1201, and a called Theobaldus Posthumus, on account of er having died before his birth. His mother, . daughter of Sancho the Wise, king of Navarre, arge of and governed his extensive territories as or twenty years. A taste for literature was here- the family of Thibaut. His grandmother, Marie e, held, about the middle of the twelfth century, one ost celebrated 'Courts of Love,' and some of her ts have been preserved by André le Chapelain. her Blanche induced by her commands Aubein ne to compose several songs, after he had solemnly ed the practice of poetry. With such examples im it was natural enough that the young count of gne should contract a taste for rhyming.

tempt was made in the year 1214 to wrest the s of Champagne from the widow and her son. her of Thibaut was a younger son: his elder Henry followed Philippe Auguste to the Holy id, marrying there a sister of Baldwin IV., king of and Jerusalem, had by her two daughters, Alice, f Cyprus, and Philippa, who married Airard de . The father of Thibaut V., after his brother's re for Palestine, took possession of Champagne s, which were held without challenge by him, and widow in name of her son, till 1214. Airard de then claimed them in right of his wife. Philippe : decided in favour of Thibaut, and the sentence ifirmed by the peers of France, in July, 1216, on

the ground that Henry, when departing for the East, had ceded all his lands in France to his brother, in the event of his not returning. In November, 1221, the seigneur o Brieune was persuaded to abandon his claims upon receiv- ing a compensation.

In the same year Thibaut took upon himself the management of his domains, which rendered him, by their extent, and the title of count palatine, which they conferred upon their holder, the most powerful vassal of the crown. During the brief and troubled reign of Louis VIII. (July, 1223, to November, 1226), Thibaut distinguished himself by nothing but the pertinacity with which he insisted upon his feudal rights. At the siege of Rochelle he consented to remain till the town was taken, but exacted in return a declaration from the king that by so doing he did not render himself liable on any future occasion for more than the 40 days' service in arms due by the vassals of the crown. In the crusade against the Albigenes (induced probably by regard for the count of Toulouse, who was his kinsman) he resisted every entreaty of the king to remain with the army after the 40 days had expired; and his departure from it was one of the foundations for the stories afterwards circulated to his disadvantage.

On the death of Louis VIII. a league was formed by a number of the most powerful French nobles to prevent the queen from acting as regent. Thibaut was at the outset a party to this confederacy. There are extant letters of Pierre, duke of Bretagne, and Hugues de Lusignan (dated March, 1226, which, as the year is now made to commence, would be called 1227), authorizing him to conclude in their name a truce with the king. The regent however found means to detach the count of Champagne from his allies; for an attempt which they made soon after to obtain possession of her person and the king's was frustrated by the opportune arrival of Thibaut at the head of a strong body of horse.

The duke of Bretagne and his coadjutors were much incensed at the desertion of the count of Champagne, and appear to have soon after formed the project of harassing him by supporting the claims of the queen of Cyprus upon Champagne and Brie. He was however, on account of his wealth, too desirable an ally to be lost without an endeavour to regain him. Overtures of reconciliation were made, in consequence of which count Thibaut engaged, in 1231, to take to wife the daughter of Pierre of Bretagne. Thibaut had been twice married before; in his 18th year, to Gertrude, daughter of the count of Metz, from whom he was divorced, and afterwards to Agnes de Beaujeu, by whom he had a daughter. The regent, fearing the consequences of this reconciliation, interfered to break it off. The marriage-day had been fixed, and the bridegroom was already on his way to the place where it was to be celebrated, when letters from the king, forbidding him to conclude the engagement, were delivered to him. He obeyed the royal mandate.

This insult determined the confederates to carry into execution their original project. They sent for the queen of Cyprus, and invaded Champagne, avowedly for the purpose of putting her in possession of it. The king marched to the assistance of Thibaut, and under his auspices a compromise was arranged. Thibaut ceded to the queen of Cyprus lands to the value of 2000 livres yearly, and paid her in addition 20,000,000 of livres in money. This sum was advanced by the king, who received in return the estates of Sancerre and others which Thibaut's father had held before he acquired Champagne.

Here seems the proper place to notice the stories told by Matthew of Paris regarding the loves of Thibaut and queer Blanche, and the poisoning of Louis VIII., laid to the charge of the former. Matthew only mentions the accusations as a rumour he had heard. No other historian o. equal antiquity mentions them. Had Thibaut been suspected of being the murderer of the king, the charge would probably have been urged against him by one or other of the rival factions, with whom he played fast and loose immediately after. There is not a passage in his poems that can be interpreted into a declaration of attachment to Blanche, who was moreover thirteen years his senior. But it is easy to see how the rumour mentioned by Matthew of Paris arose. A rhymed chronicle, apparently of the age of Thibaut, represents him as going

about (1230) in disguise to learn how men spoke of him, and discovering he had no friends. About this time there were violent disputes between the university of Paris and the papal legate, and, the queen supporting the legate, the wild students made and sang ribald songs attributing this report to a guilty passion for his person. In times of civil dissension it is generally found that parties otherwise totally unconnected catch up and spread each others' lies when it suits their purpose. The queen, the legate, and the count of Champagne were all unpopular; the dissolute students had circulated imputations against the chastity of the two former; and the interference of the king to prevent the marriage of the last-mentioned with the daughter of the duke of Bretagne would, under such circumstances, be easily interpreted into a plot of the queen-mother to keep him for herself. It was amongst the students that the first story was invented, and that is the quarter whence Matthew of Paris most probably obtained much of his information regarding French affairs.

In 1232 Thibaut married a daughter of Archambaud VIII. of Bourbon. In April, 1234, he succeeded to the throne of Navarre, on the death of Sancho the Strong. In 1235 he quarrelled with Saint Louis about the territories he had ceded to the king at the time of the arrangement with the queen of Cyprus, representing them as merely transferred to the king in security for the money he advanced, while the latter asserted that they had been sold to him for that sum. It came to blows, and Thibaut was beaten.

In 1239 Thibaut took the cross, and set out at the head of an expedition to the Holy Land. He displayed none of the talents of a general. Unable to procure ships to transport his forces to the scene of action, he marched through Hungary and Thrace. Arrived in the neighbourhood of Byzantium, his treasure was so completely expended, that his followers had to support themselves by plunder. In an engagement near Caesarea the division of the army under his immediate command was beaten, although the other was victorious. He got involved in the defiles of Taurus, and lost two-thirds of his men. Lastly, at the final defeat near Ascalon, he fled ingloriously before the battle was ended, leaving his followers to their fate.

He returned to Pampeluna, which he had made his capital, in 1242, and died in 1253, having done nothing worthy of notice in the interim, leaving a widow and six children.

The poems attributed to Thibaut are in number sixty-six, and there appears no reason for questioning the authenticity of any of them. Thirty-eight are devoted to the expression of passionate complaints and ecstasies; three recount his amorous adventures with peasant-girls; twelve are what may be called rhymed law-cases in matters of love; the rest are exhortations to engage in the Crusade, or invectives against the immorality of the age. The passion of the amorous poems is not very intense; there scarcely needed the few lines appended to most of them, addressed to some brother-troubadour, to show that they are mere displays of the author's cleverness. The cases for the Court of Love are ingenious and insignificant, like all other compositions of that kind. The fifty-fourth song, an exhortation to join the Crusade, is spirited. The sixty-fifth, in which the God of Christians is compared to the pelican feeding its young with its blood, is characterised by a blended tone of toleration and enthusiasm. In the sixty-sixth he starts a theory that the law of God is ripe and wholesome fruit, and that Adam sinned by eating unripe fruit. Thibaut's versification is correct and sweet. There is a spirit of generosity about his poems that is creditable to himself: the neatness and finish of his verses are more attributable to the degree of perfection to which the art had been previously carried by others than to the author's own talents. Altogether his literary productions leave a more favourable impression of his character than the part he played as a warrior and politician. There is tergiversation and something worse in his public conduct, but the disposition evinced by his writings leads to the conclusion that he sinned more through want of firmness than from ill-will.

(*Les Poésies du Roy de Navarre*, par Levesque de la Ravalière, Paris, 1742, 12mo; *Histoire de S. Loys*, IX. du nom, *Roy de France*, par Messire Jean, Sire de Joinville;

par M. Claude Menard, à Paris, 1617, 4to; *De Belis Continuatæ Historiæ Libri V.*, Basilio Johanne autore, Basiliæ, 1500, fol.; Bayle; Moren; and *Biographie Universelle*, in voce Thibaut.)

THIBET. [TIBET.]

THIEL, or TIEL, is the chief town of a district in the province of Gelderland in the kingdom of the Netherlands. It is situated in 51° 50' N. lat. and 5° 28' E. long. It is on the river Waal, about 15 miles from Nimegen, in the province called the Betuwe, which is celebrated for its fertility. The town of Thiel contains 5000 inhabitants; the chief occupation of which it is the chief place, 48,200. The chief occupations of the inhabitants are agriculture and the breeding of cattle; they have also manufactures of woollen and water-colours. (Stein, *Lexicon*; Hassel; Cannabach.)

THIELEN, JAN PHILIP VAN, was born at Mechlin in 1618. He was of a noble family, and lord of Couwenburg. Though he received an education suitable to his rank, and was instructed in every branch of polite literature, his predilection for the art of painting induced him to become a disciple of Daniel Segers.

Having voluntarily placed himself under so able an instructor, his improvement, as might have been expected, was rapid. His subjects were usually in the taste of Segers, garlands of flowers, with some historical designs in the centre, or festoons twining round vases enriched with representations in bas-relief. He always copied from nature, and chose his flowers in the entire perfection of their beauty, grouping them with great taste. His pictures are very highly finished, with a light touch, perhaps less spirited than the works of Segers; but it is sufficient praise to say that his performances rivalled those of his master.

He was much employed by Philip IV., king of Spain, and most of his finest performances are (or at least were) in the Spanish royal collection. Two of his capital pictures were at Mechlin; they represented garlands and flowers, and many insects of different kinds on the table all finished with exquisite delicacy. The figure of St. Bernard is in the centre of the one, and that of St. Weyermann also highly commended, which has in the centre a nymph sleeping, watched by a satyr, the figures being painted by Poelemburg.

Von Thielen seldom inscribed his name on any of his works; he generally marked them J. or P. Couwenburg.

THIELT is the chief town of the district of the same name in the province of West Flanders, in the kingdom of Belgium. It is about 15 miles south-west of Bruges, on the road from Ghent to Dixmuden. Thielt is a cheerful town, with two churches, 1700 houses, among which are many handsome modern buildings, and 12,000 inhabitants, and is the chief market for the flax-trade of Flanders. At the weekly market there is a great sale for linen, corn, cattle, and butter. The inhabitants have several establishments for bleaching wax and linen, six breweries, and many flourishing manufactories. There are an academy, several literary societies, a musical society, and several schools. [FLANDERS, WEST.]

(Stein, *Lexicon*; Cannabach, *Lehrbuch*; Hoffmann, *Deutschland und seine Bewohner*, vol. iii.)

THIERS, a town in France, capital of an arrondissement in the department of Puy de Dôme, 273 miles from Paris by Nevers, Moulins, and Roanne, and 24 from Clermont-Ferrand, the capital of the department: it is in 45° 51' N. lat. and 3° 33' E. long. Thiers originated in the middle ages. There was a strong castle here in the earlier periods of the French monarchy, which became under the feudal system the head of one of the principal fiefs of Auvergne. The town stands on the crest and side of a hill sloping down to the northern or right bank of the Durole, a little stream flowing into the Dore, which itself flows into the Allier. It is in a picturesque situation, amid wild scenery, and commanded by lofty and well-wooded hills on the north, down the side of which the road from Lyon to Thiers runs by a remarkably steep slope. The houses at this entrance

* So many valuable pictures were carried off or destroyed, not only during the French occupation, but in the disorders of late years, that it is difficult to speak positively. Thus the French king, Louis-Philippe, a few years ago sent the Chevalier Taylor to Spain to purchase pictures, at a time when the rap of the populace was directed against the convents. The chevalier accordingly went to Spain, and purchased four hundred and seventy-four pictures, many of which were thereby saved from destruction. The Chevalier Taylor was that he saw some fine pictures by Paul Veronese destroyed, in spite of his urgent entreaties and offers to purchase them.

he town present a pleasing appearance, from their being painted in fresco in a manner similar to those of Nice; but proceeding into the town the steep, narrow, dark streets, bordered by gloomy houses, disappoint expectation. There is no public building worthy of notice, and no public square or place except one at the entrance of the town from Lyon: the town is inhabited by workpeople, and presents very few ('not a score,' says one of our authorities) decent houses. The chief manufactures are paper and playing-cards, fine cutlery and hardwares, tapers, and candles. The paper-mills are on the Durole, the steep rocky banks of which excavations have been made for the sites of the mills: this branch of industry has been established in the town from the sixteenth century. The quality of the paper manufactured here is good, and a large portion of it is sent to Paris. The razors, knives, and scissors, though of ordinary quality, command a good sale, and are exported to Spain, Italy, the Levant, and the East Indies: the iron is brought from Nivernais, Burgundy, and Franche-Comté. There are in and round the town 600 manufactories or workshops for cutlery, employing it is said, 6000 persons. The candles are made from the fat of the goats reared on the surrounding hills. There is a large poor-house, in which woollen cloths, lace, and trimmings are made, and other manufactures are carried on. These various manufactures employ three-fourths of the population of the town and the villages many miles round. The population of the commune of Thiers, in 1826, was 11,613; in 1831, 9836, of which 6586 were in the town itself; and, in 1836, 9982. There is an inferior court of justice, a tribunal de commerce, a chamber of manufactures, a council of prud'hommes; some fiscal or administrative government offices, a hospital or poor-house, and a high school, or college. There are eight yearly fairs.

The arrondissement of Thiers has an area of 332 square miles, and comprehends only 39 communes, with a population, in 1831, of 67,870; in 1836, of 70,657: it is divided into six cantons or districts, each under a justice of the peace.

Thiers, *Yasse de Villiers, Itinéraire Descriptif de la France; et Brun, Géographie; Dictionnaire Géographique universel.*)

HIMBLE, a metallic cap, in the shape of a hollow conical cone, worn on the finger in sewing, in order to prevent the needle to be pressed through the work with adequate force, without injury to the finger. Thimbles used by dress-makers usually have slightly convex tops, which, as well as the upper part of the circumference of the cone, are studded with numerous small indentations symmetrically arranged, which serve to prevent the end of the needle from slipping; but those used by tailors, upholsterers, and needle-makers generally, have no tops, but have the like indentations on the sides of the cone, with which alone the necessary pressure is applied to the needle. Although occasionally made of other materials, as porcelain and ivory, for ornamental purposes, thimbles are most commonly formed of silver, steel, white alloys, or brass; or of silver and steel so combined as to retain the advantage of the superior hardness of the latter metal for the parts which are in contact with the needle, while those which are in contact with the finger are of silver. This is sometimes effected by making the cap and upper part of the cone of silver and the lower part of silver; and sometimes by forming the body of the thimble entirely of iron or steel, and lining it with silver or gold. As thimbles form an indispensable part of the furniture of a lady's work-table, they are with ingenuity is often displayed in their decoration by engraving, engraving, and inlaying with gold. They are usually formed by means of a stamping-machine, but the following process, for the description of which we are indebted to Dr. Ure's 'Dictionary of Arts,' &c., p. 1239, has been practised by MM. Rouy and Berthier, of Paris:—A sheet of iron, one twenty-fourth part of an inch thick, after being cut into strips of convenient size, is passed under a rolling-press, by which it is cut into circular discs of about one-eighth of an inch diameter. These discs are then made red-hot, and laid in succession upon a series of mandrils, with holes of successively increasing depth, into which the heated discs are forced by striking them with a rounded punch, about the size of the finger. After being brought to the required shape, the thimble is placed

in a lathe, when the inside is polished and the outside is turned, cut with circles for the reception of gold ornaments, and indented or pitted with a kind of milling-tool. After this the thimbles are annealed, brightened, and gilt inside with a very thin cone of gold-leaf, which is firmly united to the surface of the iron simply by the strong pressure of a smooth steel mandril. Gold fillets are then fixed by pressure in the grooves turned to receive them.

Sail-makers, in those coarse kinds of sewing which require the application of considerable force to the needle, employ, in lieu of thimbles, circular plates of cast-iron, indented or pitted on the surface. These are called *palmes*, and are secured to the palm of the hand by straps.

The name 'thimble' is applied to the metallic eyes, in the form of rings with a groove in their circumference to receive a rope, which are used in rigging where it is desired to form a loop or eye at the end of one rope, through which another may slide with very little friction.

THINOCORINÆ, Mr. G. R. Gray's first subfamily of the family *Chionididæ*, containing the genera *Attagis*, J. Geoff. and Less.; *Ocyptetes*, Wagl.; and *Thinocorus*, Eschsch.

THINOCORUS, Eschscholtz's name for a genus of birds placed by Mr. G. R. Gray in his subfamily *THINOCORINÆ*.

THION DE LA CHAUME, CLAUDE-ESPRIT, an eminent French physician, was born at Paris, January 16, 1750. His father, who was a banker, gave him an excellent education, and destined him originally for the bar, but he himself preferred the study of medicine. He commenced his studies at Paris with great success, but, for some unknown reason, took his doctor's degree at Rheims. In 1773 he was appointed physician to the military hospital at Monaco in Italy, which was then occupied by a French garrison; and in 1778 to that at Ajaccio in Corsica. His zeal and talents were rewarded by the rank of chief physician to the troops destined to lay siege to Minorca and shortly afterwards to Gibraltar. Here he had to treat a fatal epidemic which prevailed among the combined French and Spanish forces in a typhoid form, the description of which same disease immortalised the name of Pringle towards the middle of the last century. This same squadron had already put ashore and left at Cadiz a great number of Frenchmen that had been attacked by the disease, when, in the beginning of September, 1782, it came to the bay of Algeiras. Here the naval hospital could only receive fifty of their sick, while as many as five hundred were in want of admission; and to place these in private houses was not only a very difficult, but also an undesirable proceeding. In these embarrassing circumstances Thion de la Chaume conceived the happy idea of making the sick encamp under tents as soon as they landed, an arrangement which was dictated by the climate, the season, and the nature of the disease, and of which the boldness was justified by success. La Chaume himself was attacked by the epidemic, and a great number of medical officers of all ranks, as well as the nurses, were carried off by it. When peace was concluded La Chaume returned to France, and was received with distinction by the Comte d'Artois (afterwards Charles X.), who had been a witness of his self-devotion and success at Algeiras, and who appointed him to be one of his own physicians. Shortly afterwards he married, but in the winter of 1785-6 he found that, in consequence of the rapid progress made by a pulmonary disease which had for some time threatened him, it was necessary for him to go to the south of France. Here he met with the kindest attentions from the officers of the regiment which he had formerly taken charge of at Ajaccio, who were at this time in garrison at Montpellier; at which place he died, October 28, 1786, at the early age of thirty-six. Thion de la Chaume wrote but little, though he is said to have carefully noted down every night whatever he had seen during the day worth recording; he nevertheless occupies a high rank in the list of army surgeons. His writings consist almost entirely of articles in medical dictionaries and periodicals, of which the most interesting is the account of the epidemic at Algeiras, which was published in the second volume of the 'Journal de Médecine Militaire.' (*Biographie Médicale.*)

THIONURIC ACID. When nitric acid is made to act upon uric acid, both are decomposed, and *alloxan*, a compound of hydrogen, carbon, oxygen, and azote, is ob-

tained in crystals. If sulphurous acid gas be passed through a saturated solution of alloxan in water, brilliant white crystals are obtained, which are thionurate of ammonia; these are to be decomposed by acetate of lead, and the thionurate of lead formed is to be decomposed by hydrosulphuric acid. By separating the sulphuret of lead, and evaporating the liquor, thionuric acid remains.

Its properties are, that it is a white semi-crystalline mass, readily soluble in water, and the solution reddens litmus strongly; it contains the elements of two equivalents of sulphurous acid, one equivalent of ammonia, and one of alloxan, or—

Seven equivalents of hydrogen . . .	7
Eight equivalents of carbon . . .	56
Fourteen equivalents of oxygen . . .	112
Three equivalents of azote . . .	42
Two equivalents of sulphur . . .	32
Equivalent . . .	<hr/> 249

When heated, it is decomposed, much sulphuric acid remains in solution, and a crystalline compound is formed, which is termed *uramil*.

Thionuric acid combines with bases to form salts, which are termed *thionurates*; they are not however of sufficient importance to require description.

THONVILLE, an important town in France, capital of an arrondissement in the department of Moselle, 208 miles east-north-east of Paris, by Meaux, Château Thierry, Châlons-sur-Marne, Ste. Ménehould, Verdun, and Metz: it is in 41° 29' N. lat. and 6° 11' E. long.

Thionville (Latinized, Theodonis Villa) was a place of consequence in the time of the kings of France of the Carolingian dynasty, who had a palace here: several important councils were held at Thionville in the reign of Charlemagne and his son Louis le Débonnaire. After the extinction of the Carolingian dynasty, the place came successively into the hands of the counts of Luxembourg, the dukes of Bourgogne, and the house of Austria, passing to the Spanish branch of that family. The duke of Guise took it from the Spaniards, A.D. 1558, but it was restored the following year. In A.D. 1639 it was besieged by the French, who were entirely defeated by an army sent to its relief: it was however taken by the prince of Condé, A.D. 1643, after the battle of Rocroy, and has ever since remained in the power of the French. It was bombarded by the Austrians in A.D. 1792, and again by the allies in A.D. 1814. Thionville is surrounded by strong fortifications, and is a fortress of the third class, and one of the barriers of France toward the Rhenish provinces of Prussia. The town is on the left or west bank of the Moselle; the citadel on the right bank: the two communicate by a bridge, the piers of which are of stone, and the upper part of wood, removeable at pleasure. The town is skirted on the south-east side by the canal of Yutz, over which are two bridges of stone and one of wood. The entrance into the town is by six gates: the houses have little worthy of notice: there are a good parade, a parish church which deserves examination, a riding-school, a corn-market, a theatre, an arsenal, a college or high school, which occupies the ex-convent of the monks of St. Augustine, an hospital, and a military prison. There are some manufactures of hosiery, woollen cloth, hats, household furniture, and candles: there are breweries, tan-yards, and oil and bark mills. There is one yearly fair.

The population of the commune of Thionville, in 1826, was 5821; in 1831, 5645 (of whom 4142 were in the town); in 1836, 5680. There are a subordinate court of justice, several fiscal and administrative government offices, and a society for the encouragement of agriculture and industry.

The arrondissement of Thionville has an area of 405 square miles, and comprehends 117 communes: it had, in 1831, a population of 83,227; and, in 1836, of 87,520: it is divided into five cantons or districts, each under a justice of the peace.

(Malte-Brun, *Géographie Universelle; Dictionnaire Géographique Universel.*)

THIRD, an interval in music, classed among the imperfect concords, because liable to alteration; that is, the third may be either *major* or *minor*. The ratio of the Major Third is 5 : 4; of the Minor Third, 6 : 5. The former comprises one major and one minor tone, as c z.

The latter comprises a major tone and a semitone c. Example:—

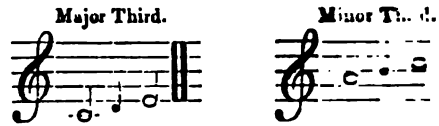

Or, according to the mode of description adopted by writers on the subject, the Major Third comprises six semitones; the Minor only four, E



THIRLAGE, a tenure or custom formerly very common in Scotland, by which the owners or occupiers of lands were compelled to take their corn to a mill, to which the lands were said to be thirled or bound, and to pay a certain proportion of it, varying in cases, as a remuneration for the grinding, and expense of the erection and maintenance of Covenants of thirlage also bound the occupiers of unstricted lands to the performance of certain duties for the maintenance of the mill and mill-dam, the carrying of millstones from the place at which they were thirled, &c. Thirlage was of three kinds, of which the most oppressive was the thirlage of food, by which the tenants or possessors of the lands were merely compelled to carry to the mill their corn as they might require to use for food. Thirlage of growing corn extended to all the lands upon the thirled lands, with the exception of small farms and such as might be used as food for horses in the state of grain. In some cases this thirlage was modified by a provision to enable the tenant on payment of a certain proportion of corn as a remuneration, to sell the remainder of his grain without the mill to be converted into meal. The thirlage, called thirlage of *invecta et illata*, requires all corn brought within the thirled district, whether it might have been raised, should be taken to the mill, that is to say, the mill to which the lands are thirled or bound. This kind of servitude, having in many cases exceedingly oppressive, has fallen into disuse, an annual payment in grain being substituted. Further particulars respecting this tenure may be seen in Rees's 'Cyclopædia,' art. 'Thirlage'; and in the 'Law' (clxx., 12-18) in the fourth edition of the *cleropædia Britannica.*

THIROPTERA, Spix's name for a genus of ROPTERA which, according to Cuvier, seems to be characterized in common with *Molossus*: its thorax is small concave palette which is peculiar to it, and it is able to hook itself better than it otherwise could.

Example, *Thiroptera tricolor*, Spix, 36, f. 9. Cuvier remarks that he places this subgenus with *because the description is incomplete.*

THIRST. [YORKSHIRE.]

THIRST is the peculiar sensation which excites a desire to drink. Water is the proper object of thirst. Of all the warm-blooded animals which are capable of thirst, man alone is either disposed, or, by the circumstances of his artificial mode of life, compelled, to drink it with any other liquid; and in all the variety of rages which man has invented, the water with which the ingredients are combined is the only part which is essential to the satisfaction of thirst.

The times and degrees in which thirst is felt are, in general, such that, by satisfying it, the individual is provided with the quantity of water necessary for the repair of its tissues and the maintenance of their moisture, and for the replacement of the fluid constantly lost by perspiration and other discharges. The quantity of water necessary for this purpose varies greatly, according to the different circumstances of age, sex, and temperament, and still more according to the nature of the food taken, the state of the atmosphere, and the mode of life, and the custom of the individual.

or salted food excites great thirst, probably because the quantity of fluid is abstracted from the blood for nutrition; but fruits and soft vegetables assist, by the quantity of water which they contain, in quenching thirst; infants, receiving their food and drink at once from the milk which is naturally provided for them, are perhaps not sensible of thirst as a healthy sensation different from the relief of hunger. Strong drinks, again, excite thirst, but in an injurious manner; either by their irritation of the nerves of the digestive canal, or by the great quantity of fluid which, by exosmosis, they withdraw from the blood.

In general, the degree of thirst during health is inversely proportioned to the rapidity of the exhalation of steam from the skin and lungs. Hence the naturally greater thirst in summer, and the desire for the fresh fruits of the tropics, which both supply water and produce moisture of the mouth by exciting a flow of saliva; hence also the natural thirst which is produced by remaining in hot crowded rooms, and that which is so painfully felt by iron-works about iron-forges and steam-engines, and which they can satisfy only by frequent and enormous quantities of water. Of the same kind is the thirst which is felt in ascending high mountains, on which, as the atmospheric pressure diminishes, the evaporation from the skin is increased; and that which is produced by exposure to a dry brisk wind.

Sensations and other circumstances accompanying thirst need not be described. The sensation of dryness of the mouth and throat, which most strongly characterizes it, is not always the result of those parts being really deficient in moisture, nor is it removed by washing the mouth alone with fluid. It is an example of a class of local sensations which are indicative of peculiar general conditions of the body, or of the condition of some other part in which no sensation is perceived. These have been called reflex sensations; and the characters common to many of them, as well as the cause, is that the animal perceiving them is impelled to do those things which tend to the health of the body. For example, the irritation which is felt at the upper part of the throat, and which induces one to cough, is often due to a direct excitement of that part, but to the existence of an irritating substance, such as mucus, in a distant insensible part of the air-passages. From the latter an impression is conveyed to the nervous centre; and, without directly giving rise to a sensation, it is reflected to be reflected to the sensitive nerves of the head; and the sensation which is perceived through these nerves is the desire to cough, and thus leads to the expulsion of the irritating substance. In like manner the sensation of dryness in the mouth induces one to drink, and to remove not merely the sensation, but the more important condition, such as a deficiency of water in the mouth of which it is a sign.

As cough may be produced by a direct irritation of any part of the larynx, so a sensation similar to that of thirst is often due only to a rapid evaporation from the mouth and throat, as in long speaking or singing; but this is removed by merely washing the mouth and throat, exciting a flow of saliva; means which are insufficient for the remedy of real thirst. That the introduction of water into the blood is necessary for quenching thirst is often proved in persons who in attempting suicide have divided the pharynx or œsophagus, so that they could not swallow in the ordinary mode. Repeated washing of the mouth has been altogether unavailing to relieve thirst; but the injecting of water through the wound in the stomach has quickly removed the sensation of thirst in the mouth, though none of the water passed into the stomach. Similar facts have been observed in those who, unable to swallow or to have liquids forced into their throats, have been long immersed in baths, and in shipwrecked sailors who have had no fresh water and have quenched their thirst by keeping their clothes soaked with sea-

water: thirst of many diseases, such as acute fevers and violent inflammations, affords another proof of the peculiarity of it being chiefly a sign of some general condition; for in these the sensation often continues notwithstanding the mouth is moist, but after large quantities of water have been imbibed, being here probably dependent on some condition of the blood which dilution does

not remedy. In certain cases also the sensation seems to be entirely subjective, and dependent on a peculiar condition of the nervous system. This is remarkably the case in a disease of which the true pathology is unknown, and which has been named polydipsia, from its chief symptom being an excessive and insatiable thirst. Several examples have been recorded, in some of which the thirst probably depended on a constant discharge of fluids from the diabetical blood, or by dropsical effusions, or otherwise: but in many it could not be traced to such an origin. One of the most remarkable of them is described by Mr. Ware, in the 'London Medical and Physical Journal' for 1816: the patient was a man 22 years old, whose health was in other respects good, but who was compelled to drink six gallons of water daily. He had been accustomed to drink nearly as much from his childhood; and, if deprived of a sufficient supply, his head was always affected, and fainting and dullness of the senses ensued. Nearly all the cases of the same kind which have been published are collected in a paper by M. Lacombe, in the French medical journal 'L'Expérience,' for May and June, 1841, and references to several are given by Tiedemann, in his 'Physiologie des Menschen,' Band iii., p. 71.

If thirst be long unalleviated, it produces one of the most dreadful states which a man can be compelled to bear. Those who have attempted suicide by starvation have been unable to resist the desire to drink, though they have endured many days of abstinence from food, and have been compelled thus for a time to protract their lives. The same tortures have been endured by sailors wrecked far from land. As the thirst increases, the mouth and throat become painful and burning hot, the respiration grows difficult, and the expired air feels hot and dry. The voice becomes hoarse, the speech thick and indistinct, and the pulse small and rapid. All secretion diminishes or is suppressed, the skin is hot and dry, and the eyes become painful and inflamed. The sensibility of every part of the body seems exalted, at the same time that the power of the muscles fails; the mind passes slowly from restlessness and anxiety to despair, and at last, as the body grows weaker, begins to wander in a low delirium. At the close of life there is an utter prostration of strength, and, in general, insensibility; but the inflammation of the mouth and eyes, and of all the parts that are not protected from the air by a thick cuticle, increases, and proceeds sometimes to gangrene. The time during which so miserable a state can be endured varies with the strength of the sufferer. Haller (*Elementa Physiologiae*, t. vi.) has collected examples of men who lived for at least fifteen days without drinking; but the more ordinary period is eight or ten days.

THIRTY TYRANTS (of Athens). In the year 404 B.C., when, after the Peloponnesian war, Athens had fallen into the hands of Sparta through the treacherous designs of the oligarchical party, the Spartans themselves did not interfere in any direct way with the political constitution of Athens (Diodorus, xiv. 4), but their negotiations with Theramenes and others of the same party had convinced them that even without their interference the democracy would soon be abolished. In this expectation they were not disappointed, as this was really the object of the oligarchical party. But as this party did not sufficiently trust its own power, Lysander, who had already sailed to Samos, was invited to attend the Assembly at Athens, in which the question of reforming the constitution was to be considered. The presence of Lysander and other Spartan generals with their armies, and the threats that were uttered, silenced all opposition on the side of the popular party, and on the proposition of Theramenes a decree was passed that thirty men should be elected to draw up a new constitution. (Xenophon, *Hellen.*, ii. 3, 2.) Lysias (*in Eratosth.*, p. 126, ed. Steph.) gives a more satisfactory account of the proceedings on that memorable day than Xenophon. These thirty individuals were invested with the sovereign power of the republic. Theramenes himself nominated ten, the Athenian ephors ten others, and the election of the remaining ten was left to the people. The names of the Thirty are preserved in Xenophon (*Hellen.*, ii. 3, 2). Their government, a real reign of terror, which fortunately did not last more than one year, was called in Athenian history the year of anarchy, or the reign of the Thirty Tyrants. From the moment that they had thus acquired an apparently legal power, they filled the vacancies in the

senate and the magistracies with their own friends and creatures. The new code of laws which they were to draw up was never made, that they might not put any restraints upon themselves, and might always be at liberty to act as they pleased. A similar board, consisting of ten men, perhaps appointed by Lysander himself, was intrusted with the government of Piræus. The object of the tyrants was to reduce Athens to the condition of an unimportant town, and to make the people forget the greatness to which it had been raised by Themistocles and Pericles. The splendid arsenal of Athens was sold and pulled down, and several of the fortresses of Attica were destroyed. To establish their tyranny the Thirty found it necessary to get rid of a number of persons obnoxious to them. The first that were put to death were the sycophants, who during the time of the democracy had contributed most towards its overthrow by their shameful practices; and the senate, as well as every well-meaning citizen, was glad to see the republic delivered of such a pestilence. The senate acted in these trials as the supreme court of justice, and the Thirty presided in it. All the votes of the senators however were given openly, that the tyrants might be able to see which way each senator voted. This mode of proceeding, though it was at first only directed against individuals equally obnoxious to all parties, became alarming when all the distinguished men, who had been imprisoned before the day on which the new constitution was established, in order that they might not frustrate the plans of the oligarchs by their opposition, were in like manner sentenced to death. The apprehensions of the people were but too well founded, and Critias, the most cruel among the Thirty, gave sufficient indications that the Tyrants did not mean to go on with the same moderation. That they might always have at hand an armed force to support them, they sent an embassy to Sparta to ask for a garrison to occupy the Acropolis. This was granted, and came under the command of Callibius as harmostes. His arrival rendered the Thirty secure. They courted the Spartan harmostes in the most obsequious manner, and he in return placed his troops at their disposal for whatever purpose they might wish to employ them in establishing their dominion more firmly. The assistance of the senate in the trials for political offences began to be dispensed with, and the number of the unhappy victims increased at a fearful rate. Not only persons who opposed or showed any dissatisfaction with the rule of the Tyrants, but all who by their merits had gained favour with the people, were regarded as dangerous persons, who, if they could choose, would prefer a popular government, and were condemned to death in a very summary manner. The reign of the Thirty now began to display all its horrors, and no one could feel safe. To be possessed of wealth, especially in the case of aliens, was sufficient to bring a man to ruin, for the tyrants, independent of all political considerations, began to murder for no other purpose than that of enriching themselves by the confiscation of the property of their victims. The remonstrances of Theramenes against this reckless system of bloodshed were not followed by any other consequences than that the Thirty selected 3000 Athenians who were to enjoy a kind of franchise, and who could not be put to death without a trial before the senate. The rest of the citizens were compelled to give up their arms, and were treated as outlaws. By this expedient the Thirty hoped to strengthen themselves, and to become more independent of the Spartan garrison. The opposition of Theramenes to this arrangement involved his own destruction. [THERAMENES.] The horrors which were now perpetrated became every day more numerous and fearful, and numbers of Athenians fled from their native country to seek refuge at Argos, Megara, Thebes, and other places, where they met with an hospitable and kind reception. The tyrants soon began to be uneasy at the crowds of exiles who thus gathered round the frontiers of Attica, and applied to Sparta to interfere. The Spartans issued a proclamation empowering the Thirty to arrest the exiles in any part of Greece, and forbidding any Greek state to interfere on their behalf. This command was entirely disregarded by the Greeks, especially the Thebans, who even declared that the Athenian fugitives should be received and protected in all the towns of Bœotia. Thebes, whose mode of action was not dictated by a generous and

humane feeling towards the unhappy Athenians rather arose from jealousy of Sparta, thus a rallying point for a great number of exiles, an Thrasybulus was the most enterprising. In the rule of the Thirty Tyrants was at last ended, and the democratical constitution was restored. See the article THRASYBULUS.

(Xenophon, *Hellen.*, ii. 3; Diodorus, xiv Thirlwall, *History of Greece*, iv., p. 174, &c.)

THIRTY TYRANTS (*under the Roman*

This name has been given to a set of usurpers who rose up in various parts of the Roman empire in the reign of Valerian (A.D. 253-260) and Gallienus (261-268). The appellation of the Thirty Tyrants, in imitation of the Tyrants of Athens, is highly improper, and bears no resemblance to the Thirty of Athens. They rose in different parts of the empire, assuming the title of emperor, in irregular and unconnected ways, and were put down one after another. They moreover does not amount to thirty, unless we include the children, who were honoured with the imperial title. Trebellius Pollio, who, in his work *Triginta Tyranni*, describes the adventures of each, has taken great pains to make out that there were only ninety-three persons,—Cyriades, Macrianus, Balista, Odenobius, in the eastern provinces; Posthumus, Victorinus and his mother Victoria, Marius, in Gaul, Britain, and the western provinces; Ingenuus, Regillianus, and Bureolus, in Illyria and the countries about the Danube; Saturninus, in Belgica; in Isauria; Piso, in Thessaly; Valerian, in Aemilianus, in Egypt; and Celsus, in Africa. The majority of these usurpers were persons of low birth, without any talent or virtue, and scarcely any one of them died a natural death. The best among them were Odenathus, and the latter, who maintained himself for many years, received the title of Augustus from the emperor, and was enabled to bequeath his empire to his son, the celebrated Zenobia.

(Trebellius Pollio, *Triginta Tyranni*; Gibbon, *History of the Decline and Fall*, chap. x.; Manso, *Histoire de Constantin des Grosses*, p. 433, &c.)

THIRTY YEARS' WAR is the name of a remarkable contest which lasted from 1618 to 1648, between the emperor and the Roman Catholic states of Germany on one side, and the Protestant states, with their allies, on the other. It was marked by the most sanguinary and afterwards Sweden and France, on the one side. Spain, Holland, and Transylvania also took part in it, but their interference was less direct. This long war has generally been considered a religious war, but indeed its origin in religious differences, and its continuation afterwards became the real motive of the warring parties, and religion was used to veil the ambition of the leaders, and to keep up the enthusiasm of the people. The Thirty Years' War arose out of the political and religious confusion into which the empire was thrown by the Reformation, and was the beginning of the seventeenth century had been inextricable, that a civil war, without foreign interference, became apparently the shortest if not the only way to save Germany from ruin.

In order to facilitate the understanding of the Thirty Years' War, we shall first give a short sketch of the state of religious and political affairs in Europe during the latter part of the sixteenth century.

When the war between Charles V. and the Protestants of Saxony was terminated by the treaty of Passau (1562), and after the conclusion of the Second Peace of Westphalia (1648), the memory of the dangers from which the empire had escaped preserved the empire during a long period from the calamity of a new religious war. The religion was propagated, without any violence, in the provinces which had until then been faithful to the emperor, early as 1580 the most powerful hereditary empire, except the archdukes of Austria and the electors of Bavaria and of Cleves, were all converted to the religion of Luther; the Roman Catholic princes, and even the emperor Ferdinand I. and Maximilian II., were obliged to make many concessions in religious matters in order to keep their subjects in obedience.

By the Second Peace of Religion the prince was required the 'ius reformandi,' that is, the right of p

ists in religious affairs, which right was gradually by them as a right of reforming the state of For this purpose the Roman Catholic princes he Jesuits and the Capuchins; the Jesuits were he conversion of men distinguished by birth, dge, or by their social position, and the Capu- ed upon the mass of the people. Their zeal s occasioned bitter complaints among the Pro- ho however gave causes of complaint equally nd equally well founded to the Roman Catho- dissatisfaction of the people was augmented by policy of their princes.

esiastical dignity of a bishop having lost all its n in the Reformed religion, the Protestant came mere temporal princes. Among their re the archbishops and bishops of Bremen, of s, of Verden, of Lübeck, of Osnabrück, of of Halberstadt, and of Minden. There being, at time, some hope that the Protestant bishops me hereditary princes in their bishoprics, the tholic bishops of Münster, of Paderborn, of 1, and the elector archbishop of Cologne, mani- ir intention to adopt the Protestant faith. 'emselves of the privilege granted them by 'eformandi,' they encouraged their subjects to Protestant religion. The Roman Catholic princes their power to prevent such changes, but the princes favoured them, and each party had its doing so, as the younger sons of the princes and both parties were usually appointed bishops, l canons.

Roman Catholic party recovered its political influ- rds the end of the sixteenth century. The elector archbishop of Cologne, Gebhard, count ss, was driven from his see, and his successor, e of Bavaria, who held together the bishoprics e, of Liège, of Münster, and of Hildesheim, the Protestants in all his extensive dominions. s of Würzburg and of Bamberg, assisted by the mpelled their Protestant subjects to emigrate, rchbishop of Salzburg treated the Protestants rd-of cruelty. In Strassburg there were at the a Protestant and a Roman Catholic bishop, a bloody feud, were both sustained by the udolph II. in those parts of the bishopric y had conquered (1593). The Roman Catholic re equally persecuted by the bishops of Halber- of Osnabrück, and the troubles were increased ferences which arose in the Protestant party een the Lutherans and the Calvinists.

ler of the Calvinists was the elector palatine IV., who, with a small number of Calvinist fused to appear at the diet of Regensburg ich was assembled by Rudolph II. for the pur- taining the assistance of the empire against the ederick and his party declared that they would udolph in the Turkish war, unless he satisfied ims of the Protestants, and at the same time sed a subsidy of 400,000 gulden to Henri IV. if he would restore the Protestant bishop of to the entire bishopric. The Lutheran princes the utmost indignation at the treacherous con- ederick IV., and they sent their contingents to sh war. But from that moment there was a rty among the princes of the empire, and we wards see how dexterously France managed her ver Germany.

t at Regensburg was dissolved in 1608 without ; with respect to the peace of the empire. The tholic states claimed the restitution of all the ter- shoprics, abbeys, and churches, which had been he Protestants since the treaty of Passau (1552); were the Protestant, and especially the Calvinist, m yielding to these claims, that they resolved to y by every means in their power. For that pur- concluded the 'Protestant Union' on the 4th of 3, of which however the elector of Saxony de- become a member. The elector palatine Fre- , a Calvinist, was the leader of the Union. The of the Union immediately levied troops, and ssadors to England, France, and Venice, thus e example of a well-organized rebellion, and C., No. 1535.

showing that they would resist the emperor and break the constitution of the empire with the assistance of foreigners.

The confusion of political and religious interests in- creased after the death of John William duke of Jülich, Cleves, and Berg (1609), one of the most powerful princes of the Roman Catholic party. The succession to his rich and extensive territories was disputed between John Sigismund, elector of Brandenburg, a Lutheran; the count palatine of Neuburg, Philip Louis, a Calvinist; and Christian II., elector of Saxony, a Lutheran, but a friend of the emperor. Alarmed by this latter circumstance, the elector of Brandenburg and the count palatine resolved to govern those duchies in common, until they could find an opportunity to settle this affair; and they immediately took possession of Jülich, Cleves, Berg, and the dependent counties. This act was declared by the emperor to be a breach of peace; he ordered the vacant inheritance to be sequestrated, and he appointed Leopold of Austria, bishop of Strassburg and Passau, to carry the measure into effect. He was assisted by the whole Roman Catholic party, which, alarmed at the loss of such a powerful member as the duchy of Cleves, concluded a union, to which they gave the name of the 'Liga' (11th July, 1609). This Liga was afterwards the strongest support of the emperor during the Thirty Years' War; Maximilian, duke of Bavaria, was at the head of it. But as early as the 11th of February, 1610, the Union concluded an alliance with Henry IV. of France, and occupied the bishoprics of Würzburg and Bamberg. French troops entered the duchy of Jülich. King Henry seemed to have found an opportunity of carrying into effect his plans of a European republic, but he was murdered on the 14th of May, 1610. Frederick IV. died only five months later, and the Union concluded a peace with the Liga at Munich on the 24th of October, 1610. In the mean time a deadly personal animosity had broken out between the elector of Brandenburg and Wolfgang William, the son and successor of the count palatine Philip Louis, owing to their common government in the states of the late duke of Cleves. Wolfgang William, in order to obtain assistance against Brandenburg, adopted the Roman Catholic religion; and the elector of Brandenburg made himself a Calvinist for the purpose of obtaining the assistance of the Union, which was chiefly composed of Calvinist princes. The confusion which arose from these sudden changes became still greater by the interference of the king of Spain, Philip III. This king became afraid of new religious troubles in his provinces of the Nether- lands, situated on the boundaries of the duchies of Cleves and of Jülich, and he therefore ordered his general, Spinola, to occupy them for the count palatine with a body of 30,000 Spaniards. But no sooner had his army entered these territories than the United States of the Netherlands, then at war with Spain, sent troops into the same countries under the pretence of occupying them for the elector of Brandenburg (1614). This was the first example of a war between foreign powers being carried on in Germany.

The empire was now on the eve of a general war. It was generally expected that it would begin on the banks of the Lower Rhine, but, on the contrary, it broke out in Bohemia.

By a solemn declaration of the emperor Rudolph II., liberty of religion had been granted to the Utraquists, a numerous Protestant sect in Bohemia (9th of July, 1609). The document containing this declaration had the name of the 'Majestäts-Brief.' Civil troubles having broken out in Bohemia, and Rudolph II. having taken arbitrary mea- sures to put an end to them, the Bohemians deposed him, and chose his brother Matthias king in his stead, in 1611. Rudolph II. died of grief in the following year, and Matthias likewise succeeded him on the Imperial throne (1612). The number of Lutherans and Calvinists having greatly increased in Bohemia, they claimed the same religious liberties with the Utraquists. Matthias refused to yield to these claims, and serious differences arose between him and the Lutheran and Calvinist Bohemians. They were joined by the Utraquists, who were afraid the emperor might abolish the 'Majestäts-Brief.' Matthias sent commissioners to Prague, who assembled the deputies of the Bohemian states in the royal castle of the Hradshin, and declared to them that their king and emperor would not extend the 'Majestäts-Brief' to the Lutherans and

Calvinists. Suddenly an armed party of Bohemian nobles, who belonged to the Utraquists, rushed into the room where the commissioners and the deputies were assembled. They seized two of the commissioners, the counts Martinitz and Slavata, who were detested in Bohemia, and they and their secretary Fabricius were precipitated from the windows, a height of eighty feet; but a heap of dung preserved them from being dashed to pieces, and they all escaped and hastened back to Vienna.

This happened on the 21st of May, 1618, and this day is justly regarded as the beginning of the Thirty Years' War.

The conduct of the Bohemians towards the Imperial commissioners was by no means an act of rashness or anger. The party of the Utraquists had previously resolved upon it, because they wanted to give the signal for an insurrection which had been secretly prepared among all the Protestants of Bohemia and her dependent provinces Moravia, Silesia, and Lusatia, as well as among those of the archduchy of Austria. The insurgents immediately organized a regular administration of the kingdom. They also levied an army, which was commanded by the count of Thurn, and which was reinforced by a body of the troops of the Union, commanded by Christian, prince of Anhalt, one of the greatest intriguers of his time. The emperor Matthias died soon afterwards (20th of March, 1619), and Ferdinand II., archduke of Austrian Styria, succeeded him as emperor. Previously to the event of the 21st of May, 1618, Ferdinand had been crowned as future successor of Matthias in Bohemia.

The leaders of the Union encouraged the Bohemians to further resistance. Although Ferdinand II. promised religious liberty to all the Protestants of Bohemia, they nevertheless sent their troops against him, and declared the throne vacant. Frederick V., elector palatine, the son-in-law of James I. of England, was chosen king of Bohemia, and he was crowned at Prague on the 4th of November, 1619. In the mean time the count of Thurn had made great progress in Austria. In the month of July, 1619, he was under the walls of Vienna, and, although this city was relieved, he remained with his army in the adjacent country. There he was joined by Betlen Gabor, the sovereign prince of Transylvania, who had overrun Hungary and who took up his winter-quarters in Moravia, together with the count of Thurn. In the same winter (1619-1620) the new king of Bohemia made a defensive and offensive alliance with the Protestant insurgents of Hungary, and he proposed a similar alliance to Sultan Ahmed I. This imprudent and unpatriotic policy made his cause unpopular among all parties in Germany.

Ferdinand II. took vigorous though arbitrary measures to recover Bohemia and her dependencies, those extensive and rich countries which are now inhabited by upwards of ten millions of inhabitants. The pope, Spain, Bavaria, and even the Protestant elector of Saxony, promised their assistance to the emperor. In the autumn of 1620 the Lower Palatinate was occupied by the Spaniards under Spinola; the duke of Bavaria overran the Upper Palatinate and entered Bohemia; John George, elector of Saxony (since 1611), conquered Lusatia; and Austria was rescued by the emperor himself, who had made peace with Betlen Gabor. At last the Bavarians, commanded by their duke and the celebrated Tilly, forced the Bohemians to make a stand on the Weisse Berg under the walls of Prague. There they were completely defeated on the 8th of November, 1620. Frederick fled from his capital, and after a short stay in his second capital, Breslau, he abandoned his kingdom and took refuge in Holland. Towards the close of 1621 Bohemia, with all her dependencies, was in the hands of the emperor, who rewarded his ally, the elector of Saxony, with the province of Lusatia. He punished the Bohemians severely. A great number of nobles were beheaded, and their estates, as well as those of a still greater number of fugitives, were confiscated; but an amnesty ('quoad vitam et honorem') was given on the 4th of May, 1622, to all those who had not been condemned before that day. The Lutheran and Calvinist ministers were banished, and their churches were shut up; but not those of the Utraquists, notwithstanding the 'Majestäts-Brief' was abolished. The Roman Catholics were restored to all their rights; and the university of Prague and the whole national education were put under the direction of the Jesuits. The emperor then put king Frederick under the

ban of the empire, declared his electorship to be forfeited, and proposed the duke of Bavaria to be chosen elector. This proposition however gave dissatisfaction to the other electors, who considered the banishment of Frederick as illegal because the council of the electors had not formally pronounced it according to the constitution of the empire.

The power of the emperor increased so much by the conquest of Bohemia, and the Roman Catholics were so much encouraged, that they closed up many of the abbeys, and churches which had been reserved for the Protestants since the Second Peace of Religion.

Before the fate of Bohemia was decided, Christian, king of Denmark and duke of Holstein, several northern Germany, and the ambassadors of Sweden, and the United States of the Netherlands, met at a congress at Segeberg in Holstein for the purpose of forming an alliance against any ambitious scheme of the emperor. After the battle on the Weisse Berg, Frederick also came to Segeberg, and claimed the support of the northern princes in order to recover his own interests. These princes however had assembled for their own interests. The bishoprics of Lübeck, Verden, of Schwerin, of Halberstadt, and had been bestowed on younger sons of the king of Holstein and of Brunswick, and they would not have them if the Roman Catholic party had taken them. Frederick therefore found only Christian, duke of Brunswick and Halberstadt, an unprincipled man, who loved his own land, the wife of the unhappy king of the Palatinate, who swore he would die for her. With a small army he entered the Palatinate. He was beaten by Mansfeld (6th June, 1622). Christian now joined Mansfeld, a man not less unprincipled than Christian, who retired to northern Germany as far as he could. They plundered and robbed friends as well as enemies, but, pressed by Tilly, they disbanded their troops and fled to England (December, 1623). Mansfeld, having been chosen elector at the diet of Speyer, was being then in possession of several northern German cities. King Christian concluded an alliance with the United States of the Netherlands for the purpose of obtaining subsidies for the war which he had declared against the emperor. Christian of the Palatinate and the count of Mansfeld promised their assistance. The former went to France and levied troops there. Mansfeld, who had obtained a commission as an Imperial general, levied a strong force in England. They were sent to the Netherlands, and, after many adventures, Mansfeld succeeded in joining the duke of Brunswick, who was an ally of the king of Denmark. The latter king had been appointed commander-in-chief of the united forces of the circle of Lower Saxony. The greater part of the princes of this circle afterwards made their peace with the emperor, and Tilly advanced into Hanover, where Tilly was ready to enter (1625).

The emperor was then in a very embarrassed situation. The war in northern Germany was carried on by the troops of the Liga, and principally by those of Bavaria, commanded by Tilly, who was at the same time commander-in-chief of the forces of the Union. The duke of Bavaria had consequently an immense influence in public affairs; the emperor was obliged to cede to him the revenues of a part of his archduchy of Austria as an indemnification for his expenses in the Bohemian war, and to appoint him his high commissioner in the electorates of the Palatinate. On the other side, Ferdinand II. was threatened by the count of Mansfeld, who was then at the head of a strong army in the duchies of Mecklenburg, and who was ready to invade Lusatia and Silesia, and to join Betlen Gabor, prince of Transylvania. This prince had again taken arms against Austria, and there was only a small body of Imperial troops to check him.

Albrecht of Waldstein [WALLENSTEIN], the hero of the Thirty Years' War, saved the emperor and preserved the empire. Known as a skilful general, and in possession of very large estates, he was created duke of Friedland in 1624. In 1625 Ferdinand II. appointed him commander-in-chief of an Imperial army which did not exist, but which was created by Waldstein in a very short time.

Waldstein advanced towards the Lower Elbe, and took a fortified position at Dessau. There he was three times attacked by Mansfeld. On the 1st and on the 11th of April, 1626, Mansfeld was beaten; on the 25th of the month he was put to the route. He reinforced his army in Mecklenburg, and in June invaded Silesia with 10,000 men, in order to join Betlen Gabor. Waldstein marched in a parallel direction, and weakened his enemy by skirmishes. On the 8th of September Mansfeld was on the banks of the Waag in north-western Hungary, with only one-fourth of his army, while Waldstein with fifty thousand men stood between him and Betlen Gabor. This prince made peace with the emperor, and Mansfeld, leaving the remainder of his army to the command of John duke of Saxe-Weimar, fled to Venice, but died on the way, in a village in Dalmatia. Christian of Halberstadt, a fellow-adventurer, had died before him, in the 27th of his age.

While Waldstein was victorious in eastern Germany, he carried on the war in the country west of the Elbe against the king of Denmark. In consequence of a fall from horse, which had affected King Christian's mind to an alarming degree, he firmly believed that God had chosen him to be the champion of the Protestant religion. But his army was destroyed by the skilful manoeuvres of the king, and at last the king was obliged to make a stand at the battle of Barenberg, between Goslar and Hildesheim. A battle ensued, in which the Danes were completely routed (17th of August, 1626), and Christian fled beyond the Elbe into his dominions.

Christian employed the following year (1627) in besieging the towns on the left side of the Elbe, which were occupied by Danish garrisons. In the month of July he was joined by Waldstein, who, after his victories over Mansfeld, had driven the Danes from the countries west of the Elbe. Waldstein, after having put the dukes of Mecklenburg to flight, attacked the king of Denmark, who had assembled a new army (1628), and in one campaign his troops conquered all the continental possessions of Christian IV., who was compelled to beg for peace before the end of the year. A congress assembled at Lübeck, and on the 22nd of May, 1629, Waldstein granted peace to the king of Denmark, on conditions unexpectedly favourable: Jutland, Sleswick, and Holstein were restored to Christian, who promised not to interfere in German affairs nor to make any further claim on bishoprics in behalf of his kinsmen. Immediately after the peace of Lübeck, Waldstein was invested with the duchies of Mecklenburg, the dukes having previously been dispossessed and put under the ban of the empire for their adherence to the king of Denmark.

One of the most remarkable events in the Danish war was the siege of Stralsund on the Baltic, a town which belonged to the Hanseatic confederacy, though it was subject to the duke of Pomerania. Stralsund being occupied by a Danish garrison, it was besieged by the troops of Waldstein, who conducted the siege during the months of June and July, 1628. On the 14th of July the town capitulated; but before the Imperial troops had taken possession of it, a Swedish fleet appeared off Stralsund, and landed a strong body of troops, who took possession of the fortress. Although the inhabitants of Stralsund had professed obedience to the emperor, the Imperial troops were not allowed to enter the town, which remained under the command of a Swedish general. Of this most unfair and interfering interference on the part of the Swedes, Waldstein was previously aware; and this was one of the reasons why he allowed such favourable terms to the king of Denmark at the peace of Lübeck; another cause was a daring design of the emperor on the liberty of the Protestant religion. Encouraged by the success of his armies, and misled by imprudent counsellors, Ferdinand I., on the 6th of March, 1629, issued the 'Edictum Restitutionis.' By this edict he deprived the Calvinists of their religious liberties; and he declared that, conformably to the Peace of Religion, all the bishoprics, abbeyes, and arches which had been taken from the Roman Catholics since that peace should be restored to them; and that the Roman Catholic possessors of Protestant territories should not be hindered from the enjoyment of the privileges granted by the 'Jus Reformandi.' The ecclesiastical territories which had been ceded to members of the house of

the elector of Saxony, who was still an ally of the emperor, were alone excepted from this ordinance. If the 'Edictum Restitutionis' had been executed, a general civil war would have been the immediate consequence; but it met with much opposition. Only a few Protestant bishoprics were conferred upon Roman Catholic princes, and the legal execution of the Edict was made dependent upon the arbitration of a general meeting of all the states. This meeting was called the 'Day of Composition,' and was fixed for the month of February, 1631.

The religious troubles seemed now to be nearly at an end. All the states of Germany wished for peace; and all hoped that this peace was to be settled on the 'Day of Composition.' The Protestant party was still powerful enough to obtain favourable conditions for their religion. The emperor's power had much increased, but the ambition of his counsellors and the haughtiness of his generalissimo, Waldstein, met with vigorous opposition among the members of the Liga, who obliged the emperor to deprive Waldstein of his rank as commander-in-chief of the Imperial forces (1630). Foreign interference was not at all necessary. But foreign interference was nevertheless prepared by France and Sweden.

Gustavus Adolphus, king of Sweden, was master of all the countries which lie around the northern and eastern parts of the Baltic, and his favourite plan was to make this sea into a Swedish lake. He was also a pious man, and sincerely attached to the Protestant faith. Deeply afflicted by the dangers to which this religion was exposed in Germany, he formed the plan of becoming its protector, and he pursued this plan with the more zeal and perseverance, as he was convinced that by becoming protector over the Protestant religion he would also become master of the Baltic. Immense influence in Germany, and the possibility of being raised to the dignity of emperor, would have been the consequence of success in either of his ambitious designs. (Extracts of documents contained in Breyer, *Beiträge zur Geschichte des Dreissigjährigen Krieges*, pp. 210, 219, 221, 252.) France, then weakened by civil troubles, was unable to interfere directly in the German war, and her minister, Richelieu, employed every means in his power to persuade the king of Sweden to make the first attack. Gustavus Adolphus being then at war with the Poles, Richelieu tried to negotiate a truce between the belligerent parties; but the emperor, anxious to prevent any such peace, sent his general, Arnheim, to Poland, with those troops who had been employed in the siege of Stralsund. Although the Swedes had first violated the German territory by occupying that fortress, they nevertheless considered the assistance which the emperor gave to the Poles as a declaration of war. But, instead of attacking the hereditary states of the emperor on the Polish frontier, Gustavus Adolphus, by the mediation of the French ambassador, Charnacé, made a truce with the king of Poland for six years, at Altmark, in the month of September, 1629. He then made great preparations for an attack on the German countries along the Baltic, and ordered his fleet to blockade the towns of Wismar and Rostock in Mecklenburg, which were occupied by the troops of Waldstein. The king of Sweden was the more active because he was checked in his designs on the Baltic by Waldstein, who had assumed the title of Imperial admiral of the Baltic, and who, by means of the Hansatic towns, wished to restore the supremacy of the German navy in the northern seas. But, having been deprived of his military command by the emperor in 1630, Waldstein saw himself compelled to defer the execution of these gigantic plans.

French subsidies enabled Gustavus Adolphus to be ready for the new war as early as the spring of 1630. On the 24th of June he landed 16,000 men on the island of Usedom, on the coast of Pomerania. He styled himself Protector of the Protestant Faith, and came to Germany at a moment when the princes were assembled at Regensburg for the purpose of settling their religious affairs, and when the Protestant party itself had sufficient power to protect its faith. The first act of Gustavus Adolphus was to compel Bogislav XIV., duke of Pomerania, a Protestant prince, to appear in his camp, and to surrender to him his capital, Steffin, a town equally important by its fortifications and by its situation near the mouth of the Oder. He then gradually occupied all Pomerania, and on the 13th of January, 1631, concluded a treaty with France, by which

he engaged himself to carry on the war against Austria with 16,000 cavalry and 30,000 foot, on the condition of an annual subsidy of 400,000 thalers. Meantime he summoned the Protestant princes to join him, but when assembled at Leipzig (10th of February to 12th of April, 1631) they declared the king of Sweden an intruder, and they promised to assist the emperor with all their forces. George, duke of Brunswick Lüneburg, was the only prince who joined the Swedes, in the hope of obtaining some ecclesiastical territory as an addition to his hereditary states. Thus deceived in his hopes, the protector of the Protestant faith attacked George William, elector of Brandenburg, who was his brother-in-law and one of the first Protestant princes of the empire. He compelled him to surrender his fortress of Spandau, and he then made an alliance with the city of Magdeburg.

This rich and populous Imperial town joined the Swedish party for the purpose of escaping the danger of being occupied by the Imperialists, who were ordered to defend that fortress against the Swedes. For this conduct Magdeburg was put under the ban of the empire. Tilly having been charged to execute the ban, and to take the town by force, the citizens of Magdeburg hoped to be rescued by the king of Sweden, who had promised his assistance, but Gustavus durst not advance as far as the Elbe, unless his rear was secured by an alliance with the electors of Brandenburg and of Saxony. Magdeburg was taken by storm by Tilly and Pappenheim, whose troops plundered the town during three days and destroyed it by fire (20th of May, 1631). The unhappy fate of this opulent town was made the subject of a charge against the king of Sweden, who however had gained such influence over the princes of northern Germany, that his political credit was in no way weakened by this event. He forced the elector of Brandenburg to conclude an alliance with him; he drove the Imperial garrisons from Mecklenburg, and restored the dukes; and he ravaged the electorate of Saxony until the elector surrendered his towns, and concluded a defensive and offensive alliance with Gustavus Adolphus (14th of September, 1631). Previously to this, William V., landgrave of Hesse-Cassel, had voluntarily attached himself to the Swedes, for the sole purpose of profiting by the confusion into which the empire was thrown by their interference. Bernhard, duke of Saxe-Weimar, offered his services as general to Gustavus Adolphus, and he was immediately put at the head of a part of the Swedish army.

While the king of Sweden thus had his power increased by the forced or voluntary adherence of the princes, Tilly reinforced his army, and occupied Leipzig. But on the 17th of September, 1631 (N. S.), Tilly lost the battle of Leipzig against the united forces of the Swedes and Saxons; and such was the disorganization of the Imperial army, that Gustavus Adolphus found no enemy to oppose his march to southern Germany. However, instead of invading the hereditary states of the emperor, the king of Sweden conquered the bishoprics of Würzburg and Bamberg in Franconia, which he intended to keep for himself. He then took the archbishopric of Mainz and the Palatinate, but did not restore it to its legitimate master, the banished king of Bohemia, Frederick V. At last he marched to Bavaria, and forced his way across the Lech after a bloody victory over the Bavarians, who lost their general, Tilly (5th of April, 1632). Augsburg, a free Imperial town, was forced to pay homage to Gustavus Adolphus, who on the 7th of May made his entrance into Munich, the capital of Bavaria. During this time the Saxons, the compulsory allies of the Swedes, had occupied a considerable part of Bohemia and Silesia. The great designs of Gustavus Adolphus now became manifest. He proposed to George William, elector of Brandenburg, that Frederick William, the elector's son, should marry his only daughter Christina. Frederick William was thus to become master of Sweden, Finland, Ingermannland, Esthonia, Livonia, Curland, Prussia, Brandenburg, Mecklenburg, Pomerania, of the bishoprics of Bamberg, Würzburg, Mainz, Magdeburg, Halberstadt, Speier, and Worms, of the Palatinate, and of all the countries which the king hoped to conquer in southern Germany. But this brilliant offer was refused by George William. It is said that this prince, who was a zealous Calvinist, would not allow his son to become a Lutheran. But another condition of this marriage being to assist the king of Sweden in his designs on the Imperial crown, it

seems that the elector refused the proposal, because would not make himself the instrument of Swedish ambition.

The emperor was then in the utmost extremity. He had no army to oppose to the Swedes, and if he had had one, the only general who, after Tilly's death, was able to lead it with success against Gustavus Adolphus, Waldstein had been deprived of his rank as commander-in-chief, and had become a deadly enemy of the emperor. Johann was obliged to humiliate himself before him, and at last Waldstein consented to resume the command of the Imperial army, not as its general, but as its chief and independent master. This army however did not exist, but was to be created by Waldstein.

When Gustavus Adolphus occupied Munich, Waldstein had already levied a strong body of troops, with which he expelled the Saxons from Bohemia. The defeat of his ally obliged the king of Sweden to relinquish the attack on Austria, to leave Bavaria, and to hasten to the assistance of Saxony, then exposed to the victorious Imperialists. He made a stand at Nürnberg, in order to observe the Imperial army (January, 1632). In the month of July Waldstein arrived at Fürth, near Nürnberg, and took up a strong position, by which he checked the king, and intercepted the supplies of provisions which were destined for the Swedish camp. Gustavus Adolphus assaulted the camp of his adversary on the 24th of August, but his troops were driven back with great slaughter; and the king, seeing his army exposed to hunger and disease, left his camp on the 8th of September, and retired to Saxony. Waldstein followed him, and in the month of October both the armies were in Saxony. Waldstein divided his army into two bodies, in order to enter into winter-quarters, thinking that the king of Sweden had renounced hostilities for that winter. But on the 6th of November he was suddenly attacked by the Swedes at Lützen, a small town in the environs of Leipzig, and he lost the battle in consequence his army having been separated from the rest. This victory however was fatal to the Swedes, on account of the death of Gustavus Adolphus, who was killed: the battle was gained by Bernhard, duke of Saxe-Weimar, who immediately took the command of the Swedish army. Waldstein retired to Bohemia, where he remained inactive, although he soon repaired his losses at the battle of Lützen.

The death of Gustavus Adolphus did not lessen the power of the Swedes, nor change their politics: the chancellor Oxenstierna directed their affairs with the same care and the same skill as the late king; and the new generalissimo, Bernhard of Saxe-Weimar, was one of the most distinguished captains of his time. In 1633 Oxenstierna concluded an alliance with the states of the circles of Swabia, of Franconia, of the Upper Rhine, and of the Lower Rhine, and duke Bernhard got possession of Regensburg. Waldstein however destroyed the Swedish army in Silesia, conquered Lusatia, and entered into negotiations for the purpose of concluding a separate peace with Brandenburg and Saxony, those compulsory allies of the Swedes, who were afraid of the dangers to which Germany was exposed by the Swedish protection of the Protestant church. But Waldstein, whose pride became insupportable, and whose policy was crooked, was accused of high treason by his numerous enemies; and he was assassinated in the midst of his army, on the 25th of February, 1634. Ferdinand of Austria, the son and heir of the emperor, succeeded Waldstein as commander-in-chief of the Imperial and Bavarian armies: his lieutenants were Gallas and John von Werth, both experienced generals. Reinforced by a corps of Spaniards, he attacked the Swedes at Nördlingen, on the 7th of September, 1634. The Swedes were routed, their general, Horn, was made prisoner, and southern Germany fell into the hands of the Imperialists, who, though they exacted heavy contributions from the Protestant inhabitants, respected the liberties of the Protestant church. The Protestant princes of southern Germany, who hoped to aggrandize their states by means of the Swedes, were disappointed by the defeat of their protectors: but they found another powerful ally, who was always ready to encourage the German princes in their rebellious undertakings against the authority of their emperor. This ally was France. Löffler, the vice-chancellor of the duke of Würtemberg, and Streif, a privy councillor of the margrave of Baden, negotiated an alliance between them

reigns and France (11th of November, 1634). The king of France being one of the first Catholic princes, he durst not assume the title of protector of the Protestant church, as the king of Sweden had done, and he therefore styled himself the protector of the liberties of the states of Germany against the tyranny of the emperor. His policy was nevertheless severely blamed by his fellow-believers. Jacob Keller, a German Jesuit, wrote a book concerning the policy of Louis XIII., who, at the same time, protected the Protestants in Germany, and persecuted them in his own kingdom; but this book was burnt in Paris by order of the Sorbonne. Duke Bernhard of Saxe-Weimar at the same time having sold himself and his country to France, Saxony and Brandenburg saw at last that they no longer adherence to the Swedish alliance would be the ruin of themselves and of all Germany. Saxony concluded a peace with the emperor on the 30th of May, 1635, at Prague; and Brandenburg gave in its adherence to this peace on the 27th of August following: the favourable conditions which they obtained proved that the emperor had given up all schemes of oppressing the Protestant church. The landgrave of Hesse-Darmstadt, the dukes of Hesse-Cassel, of Brunswick, and of Saxe-Weimar (duke William), the cities of Frankfurt, of Erfurt, &c., the Hanse towns, and at last the whole circle of Lower Saxony, became parties to the peace of Prague in the course of the same year. Among all the Protestant states of importance, Hesse-Cassel, Württemberg, and Baden were the only states which continued their alliance with the foreign invaders. This fact also proves that the Swedes had not armed for the sake of the Protestant religion, as they pretended; and that their sole purpose was conquest. If they had taken arms for the liberty of their faith, they would have made that liberty a principle, and they would have withdrawn from Germany as soon as this principle had ceased to be interfered with. Such disinterested conduct is indeed rare in history, and is often regarded as contrary to the substantial welfare of that nation which adopts it. But is the rarity of the fact a proof of its absurdity? To veil ambition with moral or religious pretexts is a common practice, but it deserves to be stigmatized with the name of public hypocrisy; and such was the Swedish interference in the Thirty Years' War.

The most important event from the year 1635 to 1639 was the conquest of Alsace by duke Bernhard of Saxe-Weimar, who hoped to possess that Austrian province as an hereditary duchy. His plans however were contrary to the policy of France, who herself aimed at the possession of Alsace, and had bribed the duke for the sole purpose of employing him as an instrument. No sooner had the duke's intentions become manifest, than he fell suddenly ill, and died on the 8th of July, 1639. His army, a strong and experienced body, was bought by France, who immediately occupied Alsace. The Imperialists however, reinforced by the Saxon troops, gained a victory at Haselünre over the Swedish general Knyphausen, who was killed (December, 1635); and they forced Magdeburg to surrender (1636). They and the Saxons were beaten in their turn at Wittstock by the Swedish general Banér (24th of September, 1636); and duke Bernhard defeated them at Rheinfelden (21st of February, 1638), and made prisoners generals Savelli and the celebrated John von Werth. Previously to this the emperor Ferdinand II. died (15th of February, 1637), and was succeeded by his son Ferdinand III., who had been king of the Romans since 1636. Leopold William, the brother of Ferdinand III., was appointed generalissimo of the Imperial army; and as early as the spring of 1640 he succeeded in driving the Swedes, under Banér, from Bohemia, and he pursued them as far as Hesse and Hanover. In the autumn of 1640 the emperor issued a proclamation, granting to the rebellious Protestant princes a general amnesty and the sovereignty over their temporal dominions on the status quo of 1630, and over their ecclesiastical territories on the status quo of 1627. But these princes treated the proclamation with neglect, still hoping that by their alliance with the foreigners they would acquire some privileges and some little territory more. They sent new contingencies to the army of Banér, who, in January, 1641, advanced as far as Regensburg. He was reinforced by a French corps, commanded by the Marshal de Guébriand, but their united forces were defeated by the Imperialists, and on their retreat they lost

half of their troops. Banér died in the month of May, 1641, and his successor was Torstenson, who led the Swedes to new triumphs.

The war had now lasted for twenty-three years. Swedes, Danes, Spaniards, Dutchmen, Frenchmen, half-savage warriors from Hungary, Transylvania, and Croatia, had ravaged Germany from one sea to the other. Adventurers from all the countries of Europe flocked to Germany to learn warfare, and to enrich themselves by the plunder of the country. The foreigners pretended to protect the churches, but the churches were laid in ruins; they professed to defend the liberties of the cities, but the cities were deserted; they promised to maintain the privileges of the princes, and they robbed them of their dominions, and led them to disobedience and anarchy.

Before the war commenced, the people were told that they were on the eve of a religious contest, but they hesitated to believe it; no deep religious hatred, no fanaticism disturbed their domestic peace. After the war had lasted some years, their passions were roused, and their warlike spirit excited them to take up arms, some for the defence of their hearths, and others to follow Waldstein or any other leader of the time. The pretext which the princes made of religion was shown by their attacks on the property of the church, and thus the people lost their respect for religion. The example of Christian of Halberstadt, of Mansfeld, of Waldstein, who supported their armies by robbing indifferently Roman Catholics and Protestants, corrupted both peasants and citizens; and commerce and industry being ruined, and agriculture becoming an uncertain means of living, they formed bands of robbers, who ravaged the country. From these bands the Swedes recruited their troops, who, after the death of Gustavus Adolphus, were chiefly composed of Germans. The armies presented an aspect like those of the Goths when they invaded the Roman empire. One-third and often only one-fifth of them were soldiers: the remainder were vagabonds, women, and children, who followed the army, carrying with them on carts the property which they had stolen on their march. The greater part of the women were prostitutes, who, in the army of Waldstein, had a perfect military organization. They were divided into regiments, companies, and sections, each body being commanded by a prostitute, and the women having the same rank among these female adventurers which their lovers had in the army. The provinces which were the principal theatre of war were laid waste, and the inhabitants fled, or were killed, or died of hunger and disease. Of 500,000 individuals, the population of the duchy of Württemberg in 1618, only 48,000 remained at the end of the war in 1648.

Torstenson, the new generalissimo of the Swedes, conquered, or rather traversed, in the spring of 1612, Saxony, Silesia, and Moravia, and his light horse appeared in the neighbourhood of Vienna. At the same time the Marshal de Guébriand penetrated into Suabia, in hope of joining the Swedish army under the walls of the emperor's capital. The Imperial generals however succeeded in delivering the hereditary states of Ferdinand; and while Torstenson retired to the north, where his presence became urgent on account of a new war with Denmark, the French army was compelled to cross the Rhine. Guébriand was killed in an engagement near Rotweil, and his successor, the count of Rantzau, a German nobleman in the French service, who had again appeared on the right bank of the Rhine, was surprised by the Imperialists under John von Werth, Mercy, and the duke of Lorraine. The battle was fought on the 24th of November, 1643, near Duttlingen, and the French army was almost annihilated. Christian IV. of Denmark was not more fortunate in his war with the Swedes than he had been against Tilly and Waldstein; but while he was fighting with Torstenson in Jutland, Gallas, the general of the emperor, suddenly appeared in Holstein, with the view of placing the Swedes between two fires. From this dangerous position Torstenson escaped by a bold manœuvre, which he executed with his usual rapidity. He advanced as if to attack Gallas, but suddenly turned to the right, crossed Holstein, and penetrated by rapid marches into the heart of Germany, thus obliging the Imperial army to follow him in order to protect the hereditary states of the emperor. The Swedes often made a stand to engage in skirmishes which proved disastrous to the Imperialists, and Gallas brought only half his army back to Austria. In the mean time

France had levied a new army, which was put under the command of Turenne, and which was reinforced by a body under Louis d'Enghien, afterwards prince of Condé. They attacked the Imperialists under Mercy, who, after a gallant resistance and various success, was at last obliged to retire to the east of the Black Forest, leaving the Palatinate, Alsace, and Baden in the hands of the French (autumn, 1644). The Imperialists were still more unfortunate in eastern Germany. Torstenson defeated them and the Saxons at Jankau in a bloody battle (6th of March, 1645), and their general, Hatzfeld, was made prisoner. In one campaign Torstenson made himself master of Silesia and Moravia, and encamped near Vienna; and his lieutenant, Königsmark, conquered the bishoprics of Bremen and Verden. The elector of Saxony, and the elector of Brandenburg, Frederick William, who had succeeded his father George William in 1640, renounced their alliance with the emperor, and made their separate peace with Sweden; and their example was followed by Maximilian, elector of Bavaria. This hitherto faithful ally abandoned the emperor in 1647, after the victory of Turenne at Allerheim, and after the conquest of Suabia by Turenne, who advanced towards Munich. The defection of the elector of Bavaria excited the discontent of his army, and was considered an act of high treason by his generals. John von Werth, the idol of the soldiers, conceived the plan of putting the Bavarian army under the command of the emperor, and of seizing the elector and his ministers for the purpose of confining them in order to secure their fidelity. The plot was betrayed at the moment when it was to have been carried into effect. But John von Werth escaped, and Ferdinand created him a count of the empire. This event was followed by a victory of the Swedes at Zusmarshausen, near Augsburg (7th of May, 1648). Königsmark, their general, now invaded Bohemia, and on the 31st of July conquered that separate part of Prague which is called the Kleinseite. This conquest was the last important event of the Thirty Years' War, which began and ended at Prague.

Peace of Westphalia.—As early as 1640 the Diet at Regensburg was occupied in putting an end to this awful war, and in 1641 preliminaries were prepared at Hamburg under the mediation of Denmark. Münster and Osnabrück were afterwards chosen for the places of congress, and the meeting was to be held in the spring of 1642, but it was not organised before the spring of 1643. The count of Auersberg was the emperor's ambassador at Osnabrück, where he was to negotiate a peace with the Swedish ambassador, John Adler Salvius; and the count of Nassau met at Münster the count d'Avaux, the ambassador of the king of France. The states of Germany sent likewise ministers or agents to both these towns; ambassadors of Venice and of the pope came as mediators; and Spain and the United States of the Netherlands sent their plenipotentiaries for the purpose of settling their private differences, and interfering in those of Germany. The negotiations lasted three years: the various chances of the war prevented the parties from acting upon an invariable principle, and the troublesome intervention of the German States were an obstacle to private interests being made subordinate to the general interest. At last the count of Trautmannsdorf, 'the most honest among all the ambassadors,' arrived from Vienna with full powers, and on the 14-24th of October, 1648, a double peace was concluded at Münster and at Osnabrück, which was legally considered as one, under the name of the Peace of Westphalia. Previously to this Spain and the United States of the Netherlands had likewise made peace at Münster, on the 20-30th of January, 1648. These are the principal conditions of the peace of Westphalia:—

I. Conditions concerning the cession of territories and rights to foreign powers.

1, Sweden, as an indemnification for her expense in the war and for ceding several of her conquests to their former possessors, acquired Pomerania, except a part of Pomerania Citerior (duke Bogislaw XIV. had died in 1637); the town of Wismar in Mecklenburg; the archbishopric of Bremen, and the bishopric of Verden, as hereditary duchies; a sum of five millions of thalers, which was not to be paid by the emperor, but by those circles where Gustavus Adolphus had promised to protect

the Protestant church. In respect of these Sweden became a member of the empire.

2, France acquired the sovereignty over the 1 of Metz, Toul, and Verdun, the possession of 5 been ceded to king Henry II. in 1556; the 50 over Pignerol; the town of Breisach, and the keeping a garrison in Philippsburg; the lands Upper and Lower Alsace, the Sundgau, and the rights over ten free towns in Alsace, but not over burg. These territories were ceded to France sovereignty, and the king of France consequently become a member of the empire.

3, The United States of the Netherlands and confederacy of the cantons of Switzerland were acknowledged by the emperor as independent states; legally these countries were parts of Germany until the Westphalia.

II. Conditions concerning the cession of territorial rights to members of the empire.

(These indemnifications were effected by the bishoprics and other ecclesiastical territories.)

1, Hesse-Cassel acquired the abbey of Hildesheim of the fiefs of Schauenburg, and six hundred thalers which were to be paid by Roman Catholics.

2, Brandenburg acquired the bishoprics of Minden, and of Camin, as hereditary principalities, and the archbishopric of Magdeburg as an hereditary principality.

3, Mecklenburg acquired the bishoprics of Rostock and of Schwerin as hereditary principalities, and the commanderies of Mönch and Nemerow, which were from the Knights of St. John.

4, Brunswick acquired the convents of Walken and Groningen, and the privilege of appointing a bishop; the reigning house bishop of Osnabrück; on condition, however,—that the bishopric was to be alternately by a Protestant bishop of the House of Brunswick, and by a Roman Catholic bishop, who was chosen by the chapter.

5, The duke of Bavaria was confirmed as elector, and rewarded with the Upper Palatinate and the Palatinate of the Rhine.

6, Charles Louis, the successor of the elector palatine Frederick V., was restored to his principality, except that part of them which was ceded to Brandenburg; the electorship of his father was forfeited, and a principality was created and bestowed upon him.

III. Conditions concerning religion and the constitution of the empire.

The principle of these conditions was an amnesty with regard to those who had rebelled against the emperor, though the word 'rebel' was not used, and the maintaining of the status quo of 1618, the beginning of the Bohemian war, with respect to the constitution of bishoprics, churches, &c., was observed by either of the parties.

A. Religion.

1, The treaty of Passau and the Second Peace of Religion were confirmed.

2, The religious quality of a territory was to be decided after the status quo of the 1st of January, 1624 (N.S.).

3, Equality of political rights between the Catholics, the Lutherans, and the Calvinists or Protestants.

4, The Jus Reformandi was reduced to the meaning as a mere protection of religion. It was checked by numerous and complicated provisions which afterwards led to many complaints.

5, The ecclesiastical jurisdiction of the emperor was conferred upon the Protestant princes as a sovereignty; in the Roman Catholic territories it remained in the hands of the bishops.

B. Constitution of the empire.

1, The princes acquired the right of concluding defensive and offensive alliances with foreign powers, and they became almost sovereign with regard to their subjects.

2, The German empire was changed into a confederacy of almost sovereign states, the emperor becoming a mere director of the public affairs.

conditions concerning the relations between Germany and foreign powers.

The peace of Westphalia was guaranteed by Sweden etc.

The Thirty Years' War was the Peloponnesian War of 1618-48, and by the Peace of Westphalia the German princes prepared the destruction of their independence and the downfall of the empire. The German princes were originally rich landowners appointed by the emperor; high judges (graven, comites) and military commanders (herzoge, duces). From the eleventh century they strove to obtain possession of these functions as sovereign rights. During five centuries they carried on a policy of rebellion against the Imperial authority, and they usurped rights and privileges which the emperor was compelled to confer upon them in due form. The legislative and administrative power became hereditary in the princes. Having succeeded with regard to their rights, they considered the Reformation of Luther an opportunity of usurping ecclesiastical legislation. They wanted to a great number of them by the Peace of Westphalia. Luther's reforms gave birth to the Protestant church, which this faith required to be supported by a church. The Protestant church did not exist before the Peace of Westphalia. It was established by this peace, nor is there a general Protestant church in Germany. The emperor considered himself as legal successor of the pope, and the episcopal rights became a part of political power, and the ministers of the faith gradually became functionaries of the princes. Their first duty was to obey; they not only obeyed, but they crouched before the emperor and their ministers; their abject behaviour was shown by numerous works published during the latter part of the seventeenth century and the eighteenth century. When the people saw the dependence of the minister on the temporal authority, they confounded the emperor's faith with the laws of their princes, and, not recognizing any divine character in these laws, they forgot the origin of their religion. Thus they fell into that indifference concerning religious matters which prevailed in the greater part of the Protestant countries of Germany. This religious state is a consequence of the Thirty Years' War.

The political consequences of that war are still more evident. Germany was a wilderness—its material strength and its political power was broken—its intellectual development was checked—and the fierce and manly character of the nation was broken by their thousand arbitrary laws. They themselves became slaves of the French. They fell into factions by the private interests of the princes, and became the theatre where the armies of all Europe fought the differences of their kings. This state of anarchy lasted a hundred and fifty years, and ended with the restoration of the German empire by Napoleon.

Menzel, *Geschichte des Dreissigjährigen Krieges*, 2 vols. 8vo., Breslau, 1835-37; Breyer, *Geschichte des Dreissigjährigen Krieges nach ungedruckten Quellen*, 1st vol., München, 1811, 8vo.; Breyer, *Beiträge zur Geschichte des Dreissigjährigen Krieges aus bisher unbenutzten Papieren*, München, 1812, 8vo.; Schiller, *Lebensgeschichte des Dreissigjährigen Krieges*: this work, valued by the beauty of its style, contains the most interesting description of the Thirty Years' War; but its value is not very great; Leo, *Lehrbuch der Geschichte*, vol. iii.: the author's description is valuable for the application of philosophical principles to history; Eichhorn, *Deutsche Staats- und Rechts-Geschichte*, vol. iv.: the author starts from a legal point of view; he treats political and religious rights rather as a jurist than as a publicist; Woltmann, *Geschichte des Dreissigjährigen Krieges*, Leipzig, 1808-9, 2 vols. 8vo.; *Acta Pacis Westphalicae publica, oder öffentliche Friedenshandlungen*, Göttingen, 1784-6, 4to.

LE, the common name of *Carduus*, a genus of plants belonging to the large natural order Compositae. The name is of Greek origin, and is found in the time of Theophrastus down to that of Caspar Bauhin. All plants that possessed a spiny involucre were included in the genus *Carduus*. The artichoke and the teasel (*Dipsacus*) were included in it by Linnaeus. Lobelius. Morison confined the genus to

those plants that had spiny scales of the involucre and a crown of feathery down (pappus) surmounting the seed. Plants resembling them, but without a spiny involucre, he called *Cirsium*, and those without the feathery pappus *Carduus improprie dictus*. Tournefort adopted these distinctions. Vaillant defined *Carduus* more accurately, giving it to plants with a globular involucre composed of spiny scales, with compound flowers, tubular florets, stamens united by the anthers, a hairy receptacle, and a hairy pappus on the seeds. If the pappus was feathery, he called the genus *Acama*; and when the receptacle was not hairy, but honeycombed, he used the term *Onopordon*, a name previously applied to thistles by Pliny. When the scales and receptacles were fleshy, he named the genus *Cynara*. Linnaeus adopted these genera, but changed Vaillant's *Acama* into *Cirsium*, a name which had been previously employed by Tournefort for another genus.

The genus *Carduus*, Common Thistle, consists of upwards of 30 species, most of which are inhabitants of Europe. None of them are found in the New World.

C. nutans, Musk-Thistle, has decurrent spiny leaves, with handsome drooping flowers; the scales of the involucre cottony, the outer ones spreading. It is a common plant on waste ground, in dry, stony, or chalky soils, in Great Britain. It gives out, especially in the evening in warm weather, a strong smell of musk.

C. marianus, Milk-Thistle, has spinous leaves embracing the stem; the scales of the involucre leaf-like, recurved and spinous at the margin. It is a native of England; scarce in Scotland. The leaves are distinguished by the milky whiteness of their veins. This milkiness is said, according to an absurd story, to have been produced by a drop of the Virgin Mary's milk, just as the Milky-Way was supposed to arise from that of Juno. This plant is an esculent, and may be eaten young as a salad, or boiled and eaten as greens. The young stalks, when peeled and soaked in water, are also excellent.

The root may be prepared like salsify and skirret, and the receptacle may be cooked and eaten as the artichoke. When cultivated, the seeds should be sown in spring, and the plants kept at a foot and a half distance from each other, and the earth thrown up round them till they are etiolated.

The genus *Cnicus*, Plume-Thistle, is known by the feathery down that crowns the seeds. It is a large genus: nine of the species are inhabitants of Great Britain.

The Cotton-Thistle is the *Onopordon*, which is known by its honeycombed receptacle. The *O. Acanthium* is a British species. The leaves are ovato-oblong, sinuated, spinous, decurrent, and woolly on both sides. It attains a height of from four to six feet. It is cultivated in Scotland as the Scotch Thistle; but it is doubtful whether this national badge has any existing type, as the representations of the Scotch Thistle on ancient wood-carvings, coins, and armorial bearings, differ more from each other than any known species of thistles. The receptacle and stalks of the Cotton-Thistle are sometimes eaten, in the same manner as the artichoke and cardoon. [CYNARA.]

The Carlina Thistle forms the genus *Carlina*, which obtained that name from a tradition that the root of the Common Carlina (*C. vulgaris*) was shown by an angel to Charlemagne as a remedy for the plague which prevailed in his army. The genus is known from the others by the inner scales of the involucre being spreading and membranous, and of a yellow colour. The Common Carlina is a frequent plant in Great Britain on dry hilly pasture and in fields. It is about one foot high.

The Blessed Thistle is the *Centaurea benedicta*, the *Carduus benedictus* of old writers. The involucre of the genus *Centaurea* is not spiny, and the seeds have a very simple pappus, or none. The Blessed Thistle is a native of the Levant, and in the middle ages was held in extravagant estimation on account of its supposed virtues. It is still cultivated in some places on account of its medical properties.

For Sow Thistle, see *SONCHUS*.

Some of the species of thistles are admitted into gardens. They form a pretty variety for borders, and require little care in their cultivation. They sow themselves very extensively by means of their winged seeds. On this account they are great pests to the farmer. In fields the annual kinds may be got rid of by the weeding-hook, but

the perennial kinds must be ploughed and the roots picked out. The *Carduus arvensis* has got the name of Cursed Thistle, on account of the difficulty of eradicating it where it has once grown. Although injurious to man, by exhausting the soil of that nutriment which plants supplying food require, their seeds are generally eaten by birds, and the larvæ of many insects live entirely on their leaves.

THISTLE. The thistle, with its strong prickly leaves and stem, establishes itself in the meadows and corn-fields, when it is not very carefully eradicated, and occupies the place of more useful plants. There are many varieties of the thistle, some of which are not destitute of elegance when in full blossom. Considered as a weed in our fields, our principal object is to eradicate it, which, in consequence of the ready dispersion of the seeds by the wind, is not easily done, as a slovenly farmer may seed the whole country around; and where the thistles are not eradicated from the hedges and sides of roads and paths, it is impossible to destroy them entirely: wherever the soil is newly turned up, especially when it is of a nature where wheat will grow well, thistles invariably arise: hence the saying of the blind man in choosing land, 'Tie me to a thistle.'

Those crops which are usually hoed can readily be cleared of thistles: but where the seed is sown broadcast, the labour of weeding them out is much greater. If they are not extracted with the root, they will soon grow again with redoubled vigour. In a moist season they may be pulled up by means of a wooden or iron forceps, which grasps them strongly near the crown of the root, and, as it has a projection which serves as a fulcrum, a pressure on the handles draws the root out when they are brought together. When a field has been long infested with thistles, the best way of clearing it is to watch when the thistle is in full bloom and the seed is just forming; if it be then cut off at the root it will die. Thus in two years a field may be entirely cleared of thistles.

It is chiefly in arable land that thistles are most troublesome. In pastures it is sufficient to eradicate them once, and to permit none to grow along the hedges and ditches. The seed does not readily vegetate, unless it finds a loose soil; and little birds are so fond of it, that they will leave none that is not covered with earth, especially in the beginning of winter. In some countries there are penalties inflicted on those who allow thistles to remain in their hedges or along the high road which borders their land; and a man may complain to a magistrate of a neighbour who will not destroy the thistles on his land, when the delinquent will be admonished or fined, as the case may require. Such a law would be very advantageous in many parts of the country, where no attention is ever paid to the weeds which grow in the hedges or in waste spots.

THISTLE, ORDER OF THE, an ancient Scottish order of knighthood, sometimes called the order of St. Andrew. The early history of this order is involved in some obscurity, and the most absurd attempts have been made to establish its claim to high antiquity, of which it is sufficient to allude to the legendary account recited in the warrant for the restitution of the order in 1687, and given most minutely by several Scottish antiquaries, attributing its formation to Achaius, king of the Scots, in commemoration of a victory obtained by himself and Hungus, king of the Picts, over Athelstan. Nicolas observes, as a fitting illustration of this legend, that Achaius died upwards of a century before the reign of Athelstan; and he further shows that the thistle was not the acknowledged badge or symbol of Scotland until the latter part of the fifteenth century. Even after it became a national ornament, and formed a distinguishing feature of a collar resembling that now worn by Knights of the Thistle, it is by no means certain that it was considered the badge of an order of knighthood; and the searching investigation of Sir Nicholas Harris Nicolas, which is detailed at great length in the third volume of his recently published 'History of the Orders of Knighthood of the British Empire,' leads him to the conclusion that it is difficult to believe in the existence of the Order of the Thistle, as an organized fraternity, until the reign of James VII. of Scotland and II. of England. Whether it had any such prior existence or not, 'it is admitted,' he adds, 'even by the assertors of the antiquity of the order themselves, that, after the Reformation orders of knighthood being considered in Scot-

land as relics of popery, it fell into desuetude; and frequently it is not pretended that there were any of St. Andrew,' or 'of the Thistle,' after the accession of King James VI., in 1567.' The warrant of James VI. for the re-institution of the 'most ancient and noble order of the Thistle,' which is printed at full length and which asserts that by authentic proofs, documents, records, the order 'continued in great glory and for many hundreds of years,' bears date Windsor 1687; but, although statutes were issued, and candidates were nominated by James II., the patent for the restitution of the order never passed the House of Commons. Owing to the abdication of James, the order remained in abeyance, until it was finally revived by George III. In the warrant of 1687 it is stated that the order was originally of the king and twelve brethren in the Saviour and the twelve apostles, and the same was ordained as the full complement by Anne II. It was not filled up for several years. This continued alteration until July 16, 1821, when, in consequence of the coronation of George IV., an ordinance was issued for the appointment of four extra members, who should come regular knights as vacancies should occur. In May, 1827, the number of knights brethren of the order was extended to sixteen. Originally none but noblemen were admitted to the order; but since the reign of George I. it has also been conferred upon English peers. No foreigners have been admitted to the order; nor have any commoners, excepting a few heirs-apparent to dukedoms. It is usual for a knight of the Thistle to resign the ensigns of the order when he becomes a knight of the Garter, although the statutes contain no provision to that effect; but in a few instances this has been dispensed with, as a special mark of royal favour. The decorations worn by the knights consist of: a collar of enamelled gold, composed of sixteen thistles, with sprigs of rue, fastened to the mantle by a green riband; a small image of St. Andrew, also of gold, suspended from the collar; a medal of gold, having an image of St. Andrew within a circle, containing the motto of the order, 'Nemo mecum in casso' (No one provokes me with impunity); a green riband, to which the medal is attached, and which is thrown diagonally over the left shoulder, and a star, consisting of a thistle enamelled in blue and red colours upon a ground of gold, and surrounded by a wreath of motto and rays of silver. The star is worn on the left shoulder, on a mantle of green velvet, which, with the collar and medal, are minutely described by the original statutes of the order. Although the original statutes of the order, as printed by Sir N. H. Nicolas in 1828, do not strictly define the method of admission, it was ordained by George III. in 1717, that vacancies should be filled up by the chapter of the order; but the usual practice is for the sovereign to appoint to vacancies without the sanction of a chapter. His late Majesty, William IV., retained the practice of election in a chapter of the twelve knights, but it has been again dispensed with by George IV. His Majesty. The officers of the order are the dean, the chancellor, the secretary, the king-at-arms, and the usher, of whom receives an annual salary, and a fee on the occasion of a knight, excepting only the chancellor, who is an officer never having been appointed, although mentioned in the statutes of 1687, 1703, 1717, and 1719. The duties are performed by the secretary. A complete list of knights of the Thistle, from the revival or re-institution of the order in 1687 to 1840, is given in the work above mentioned, from which this brief account is condensed.

THLASPIDEÆ, a tribe of plants of the natural order Cruciferae, having for its type the genus *Thlaspi*, also called *Pleurorhiza*, from having the radical embryo at the side of the cotyledons. The siliqua is with a very narrow dissepiment, and has keeled valves. The seeds are oval, with flat acuminate cotyledons. The principal genera of this tribe are, *Thlaspi*, the Cress; *Iberis*, the Candy-tuft; *Hutchinsia*; and *Buckler-Mustard*. They are most of them insectivorous plants, possessing the acrid biting properties of the order. The genus *Thlaspi* is known by its siliqua emarginate at the apex with the valves winged back; the petals are equal, the pedicels bracteate, and the flowers are white. Some of them, as the *Thlaspi*

Penny Cress, have a strong alliaceous odour. They grow on rocks and barren places, and are frequently found amongst collections of rubbish from mines, &c., and are inhabitants of most parts of the world in cold and temperate regions.

Hutchinsia was named by Sir J. E. Smith after Miss Hutchins of Belfast, who contributed many observations on marine plants to the 'English Botany.' It has an elliptical silicle with wingless valves, equal petals, entire ayes, bractless pedicels, and variously-coloured flowers, it never yellow. All the species are mountainous plants. They possess no active properties, but are pretty little plants, and will grow on rock-work or in small pots. They are best grown in a soil composed of sand, loam, and peat. Annual kinds may be propagated by seeds; the perennials, by dividing the roots or by cuttings.

The Candy-tuft is known by two of its petals being larger than the other two; they are of a white or purplish colour, but never yellow. They are mostly mountainous plants, but grow well in gardens; and, if the seeds are sown at different periods, will blossom all the summer, and even through a mild winter. The shrubby species are also well adapted for rock-work, and may be propagated by cuttings. [IBERIS.]

Discutella has a flat silicle with one-seeded cells, a long permanent style, a compressed seed, and yellow stemless flowers. They are also alpine plants. In the garden they form a pretty variety with the other plants, on account of their yellow flowers. A dry sunny situation in a light sandy soil suits them best. They are best propagated by seeds, and may be kept in blossom during the summer by sowing at different periods of the year.

THOIA, a genus of Polypitaria; included by Linnæus in *Bertularia*.

THOMAS, Θωμάς, ΘΩΜΑ (in Greek, Διδυμος; John, xi. 16; xx. 24), one of the twelve apostles of Christ. (*Matt.*, x. 3.) The Hebrew and Greek names both signify a twin. St. Thomas is presumed to have been a Galilean; but no particulars of his birth-place or call to the apostleship are given, and the first notice of him individually is in *John*, xi. 40. Christ having expressed an intention of returning to Judæa, in order to raise his friend Lazarus from the dead, Thomas encouraged the other apostles to attend him, although he regarded death as the certain consequence of this step. The impulsiveness of character thus indicated was not long after very differently displayed. Thomas happened to be absent when Christ, after his resurrection, first appeared to the apostles; and when made acquainted with the fact, he expressed an incredulity which could only be satisfied by the manual evidence of inserting his finger in the holes which the spear and the nails had made in the body of his crucified master. Eight days after, when Christ again appeared, Thomas was present; and the reaction in his mind was very strongly expressed by him, when he was pointedly called upon by Jesus to stretch forth his hand and take the desired proof. (*John*, xxi. 24-29.) Thomas is not again mentioned in the New Testament. Doubtless he laboured, like the other apostles, in the propagation of the Christian doctrines: and ecclesiastical traditions make him one of the apostles of the Gentiles. It is alleged that he travelled eastward, and laboured among the various nations which then composed the Parthian empire. (*Euseb.*, iii. 1; *Rufin.*, x. 9; *Recognit.*, ix. 29.) There is a singular concurrence of Oriental and Western testimony (which may be seen in Assemani and Baronius), to the effect that St. Thomas extended his labours farther eastward, and then southward, until he reached the coast of India and Malabar, where, having exercised his apostolic labours with success, he passed on to the coast of Coromandel; and having made great conversions to the faith in those parts, he proceeded over to some coast on the east, called China (which may possibly have been the country now called Cochin-China), and afterwards returned to Coromandel, where, having suffered martyrdom, he was buried in the mount since called St. Thomas's Mount.

In the quarters indicated there are Christian churches which bear the name of St. Thomas, and claim him for their founder. If they derive their existence as a church uninterrupted from the apostolic age, this fact may be taken as a corroboration of the above traditions. But if the P. C., No. 1536.

effects which resulted among them from the labours of Mar Thoma and other Nestorian missionaries, at the commencement of the sixteenth century, were really an original conversion, or at least a re-conversion, and not, as is often supposed, the revival of a fallen but not extinct church—then this claim is to be regarded only as an echo of the tradition which has always prevailed in the Syrian churches, and which must be estimated by its intrinsic probability and value.

(Besides Assemani and Baronius, see Tillemont, i. 397, sq.; Cave's *Antiq. Apostolicæ*; Winer's *Biblisches Realwörterbuch*, art. *Thomas*; Buchanan's *Christian Researches*; Yeate's *Indian Church History*; and Principal Mill's *Letter to the Society for the Propagation of the Gospel* (July 29, 1822), inserted in *Christian Remembrancer* for Nov., 1823.)

THOMAS A' KEMPIS. [KEMPIS.]

THOMAS AQUINAS. [AQUINAS.]

THOMAS, ANTOINE LÉONARD, was born at Clermont in Auvergne, on the 1st of October, 1732. His father, it has been generally believed, died while Thomas was an infant, leaving a widow with three sons and a daughter. The eldest son, Joseph Thomas, who embraced the clerical profession, died in 1741: he composed a dramatic piece, entitled 'Le Plaisir,' which was acted with success in 1740. The second, Jean Thomas, died in 1755, professor in the college of Beauvais: he published some Latin verses, and introduced into his college an improved method of teaching Latin. It appears therefore that the taste for literature was common to the whole family.

Antoine Léonard was educated at home till he had completed his ninth year, and was then sent to prosecute his studies at Paris, where his brothers preceded him. In a letter which he addressed, in 1767, to Madlle. Moreau, he mentions that his second brother had taken great pains with his education. They were an attached family: Antoine retained all his early devotion for his mother till her death, in 1782; and his sister, the only member of the family who survived him, lived with him till his death.

Antoine Léonard Thomas distinguished himself at the university. In 1747 he carried off two of the prizes distributed in his class in the college of Duplessis: in 1748 and 1749 he studied rhetoric in the college of Lisieux, and obtained four prizes: from October, 1749, to August, 1751, he studied philosophy with equal distinction, at first in the college of Lisieux, subsequently in that of Beauvais. When he finished his university career, his friends wished him to study for the bar, and he did so far comply with their desire as to attend law classes and the office of a solicitor. This continued till the death of his second brother, in 1755, at which time he had retired, apparently on account of his health, which was always infirm, to his native district. A short time after he accepted the offer of a professorship in the college of Beauvais. He continued to discharge the duties of his appointment till 1761, when, finding them injurious to his health, he resigned, and was appointed private secretary to the Duc de Praslin.

Thomas commenced his career as author in 1756 by publishing 'Reflections Philosophiques et Littéraires sur le Poème de la Religion Naturelle.' This was throwing down the gauntlet to the whole school of Voltaire: the patriarch himself took no notice of the publication, and Grimm spoke of it as the work of 'a silly lad just escaped from the school of the Jesuits.' In the same year Thomas addressed an ode, full of hyperbolic compliments, to Sechelles, controller-general of finance: the flattery was successful; it obtained from the minister an addition to the revenues of the college. In 1757 Thomas composed, on the occasion of the great earthquake at Lisbon, a 'Mémoire sur les Causes des Tremblemens de Terre,' which was crowned by the Academy of Rouen. In 1759 he published 'Jumarville,' a poem in four cantos, on the death of a French officer, killed, as the French alleged, under circumstances of peculiar atrocity, in the war between the French and English, in the backwoods of America. Fréron praised this poem in the 'Année Littéraire,' a tribute of thanks to the young author who had ventured to attack Voltaire. These early works of Thomas are remarkable only for their turgid style, commonplace ideas, and for the eagerness of the author to avail himself of the popular topic of the day.

About this time the French Academy, with a view to render the prize-essays of its members more popular, began to propose the eulogies of great men as the subjects. Thomas entered the lists three successive years, and was successful every time. His 'Eloge de Maurice, Comte de Saxe,' was crowned in 1759; his 'Eloge de Henri François d'Aguesseau,' in 1760; and his 'Eloge de René du Guay-Trouin,' in 1761. In 1760 he also competed for the prize of poetry: his 'Épître au Peuple' was declared next in merit to the poem of Marmontel, to which the medal was assigned. In these compositions a marked improvement can be traced. There is no greater originality of thought than in his first productions—nothing of genius in them; but more matter, more of artistical finish, and less of boyish inflation of style.

The connection with the Duc de Praslin was less advantageous to Thomas than it promised to be at the outset. The duke procured for him the sinecure appointment of secretary-interpreter to the Swiss cantons. But a vacancy occurring soon after in the Academy, this minister, who had a personal quarrel with Marmontel, sought to obtain it for his secretary. Thomas had the magnanimity to refuse the appointment, urging the superior claims of Marmontel. This act of honesty lost him the favour of the Duc de Praslin, and closed the career of office which was opening to him. The admission to the Academy was not however long deferred. He delivered his inaugural address to that body on the 22nd of January, 1767.

Between 1761 and 1767 he composed—'Eloge de Sully,' crowned in 1763; 'Eloge de Descartes,' crowned in 1765; in 1766, 'Eloge de Louis, Dauphin de France,' composed and published at the request of the Comte d'Angiviller; and his inaugural discourse. In October, 1767, his opera of 'Amphion' was brought out, but without success. These works are all characterised by a progressive improvement in execution. They differ also from his juvenile productions in an attempt to adopt the sparkling and antithetical style of the Encyclopedists, and in the complete appropriation of their bold satirical tone in respect to politics, although much of the author's juvenile respect for religion remained with him to the last. As a natural consequence of the change, Grimm had by this time begun to praise Thomas, and Frélon had cooled in his admiration of him: Voltaire had written a complimentary letter on the 'Eloge de Descartes,' but had on the other hand remarked to his friends that they ought now to substitute the word *galithomas* for *galimathias*: Diderot continued implacable. It was rumoured that the court, enraged at the free strain of the 'Épître au Peuple,' and the sarcasms launched against itself and the feudal system in the 'Eloge du Dauphin,' threatened the liberty of Thomas.

The principal publications of Thomas, from the time of his admission into the Academy till his death, are—'Eloge de Marc Aurèle,' read to the Academy in 1770, and published in 1775. His reply, as director of the Academy, to the inaugural discourse of the archbishop of Toulouse, also in 1770. 'Essai sur le Caractère, les Mœurs, et l'Esprit des Femmes, dans tous les Siècles,' 1772. 'Essai sur les Éloges; ou l'Histoire de la Littérature et de l'Éloquence appliqués à ce genre d'Ouvrage,' published in 1773, in an edition of his collected works. He commenced a poem on the czar, Peter I.; but only four books and part of a fifth were completed at the time of his death. The increased technical skill of the author continues to show itself in these works; but the increased boldness of his attempts serves also to show the natural meagreness and feebleness of his genius. He was utterly devoid of impassioned imagination. His 'Eloge de Marc Aurèle' is an attempt to personify a Stoic of the age of that emperor: it is alike deficient in interest and dramatic truth. His essay on the character and manners of women is a collection of passages which would have swelled his didactic essay on 'Éloges' to too great a bulk. It was said at the time that this panegyric essay on the sex pleased them less than the vituperations of Rousseau. No wonder the treatise of Thomas is cold and unimpassioned: it was forced work; but the ravings of Rousseau are the scoldings of a jealous man who has been anxious but unable to please. The treatise on 'Éloges' is a worthy consummation of the author's labours in that empty and artificial branch of literature which has all the falsehood of oratory without the interest

which attaches to the eloquence of the bar or statesman from its power of producing great practical effects. The partially completed poem of 'The Czar' is scarcely read, the versification smooth, but the four books are not separate poems, in the manner 'though not so good' as Goldsmith's 'Traveller.' They never could have been made parts of an epic.

Thomas died on the 17th of September, 1786. His health, always delicate, had been undermined by incessant study. His end is supposed to have been hastened by the shock he received from an accident which happened to one friend and the death of another. That he was capable of generous feeling and disinterested action he showed when he forfeited the favour of the Duc de Praslin by refusing to accept a seat in the Academy to the exclusion of Marmontel. That he was capable of sincere affection is proved by the footing on which he stood with his family and friends. The insinuations against his sincerity and veracity thrown out by Diderot seem to have no better foundation than the change of tone in his later from his earlier publications. The truth is, that, like many other inferior *littérateurs*, Thomas was a mere echo of the society by which he was surrounded. He took his colouring in youth from his preceptors, most of whom were ecclesiastics: in after-life, from the sceptical literary conversation of the salons of Paris. His éloges are his most characteristic works, a kind of composition too inaccurate to have value as history, too cold and remote from the real business of life to impress as oratory. He stands however high among his class of writers. The high finish and some of the brilliancy of the French school cannot be denied him; though for this he was indebted quite as much to the company he kept as to natural talent, or even his unquestionable painstaking.

(Œuvres de M. Thomas, Paris, 1792; Œuvres Posthumes de M. Thomas, Paris, An x. 1802; 'Sketch of Thomas,' by Saint Surin, in the *Biographie Universelle*.)

THOMAS, ST. (Santo Thome), an island in the Gulf of Guinea, extends from 1° to 25' N. lat., and from 0° 25' to 6° 43' E. long. It is about 140 miles west-north-west from Cape Lopez. The island is of an oval shape: its greatest length is about 30 miles, and its greatest breadth about 9 miles. Its area may be estimated at about 420 square miles. It is of basaltic formation, and mountains: the Pico de Santa Anna de Chaves is 7000 feet high. The mountains are mostly covered with wood, and there are numerous streams well supplied with fish. The vegetation is abundant. The chief exports are sugar, indigo, and cotton. The island belongs to the Portuguese; and the inhabitants, who are chiefly composed of Portuguese and of negro slaves, amount to about 18,000. A number of runaway negroes live in the mountains. The chief town is called Santo Thome.

THOMAS, ST., Island. [VIRGIN ISLANDS.]

THOMASIN, or TOMASIN, surnamed Tirkeläre, Czar or Zerker, a German poet of the thirteenth century. He was a native of the Italian province of Friuli, and born about the year 1186. Being thus an Italian by birth, or, as he himself says, a Walich, he wrote in his earlier days an Italian work, probably a didactic poem, 'On Courtly Manners,' which is no longer extant. In the course of the year 1216, when he had just reached his thirtieth year, he wrote in the space of ten months a great didactic poem in German, which from his native country he called 'The Welsh Guest' (Der Welsehe Gast), and which consists of ten books. This poem, of which there exist many excellent manuscripts, is one of the most splendid productions of German literature during the thirteenth century, and, although the author is a foreigner, the work breathes throughout a pure German spirit, and displays at the depth and intensity of German thought and feeling. In the beginning of his poem Thomasin admits that he is not a perfect master of the language which he used; but still the peculiarities are so few and slight, that it requires a profound knowledge of the old German language to discover the foreigner. Eschenburg therefore supposes that the author's statement respecting his native country is a mere fiction. But this supposition, as well as another, the 'Welsh Guest' is merely a German translation of the Italian work 'On Courtly Manners,' is without foundation, and contradicted by numerous passages of the work. The object of this poem is to show in what

piety, and good conduct consist, and why man should strive after them. It shows that a remarkable progress had taken place in the mind of Thomasin during the interval between the composition of the Italian and that of the German work. In the former, as he himself states, he had proceeded from the idea that courteous conduct and nobility of birth were always combined with a noble mind, or, in other words, that the changeable rules respecting good manners were of greater value than the eternal law of morality which is implanted in every man's heart. This prejudice is altogether given up in his German poem, where he declares that a man is foolish who thinks himself great because he is of noble birth and possesses courteous manners, and that it is only a man's heart and real character that make him worth anything. Virtue with him is now a fundamental principle, and not a mere expedient. He describes virtues and vices, and their respective consequences, with a truly Socratic spirit and dignity. Thomasin was well acquainted with the history of antiquity, and it is among the antients that he found his best models of really virtuous men. The whole poem is a sublime and altogether practical system of morality: it is a philosophy in the garb of poetry occasionally embellished by figurative language.

He does not write in the spirit of any particular school; object is in general to instruct man on matters concerning his physical and spiritual welfare.

This masterpiece of early German poetry and philosophy has never yet been published entire, but it is said that Frommann is preparing an edition of it. Fragments of it are printed in Eschenburg's 'Denkmäler Altdeutscher Dichtkunst,' p. 121, &c.; compare Gervinus, 'Geschichte der Poetischen National Literatur der Deutschen,' vol. i., p. 456, &c.

THOMAS'SIUS, CHRISTIAN. The real name of this author is Thomas, and in the works which he published in his mother tongue he always calls himself Christian Thomas. He was born at Leipzig, on the 12th of January, 1655, and was the son of Jacob Thomasius (1622-1684), a distinguished professor of philosophy, and some time rector of the celebrated Thomasschule at Leipzig, under whose auspices Leibnitz was educated. The education of Christian Thomasius was conducted by his father, whose knowledge of philosophy and its history gave his mind at an early age a decided turn. Christian had scarcely attained his fourteenth year when he was found sufficiently prepared to enter the university. In his sixteenth year he obtained the degree of bachelor of arts, and the year after that of master of arts. The chief subjects of his studies were philosophy and law, more especially the law of nature, which he regarded as the basis of all other laws. The instruction of his father and his own experience at the university had convinced him that the methods of teaching then followed were pedantic and deficient, and he determined to remedy these defects as much as was in his power. In 1675 he went to Frankfort-on-the-Oder, where he began a course of lectures on law, but they do not appear to have been well received by his colleagues, and a few years after, in 1679, after having obtained the degree of doctor of laws, he left Frankfort, and made a literary journey to Holland. On returning to Leipzig he commenced the practice of the law. But this occupation did not offer sufficient scope for him, and he again became an academic teacher, in which capacity he brought about the most beneficial reforms. The law of nature, which had until then been almost entirely neglected in the universities, continued to be the principal subject of his studies. The older professors, who found themselves disturbed in their routine of teaching by the energy and boldness of the young man, began to clamour against him. As long as his father lived, violent outbreaks were prevented, partly because he restrained his son's eagerness for reforms, and partly because the other professors seemed him too much to hurt his feelings by open attacks upon his son. When however his father died, in 1684, the bitterness and boldness with which young Thomasius attacked antiquated prejudices of all kinds together with their champions, involved him in numerous disputes. This enmity was not only provoked by the matter and the manner of his teaching, but also by several publications which tended to destroy established opinions. One of them, on polygamy, especially gave great offence;

he asserted that polygamy was at least not contrary to any law of nature.

Up to this time it had been the general custom in all German universities to deliver lectures in Latin, and to make all public announcements of them in the same language. In the year 1687 Thomasius published his program in German, and announced that he would deliver a course of lectures in German, and on a subject which appeared altogether foreign to a university.—viz. on the manner in which the Germans should follow the example of the French ('Discours, welcher Gestalt man denen Franzosen im gemeinen Leben und Wandel nachahmen soll,' published at Leipzig, 1687, 4to.). This daring innovation was regarded by his colleagues as a perfect heresy, though, after the example was once set, it was gradually followed by other professors, until it became the universal practice in all German universities to lecture in German. It was a necessary consequence of this that books of a scientific character now began to be written in German. Notwithstanding both the open and secret attacks to which Thomasius had thus exposed himself, he continued to combat prejudice, pedantry, and error. He was unsparing in his censure, which was usually combined with wit and satire, and even his former teachers did not escape. In the year after, 1688, he established a German Monthly Review, under the title, 'Freimüthige, jedoch vernunft- und gesetzmässige Gedanken über allerhand, fürnehmlich aber neue Bücher,' which he conducted from 1688 till 1690, and which gave him immense influence in all parts of Germany, and the means of chastising his enemies. His enemies in their turn tried every means to avenge themselves; and although Thomasius at first succeeded in averting the danger that was gathering around him, yet the disputes became daily more vehement and serious, especially with two divines, Pfeifer and Carpzovius, who charged him with atheism. The theological faculty of Leipzig was likewise gained over to their side. H. G. Masius, court preacher to the king of Denmark, who had been rather severely dealt with by Thomasius in his Journal, and who made a reply, to which Thomasius answered in a very energetic manner, persuaded the king of Denmark to have all the published parts of Thomasius's Journal burnt in the market-place of Copenhagen by the hangman, 1689. Such proceedings in a foreign country were treated by Thomasius with contempt; but the storm was gathering over his head. In the same year he became involved in disputes with the Pietists, and also came forward to justify marriages between two persons of different religions, which enraged the divines of Wittenberg to such a degree, that the chief consistory was induced by various charges which were made against him to issue an order for the apprehension of Thomasius. He escaped the danger and fled to Berlin, where he met with a kind reception and the protection of Frederick III., the great elector of Brandenburg (afterwards King Frederick I.), who not only permitted him to settle at Halle, but also to lecture in the Ritteracademie (academy for young noblemen) of that place. He began his lectures here in 1690, and met with the same approbation on the part of the students as at Leipzig; and the increase in the number of students induced the elector in 1694 to found the university of Halle, in which he appointed Thomasius professor of jurisprudence, and conferred upon him the title of councillor, with a salary of 500 thalers. In this new position too Thomasius continued to be annoyed by numerous disputes, partly with his former adversaries and partly with others. In the year 1709 he had the satisfaction to receive an invitation to the chair of jurisprudence in the university of Leipzig, which however he refused. King Frederick I. of Prussia, pleased with the determination of Thomasius not to leave his service, rewarded him with the title of privy-councillor. In 1710 Thomasius was elected rector of the university of Halle, and dean of the faculty of jurisprudence. He died on the 23rd of September, 1728, in the seventy-third year of his age.

If ever a man exercised a beneficial influence upon his age and country, an influence which will extend to the latest posterity, it is Thomasius. He was one of the few men, like Luther and Lessing, who now and then rise up in a nation, give it an impulse, and determine its course. At the time when Thomasius began to make himself known, philosophy and theology were studied and taught in such a

manner that it was evident that the spirit which had been created by the Reformation would soon vanish altogether. All philosophical and scientific works were written in Latin, which formed an inadequate medium for communicating new thoughts and ideas, which were frequently crippled and imperfect on that account, or the language itself was barbarous. In the universities also Latin was the ordinary language for communicating knowledge, which thus remained in the exclusive possession of a small number, and without influence upon the nation at large. Thomasius prepared the way for better things, first by communicating knowledge in his native language, and by extending the sphere within which speculation had until then been carried on. At the same time he urged the necessity of writing in a clear and intelligible style, which many of his countrymen in recent times have greatly neglected. His own style, though not always pure, is precise and vigorous. As in places of learning Thomasius destroyed old prejudices and pedantry, he also boldly combated superstition and hypocrisy in the affairs of common life, such as the belief in ghosts, spectres, and witchcraft; and it is almost entirely owing to his exertions that trials for witchcraft and torture were abolished in Germany. In reference to this, Frederick the Great says of Thomasius, 'He denounced trials for witchcraft so loudly, that persons began to be ashamed of them, and from that time the female sex has been permitted to grow old and die in peace.' All this would alone be sufficient to immortalize his name, even if he had no claim to it by what he did in philosophy. Here he indeed found things in such a state, that it required all his energy to clear the field from the weeds with which it was overgrown, before it was fit to receive the seed, and accordingly his philosophy is more of a destructive than of a constructive character. But in this negative way he has done incalculable service to his nation, and Frederick the Great justly says, that, among all the philosophers of Germany, none have contributed more to render its name illustrious than Leibnitz and Thomasius.

The number of works of Thomasius is considerable. Besides those mentioned above, the following must be noticed: 'Einleitung zu der Vernunftlehre, worinnen durch eine leichte, und allen vernünftigen Menschen, waserlei Standes oder Geschlechts sie seyn, verständliche Manier, der Weg gezeigt wird, ohne die Syllogistica, das Wahre, Wahrscheinliche und Falsche von einander zu unterscheiden und neue Wahrheiten zu erfinden,' Halle, 1691, 8vo. The fifth and last edition of this work appeared at Halle, 1719, 8vo.; it was the first readable book that had ever been produced in Germany on logic. 'Von der Kunst vernünftig und tugendhaft zu lieben, als dem einzigen Mittel zu einem glückseligen, galanten, und vernünftigen Leben zu gelangen, oder Einleitung der Sittenlehre,' &c., Halle, 1692, 8vo.; an eighth edition of it appeared in 1726. This work contains a system of ethics better than any that had appeared before him. 'Historie der Weisheit und Thorheit, in three parts, Halle, 1693, 8vo. 'Weitere Erläuterung durch unterschiedene Exempel, anderer Menschen Gemüther kennen zu lernen,' Halle, 1693, 8vo., reprinted in 1711. 'Der Kern wahrer und nützlicher Weltweisheit,' Halle, 1693, 8vo.: this is a translation of Xenophon's 'Memorabilia of Socrates,' which Thomasius strangely enough took from the French translation of Charpentier, although he himself was well acquainted with the Greek. 'Versuch vom Wesen des Geistes, oder Grundlehren die einem Studioso Juris zu wissen und auf Universitäten zu lernen nöthig sind,' Halle, 1699, 8vo., reprinted in 1709. 'Ernsthafte aber doch muntere und vernünftige Gedanken und Erinnerungen über allerhand auserlesene juristische Händel,' 4 vols., Halle, 1720-21. His miscellaneous and smaller essays appeared in a collection under the title 'Kleine Deutsche Schriften mit Fleiss zusammengetragen,' Halle, 1701, 8vo. A complete list of his works is given in Luden's *Christian Thomasius nach seinen Schicksalen und Schriften dargestellt*, with a preface by Johannes von Müller, Berlin, 1805, 8vo.; and in Jürden's *Lexikon Deutscher Dichter und Prosaisten*, vol. v., p. 37-59.

THOMASIIUS, JACOB. [THOMASIIUS, CHRISTIAN.]

THOMASTON. [MAINE, p. 307.]

THOMOND, THOMAS, an architect who practised at St. Petersburg, and held the rank of a major in the Russian service, was a native of France, and born at Nancy,

December 21, 1759. Scarcely had he completed his professional education at Paris, when the Revolution rendered it unsafe for him, he and his family being royalists, remain in the country, and he accordingly emigrated to Russia, where he at first supported himself by the produce of his pencil, which not only found purchasers, but made him favourably known to the St. Petersburg public. The time he displayed in architectural subjects led at length to being employed by the government in that branch of art which he had originally intended to follow, and one of his first works of any importance intrusted to him was the Great Theatre (erected by the German architect Theobald, 1782-83), which he was commissioned to improve and partly remodel, in 1804. Although not altogether free from the peculiarities of the French school, the Arcade and octastyle Ionic portico which he added to that structure is one of the noblest pieces of architecture in the northern capital of Russia, and, of its kind and date, in Europe. Had he executed nothing else, that alone would have entitled him to rank higher in his profession as an artist than many who owe their celebrity as much to the number as to the merit of their works. But he had also the opportunity of displaying his taste and ability in another very striking public edifice at St. Petersburg, namely, the Imperial Bourse, or Exchange, erected by him between the years 1804 and 1810, which is an insulated structure about 256 by 300 feet) of the Roman Doric order, pterical and decastyle at each end (although without pediments, and having altogether 44 columns. Situated at the southern point of the Vassilievskii Island, immediately facing the Neva, it stands in the centre of a spacious *placé*, or 'place,' upon a rich architectural terrace, which sweeps out so as to form a semicircular esplanade in front, at each extremity of which is a flight of steps leading down to the river, and a massive rostral column 120 feet high. Taken altogether, the architectural combination thus produced is exceedingly picturesque, and may be said to be unique.

Thomond also erected some private mansions and other buildings at St. Petersburg, the mausoleum of the emperor Paul at Pavlovsk, the theatre at Odessa, and the Pulkova monument. In 1808 he published some of his buildings and architectural designs in a quarto volume, very unsatisfactorily executed however; and he also wrote a treatise on painting, an art to which he was greatly attached. He died August 23, 1813.

(Kukolnik, in *Khudozhestvennaya Gazeta*, 1837.)

THOMPSON, SIR B. [RUMFORD, COUNT.]

THOMSON, JAMES, was born at Ednam in Roxburghshire on the 11th September, 1700. His father was clergyman of the place, and distinguished for his piety and pastoral character. James was first sent to the grammar-school at Jedburgh, and completed his education at the University of Edinburgh, where in 1719 he was admitted as a student of divinity. In 1720 his father died, and this, says Dr. Murdoch, affected him to an uncommon degree, and his relations still remember some extraordinary instances of his grief and filial duty on that occasion.

Thomson turned from divinity to poetry owing to the following incident:—The Rev. Mr. Hamilton, who then filled the chair of divinity, gave as a subject for an exercise a psalm in which the majesty and power of God are described. Of this psalm Thomson gave a paraphrase and illustration as the exercise required, but in so poetical and figurative a style as to astonish the audience. Mr. Hamilton complimented the performance and pointed out to the students its most striking points: but, turning to Thomson, he suggested that if he intended to become a minister he must keep a stricter rein over his imagination and learn to be intelligible to an ordinary congregation.

Some encouragement held out to him by Lady Gravel, Bailie following this intimation of the Professor, he determined to give up divinity and try his fortune in London. Slender as this pretext of 'encouragement' was, there have been many poets who have thus sought their fortune from no stronger reason. The truth is, Thomson wanted to try his capacity in London, and seized on this as a pretext. Arrived there, says Dr. Johnson, he was one day loitering about 'with the gaping curiosity of a new-comer,' his attention upon everything rather than upon his pocket, when his handkerchief, containing his letters of recommendation to several persons of consequence, was stolen from him. And now the lonely poet in the vast city

his inexperience and his poverty. A pair of shoes his first want; his manuscript of 'Winter' his only property. A purchaser for this poem was found with difficulty; but Mr. Millar consented to give a trifle, and it was published in 1726. It was little read by Mr. Whately and Mr. Spence spoke so favourably that attention was attracted, and it rose rapidly in popularity, and one edition very speedily followed the other.

His success procured him many friends, among whom Mr. Rundle, who introduced him to the lord chancellor; and some years after, when the eldest son of that man made a tour on the continent, Thomson was named his travelling companion. Meanwhile his natural powers were fully employed, and in 1727 appeared 'Summer'; in 1728, his 'Spring'; and in 1730, his 'Autumn.' Besides these he published, in 1727, 'A Poem on the Memory of Sir Isaac Newton,' and 'Britannia poetical invective against the ministry for the injustice they showed to the depredations of the Spaniards in America. By this piece he declared himself a favourer of opposition, and therefore could expect nothing from court.

His tragedy of 'Sophonisba' was acted in 1727, Wilks being the part of Masinissa, and Mrs. Oldfield that of Sophonisba. So high were the expectations raised, that the rehearsal was dignified with a splendid audience, intended to anticipate the pleasure that was preparing for the public. Its success however was very equivocal. 'The play is,' says Johnson, 'a feeble line in the play:—

"O, Sophonisba, Sophonisba, O!"

gave occasion to a waggish parody,

"O, Jemmy Thomson, Jemmy Thomson, O!"

For awhile was echoed through the town. At this time long opposition to Sir Robert Walpole had raised the nation with clamours for liberty, and Thomson, actively seizing the poet's office to utter in verse the sentiments of the nation, determined on writing a poem on 'Liberty.' He spent two years on this undertaking, and considered it as his noblest work, probably because it had cost him the most trouble. It was divided into five parts, and were published separately, thus: 'Antient and Modern Italy compared; being the first part of "Liberty," &c.,' 1735. 'Greece; being the second part, &c.,' 1735. 'Rome; being the third part, &c.,' 1735. 'Bribery; being the fourth part, &c.,' 1736. 'The Prospect; being the fifth part, &c.,' 1736. The poem of 'Liberty' does not now appear in its original state, having been shortened by George (afterwards Lord) Lyttelton. Of all Thomson's works this is the least read, and deservedly so; for, independent of the feebleness of its execution, it is obvious, as Johnson remarked, that 'the recurrence of the same ideas must tire in time; an enumeration of examples to illustrate a position which nobody denied must quickly grow tedious.'

His friend Talbot appointed him secretary of briefs, a situation requiring little attendance, suiting his retired mode of life, and equal to all his wants. When his friend died, Lord Hardwicke succeeded him, and kept the office vacant for some time, probably till Thomson should be ready for it; but either his modesty, pride, or depression of spirits prevented his asking, and the new chancellor would not give him what he would not request. This want of fortune increased his literary activity. In 1738, in editing his own works in two volumes and writing the preface to Milton's 'Areopagitica,' he produced the play of 'Agamemnon,' with Quin for his hero. For it he got 'no inconsiderable sum,' though it had but little success. Johnson says that on the first night Thomson satiated himself in the upper gallery, and was so interested in its performance, that 'he accompanied the players in audible recitation, till a friendly hint frightened him to bed.'

Thomson's next tragedy was 'Edward and Eleonora,' which was not allowed to be represented on account of its pretended allusions. He then wrote, conjointly with Mallet, the masque of 'Alfred,' which was represented before the prince and princess of Wales at Clifden in 1739.

This masque contains the national song of 'Rule Britannia,' which Mr. Bolton Corney ascribes, 'on no slight authority,' to Mallet.

Thomson's next work was another tragedy, 'Tancred and Sigismunda,' which, being taken from the interesting story in 'Gil Blas,' instead of the Grecian mythology, as were his other pieces, had more success. Garrick and Mrs. Cibber played the principal parts. His friend Sir George Lyttelton now appointed him surveyor-general of the Leeward Islands, from which, after paying a deputy, he received about 300*l.* a year.

The 'Castle of Indolence,' which was many years under his hands, was now finished and published (1748). It was at first little more than a few detached stanzas, in the way of raillery on himself, and on some of his friends who reproached him with indolence, while he thought them at least as indolent as himself. But the subject grew under his hands till it became his masterpiece.

A violent cold, which from inattention became worse, at last carried him off, on the 27th August, 1748. He left behind him a tragedy of 'Coriolanus,' which was brought on the stage by Sir George Lyttelton for the benefit of his family. A considerable sum was gained, which paid his debts and relieved his sisters. The remains of the poet are deposited in Richmond churchyard.

Thomson was 'more fat than bard be seems'; of a simple, unaffected, indolent, sensual character; silent in company, but cheerful among friends, of whom he had many and true. This character is discernible in his writings. His simplicity is seen in the purity and warmth of his sentiments, sometimes even childish; his indolence in the slovenliness of his versification, and the inappropriateness of so many of his epithets: he never seems to have thought anything worth the toil of polishing, and hence the perpetual use of pompous glittering diction substituted for thought or description; his sensuality appears in the gusto with which he describes all luxuries of the senses, and the horrors of deprivation. Amidst much that is truly exquisite both in feeling and expression, he mingles the absurdities of a schoolboy's trite commonplaces and mechanical contrivances to piece out his verse. A sweet line of almost perfect beauty is followed by a bombastic allusion, or some feeble personification as tiresome as the first was bewitching. A touch of nature is overloaded by superfluous epithets—a picturesque description is often marred by pedantry or carelessness. Hazlitt says that 'he is affected through carelessness—pompous from unsuspecting simplicity of character. He is frequently pedantic and ostentatious in his style, because he had no consciousness of these vices in himself.'

In spite of these drawbacks, Thomson is a charming poet, and one whose works have always been the delight of all classes. The popularity of his 'Seasons' equals that of any poem in the language, and it is said that some one, finding a shabby copy of it lying on the window-seat of a country ale-house, exclaimed, 'That's true fame!' Thomson's beauties are genuine: his descriptions of nature often come with the force of reality upon the mind; and no one ever painted more successfully the 'changing scene' and the 'rustic joys' of England.

His 'Castle of Indolence' may be regarded as his best-sustained effort, for, although separate passages of the 'Seasons' may be superior, yet on the whole it has fewer defects, while some of the stanzas, especially in the first canto, fill the mind with lazy luxury.

Of his tragedies we need say little: their neglect has been so signal, that we may accept so unanimous a verdict without further examination; indeed the genius of Thomson was eminently undramatic.

(Dr. Johnson, *Lives of the Poets*; Murdoch's *Life of Thomson*; Thomson's *Seasons*, edited by Bolton Corney; Hazlitt's *Lectures on the English Poets*; Campbell's *Specimens of the British Poets*.)

THOMSONITE. This mineral occurs generally in masses. Structure fibrous and radiated, the fibres prolonged into small columnar crystals in the occasional cavities. Primary form a right rhombic prism. Cleavage parallel to the diagonal planes of the primary form. Fracture uneven. Hardness—scratches fluor spar, or 5.0. Colourless, translucent, and in small fragments transparent. Lustre vitreous. Brittle. Specific gravity 2.35 to 2.37.

Before the blow-pipe it intumescs and becomes opaque, but does not fuse; at a red heat it loses water.

It occurs at Kilpatrick, near Dumbarton, in trap associated with analcime and prehnite.

Analysis by—

	Dr. Thomson.	Rezzellus.
Silica	36·80	38·30
Alumina	31·36	30·20
Lime	15·40	13·54
Soda	—	4·53
Magnesia	0·20	0·40
Peroxide of iron	0·60	—
Water	13·00	13·10
	97·36	100·07

THONON. [CHABLAIS.]

THORACIC DUCT is the principal trunk of the lymphatic or absorbent system, and the canal through which the greater part of the chyle and lymph is conveyed into the blood. It commences, below, at what is called the receptaculum chyli, which receives all the principal absorbent vessels from the intestines and from the lower extremities, and lies at the posterior and middle part of the abdomen, on the upper lumbar vertebra and on the right side of the aorta. In man the diameter of the receptaculum is but little greater than that of the thoracic duct, which is continued from it; in most other animals it is considerably greater, and the duct seems in them to commence in a large pouch. From the receptaculum chyli the thoracic duct passes upwards, on the right side of the aorta, and behind it, from the abdomen into the chest, being joined in its course by the lymphatic vessels of the adjacent organs. Opposite the sixth dorsal vertebra it begins to bend to the left, and, after passing behind the arch of the aorta, it ascends to the level of the seventh cervical vertebra, curves forwards and downwards, and opens into the left subclavian vein, usually near its junction with the left jugular vein. At this orifice of the thoracic duct there are two valves, like those of the veins, which open to permit fluid to pass from the duct, but close when any is forced against them from the vein. Other valves in uncertain number are found in different parts of the duct, and have all the same direction as those of veins. [ABSORBENTS; CHYLE; DIGESTION.]

THORAX. [RESPIRATION.]

THORDO is the Latinized name of a celebrated Danish lawyer, whose real name was Thord, or, more completely, Thord Deghn. He lived in the reign of Waldemar III., king of Denmark, and was descended from an ancient family of that country. Concerning his life little is known beyond the fact that he was chief judge of the province of Jütland. His name has come down to us through a collection of Danish laws which he formed into a kind of code. It contains the earliest Danish laws, to which no historical origin can be assigned, as well as the subsequent laws which were passed between the years A.D. 1200 and 1377, by the Danish parliament, and sanctioned by the kings. They are not arranged in chronological order, but systematically, and comprise civil as well as constitutional laws. They are of very great value to the student of the social and political history of Denmark. Danish editions of this small code appeared at Ripen, 1504, 4to.; and at Copenhagen, 1508, 4to. Ludewig, in his 'Reliquiæ Manuscriptorum omnis ævi diplomatum ac monumentorum ineditorum,' vol. xii., pp. 166-216, has published a Latin translation of this code of laws. In the title to them Thordo calls himself, 'Thordo legifer Daciae,' where Daciae must mean Daniae, that is, Denmark.

THORDSON, STURLA, belonged to the celebrated Icelandic family of the Sturla; his name Thordson indicates that he was a son of Thordo. He was a nephew of Snorri Sturluson, and born about A.D. 1218. Being a man of high rank and great knowledge, he was appointed to the most important offices by the Danish kings Hacon and Magnus, and it was at their command that he wrote the history of Iceland, Denmark, and Norway, from the time where the work of Snorri Sturluson broke off. This history bears the title of 'Historia Sturlungorum,' but the work which is now extant under that name is only an abridgment of the original history, and the latter part is altogether lost. The substance of the work is given in Torfaeus, 'Historia Rerum Norvegiarum,' who, in his Prolegomena, also gives an account of the 'Historia Sturlungorum.' Thordson died in A.D. 1288, at the age of seventy.

THORER. [TORINUS.]

THORESBY, RALPH (born 1658, died 1725), a virtuoso

and antiquary, and an early Fellow of the Society. He was the son of a merchant at Leeds, and he received his education at the Leeds Grammar School, but, being intended by his father for commerce, did not pass to any of the higher seats of learning; he had however what may be called a liberal education, being sent by his father to Holland for the purpose of becoming acquainted with the mode of conducting business in that country, and of acquiring the Dutch language; and afterwards to London for a similar purpose. He settled in his native town, where his talents connected with some of the principal persons of the society of Leeds, and where he had a house set apart for him, which had been successfully conducted by his father, who died when the son was just twenty.

Thoresby possessed from a very early period an eager curiosity respecting the things and persons which presented any features of historical interest, and a desire of collecting objects of curiosity, natural or artificial. His father had something of the same taste, and purchased the collection of coins and medals which had been formed by the family of Lord Fairfax, the military general, and this collection was the nucleus of a museum formed in a few years by the son. This was a means of bringing him acquainted with the celebrated antiquaries and naturalists of the time, and the perpetual attraction to persons of curiosity, who visited Leeds for no other purpose than to see it. It is too much to say of it that it was perhaps the first ever formed in England by a gentleman of a rather small fortune; containing, it is true, but few objects which would now be esteemed of not the smallest value, but also many objects of very high value, especially in the two grand departments of medals and coins.

As he advanced in life, the curiosity which had been directed upon the objects more immediately connected with him became expanded so as to comprehend objects of more general interest, and in fact the whole range of natural history is usually understood to be comprehended in the term antiquarian literature. In the department of natural history he was also not merely a collector, but an observer, and made many communications, esteemed either by his private friends or to the Royal Society.

With this turn of mind, it will hardly be supposed that he was very successful in his mercantile affairs, and that however the good sense to withdraw from business his fortune was entirely lost to him, and about the sixth year of his age he seems to have wholly renounced it, and to have formed the determination of living upon a little income which the portion of his property which remained would afford him.

Besides amassing such manuscript matter as he could by any means become possessed of, he was himself a diligent and industrious transcriber, and was also accustomed to collect and write notes of things which he observed, or were collected from his friends or the old people of the country. When released from the cares of business, he did not make use of these notes, and he entered upon the publication of the press of two works, which it was not probable that he should contain all that he had gathered together. One of them was to be in the form of a topographical survey of the whole of the large parish of Leeds, and a few of the smaller parishes which are supposed to have been comprehended under the very antiquated name of 'Elmete'; the other, a history of the various parts of which that district had been the scene, or the residence of its inhabitants, of the public benefactors, and the changes which had taken place in the state of the town and its inhabitants. The first of these designs was never accomplished. The work appeared in a folio volume in 1715, under the title of 'Ducatus Leodiensis, or the Geography of the Town and Parish of Leeds.' It leaves little for the inhabitants of the town to desire, of the kind, except that he had prepared the 'Historical Part' to which the author is perpetually referring. The work is more than its title promises, since it contains a large body of genealogical information, comprising the descents of nearly all the families of consequence who inhabited the central parts of the West Riding. There

a very large descriptive catalogue of the treasures deposited in his museum.

The 'Ducatus' is the principal literary work for which we are indebted to him. As a kind of supplement to it, he published, in 1724, a history of the Church of Leeds, under the title 'Vicaria Leodiensis,' which, like his former work, contains many things not strictly belonging to his subject, but themselves valuable. A new edition of the 'Ducatus,' containing also all the matter of the 'Vicaria' which properly belonged to Leeds, was published by Thomas Dunham Whitaker, LL.D., in 1816.

The writings of bishop Nicolson, bishop Gibson, Obadiah Walker, Galamy, Strype, Hearne, and many others, show how willing Thoresby was to give assistance to any of his literary friends in their various publications.

Thoresby kept during the greater part of his life an exact diary of each day's occurrences. Large extracts from the diaries which remain of it were published in two octavo volumes in 1830, and two more volumes were published at the same time of selections from the letters of his various correspondents; these were published under the care of Mr. Hunter. They exhibit the peculiar features of a somewhat remarkable character, and the particular incidents of his life. A large account of him may be found in the 'Biographia Britannica,' and another prefixed to Dr. Whitaker's edition of his topographical work.

THORITE, a mineral in which thorina was discovered by Berzelius. It occurs massive and compact. Its fracture uneven, very brittle, and full of cracks. Hardness about 5.0. Lustre resinous; vitreous; opaque. Colour black. Specific gravity 4.63 to 4.80.

Before the blow-pipe, gives off water, and becomes yellow, but does not fuse.

It is found in syenite, in Norway. It contains nearly 58 per cent. of thorina, mixed with thirteen metallic and other bodies.

THORIUM, or **THORINUM**, a metallic body discovered by Berzelius in an earth to which he had given the name of *thorina*. When this was converted into chloride of thorium, and treated with potassium, after washing the mass a heavy metallic powder was left of a deep leaden-grey colour, which, when pressed in an agate mortar, acquired an iron-grey tint and a metallic lustre. It is not oxidized by water, either hot or cold, but when heated in the air it burns brilliantly, and is converted into oxide of thorium, or thorina, which is perfectly white, and devoid of any trace of fusion. Thorium is scarcely attacked upon by nitric acid, and slowly by the sulphuric; but hydrochloric acid dissolves it readily with the evolution of hydrogen gas.

Oxygen and Thorium combine to form oxide of thorium, or thorina, by heating the metal in the air, or by decomposing the chloride by means of an alkali. When it has been strongly heated, its density is 9.402, and it is then insoluble in any acid but the sulphuric, and in that with difficulty. It is precipitated in the state of hydrate from solutions by the alkalis, and in this state it is readily soluble in acids, and is converted into carbonate by exposure to the air. The alkaline carbonates dissolve the hydrate, carbonate, and subsalts of thorina; thorina is precipitated from solution by the ferrocyanide of potassium. Thorina probably consists of—

One equivalent of oxygen	8
One equivalent of thorium	60

Equivalent 68

Besides combining readily with oxygen, as already mentioned, thorium unites energetically with chlorine, sulphur, and phosphorus; but the compounds which they form have not been minutely examined.

THORN. [CRATÆGUS.]

THORN-APPLE. [DATURA.]

THORN (in Polish, *Poronia*) is a celebrated fortress in the government of Marienwerder, in the province of Prussia. It is situated in 53° N. lat. and 36° 25' E. long., on the right bank of the Vistula, over which there is a bridge, which is the only standing bridge over the Vistula in its whole course. (The others are floating bridges.) It consists of two parts, the German and the Polish bridge, which are separated by an island called the Mazarkämpe. The German part, from the town to the island, is 1246 feet long; the Polish part is 927 feet long. The whole distance

from Thorn to the opposite bank of the Vistula (including 296 feet for the island) is 2469 feet: the breadth of the carriage-way is 18 feet; it is 17 feet above the river at its ordinary level.

Thorn is divided into the old and the new town. There are two Lutheran and three Roman Catholic churches, two monks' convents and one of Benedictine nuns, a celebrated Lutheran gymnasium, a Roman Catholic school (formerly a Jesuits' college), four elementary schools, one girls' school, four hospitals, an infirmary, and a house of correction. The most considerable buildings are the cathedral, built in the Gothic style; St. John's church, containing the monument of Copernicus, who was born here in 1473; the town-house, built in 1602, on the model of that at Amsterdam (the doors, inlaid with ebony and ivory, the marble tables, and the paintings on the walls are memorials of former splendour); the well-known leaning tower, like that at Pisa; and the house in which Copernicus was born.

Thorn is indebted for its foundation to Herman Balk, master of the Teutonic order, who immediately on his arrival, in 1231, fortified the ancient castle of Turno, at Old Thorn, about five miles from the present town. In the following year he founded the town, but, finding the situation inconvenient, pulled it down in 1235, and chose another site eight miles farther up the Vistula. At the commencement of the fourteenth century Thorn joined the Hanseatic League, and during the dominion of the Order became rich and flourishing through its extensive commerce. It afterwards joined 'The Union of the Prussian Cities,' and with it threw off the authority of the Knights: it took an active part in the sanguinary war arising from this step, which ended with the peace concluded in its walls in 1466, by which West Prussia was annexed to Poland. Commerce continued to flourish under the Polish government, but the city suffered severely, partly from the internal troubles of the kingdom, partly by the wars with Sweden, during which it was twice plundered by the Swedes (1655, 1703). Charles XII. entirely destroyed the fortifications. The Reformation was favourably received at an early period, but led to very harsh measures on the part of the Roman Catholics, and to internal troubles. These dissensions continued from the time of Sigismund I. (1506-1548), through the sixteenth and seventeenth centuries; and at the beginning of the eighteenth century occasioned what is called the 'Thorn Tragedy,' a persecution excited by the Jesuits, which ended, on the 7th December, 1724, with the execution of the burgomaster John Rossner and eleven of the principal citizens.

When West Prussia was separated from Poland in 1772, Thorn and Danzig remained under the Polish government, but their prosperity declined in consequence of the many obstructions to their commerce caused by the regulations of Prussia for the navigation of the Vistula. After its union with Prussia, on the second partition of Poland, in 1793, its commerce and prosperity revived. Since 1809 it has been again converted into a fortress. It is also important as a commercial port for the exportation of the produce of the country, corn, timber, linen, raw hides; especially however corn. The population, including the garrison, is nearly 12,000 inhabitants.

(A. E. Preuss, *Beschreibung von Preussen*; Brockhaus, *Conversations Lexicon*, 7th edit.; Hassel; Cannabich; Hürschelmann.)

THORNBURY. [GLOUCESTERSHIRE.]

THORNE. [YORKSHIRE.]

THORNEY. [CAMBRIDGESHIRE.]

THORNHILL. SIR JAMES, an eminent painter during the reigns of Queen Anne and George I., and, says Walpole, 'a man of much note in his time, who succeeded Verrio, and was the rival of Laguerre in the decorations of our palaces and public buildings,' was descended of a very ancient family in Dorsetshire, and was born at Weymouth in 1676. Through the extravagance of his father, who disposed of the family estate, Thornhill was compelled to support himself by his own exertions. He adopted the profession of a painter, and, by the liberality of an uncle, Dr. Sydenham, the eminent physician, he was enabled to pursue his studies in London, where he placed himself with a painter, whose name is not known, with whom however he did not remain long. Thornhill appears to

have made rapid progress in the public favour, for in his fortieth year, when he made a tour through Flanders, Holland, and France, he was sufficiently wealthy to purchase many valuable pictures of the old masters and others. Upon his return he received the commission from Queen Anne to paint the interior of the cupola of St. Paul's cathedral, in which he executed eight pictures illustrating the history of St. Paul, painted in chiaroscuro, with the lights hatched in gold: for this work he was appointed historical painter to the queen, yet was paid only forty shillings the square yard for his production. Thornhill's reputation was now established, and, through the favour of the earl of Halifax, he received the commission to paint the princess's apartment at Hampton Court, which the lord chamberlain, the Duke of Shrewsbury, had intended should be painted by Sebastiano Ricci, then in great favour with the court in England; but the Earl of Halifax, who was then first commissioner of the treasury, declared that if Ricci painted it he would not pay him. Sir James executed many other great works, as the staircase, the gallery, and several ceilings in the palace at Kensington, a hall at Blenheim, the chapel at Lord Oxford's at Wimpole in Cambridgeshire, a saloon for Mr. Styles at Moor Park in Hertfordshire, and the ceilings of the great hall at Greenwich Hospital. Sir James commenced the last work in 1703, and was occupied upon it for several subsequent years, but it was not entirely painted by his own hands. The paintings are allegorical: on the ceiling of the lower hall, which is 112 feet by 56, are represented the founders of the institution, William III. and Queen Mary, in the centre, surrounded by the attributes of national prosperity; in the other compartments are figures which represent the zodiac, the four seasons, and the four elements, with naval trophies and emblems of science, among which are introduced the portraits of famous mathematicians who have advanced the science of navigation, as Tycho Brahe, Copernicus, Newton, and others. On the ceiling of the upper hall are represented Queen Anne and her husband Prince George of Denmark; other figures represent the four quarters of the world; on the side walls of the same apartment are the landing of William III. at Torbay, and the arrival of George I. at Greenwich; on the end wall facing the entrance are portrait groups of George I. and two generations of his family, with accessories, and Sir James Thornhill's own portrait. These works, which are executed in oil, have little to recommend them besides their vastness; yet in invention and arrangement they are equal to the majority of such works in the great buildings on the continent: in design and colouring however they are inferior.

Walpole has preserved some interesting details respecting the remuneration Thornhill received for some of his works: he says, 'High as his reputation was, and laborious as his works, he was far from being generously rewarded for some of them, and for others he found it difficult to obtain the stipulated prices. His demands were contested at Greenwich; and though La Posse received 2000*l.* for his work at Montague House, and was allowed 500*l.* for his diet besides, Sir James could obtain but forty shillings a square yard for the cupola of St. Paul's, and I think no more for Greenwich. When the affairs of the South Sea Company were made up, Thornhill, who had painted their staircase and a little hall, by order of Mr. Knight, their cashier, demanded 1500*l.*, but, the directors learning that he had been paid but twenty-five shillings a yard for the hall at Blenheim, they would allow no more. He had a longer contest with Mr. Styles, who had agreed to give him 3500*l.*, but, not being satisfied with the execution, a lawsuit was commenced, and Dahl, Richardson, and others were appointed to inspect the work. They appeared in court bearing testimony to the merit of the performance; Mr. Styles was condemned to pay the money, and, by their arbitration, 500*l.* more, for decorations about the house, and for Thornhill's acting as surveyor of the building.' Thornhill obtained permission, through the earl of Halifax, to copy the Cartoons of Raphael at Hampton Court, upon which he bestowed three years' labour; he made also a smaller set, one-fourth the size of the originals, and distinct studies of the heads, hands, and feet, intending to publish an exact account of the whole for the use of students, but the work never appeared. These two sets of the Cartoons were sold the year after his death,

with his collection of pictures, among which were a few capital specimens of the great masters: the smaller set sold for seventy-five guineas, the larger for 200*l.* only a price, says Walpole, which can have been owing solely to the circumstance of few persons having spaces in their houses large enough to receive them. They were purchased by the duke of Bedford, and were placed in a gallery at Bedford House in Bloomsbury Square. They remained until that house was pulled down. They were presented by the owner to the Royal Ac-

Thornhill painted also several portraits and small pieces: he painted the altar-piece of the chapel of Souls at Oxford; and one which he presented to the church of his native town, Weymouth. There is also at Oxford, according to Dallaway, a good portrait of Christopher Wren by Thornhill; and in the hall of the Weymouth Hospital there is by him the portrait of John Wren in his ninety-eighth year, one of the first pensioners admitted into the hospital: it is painted in a bold classical style, and was presented to the hospital by Thornhill himself. In 1724 he opened an academy for drawing in a house in Covent Garden. He had previously proposed to the earl of Halifax the foundation of a Royal Academy of the Arts, with apartments for professors, but without success. Sir James estimated the cost at 3130*l.*; for, among other occupations, he occasionally 'dabbled' in architecture. At the end of his life he was afflicted with the gout, and in the spring of 1734 he retired to his paternal seat at Thornhill, near Weymouth, which he had the satisfaction of repurchasing; but his period of repose was extremely short, for, says Walpole, 'four days after his arrival, he expired in his chair, May 4, 1734, aged fifty-seven, leaving one son named James, whom he had procured to be appointed serjeant-painter and painter to the navy; and one daughter, married to that original and unequalled genius, Hogarth.'

Sir James Thornhill amassed considerable property, was a man of agreeable manners, was a Fellow of the Royal Society, and represented his native town, Weymouth, in parliament for several years until his death. He was knighted by George I.: his widow, Lady Thornhill, died at Chiswick in 1757.

(D'Argenville, *Abrégé de la Vie des plus fameux Peintres*; Walpole, *Anecdotes of Painting in England*; Pilkington, *Dictionary of Painters*.)

THORNTON, BONNELL, was born in London in the year 1724. He was educated at Westminster School and at Christchurch, Oxford. In compliance with the wish of his father, who was a physician, he studied medicine, but seems not to have liked the profession, and left it for literature. George Colman the Elder was his fellow-student at Westminster School and at Christchurch, though eleven years younger than Thornton. Similarity of taste led to friendship, and they commenced in conjunction the series of periodical essays called 'The Connoisseur,' which was continued from January 31, 1754, till September 30, 1756. The papers are chiefly of a humorous character, and the wit and shrewd observation of life which they display well entitle them to the place which they still retain among the works of British essayists. Thornton contributed largely to 'The St. James's Magazine,' 'The Public Advertiser,' 'The Covent-Garden Journal,' and other periodical works. He published 'An Ode on St. Cecilia's Day, adapted to British music, viz. the salt-box, the Jews'-harp, row-bones and cleavers, the hum-strum or &c., with an Introduction giving an account of British instruments.' London, 1762, 4to.

In 1767, in conjunction with Colman and Warner, he published two volumes of an Edition of Plautus, 'The Comedies of Plautus, in familiar Blank Verse.' Of the plays contained in these volumes, Thornton translated 'Amphitryon,' 'The Tartar Captain,' 'The Treasure,' 'The Miser,' and 'Shipwreck'; 'The Merchant' was translated by Warner, and 'The Captives' by Warner. The rest of the plays were translated by Warner, and were published in two additional volumes. In 1770 Thornton published 'The Battle of the Wigs, an Allegory in Canto to Dr. Garth's Poem of The Dispensary.' London, 1770, 4to. Thornton, who appears to have injured his health by habitual indulgence in drinking, died

he age of 44. There is an inscription to his memory, by Thomas Warton, in the cloisters of Westminster Abbey.

(Baker's *Biographia Dramatica*, by Reed and Jones.) THOROUGH-BASE, the art of playing (on keyed instruments, and according to the rules of harmony) an accompaniment from figures representing chords, such figures being placed either over or under the notes of the instrumental base staff. This is one of the many absurd terms employed in music, and its meaning is altogether arbitrary.

The figures used in *Thorough-Base* are the nine units. These represent certain intervals or sounds. Thus a 6 placed over a c in the base, points out A as an accompaniment: and that figure also implies two other notes attending on it, namely, the 3rd and 8th, which are called the *companiments* of the 6th. A 6 and a 5 placed under (6/5), indicate the intervals of the 6th and 5th played together; and also, as accompanying notes, the 3rd and 5th. The figures 3, 5, and 8, singly, or together, represent the perfect or common chord. But in *Thorough-Base* a base note without any figure is supposed to carry a perfect chord. Chords are, as a general rule, assigned to the right of the performer, and the intervals are, in most cases, counted from an octave above the figured note. This will be more clearly understood by referring to the tables ACCOMPANIMENT, CHORD, and HARMONY.

The following is a tabular view of the figures used in *Thorough-Base* to represent chords, together with those not written, but understood, representing the accompaniments which, with the base, form the chords:—

Figures designated by figures.	Accompanying intervals.
3rd, accompanied by a . . .	5th and 8th.
5th, " . . .	3rd and 8th.
8th, " . . .	5th and 3rd.
6th, " . . .	3rd and 8th.
6/4th, } " . . .	8th.
7th, " . . .	3rd, 5th, and 8th.
6/5th, } " . . .	3rd and 8th.
4/3rd, } " . . .	major 6th.
4/2nd, } " . . .	6th.
4th (sometimes called the 11th), accompanied by a . . .	5th and 8th.
5th, accompanied by an . . .	8th.
8th (sharp 6th)	3rd.
9th, " . . .	3rd and 5th.
9/4th, } " . . .	5th.
9/7th, } " . . .	3rd.
7 (sharp 7th)	5th, 4th, and 2nd.

Some other chords of an extraordinary kind are occasionally formed; but they are always clearly denoted, in *Thorough-Base*, by an ample number of figures.

The above chords exemplified.

When two figures are placed in succession over one base P. C., No. 1537.

note, the time of the latter is divided between them. Example:—

A sharp, or flat, or natural, placed alone over a base note, relates solely to the 3rd. Example:—

When other intervals are to be raised or lowered, the proper characters for the purpose are prefixed to them. A dash through a figure is equivalent to a sharp.

The practice of figuring a base staff, whether in a score or in the part assigned to a keyed instrument, has fallen into disuse, the harmony being now fully and clearly presented to the eye of the accompanist in notes placed in a treble staff over the base. But a knowledge of what is yet too commonly misnamed *Thorough-base*, that is to say, harmony, is absolutely indispensable to the good musician, and very much abbreviates the labour of those who, as amateurs, only aspire to a practical skill either as vocal or instrumental performers. The rules of harmony stand in the same relation to music as those of grammar do to language.

The invention of a *Figured Bass* (*Basso Cifrato*, as the Italians so well denominate it) has been stated to have taken place in 1605, and is commonly attributed to Ludovico Viadana, *Mestro di Cappella* at the cathedral of Mantua. But this kind of musical abbreviation was earlier practised, and by an English composer, Richard Deering, who, in 1597, published his *Cantiones Sacrae*, at Antwerp, in which a figured base appears. And we have now before us Jacopo Peri's serious opera *Euridice*, printed at Florence in 1600, in which the base is figured throughout. Lying by us also is Caccini's *Nuove Musiche*, likewise printed at Florence, but one year later, and here we find the base regularly figured. The edition of the latter work referred to by Dr. Burney, is dated Venezia, 1615; it is to be presumed therefore that the active historian of music was not so fortunate as to have met with the first edition of Caccini's remarkably curious and now very rare work.

THOU, JACQUES-AUGUSTE DE (or, as he called himself in Latin, Jacobus Augustus Thuanus), was born at Paris, on the 8th of October, 1553: he was the third son of Christophe de Thou, first president of the parlement of Paris, and of his wife Jacqueline Tuellen de Celi. Besides their three sons and four daughters, who grew to be men and women, De Thou's parents lost six children in infancy; and he himself was so weak and sickly a child till he reached his fifth year, that he was not expected to live. In the exemption which this state of health procured him in his childhood and early boyhood from severer task-work, he amused himself in cultivating a turn for drawing, which was hereditary in his family; and in this way, he tells us himself, he learned to write before he had learned to read. Although originally intended for the church, he went in his early studies the whole round of literature and science as then taught; and while yet only in his eighteenth year he had conceived from the perusal of some of his writings so great an admiration of the celebrated jurist Cujacius, that he proceeded to Valence in Dauphiné, and attended his lectures on Papinian. Here he met with Joseph Scaliger, with whom he contracted an intimate friendship, which was kept up for the thirty-eight remaining years that Scaliger lived. In 1572, after he had been a year at Valence, he was recalled home by his father; and he arrived in Paris in time to be present at the marriage of Henry, the young king of Navarre, and to witness the horrors of the massacre of St. Bartholomew which

followed. He relates that he saw the dead body of Coligny hanging from the gibbet on Montmartre. The next year he embraced an opportunity of visiting Italy, in the suite of Paul de Foix, who was sent by Charles IX. on a mission to certain of the Italian courts; and he remained in that country till the death of Charles, in May, 1574, and the accession of Henry III., the news of which reached them at Rome, recalled De Foix home. In 1576 he made a journey to Flanders and Holland. In 1578 he succeeded Jean de la Garde, Sieur de Saigne, as one of the ecclesiastical counsellors of the parlement de Paris—an entrance into public life which, he says, he made with reluctance, as withdrawing him in part from the society of his books and the cultivation of literature, in which he would have been much better pleased to spend his days. The next year he lost his eldest brother; and from this time it began to be proposed that, for the better chance of continuing the family, his original destination should be changed, and that he should quit his ecclesiastical for a civil career. Some years elapsed however before this scheme was finally determined upon. Meanwhile he continued to pursue his usual studies; and he states that he had already conceived the project of his great historical work, and begun industriously to collect materials for it wherever he went.

It was in the year 1582, while on a visit to Bordeaux, that he made the acquaintance of Montaigne, whose character as well as genius he has warmly eulogized. The same year his father died; and having also by this time lost his second brother, he, in 1584, resigned his rank as an ecclesiastical counsellor, and on the 10th of April was appointed by the king to the office of master of requests, which then was wont to be held indifferently by ecclesiastics or laymen. Two years after he obtained the reversion of the place held by his uncle, of one of the présidents au mortier in the parlement de Paris; and in 1587 he married Marie, daughter of François Barbanson, Sieur de Cani. When, in the next year, in the increasing distractions of the state, Henry III. found himself obliged to leave Paris, De Thou, who, as well as his father and his brothers, adhered steadily throughout the troubles of the time to the royal party, accompanied his majesty to Normandy, and afterwards to Picardy. At Chartres, in August, 1588, he was admitted a counsellor of state; and from this date he took a leading part in all the principal public transactions which followed. When the estates of the kingdom were assembled at Blois, in October of this year, De Thou, as he tells, was there courted with much blandishment by the duke of Guise, but steadily resisted the attempt to seduce him from his loyalty. He had left Blois and was in Paris when the news of the murders of the duke of Guise and his brother the cardinal (on the 23rd and 24th of December) reached the capital; and he had great difficulty in effecting his escape from the popular fury. He succeeded however in rejoining the king at Blois; and having soon after been dispatched on a mission into Germany and Italy to raise succours of men and money for the royal cause, he was at Venice when he heard of the death of Henry, in August, 1589. He immediately set out by the way of Switzerland for France, and met the king of Navarre, now calling himself Henry IV., at Châteaudun. He was received very graciously; and for some years from this time he was constantly with Henry, or employed on missions to different quarters in his service.

In 1591, while Henry was at Nantes, he received accounts of the death of Amyot, bishop of Auxerre (renowned for his translations of Plutarch and other Greek authors); upon which his majesty immediately bestowed his office of keeper of the royal library on De Thou. It was in the year 1593, as he has noted, that he at last actually commenced the composition of his History, which he now states he had conceived in his mind so long as fifteen years before. In 1594 the death of his uncle opened to him his reversionary office of one of the présidents of the parlement de Paris.

Among other important transactions in which he had a part after this, was that of the Edict of Nantes, published in 1598, which he was greatly instrumental in arranging. He has left an account of his own life, in ample detail, down to the year 1601, in which the last event he notices is the death of his wife, in August of that year. In 1604 he published the first eighteen books of his 'History.' The

work was received with general applause by the public throughout Europe, and, although some theologians gave umbrage to the more zealous friends of the Roman Catholic faith, it was not till several years afterwards when a second portion of it had been published, that it was formally stigmatized by being inserted in the *Index Expurgatorius.* De Thou however severely felt the authoritative condemnation of his performance, when it did take place, in November, 1609. The death of Henry IV., in 1610, did not deprive De Thou of his place in the ministry; but he had no longer the same influence as before; and a new appointment, which he received the following year, of one of the three directors charged with the management of the finances, on the retirement of the great Sully, was felt by himself to be not so much an accession of power or honour, as a burdensome and obnoxious office forced upon him, for which he was fitted neither by tastes, habits, nor qualifications. In this same year his brother-in-law, Achille de Harlay, resigned his office of first president of the parlement de Paris, in the hope that De Thou would be nominated his successor; but the place was given to another. These disappointments and disgraces, together with the loss of a second wife, are supposed to have shortened the life of De Thou, who died at Paris on the 7th of May, 1617, in his sixty-fourth year. By his second wife, whose family name was de Bourdeilles, he left three sons and three daughters, one of the former of whom, François Auguste de Thou, the inheritor of his father's virtues and of a considerable share of his talents, fell a sacrifice to the inexorable revenge of Cardinal Richelieu, one of whose last acts was his putting this unfortunate young man to death for his alleged participation in what was called the conspiracy of Cinquars:—he was executed at Lyon, in his thirty-fifth year, on the 12th of September, 1642, not three months before Richelieu's own death.

The president De Thou is the author of a number of Latin poems, one of the principal of which, entitled 'De Re Accipitraria' (on Hawking), was published in 1584; but his fame rests upon his 'Historia sua Temporis,' or 'History of his own Time,' written also in Latin, in 138 books, of which the first 80 appeared in his lifetime, the remainder not till 1621. The space over which it extends is from the year 1544 to 1607, comprehending the closing years of the reign of Francis I., the entire reigns of Henry II., Francis II., Charles IX., and Henry III., and nearly the whole of that of Henry IV. For about one-half of this period of sixty-three years he has the value belonging to the narrative of one who was himself a principal actor in many of the affairs which he relates, and who with regard to many others was so placed as to have an opportunity of seeing much that was concealed from the common eye; but in truth, from the author's family connections, and his extended acquaintance among the eminent and remarkable persons of his time, this is an advantage which belongs in some degree to the earlier as well as to the later part of the work. It is also admitted to have throughout the merit of a rare impartiality: with no deficiency of patriotic feeling, and perfect steadiness to his own political principles, De Thou is always ready frankly to recognise the high qualities of whatever kind, that may have belonged either to the citizen of a rival state or a party opponent. As for religious prejudice, he shows so little of that, as to have exposed himself to the imputation of having no religion, or at least of not being really a believer in the form of Christianity, the Roman Catholic, which he professed. But for either of these charges there seems to be no ground. The reputation of his 'History' however stands not so much upon the facts contained in it that are not elsewhere to be found, as upon the skill displayed in its composition—and so much upon the material as upon the workmanship; and it is very evident that with all the pains he took in the collecting of information, this was the praise of what he was the most ambitious, as indeed may perhaps be said to have been the case with the most famous historians of every age and country, from Herodotus and Thucydides among the Greeks, and Livy and Tacitus among the Latins, to Hume and Gibbon among ourselves. But De Thou's manner of writing, though flowing and eloquent, is not very picturesque; and of course he also loses something in raciness and natural grace, ease, and expressiveness, by writing in a dead language. De Thou's Latin style, with all its merit, is not admitted to be faultless, though he has

taken great pains to give it as uniformly classical an air as possible, not only by metamorphosing all his modern names, both of places and persons, so as to give them antique forms, often to the no small perplexity and hindrance of the reader, but, what sometimes produces still more obscurity or ambiguity, by generally endeavouring to describe modern proceedings and transactions in the established legal, political, and military phraseology of the old Romans. The best edition of De Thou's 'History' is that published at London in 1733, in seven volumes, folio, under the superintendence of Samuel Buckley, Esq., and at the expense of Dr. Mead. The last volume of this edition contains De Thou's autobiographical memoir (first published in 1620, and also written in Latin), in six books, together with a mass of additional materials illustrative of the history of his life and works.

THOUARS. [SEVRES, DEUX.]

THOUARS, LOUIS MARIE AUBERT DU PETIT, an eminent French botanist, was born at the château de Boumois, in Anjou, 1756. His family was wealthy and noble, and being destined for the army, he was early sent to the school of La Flèche. He was made a lieutenant of infantry at the age of 16. This was in a time of peace, and he occupied his leisure in studying the science of botany and its literature. At the time of the loss of La Perouse and his companions, Aristide du Petit Thouars proposed to his brother Aubert that they should go in search of him. To this he willingly consented, hoping to add to his stock of plants and his fame by the voyage. The two brothers sold their patrimony, raised a subscription, and having secured the patronage of Louis XVI., were ready to start on their voyage, when a curious accident separated them. The ship that was to have taken them lay at Brest, and Aubert, with his vasculum (the tin box which botanists carry to put their plants in) at his back, intended to botanise on his way from the capital to the port. He was however found by some *gens d'armes* in the woods, and being suspected as an enemy of his country in those days of disorder, he was arrested and thrown into prison at Quimper. He was however soon released, but too late, as his brother had sailed. He followed him to the Isle of France, but his brother had again departed; and being here without money and without friends, his only resource was his botanical knowledge, and he accordingly applied for employment to some of the rich planters of that island. He quickly obtained an engagement, and remained in the island nearly ten years. On this spot he was very favourably placed for making those observations for which his previous studies had so well prepared him; and during his stay here he collected most of the materials for the numerous works which he published on his return. Whilst a resident in the Isle of France he made a voyage to Madagascar, and collected plants from that island. He returned to Paris in 1802. Many of the results of his researches in the Isle of France and Madagascar were communicated to the Institute and other scientific bodies in Paris. His first work on the botany of the islands which he had visited, was published at Paris in 1804, with the title 'Plantes des Iles de l'Afrique Australe formant des Genres nouveaux,' &c., 4to. He also published on the same subject the 'Histoire des Végétaux des Iles de France, de Bourbon, et de Madagascar,' 1804, 4to. In the same year Bory St. Vincent gave an account of the vegetation of the African islands, in his 'Voyage dans les quatre principales Iles des Mers l'Afrique,' Paris, 4to., although he did not go out till Du Petit Thouars had returned. In 1806 Du Petit Thouars was appointed director of the royal nursery-ground at Paris, which office he held till the closing of his institution a short time before his death, which took place in May, 1831. In 1806 he published another work on the plants of Africa, with the title 'Histoire des Végétaux recueillis dans les Iles Australes d'Afrique,' Paris, 4to. In 1810 his 'Genera nova Madagascariensia' appeared, in which the Madagascar plants were arranged according to the system of Jussieu. His latest work on systematic botany was one on the Orchidaceæ of the African islands, 'Histoire des Plantes Orchidées recueillies dans les trois Iles Australes d'Afrique,' 1822, Paris, 8vo. His publications on vegetable physiology are equally numerous. Most of these had their foundation in observations and experiments which he made whilst in the Isle of France. In 1803 he published his 'Essai sur l'Organisation des Plantes,' Paris,

8vo.; in 1809, another essay on the vegetation of plants; in 1811, 'Mélanges de Botanique et de Voyages,' Paris, 8vo.; in 1819, a kind of botanical miscellany, passing in review his own labours, under the title 'Revue générale des Matériaux de Botanique et autres, fruit de trente-cinq années d'observations,' Paris 8vo.

As a systematic botanist the views of Du Petit Thouars were uncertain and speculative, and the delay in the publication of his works on African botany deprived him of the merit of introducing to the world many new species. In his physiological works his views are ingenious, but in most cases wanting in sufficient data to establish them. His views on the formation of buds, the motion of the sap, and the origin of wood, are those which have excited most attention. But each of these is perhaps more indebted to the speciousness of its reasoning than to the correctness of the facts, for the importance that botanists have attached to it. But at the same time his great activity of mind, his extensive erudition and original observation, have had a great influence on the progress of botany in the present century. He was a contributor to the 'Biographie Universelle,' and wrote the lives of many of the botanists in that work. The genus of plants *Thouarea* was named after him, and Bory St. Vincent named *Aubertia* in honour of him.

(*Biog. Univ.*, *Supp.*; Bischoff, *Lehrbuch der Botanik.*)

THOURET, MICHEL-AUGUSTIN, an eminent French physician, was born in 1748, at Pont-l'Évêque, in the ancient province of Normandy and the modern department of Calvados, where his father was royal notary (*notaire royal*). His education was commenced at his native town, and finished at the university of Caen. He afterwards went to Paris, and in 1774 was admitted gratuitously by the Faculty of Medicine in that city to the degree of M.D., an honour which was gained by public competition (*concours*). A few years later, upon the foundation of the Royal Society of Medicine, Thouret became one of its earliest members, and enriched the Memoirs of the Society by several valuable essays. The most important public work in which he took a part was the exhumation of the bodies in the cemetery of the Holy Innocents, of which he drew up a most interesting report. This cemetery, together with a church of the same name, stood on the spot now occupied by the Marché des Innocens, and had become in process of time so unhealthy from being the principal burial-ground in Paris, that it was absolutely necessary to destroy it. This great work had been several times attempted, but as often abandoned on account of the dangers and difficulties of the undertaking; at last however, in 1785, a committee was named for directing the works, which were carried on without any intermission by night and by day for more than six months, and which were at length completely successful. Thouret afterwards filled several public situations with equal zeal and integrity; and in the midst of the labours of his numerous employments was carried off, after a few days' illness, by a cerebral affection, at Meudon, near Paris, June 19, 1810. Great honours were paid him after his death by the Faculty of Medicine at Paris, of which body he was dean. His works consist almost entirely of essays published in the 'Histoire et Mémoires de la Société Royale,' of which perhaps the most interesting are the 'Rapports sur les Exhumations du Cimetière des SS. Innocens,' mentioned above. These were afterwards published in a separate form at Paris, 1789, 12mo. (*Biographie Médicale.*)

THOURET is a town in the province of West Flanders, in the kingdom of Belgium, in the district of Bruges, on the high road from that city to Menin and Courtray. It is a well-built town, with a population of 8000 inhabitants, who have a considerable trade in linen, flax, and linseed. They also manufacture hats, starch, and wooden shoes. [FLANDERS, WEST.] (Stein, *Lexicon*; Schulz, *Allgemeine Erdkunde*, vol. xvii.)

THRACE (Θράκη, *Thracia*) was in earlier times the name of the country bounded on the north by the Danube, on the south by the Propontis and the Ægean Sea, on the east by the Black Sea, and on the west by the river Strymon and the chain of mountains which form the continuation of Mount Rhodope. This country is divided into two parts by Mount Hæmus (now the Balkan), which runs from west to east, separating the plain of the lower Danube from the rivers which flow into the Ægean Sea. This mountain probably derived its name

from its cold and snowy top, since Hæmus seems to contain the same root as the Sanscrit *hima*, 'snow,' whence also comes the name of the Himālaya Mountains. Two extensive ranges branch off from the southern side of Mount Hæmus: one at about a hundred miles from the Euxine, which runs in a south-eastern direction towards Constantinople; the other, which is far larger, branches off near the sources of the Hebrus, and likewise runs to the south-east. The latter bore the name of Rhodope, and is now called the Despoto Mountains. Between these two ranges there are many plains, which are drained by the Hebrus (the Maritza), the principal river of Thrace, and its tributaries. For a further account of the physical geography the reader is referred to the articles BALKAN MOUNTAINS and MARITZA.

In ancient times there was a great quantity of corn and wine grown in the valley of the Hebrus. In the 'Iliad' the ships of the Achæans are described as bringing wine every day to Agamemnon from Thrace (ix. 72); and the Maronean wine, which retained its reputation in the time of Pliny (*Hist. Nat.*, xiv. 6), is spoken of in the 'Odyssey' (ix. 197). In the mountainous parts of the country there were also mines of precious metals. (Justin, viii. 3.)

The Thracians were divided into many separate and independent tribes; but the name of Thracians seems to have been applied to them collectively in very early times. Thrace, according to Stephanus Byzantinus (*s. v. Θράκη*), was previously called Perce (*Πέρκη*). It signifies any country in the north, according to Ukert (*Geographie von Griechen und Römer*, I, i., p. 282), who quotes the remark of Andron of Halicarnassus (*Schol. ad Lycophr.*, 894, 1283), that Oceanus had four daughters, Asia, Libya, Europa, and Thrace, from whom the four parts of the world were named; and thence he concludes that Asia signified the east, Libya the south, Europa the west, and Thrace the north. This conclusion however hardly amounts to a small probability. Josephus and many Biblical scholars suppose that the name is derived from Tiras (טִירָס), the

son of Japhet (*Genesis*, x. 2), but this opinion rests on little more than an apparent similarity of sound.

The Thracian nation, according to Herodotus (v. 3), was, next to the Indians, the most numerous of all, and if united under one head would have been invincible. He observes that the usages of the different tribes were similar, with the exception of the Getæ [Γετæ], the Trausi, and those who dwell above the Crestonæi. The account which he gives of the most striking national peculiarities of the Thracians, represents them as a barbarous and savage people, which is supported by other ancient writers, though the districts on the southern coast seem to have attained to some degree of civilization, owing to the numerous Greek cities which were founded there at various times. The Thracians, says Herodotus (v. 6), sell their children to be carried out of the country as slaves; they do not guard their young women, but permit them to have intercourse with whatever men they please; they purchase their wives with great sums; they puncture or tattoo their bodies, which they regard as a sign of noble birth; agriculture they despise, and consider it most honourable to live by war and robbery. Deep drinking prevailed among them extensively, and the quarrels over their cups became almost proverbial. (*Hor., Carm.*, i. 18 and 27.) In earlier times, however, there must have been a greater degree of civilization among some of their tribes at least, than prevailed at a later period. The earliest Greek poets, Orpheus, Linus, Musæus, and others, are all represented as coming from Thrace; and Eumolpus too, who founded, according to tradition, the Eleusinian mysteries at Attica, is also said to have been a Thracian. At an early period likewise the Thracians spread extensively over southern Greece. Thucydides (ii. 29) says that they once dwelt in Phocis; Strabo (ix. 401, 410) speaks of their settlement in Bœotia; and their invasion of Attica under Eumolpus, who fought against Erechtheus, is mentioned by many writers. (Strabo, vii. 321; Thucyd., ii. 15; Pausan., i. 38.)

The Thracians are said to have been subdued by Sesostris (Herod., ii. 103), and subsequently by the Mysians and Teucrians, who crossed over into Europe before the Trojan war, and penetrated as far as the Ionian Sea and the Peneus. Herod., vii. 20. But the first real historical event respecting them is their conquest by Megabazus, the general of Darius, who conquered all the separate

tribes, with the exception of the Satræ, who were the only Thracian people that had retained their independence down to the time of Herodotus. (Herod., v. 2: vii. 11.) After the failure of the expedition of Xerxes, the Thracians appear to have recovered their independence, and in the time of the Peloponnesian war we find a powerful native empire in Thrace, which was under the dominion of Sitalces, who is called by Thucydides (ii. 29) king of the Thracians. This empire was founded by the father of Sitalces, Teres, the king of the Odrysæ, one of the most powerful of the Thracian tribes. It extended along the coast from Abdera to the mouth of the Danube, a distance of four days' and four nights' sail with a favourable wind, and was by land a journey of eleven days, by the shortest road for an active man: it extended inland from Byzantium to the Læsei and the Strymon, a journey of thirteen days. The tribute paid to Seuthes, the successor of Sitalces, was 400 talents, besides a great number of presents to himself and the Odrysian nobles. Thucydides says that of all the kingdoms between the Ionian Gulf and the Euxine, this was the greatest in revenue and opulence, but that it was inferior to the Scythians in military strength and numbers. In the third year of the Peloponnesian war, B.C. 429, Sitalces, who had formed an alliance with Athens, invaded the territories of Perdiccas, king of Macedonia, with an army of 150,000 men; but being disappointed of the co-operation of an Athenian fleet, he was persuaded by his nephew Seuthes to accept the overtures of Perdiccas, and return home with his army, after remaining in Macedonia thirty days. In the year B.C. 424, Sitalces fell in battle against the Triballi, the most powerful Thracian people between Mount Hæmus and the Danube, and was succeeded by his nephew Seuthes. The power of the Odrysian empire however did not last long. In little more than twenty years from the death of Sitalces it had lost its former greatness; and when Xenophon crossed over into Thrace, in B.C. 400, he found Medorus, the reigning king of the Odrysians, unable to command the obedience of his Thracian subjects. (Compare *Isid.*, 2, s. 32, &c.) In the reign of Philip, the father of Alexander, Cotys was the most powerful of the Thracian and is usually called king of Thrace; but he was deposed by Philip of almost all his dominions between the Strymon and the Nestus, and became little else than a vassal of the Macedonian kingdom. He was a savage and vindictive barbarian, and was assassinated in B.C. 358. His son Cersobleptes succeeded to the throne; but he was eventually stripped of all his territories by Philip, who reigned in B.C. 343, the whole of Southern Thrace at least, and compelled it to pay tribute. (Diodorus, xvi. 71. On the death of Philip there was a general movement among the Thracians to throw off the Macedonian supremacy, at the head of which the Triballi placed themselves. But Alexander, by his activity, suppressed this rising; he crossed the Hæmus, marched into the country of the Triballi, and, after defeating them, advanced as far as the Danube, which he crossed, and offered up a sacrifice on its north bank. (Arian, *Anab.*, i. 2, 3; Strabo, vii. 301.) On the death of Alexander, Thrace fell to the share of Lysimachus, who erected it into an independent monarchy; but it subsequently came under the dominion of the Macedonian kings. They seem however to have left the country under the government of its native rulers, and were probably contented with what the Greeks called a hegemony. In the Roman war against Perseus, Cotys, king of the Thracians, is mentioned as an ally of Perseus; though the Thracians, just before the war broke out, had sought the alliance of the Romans. (Livy, xlii. 29, 51; compare xlii. 19.) At the conclusion of the war, however, Cotys was allowed to continue in possession of his kingdom, notwithstanding the assistance he had rendered to Perseus. (Livy, xli. 4.)

At what time Thrace was reduced to the form of a Roman province is uncertain, but it seems not to have constituted a distinct province till a late period. Under Augustus, the part of Thrace north of the Hæmus was conquered by the Romans, and was afterwards erected into a separate province under the name of *Mœsia*. (Mœsia.) The name of Thrace was then confined to the country south of the Hæmus, and between the Euxine, the Propontis, and the Ægean Sea. Its boundary on the west differed at various times: in the time of Ptolemy (iii. 11) it seems to have been the Nestus; but as the Strymon was anterior to the boundary between Macedonia and Thrace, it will be

inconvenient, in the following description of the principal cities in Thrace, to consider the district between the Strymon and the Nestus as belonging to the latter country.

Beginning then on the left bank of the Strymon, the first town we come to is Amphipolis, which was founded by the Athenians, and was one of the most important towns in Thrace. [AMPHIPOLIS.] It was situated in the country of the Edones, who dwelt between the Strymon and the Nestus, but originally inhabited the Macedonian city of Mygdonia. (Thucyd., ii. 99.) The next town of importance east of Amphipolis was Philippi, which was founded by Philip of Macedonia: it was previously called Crenides, but was then only a small place inhabited by the Thasians, who settled there for the purpose of working the gold and silver mines in its neighbourhood. West of Philippi the country was an extensive plain stretching towards Amphipolis, which has become memorable on account of the battle fought there by Antony and Octavius (Augustus) against Brutus and Cassius. Under the Romans Philippi became a colony, and was the chief city in that part of the country, when it was visited by the Apostle Paul. (*Acts*, xvii. 12.) It still bears the name of Filibi, but is only a village.

West of the Nestus the first town of importance on the coast is Abdera. [ABDERA.] Next comes Dicæa or Amphipolis, which was a Greek city on the shores of the Euxine (Herod., vii. 109); and then Maroneia and Ismarus, which were both in the country of the Cicones, where Ulysses landed and was defeated by the inhabitants, before he had taken their city. (*Odys.*, xi. 39, &c.) The Thracian wine has been already mentioned, and the city was in consequence sacred to Dionysus, as may be seen from its coins. It was originally called Orthagoria. Its ruins are still named Maroni. Ismarus is not mentioned by later writers as a city, but only as a mountain celebrated for its wine. Following the coast we next come to Cardy, a colony of the Thasians; then to Mesembria, built by the Samothracians (Herod., vii. 108); and next to Doriscus, situated in a large plain, in which Xerxes numbered his army. (Herod., v. 59.) Crossing the Hebrus we come to Ænos, which, according to Virgil (*Æn.*, iii. 17, &c.), was founded by Æneas, but it is mentioned under his name by Homer, as the place from which Pirous came in the Trojan war (*Il.*, iv. 520). It was a place of considerable importance in later times, and under the Romans as a free town. (Pliny, *Nat. Hist.*, iv. 18.) It is still called Enus.

After passing round the head of the Gulf of Melas, now the Gulf of Saros, we come to the Thracian Chersonese (ἡ χερσόνησος, or Κερσόνησος ἢ ἐν Θράκη), now Gallipoli, which was very early colonized by Greek settlers, and though but of small extent is of considerable importance in ancient history. In early times it was inhabited by the Peloponnesians, a Thracian tribe, who being hard pressed in war by the Apsinthii, were led to invite Miltiades, the son of Cypselus, an Athenian, to be their king, in consequence of an answer given them by the oracle at Delphi. This was about the year B.C. 560. Miltiades complied with their request, and took with him to the Chersonese a colony of Athenians. On his death he was succeeded by his nephew Megacles, and he by his brother Miltiades, the son of Cimon, who fled to Athens to escape the vengeance of the Athenians, on account of the advice he had given to the Persian chiefs in the Scythian expedition of Darius. (Herod., i. 34, &c.) [MILTIADES.] When the Persians were driven out of Greece, the Chersonese came into the hands of the Athenians, who retained it till the end of the Peloponnesian war. Shortly afterwards the Lacedæmonians, at the request of the inhabitants, built a strong wall across the isthmus to protect the country from the incursions of the Thracians. (Xenoph., *Hell.*, iii. 2, s. 8-10.) It subsequently came under the power of Athens, who wrested it from Cersobleptes, the son of Cotys, when he was deprived of his other dominions by Philip. Afterwards it formed part of the kingdom of Lysimachus, who founded the city of Lysimachia on the isthmus, which he made his capital. It was on the western side of the isthmus, not far from the ancient Cardia, the inhabitants of which he removed to his new city. (Diodorus, xx. 29; Pausan., i. 9, s. 10.) South of Lysimachia were Agora, Ide, Pæon, and Alopeconusus, the last of which only was of any importance. It was an Æolian colony, and was one of the chief towns of the Chersonese in the time of Demosthenes. On the

eastern side of the Chersonese, upon the Hellespont, the most southerly town was Cynossema, near which the Lacedæmonian fleet was defeated by the Athenians under the command of Thraaybulus and Thraayllus, in B.C. 411. (Thucyd., viii. 104, &c.) Above Cynossema was Madytus, which was also one of the chief towns of the Chersonese in the time of Demosthenes (Demosth. *pro Cor.*, p. 256); and north of Madytus was Sestos. [SESTOS.] North of Sestos was the small river of Ægospotamoi, with apparently a town of the same name at its mouth, near which the Athenian fleet was totally defeated by Lysander, in B.C. 405, who was enabled in consequence to obtain possession of Athens and put an end to the Peloponnesian war. Above Ægospotamoi were Callipolis, now Gallipoli, which has given its name to the peninsula, and Pactya, opposite Lysimachia.

As the other towns are not of so much importance as the preceding, a brief notice of them will be sufficient. On the Propontis the chief seaport was Perinthus, afterwards called Heraclea, and sometimes also Heraclea Perinthus. (Zosimus, i. 62; Diodorus, xvi. 76.) On the Bosphorus (not Bosphorus, as it is frequently, but incorrectly, written in modern maps and works), which connected the Propontis and the Euxine, the ancient Greek city of Byzantium was situated, which occupied part of the site of the modern Constantinople. [BYZANTIUM.]

On the European coast of the Euxine the chief towns were Salmydessus, Apollonia, and Mesembria. The two former were colonies of the Milesians, and the last of the Megarians. (Strabo, vii., 319.)

In the interior of the country the towns most worthy of mention are Trajanopolis, on the Egnatian road to the west of the Hebrus; Plotinopolis, so called in honour of Plotina, the wife of Trajan, to the north of Trajanopolis; Hadrianopolis, on the Hebrus, originally called Orestias, and now Adrianople [ADRIANOPLE]; and, lastly, Philippi, also on the Hebrus, now called Filibi. The names of these towns sufficiently show by whom they were built or enlarged.

The Via Egnatia, which was the great road of communication between the Ionian Sea and Byzantium, and which is spoken of under MACEDONIA (p. 243), entered Thrace at Amphipolis, and passed by the towns of Philippi, Neapolis, Abdera, Maximianopolis, Trajanopolis, Cypsela, Apri, Heraclea, till it reached Byzantium.

Xenophon, in his 'Anabasis' (vi. 4), speaks of Thrace in Asia, which he describes as extending from the junction of the Bosphorus and the Euxine along the Asiatic coast as far as Heracleia: the country within these limits was inhabited by Thraciæ Bithyni. The harbour of Calpe was about the middle of this coast-line. [BITHYNIA.]

THRACIA, Dr. Leach's name for a genus of testaceous mollusks described as intermediate between *Anatina* and *Mya*, and as having some resemblance to *Corbula*.

THRAPSTON. [NORTHAMPTONSHIRE.]

THRASÆTOS, Mr. G. R. Gray's name for a genus of Eagles, *Harpyia*, Cuv., *FALCO destructor*, Daud. [FALCONIDÆ, vol. x., p. 174.]

THRA'SEA PAETUS. His prænomen is uncertain; some writers call him Lucius, and others Publius, but he is generally called simply Thrasea Paetus or Thrasea. He was a native of Patavium, Padua (Tacitus, *Annal.*, xvi. 21; Dion Cass., lxiii. 26), and, like most men of talent at the time, he went to Rome, where he afterwards became a senator and a member of the priestly college of the quindecimviri. The first time that Thrasea came prominently forward in the senate was in A.D. 59, when a senatus-consultum was passed by which the city of Syracuse obtained permission to employ a greater number of gladiators in the public games than had been fixed by a law passed in the time of J. Cæsar. (Tacitus, *Annal.*, xiii. 49; Dion Cass., liv. 2; Sueton., *Caes.*, 10.) Although the matter was of no importance, Thrasea took an active part in the deliberation, merely to impress upon his colleagues the necessity of paying attention even to the smallest matters belonging to the administration of the senate. In the same year Nero determined to carry into effect his design of getting rid of his mother Agrippina. [NERO; AGRIPPINA.] When the crime was committed, and when the emperor sent a letter to the senate in which he endeavoured to exculpate himself, the degraded senators congratulated him upon having got rid of so dangerous a woman. The only man who on that occasion had the

courage to show his detestation of the crime was Thrasea. (Dion Cass., lvi. 15; Tacit., *Annal.*, xiv. 12.)

In the year A.D. 62, when the praetor Antistius was charged by Cossutianus Capito with high treason for having composed and read at a numerous party of friends some libellous verses upon the emperor, and when the emperor showed an inclination to interfere in the trial, Thrasea boldly claimed for the senate the right to try the case according to the existing laws. The firmness of Thrasea induced most of the senators to follow his example and to vote with him. Cossutianus was thwarted in his hope of getting Antistius sentenced to death, and the emperor, though highly annoyed, endeavoured to disguise his anger. (Tacitus, *Annal.*, xiv. 48, 49.) A short time afterwards Thrasea again attracted general attention in the senate by a speech against the assumption and insolence of wealthy provincials. It had at that time become customary with the provincials to request the Roman senate, by embassies, to offer public thanks to the pro-consuls who returned from their province, and who had conducted the administration to their satisfaction. The ambition to gain this distinction often deprived the pro-consuls of their independence, and degraded them into flatterers of influential provincials, who thus obtained an improper power. Thrasea proposed to the senate a measure to remedy the evil, but although it met with general approbation, he did not succeed in making the senate pass a decree, which was however done shortly after on the proposal of Nero himself. (Tacitus, *Annal.*, xv. 20-22.) Nero already hated Thrasea, and envy now began to increase the hatred. When therefore, in A.D. 63, Poppaea, the wife of Nero, was expecting her confinement at Antium, and all the senators flocked thither to wait for the event, Thrasea was forbidden to go there. The Stoic philosopher bore this insult with his usual calmness. Nero afterwards indeed declared to Seneca that he was reconciled to Thrasea, but this was probably no more than an expression of his fear. The inflexible character of Thrasea, his refusal to take any part in the degrading proceedings of the senate, and the esteem which he enjoyed among his contemporaries, increased the hatred of Nero, who only waited for a favourable opportunity to get rid of him. It appears that from the year A.D. 63 Thrasea never attended the meetings of the senate. Three years thus passed away, when at length, in A.D. 66, his old enemy Cossutianus brought forward a number of charges against Thrasea, the substance of which was, that he took little or no part in public affairs, and that when he did so, it was only to oppose the measures of the government; that he was a secret enemy of the emperor, and fulfilled neither his political duties as a senator nor his religious duties as a priest. Thrasea first requested a personal interview with the emperor, which was refused. He then wrote to him, asking for a statement of the charges against him, and declaring that he would refute them. When Nero had read this letter, instead of which he had expected a confession of guilt and an humble petition for pardon, he convoked the senate, to decide upon the charges against Thrasea and others. Some of Thrasea's friends advised him to attend the meeting, but most dissuaded him from it. One young and spirited friend, Rusticus Arulenus, who was tribune of the people, offered to put his veto upon the *senatus-consultum*, which however Thrasea prevented. The philosopher now withdrew to his country-house. In the senate, which was surrounded by armed bands, the quaestor of the emperor read his oration, whereupon Cossutianus and others began their attacks upon Thrasea. The wishes of Nero, and the presence of armed soldiers ready to enforce them, left the senators no choice, and it was decreed that Thrasea, Soranus, and Servilia should choose their mode of death, and that Helvidius, the son-in-law of Thrasea, and Paconius, should be banished from Italy. The accusers were munificently rewarded. Towards the evening of this day the quaestor of the consul was sent to Thrasea, who had assembled around him a numerous party of friends and philosophers; but before he arrived, a friend, Domitius Cæcilianus, came to inform him of the decree of the senate, which spread consternation among all who were present. Thrasea's wife Arria, who was a relative of Persius the poet (*Vita A. Persii Flacci*), was on the point of making away with herself, but her husband entreated her not to deprive her daughter of the last support which now remained to her. When at

length the quaestor arrived and officially announced the decree, Thrasea took Helvidius and his friend Decimus to his bed-room, and had the veins of both his arms opened; and when the blood gushed forth, he called out, 'Jove, my deliverer, accept this libation.' Tacitus, *Annal.*, xvi., 21-35; Dion Cass., lxi., 28.

Thus died Thrasea, according to the unanimous consent of the ancients a man who professed the genuine and stern virtues of the olden time in the midst of a degenerate age. Tacitus calls him virtue itself, and even Nero is reported to have said, 'I would that Thrasea liked me as much as he is a just judge.' (Plutarch, *Rei Publicae græcæ Præcepta*, p. 810, A. ed. Frankf.; comp. Martial, i., Juvenal, v. 36; Pliny, *Epist.* viii. 22.) The principles which guided him through life he had imbibed from the Stoic philosophy. Cato the younger was his favourite character in the history of the Roman republic; he wrote *Life of Cato*, which Plutarch made use of in his biography, and thus we probably still possess the substance of it. (Plutarch, *Cato Min.*, 25 and 37; compare Heeren, *De Fontibus Plutarchi*, p. 168.) Rusticus Arulenus wrote a work on Thrasea and Helvidius, in which he characterised them as men of the purest integrity—an expression which became fatal to the author. (Sueton., *Domit.*, 10, Tacitus, *Agric.*, 2 and 45.)

THRASHING. The separation of the grain from the ear in corn has always been one of the most laborious operations on a farm. Where the quantity grown is merely sufficient to supply food for the cultivators of the soil, the simplest methods answer the purpose sufficiently. The corn taken by handfuls may be beaten on a piece of wood or a table, and by repeatedly turning the straw the whole of the grain may be readily beaten out. This mode of thrashing is still adopted in order to obtain the finest and ripest grains for seed; but then the straw is afterwards thrashed over again with the *flail*, which is the instrument most generally adopted for thrashing corn. It is needless to describe this instrument, which is so generally known. It requires some practice to use it effectually and to avoid accidents to the thrasher himself or the bystanders. The flail being swung round the head, the beating part of it is made to fall horizontally on the straw which is spread on the thrashing-floor; and, by inserting the part occasionally under the straw, it is turned over and a new portion is brought up to be beaten. This is done without losing the stroke or time when several men are thrashing together. If it were not that thrashing is mostly done in winter, when no out-door work could well be done, few labourers would submit to its toil; and it is very difficult to ensure the entire separation of the grain without great vigilance and attention on the part of the master or overseer. If the labour is paid by the day, much time is usually lost; and if it be by the quantity of grain thrashed or by the number of sheaves, there is a great temptation for the men to hurry over the work, as more grain is thrashed out at first when the ears are full than afterwards.

Where the corn is thrashed out immediately after harvest, to be put into a granary, as is the case in those countries where extensive tracts of rich land are sown with corn two or three times without much tillage or manuring, and then left to be recruited by several years' rest and pasture, the most common practice is to level a portion of a field, and laying the corn in the straw in a large circle, to drive oxen and horses over it till it is all trodden out. This is the method alluded to in Scripture, and can only take place where the climate is serene and dry. Till ingenuity had produced machines to supersede the flail, this was the only instrument in use. The first idea of a machine for thrashing was that of imitating the motion of the flail, but so much depends on the eye of the thrasher, that no mechanism could well imitate the motion of his arms. This was consequently given up, and an imitation of the rubbing of the grains from the ears between the hands, combined with the beaters of a flax dressing-machine, gradually produced the present improved thrashing-machine.

Without a figure it would be difficult to describe the different parts and motions of a thrashing-machine. They are however now so common, that it will suffice to give the general principle of action, and to mention some of the latest improvements in it. A rapid motion is given to a hollow cylinder round a horizontal axis: on the outer surface there are projecting ribs parallel to the axis of

ances from each other; the width of these is to six inches. Around half the cylinder is a mer surface of which is lined with plates of cast-iron in the direction of the axis. The ribs are not quite close to these grooves, so that an ear or other corn cannot well pass between them being flattened. The sheaves of corn, having been drawn on a slanting table, and in some cases are drawn in between two iron rollers, of which one is and the other fluted. The motion of these rollers is slow, while that of the cylinder or drum is very rapid. The beaters act on the straw as it comes through the rollers, and beat out most of the corn; but what remains is carried in between the beaters and the fluted rollers, when it has made half a revolution all the grain is beaten and rubbed out. It falls on a sieve which allows the grain to pass through, but retains the straw, which is then gathered up by hand or by circular rakes moved by the rollers.

Some of the best implement-makers in England have found the two rollers superfluous, and have been able to dispense with them. The straw is at once broken up by the beaters, and the machine may be fed less rapidly according to circumstances. It requires little more attention in the person who feeds it than in the case of the ordinary threshing-machine, but more work is done and some power is saved. The great perfection of a thrashing-machine is to thresh the grain and to break the straw as little as possible, and to do this the larger the scale of the machine the better it is.

Hand-machines have been made on the same principle, but they do not effect any saving in the expense, and many men to produce the effect of one horse. The advantage of hand-machines is that men and boys can be employed to thrash who could not use the ordinary machine. Moveable thrashing-machines are very much in use in England where farms are small. They are the property of an industrious labourer or mechanic who undertakes to superintend the work, the thrashing is done by the hired men. Thus he goes from farm to farm and earns his livelihood from a small capital laid out in the purchase of a machine. The price of thrashing is about half of what is usually paid for thrashing with the flail; it is more rapidly done, there is less loss of grain, and fewer grains remain in the straw. On very large farms it has been found economical to employ a steam-engine to work the thrashing-machine, and other domestic implements. Where there is a great saving. A steam-engine is used to keep it in order. When not working, the cost of the original price is the only loss, whereas with a hand-machine it is fed whether they work or not. The price of thrashing is so much reduced and their construction simplified, that they will probably soon form an important part of the implements on every farm.

There are some thrashing-machines on a new principle which are said to work well. The drum is furnished with pikes, and similar spikes are fixed into the cover, so that the corn falls in the intervals between the first. The corn is drawn in by the spikes on the drum, which rotates rapidly, and the ears being beaten in all directions by the revolving spikes, the grain falls out of the drum and is collected below. Such a machine was exhibited at the Agricultural Meeting at Cambridge in 1840, and was found to be more adapted to break the straw more, and to be more apt than the machines in general use. These will no doubt be made gradually simpler and cheaper, till they supersede the flail, even in very small farms.

THRASYBULUS (*Θρασύβουλος*), the son of Lycus, was a noble in Attica. In the year B.C. 411 the oligarchy at Athens gained the ascendancy, and formed a council of 400 members. The oligarchs in the fleet at Samos endeavoured to bring about a similar oligarchy there, but their efforts failed; and among the democrats exerted themselves to maintain the democratical constitution, Thrasybulus, who then had the command of the fleet, was foremost. He and his friend Thrasyllus compelled the oligarchs to swear to keep quiet, and not to make any alteration in the constitution. The generals known to belong to the oligarchs were removed, Thrasybulus and Thrasyllus were appointed in their stead, and he army under their command assumed the rights of the people of Athens, and in an assembly of the people Thrasybulus got a decree passed, by which Alcibiades had lately been the chief support of the demo-

cratic party, and who was living in exile with Tissaphernes, should be recalled. Thrasybulus set out to fetch him to the camp. (Thucydides, viii. 81.) In 410 B.C. he greatly contributed to the victory which the Athenians gained in the battle of Cyzicus. In B.C. 408, when Alcibiades returned to Athens from Byzantium, Thrasybulus was sent with a fleet of eighty galleys to the coast of Thrace, where he restored the Athenian sovereignty in most of the revolted towns; and while he was engaged here he was elected at Athens one of the generals, together with Alcibiades and Conon. In B.C. 406 Thrasybulus was engaged as one of the inferior officers in the Athenian fleet during the battle of Arginusæ; and after the battle he and Theramenes were commissioned by the generals to save the men on the wrecks: but a storm prevented their executing this order. Respecting the fate of the generals and the conduct of Theramenes on this occasion, see **THERAMENES**. Thrasybulus is not charged with any improper act during the proceedings against the generals, and for two years after his name does not occur in the history of Attica.

During the government of the Thirty Tyrants at Athens, he was sent into exile, and took refuge at Thebes. The calamities under which his country was suffering roused him to exertions. The spirit which prevailed at Thebes against Sparta, and against its partisans at Athens, emboldened him to undertake the deliverance of his country. With a band of about seventy, or, according to others, of only thirty fellow-exiles, he took possession of the fortress of Phyle, in the north of Attica. The Thirty, sure of victory over so insignificant a garrison, sent out the 3000 Athenians whom they had left in the enjoyment of a kind of franchise, and the knights, the only part of the population of Athens who were allowed to bear arms. On their approach to Phyle some of the younger men, eager to distinguish themselves, made an assault upon the place, but were repelled with considerable loss. The oligarchs then determined to reduce the fortress by blockade; but a heavy fall of snow compelled them to return to Athens. During their retreat the exiles sallied forth, attacked the rear, and cut down a great number of them. The Thirty now sent the greater part of the Lacedæmonian garrison of Athens and two detachments of cavalry to encamp at the distance of about fifteen stadia (nearly two miles) from Phyle, for the purpose of keeping the exiles in check. The small band of Thrasybulus had in the meantime increased to 700, as the Athenian exiles flocked to him from all parts. With this increased force he one morning descended from Phyle, surprised the enemy, and slew upwards of 120 hoplites and a few horsemen, and put the rest to flight. Thrasybulus erected a trophy, took all the arms and military implements which he found in the enemy's camp, and returned to Phyle.

The Thirty now began to be alarmed at the success of the exiles, and thought it necessary to secure a place of refuge in case the exiles should succeed in getting possession of Athens. For this purpose they, or rather Critias, devised a most atrocious plan. By fraud and force he contrived to secure 300 citizens of Eleusis and Salamis capable of bearing arms; and after they were conveyed to Athens, he compelled the 3000 and the knights to condemn them to death. All were accordingly executed, and Eleusis was deprived of that part of its population to which it might have looked for protection. In the meantime the number of exiles at Phyle had continued to increase, and now amounted to one thousand. With these Thrasybulus marched by night to Piræus, where he was joyfully received, and great numbers of other exiles immediately increased his army. The Thirty no sooner heard of this movement than they marched against Piræus with all their forces. Thrasybulus by a skilful manœuvre obliged the enemy, who was superior in numbers, to occupy an unfavourable position at the foot of the hill of Munychia. In the ensuing battle the army of the tyrants was put to flight and driven back to the city. Critias fell in the contest.

The consequences of this success showed that there had been little unity among the oligarchs, and that an open breach had only been prevented by fear of Critias. Some of the Thirty and a great many of the 3000 were in their hearts opposed to the atrocities which had been committed, and had avoided, as much as they could, taking part in the rapine and bloodshed. They also were aware that the hatred and contempt under which they were

labouring were owing mainly to the violence of their colleagues; and for the purpose of maintaining their own power they now resolved to sacrifice their colleagues. An assembly was held in which the Thirty were deposed, and a college of ten men, one from each tribe, was appointed to conduct the government. Two of these ten had formerly belonged to the Thirty, and the rest of the Thirty withdrew to Eleusis. As regards the army of exiles under Thrasybulus, the new government of Athens was no less determined to put them down than the Thirty had been. Thrasybulus therefore continued to strengthen himself, and to prepare for further operations. His army had gradually become more numerous than that of Athens, for he engaged aliens in his service, and promised them, in case of their success, the same immunities at Athens as those enjoyed by the citizens (*ισοτελεια*). Arms, of which he was still in want, were generally supplied by the wealthy citizens of Piræeus and other places, and by the ingenuity of his own men. As the danger from the exiles became at last very imminent, the Ten of Athens applied to Sparta for assistance. At the same time the faction at Eleusis also sent envoys to Sparta; but the government of Sparta refused to send an army for an undertaking from which it could reap no advantages. However Lysander, as harmostes, obtained leave to levy an army, and his brother Libys was appointed admiral to blockade Piræeus. Lysander went to Eleusis, and got together a numerous army. Being thus enclosed by land and by sea, Thrasybulus and his army had no prospect except to surrender.

But their deliverance came from a quarter whence it could have least been expected. The power and influence which Lysander had gradually acquired, had excited the envy of the leading men at Sparta, even of the ephors and kings, and they were now bent upon thwarting his plans. King Pausanias was accordingly sent out with an army to Attica, avowedly to assist Lysander in his operations, but in reality for the purpose of preventing the accomplishment of his designs. He encamped near Piræeus, as if he designed to besiege the place in conjunction with Lysander. After several sham manœuvres against the exiles, Pausanias gained a victory over them without following it up. He now sent secretly an embassy to them, requesting them to send a deputation to him and the ephors; and he also suggested the language which the deputies should use. At the same time he invited the pacific party at Athens to meet and make a public declaration of their sentiments. Hereupon a truce was concluded with the exiles, and a deputation of them, as well as of the pacific party at Athens, was sent to Sparta to negotiate a general settlement of affairs. As soon as the Ten of Athens heard of this, they also sent envoys to Sparta to oppose the other embassy. But this attempt failed, and the ephors appointed fifteen commissioners with full powers, in conjunction with king Pausanias, to settle all the differences between the parties in Attica. In accordance with the wishes of the exiles and the peaceful party of the city, the commissioners proclaimed a general amnesty, from which none were to be excluded except the Thirty, the Eleven, and the Ten who had formed the government of Piræeus. Any one who might not think it safe to return to Athens was permitted to take up his residence at Eleusis. This clause is unintelligible, unless we suppose that the Spartans still wished to see Eleusis in the hands of a party which might check the reviving spirit of independence among the Athenians. Sparta guaranteed the execution of the proclamation. Pausanias withdrew his forces, and Thrasybulus at the head of the exiles entered Athens in triumph, and marched up the Acropolis to offer thanks to Athena. An assembly was then held, in which Thrasybulus impressed upon all parties the necessity of strictly observing the conditions of the peace.

Eleusis was now the seat of the most violent of the oligarchical party, and they still indulged some hope of recovering what was lost. They assembled a body of mercenaries to renew the civil war; but Athens sent out a strong force against them. Xenophon says that the leaders of the Eleusinian party were drawn to a conference and then put to death. This isolated statement is rather surprising, as in all other respects the popular party showed the greatest moderation, and immediately after the quelling of the Eleusinian rebellion Thrasybulus induced the Athenians to proclaim a second amnesty, from which no one was to be excluded. This amnesty was faithfully observed. The first

step after the abolition of the oligarchy was the passing of a decree which restored the democratic form of government.

Thrasybulus acquired the esteem of his countrymen by the courage and perseverance which he had shown in the deliverance of his country, and although for many years he does not come forth very prominently in the history of Attica, he was no less active in restoring Athens to her former greatness, than he had been in wresting her from the hands of her enemies. His last military undertaking belongs to the year B.C. 389, when the government of Athens placed a fleet of 40 galleys at his command, with which he was to support the democratic party in the island of Rhodes. On his arrival there he found that no protection was needed, and he sailed to the north part of the Ægean. In Thrace he settled a dispute between two princes, and gained them as allies for Athens. At Byzantium and Chalcedon also the influence of Athens was restored, and with it new sources of revenue to the republic were opened. After this he sailed to Mitylene, the only town in the island of Lesbos in which the Spartan party had not gained the ascendancy. Thrasybulus here fought a battle with Therimachus, the Spartan harmostes, who was defeated and slain. Several towns were now reduced, and after he had plundered the lands of those who refused to submit to Athens, he prepared to sail to Rhodes; but before he landed there, he sailed along the southern coast of Asia Minor to levy some contributions there. His first anchorage in the mouth of the river Eurymedon in Pamphylia near Aspendus. In consequence of some outrage committed by his soldiers on land, the Aspendians were exasperated, and during the night they surprised and killed Thrasybulus in his tent, in B.C. 389.

(Thucydides, viii.; Xenophon, *Hellen.*, i. 1, 12; i. 6, 26; ii. 3, 42; ii. 4, 2, &c.; iv. 8, 25, &c.; Diodorus Sic., iv. 32, &c.; 94 and 99; C. Nepos, *Thrasybulus*; compare E. Ph. Hinrichs, *De Theramēnia, Critic. et Thrasybuli Rebus et Ingenio*, Hamburg, 1820, 4to.; Thirlwall, *History of Greece*, vol. iv.)

THRASYBULUS (*Θρασύβουλος*), of Collytus in Attica was a contemporary of Thrasybulus, the deliverer of Athens, from whom he is usually distinguished by epithet of the Collytitan. He was one of the Athenian exiles who joined his namesake at Phyle and afterwards at Piræeus. (Demosthenes, in *Timocrat.*, p. 742.) In the war against Antalcidas he commanded eight Athenian galleys, with which he was taken prisoner by the Spartan admiral.

(Xenophon, *Hellen.*, v. 1, 26, &c.; compare *Æchias in Ctesiphont.*, p. 73, ed. Steph.)

THRASYBULUS (*Θρασύβουλος*), a tyrant of Syracuse. He was a son of Gelo, and brother of Hiero the Elder, who ruled over Syracuse till the year B.C. 406. Hiero was succeeded by his brother Thrasybulus, who was a bloodthirsty tyrant, and oppressed the people still more than Hiero: great numbers of citizens were put to death and others sent into exile, and their property filled the private coffers of the tyrant. In order to protect himself against the exasperated citizens, he got together a large force of mercenaries, and relying on this new support, he carried his reckless cruelties so far, that at last the Syracusans determined to rid themselves of their tyrant. They chose leaders to give them a military organization, that they might be enabled to resist the mercenaries of Thrasybulus. The tyrant at first endeavoured to stop the insurrection by persuasion, but this attempt failing, he drew reinforcements from Catania and other places, and also engaged new mercenaries. With this army, consisting of about 15,000 men, he occupied that part of the city which was called Achradina, and the fortified island, and harassed by frequent sallies the citizens, who fortified themselves in a quarter of their city called Imera. The Syracusans sent envoys to several Greek towns in the interior of Sicily, soliciting their aid. The request was readily complied with, and they soon had an army and a fleet at their disposal. Thrasybulus attacked them both by sea and land, but his fleet was compelled to sail back to the island after the loss of several triremes, and his army was obliged to retreat to Achradina. Seeing the impossibility of maintaining himself, he sent ambassadors to the Syracusans with offers of terms of peace, which were granted on condition of his quitting Syracuse. Thrasybulus submitted to these terms, after having scarcely one year, and went to Locri in Southern Italy, in B.C.

le. After the Syracusans had thus delivered them of the tyrant, they granted to his mercenaries freedom, and also assisted other Greek towns in Sicily in winning their freedom. (Diodorus Sic., xi. 67 and 68.) RASYMENE LAKE (Trasiménus Lacus, in the best MSS.; in Greek writers, ἡ λίμνη Τρασυμένη, or Θρασύμηνη), the ancient name of the Lago di Perugia in Italy, in Etruria, and was the scene of the third defeat of Hannibal after he had crossed the Alps. [NIBAL.] The lake itself is fully described under NIBAL.

RAULITE. *Hisingerite. Hydrated Silicate of Iron.* It occurs in roundish nodules. Fracture uneven or imperconchoidal. Structure curved, foliated. Brittle. Lustrous. Nearly opaque. Lustre vitreo-resinous. Colour blackish.

It effervesces out water when heated in a glass tube; imperfused by the blowpipe, and is, after heating, attracted by magnet.

It occurs at Riddarhyttan in Westmanland (1) and at Eisfeld in Bavaria (2), accompanying iron pyrites. Analysis by

	(1) Hisinger.	(2) Kobell.
Silica	36.30	31.28
Peroxide of Iron	44.39	50.86
Water	20.70	19.12
	101.39	101.26

READ (French, *Fil*; German, *Zwirn*; Dutch, *Garen*; Italian, *Rafe*; Spanish, *Hilo, Torzal*; Russian, *Nitki*), a line formed by twisting together fibres of vegetable or animal substances, as flax, cotton, or silk. Sewing-threads, and the various kinds of thread used in the manufacture of bobbin-net, lace, and some other kinds of textile consist of two or more yarns, or simple spun threads, united together by twisting, just as a rope-strand consists of several yarns or distinct cylinders of hemp. (Encyclopædia, vol. xx., p. 154; SPINNING, vol. xxii., p. 349.)

A paper on the manufactures of Paisley, printed in an appendix to Anderson's 'History of Commerce' (edited 1787-9), it is stated that 'the manufacture of thread first attempted in this country by Mrs. Millar, of Balaclava, in 1722, on having received some information and encouragement from Holland.' Her example was speedily followed by several families in Paisley, where the manufacture became of considerable importance. The first practitioners imitated the kind called Nuns' or ounce thread, which was made up in hanks of forty threads each, upon reels a yard in circumference; but when the profits of the manufacture were diminished by competition, it was injured by the surreptitious practices of some of the manufacturers, who reduced the number of threads in each hank from forty to thirty, and when this was notorious in the market, put but twenty-eight threads in the hank, or reduced the diameter of their reels, consequently the length of the threads. These frauds were carried to such an extent that it became necessary, in 1733, to pass an act of parliament requiring all manufacturers of this description of thread to use uniform standards of thirty-six inches in circumference, and to put threads or rounds of the reel in each hank. From the statement above referred to, it appears that the number of machines employed at Paisley in twining thread, in 1733, was not less than 120; and that the number employed in thread manufacture in the whole of Scotland at that time was at least 500, of which about 200 were engaged in the production of the different species of ounce threads. These machines consumed upon an average 2400 spindles of yarn or 480,000 in the whole; and these spindles, valued 3d. each, when manufactured into thread, amounted to 1,200,000l. The 300 machines employed in making other kinds of thread consumed upon an average 2000 spindles or 600,000 spindles in the whole, which, estimated 9d. each when manufactured, amounted to 112,000l. The total annual value of the thread manufactured in Scotland in 1784 was 220,000l.; and it is stated that the thread manufacture gave employment in its various operations, from the spinning of the flax to the finishing of the thread, to upwards of 20,000 women, besides 4000 or 5000 men.

The manufacture of thread from fibres of cotton-wool, for sewing and other purposes, is one of the many important branches of British industry called into exercise by the progress of the P. C., No. 1538.

improvements effected by Arkwright and his successors in spinning-machinery, and forms a considerable branch of business both in Manchester and in Scotland, for exportation as well as for home consumption.

The operation of combining yarns of cotton or linen into thread is performed by a machine called a doubling and twisting frame, somewhat resembling the throstle of the cotton-spinner. Engravings of this machine, with a minute description, are given in Dr. Ure's 'Cotton Manufacture of Great Britain,' vol. ii., pp. 226-234, and 'Dictionary of Arts,' pp. 1239-1241, from which authorities the following account is derived. Along the centre of the machine is an elevated creel or frame-work, which supports two parallel rows of cops or bobbins of yarn, one row towards each side of the machine. The cops or bobbins are placed vertically, or nearly so, and the lower ends of their axes rest in oiled steps or hollows, while the upper ends are supported by wire eyes, so that they may revolve with facility. The number of cops or bobbins of yarn is twice as great as that of the twisting spindles when the thread is to consist of two yarns, three times as great for thread formed of three yarns, &c.; and the yarn with which they are charged is frequently gassed, or passed quickly through a series of coal-gas flames, to singe off any loose downy fibres, before it is taken to the doubling and twisting frame. From the cops the yarns are conducted over horizontal glass rods, which are fixed parallel with the creel, and thence downwards into troughs filled with water or very thin starch-paste, which by moistening the yarns facilitates the subsequent process of twisting. To ensure the equal moistening of the yarns they are, while being drawn through the troughs, made to pass either under a glass rod, or through eyes which may, if necessary, be lifted out of the trough without wetting the fingers, by means of upright stems provided for that purpose. The wetting-troughs and other apparatus are alike on each side of the machine; but in further tracing the progress of the thread we shall confine our attention to one side, and to the apparatus necessary for producing one thread, although a great number of such trains of apparatus are combined in one frame, and set in motion by one train of impelling machinery. After being wetted the yarns pass over the rounded edge of the trough, which is covered with flannel for the purpose of absorbing the superfluous moisture; and thence under and partly around an iron roller, which is made to revolve with any required velocity by a train of wheel-work. Upon this roller rests another, of box-wood, which revolves solely by contact with the iron roller, its axis playing in vertical slots. In passing under the iron roller, then between it and the wooden roller, and finally over the latter, the yarns required to form the thread are brought together and slightly compressed; but although thus prepared for a more intimate union, they are not yet twisted together. The action of the winding and twisting apparatus may be illustrated by a diagram, in which none but the essential parts are shown. In this figure *aa* represents the untwisted thread, or rather the united yarns which are to form the thread, and *b* is a fixed eyelet through which they are conducted to the flyer *c*, which is mounted upon and revolves with a long vertical spindle set in motion by a wheel or pulley and strap at *d*. *e* is the bobbin upon which the finished thread is wound by the revolution of the flyer, which also gives to it any predetermined degree of twist. The spindle passes freely through a hole in the

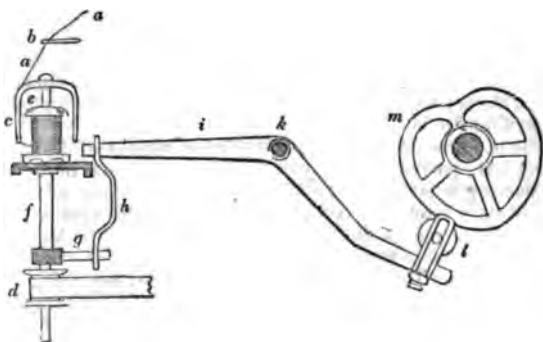

centre of this bobbin, which rests upon a bar called the **copping-rail**, the transverse section of which is indicated

by a tint in the cut; and the coping-rail, which extends the whole width of the machine, is supported at intervals by vertical rods, one of which is shown at *f*. To these rods, and consequently to the coping-rail and bobbins supported by them, a reciprocating vertical motion is imparted through the connecting pieces *g* and *h*, from the bent lever *i*, which is pivoted at *k*, and receives its motion through the adjustable friction-roller *l*, from an eccentric or heart wheel *m*. Thus by the combined rotatory motion of the spindle and flyer, and rising and falling motion of the bobbin, the thread is at once twisted and wound regularly upon the bobbins, which may be easily removed when full. It is unnecessary to detail the contrivances by which motion is communicated to various parts of the machine, and it is sufficient to add that, by changes in the relative sizes of some of the toothed wheels by which the moving-power is distributed from the main shaft, the spindles, which always revolve much faster than the rollers, may be made to do so to any required degree, so as to impart a greater or less degree of twist to the thread.

Silk thread is, according to Dr. Ure, commonly twisted in lengths of from fifty to a hundred feet, with hand-reels somewhat similar to those employed in rope-making.

(Anderson, *History of Commerce*, vol. iv., pp. 703-4; Dr. Ure's *Cotton Manufacture of Great Britain*, vol. ii., pp. 226-234; *Dict. of Arts*; &c.)

TREATS AND THREATENING LETTERS. By the criminal law of England, threats of personal violence, or any other threats by which a man of ordinary firmness and prudence may be put in fear, and by means of which money or other property is extorted from him, amount to the crime of robbery. [ROBBERY.] And by the statute 7 Will. IV. & 1 Vict., c. 87, sect. 7, a person demanding by menaces any property of another with intent to steal the same, is declared to be guilty of felony, and is liable to imprisonment for any term not exceeding three years. Besides these offences, it is a misdemeanor at common law to threaten another in order to deter him from doing some lawful act, or to compel him to do an unlawful one, or to extort money or goods from him, or to obtain any other benefit to the person who makes the threat.

The offence of sending or delivering letters or writings, threatening to kill or injure the person to whom they are sent or delivered, or to burn his house, or to accuse him of some heinous crime for the purpose of extorting money, was formerly considered to be high treason (stat. 8 Hen. V., c. 6); and under the stat. 9 Geo. I., c. 22, continued for more than a century to be punishable as a capital felony. By the stat. 4 Geo. IV., c. 54, s. 3, it was declared to be desirable that a less punishment should be substituted for that of death; and it was enacted that, 'if any person shall knowingly and wilfully send or deliver any writing, with or without any name or signature subscribed thereto, or with a fictitious name or signature, threatening to kill or murder any person, or to burn or destroy his house, out-house, barns, or stacks of corn or grain, hay or straw, the offender shall be guilty of felony, punishable with transportation for life, or not less than seven years, or imprisonment for any term not exceeding seven years.' By a more recent statute, 7 & 8 Geo. IV., c. 29, sect. 8, it is enacted that, 'if any person shall knowingly send or deliver any letter or writing, demanding of any person with menaces, and without any reasonable or probable cause, any chattel, money, or valuable security; or if any person shall accuse, or threaten to accuse, or shall knowingly send or deliver any letter or writing accusing or threatening to accuse, any person of any crime punishable by law with death, transportation, or pillory, or of any assault with intent to commit any rape, or of any attempt or endeavour to commit any rape, or of any infamous crime the meaning of which term is specially defined in the 9th section of the same statute, with a view or intent to extort or gain from such person any chattel, money, or valuable security, every such offender shall be guilty of felony, and shall be punishable with transportation for life or not less than seven years, or with imprisonment not exceeding four years, with or without whipping.

THREE, RULE OF. the technical name of the rule in arithmetic by which, three quantities being given, the first and second of one kind, a fourth is found such that the four are in proportion, or that the first is the same

multiple, part, or parts, of the second, which the third is the fourth.

In the earliest modern treatises are found the exact headings of this process, from which the definition *rule of three* has been formed by abbreviation. Most all such abbreviations date from the time systems of commercial arithmetic began to be written is, about the beginning of the sixteenth century. At that time, such books as were written always contained demonstrations from full definitions; and it was not necessary to provide the simple case of finding a proportional to three given numbers with a separate rule or to divide the rule for doing it from others. Thus ever was done by traders in their daily practice, separated the rule of three from the other parts of art, and called it the *golden rule*, an older term than *rule of three*. Bishop Tunstal's *Ars supputandi*, begins his chapter on the 'Regula de tribus notis quod ignotum commonstrantibus' in this manner: 'Primum omnium regula est quæ de tribus notis quantum ignotam noticiam educuntibus ab Arithmeticis traditur. *V. regulam auream* vocat; quia hæc cæteris *Art. regulis* velut cæteris metallis aurum præcedit. Recordo (1540) calls it the 'feate of the rule of proportions, whiche for his excellencie is called the golden rule.' Humphrey Baker (1562) uses the phrase 'rule of three' and says that 'the philosophers did name it the golden rule, but now in these latter daies, by us it is called the rule of three.'

The immense variety of questions which are to be solved by finding a fourth proportional defies all classification; but they may all be reduced to one form, though in particular cases not be easy to see the mode of reduction. That form is:—A produces B; what will C produce? It may be that it is money which produces goods which produce money, or money which produces goods or money of one country which produces money of another, or time which produces distance travelled, &c. The difficulty to beginners is the reduction of the question given to the above simple form, which must be done before what is (or used to be) called the *statement* question can be made, namely, the writing down the numbers A, B, C, in the proper order, with the proportion between them:

A : B :: C : the answer required.

It is proper enough to say that this is a question of proportion when numbers only are considered; but when the things represented by the numbers are taken instead of the numbers. Thus, if 5 pence buy 10 apples, and the number 5 is to 10 as 7 pence will buy 14 apples, and the number 5 is to 10 as 10 is to 14, or 5 is the same fraction of 7 as 10 is of 14. But it is absurd to say that 5 pence bear the same proportion to 10 apples that 7 pence bear to 14 apples, because 5 pence are not any assignable fraction of 10 apples. That there is a relation is true; but that it is not proportion. Thus, it is not absurd to say, in common language of the rule, As 5 pence buy 10 apples, so 7 pence to 14 apples; for the first is to the second in the same relation as the third to the fourth: 5 pence must, at all rates, do as much to purchase of 10 apples as 7 pence towards that of 14. With this understanding there is no objection to the common mode of statement, and the proof of the rule follows:—If A of the first produce B of the second, at the same rate of production, 1 of the first produces

$\frac{B}{A}$ of the second; whence C of the first must produce $C \times \frac{B}{A}$, or $\frac{CB}{A}$ of the second.

The importance of the rule of three induced arithmeticians to attach two other rules to it: the *inverse rule of three* (called by Recordo, Baker, &c., the *broker's rule*); the *double rule of three*. Some of the writers of *Common School*, apparently by an abbreviation of his words, tell that the rule of three inverse is used 'when less requires more and more requires less'; meaning that if the third of the given numbers, the less will be the answer and *vice versa*. Thus, suppose that 10*l.* has been lent for 3 months, and I want to know how long I can lend a given sum (other than 10*l.*) in return: evidently I lend, the less the time for which I ought to

not as 10 to 15, but in its inverse ratio, as 15 to 10, 10 : : 3 : 3 × 10 ÷ 15, or 2; and 2 months is the required.

double rule of three (at least in the class of questions which are usually considered as falling under it) is where time is an element in the production which the question supposes. For example: supposing it known how many men can pave B square feet in C days, or how many square feet can a men pave in c days, or how many days will it take a men to pave b square feet. If we set down the data and answer in two lines, and in the regular order—force employed—effect produced—time required—thus,

$$\begin{array}{ccc} A & B & C \\ a & b & c \end{array}$$

is—Take such an answer as will make the effect of each line multiplied by the mean of the other, to be the same in both. That is, let $AbC = aBc$, and according to the value of c is to be found, the mode of working is as follows—

$$a = \frac{AbC}{Bc}, b = \frac{aBc}{AC}, c = \frac{AbC}{aB}$$

The proof is as follows:—One man in C days could pave B square feet, and in one day $\frac{B}{AC}$ square feet. By similar

reasoning one man in one day could pave $\frac{b}{ac}$ square feet.

$$\frac{B}{AC} = \frac{b}{ac}; \text{ or } aBc = AbC.$$

The principal caution which a beginner requires is;—not to mix the rule of three (or the rule of finding a quantity which, with three others, shall constitute a fourth) to be applied in all cases in which three quantities are given to find a fourth. That such a caution is necessary arises from the defect of works on arithmetic; frequently exhibit this rule without any mention of the conditions, and leave it to be inferred that there is but one mode of obtaining a fourth quantity from three others.

EE RIVERS. [CANADA.]

ORTHORUS, M. Vieillot's name for a genus of *Alvia*, Lath., and placed by Mr. G. R. Gray in his *Troglodytinæ*, of his family *Certhidæ*.

OTHURUS, M. Vieillot's name for a genus of *Sylvia*, Lath., placed by Mr. G. R. Gray in his *Troglodytinæ*.

THROCMORTON, SIR NICHOLAS, was descended from an ancient family in Warwickshire, and his ancestors were employed in the higher offices of state for some time. His father, Sir George Throcmorton, had been connected with Henry VIII., but, being a zealous papist, he incurred the king's displeasure by refusing to take the oath of supremacy, and about 1538 was imprisoned in the Tower of London, where he remained several years.

Sir Nicholas, who was Sir George's fourth son, was born in the year 1513. Having been appointed page to the king at Richmond, the king's natural son, he accompanied him to France, and remained in his service till the year 1536.

After Throcmorton was released from the Tower in 1536, his son Nicholas was then appointed sewer to the king, which it was his duty to attend the

'mar-hall'd feast, Serv'd up in hall with sewer and seneschal.'

He headed a troop in the armament against which Henry VIII. commanded in person; he assisted at the siege of Boulogne, and after his return received a pension from the king as a reward for his services. After the king's death he attached himself to the queen, Catherine Parr, and to the Princess Elizabeth. He distinguished himself in the campaign in Scotland under the Protector Somerset; he was present at the battle of Pinkey (or Musselburgh), and Somerset sent him home with the news of the victory. He was soon afterwards created a knight, appointed to a place in the privy chamber, and admitted to great intimacy with Henry VIII. The king bestowed upon him some valuable lands, and made him under-treasurer of the Mint. He died in the parliament during Edward's reign as member for Northampton.

A short time before the king's death, Sir Nicholas married the daughter of Sir Nicholas Carew, and on taking his wife to visit his father at Coughton in Warwickshire, he was received with coldness by the old knight; partly perhaps on account of his Protestant principles, but chiefly because he had been knighted before his eldest brother. To remove this cause of offence, he took his brother back with him to court, and, at the request of Sir Nicholas, the king raised him to the dignity of a knight.

Sir Nicholas Throcmorton was present when Edward VI. died at Greenwich in 1553. He was aware of the designs of the partisans of Lady Jane Grey, but, though a Protestant, he was too much attached to law and legitimacy to give the least sanction to them. He therefore came immediately to London, and despatched Mary's goldsmith to announce to her the king's demise.

On the 2nd of February, 1554, Sir Nicholas Throcmorton was arrested and committed to the Tower on a charge of being concerned in the rebellion of Sir Thomas Wyatt. On the 17th of April he was brought to trial at Guildhall, London. This trial is the most important and interesting event in his life. A report of it, taken from Holinshed, is given in the 'Library of Entertaining Knowledge—Criminal Trials.' It is certain that he was acquainted with Wyatt's intentions, and there is little doubt that he was to some extent implicated in the rebellion. He was tried before commissioners, some of whom were bitterly inimical to him, and who seemed to regard his trial as merely a form necessary to be gone through previous to his execution. Sir Nicholas however conducted his own defence; and this he did with such admirable adroitness, such promptness of reply and coolness of argument, intermixed with retorts, spirited, fearless, and reiterated, in answer to the partial remarks of the lord chief justice and other commissioners, and followed up by an impassioned earnestness of appeal to the jury, that, in defiance of the threats of the chief justice and the attorney-general, he obtained a verdict of acquittal. Sir Nicholas was directed to be discharged, but was remanded, and kept in prison till the 18th Jan., 1555. The jury were made to suffer severely for their independent verdict. Two were fined 2000*l.* each, six were fined 1000 marks each, and four, who expressed contrition, were not fined. All were remanded to prison, where they remained till the 12th of December, when five were discharged on payment of the reduced fine of 220*l.* each, three on payment of 60*l.* each, and four without fine.

Sir Nicholas Throcmorton, after his release, avoided the approaching storm of persecution by going to France, where he remained till 1556. Though he afterwards served in Queen Mary's army under the Earl of Pembroke, he devoted himself chiefly to the princess Elizabeth, whom he visited privately at Hatfield. When Queen Mary died, he was admitted to see her corpse, and, as Elizabeth had requested, took from her finger the wedding-ring which had been given to her by Philip, and delivered it to Elizabeth. Elizabeth gave him the office of chief butler of England, a situation of some dignity, but inconsiderable emolument, and afterwards made him chamberlain of the exchequer. In 1559 he was sent on an embassy to France, and remained at the French court as resident ambassador till the beginning of 1563. Dr. Forbes has published the greater part of Throcmorton's correspondence with his own government while he was in this confidential situation. It displays great diplomatic skill and management, but perhaps rather too much tendency to intrigue; and he supported the cautious and somewhat doubtful policy of Cecil with zeal and discretion. Indeed he was on the most confidential terms with Cecil during the whole of this period, but after his return a coolness arose between the two statesmen, which increased till it became a strong personal animosity.

In 1565 Throcmorton was sent on a special embassy to Scotland, to remonstrate with Mary Queen of Scots against her intended marriage with Darnley; and when Mary was imprisoned at Lochleven in 1567, Throcmorton was commissioned by Elizabeth to negotiate with the rebel lords for her release.

In 1569 Throcmorton was sent to the Tower on a charge, which indeed appears to have been well founded, of having been engaged in the intrigue for a marriage between Mary Queen of Scots and the Duke of Norfolk. Though he was not kept long in confinement, he never afterwards regained the confidence of Elizabeth, and the distress of

mind occasioned by the loss of her favour has been thought to have hastened his death, which took place at the house of the Earl of Leicester, Feb. 12, 1571, in his 58th year.

Sir Francis Walsingham, in a letter to the Earl of Leicester, on the occasion of Throcinorton's death, says of him that 'for counsel in peace and for conduct in war he hath not left of like sufficiency that I know.' Camden says he was 'a man of large experience, piercing judgment, and singular prudence; but he died very luckily for himself and his family, his life and estate being in great danger by reason of his turbulent spirit.'

(*Criminal Trials*, in *Library of Entertaining Knowledge*; *Pictorial History of England*.)

THROMBUS is a tumour formed by blood effused from a vein after bleeding, and coagulated in the adjacent cellular tissue. It is a kind of intense ecchymosis or bruise, and usually arises from the puncture in the vein not having been made exactly opposite that in the skin, so that some of the blood, instead of flowing out, is infiltrated between the vein and the surface. It is rarely of sufficient importance to require treatment, and is usually removed like the effused blood of an ordinary bruise. Sometimes however inflammation ensues around the tumour, which should be treated by leeches and cold; or, if it proceed to suppuration, should be managed like a common abscess.

THROSTLE. [THRUSHES.]

THRUSH, or *Aphthæ*, is a disease which commonly appears in the form of minute opaque-white vesicles scattered over the interior of the mouth and fauces. Vesicles or blisters of this kind often appear in a succession of eruptions, those which were first formed bursting and leaving tender and raw surfaces, while others are breaking out; and thus continuing through the whole course of some general disorder of the system.

The only variety of thrush in which the eruption is the most obvious sign of disease is that which is called milk-thrush, or aphthæ infantum, or sometimes, in the supposition that it is the primary disease, idiopathic thrush. This however is almost always connected with disturbance of the digestion and other functions, and is usually traceable to some error of diet. It is most frequently observed in children that are brought up 'by hand;' and, in ordinary cases, requires only the means adapted to correct the disturbed digestion, such as small doses of magnesia and gentle purgatives. In very weakly children however, and in those that are ill fed and clothed, the surface of the mouth and fauces, exposed by the bursting of the vesicles, may slough or ulcerate; and this condition is always a sign of the necessity of administering tonics, nutritious food, and even powerful stimulants, such as wine or brandy. It is this form of thrush which is usually described as aphthæ maligna.

In adults, thrush is a very common occurrence in the advanced stages of many diseases, such as typhoid and other acute fevers, the hectic fever accompanying phthisis, diabetes, &c.; in short, in nearly all cases in which there is great prostration of strength, thrush may occur. In these cases, the only treatment that can be applied peculiarly to it is local. Great relief is often afforded by lightly sponging the affected surfaces with a solution of nitrate of silver, in the proportion of eight or ten grains to an ounce of water. Gargles, consisting of a drachm of alum to a pint of water or acidulated infusion of roses, or of one or two drachms of sub-borate of soda to half a pint of water, are often beneficial; and so is the mel boracis of the Pharmacopœia, when a small quantity of it is held for a few minutes in contact with the affected part.

THRUSHES. Under this name many ornithologists treat of the whole of the *MERULIDÆ*, in which article the views of Mr. Vigors, Mr. Swainson, and the Prince of Musignano, now Prince of Canino, with regard to this family, are given.

Since the article *Merulidæ* was written, Mr. G. R. Gray has published his 'List of the Genera of Birds,' and we proceed to lay before our readers his arrangement.

Mr. G. R. Gray makes the *Turdidæ* (*Turdus*, Linn.) the second family of his third tribe (*Dentirostres*) of his second order (*Passeres*). The *Dentirostres* are placed by him between the *Tenuirostres* and the *Conirostres*, and the *Turdidæ* between the *Eusciniidæ* and the *Muscicapidæ*.

The following are the subfamilies and genera into which Mr. G. R. Gray divides the *Turdidæ*:—

Subfam. 1. Formicariinæ.

Genera:—*Notodela*, Less.; *Eupetes*, Temm.; *Ajar*, *Dusyccephala*, Sw.; *Pithys*, Vieill.; *Formicivora*, *Myrmeciza*, G. R. Gray; *Urotomus*, Sw.; *Miturus*, *Corythopsis*, Sundev.; *Brachypteryx*, Horsf.; *Mac* Jard. and Selby; *Tinactor*, Pr. Max.; *Formicarius*, E. *Chamaeza*, Vig.; *Grallaria*, Vieill.; *Cissa*, Bosc; *chyurus*, Thunb.; *Myiophoneus*, Temm.; *Hydr* Vieill.

Subfam. 2. Turdinæ.

Genera:—*Petrocosyphus*, Boie; *Orocetes*, G. R.; *Larvicora*, Hodgs.; *Bessonornis*, Smith; *Saxea* Less.; *Chætops*, Sw.; *Gericichla*, Kuhl; *Zonothra*, *Myiophaga*, Less.; *Orococla*, Gould; *Turdus*, L. *Merula* (Ray), Boie; *Mimus*, Briss.; *Troglodytes*, W.

Subfam. 3. Timalinæ.

Genera:—*Donacobius*, Sw.; *Pellorneum*, Sw.; *nemia*, Sw.; *Crateropus*, Sw.; *Garrulus*, Less.; *A* *dura*, Gould; *Cinelosoma*, Vig. and Horsf.; *Syngis*, Ho *Sibia*, Hodgs.; *Tesia*, Hodgs.; *Malacocercus*, Sw.; *malia*, Horsf.; *Pomatorhinus*, Horsf.; —? *Pa* *cola*, Hodgs.; *Icteria*, Vieill.; *Turnagra*, Less.

Subfam. 4. Oriolinæ.

Genera:—*Dulus*, Vieill.; *Sphæcotheres*, Vieill.; *Or* *Linn*; *Mimeta*, Vig. and Horsf.; *Analcipus*, Sw.; *culus*, Sw.; *Oriolia*, J. Geoff.

Subfam. 5. Pycnonotinæ.

Genera:—*Microcellis*, G. R. Gray; *Microtar* *Malacopteron*, Eyton; *Trichophorus*, Temm.; *n* *Vig*; *Yuhina*, Hodgs.; *Phyllastrephus*, Sw.; *u* *ornis*, Sw.; *Pycnonotus*, Kuhl; *Andropodus*, Sw.; *chirox*, Less.; ? *Setornis*, Less.

Mr. G. R. Gray, with his usual diligence and accuracy gives the synonyms of all these genera; and observes regard to some of them, that *Drymophila*, Sw., has been used in botany; that *Leptorhynchus*, Menestr., has been previously employed; *Petrophila*, Sw., used in botany; *sypha*, Vig., used in entomology, only the term used there in us; *Cichla*, Wagl., previously used in entomology; *Paludicola*, Hodgs., previously employed in entomology; and *Micropus* and *Brachypus*, Sw., used in other branches of natural history.

Some of these forms have already been noticed in this work, and we shall here confine ourselves to those true thrushes, or those so nearly allied to them as to be common parlance, they are so termed.

EUROPEAN THRUSHES.

The following thrushes are European:—*Black Ouzel*, or *BLACKBIRD*, *Merula ru* *the Ring Ouzel*, *Merula torquata*, Briss.; the *Ouzel*, *Merula migratoria*, Sw.; the *Blackbird*, *Merula migratoria*, Sw.; the *Field Thrush*, *Turdus atrogularis*, Temm.; the *Field Thrush*, *Turdus pilaris*, Linn.; the *Redwing*, *Turdus iliacus*, Linn.; the *Missel Thrush*, *Turdus viscivorus*, Linn.; *Thrush*, or *Throstle*, *Turdus musicus*, Linn.; *the Thrush*, *Turdus Naumanni*, Temm.; the *Pallid Thrush*, *Turdus pallidus*, Pall.; *White's Thrush*, *Turdus* *Extor*; the *Siberian Thrush*, *Turdus sibiricus*, Linn.; *the Water Ouzel*, or *Common Dipper*, *Cinclus cinclus*, Bechst.; the *Black-bellied Water-Ouzel*, *Cinclus mus* *gaster*, Brehm; *Pallas's Water Ouzel*, *Cinclus pal* *Temm.*; the *Rock-Thrush*, *Petrocincla saxatilis*, and the *Blue-Thrush*, *Petrocincla cyaneus*, Vig.

Of these, the *WATER OUZEL*, or *Common Dipper*; *Missel Thrush*; *White's Thrush* (occasional only); *Song Thrush*; the *Fieldfare*; the *Redwing*; the *Blackbird*; and the *Ring Ouzel*, or *RING BLACKBIRD*, are British.

We select as an example the sweetest songster of this tribe, in our opinion at least, and we write it with respect to the rich mellow whistle of the blackbird and the loud stirring notes of the missel thrush.

The Throstle or Song Thrush.

This well-known bird needs no description. It is the *Grive* and *Petite Grive* of the French; *Tordo*, *Tordo mune*, and *Tordo Bottaccio* of the Italians; *Song-bird* or *Weiss-drossel*, of the Germans; *Maria*, with the names above given, of the modern British; and *the Song-bird* of the antient British.

Geographical Distribution.—Inhabits every corner of Europe, haunting gardens and woods near streams and

* N.B. The *Mauris* of the French is the *Redwing*.

dows. Bechstein says that in Germany, as soon as the autumnal fogs appear, the throistles collect in large flights to a warmer climate, the principal time of passage being the 15th of Sept. to the 15th of October, and the return about the middle or end of March, when each pair returns to its own district. In Britain it is permanent, and is recorded over England, Wales, Ireland, Scotland, and its islands. Russia, Denmark, Sweden, and Norway possess it in the south, besides Germany, France, Italy, and Greece have it. It has been seen in winter at Smyrna and Constantinople. Professor Nilsson states that it leaves Sweden in the winter, and comes farther south. Mr. Selby observes that such visitors arrive in Britain with a north or north-east wind, and, after staying a few days to recruit, return southward.

Habits, Food, &c.—Worms, insects, snails, and fruits form the food of the throistle. The common garden-snail, *Helix hortensis*, and the wood-snail, *Helix nemoralis*, are killed and eaten in great numbers by this species. The bird beats and breaks the shells against a stone to get at the animals. The nest is made of green moss generally, and fine root-fibres on the outside, and is lined within with cow-dung and decayed wood, the lining forming a cement, so perfectly spread that it will hold water. Eggs four or five, of a light blue, the larger end having a few small black specks or spots. Time of incubation thirteen days. The first hatch generally comes forth in April, but the young have been known to be out at the end of March. There are generally two broods in the year. Both the cock and the hen sit, but the former less than the latter. He often feeds her on the nest. A holly, a thick bush—a tall one is mostly preferred—a dense and somewhat high shrub or a fir, is usually selected; but the bird has been known to breed in an open shed or tool-house, and does not seem to shun the neighbourhood of man. In 1833 a pair built their nest in a low tree at the bottom of Gray's Inn Gardens, near the gates where passengers are going by all day long. The hen laid her complement of eggs, and was sitting on them, when a cat climbed up and killed her on the nest. The cock immediately deserted the place.

Bechstein states that in captivity the Throistle is easily taught to perform airs. For taking it he recommends a perch with a limed twig as the best mode of capturing a well-toned male; but in September or October he says that they may be caught in the water-traps, where they repair at sunrise and sunset, so late that they sometimes cannot be seen, and the bird-catcher is only guided by his ear. He observes that, when the birds enter the water, there must be no haste on the part of the fowler, because they like to bathe in company, and assemble sometimes to the number of ten or twelve at once, by means of a peculiar call. Bechstein tells us that the first which finds a convenient stream, and wishes to go to it, cries in a tone of surprise or joy, 'sik, ik, sik, siki, tsac, tsac, tsac.' then all the thrushes in the neighbourhood immediately reply in concert and repair to the place. The bath is entered however with a good deal of circumspection on their parts, and they seldom venture in till they have seen a Red-breast bathe without danger. But the first that bathes is soon followed by others, and they begin to quarrel among themselves if the bath is not deep enough to accommodate all satisfactorily. Bechstein further remarks that it is a good plan to have a tame bird swimming and fluttering on the banks of the stream, as a decoy to attract them.

ASIATIC THRUSHES.

Example, *Turdus erythrogaster*.

Description.—*Male.*—Grey-cærulescent above; the cheeks, the sides of the neck, and the quills black; breast, abdomen, and rump red; beak and tarsi black.

Female differs in being cærulescent-brown, the lower part of the back obscurely banded with brown; neck in front whitish marked with dark brown; breast, abdomen, and rump reddish-white marked with undulations. Length 8½ inches.

Mr. Gould (*Century of Birds from the Himalaya Mountains*) states that this beautiful species exhibits a marked departure in the style of colouring from its more typical congeners; and were it not that its form dictated the situation in which it is retained, it would otherwise seem to be allied in many respects to the genus *Petrocincla*.

Locality.—The rocky districts of Himalaya; never found in the low lands.

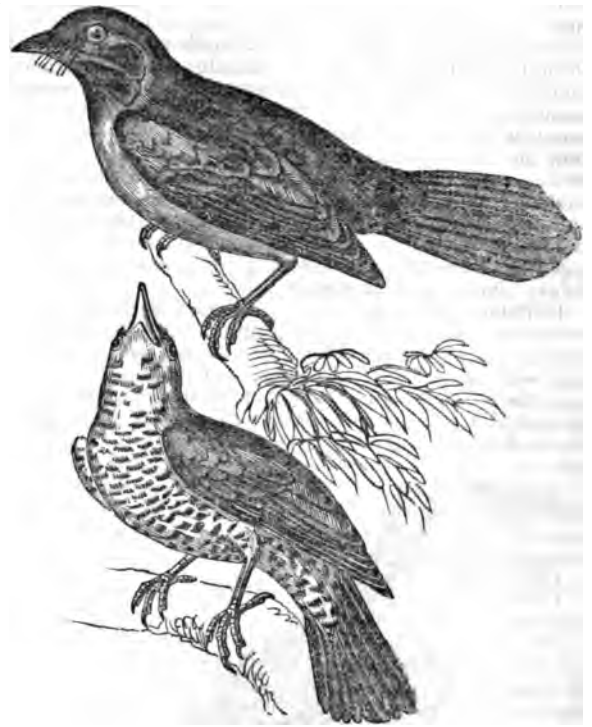

Turdus erythrogaster, male and female. (Gould.)

AFRICAN THRUSHES.

Example, *Turdus strepitans*, Smith (*Merula Letsitsirupa* of the same).

Description.—*Male.*—Front and top of head brownish-grey; occiput, upper aspect of neck, interscapulars, scapulars, and shoulders deep yellowish-grey, faintly shaded with brown; back, rump, and upper tail-coverts dirty ash-grey. Under parts white, tinted in places with ochre-yellow; sides of the neck, slightly tinted with ochre-yellow, and belly variegated with blackish-brown pyriform spots, one on each feather, the large end reaching nearly to its point. Sides of the head white, slightly tinted with ochre-yellow, variegated below the eyes with three blackish-brown bands; the foremost proceeds from the base of the lower mandible, the second from the middle of the under eyelid, and the third from the outer angle of the eye; the first extends nearly horizontally, and the two others obliquely downwards and backwards till they unite with the horizontal one. Primary wing-coverts and primary quill-feathers deep brownish-red, the latter tipped and edged externally with yellowish-white; the first two-thirds at least of the inner vanes of these feathers are of a clear buff-colour, darkest towards the shafts; secondary wing-coverts and secondary and tertiary quill-feathers dark greyish-brown, the outer vanes lightest, all margined externally and tipped with dirty white. Eyes reddish brown; upper mandible and tip of lower inferiorly as well as the claws liver-brown; lower mandible elsewhere, and the cutting edge of upper, pale saffron-yellow. Feet and insides of the bill deep straw-yellow.

Figure robust and rather short. Bill long, and moderately strong; upper mandible broad and slightly depressed towards the base, narrow and distinctly notched near the tip; culmen between nostrils elevated and rounded, towards the point of the bill strongly curved; nasal fossæ large and membranous, the nostrils narrow longitudinal slits near to the edges of the mandible; wings short and rounded, and when folded they reach over the first half of the tail; the first quill-feather rudimentary, the third rather the longest; the second and fourth of equal length, and scarcely shorter than the third; the fifth a little shorter than the fourth, and the remaining primaries diminish in length successively. Tail short and slightly forked. Legs long, tarsi robust, anteriorly indistinctly scutellated, posteriorly entire; toes strong, the inner and outer toes of the same length; claws strong, much curved and pointed. Length from point of bill to tip of tail eight inches six lines

Female differing but little in colour, if at all, from the male. (Smith.)

Locality, Habits, Food, &c.—Dr. Smith states that immediately upon reaching Kurichane, this thrush began to appear in the thickets, and he continued to acquire occasionally a specimen even in the vicinity of the tropic. It seeks, he says, its food upon the ground, and, when so occupied, its resort is readily discovered by the natives from the noise it makes in scratching the ground, or in displacing rubbish and decayed leaves which conceal the insects it is seeking. The name by which it is known in the country it inhabits is, he informs us, characteristic of the vigour with which it employs its feet, and the nearest translation he can give is 'Ground-Scraper.'

Dr. Smith further remarks that the form of its bill, particularly towards the base, the length of its legs, and the shortness of its tail, are all characters which remove it from the more typical species of the genus *Turdus*; but yet there is in its structure and habits what necessarily constitutes it a true thrush. (*Illustrations of the Zoology of South Africa.*)



Turdus strepitans, male. (Smith.)

AMERICAN THRUSHES.

Example, *Turdus mustelinus*, Gm.

Description.—Above, bright cinnamon brown, brightening into rufous on the head, and inclining to olive on the rump and tail. Beneath, whitish, thickly marked with pencil-shaped dusky spots. Vent pure white. Orbits of the eye white. Bill dusky brown, slightly notched, lower mandible flesh-coloured towards the base. Legs and claws very pale flesh-colour. Iris dark chocolate. Length 8 inches; alar extent 13 inches. (Nuttall.)

This appears to be the *Turdus melodus* of Wilson and *Twany Thrush* of Pennant, and is generally known as the *Wood Thrush*.

Locality, Habits, Food, &c.—Nuttall states that this solitary and retiring songster inhabits, during summer, the whole continent from Hudson's Bay to Florida, and, according to his friend Mr. Ware, breeds as far south as the vicinity of Natchez, in the State of Mississippi. He remarks that it is not satisfactorily ascertained whether the species quits the boundaries of the United States in winter, because the bird is then silent, and always difficult of access. He thinks it probable that this Thrush may winter in the Southern States, as a young bird, gleaning insects and berries, had been caught in a garden in Boston on the 26th October.

But, wherever the Wood Thrush may winter, it arrives in the Middle States from the 1st to the 15th of April. Nuttall thus describes its song and habits:—

'At the dawn of morning he announces his presence in the woods, and from the top of some tall tree, rising through the dark and shady forest, he pours out his few clear and harmonious notes in a pleasing reverie, as if inspired by the enthusiasm of renovated nature. The

prelude to this song resembles almost the double of the flute, blended with a tinkling shrill, warble, which re-echoes from his solitary retreat. A dirge of some sad recluse who shuns the bright life. The whole air consists usually of four notes, which succeed, in deliberate time, and together in impressive and soothing tones, more mellow and sweet at every repetition. The former seem to challenge each other from the depths of the wood, vying for the favour of their sympathetic responses and softer tones; and, as if a jealous strife, terminate the warm dispute by rushing to combat and violence. Like the Robin and the Wood Thrush, in dark and gloomy weather, when otherwise sheltered and silent, the clear notes of the Wood Thrush are heard through the dropping woods, from so that, the sadder the day, the sweeter and more plaintive his song. His clear and interrupted whistles are nearly the only voice of melody heard by the traveller in the mid-day, in the heat of summer, as he traverses the dark, and wooded wilderness, remote from the haunts of men. It is nearly impossible by words to convey an idea of the peculiar warble of this bird, which, amongst his phrases the sound of 'air-dee, pe' is repeated, and followed by a trill, repeated in two interrupted notes, is readily recognisable. At times their notes bear a considerable resemblance to those of Wilson's *Thrush*, 'eh rrehu 'vrehu, then varied to 'eh villia rrehu, then, 'eh villa rillu, high and shrill.

'The Wood Thrush is always of a solitary disposition, appearing alone, or only in pairs, while he willingly charms us with his soft and even solicitous to remain concealed. His haunts are low shady glens by watercourses, of dark with alder-bushes, mantled with the trailing vine. In quest of his insect prey he delights to meander of the rivulet, through whose leafy sunbeams steal only in a few uninterrupted rays, the sparkling surface of the running brook. So prone is this bird to solitude, that I have known one to uniformly in the same place, though nearly from his mate and nest. At times, indeed, he ventures a few faltering low notes in an oak grove, but his mellowest morning and evening was always delivered from a tall hickory, over a grove of hemlock firs, in which the dimness prevailed at noon. The Wood Thrush, like the Woodcock, therefore, feels inspired in darkness, waiting for the setting sun, he chooses a retreat where the beams of day can seldom enter. These shady haunts are also an additional attraction to our Thrush; and the most interesting scene of his instinctive and ends, here he first saw the light, and here he now bestows his nest, or in the next thick laurel or blooming oak, berries afford him an ample repast in the evening. Outwardly it presents a warm bed of withered oak leaves, above these a layer of coarse old leaf-stalks is laid, tempered with a mixture of decayed wood smoothly plastered, so as to resemble the nest of the Robin. The whole is thickly lined by a thin lining of the black fibrous radicles of



Wood Thrush.

The same author states that the egg

ve in number, are scarcely distinguishable from those of the Robin, and of an uniform bright greenish blue destitute of spots. Beetles, caterpillars, and other insects, and in autumn berries, constitute the principal food of the species. Linnæus further states that the young remain for weeks in the rural gardens in quest of berries, and that they are peculiarly fond of those of the various species of cornel *viburnum*. At this season, he says, they occasionally seek their favourite glens, and in their devious wanderings, previous to their departure, sometimes venture to the rural suburbs of the city. The young, it appears, are easily reared, and, like our Thrush, sing nearly as well in the cage as in their native wilds. (*Manual of the Mythology of the United States and of Canada.*)

THUANUS. [THOU, DE.]

THUCYDIDES (Θουκυδίδης), the son of Olorus, or Olorus, and Hegesipyle, was a native of the demus of Alimus Attica. He was connected by his mother's side with the family of the great Miltiades, and the name of his father was a common one among the Thracian princes. He was forty years old at the commencement of the Peloponnesian war, according to the statement of Pamphilus (Dionysius, xv. 23), he was born B.C. 471. In his own works he nowhere mentions his age or the time of his birth, but he says that he lived through the whole of the Peloponnesian war, and that he was of the proper age for writing its progress (v. 26).

Our principal information respecting the life of Thucydides is a biography of him written by Marcellinus, which however is full of contradictions and doubtful stories. There is also an anonymous biography of him prefixed to editions of his works, which is still worse than that of Marcellinus. Thucydides mentions incidentally a few particulars concerning himself, which is almost all that we know with certainty about his life.

There is a well-known story that when a boy he heard Herodotus read his History at Olympia, and was so much moved that he burst into tears. But there is good reason for believing that this recitation of the History of Herodotus never took place at the Olympic games [HERODOTUS]; and if there is any foundation for the story of Thucydides having heard him read it, we would rather refer it to a later recitation at Athens, which is mentioned by Plutarch and Eusebius. Suidas is the only writer who says that Thucydides heard Herodotus at Olympia; Marcellinus and others relate the same tale without mentioning where the citation took place.

There seems nothing improbable in the accounts of the student biographers that Thucydides was taught philosophy by Anaxagoras and rhetoric by Antiphon; but their statement that he accompanied the Athenian colony to Thurii is probably a mistake arising from their confounding him with Herodotus, who, we know, was of the colonists. But whether he went to Thurii or not, it is certain that he was in Athens in the second year of the Peloponnesian war, B.C. 430, when he was one of those who had the charge. (Thucyd., ii. 48.) In the eighth year of the war, B.C. 424, he was in command of an Athenian fleet of seven ships, which lay off Thasos. Brasidas, the Lacedæmonian commander, made an attempt to obtain possession of Amphipolis on the Strymon, which then belonged to Athens; and Thucydides, as soon as he heard of it, sailed to protect Amphipolis, but was only in sufficient time to save Eion, a port at the mouth of the Strymon. Amphipolis had fallen before he could arrive there. (Thucyd., iv. 102, &c.) For this he was either condemned to death or banished by the Athenians in the year following, B.C. 423; and in consequence of the sentence passed upon him he spent twenty years in exile, namely, till B.C. 403. (Thucyd., v. 26.) This year coincides exactly with the restoration of the democracy. Thrasylbulus, when a general amnesty was granted, of which Thucydides seems to have availed himself. Where he passed the time of his exile is not mentioned by himself. Marcellinus says that he first went to Ægina, and afterwards to Scapte-Hyle in Thrace, opposite the island of Thasos, where he had some valuable gold-mines. (Compare Plutarch, *De Exilio*, p. 605.) It appears however not improbable that he visited several places during his exile: the intimate knowledge which he shows respecting the history of the Italiotes and Siceliotes almost inclines one to suppose that he may have visited Italy and Sicily after the failure of the Athenian expedition in the latter island. His property in Thrace would however naturally lead him

to pass the greater part of his time in that country. This property, which was very considerable (Thucyd., iv. 105), was probably derived from his family, which came from Thrace, though Marcellinus says that he obtained it by marrying a Thracian heiress.

How long he lived after his return from exile, and whether he continued at Athens till the time of his death, is quite uncertain. According to some accounts he was assassinated at Athens, according to others he died at Thasos, and his bones were carried to Athens. He is said to have been buried in the sepulchre of the family of Miltiades.

The Peloponnesian war forms the subject of the History of Thucydides. He tells us that he foresaw it would be the most important war that Greece had ever known, and that he therefore began collecting materials for its history from its very commencement; that, where he had to rely upon the testimony of others, he carefully weighed and examined the statements that were made him; and that he spared neither time nor trouble to arrive at the truth, and that in consequence of his exile he was enabled to obtain information from the Peloponnesians as well as his own countrymen (i. 22; v. 26). Though he was engaged in collecting materials during the whole of the war, he does not appear to have reduced them into the form of a regular history till after his return from exile, since he alludes in many parts of it to the conclusion of the war (i. 13; v. 26, &c.). He did not however live to complete it: the eighth book ends abruptly in the middle of the year B.C. 411, seven years before the termination of the war. Even the eighth book itself does not seem to have received the last revision of the author, although there is no reason at all for doubting its genuineness, as it bears on every page indubitable traces of his style and mode of thought. Some ancient writers however attributed it to his daughter, others to Theopompus or Xenophon. As the work of Thucydides is evidently incomplete, it would appear that it was not published in his lifetime; and there is therefore great probability that the statement is correct which attributes the publication of it to Xenophon. Niebuhr has brought forward reasons which seem to render it almost certain that Xenophon's 'Hellenica' consist of two distinct works, and that the last five books were not published till long after the first two. The first two, which seem to have borne the title of the 'Paralipomena' of Thucydides, complete the history of the Peloponnesian war, and were not improbably published by Xenophon, together with the eight books of Thucydides. (Niebuhr, in *Philological Museum*, i. 485, &c.)

The first book of Thucydides is a kind of introduction to the history. He commences by observing that the Peloponnesian war was more important than any that had been known before; and to prove this, he reviews the state of Greece from the earliest times down to the commencement of the war (c. 1-21). He then proceeds to investigate the causes which led to it, of which the real one was the jealousy which the Peloponnesians entertained of the power of Athens; and interrupts his narrative to give an account of the rise and progress of the Athenian empire down to the commencement of the war (c. 89-118). He had an additional reason for making this digression, since this history had either been passed over by previous writers altogether, or had been treated briefly, without attention to chronology (c. 97). He resumes the thread of his narrative at c. 119, with the negotiations of the Peloponnesian confederacy previous to the declaration of the war; but the demand of the Lacedæmonians, that the Athenians should drive out the accused, which was answered by the Athenians requiring the Lacedæmonians to do the same, leads to another digression respecting the treason and death of Pausanias (c. 128-134); and as proofs were found implicating Themistocles in the designs of the Spartan king, he continues the digression in order to give an account of the exile and death of Themistocles (c. 135-138). He then resumes the narrative, and concludes the book with the speech of Pericles which induced the Athenians to refuse compliance with the demands of the Peloponnesians. The history of the war does not therefore begin till the second book; but it would be out of place to give here an abstract of the remainder of the work.

Thucydides had formed a high opinion of the value and importance of the work he had undertaken. It was not his object to afford amusement, like former writers, but to

give such a faithful representation of the past as would serve as a guide for the future (i. 22). His observation of human character was profound; he penetrates with extraordinary clear-sightedness into the motives and policy of the leading actors of the war; and he draws from the events he relates those lessons of political wisdom which have always made his work a favourite study with thoughtful men of all countries.

He claims for himself the merit of the strictest accuracy, and it is impossible to read his History without being convinced of the trustworthiness of his statements. His impartiality also is conspicuous: although he had been banished from his native city, he does not, like Xenophon, turn renegade, and try to misrepresent the conduct and motives of his own countrymen. Although a contemporary, and one who had taken an active part in public affairs, he writes as free from prejudice and party-feeling as if he had lived at a time long subsequent to the events he narrates.

His History is constructed on entirely different principles from those of his predecessors. He confines himself strictly to his subject, and seldom makes any digressions. He feels deeply the importance of his work, and constantly strives to impress the same feeling upon his readers. He had proposed to himself a noble subject, and writes with the consciousness of the value of his labours, and the presentiment that his work will be read in all future ages. There is consequently a moral elevation in his style and mode of treating a subject, which is scarcely to be found in any other writer except Tacitus.

In narrating the events of the war, Thucydides pays particular attention to chronology. He divides each year into two portions, the summer and the winter, and is careful to relate under each the events that took place respectively during that time. The speeches which he introduces are not mere inventions of his own, but contain the general sense of what the speakers actually delivered, although the style and the arrangement are his (i. 22).

The style of Thucydides is marked by great strength and energy. Not only his expressions, but even single words seem to have been well weighed before they were used; each has its proper force and significance, and none are used merely for the sake of ornament and effect. The style is not easy, and it is probable that Thucydides never intended it should be so, even to his own countrymen: his work was not to be read without thought. Still his style is open to serious objections. He does not sufficiently consult perspicuity, which is the first virtue in all writing. His sentences too are frequently unnecessarily long, and the constructions harsh and involved. These remarks are more especially applicable to the speeches inserted in the History, which Cicero found as difficult as we do. (*Orator*, 9.)

The Greek text was first published by Aldus, Venice, 1502, and the scholia in the following year. The first Latin translation, which was made by Laurentius Valla, appeared at Paris in 1513, fol. The first Greek and Latin edition was that of Henry Stephens, the Latin being the translation of Valla, with corrections by Stephens, 1564, fol. Among the modern editions, those most worthy of notice are Poppo's, which contains two volumes of prolegomena, with the scholia and numerous notes, Leipzig, 10 vols. 8vo., 1821-1838; Haack's, with selections from the Greek scholia and short notes, which the student will find very useful, 2 vols. 8vo., Leipzig, 1820, reprinted in London, in 3 vols. 8vo. 1823; Gülller's, 2 vols. 8vo., Leipzig, 1836, 2nd edition, reprinted in London; and Arnold's, 3 vols. 8vo., Oxford, 1830-1835, of which a second edition is in course of publication.

There are translations of Thucydides into most of the modern European languages. In English the first translation was made by Thomas Nicolls, from the French version of Seyssel, and was published in London, 1550, fol. This was succeeded by the translations of Hobbes and William Smith, which have been frequently reprinted. The most recent is by S. T. Bloomfield, 3 vols. 8vo., London, 1829. The most recent translation in German is by Klein, München, 1826, 8vo.; and in French one of the best is said to be by Gail.

Respecting the life of Thucydides, the reader may consult Dodwell, 'Annales Thucydidei et Xenophontei,' &c., Oxf., 1792, 4to.; and Krüger, 'Untersuchungen über das Leben des Thucydides,' Berlin, 1832.

THUG (from Hindustanee *t'hagna*, to deceive, deceive, and is the special appellation of secret thieves in India, whom since the year 1810 it has been the endeavour of the British government to root out. Of their origin can be said with any degree of certainty. The Thugs themselves refer it to the remotest antiquity, and there is doubt that the ceremonies with which they carry on their murderous trade can be traced as far back as the Purāna, where we find them described with the same accuracy. But before we proceed to investigate their history, of which we have only a slight and unsatisfactory knowledge, we shall describe them as they were at the time of their discovery. Their gangs, consisting of ten to two or three hundred men of all races, castes, and religions, yet all joining in the worship of Kāli about all parts of India, sacrificing to their tutelary deity every victim that they could seize, and sharing the spoils among themselves. Still they shed no blood, except forced by circumstances; murder being their religious performance of its duties required secrecy, and the mode of death was a rope or a handkerchief, which excite no suspicion. They were stranglers. Every gang had its leader, the *Jemadar* or *Sirdar*; its teacher, the *Guru*, whose duty it was to initiate the novice in the secret of using the *roomal*, or handkerchief. There are also the *Bhuttotes*, that is stranglers, and the *Sothas*, or trappers, and at last the *Lughaees*, or gravediggers. In a country like India, the striking character of whose manners and customs is an almost incredible apathy, it was easy for the Thugs to commit the most outrageous murders without exciting the interest of the victim's relations. The immense number of roads which border the roads afforded the Lughaees every opportunity for effectually concealing the bodies; and the custom of travelling in parties prevented the discovery. Sotha from being suspected, whenever he was offered the protection of his *Jemadar* to travel, their wealth induced him to entrap. The Thugs assume the appearance of merchants, which increases the confidence of their victims, whom they despatch with the greatest celerity whenever they find a convenient opportunity. Whilst the *Bhuttotes* arrange themselves in a manner to effect their purpose with facility, the *Lughaees* dig a hole; and at a given signal the noose is passed round the neck of the traveller, and, being taken unawares, he is strangled without being able to make any resistance. He is then thrown into the hole, and large incisions are made in the abdomen to prevent the corpse from swelling, and the whole is covered over with a layer of dry sand, another of thorns and bushes, and over all is thrown the earth which had been dug out, which they smooth down so as not to attract the notice of travellers. After every murder they offer a sacrifice to Kāli, which they call *Tograsan*. It is performed in the following manner:—A large sheet is spread over the cleanest spot they can select, and on this is cast a pile consisting of one rupee and four annas worth of coarse sugar; near this they place the consecrated pick-axe (an instrument sacred to Siva and Bhīvanī), and a piece of silver as a *rāpu darsana*, or silver offering. The leader then sits down on the sheet, and the but stranglers place themselves on each side of him with their faces to the west. They then distribute the sugar and eat it in solemn silence. But for this as well as other ceremonies we must refer to the works of Colonel Sleeman and Captain Meadows, as well as to an article in the 130th number of the *Edinburgh Review*. Here it will suffice to state that many ceremonies to which the Thugs attach the greatest importance are scrupulously performed by them both before and after the murder is committed; such as consulting the omens, propitiating Devi, thanksgiving, &c.

We have already observed that Thugs were found exercising their fearful trade in all parts of India. In the Deccan they are called *Phānsigars* (from Sanscrit *phāns*, a noose) or noosers, and on them we have a very interesting paper in the 13th volume of the 'Asiatic Researches.' Their customs are the same as those of the northern Thugs; but, having fewer Mohammedans among them, they are more strict observers of the duties which their religion imposes; they kill neither women, nor old men, nor any of the subjects which the Kālika Purāna (in the *Rudhira Adhyāya*) declares to be unfit for a sacrifice to Devi. In the same volume of the 'Asiatic Researches' there is another article on them, by Mr. Shakespear: both were written in 1816.

The origin of this atrocious worship is undoubtedly Hindu. The Thugs maintain that their occupation is represented in the caves of Ellora, as well as all other des. Moreover the terms they use are chiefly of Sanskrit origin; and the worship of Kâli corresponds so well to religious ceremonies of the Thugs, that there can be no doubt as to their identity. To satisfy the reader on this head we refer to the 5th volume of the 'Asiatic Researches,' where a chapter from the Kâlika Purâna has been translated and communicated by Mr. Blaquière.

The ceremonies of the Thugs are fixed by this Purâna, the date of which it is difficult to ascertain, but frequent allusions being made to it in the Vîra Charita, a drama of Bhâvabhûti, who lived at the court of king Vikramaditya in the beginning of the eighth century of our æra, we have sufficient reason to refer it at least to his time, if not to a previous period.

The Thugs then are a degenerate sect of Kâlî worshippers. They are very numerous in Bengal; but they are only buffaloes and kids (Colebrook, 'Essays,' i. 111), shed their blood, which they present to the idol in offerings that are kept for that purpose. In like manner as the Saktas left the pure worship of Siva in order to indulge in gross sensuality, the Thugs abandoned the original worship of Kâlî to get a livelihood by plunder. Both sects adhere strictly to the injunctions of their religion, which is taught in the Tantras of the Saktas and the tradition of the Thugs, and thereby convert crime into a sacred duty. As well may be expected, secrecy is dictated by prudence, and hence it is that we find the Thugs seldom mentioned by travellers.

Thévenot, in his Travels (part iii., ch. 22), is the first to describe them; he describes them as infesting the road from Agra to Delhi, and using a long rope furnished with hooks, which they throw with great dexterity round the traveller's neck, and he relates that their Sothas were frequently women. About ten years after Thévenot, Dr. Fryer found them at Surat, where a gang of them were executed. He describes them as Thévenot does, and it appears from the description that they belonged to the *wooltaneas*, a peculiar class of Mohammedan Thugs.

Although the whole of the ceremonial is Hindu, the Thugs themselves, whether Hindu or Mohammedan, maintain that they descend from seven Mohammedan clans, Thugs, Bhys, Bursote, Kachunee, Huttar, Ganoo, and Thundee ('Ramaseana,' p. 11); the seven clans are admitted to be the most antient and the original stock on which all the others have been engrafted. This circumstance may lead us to suspect that Mohammedams were the first to give a sort of political system to the Thugs; and the seven clans of Ismailis, whose occupation was murder as dreadful as that of the Thugs, may, when persecuted in the last days of their political existence, have joined themselves to the Hindu Phânsigars, and, adopting their ritual, have given rise to their present institution. This point is investigated with much ingenuity in an article on the 'Secret Societies of Asia,' in the 49th vol. of 'Blackwood's Magazine' (part civ.). Shah Jehan and Aurangzebe instituted criminal proceedings against them. After this we again lose sight of them until the time of Syder Ali, who proceeded against them in a summary way. Mysore however seems to have been their favourite residence; for in order to suppress them, in the reign of Tippoo Sultan, many of them were apprehended and sentenced to hard labour, and others suffered mutilation. It was in Mysore also that the English government first discovered them soon after 1799; but it was not before 1810 that any measures were taken for their extermination; and a plan for their suppression, which promises success, was adopted in 1830 by the then governor-general, Lord William Bentinck. Since that time their numbers have rapidly diminished, and it is to be hoped that they will soon be totally extinct.

(*Ramaseana, or Vocabulary of the Peculiar Language used by the Thugs*, Calcutta, 1836; this work is written by Col. Sleeman; *The Confessions of a Thug*, by Captain Meadows, 1840, London; *Illustrations of the History and Practices of the Thugs*, London, 1837.)

THUJA, or THUYA, the name of a genus of plants belonging to the natural order Coniferæ. This name is derived from *thûw*, as, on account of the pleasant odour given out by the wood in burning, it was used in antient sacrifices. The species of the genus are more commonly known by the

P. C., No. 1539.

name of *Arbor Vitæ*, but why this name has been given to it is a matter of uncertainty. Clusius, who wrote in the sixteenth century, gives it this name, and Dr. Royle says that the Cypress, an allied genus, is called the tree of life in the East. It belongs to the section of Coniferæ called Cupressinæ by Richard, in which Cupressus, Callitris, Taxodium, and Juniperus are also included. The pistils and stamens are in separate flowers on the same tree. The male catkins are terminal and solitary; the pollen of each flower is included in four cases that are attached to the inner face of the scale towards its base. The female catkin is terminal; the ovary is united to the bractea, forming together a kind of receptacle; each receptacle has two ovules; the receptacles are semipeltate, imbricated, and smooth, or, in some cases, have a recurved beak near the tip; the seeds in some are slightly winged. The leaves are scale-like, closely imbricated or compressed. The species are evergreen, either trees or shrubs, and are inhabitants of Asia, Africa, and North America.

T. occidentalis, the Western or American Arbor Vitæ, has the branchlets 2-edged; the leaves imbricated in four rows, ovato-rhomboid, adpressed, and tuberculated; the cones are obovate with the interior scales truncate and gibbous beneath the apex. This plant is a large shrub or small tree, and is a native of North America, from Canada to the mountains of Virginia and the Carolinas. It is not so frequent in the Southern states, and is found there on the steep banks of mountain-torrents. In the Northern states of America it is sometimes called the white cedar, but more commonly arbor vitæ. It grows best in cool moist places, on the borders of rivers and lakes, and in swamps, some of which it covers to the extent of 50 to 100 acres. The stem of this tree seldom rises straight from the ground, but makes a short bend before it becomes straight. On this account it is difficult to obtain trunks of any length, and, although the timber is very durable, it is not much used in building. It makes good posts and rails, which last three or four times as long as any other species. Its branches are used for making brooms, a recommendation of which is, that they exhale an agreeable odour. In Great Britain the American arbor vitæ is planted as an ornamental shrub, for which purpose it flourishes best in low moist and sheltered situations. It will bear cutting well, and hence is employed for making hedges. It grows slowly, making 6 or 8 inches of stem in a year; the largest specimens in this country have attained a height of from 30 to 45 feet.

T. orientalis, the Oriental or Chinese Arbor Vitæ, has 2-edged branchlets; imbricated, ovato-rhomboid, adpressed leaves, furrowed in the middle and in 4 rows; the cones are elliptic with the interior scales blunt, and mucronate beneath the apex. It is a native of rocky situations in Siberia and China, and on the mountains of Japan. It is a low tree and easily distinguishable from the American species by its denser foliage and lighter green colour. It has a straight trunk, and seldom exceeds 18 or 20 feet in height. It is a hardy plant, and flourishes in the gardens about London, where it was first introduced by Miller in 1752.

T. pendula, the Pendulous or Weeping Arbor Vitæ, has opposite, decussating, spreading, lanceolate, mucronate, keeled, somewhat distant leaves; globose cones; convex smooth scales; filiform pendulous branches. It is a native of Tartary, and is an elegant shrub, but only a few specimens exist at present in this country.

T. articulata of Desfontaines is now called *Callitris quadrivalvis*, four-valved Callitris. The genus Callitris differs from Thuja in having the scales of the female catkins, from 4 to 6 in number, opening like the valves of a regular pericarp, and the seeds at the base of these scales winged on the margin. The four-valved Callitris has flattened articulated leaves; the female catkin with four oval pointed valves, two of which have seeds. It is a native of Barbary, and attains a height of from 15 to 20 feet. It was first discovered by Desfontaines on Mount Atlas in 1796. The gum-sandarac of commerce [SANDARAC], according to Broussonet, Brongniart, and others, is the produce of this tree, although it is often ascribed to the Juniperus communis. This substance is brought into the market in tears, which are clear, shining, and diaphanous, and of whitish-yellow colour. When reduced to a fine powder, it makes an excellent pounce. Dissolved in spirits of wine, it forms a delicate varnish. Under the name of *alerce*, the wood of this tree is in great repute in

the East for building religious edifices. Captain S. E. Cook ascertained that the roof of the celebrated mosque, now the cathedral of Cordova, which was built in the ninth century, is constructed of the wood of the *alerce*. It appears to be a hardy tree, and would probably grow well in this climate in the open air.

(London, *Arboretum et Fruticetum Britannicum*; Lindley, *Natural System*; Burnett's *Outlines of Botany*.)

THULDEN, THEODOR VAN, born at Bois-le-Duc in 1607, was one of the most distinguished scholars and assistants of Rubens, with whom he was also a favourite. He was with Rubens in Paris, and is said to have executed the greater part of the celebrated series of the so-called Gallery of the Luxembourg, painted in honour of Mary de' Medici. Van Thulden is distinguished both as a painter and as an etcher. As a painter he excelled in various styles. There are several large pictures, both historical and allegorical, by him, dispersed over Germany and the Netherlands; he painted also small pictures from common life in the manner of Teniers, such as markets, fairs, and the like; and he was frequently employed by architectural and landscape painters to embellish their pictures with small appropriate figures, in which he was excellent; he painted many such in the pictures of Neefs and Steenwyck.

Van Thulden's style in his greater works is altogether that of Rubens, and, although inferior in boldness of design and colouring, his works may easily be mistaken for those of Rubens; the Martyrdom of St. Andrew, in St. Michael's church at Ghent, was long thought to be a work of Rubens. In chiar'oscuro, Van Thulden was quite equal to his master. A St. Sebastian, in the church of the Bernardines at Mechlin, and an Assumption of the Virgin, in the church of the Jesuits at Bruges, were considered two of his best altar-pieces. While at Paris he painted twenty-four pictures of the Life of St. John of Matha in the church of the Mathurins, which he himself etched on copper in 1633; the pictures have since been painted over. Van Thulden's etchings are numerous, and in a masterly style; he published a set of 58 plates from the paintings of Niccolò Abati at Fontainebleau, after the designs of Primaticcio, which are greatly valued, for as the paintings were destroyed in 1738, they are all that remains of the original designs. They have been copied several times; the original set appeared under the following title: 'Les Travaux d'Ulysse, dessinés par le Sieur de Saint-Martin, de la façon qu'ils se voyent dans la Maison Royale de Fontainebleau, peint par le Sieur Nicolas, et gravés au cuivre par Theodore van Thulden, avec le sujet et l'explication morale de chaque figure.' He etched also 42 plates after Rubens, of the entrance of Ferdinand the Cardinal-Infant into Antwerp: 'Pompa introitus Ferdinandi,' &c. The eight plates of the History of the Prodigal Son, to which he put Rubens' name, are now said to be from his own designs; they are entitled, 'De verlooren Soon, door P. P. Rubens. Th. Van Thulden fec.' Van Thulden died in his native place, Bois-le-Duc, in 1676.

(Descamps, *La Vie des Peintres Flamands*, &c.; Füßli, *Allgemeines Künstler Lexicon*.)

THULITE, a mineral, the texture of which is usually granular. Lustre vitreous. Translucent on the edges. Hardness between 5 and 6; but the grains separate so easily that it is rather difficult to determine it. Colour rose-red; streak greyish-white. Specific gravity 3.1055.

Before the blowpipe fuses with carbonate of soda into a greenish-white bead; with borax forms a colourless transparent bead; but on the addition of nitre becomes violet.

It has been found in Norway; and, according to Gmelin, consists of—silica, 42.808; alumina, 31.144; lime, 18.726; soda and a trace of potash, 1.891; oxide of iron, 2.888; oxide of manganese, 1.635; water, 0.640: total, 99.732.

THÜMMEL, MORITZ AUGUST VON, a German writer who was greatly admired by his contemporaries, and who still continues to hold a high literary rank with his own countrymen. He was born at Schönfeld, near Leipzig, May 27th, 1738, where his father possessed considerable property, but lost much of it by the plundering of the Prussian troops in Saxony, 1745. Moritz, who was the second son of a family of nineteen, was sent to the university of Leipzig in 1756. There he found in Gellert not only an instructor, but a friend; and he also formed an acquaintance with Weisse, Rabener, von Kleist, &c., and, among others, with an old advocate named Balz, who at his death, in 1776, left him the whole of his fortune,

twenty-four thousand dollars. This accession of wealth enabled Moritz to give up the places he held under Duke Ernest of Saxe-Coburg, first as Kammer-junker, and from 1768, as privy councillor and minister, and to retire in 1790 to Sonneborn, an estate of his wife, at which place and at Gotha he continued chiefly to reside until his death, which happened while he was on a visit at Coburg, October 26th, 1817. Thümmel's literary reputation was established by his 'Wilhelmine,' a 'comic poem in prose,' first published in 1764. This short production, for it is in only five cantos or chapters, was received as something altogether new in German literature, and as a masterpiece of polished humour and playful satire. It was translated not only into French, but Dutch, Italian, and Russian; and it has been reprinted entire in Wolff's 'Encyclopædie' 1802. His poetical tale, 'Die Inoculation der Liebe,' 1771, and other pieces in verse, did not add much to his fame; but his last and longest work, 'Reise in den Mittäglichen Provinzen von Frankreich' (Travels in the Southern Provinces of France), in 9 vols., 1799-1805, is also his literary chef-d'œuvre. Instead of being, as its title would import, the mere record of his tours in that country, it is, like Sterne's 'Sentimental Journey,' to a great extent, a work of fiction, interspersed with fragments in verse, which breathe more of poetry than his other productions of that kind. It abounds with satiric humour and pleasantry, with witty and shrewd observations, and shows the author to have been an accomplished man of the world, intimately acquainted with human nature. That it is a work of no ordinary merit and pretension may be supposed from the notice it has obtained from Schiller, in his essay 'Ueber Naive und Sentimentalische Dichtung,' who, if he praises it with greater reserve than other critics, admits that, as a work of amusement, it is one of a superior kind, and will as such continue to enjoy the character it has obtained. A portrait of Thümmel, after Oeser, is fixed to the 6th volume of the 'Neue Bibliothek der neuen Wissenschaften,' a complete edition of his works, six volumes.

(Jörden's *Lexicon*; Schiller's *Kleinere Prosaische Schriften*; Wachler's *Vorlesungen*.)

THUN, a town in the canton of Bern in Switzerland, situated on the river Aar, about a mile below its exit from the lake of the same name. Part of the town stands on an island formed by the river, and part is on the right bank, at the foot of a hill, on which is built the castle, the keep of which was, in the middle ages, the residence of the counts of Thun. On the opposite or southern side are seen the Alps of the Oberland, covered with perpetual snow. The parish church, with its lofty tower, is a remarkable building. There are also a handsome town-house, an hospital, an orphan asylum, a public library of 7000 volumes, and a military school for the artillery and engineer corps of the federal service. [SWITZERLAND.] The population of Thun amounted, by the last census, to 4833 inhabitants. (Lerchesche, *Dictionnaire Géographique Statistique de la Suisse*, 1836.)

The lake of Thun, Thunersee in German, is 14 miles long from south-east to north-west, about three miles in its greatest width, and about 700 feet deep. Its surface is 1780 feet above the sea. The Aar, coming from the lake of Brienz, enters it at its south-east end, and issues from it at the opposite extremity. The Kander, swelled by the Simmen, also enters the lake from the south. The lake abounds with fish; and its banks, planted with vineyards in some places, and rising abruptly to steep mountains in others, afford a variety of scenery. A steam-boat plies at the lake.

THUNBERG, CARL PETTER, an eminent Swedish traveller and botanist, and professor of natural history at the university of Upsal, was born on the 11th of November, 1743, at Jönköping in Sweden, where his father was a clergyman. He was early sent to the university of Upsal for the purpose of studying medicine, and became a pupil of the great Linnæus. Under his instruction he acquired that taste for natural history which so remarkably distinguished the school of Linnæus, and which has given to the world so many famous naturalists. Having completed his course of study, he graduated in 1770, and was honoured by having bestowed upon him the Koborn pension for the space of three years. Although the sum was small, about fifteen pounds per annum, he determined to use it for the purposes of improvement, and accordingly

left Upsal for the purpose of visiting Paris and the universities of Holland. Whilst in Amsterdam, he became acquainted with the botanists and florists of that city, and they suggested to him the desirableness of some person visiting Japan for the purpose of exploring its vegetable treasures. Thunberg immediately offered his services, and a situation as surgeon to one of the Dutch East India Company's vessels having been obtained for him, he left Amsterdam for Japan in the year 1771. He landed at the Cape of Good Hope for the purpose of learning amongst the Dutch settlers there the Dutch language, which is the only European language spoken extensively in Japan, and also in the hope of adding to his knowledge of natural objects by researches in Africa. Here he made several excursions into the interior, visiting various of the native tribes, and after having remained at the Cape three winters, where he collected much valuable information, he set sail in 1773 for Java and the Japan Isles. He remained in these islands five years, making large collections of the plants of these countries, as well as observations on the habits, manners, and language of their inhabitants. His ability to labour, however, during his residence both in Africa and Asia, was very much diminished by a frightful accident which he met with on first leaving Holland. The keeper of the stores in the ship, having inadvertently given out white lead instead of flour, it was mixed with flour and used for making pancakes, of which the whole crew partook. All were ill, and many suffered very severely at the time, but none was so bad as Thunberg; he only gradually recovered his health, and through his long life always laboured under the debility and derangement his system had thus received. He returned to his native country in 1779, making first a short stay in England. Here he formed the acquaintance of Sir Joseph Banks, Dryander, and Solander, and availed himself of the extensive collection of plants from all parts of the world, and valuable library of Sir Joseph, for the purpose of adding to his botanical knowledge. During his absence he had been made demonstrator of botany at Upsal in 1777, and in 1784 was installed in the chair of the great Linnæus as professor of botany. In 1785 he was made a knight of the order of Wasa, and in 1815 commander of the same order.

On gaining his home, Thunberg immediately commenced arranging the vast mass of materials he had collected in his travels for the purpose of publication. His most important work was a description of the Japanese plants, which was published at Leipzig in 1794, with the title, 'Flora Japonica, sistens Plantas Insularum Japonicarum, secundum Systema Sexuale emendatum,' 8vo., and illustrated with thirty-nine engravings. In this work a great number of new plants were described and arranged according to the Linnæan system, in which he ventured to dispense with the three classes called Monœcia, Diœcia, and Polygamia. He subsequently published some botanical observations on this 'Flora,' in the second volume of his 'Transactions' of the Linnæan Society.

In 1788 he commenced the publication of an account of his travels, under the title, 'Resa uti Europa, Africa, Asia, orattad åren 1770-1779,' Upsal., 8vo. This work was completed in four volumes, and contains a full account of his eventful life, from the time he started from Upsal with his Kohrean pension, till he returned to the same place laden with treasures from a hitherto unexplored region. In these volumes he has taken great pains to collect all possible information on the medicinal and dietetic properties of plants in the countries he visited, as well as their uses in rural and domestic economy. He recommends several new plants for cultivation in Europe as substitutes or those in present use. This work also gives a simple and pleasing account of the original natives of the places in which he sojourned, as well as of the European settlers.

It has been translated into German by Groskund, and published at Berlin in 1792. It appeared in English at London in 1793, and in French at Paris in 1796. His next work was a 'Prodromus Plantarum Capensium, Annis 1772-1775 collectarum,' Upsaliæ, 1794-1800; being an account of the plants he had collected at the Cape. From 1794 to 1805 he published in folio, under the title 'Icones Plantarum Japonicarum,' Upsaliæ, a series of plates illustrative of the botany of the Japan Isles. These were followed by the 'Flora Capensis,' Upsaliæ, 1807-13, 8vo. In this work the most complete view of the botany of the

Cape of Good Hope is given that has hitherto been published. In 1807, in conjunction with Billberg, he published the 'Plantarum Brasiliensium Decas Prima,' Upsaliæ, 4to. In this work the plants collected by Freireiss and Sauerländer, in the province of Minas Geraës in Brazil, are described; but the subsequent parts were published by other hands.

Besides the above works, on which the reputation of Thunberg as a traveller and a botanist mainly rests, he was the author of almost countless memoirs and academical dissertations. The subjects of these were chiefly those which his long residence in Africa and Asia afforded. The majority of them are upon botanical topics, not a few however are devoted to a consideration of zoological subjects. Although botany was his primary object in his travels, he yet lost no opportunity of obtaining a knowledge of the new animals he met with, and several of his papers are descriptions of these. He published several memoirs in the London 'Philosophical Transactions,' and the 'Transactions' of the Linnæan Society, also in the Transactions of Russian, German, French, and Dutch scientific Societies and Journals, and a much greater number in those of Sweden. The academical dissertations bearing his name, and presented at the university of Upsal, are nearly one hundred in number, and were published between the years 1789 and 1813.

Thunberg was elected an honorary member of sixty-six learned societies. He died at the advanced age of eighty-five, on the 8th of August, 1828.

Retzius named a genus of plants in the natural order Acanthaceæ, in honour of him, *Thunbergia*. The following genera of plants have species named after him:—*Ixia*, *Isolepis*, *Cyperus*, *Imperata*, *Spatalla*, *Convolvulus*, *Campanula*, *Gardenia*, *Atriplex*, *Hydrocotyle*, *Rhus*, *Crasula*, *Berberis*, *Erica*, *Passerina*, *Thalictrum*, *Cocculus*, *Equisetum*, *Hypnum*, *Fissidens*, *Cystoseira*, *Gyalecta*, and *Endocarpon*. Of insects, the genera *Harpalus*, *Lygæus*, *Pyralis*, and *Tinea* have specific names after Thunberg.

Thunberg was an amiable kind man, and highly esteemed by his friends and pupils. The great additions that he has made to our knowledge of the plants of the world, as well as their uses to man, place him amongst the most distinguished botanists of the last and present century. He was not great as a vegetable physiologist, nor did he attempt anything more in systematic botany than a slight emendation of the system of Linnæus. In this he was followed by very few; and those who at the present day have recourse to that system for arranging plants, generally adopt the primitive plan of Linnæus. As a traveller, Thunberg is remarkable for the accuracy of his observations on the manners, habits, and domestic economy of the people that he visited.

(Bischoff, *Lehrbuch der Botanik*; *Resa uti Europa, &c.*; *Kongl. Vetensk. Acad. Handlingar*, 1829.)

THUNDER is an explosion accompanied by a loud noise, which is heard after a discharge of lightning from the clouds. The character of the noise is variable: it sometimes resembles that which is produced when a single piece of ordnance is fired; at other times it is a rolling sound like the successive discharges of several great guns; and occasionally it may be compared to a series of sharp reports from a fire of musketry.

The identity of lightning with the electric fluid is now well known [LIGHTNING], but the physical cause of the detonation which accompanies the flash is still the subject of conjecture; in general it is considered that lightning, by its heat, creates a partial vacuum in the atmosphere, and that the sudden rushing of air into the void space produces the sound; but various reasons have been assigned for its prolongation. It was formerly supposed that the rolling noise is merely the result of several echos caused by the sound being reflected from mountains, woods, buildings, or clouds, or from the latter alone when a thunder-storm takes place over the ocean: this opinion seems to have been founded upon the fact that the report of a fire-arm discharged in a mountainous tract is prolonged by the echos during at least half a minute, which is about the time that the rolling of thunder continues. But though the reflections of sound are, very probably, in part, or at times, the causes of the prolongation of the report arising from the explosion, yet it must be admitted that these will not always afford a satisfactory explanation of the phenomena. It may happen, for example, that, when the sky is

uniformly covered with clouds, a flash of lightning will dart from the zenith, and, after a few seconds, the crash of thunder will take place accompanied by a rolling sound: soon, a second flash may pierce the clouds in the zenith and thunder may follow, but now the crash, though loud, may not be prolonged. It is justly observed by M. Arago that this is very different from the phenomena of echoes; and the explanation which was first proposed by Dr. Hooke ('Posthumous Works,' 1705) is perhaps that which possesses the highest degree of probability. The flashes of lightning, Dr. Hooke observes, are either simple or multiple: the first occupies but one small portion of space, and gives rise to an instantaneous report; the multiple flash takes place at different parts of one long line: if these parts should be situated in a circular arc, and the observer should be in its centre, all the reports would arrive at his ear at the same time, and still one loud crash only would be heard; but if the parts were nearly in a straight line, and the observer were at one of its extremities, the reports, whether they take place at the same instant or in succession, would arrive at his ear at different times, depending wholly or partly on the distances. It may be considered therefore that the rolling arises from the circumstance that the points of explosion are at different distances from the observer; and it will follow that the duration of the noise is equal to the time in which sound travels through an interval equal to the difference between the lengths of two lines drawn from the observer to the two extremities of the flash. The flash of lightning and the report of the thunder take place in reality at the same moment; but since sound travels at the rate of 1100 feet per second, while the passage of light from the cloud to the observer may be considered as instantaneous, it follows that, on counting the number of seconds which elapse between the time of seeing the flash and hearing the report, the distance of the thunder-cloud from the observer may be ascertained if 1100 feet be multiplied by that number of seconds.

The experiments of Lavoisier and La Place have shown that the molecules of water, in evaporating, convey away from the earth a portion of the electricity which it contains, and which the water has acquired in being converted into vapour. This electricity becomes diffused in the upper regions of the atmosphere, and, when the vapours again become condensed so as to form globules of water, the electricity disposes itself on the surface of the globules in different quantities according to their magnitudes. When these globules have equal volumes, those quantities are equal; and, an equilibrium then subsisting with respect to electricity, no sensible effect is produced: but when a considerable difference takes place between the quantities of electricity on the different globules, the tendency of that element to return to a state of equilibrium causes it to pass rapidly in flashes from those globules which have more, to those which have less, than their mean quantity; and thus, if the condensation be great and take place suddenly, vivid flashes of lightning and loud peals of thunder may take place. The effect is probably the greatest when two masses of clouds in opposite states of electricity are carried rapidly against one another by winds blowing in contrary directions.

An opinion prevails that thunder has been heard when the sky was without a cloud, but the fact can scarcely be said to be satisfactorily established; for the sounds which, in countries subject to earthquakes, have been supposed to be thunder, proceed from under the ground, and may result from a different cause. Volney however relates that, being one day at Pontchartrain near Versailles, when no cloud was visible, he heard distinctly four or five claps of thunder: he adds that about an hour afterwards the sky became overcast, and a violent hail-storm followed. On this relation M. Arago observes that the sounds could not have been heard if they had come from clouds at a greater distance than six leagues: and if the clouds had been at, or a little within, that distance, they must have been visible, unless it be supposed that they were not more than a few yards above the ground: but the hail which followed the thunder must have proceeded from clouds having great elevation, though at the time the claps were heard they were too remote to allow any sound from them to reach the ear: and therefore he concludes that the sounds must have been produced in the air itself. For an account of death caused by electricity in the air when the thunder-cloud was very distant, and

for the theory of the returning stroke, see the *Philosophical Transactions*, vol. lxxvii.; and STANHOPE, CHARLES, Esq.

From the meteorological observations made by Dr. Scoresby, and Captains Phipps, Parry, and Ross, it appears that neither thunder nor lightning is known to take place beyond the 75th degree of north latitude: even so low as the 70th degree those phenomena are very rare: and in the tables of Captain Parry the occurrence of thunder and lightning is mentioned but once between June, 1821, and September, 1823. Captain Franklin also, in 67½° N. lat., heard thunder on one day only between September, 1825, and August, 1826.

THUNDER-ROD, a bar of metal attached generally to a side of a building, and extending from below the level of the ground to a point several feet above the highest part of the roof, or of the steeple, if the building have one, in order to secure the edifice from the effects of thunder or lightning: the upper extremity of the rod or bar terminates in a point.

When a thunder-cloud passes above an elevated object, it produces in the nearest part of the object the kind of electricity which is opposite to that of the cloud itself, so that a rapid and abundant communication takes place; either the electric matter in the cloud rushes towards the earth, or that of the earth rushes towards the cloud: and if the materials of the building are not good conductors of the fluid, the latter in its passage exerts an explosive action by which the building is destroyed or greatly injured. The thunder-rod, from the conducting property of its metallic substance, serves to convey the fluid harmlessly to the earth or air. When it has happened that there is an interruption of the communication, by the rod being broken, or even by being much diminished in magnitude in some part of its length, the electric fluid has been observed to pass between the parts of the rod above and below the place of fracture.

Buffon, and Dalibard, at his suggestion 1752, are to have been the first persons who drew lightning from the atmosphere by means of pointed rods of metal: and in the following year M. de Romas elevated a paper kite to the height of 550 feet for the like purpose: this was about twelve months before Dr. Franklin, without any knowledge of what had been done in Europe, performed the like experiment in America. The object of the French philosophers was merely to obtain by those means electrical sparks or flashes of fire: but it is to Dr. Franklin that the world is indebted for the idea of raising pointed rods in order to secure buildings from the effects of atmospheric electricity; and the recommendation was immediately adopted both for edifices on land and ships on the water.

Soon after the first employment of thunder-rods in Europe, an opinion prevailed that when their extremities were pointed they created a danger which did not exist before, and that they attracted lightnings which would, without the rods, have discharged themselves at a distance: and in order to diminish the risk, it was proposed to crown the summits of the rods with knobs or balls of metal. The notion was entertained by the Abbé Nollet, in France; but in the Royal Society of London the question concerning the relative efficacies of pointed and knobbed conductors was agitated with great vehemence, chiefly through the obstinacy of Mr. Wilson, one of the Fellows, who, in 1778, made himself the head of a party in support of the latter kind of conductors, in opposition to the president. [PRINGLE, JOHN.] It is remarkable that both George III. of England and Frederick of Prussia placed themselves on the side of the opponents of Franklin; the first king giving the preference to balls over points, and the other, while he consented to have conductors raised on his barracks and powder-magazines, prohibited the erection of them on his palace of Sans Souci. It is now admitted that the prejudice against pointed thunder-rods was entirely without foundation: those conductors have been found not only to protect buildings when struck, but also to diminish the number of shocks which in a given time they have experienced. An experiment which was made by Beccaria in 1753, might have shown the superiority of pointed conductors over those with balls; for that distinguished electrician set up on the roof of the church of San Giovanni, at Turin, a metallic rod bent near the top and terminated in a point: the upper part was capable of being surrounded by means of a silk line, so that the point could

directed upwards or downwards at pleasure, and the lower part of the rod terminated upon substances which were imperfect conductors of electricity. On directing the point towards the sky when a thunder-cloud passed over the church, electrical sparks issued in abundance from the foot of the rod; but when the point of the rod was reversed so that the bend was upwards, few or none were obtained. The conducting-rod set up by Professor Richman, at St. Petersburg, may be said to have been the cause of his death (in 1753); but the house would most probably have been struck if there had been no conductor. The immediate cause of the melancholy accident was that the rod led into the apartment, and the unfortunate Professor was standing too near its lower extremity. (*Phil. Trans.*, vol. xlviii.)

Some doubt however still exists concerning the distance to which the protecting influence of the rod extends, but it is generally supposed that this influence is limited by the circumference of a circle described about the rod with a radius equal to double its height above the top of the building.

When the magazine at Purfleet was struck by lightning in 1777, the shock took place on an iron cramp which united two stones of the cornice, at the distance of 24 feet from the thunder-rod, measured horizontally; and the upper extremity of the rod was 11 feet above the top of the roof on which it was erected. Again, in 1781, the workhouse at Heckingham in Norfolk, though provided with eight rods, was struck by lightning at a spot which was distant 55 feet measured horizontally from the nearest rod, while the pointed summit of the latter was 22 feet above the level of the part struck; and many other instances might be cited in confirmation of the supposition. It may be inferred therefore that large buildings ought to be secured by several rods, and that the less these are elevated the greater ought to be their number; also that no point of the building ought to be at a greater horizontal distance from the nearest rod than twice the height of the rod above the top of the building. Mr. Cavendish, Dr. Priestley, and other English philosophers, recommend them to stand 10 feet above the roof; but in France their height is sometimes more than 30 feet.

The most elevated objects are not always those which are struck by lightning; for in 1829, the sails of a mill at Toothill in Essex being at rest, the electric fluid left untouched the arm, which was in a vertical position, and fell on a knob of iron at the middle of one of those which was inclined to the horizon in an angle of 45°; and it has frequently happened that buildings containing in their walls conducting substances have been struck much below their summits by a lateral action of the fluid; bars or plates of metal in the side walls having served to attract it more powerfully than the materials on the roof. This happened to the cathedral at Lausanne in 1783.

In order that the points of rods may not become blunt by rust, they are generally made of copper and covered with gilding; but it appears to be the practice of late to make the upper part of the rod of platinum, this metal being not only unaffected by the corrosive power of the air or rain-water, but also incapable of fusion by heat. As the erection of a thunder-rod requires in general an expensive scaffolding, the latter metal, even though more costly than iron or copper, will from its durability be in reality more economical than either of the others.

Thunder-rods are frequently made to terminate at the upper extremity with one point in a vertical position, and about this a number of points diverge from the rod at different inclinations to the horizon: by this construction there is not only a probability that some of the points will be acute when others may have been blunted by the action of the atmosphere, but also among them there will always be one which presents itself in the most favourable position for attracting the electric fluid. Observations have not yet however been sufficiently multiplied to enable philosophers to decide whether conductors so terminated have any advantage over the more simple rods of Franklin.

The thunder-rod should be thick enough to carry the electric fluid to the ground without being melted by it; in general a cylindrical rod about half an inch in diameter will be sufficient to prevent this effect from taking place; whether of iron or copper, it should be covered above ground with a coating of paint; and the part under ground is usually formed with two or more branches in order to

facilitate the passage of the electric fluid into the earth. It must be observed however that, if the lower part of an iron thunder-rod descends into water, it is liable to become corroded by rust; and a dry soil is not a good conductor of electricity. On the Continent it has been the practice to let the lower part of the rod enter into a pit filled with ashes of burnt wood or powdered coke. If the rod is made of a kind of metal which does not become corroded in water, its lower extremity may be allowed to enter about three feet below the surface: the water should be that of a natural pond, for, if it be in an artificial reservoir, the walls of the latter, being sometimes formed of, or covered with, conducting substances, may prevent the electric fluid from diffusing itself in the earth.

When a building is provided with several rods, each of these should be continued quite to the ground: at the level of the parapet the several rods should be connected together laterally by slender iron bars; and the plates of iron which enter into the construction of roofs should in like manner have a metallic communication with each other. As the thunder-rod is necessarily made to follow the outline of a cornice and roof, the part below that which projects above the roof may be made of metallic cords, in order to avoid the formation of angles in its length; for experience has shown that lightning in descending a rod has quitted the latter at its angles, and, after passing through the air, has struck objects which were situated in the line of its first direction. In the expectation of being able to attract the lightning entirely away from powder-magazines, or any building containing explosive materials, thunder-rods have been attached to masts at the distance of a few yards from the building: this practice has many advocates, and the only objection to it is, that it is attended with considerable expense.

Many lofty buildings contain in their construction the means of securing them from the effects of lightning, and such is the case with the Monument on Fish-Street Hill; this building, whose height is more than 200 feet, is crowned with a metallic ball surrounded by bands which terminate in points tending upwards. From the ball descend four bars of iron which serve to support a flight of steps, of the same metal, and one of them is in connection with the iron railing which extends from the balcony to the ground. In 1764 lightning struck the steeple of St. Bride's Church in Fleet Street, and descended from thence along an iron bar about 20 feet in length and two inches in breadth, which was almost buried in the stones: the electric fluid left no traces of its passage along this bar, but at the place where the metal terminated the damage commenced, the stones being destroyed or thrown to a considerable distance. A similar accident has this summer (1842) occurred to the church of St. Martin in Westminster.

A ship at sea, like an edifice on land, may, when there is an accumulation of electric matter in the upper part of the atmosphere, be struck aloft; or, when the atmosphere is in a contrary state, the lower part of the ship may be struck, the lightning in the latter case ascending along the mast: and ships unfurnished with metallic conductors have frequently suffered serious injury during thunderstorms, while those which have been so provided have generally escaped. When Captain Cook was at Batavia, lightning fell on the ship with such force that the shock resembled an earthquake; the conductor, which was very slender, appeared to be on fire from the mast-head to the sea, yet no damage was done to the ship. In 1814, while a great storm raged at Plymouth, of all the ships then in port only one was struck by lightning, and this alone was not provided with conductors. And in the roads at Corfu, three violent flashes struck the ship Etna, which had conductors, without doing any injury, while two ships not far distant, being destitute of such protection, were much damaged.

The rigid bars of Franklin are considered inapplicable, as conductors, to ships, and instead of them chains of copper have been generally employed; these are attached to the masts at their upper extremities; and, following the standing rigging, they pass down the ship's sides into the water. Objections have been made to them on account of their want of continuity, and their liability to be injured or broken during storms; and copper links attached to the masts by flexible spiral wires were suggested by Mr. Singer. M. le Roy also recommended a chain of copper rings which were to encircle the main-topmast backstay; but neither of these methods has been put in practice. In

1822 Mr. Snow Harris proposed ('Observations on the effects of Lightning on Floating Bodies'), and subsequently caused to be executed for ships, conductors consisting of slips of copper, of sufficient thickness to prevent them from being fused; these slips are inserted, in two layers, in a groove cut longitudinally along the mast, the joints of one layer being opposite the middle parts of the other, and they are fastened to the mast by copper screws. The whole line of metal passes down from the copper spindle at the top of the mast-head, and at the junctions of the upper and lower masts the slip is made to join a cylinder of copper which lines each sheave-hole: the lower part of the line is connected with a plate of copper which is fixed on the keelson, at the step, and from thence there is a communication with the water by three copper bolts which pass quite through the keel.

THURGAU, a canton of Switzerland, bounded on the north partly by the lake of Constance, and partly by the Rhine, which divides it from the canton of Schaffhausen; on the east and south by the canton of St. Gallen, and on the west by that of Zürich. The river Thur, which comes from the canton of St. Gallen and is joined by the Sitter from Appenzell, has given its name to the canton 'Thurgau,' or 'district of the Thur,' the river crossing the middle part of it from east to west. The valley of the Thur is separated from the basin of the lake of Constance by a succession of hills which rise in terraces on both sides, and are intersected by several valleys. On the south and west sides other hills divide the Thurgau from the valley of the Töss in the canton of Zürich. The whole country belongs to the plateau or table-land of Switzerland, and is a considerable distance from the Alpine region. The climate of the Thurgau is comparatively mild; a great part of the country is planted with fruit-trees, especially apple, pear, and cherry: the vine also thrives in several localities. The produce of corn is not sufficient for the consumption. According to a late return, there were in Thurgau about 28,000 head of horned cattle, 3500 sheep and goats, and 2550 horses. The rivers and the lake abound with fish. The area of the canton is estimated at about 365 English square miles; and the population in 1835 was 84,124 inhabitants, of whom about 66,000 follow the tenets of the Reformed or Protestant communion, and the rest are Roman Catholics. German is the language of the country. About one-third of the population is employed in trade and manufactures. The principal manufactures consist of cotton goods, in which above 3000 looms are employed. The average wages of a workman are about 7½ batzen, or eleven pence sterling per day. About 3000 pieces of fine linen from native flax are made annually; but this manufacture is on the decline. There are also spinning-factories which produce yarns of the quality from No. 40 to 60. The tariff of the German commercial league has much diminished the exportation of manufactured goods. Some silks are manufactured for the French market. The other exports consist of wine, cattle, oats, dried fruit, and cider. The principal imports are—iron and metal ware, chiefly from England; coarse woollen goods from Germany; fine woollen from France and Belgium; fine cotton yarns from England; salt from Bavaria and Würtemberg; colonial articles, and wheat.

The revenue of the canton amounts to about 102,000 florins, or 85000/ sterling, and is derived from duties on salt and other articles imported, stamps, transfers of property, and an income-tax.

Elementary education has been improved of late years. There are about 264 schools, 200 of which are for Protestants, 58 for Roman Catholics, and six mixed of both communions. About 17,000 children attend the schools. A school for teachers has been established at Kreuzlingen.

There is a fund, the capital of which amounts to about half a million of florins, for the support of the poor, besides which there is a small poor's rate on property. The annual expenditure for the poor varies from 15,000 to 30,000 florins. There is a special fund for hospitals and also a benevolent fund. Switzerland in general is a country remarkable for its charitable spirit.

Thurgau is divided into eight districts—Frauenfeld, Arbon, Bischofzell, Tobe, Weinfeld, Gottheben, Steckborn, and Diessenhofen. The principal towns are—1. Frauenfeld, which is the head town of the canton, situated in a fertile valley near the confluence of the river Murg with the Thur. It consists of 162 houses, besides other

buildings, forming three wide streets; the total amount to about 1300. The old castle, former residence of the Swiss vögtin or governors of the town-house, where the Helvetic diet used to sit in the time of the old confederation; the arsenal; a Protestant and Roman Catholic churches, are the buildings. 2. Steckborn, a small busy town, situated on the banks of the Zellersee, or smaller lake of Constance, has several manufactories, and 1900 inhabitants. In the neighbourhood of Steckborn fine country-residence called Arenenberg, which was chased by the countess of St. Leu, daughter of Jos. Beauharnais and wife of Louis Bonaparte, ex-king of Holland, and in which she died in 1840. 3. Diessenhofen, on the left or southern bank of the Rhine, a place of considerable trade in agricultural produce has about 1000 inhabitants. 4. Bischofzell, at the confluence of the Sitter and the Thur, is a walled town with a collegiate church of the ninth century, an old long bridge on the Thur, several schools, and about 1000 inhabitants. 5. Arbon, a small town on the southern bank of the Bodensee, or lake of Constance, of which it enjoys a splendid view, is said to be built on the site of a Roman station named Arbor Felix.

The canton of Thurgau is a representative democracy with a legislative assembly, 'Grosser Rath,' and an executive council, 'Kleiner Rath.' The right of election of members of the legislature is subject to qualifications; but by the last accounts we have seen the constitution was undergoing a revision.

(Leresche, *Dictionnaire Géographique Statistique Suisse*; J. Bowring's *Report on the Commercial Factories of Switzerland*.)

THÜRINGER WALD. [GERMANY: PRUSSIA.] THURINGIA (*Thüringen*) is the ancient name of an extensive tract of country in the central part of Germany situated between the Harz Mountains, the rivers Werra, and the Thüringerwald. These however are not the boundaries of the great kingdom of Thuringia which extended to the Elbe, and northwards nearly to the North Sea, southwards to the vicinity of the Danube, comprehended on the west the greater part of the country afterwards called Franconia. It cannot be positively ascertained what people originally possessed Thuringia. According to Galetti, it was formerly inhabited by the Catti. Vegetius mentions the Thuringi about the year 304. Various conjectures have been made respecting the derivation of the name: and authors, misled by a similarity of names, have confounded them with others. The history of the country is very intricate, and has been the subject of numerous works, such as Galetti's 'History of Thuringia' 6 vols.; and Wachter's History, in 3 vols. Thuringia gave the title of margrave to the elector of Saxony. Properly speaking, there is no country now called Thuringia: it is divided among Prussia, Saxe-Weimar, Saxe-Coburg, Schwarzburg-Sonderhausen, and Schwarzburg-Rudolstadt. The name is still preserved in the Thüringerwald, a continuation of the Fichtelgebirge, which it branches out near Mühlberg and Gera into the kingdom of Bavaria: near Eisenach, Marktsalza, and Salzungen it rises above the Werrathal; it then runs east along the frontier of the former circle of Saxony and Franconia, till it turns, near Leine, into the Saalthal (where however it receives the name of Frankenwald), and declines, near Kronach, into the Mainthal. The length is 70 English miles, and the breadth varies from 9 to 18 miles. It covers 3400 square miles, and has a population of 2200 inhabitants, living in 28 towns and 570 villages. It is a mountain-chain with a narrow ridge, and it is only at Schnee-kopf, on the road between Suhl and Oberhof, there is a plateau two or three miles across. The highest points are the Schnee-kopf, 2700 feet, and Inselsberg, 2604 feet, above the level of the sea. The highest points consist of granite, clay-slate, and gneiss, and partly porphyry: the whole chain is clothed to the summit with pine-forests, mixed in a few places with oak and other timber. Numerous rivers rise in the chain, which flow on one side into the Elbe, and on the other into the Weser.

(Hassel, *Geograph. Lexicon*; Stein's *Lexicon*; Haus, *Conversations Lexicon*.)

THURLOE, JOHN, who held the office of secretary of state during the Commonwealth, was born in 1616, at Abbots Roding, in Essex, of which place his father, the Rev. Thomas Thurloe, was rector. He was designed for the profession of the law. Through the interest of Oliver St. John, who was his patron through life, he was appointed, in 1645, one of the secretaries to the parliament commissioners for conducting the treaty of Uxbridge. He was called to the bar after this, in 1647, by the society of Lincoln's Inn; and in March, 1648, he received the appointment of receiver or clerk of the cursitors' fines, 'worth at least 350*l.* per annum,' says Whitelocke; 'and in this place was Mr. Thurloe servant to Mr. Solicitor St. John.' (*Memorials*, p. 296.)

Thurloe has left behind him a distinct denial of knowledge of or participation in King Charles's death, which took place, as is well known, in January, 1649. Writing to Sir Harbottle Grimston for the purpose of contradicting reports that St. John had been Cromwell's counsellor on that and on other occasions, and 'that I was the medium or hand between them by which their counsels were communicated to each other,' he says, 'I was altogether a stranger to that fact and to all the counsels about it, having not had the least communication with any person whatsoever therein.' (*Thurloe's State Papers*, vol. vii., p. 914.) It was very unlikely that a person in Thurloe's subordinate position at that time should have been consulted; and if it were a question of any importance whether he approved of the king's death or not, his subsequent continual identification with the authors of that event is more than sufficient to fix him with responsibility.

On the 11th of February, 1650, Thurloe was appointed one of the officers of the treasury of the Company of undertakers for draining Bedford Level, a new effort to drain this tract of country having been set on foot the year before. [*BEDFORD LEVEL.*] In a letter from St. John to Thurloe, dated April 13, 1652 (*State Papers*, vol. i., p. 205), which is interesting as showing the terms on which Thurloe and St. John were, we find that Thurloe was then on an official tour of inspection: 'Now you are upon the place, it would be well to see all the works on the north of Bedford river to be begun. Pray by the next let me know whether Bedford river be finished as to the bottoming.' In the same letter are directions from St. John, now ord-chief-justice, for the purchase of a place for him in the neighbourhood of London, from which it would appear that Thurloe was in the habit of managing St. John's private affairs for him. The same letter contains St. John's congratulations to Thurloe on his appointment as secretary of the council of state, which appointment had just taken place: 'I hear from Sir Hen. Vayne, and otherwise, of our election into Mr. Frost's place, with the circumstances. God forbid I should in the least repine at any his works of providence, much more at those relating to your own good, and the good of many. No, I bless him. As soon as I heard the news, in what concerned you, I rejoiced in it upon those grounds. No, go on and prosper: let not our hands faint: wait upon Him in his ways, and he that hath called you will cause his presence and blessing to go along with you.' In the course of the previous year, 1651, Thurloe had been to the Hague, as secretary to St. John and trickland, ambassadors to the states of the United Provinces.

When Cromwell assumed the Protectorship, in December, 1653, Thurloe was appointed his secretary of state. In consequence of his attaining to this distinction, he was, in the February succeeding, elected a bencher of the society of Lincoln's Inn. Thurloe was elected member for the Isle of Ely in Cromwell's second parliament, called in June, 1654, and framed on the model prescribed by the Instrument of Government. He was re-elected for the Isle of Ely in the next parliament, called in September, 1656. Cromwell obtained from this parliament an act settling the office of post of letters, both inland and foreign, in the state for ever, and granting power to the Protector to let it for eleven years at such rent as he should judge reasonable: and it was let by him to Thurloe, at a rent of 800*l.* a year, as we learn from a memorandum drawn up by him when the Rump Parliament had cancelled the act. (*State Papers*, vol. vii., p. 788.) It is to be inferred that he made much profit by this farming of the office. The salary of his secretaryship of state was 800*l.* year. He is described in a 'Narrative of the Late Parliament,' reprinted in the 'Harleian Miscellany' (vol. iii.,

p. 453), as 'secretary of state and chief postmaster of England, places of a vast income.'

There is the following entry in Whitelocke's 'Memorials,' under the date of April 9, 1657:—'A plot discovered by the vigilancy of Thurloe, of an intended insurrection by Major-General Harrison and many of the Fifth-Monarchy men' (p. 655). Thurloe afterwards, by Cromwell's desire, reported on the subject of this plot to the parliament, and received in his place the thanks of the house, through the Speaker, for his detection of the plot, and 'for the great services done by him to the commonwealth and to the parliament, both in this and many other particulars.' On the 13th July, 1657, he was sworn one of the privy council to the Protector, appointed in accordance with the 'Humble Petition and Advice.' Honours now came thick upon him. In the year 1658 he was elected one of the governors of the Charter-House and chancellor of the university of Glasgow.

In September, 1658, Cromwell died, and his son Richard was proclaimed in his stead. In the parliament that was called in December, Thurloe was solicited to sit for Tewksbury, in a letter which is worth extracting, as showing his estimation and position at this time, and the spirit of constituencies:—'Noble Sir, We understand that you are pleased so much to honour this poor corporation as to accept of our free and unanimous electing you one of our burgesses in the next parliament, and to sit a member for this place. Sir, we are so sensible of the greatness of the obligation, that we know not by what expressions sufficiently to demonstrate our acknowledgments; only at present we beseech you to accept of this for an earnest, that whomsoever you shall think worthy to be your partner shall have the second election; and our zeal and hearty affections to serve and honour you whilst we are, as we shall ever strive to be, Sir, your most humble and obliged servants,' &c.: signed by the bailiffs and justices of Tewksbury. (*State Papers*, vol. vii., p. 572.) He was not after all chosen for Tewksbury. He was elected for Wisbech, Huntingdon, and the university of Cambridge. His election for the last was communicated to him in a letter from the celebrated Dr. Cudworth, who wrote to him in this strain:—'We being all very glad that there was a person of so much worth and so good a friend to the university and learning as yourself, whom we might be trust with the care of our privileges and concerns.' (*State Papers*, vol. vii., p. 587.) Thurloe made his election to sit for the university of Cambridge.

The meeting of this parliament was the beginning of discontents and of Richard Cromwell's fall. We find Thurloe, in a letter to Henry Cromwell, viewing the complaints of the army and of the opposition in parliament as pointed principally against himself, and stating that he had asked the Protector's permission to retire from his office. 'I trust,' he adds, 'other honest men will have their opportunity, and may do the same thing with myself with better acceptance, having not been engaged in many particulars, as I have, in your father's lifetime, which must be the true reason of these stirrings; for they were all set on foot before his now highness had done or refused one single thing, or had received any advice from any one person whatsoever.' Thurloe remained however secretary of state. It was one of the objects set before themselves by the royalists in this parliament, who, by uniting with the republican party, formed a most troublesome opposition to Richard Cromwell's government, to impeach Thurloe; but this object was yet undeveloped when the parliament was dissolved. Thurloe appears to have given strong counsel against the dissolution.* The immediate consequence of the dissolution was the summoning, by Fleetwood and the council of officers, of the Rump of the Long Parliament, and Richard Cromwell's deposition.

* It is generally stated otherwise, on the authority of the following passage in Whitelocke:—'Richard advised with the Lord Broghill, Fiennes, Thurloe, Wolsey, myself, and some others, whether it were not fit to dissolve the present parliament: most of them were for it; I doubted the success of it' (p. 677). Those mentioned are very few of the council, and, even if there had been no others, it would be quite consistent with the words of this passage that Thurloe should have sided with Whitelocke. That Thurloe strenuously opposed the dissolution is distinctly stated, and with circumstantial mention of the authority, in Calamy's *Life of Howe*, prefixed to *Howe's Works*, p. 9, ed. 1724, fol. We know further that the dissolution was urged on Richard Cromwell by the Republican and Royalist parties, which were united against Thurloe. Whitelocke says, a little afterwards, of the dissolution that it 'caused much trouble in the minds of many honest men; the Cavaliers and Republicans rejoiced at it.' One of the 'many honest men' was doubtless Thurloe. See also Clarendon's *State Papers*, vol. iii., pp. 420, 60.

de was called to the bar, and joined the Western circuit in the ensuing spring.

Thurlow immediately applied himself to the practice of his profession with great assiduity; and although he brought with him an indifferent character from the university, he attained unusually early to reputation and employment both in Westminster Hall and on the circuit. His name appears frequently in the Law Reports soon after he was called to the bar; and his success in the profession he had chosen was clearly ascertained in less than seven years from the commencement of his practice. In 1761 he obtained the rank of king's counsel; and it may perhaps be inferred from an anecdote which is related by his early friend and associate Cowper, in one of his letters (*Cowper's Works*, vol. v., p. 254, Southey's edit.), and which refers to this period, that Thurlow had then acquired a degree of reputation which suggested the prediction that he would eventually rise to the highest office in his profession. A more convincing proof of his position in the law is however recorded in the Reports, from which it appears that immediately after his appointment as king's counsel his practice in the courts rapidly increased, and, during ten years preceding his appointment as solicitor-general, was exceeded only by that of Sir Fletcher Norton, and one or two others of the most eminent advocates of his time. To have succeeded so early and to so great an extent, without adventitious aid from influence or connection, and in competition with advocates of unquestioned ability and learning, is a substantial argument of professional merit. His employment in preparing and arranging the documentary evidence for the trial of the appeal in the House of Lords against the decision of the Court of Session in the Great Douglas Cause (which, according to professional tradition, resulted from mere accident) may have had the effect of bringing his talents, industry, and legal acquirements under the immediate notice of persons of power and influence, and of thus opening the way to his subsequent elevation.

In the new parliament called in 1768 he was returned as member for the borough of Tamworth, and became a constant and useful supporter of Lord North's administration. Upon Dunning's resignation of the office of solicitor-general in March, 1770, and Blackstone's refusal to accept it (*Life of Sir William Blackstone*, prefixed to Blackstone's *Reports*), Thurlow received the appointment, and in January, 1771, he succeeded Sir William De Grey as attorney-general. Soon after his introduction to office, he attracted the particular notice of George III. by the zeal and energy displayed by him in supporting the policy of Lord North's government respecting America, and in which the king is known to have taken the warmest interest. Thurlow's strenuous and steady support of the minister in the great parliamentary contest which ensued respecting that policy, procured for him a degree of confidence and even of personal regard on the part of the king, which continued unabated for upwards of twenty years, and had unquestionably great influence in the remarkable vicissitudes of party which occurred in that period.

In the summer of 1778 lord chancellor Bathurst resigned his office; and on the 2nd of June in that year Thurlow was appointed his successor, and raised to the peerage with the title of Baron Thurlow of Ashfield in the county of Suffolk. Four years afterwards, in March, 1782, when Lord North was removed from power, and the ephemeral Rockingham administration was formed, Thurlow remained in possession of the great seal by the express command of the king, and in spite of Mr. Fox's opposition to his continuance in office; thus furnishing an instance without a parallel in the history of English party, of a lord chancellor retaining office under an administration to all the leading features of whose policy he was resolutely opposed. Nor was he content in this inconsistent association to differ from his colleagues in opinion only; on the contrary, he took no pains to conceal his hostility to their principles, and even opposed in the House of Lords with all his characteristic energy the measures which they unanimously supported. Thus, after the bill for preventing government contractors from sitting in the House of Commons had been introduced into the House of Lords, where it was supported by Lord Shelburne and all the ministers in that house, the lord chancellor left the woolsack, and himself moved that 'the bill be not committed,' denouncing the measure as 'an attempt to deceive and betray the people,' and designating it 'a jumble of con-

P. C., No. 1540.

tradictions.' (*Hansard's Parl. Hist.*, vol. xxii., pp. 1356-1379.) The inconvenience produced by this embarrassing disunion of councils was deeply felt, and was one of the principal reasons for Mr. Fox's retirement from administration on the death of the marquis of Rockingham; and when the administration was dissolved in February, 1783, upon the coalition formed between Lord North and Mr. Fox, Lord Thurlow was compelled to retire from office, notwithstanding the exertions of the king to retain him. But though no longer chancellor, he still continued to be one of those who were described by Junius as 'the king's friends,' and was supposed to have been his secret and confidential adviser during the short reign of the Coalition ministry. Upon the dissolution of that ministry at the end of the same year in which it was formed, the great seal was restored to Lord Thurlow by Mr. Pitt, who then became prime minister. He continued to hold the office of lord chancellor for nine years after his reappointment; and until the occurrence of the king's madness in 1788, appeared to act cordially with the rest of the cabinet; but when that event rendered a change of councils by means of a regency probable, he was suspected, with good reason, of some intriguing communications with the Prince of Wales and the Whigs (*Moore's Life of Sheridan*, vol. ii., chap. xiii.), and was always subsequently regarded with distrust by Mr. Pitt and his colleagues. On the other hand, Lord Thurlow took no pains to conceal his dislike of Mr. Pitt; and that minister felt himself so embarrassed by the chancellor's personal hostility to him, that in 1789 he complained to the king, who immediately wrote to Thurlow upon the subject, and obtained from him a satisfactory answer. His angry feeling however still continued, until at length, in 1792, probably relying upon his personal influence with the king, he ventured to adopt a similar course to that which he had followed in very different circumstances under the Rockingham administration, and actually opposed several measures brought into parliament by the government. In particular he violently opposed Mr. Pitt's favourite scheme for continuing the Sinking Fund, and voted against it in the House of Lords, though he had never expressed his dissent from the measure in the cabinet. This kind of opposition, though submitted to from necessity by a weak government like that of the marquis of Rockingham, could not be endured by so powerful a minister as Mr. Pitt; and on the next day he informed the king that either the lord chancellor or himself must retire from the administration. The king, without any struggle or even apparent reluctance, at once consented to the removal of Lord Thurlow, who was acquainted by command of his majesty that he must resign the great seal upon the prorogation of parliament. Lord Thurlow is said to have been deeply mortified by this conduct on the part of the king; and he is related to have declared in conversation that 'no man had a right to treat another as the king had treated him.' Subsequently to his notice of dismissal, and before he quitted office, his ill humour was displayed by his opposition to another measure prepared and supported by Mr. Pitt, the object of which was the encouragement of the growth of timber in the New Forest. On this occasion he reflected severely upon those who had advised the king upon this measure, and went so far as to say that his majesty had been imposed upon. (*Tomline's Life of Pitt*, vol. iii., p. 398-9.) One of his latest acts as lord chancellor was to sign a protest in the House of Lords against Mr. Fox's Libel Act. The opportunity of his retirement from office was taken to grant him a new patent, by which he was created Baron Thurlow, of Thurlow, in the county of Suffolk, with remainder, failing his male issue, to his three nephews, one of whom afterwards succeeded to the title under this limitation.

After his retirement from office in 1792, Lord Thurlow ceased to take any leading part in politics, and having little personal influence with any party, became insignificant as a public character. He occasionally spoke in the House of Lords on the subjects of interest which were discussed at the period of the French revolution; and it is worthy of remark that he frequently opposed the measures adopted by the Tory government at that time for the suppression of popular disturbances. Instances of this occur with respect to the Treasonable Practices Bill and the Seditious Meetings Bill, in 1795; and a comparison of the sentiments expressed by him on these occasions, with his

speeches respecting America during Lord North's administration, affords a striking example of political inconsistency. A circumstance is recorded in the 'Memoirs of Sir Samuel Romilly' (vol. ii., p. 124), which proves that till within a few months of his death Lord Thurlow was still confidentially consulted by members of the royal family. On occasion of the first communication of the charges made by Lady Douglas against the princess of Wales in 1805, the prince (afterwards George IV.) directed that Thurlow should be consulted, and the particulars of the interview between him and Sir Samuel Romilly are characteristic and interesting.

Lord Thurlow died at Brighton, on the 12th of September, 1826, after an illness of two years.

THURMER, JOSEPH, a German architect of some note, was born at Munich, November 3, 1789, but did not begin to apply himself to architecture professionally until 1817, when he became a pupil of Professor Fischer's, and had for his fellow-students Gärtner, Ziebland, Öhlmüller [ÖHLMÜLLER], and many others who have since rendered themselves more or less distinguished. At the end of the following year (after a previous visit to Rome at the commencement of it) he joined Hübsch, Heger (died 1837), and Koch, in a professional excursion to Greece, where he spent five months in studying and drawing the remains of buildings at Athens, some few of which he published on his return, with the title of 'Ansichten von Athen und seine Denkmaler,' 1823-6. He did not however confine himself to the study of the Grecian style, nor was he such a prejudiced admirer of it as to have no relish for any other; on the contrary, he considered the Italian style of the time of Leo X. to be equally worthy of the architect's attention, and to deserve to be far better, more faithfully and tastefully, represented by means of engravings than it previously had been. He accordingly joined with Guttensohn in bringing out a 'Sammlung von Denkmaler,' &c., 'Collection of Architectural Studies, and Decorations from Buildings at Rome, of the fifteenth and sixteenth centuries,' the first number of which appeared in 1826; but, unfortunately, it did not meet with the encouragement it deserved, and was therefore given up, when very little progress had been made with it. The publication however was so far advantageous to Thurmer, since it recommended him to notice, and led to his receiving (1827) at the same time two different invitations, one from Frankfort, the other from Dresden, to which last he gave the preference. He was there made professor-extraordinary at the school of architecture, and in 1832 was promoted to be first professor of architecture, in which capacity he did very much for the advancement of the art and the improvement of taste. Though he has left very little executed by himself in that city, the only public building in it entirely by him being the post-office (for though the 'Hauptwache,' or guard-house, was erected by him, it was after Schinkel's designs), his opinions had a very beneficial influence. That he should have had so few opportunities for displaying his ability, is not very surprising, nor does it detract from his reputation, since he did not long survive the completion of his first edifice: he died November 13th, 1833, while staying at Munich. What he might have done, had a longer life been granted him, is shown by the number of designs he left, all more or less stamped by originality and artistical feeling. That the grateful regard expressed for his memory and his talents by his friends and pupils was not a mere temporary effusion, is proved by their having erected a bronze bust and monument to him, in 1838, at the Academy of Arts.

(*Convers. Lex. der Neuesten Zeit: Morgenblatt*, 1838.)

THURNEYSSER ZUM THURN, LEONARD, a celebrated alchemist and astrologer, was born in 1530 at Basle, where his father carried on the trade of a goldsmith. He was himself brought up to this employment, but he was obliged to leave his native place when eighteen years of age, on account of having sold to a Jew a piece of gilt lead for pure gold. He first went to England, thence to France, and afterwards to Germany, where he enlisted among the troops of the margrave of Brandenburg. The following year he was taken prisoner; from that time he gave up a military life, and having visited the mines and foundries of Germany and the north of Europe, he came back in 1551 to Nürnberg, Strassburg, and Kostnitz. Here he again carried on the trade of a goldsmith, and made much money

by it, till, on account of his reputation for skill in the art of mining, he was sent for to the Tyrol to superintend different mineral works. Accordingly in 1558 he went to Tarenz in Upper Innthal, and established on his own account in that place, as well as at St. Leonard, foundries for the purifying of sulphur, the success of which contributed still more to his celebrity. The Archduke Ferdinand had so much confidence in him that he sent him to travel in Scotland, the Orkney Islands, Spain, and Portugal. Thurneysser also visited the coasts of Barbary, Ethiopia, Egypt, Arabia, Syria, and Palestine, and returned to the Tyrol in 1567. Two years afterwards, at the request of the same prince, he again visited the mines of Hungary and Bohemia. The publication of his works made him determine to go to Münster and Frankfort on the Oder, at which latter place he became acquainted with the elector of Brandenburg, whose wife he cured of a dangerous illness, and who resolved to attach him to his service in the hope that he might discover in his estates some unknown mineral treasures. Thurneysser accepted the office of physician to the prince, and accompanied him to Berlin, where, from his skill in profiting by the prejudices and weaknesses of his contemporaries, and from being acquainted with all the resources of charlatanism, he soon succeeded not only in acquiring considerable wealth, but also in passing himself off for one of the most learned and scientific men of his age. At length however, by the envy of others, and still more by his own imprudence, his deceptions were discovered, and he was, in 1584, obliged to leave Berlin. He went to Prague, Cologne, and Rome; and after having thus led a wandering life for some years, he died at last in a convent at Cologne, at the age of sixty-six, in 1596. He was an advocate for the pretended sciences of alchemy and uromancy, and his whole history like that of most similar characters) is a proof of the influence that may be acquired in an ignorant age by a bold and enterprising man, when he possesses some little information above the generality of his contemporaries. His writings were numerous, but of little worth, and they are now very seldom looked into. The titles of twelve of them are given in the *Biographie Médicale*, from which see the preceding account is taken.

THUROTZ, or THUROCOZ, is a small county in Hungary, in the circle on this side the Danube. It is bounded on the north by Arva, on the east by Leptan and Sob, on the south by Bars, and on the west by Neitra and Trencsen. Its area is 445 square miles, and the population 42000 inhabitants, chiefly Slovacs, of whom about two-thirds are Lutherans and one-third Roman Catholics, except about 500 Jews. 'This country is justly called a beautiful garden' (says the anonymous author of the description of Hungary, Croatia, and Slavonia), for it is surrounded on all sides with lofty mountains, as with walls, within which nature has been lavish of the most beautiful scenery. This garden has only two entrances in the northern part, through which the river Waag enters and leaves the country. The first entrance is between the two mountain-chains called the Great and the Little Fatra, and the other near Sztrečno. The Great Fatra has two summits, the Stock, 4876 feet high, and the Thurocz Krivan, 5300 feet high. The climate is cold, but healthy. Though the soil is fertile, there is no superfluity of natural productions: it produces no wine, but nearly sufficient corn (chiefly buckwheat) for the consumption of the inhabitants; and so much barley and oats, that some portion can be exported. Pulse of different kinds abounds, especially large and excellent peas. Potatoes are extensively cultivated, and also a species of turnip peculiar to this country. The inhabitants collect a considerable quantity of a balsam from the mountain-pines, which is sold to the common people and extolled as possessing great medicinal virtues; it is exported to Germany, and even to America. There are numerous flocks of sheep on the mountains and numerous valleys. Of 158,820 acres of land only 62,442 acres are arable, and 83,756 acres are covered with forests. The chief town is St. Matyas. The Thurocz, which has about 2000 inhabitants, is a handsome county-hall, and five large churches. (Hassel, *Geography*; *Blumenbach's reschische Monarchie*.)

THURROCK. [ESSEX.]

THURSDAY. [WEEK.]

THURSO. [CAITHNESS.]

[BOSWELLIA.]
TEIRA. [INDIA.]
ACINUS. [MARSUPIALIA, vol. xiv., p. 455.]
ACOTHERIUM. [MARSUPIALIA, vol. xiv.,

[E. [THYMUS.]
ELACEÆ, a natural order of plants belonging to a biforous group of Incomplete Exogens. The name is derived from Thymelæa, a plant spoken of by Pliny, and which some have supposed to be the Sida, a plant belonging to the present order. The order consists of shrubs or small trees, very rarely herbaceous, with very rarely articulated, sometimes spiny branches, very tenacious bark. The leaves are entire, simple, ovate, and alternate or opposite. The flowers are axillary, terminal or axillary, occasionally solitary. The ovary is tubular, coloured, 4-cleft with an imbricate calyx; the stamens 2-4 or 8 in number, inserted into the tube of the ovary with 2-celled anthers, dehiscing lengthwise in the tube of the ovary is solitary, with a solitary pendulous ovule. The fruit is hard and dry, or drupaceous; the seed is without albumen, a straight embryo, with a short and entire cotyledon. This order is related to the Euphorbiaceæ, from which it differs in its inferior calyx. It is related to Elæagnaceæ and Proteaceæ, from both of which it is distinguished by its pendulous ovules. Lindley has placed this order Bartling's Anthoboleæ, on account of the inferior fruit. [EXOCARPUS.] The species are numerous in Europe, but are not common; they occur in abundance in the cooler parts of India and Africa, at the Cape of Good Hope, and in New

Zealand. The most prominent property of this order is their causticity, which resides in their bark. When applied to the skin it produces vesication, and pain in the mouth when

applied to the mouth. The bark of several of the species is very tough, and may be manufactured into cordage. Passerina tinctoria is a dye which is used in the south of Europe to dye wool yellow. The various species of Daphne possess various properties; some are used for dyeing, some are used for medicinal purposes, and the Daphne Lagetta is the Lace-bark-tree of the East. [DAPHNE.]

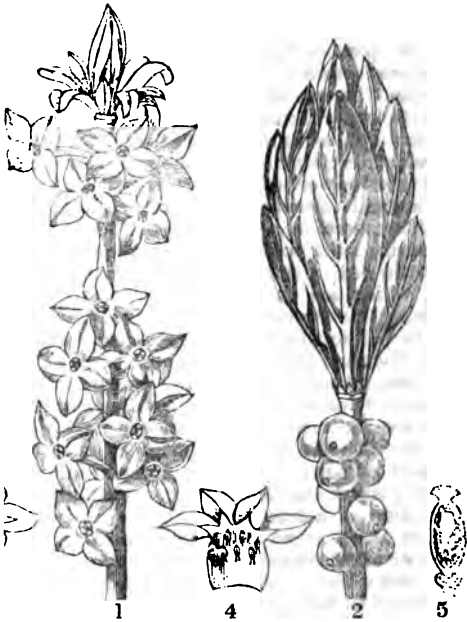

Daphne Mezereum.

1, with flowers; 2, ditto with fruit; 3, single flower; 4, calyx showing the insertion of the stamens; 5, section of ovary, showing the two ovules.

THYMUS (*θύμος*), the name of a genus of plants belonging to the natural order Lamiaceæ or Labiatae. It has a bilabiate calyx with thirteen ribs; the upper lip is bifid, the lower lip is bifid with ciliated subulate lobes, and throat villous inside; the corolla with the lobes erect, nearly plane, notched, lower patent and upper concave; anthers straight, exserted; styles divergent at apex. All the species are small under-shrubs

with usually purplish flowers. Between twenty and thirty species have been described by botanists, most of them inhabitants of Europe, especially the region of the Mediterranean: one only is a native of the British Isles.

T. vulgaris, Common or Garden Thyme, is an erect plant, or sometimes procumbent at the base, or clothed with a hoary pubescence; the leaves are sessile, linear, or ovate-lanceolate, acute, with revolute edges, fasciated in the axils; the teeth of the upper lip of the calyx are lanceolate, but the segments of the lower lip are subulate and ciliated. This plant is a native of the south-west parts of Europe, in dry plains and on hills, and uncultivated places free from woods. The plant is very much branched, and has purplish flowers. This species is cultivated for culinary purposes, and many varieties of it are met with in gardens. It has a pungent aromatic odour and taste. These properties are communicated to water by infusion only to a slight extent. They depend upon an essential oil, an ounce of which may be obtained from thirty pounds of the plant.

T. serpyllum, Wild Thyme, or Mother-of-Thyme, is a suffruticose plant, with capitate flowers, branched decumbent stems, with plain, ovate, obtuse, entire, petiolate leaves, more or less ciliated at the base. It is a native of Great Britain, on hills and in dry pastures, and throughout Europe and the north of Asia. This plant has the same sensible properties as the last, but is more inclined to produce varieties, several of which have been described as species. These vary principally in the colour of the flowers and the size of the leaves and plant. One of the varieties, *T. s. citratus*, is known by the name of Lemon-Thyme on account of its scent resembling the lemon. The seeds will not however maintain this property: if required to be preserved, the plants must be propagated by means of slips or cuttings.

Both this and the former species, when cultivated, are best raised by means of seeds, although they may be easily propagated by parting the roots or planting slips and cuttings. The seed may be sown in March or April, in a light fine soil, and when the plants are two or three inches high, they should be transplanted. Roots or slips should be planted in the autumn. The plants produce abundance of seeds in the summer and autumn, which, when gathered, should be rubbed out, and preserved for planting in the following spring.

These plants are not so much used in medicine as for culinary purposes. The volatile oil is frequently used as an application to carious teeth. Linnæus recommends them as a remedy for dissipating the effects of intoxicating liquors, and a decoction is used in France as an application for the itch.

T. mastichina, Mastich-Thyme, or Herb-Mastich, has ovate or oblong, obtuse, petiolate leaves, narrowed at the base and not ciliated; the calyx is villous, with feathery subulate teeth, which are longer than the tube. It is a native of dry, sandy, uncultivated places in Spain, Portugal, and Barbary. It exhales a scent resembling mastich. It is the *Marum vulgare* of older botanists, and at one time had some reputation as an emmenagogue. Several other species of thyme are cultivated; they do not require much care; the more delicate and rarer kinds are found amongst collections of alpine plants.

THYMUS GLAND, which in the calf and lamb is called the sweetbread, is an organ situated behind the sternum, in the anterior mediastinum, in front of the pericardium and the large vessels arising from the base of the heart. In the embryo and the infant it has, in proportion to the rest of the body, a very considerable size; in after-life it becomes comparatively smaller, and at last nearly disappears. It is of an elongated form, its greatest dimension being from above downwards, and is composed of two chief portions, which, by careful dissection, may be separated in the middle line. At each end it bears two processes or horns, of which the upper are longer and more slender than the lower, and the right are usually longer than the left. It is supplied by several branches from the internal mammary, inferior thyroid, and mediastinal arteries, to which veins of considerable size correspond. Its absorbent vessels are numerous and large, but not more so than in other glands of equal vascularity.

The thymus gland is composed of a great number of similar small masses or lobules, which may be separated

by dissection, and are held together by fine cellular tissue continued from that which invests the whole gland. The lobules vary in size from half a line to three lines in diameter, and have simple or complex cavities filled with a milky fluid. Sir Astley Cooper (*The Anatomy of the Thymus Gland*), says that the lobules are arranged in spiral lines, so that the gland may be unravelled into a sort of knotted rope of lobules, which are wound around a central cavity or reservoir, with which the cavities of the lobules communicate. But the existence of such a central cavity is not generally admitted.

The fluid contained in the cells of the thymus gland is, in young and healthy animals, opaque and creamy. It has been particularly examined by Mr. Gulliver (Appendix to Gerber's *General Anatomy*), who has found that both in its chemical composition, and in the abundance and structure of the globules which it contains, it closely resembles the fluid of the lymphatic glands.

Of the function of the thymus gland scarcely anything probable is known. Whatever it be, it is performed most actively during foetal life and the first year of extra-uterine life: for during this time the thymus gland grows at the same rate as the rest of the body, its cells are full of fluid, and the fluid is thick and abundant in globules. From the end of the first to the end of the third year its size does not materially vary; but after this time it gradually diminishes, and after the twelfth or fourteenth year it is rare to meet with more than a slight trace of it. It is also of considerable size and is full of fluid in hibernating animals: and this, together with its activity during foetal life, has suggested that its office is in some way connected with the preparation of the blood, when respiration is either inactive or has not commenced. But, in these same circumstances, digestion is not going on, and it is therefore just as probable that the thymus gland may have the office of preparing a fluid and globules, like those of the chyle, from the materials which have served for the nutrition of the body and have been re-absorbed; in other words, that its function is analogous to that of the lymphatic glands. This was the opinion of Hewson (*Experimental Enquiries*); it is supported by the observations of Mr. Gulliver and many others, and is on the whole more probable than any other yet advanced.

The thymus gland is rarely diseased. The only affections of it yet described are an unnatural enlargement of it, and its persistence in the dimensions which it has in foetal life. When it is enlarged there is generally a more than usual development of all the lymphatic glands; and not unfrequently there are at the same time signs of serious general disorder of the health, such as rickets, hydrocephalus, &c. It has been supposed, especially by the German pathologists, that a peculiar affection of the respiration, which has been called Thymic Asthma, is the general result of enlargement of this gland; but the connection of the two affections is not yet clearly established.

THYONE. [HOLOTHURIA, vol. xii., p. 269.]

THYROID GLAND is an organ situated in the middle and fore part of the neck, in front and by the sides of the thyroid cartilage of the larynx (from which it has its name), and of the cricoid cartilage and the upper part of the trachea [LARYNX], to which it is closely fixed by cellular tissue. It is composed of two chief lateral portions or lobes, and a smaller portion or isthmus connecting them. A fourth portion, which is long and slender, and is named the middle column or horn, usually passes upwards from the isthmus in front of the larynx. The lateral lobes are of a somewhat pyramidal form, about two inches long, and an inch wide at their bases. The whole gland is proportionally larger in the embryo than in the adult, and in women than in men.

The substance of the thyroid gland is firm, fleshy, and very vascular. It receives a copious supply of blood from two superior and two inferior thyroid arteries; the former are branches of the external carotid, the latter of the subclavian arteries; their branches communicate freely in the gland, and they are accompanied by veins and lymphatics of corresponding size. The interior of the gland contains numerous very minute cells, lined by polished membranes, and in young persons filled by a clear albuminous fluid, in which, or in the walls of the cells, there are numerous granular corpuscles.

Of the function of the thyroid gland no more is known than of those of the spleen and thymus gland, between

which it seems, in structure, to hold an intermediate place: resembling the spleen in its vascularity, far greater than is required for its nutrition, and the existence of cells containing a fluid, and in development during early life. What has been said of its probable functions might be repeated here.

The thyroid gland is subject to several changes of structure, most of which, being attended with enlargement, are comprehended in the name of bronchocele [BRONCHOCELE], to which the reader is referred. In some cases the cells of the gland are enlarged, and its structure which in health is with difficulty discernible, may be easily demonstrated.

THYRSANOPODA. [STOMAPODS, vol. XIII., p.

TIARA: *τιάρα* or *τιράρα*, a high kind of hat, worn in ancient times worn by the inhabitants of the East, especially by the Persians, Parthians, Armenians, and Phrygians. There were two kinds: the upright tiara was only used by kings, priests, and persons of the highest rank, and the upper part frequently the shape of a crown; the tiara worn by the people was of a soft and flexible material, so that it could be drawn down on one side, as in the case of the so-called *gigean bonnet*. Hesychius and Suidas, s. r. *τιάρα*. The tiaras of persons of high rank were of the most precious colours, such as purple, and adorned with gold and precious stones. (Ovid, *Metamorph.*, xi. 161; Flaccus, vi. 699; compare *Dictionary of Greek and Latin Antiquities*, under 'Tiara.')

In modern times the term tiara is applied to the dress of the popes, which is worn on solemn occasions and consists of a triple crown. Hence it is also used in a figurative sense to designate the papal dignity.

TIARA, Mr. Swainson's name for a genus of shells of his term for the subfamily of testaceous mollusks, the shells of which are termed 'Mitres' by collectors. [TIARA.] N.B. This generic name comes too near

TIARINI, ALESSANDRO, one of the most celebrated painters of the Bolognese school, was born at Bologna in 1577. He first studied under Prospero Fontana. Fontana's death in 1597, under Bartolomeo Passignano, having in a quarrel discharged a pistol or similar weapon at a fellow-scholar, without however doing him any harm, he was obliged to fly from Bologna. He went to Mantua and there engaged himself with a portrait-painter, whom he painted hands and draperies, and whose performances having attracted the notice of Don Passignano, he was admitted by that painter into the studio as a scholar. Tiarini remained with Passignano for several years, and by that time acquired so great a reputation that he received invitations from Bologna to return to his native city. In Bologna his works excited universal admiration for their invention and earnestness of character, and for the correctness of foreshortening, correctness of design, and delicacy of colouring: the tone of Tiarini's pictures was not used little red, and avoided gay colours generally. His works, which are very numerous, consist chiefly of religious paintings; he executed comparatively little in those in public places alone, in Bologna and its environs, and in Mantua, Modena, Reggio, Parma, Cremona, Pavia, amount to upwards of two hundred: their character is generally of a melancholy or serious nature. His most celebrated are the most celebrated:—A Miracle of San Domenico, in the Capella del Rosario, in the church of the same name at Bologna, painted in competition with Spada, in which the saint restores a dead child to life; the exhumation of a dead monk, in the convent of the same name in Bosco; and St. Peter repenting his sin, standing outside the door of the house of a priest, with the Mocking of Christ in the background, illuminated by torchlight.

Ludovico Carracci, whose style Tiarini ultimately adopted, was a great admirer of his works: when he first saw Tiarini's picture of the Miracle of San Domenico, he is reported to have exclaimed that he knew no living painter that could be compared with Tiarini. Many of his pictures, out of Bologna, have been attributed to other of the Carracci: such was the case with the celebrated Deposition from the Cross, now in the Gallery of the Academy of Bologna, formerly in the church of the college of Montalto: it is engraved in the work of the *Pinacoteca della Ponteficia Accademia delle Belle Arti in Bologna*.

al of Tiarini's pictures have lost their colour, owing to the practice of glazing; in some the colouring consists of glazed tints, the design being executed in grey. He founded a life academy in Bologna, and had many pupils. Malvasia has preserved the name of a famous pupil that he used frequently to engage, Valstrago. Tiarini died in 1668, aged ninety-one.

Asia, Felsina Pittrice; Lanzi, Storia Pittorica,

TIS, *Crestlet*, Mr. Swainson's name for a genus of *LINÆ.*, placed by him in the subfamily *Cocconæ*, between *Amudina* and its subgenera and is.

ic Character.—Bill perfectly conic, entire; compressed, and consequently angulated. Nostrils naked, round. Wings moderate; first quill rather than the second, third, and fourth, which are equal rest. Tail even or slightly rounded. Feet moderate. Middle toe and tarsus of equal length; lateral toes under toe much shorter than the tarsus. Claws fully curved. Head crested. *Locality*, South only.

Example, *Tiaris ornatus*. Pl. Col., 208 (*Classification*).

Mr. R. Gray arranges this genus in the subfamily *inaæ*, between *Pytelia*, Sw., and *Carduelis* (Antiq.), *List of the Genera of Birds.*

LEO. [TEBALDEO.]

LEO, PELLEGRINO, otherwise called Pellegrino, or sometimes Pellegrino da Bologna, distinguished himself both in painting and in architecture. He was born in 1527, at Bologna, where his father, who originated from Valsolda in the Milanese territory, was a common mason. How, so circumstanced, the father managed to bring up his son to a profession requiring beyond those of his own condition in life, does not appear. He neither is it known from whom Tibaldi received instruction in painting. In 1547 he visited Rome, with the intention, it is said, of studying under Pierino del Verrocchio, as the latter died in that same year, he could have received any lessons from him. Whether he was a pupil of Michael Agnolo is unknown: he executed his works very successfully, for while he was free from the grandeur of style and energy of forms, tempered their severity by the freedom and gracefulness, that he afterwards acquired from the Carracci name of 'Michelagnolo Riformato,' and may be considered as the originator of that style which they perpetuated. We must, however, conclude that although he was employed there in the church of S. Lodovico di Frandini, he did not display any great ability with his pen. His residence at Rome, it being related of him that he felt so discouraged as to have determined to starve to death, from which desperate resolution he was saved only by Ottaviano Mascherino, who advised him to turn to painting and devote himself entirely to architecture for which he had shown considerable taste. In all this anecdote has been strangely exaggerated, we are informed how he set about putting Mascherino's advice into practice. That he partly adopted it, is certainly, fully certain that if he renounced painting for architecture he returned to it: in fact, not very long after the advice just spoken of, he was sent to Bologna by Cardinal Poggi to adorn his palace (afterwards occupied by Cardinal de' Medici), where he painted the history of the Poggia. For the same prelate he also painted the Poggia which had been erected after Tibaldi's own design, and it was those productions which excited the admiration of the Carracci. He was next employed at Lodi, Ancona, where he executed several works in fresco, among them those with which he adorned the Sala de' Cavalieri, or Exchange, in the last-mentioned city. His reputation as an architect in the meanwhile increased, and he being employed to design, if not to execute, several buildings at Bologna, and the Palazzo della Sapienza, at Pavia (which last was begun by Cardinal Borromeo in 1564), he restored the Archiepiscopal Palace at Milan, and was appointed chief architect of the Duomo, or cathedral, in that city (1570). He executed the idea or first design of the modern façade of the cathedral to that celebrated Gothic structure,—a design which obtained him both praise and censure in almost every degree. Among other buildings by him at Milan

are the church of San Lorenzo, that of S. Fedele, and that of the Jesuits. But the work which, if less celebrated than some of his others, is considered by one of his critics his chef-d'œuvre, and a masterpiece for the contrivance and ability shown in it, is the 'Casa Professa,' or that of the Jesuits at Genoa, with its church, &c., where he completely mastered all the difficulties arising from the inconvenience of the site. Neither his fame nor his works were confined to Italy, for the former caused him to be invited to Spain in 1586, by Philip II., where he was employed both in his capacity of architect and in that of painter, in which last he executed many admirable frescoes in the Escorial. Liberally rewarded by Philip, who also conferred on him the title of Marquis of Valsolda (his birth-place), Tibaldi returned to Italy after passing about nine years in Spain, and died at Milan in 1598; such at least is the date assigned by Tiraboschi, though some make it much earlier, 1590 or 1591, and others about as much later, viz. 1606.

(Tiraboschi; Lanzi; Milizia; Nagler.)

TIBALDI, DOMENICO, younger brother, not son of the preceding, as he is sometimes called, was born in 1541, and was, if not equally celebrated, like him both a painter and architect, but ranks far higher in the latter than in the other character. He executed many buildings at Bologna, the principal among which are the Palazzo Magnani, the Dogana, or custom-house, the chapel in the cathedral, so greatly admired by Clement VIII. as being superior to anything of the kind at Rome, and the small church of the Madonna del Borgo. Domenico also practised engraving with success, and in that branch of art was the instructor of Agostino Carracci. He died at Bologna in 1583.

(Milizia; Nagler.)

TIBBOOS. [SAHARA.]

TIBER. [PAPAL STATE.]

TIBERIAS. [PALESTINE; SYRIA.]

TIBERIUS CLAUDIUS NERO was born in Rome, on the 16th November, 42 B.C., according to Suetonius. He belonged to the gens Claudia, an old patrician family of great distinction, which was known for its aristocratical pride. Tiberius belonged to this house by the side of his father, Tiberius Claudius Nero, as well as his mother, Livia Drusilla, who was the niece of her husband, being the daughter of Appius Pulcher. This Appius Pulcher was a brother of Tiberius Claudius Nero the elder, and they were both sons of Appius Cæcilius. His father was quaestor to C. Julius Cæsar, and distinguished himself as commander of the fleet in the Alexandrian war. He became successively prætor and pontifex, and in the civil troubles during the triumvirate he followed the party of M. Antonius. Being compelled by Octavianus to fly from Rome, he escaped by sea, and hastened to M. Antonius, who was then in Greece. His wife and his infant son accompanied him in his flight, and they happily escaped. Tiberius the elder soon made his peace with Octavianus; he gave up to him his wife, Livia Drusilla, who was then pregnant with Nero Claudius Drusus, and he died shortly afterwards (38 B.C.). Thus Tiberius the younger and his brother Nero Claudius Drusus became step-sons of Octavianus, who from the year 27 B.C. was Augustus.

The great talents of Tiberius were developed at a very early age. In his ninth year he delivered a public speech in honour of his father; in 29 B.C. he accompanied Octavianus in his triumph after the battle of Actium, and rode on his left side, Marcellus being on the right. After having assumed the toga virilis, he distinguished himself by splendid entertainments which he gave to the people. He married Vipsania Agrippina, the daughter of Agrippa, and the granddaughter of Cicero's friend T. Pomponius Atticus. She brought him a son, Drusus, and she was again with child when Tiberius was obliged to sacrifice her to the policy of Augustus, who compelled him to marry his daughter Julia, the widow of Marcellus and of Agrippa, and the mother of Caius and Lucius Cæsar. (12 B.C.) Tiberius obeyed reluctantly, but he never ceased to love Vipsania. Such was his affection for her, that whenever he saw his repudiated wife he would follow her with tears; and accordingly an order was given that Agrippina should never appear in sight of Tiberius. For some time Tiberius lived in harmony with Julia, and had a son by her, who died young. But the scandalous conduct of Julia soon disgusted him, and he withdrew from all intimate intercourse with her.

During this time Tiberius took an active part in public affairs. He defended the interests of king Archelaus (of Judæa, or of Cappadocia), of the Tralliani, and of the Thessalians: he was active in obtaining relief for the inhabitants of Laodicea, of Thyatira, and of Chios, who, having suffered from an earthquake, had implored the assistance of the senate; he pleaded against Fannius Cæpio, who had conspired against Augustus, and who was condemned for high treason; and he was twice intrusted with the 'cura annonæ.' Tiberius made his first campaign as Tribune militum in the Cantabrian war. From Spain he went to Asia Minor, and succeeded in restoring Tigranes to the throne of Armenia, and in forcing the Parthians to surrender the eagles which they had taken from M. Crassus. He returned to Rome in 18 B.C. During a year he had the command in Gallia Comata, the peace of which province was troubled by disputes between the princes and by incursions of the barbarians.

In 15 B.C. he and his brother Drusus brought the Alpine nations of Rhaetia to obedience. He also put an end to the war in Pannonia, which had lasted since 18 B.C., and which he terminated by subduing the Breuci, the Scordisci, and the Dalmatae, who were allied with the Pannonians. (14 B.C.) The Germani having defeated M. Lollius and taken the eagle of the fifth legion in 16 B.C. (Velleius Paterculus, ii. 97), Drusus was sent to the Rhine, and Tiberius returned to Rome, where he celebrated his first triumph. In the Rhaetian war Tiberius had shown great military skill, but the Romans carried on the war with unheard of cruelties against the inhabitants, of whom the majority were killed or carried off as slaves. In memory of his victories, a monument was erected at Torba (now Monaco) in the neighbourhood of Nizza, on which the names of forty-five Rhaetian tribes were inscribed. (Plinius, *Hist. Nat.*, iii. 24.) In 13 B.C. Tiberius was appointed consul, together with P. Quintilius Varus. Meanwhile Drusus carried on the war in Germany with great success; but in 9 B.C., on his retreat from the banks of the Elbe to the Rhine, he had a fall from his horse, which proved fatal. Tiberius was then at Pavia, but as soon as he was informed of this accident, he hastened to Germany, and arrived in the camp of his brother, near the Yssel and the Rhine, just before he died.

Tiberius led the army to Mainz (Moguntiacum). He ordered the body of his brother to be carried to Rome, and he accompanied it on foot. After discharging this pious duty, he returned to Germany. In the new war with the Germani, Tiberius at first defeated them, and transplanted 40,000 Sigambri from the right bank of the lower Rhine to the left bank; but he afterwards employed peaceable measures, and by negotiation he obtained more influence over them than his brother Drusus by all his victories. (Velleius Paterculus, ii. 97; Tacitus, *Annal.*, ii. 26.) He left the command in Germany in 7 B.C., and returned to Rome, where he celebrated his second triumph, and he was consul for the second time in the same year.

Tiberius was now at the height of his fame; and he was respected by the army, and admired by the people; and he enjoyed the confidence of the emperor. He nevertheless suddenly abandoned his important functions, left Rome, and, without communicating his motives to anybody, retired to the island of Rhodes. So firm was his resolution to retire from public affairs, that he refused to take any nourishment for four days, in order to show his mother that her prayers and tears could not keep him any longer in Rome. (Suetonius, *Tiberius*, c. 10.) During eight years he led a private life at Rhodes, renouncing all honours, and living in the Greek style, and on terms of equality with those around him, with whom he kept up a friendly intercourse, especially Greek philosophers and poets. The Romans were surprised to see the step-son of their emperor retire to a distant island; and various hypotheses were raised to explain the motive of his voluntary exile. The disgusting conduct of his wife Julia was supposed to be a sufficient cause for this extraordinary resolution; but Tiberius himself afterwards avowed that he had renounced public business in order to escape all charges of having formed ambitious schemes against his step-sons, Caius and Lucius Cæsar, who were created 'principes juventutis,' and appointed successors of Augustus in the very year in which Tiberius went to Rhodes. It seems that he was dissatisfied with the elevation of these two young men, and that there was discord between

him and them; for when he afterwards wished to go to Rome, Augustus would not allow it until he had consented, and it was also on condition that he should take no part in the government of the state. From this we may conclude that Tiberius and his motives had perhaps been intriguing to exclude Caius and Lucius Cæsar from the succession, and that he preferred a voluntary exile to a compulsory banishment, such as inflicted by Augustus upon his own daughter Julia. This is mere supposition, and there are no facts on which a direct accusation against Tiberius can be sustained. regard to his banished wife Julia, Tiberius acted with great delicacy, notwithstanding her conduct, and he sought Augustus to leave her all those presents which had formerly been given to her. (Suetonius, *Tiberius*, c. 13.) At last Tiberius returned to Rome (A.D. 2), and was received by the people with demonstrations of joy. In the same year Lucius Cæsar died (Marseille), and his death was followed by his brother, who died in 4 A.D., in consequence of a fever which he had received in the Parthian war. Augustus then adopted Tiberius as his future successor, 4 A.D., and Tiberius in his turn was compelled by Augustus to adopt Drusus Germanicus, the son of his brother Drusus Nero. Augustus also adopted M. the posthumous son of Agrippa and Julia, but he designated him as a successor in the empire. The throne was thus secured to the house of the Claudii. The same year (4 A.D.) Tiberius was appointed consul and chief in Germany, and he was accompanied by Velleius Paterculus, who was præfectus equitum having subdued the Bructeri, and renewed his alliance with the Chatti, Tiberius in 5 A.D. made a campaign against the Longobards; who were defeated. In the whole north-west of Germany to acknowledge his authority. In the following year (6 A.D.) he sent 70,000 foot and 4000 horse against Marobod of the Marcomanni, who was saved from ruin by the intervention of the inhabitants of Pannonia and northern Italy, who intercepted the communications of the Romans with Italy. Tiberius employed fifteen legions and a number of auxiliaries against these nations. In the face of difficulties of every description, he quelled the rebellions within three years. This war was especially dangerous because the Germani threatened to join the Pannonians, but Tiberius prevented their junction by his operations and by the success of his arms. After celebrating his third triumph, he was again accompanied by Germanicus, who had slain Varus and his army, Tiberius, who was accompanied by Germanicus, succeeded in preventing the Germani from invading the countries on the left bank of the Rhine, and he then celebrated his fourth triumph. Velleius Paterculus, an able judge of military talents, gives us a most favourable idea of him as a general. Suetonius says also that, sharing in all the hardships of the common soldiers, he maintained a severe discipline, but that at the same time he carefully watched over the security and the comfort of the soldiers.

Augustus died at Nola on his return from Naples, when he had accompanied Tiberius, who was going to conduct the war in Illyria (29th of August, A.D. 14). Augustus saw her son at that critical moment in Rome. Livia concealed the emperor's death until Tiberius, who was informed of it by messengers, had arrived at Nola. (Dio. *Caesar*, c. 30, 31.)

Tiberius became emperor in his fifty-fifth year when both the virtues and the vices have taken strength from habit, and when a man's character changes. Until that time he was generally supposed to be a virtuous man; his virtues were his moderation and severe gravity of his character. Ammonius says that none has blamed his early life; yet Tiberius was emperor, than he was charged with crimes which were dreadful and disgusting. His former life is represented as dissimulation and hypocrisy. An example of dissimulation is known in history. Sixtus V. concealed his real intentions for thirty years; however, it was his real character which he thus concealed, but by his conduct in affairs, and by simulating disease as if he were dying, he made the cardinals believe that by choosing him they would make him their instrument, and his infirmities would not allow him to act as emperor. Tiberius however, except the eight years

at Rhodes, was constantly employed in matters which, although they would have allowed him to conceal his real disposition, he could never have managed with such success, unless his conduct had been directed by the force of his real character.

Augustus succeeded in making himself master of the republic by accumulating in his person the different functions of the state. Tiberius, proud and energetic, wished even the shadow of the sovereignty of a nation which he despised. The Romans being sufficiently disposed to obedience, the only obstacles in his way were worn-out institutions of the antient republic. Immediately upon the accession of Tiberius, Agrippa Postumus was put to death, probably by order of Tiberius (Suetonius, *Tiberius*, c. 22; Tacitus, *Annal.*, i. 6.) About the time the supreme power was offered by the troops on Lower Rhine to Germanicus, who however refused it; the mutiny was quelled by him and by Drusus, the son of Tiberius, who commanded in Pannonia. Tiberius began some enactments which tended to ameliorate the state morals; he abolished the comitia for the election of various officers of the state, and transferred the election to the senate, the members of which were subservient to him. It has been already said that Tiberius intended to destroy the last remnants of the antient sovereignty of the people, and to supplant the majesty of the Roman senate by the majesty of the emperor. Augustus had already employed the Lex Julia Majestatis to punish the authors of libels against his person (Tacitus, *Annal.*, i. 2); and his example was followed by Tiberius, who abolished the Judicia Majestatis, by which all those who were suspected of having impugned the majesty of the emperor, either by deeds or by words, were prosecuted with the utmost severity. The number of the delatores, or prosecutors of such crimes, daily increased, and a secret police was gradually established in Rome, as well organized, and as well supported by spies, as the secret police of Napoleon. The property, honour, and life of the citizens were exposed to the most unfounded calumnies, and a general feeling of anxiety and moral disease prevailed through the empire. The natural severity of Tiberius gradually degenerated into cruelty, and he showed symptoms of that misanthropy and that gloomy state of mind which increased with years. In the mean time Germanicus, the favourite of the army, had avenged the death of Varus, but Tiberius recalled him from Germany, and sent him into the East (17 A.D.). Germanicus conquered Cilicia and Comnagene, and he renewed the alliance with the Parthians, but he died suddenly at Antioch (19 A.D.): public opinion accused Cneius Piso, the commander in Syria, of having poisoned Germanicus by order of the emperor; but before Piso could be sent to trial, he was found dead.

Seianus, the son of a Præfectus Prætorio, succeeded in obtaining the confidence of the emperor (19-22 A.D.), who henceforth gradually abandoned to him the direction of public affairs, of which Seianus became the absolute master from the year 22 A.D. Drusus, the son of Tiberius, who had governed the Roman part of Germany with great ability, was poisoned by Seianus (23 A.D.), and this crime was followed by a great many others, with which it is possible that the emperor was very imperfectly acquainted. His practice was to shut himself up within his palace, and to spend his time in the most revolting debauchery. After the death of Drusus, Tiberius recommended to the senate as his successors, Nero and Calpurnius, the sons of the unfortunate Germanicus and of Agrippina, who was still alive. In 26 A.D., Seianus at last persuaded him to retire from public affairs. Tiberius allowed his advice and went to Capua and Nola, until at last he fixed his residence on the island of Capreae in the Gulf of Naples. The life which he led at Capreae was a series of infamous pleasures.

From this time all public affairs were directed by Seianus; the emperor was inaccessible. T. Sabinus, a friend of Nero, was put to death; statues were erected to Seianus, and received divine honours. After the death of Livia, in 29 A.D., the authority of Seianus was at its height; but at last Anthonia, the aged mother of Germanicus, penetrated through the barriers of Capreae, and informed the aged Tiberius that Seianus had left him only the name of emperor. She was supported by Macro, the commander of the Prætorian Guard. In consequence of this information, Tiberius

ordered the senate to condemn Seianus; and the senate obeyed: Seianus, his family, and his friends were put to death in 31 A.D. Some time after this event, Tiberius retired from Capreae, and took up his residence at a villa near Misenum, which had formerly belonged to Lucullus. (Suetonius, *Tiberius*, c. 73.) On the 16th March, 37 A.D., he fell into a lethargy, and everybody believing him to be dead, Caligula, the third son of Germanicus, the favourite of old Tiberius, was proclaimed emperor. However Tiberius recovered, and Macro, in order to save himself and the new emperor, ordered him to be suffocated in his bed. Thus died Tiberius, at the age of seventy-eight, after a reign of twenty-three years. (Tacitus, *Annal.*, vi. 50; Suetonius, *Tiberius*, c. 73.)

There is little doubt that the crimes said to have been committed during the reign of Tiberius, either by himself or by others in his name, are real facts. But the question is whether they are all to be imputed as crimes to Tiberius. His insanity is a fact which can hardly be doubted; a dark melancholy, disgust of life, and misanthropy, had taken possession of him, and his struggle with the idea of self-destruction often threw him into wild despair. He found consolation in the sufferings of others, and thus gave those bloody orders which he afterwards regretted. The unnatural pleasures to which he was addicted were only another mode of soothing the despair of his soul. It is probable that his insanity was complete when he retired to Capreae. Sometimes he had lucid intervals, in which he wrote those letters of which Suetonius gives some extracts (*Tiberius*, c. 67), and in which he confesses the wretched state of his soul. His physical health was excellent, until some days before his death. Tiberius loved the arts and literature. According to Suetonius he wrote a lyric poem, 'Conquestio de L. Cæsaris Morte'; he also wrote poems in Greek, choosing for his models Euphorion, Rhianus, and Parthenius, the author of an erotic poem which has come down to us.

(Suetonius, *Tiberius*; Velleius Paterculus, ii., c. 94, &c.; Tacitus, *Annal.*, lib. i.-vi.; Dion Cassius, lib. xlvi.-xlviii.; Horn, *Tiberius, ein Historisches Gemälde*. The character of Tiberius has been defended by Buchholz, *Philosophische Untersuchungen*, vol. ii., p. 49, &c.)

TIBERIUS II., ANICIUS THRAX, FLAVIUS CONSTANTINUS, one of the greatest and most virtuous emperors of the East. He was born in Thrace towards the middle of the sixth century A.D., and belonged to a rich and very distinguished family, the history of which is unknown to us. He was educated at the court of Justinian, whose successor, Justin II. (565-578), loved him as his son, and employed him in various civil and military offices. In 573 Tiberius, who was then general of the Imperial guards, commanded the army against the Avars, who were powerful north of the Save and the Danube. His lieutenant having neglected to watch the passages of the Danube, Tiberius was surprised by the Avars and lost a battle. However, he recovered this loss, and concluded a peace, by which the possession of the important fortress of Sirmium, now Mitrowicz, on the Save, near its junction with the Danube, was secured to the Romans. This was one of the few advantages obtained by the Greek armies during the unfortunate reign of Justin II. Italy, which had been conquered by Justinian, was overrun by the Longobards; the Berbers ravaged the kingdom of Carthage, which had been taken from the Vandals; and on the Persian frontier Chosroes (Khosrew) made various conquests. Justin, feeling his incompetency, and having lost his son, looked for a co-regent, and his choice fell upon Tiberius. The great talents of Tiberius, his amiable character, his generosity and love of justice, and his sincere piety, had won him the hearts of the nation, and the esteem of the emperor and his ministers. Justin was confirmed in his choice by the empress Sophia, whose private views on this occasion harmonised with the interest of the state. Tiberius was the handsomest man at the court, and it seems that Sophia intended to marry him on the death of Justin. However this may be, before she declared in his favour, she asked him whether he was married. Tiberius immediately guessed the motive of the question, and answered that he was not, although he was secretly married to a lady named Anastasia. He thus gained the protection of the empress, and was proclaimed Cæsar by Justin on the 7th of December, 574, in a most solemn assembly of

the civil and military officers, and of the clergy under the presidency of the patriarch Eutychius, by whom Tiberius was crowned with the imperial diadem. In this assembly the emperor Justin addressed to his future successor the following remarkable speech (Theophylactus, iii. 11), which Gibbon translates thus:—'You behold the ensigns of supreme power. You are about to receive them, not from my hand, but from the hand of God. Honour them, and from them you will derive honour. Respect the empress your mother—you are now her son—before, you were her servant. Delight not in blood, abstain from revenge, avoid those actions by which I have incurred the public hatred, and consult the experience rather than the example of your predecessor. As a man, I have sinned; as a sinner, even in this life I have been severely punished; but these servants (his ministers), who have abused my confidence and inflamed my passion, will appear with me before the tribunal of Christ. I have been dazzled by the splendour of the diadem: be thou wise and modest; remember what you have been, remember what you are.' To this speech of a dying sinner, Tiberius answered—'If you consent, I live; if you command, I die: may the God of heaven and earth infuse into your heart whatever I have neglected or forgotten.'

The burden of government devolved upon Tiberius, whose authority was never checked by Justin. The war with Persia prevented Tiberius from expelling the Longobards from Italy; but he sent there all the troops he could dispose of, and succeeded in maintaining the imperial authority in the Exarchate of Ravenna, on the Ligurian coast, in the fortified places in the Cottian Alps, in Rome, in Naples, and in the greater part of Campania and of Lucania. He saved Rome and pope Pelagius II. from the Longobards by sending a fleet laden with provisions (775). Some years later he concluded an alliance with the Frankish king Chilperic, who checked the Longobards in the north of Italy, and Tiberius succeeded in bribing several of the thirty Longobardian dukes, who, after the murder of king Clepho (573-574) and during the minority of Antharis, imitated in Italy the Thirty Tyrants of Athens. The daughter of king Alboin and Rosamond, who had fled from Italy, was then living at the court of Constantinople.

The most important event in the reigns of Justin and Tiberius was the war with Persia. Khosrew, the king of Persia, had made extensive conquests in Asia Minor during the reign of Justin. In 575 Tiberius concluded a partial truce for three years with him, on condition that hostilities should cease except on the frontiers of Armenia, where the war was still carried on. These frontiers being easily defended on account of the great number of defiles in the Armenian mountains, Tiberius levied a strong army while Khosrew lost time in forcing passages or in besieging small fortified places. For several centuries the Eastern empire had not seen such an army as was then raised by Tiberius. A hundred and fifty thousand men, among whom were many Teutonic and Slavonic barbarians, crossed the Bosphorus in 576, under the command of Justinian, and advanced to the relief of Theodosiopolis, the key of Armenia. Theodore, the Byzantine general, defended the fortress against the whole army of Khosrew. At the approach of Justinian the Persian king left the siege and advanced to meet the Greeks. The encounter took place near Melitene in the district of Melitene in Armenia Minor). The Persians were routed, and many of them were drowned in their retreat across the Euphrates; twenty-four elephants, loaded with the treasures of Khosrew and the spoil of his camp, were sent to Constantinople. Justinian then advanced as far as the Persian Gulf, and a peace was about to be concluded in 577: but Khosrew broke off the negotiations on account of a victory which his general Tamchosroes (Tam-khosrew) unexpectedly obtained over Justinian by surprising him in Armenia. Tiberius now recalled Justinian, and appointed in his place Mauritius, who was afterwards emperor. Mauritius restored the old Roman precaution of never passing the night except in a fortified camp; he advanced to meet the Persians, who had broken the truce of 575, and attacked the empire on the side of Mesopotamia (577). The Persians retired at the approach of Mauritius, who took up his winter-quarters in Mesopotamia (577-8).

On the 26th of September, 578, Tiberius became sole emperor by the solemn abdication of Justin, who died on

the 5th of October next. After the funeral of Justin, when the new emperor appeared in the Hippodrome, the people became impatient to see the empress. The widow of Justin, who was in the Hippodrome, expected to be presented to the people as empress; but she was soon undeceived by the sight of Anastasia, who suddenly appeared at the side of Tiberius. In revenge, Sophia, a plot against Tiberius, and persuaded Justinian, a former commander in the Persian war, to put her at the head of the conspiracy. Tiberius however, by pardoning him made him for ever his faith. Sophia was deprived of her imperial pension and she died in neglect and obscurity.

A quarrel broke out between Eutychius, the patriarch, and Gregorius, the apocrisarius of Constantinople, who could not agree on the state of the soul after death. The Greeks were then the most disputatious people in the world about religious matters, and their disputes often led to serious trouble. The emperor accordingly undertook to settle this dispute. Adhering to the opinion of Gregorius, he convinced the patriarch that he was wrong, and he persuaded him to burn a book which he had written on the corporeal nature of the soul after death.

Khosrew died in 579, after a reign of forty-eight years. He had entered into negotiations with the Greeks, but his successor, Hormisdas (Ormuz), broke them off and recommenced the war. Hormisdas was defeated by Mauritius and his lieutenant, Narses, a great captain, who must not be confounded with Narses, the victor of the Ostro-Goths. They overran Persia in one campaign 579, and in 580 they routed the army of Hormisdas in a bloody battle on the banks of the Euphrates, and took up their winter-quarters in Mesopotamia. At the same time the Goths obtained great advantages in Africa. Gaszul, king of the Mauriani, or Berbers, had defeated and killed three Gothic generals, Theodore, Theoctistes, and Arnabalis. But in 580 he was defeated by the exarch Gennadius, and put to death. Tiberius was less fortunate in Europe, the Avars having surprised and taken the town of Sirmium. But in the following year (581) Mauritius destroyed the Persian army in the plain of Constantine, and their general, Tam-khosrew, lost his life. Mauritius had a triumph in Constantinople, and on the 5th of August he was created Cæsar by Tiberius, who was then worn out by illness, and who had no male issue. After having given his daughter, Constantina, in marriage to Mauritius, Tiberius died on the 14th of August, 582, and, since the time of the great Theodosius, no emperor's death caused regret so universal. It is a remarkable circumstance in the reign of this emperor, that he was always provided with money without oppressing the people by taxation; and yet his liberality was so great that the people used to say that he had an inexhaustible treasure. But all these resources did not enable him to save Italy, which may be accounted for thus:—During the invasions of Italy and other parts of the Roman empire by the barbarians, many rich men saved great quantities of gold and silver, which they carried to Constantinople, then the only safe place in Europe. The city being the centre of the arts, and the commerce and industry of the East being very extensive, even the money which fell into the hands of the barbarians gradually found its way into the Greek empire, where the barbarians purchased all those articles which they had not skill enough to fabricate themselves. This view is corroborated by the fact, that notwithstanding the immense tribute which the Greek emperors often paid to the barbarians, there was always a want of coin in the barbarian kingdoms. On the other hand, the Greeks having lost their martial habits, the emperors were obliged to recruit their armies among the barbarians. These people however were so ready to fight against the emperors as for them; and it would have endangered the existence of the empire if too large a number had been engaged in its service. Thus Tiberius preferred bribing the Longobardian dukes to raising a new army of barbarians, who would probably have joined Longobards as soon as they had got their pay.

Cedrenus; Theophanes; Theophylactus; Gregorius Turonensis; Paulus Diaconus; Gibbon and Fall; Le Beau, *Histoire du Bas Empire*.

TIBERIUS ALEXANDER, prefect of Egypt was the son of Tiberius Alexander who was alabarcha of Alexandria, and the brother of Philo Judæus, the well-known

r. Tacitus calls him an Egyptian, but this only means he was a native of Alexandria; for he was a Jew, and he afterwards adopted paganism. Nero appointed him governor of Judaea, where he succeeded Cuspius Gaius, and he made him a Roman eques. In the last year of his reign against the Parthians, Tiberius Alexander and Vinianus Annius, the son-in-law of Corbulo, given as hostages to king Tiridates, who came to the camp for the purpose of settling his differences with the Romans (A.D. 63). Tiberius Alexander was afterwards appointed prefect of Egypt, in which capacity he suppressed a dangerous insurrection of the Jews of Alexandria, who were jealous of the favour which Nero showed to the Greek inhabitants of that town. The resistance of the Jews was so obstinate, that Tiberius was obliged to employ legions and five thousand Libyan soldiers against them; and it is said that more than fifty thousand Jews died on this occasion. On the 1st of July, 69, Tiberius Alexander proclaimed Vespasian emperor, pursuant to a decree which had been concerted by Vespasian, Titus, and Mucianus, the proconsul of Syria. In consequence of this event, the 1st of July, 69, is regarded as the beginning of the reign of Vespasian, who showed great regard for the province of Egypt. When Titus, the successor of Vespasian, was about to undertake the siege of Jerusalem, he resulted in its capture, he was accompanied by Tiberius Alexander.

Tiberius, *Antiq. Jud.* and *De Bello Jud.*; Suetonius, *Tiberius*; Tacitus, *Annal.*, xv. 28; *Hist.*, i. 11; ii. 74, he notes of Ernesti to Suetonius and Tacitus.)

TIBERIUS (Τιβέριος), an Alexandrine grammarian, who lived in the fourth century of our æra. Suidas calls him a philosopher and a sophist, and gives him a long list of rhetorical works, all of which are lost, with the exception of one, which formerly used to be called *περὶ τῶν παρὰ Δημοσθένει σχημάτων*, and which is considered to be the best work of the kind that were produced at that time. The editio princeps of it, which is ascribed to Alatrius, appeared at Rome in 1643. The next edition was that of Gale, who incorporated the work of Tiberius with *Rhetores Selecti*, Oxford, 1676, 8vo. A reprint of the collection of rhetoricians was edited by J. F. Fischer, 1773, 8vo. In all these editions the work of Tiberius contains only 22 short chapters, which treat on Schemes, that is, those forms of expression which are not the natural forms, but are adopted for ornament or use. In the year 1815, J. F. Boissonade published at London a new edition, in 8vo., from a Vatican manuscript, in which the work is called *περὶ σχημάτων ῥητορικῶν*, and in which there are 6 chapters more than had ever before been published; and this second part of the work treats on the so-called *figuræ elocutionis*, or the ornamental forms of rhetoric. This edition of Boissonade also contains a work of Tiberius, entitled *τεχνὴ ῥητορικὴ*, the author of which has become known through the Vatican MS. containing the complete work of Tiberius: in the editions of Gale and Ernesti it was called the work of an anonymous writer. Fragments of other works of Tiberius are preserved in a scholiast on Hermogenes, ii., pp. 385 and 401, edit. 1805.

TIBERIIUS, *Initia Historiæ Græcorum Literariæ*, ii., p. 3; Westermann, *Geschichte der Griech. Beredsamkeit*, p. 251, &c.)

TIBERIUS ABSIMARUS became emperor of the East, in 698, under the following circumstances:—Leontius deposed and banished the tyrant Justinian II., and having retained the imperial title in 695, continued the war with the Arabs in Africa. Notwithstanding the Greeks were aided by the Berbers, they lost Carthage in 697; they recovered it shortly afterwards, but in 698 the Arabs took the town from the Greeks and entirely destroyed it. A powerful fleet, commanded by the patrician John, was sent off Carthage; but although John entered the harbour and a division of his fleet, and landed a body of troops, his measures had only a partial effect, and he was obliged to leave Carthage to her fate. The destruction of this town was attributed by the Greek officers to the incompetency of John, and they were afraid to return to Constantinople without having prevented the ruin of Carthage.

Absimarus, the commander of the Cibyratee, or troops of the province of Cibra, then the collective name of Caria and Lycia, turned the discontent of the soldiers to his own profit. He persuaded his men that the

emperor would punish them severely for not having obtained some advantage over the Arabs, and that they ran the risk of suffering for the faults of their commander-in-chief. When the fleet was off Crete, a mutiny broke out. The Cibyratee proclaimed Absimarus emperor, the rest of the fleet followed their example, and John was massacred.

Absimarus having arrived at Constantinople, cast anchor in the bay of Ceras (now the Golden Horn), between this city and the suburb of Syrae. Leontius prepared a vigorous resistance; but the courage of his soldiers and of the inhabitants was weakened by an epidemic disease, and at last Absimarus found his way into the town by bribing some sentinels.

Absimarus assumed the name of Tiberius and was acknowledged emperor: his rival, Leontius, had his nose and his ears cut off, and was confined in a monastery. Tiberius Absimarus continued the war with the Arabs, and appointed his brother Heraclius commander-in-chief. This experienced general conquered Syria in 699 and 700, and treated the Mohammedan inhabitants most barbarously: it is said that two hundred thousand of them lost their lives by the sword of the Greeks. This war continued during 701, 702, and 703; and, although the Greeks did not recover Carthage, they obtained many signal advantages. Tiberius Absimarus had great influence in Italy, where popes Sergius and John VI. were continually harassed by John Platys, and afterwards by Theophylact, the Greek exarch of Ravenna.

Tiberius Absimarus lost his crown by a sudden revolution. When Leontius dethroned Justinian II., this prince had his nose cut off, and was banished to the town of Cherson, in the present Crimea. Some years after, he fled to the khaghan, or khan, of the Khazars [*TARTARS, Khazars*], who received him respectfully, and assigned for his residence Phanagoria, once an opulent city, on the island of Tamatarcha. [*TAMAN.*] The khaghan, whose name was Busirus, gave him in marriage his sister Theodora; but Tiberius Absimarus bribed the khan with a large sum of gold, and Justinian was only saved by the affection of Theodora, who discovered to him the treacherous design of her brother. After strangling with his own hand the two emissaries of the khaghan, Justinian rewarded the love of his wife by repudiating her and sending her back to her brother Busirus; and he fled to Terbelis, or Terbellus, the king of the Bulgarians. He now formed the plan of recovering his throne, and he purchased the aid of Terbelis by promising him his daughter and a part of the imperial treasury. At the head of fifteen thousand horse, they set out for Constantinople. Tiberius Absimarus was dismayed by the sudden appearance of his rival, whose head had been promised by the khaghan, and of whose escape he was yet ignorant. Justinian had still some adherents in Constantinople, who introduced his troops into the city by means of an aqueduct. Tiberius escaped from Constantinople, but he was seized at Apollonia on the Pontus Euxinus (705), and Justinian ordered him, his brother Heraclius, and the deposed Leontius, who was still alive, to be dragged into the Hippodrome. Before their execution, the two usurpers were led in chains to the throne, and forced to prostrate themselves before Justinian, who had sworn not to spare one of his enemies. Planting his feet on their necks, the tyrant watched the chariot-race for more than an hour, while the people shouted out the words of the Psalmist, 'Thou shalt trample on the asp and basilisk, and on the lion and dragon shalt thou set thy foot.' He then gave orders to behead Tiberius, Leontius, and Heraclius. Justinian II. reigned till 711. The Greeks gave him the surname of Rhinotmetus, that is, 'he whose nose is cut off.' Tiberius Absimarus had two sons, Theodore and Constantine, who probably perished with their father. It is said however that Theodore, who is also called Theodosius, survived his father, and became bishop of Ephesus and one of the leaders of the Iconoclasts; but this is doubtful.

(Theophanes; Cedrenus; Zonaras; Gibbon, *Decline and Fall*; Le Beau, *Histoire du Bas Empire.*)

TIBET is the most southern of the three great tablelands of Middle Asia. The name Tibet is derived from 'Thu-pho,' that is, the country of the 'Thu,' who founded an empire in Northern Tibet in the sixth century A.D. The name 'Thu-pho' has been mutilated by foreigners, and especially by the Mongols, into Thupo, Tobut, Tiböt,

Tebet, and Imbet. The orthography Tibet was introduced by the Jesuit missionaries. Sanang Setsen, the historian of the Mongols, and the modern Chinese, write it Tübet, and this latter orthography has been adopted by Ritter. Another name of this country is 'Pue-Koa-chim,' which, according to Turner, signifies the 'snowy country in the north.' Sanang Setsen often calls it 'Gang-d'yan-yul,' which signifies the 'country of the snow' in the Mongol language, a name which is analogous to 'Iceland.'

Our knowledge of Tibet is very imperfect. We are only acquainted with some lines of road and certain points which have been visited by travellers. The Chinese geographers have furnished very valuable notices concerning this country, but the Tibetan sources are almost unknown to Europeans. Marco Polo visited Tibet; in the beginning of the eighteenth century (from the 17th of August, 1715, to the 18th of March, 1716) Father Desideri travelled through nearly the whole extent of Southern Tibet, from Leh in the west, to H'Lassa or Lassa in the east; Father de la Penna was also in Tibet; and in our own days Turner, Moorcroft, and Gerard have visited parts of it.

Boundaries.—Tibet, in the largest sense of the word, has the following frontiers. The Bolor Mountains, a branch of the Hindu Kush, which stretches towards the north-west, in $72^{\circ} 30'$ E. long., form the western boundary. The length of this frontier is about 87 miles. It is bounded on the south-west by the Hindu Kush, from Mount Tutukan Mutlami and the north-western part of the Himalaya as far as the western frontier of Nepal, a distance of about 400 miles. The southern boundaries are formed by the range of the Himalaya from the western frontier of Nepal to the eastern frontier of Bootan, a distance of about 740 miles, and by the northern boundaries of Assam, Burma, and part of the Chinese province of Yunnan. This latter part, which is nearly unknown, runs in a south-eastern direction, and most probably as far as the junction of the Yu-leang-Ho, or Li-tchou, with the Kincha-Kiang, or Yang-tse-Kiang, in Yunnan, between 102° and 103° E. long. The length of this part of the frontier in a straight line between the two extremities is about 320 miles. The whole length of the southern frontier, according to a rough estimate, is 1540 miles, but as this frontier forms a curve, its real length is much more. The eastern frontier of Tibet is formed by the western boundaries of the Chinese provinces of Süichuang (Setchuen), Shensi, and Kansu. This frontier has been fixed by the Chinese, but Europeans only know some points of it which are marked in the Itineraries of the Chinese geographers. From the junction of the Yu-leang-Ho with the Kincha-Kiang it stretches northwards, and probably along the river Ya-long-Kiang as far as the 30^{th} degree of N. lat. It then takes a north-eastern direction, and stretches as far as Kiai, along a range of wild and snowy mountains, which, on some maps, are called the Yun-ling Mountains. At Kiai it takes a north-west direction, crosses the Hoang-Ho, or Yellow River, runs to the east as far as Hongchin, and then takes a north-west direction as far as a point situated in the mountains of Amegangar, in $38^{\circ} 25'$ N. lat. and 100° E. long. That part of Tibet however which lies south of the 29^{th} degree of N. lat., and east of the Kincha Kiang, or the mountains of Batang, was ceded to China in 1727, and is now under the immediate sovereignty of the emperor of China. The whole extent of the eastern frontiers of Tibet is at least 900 miles. We have no positive knowledge of the northern frontiers. They begin in the Bolor Mountains, east of which they were traversed by F. Desideri (*Nouv. Journal Asiatique*, tom. viii., p. 117) on his way from Yarkand to Leh. From thence they are said to stretch east-south-east along the mountains of Kárákorum as far as a point situated in the mountains of Kuenlun (Oneuta, or Kulkoun), in 35° N. lat. and 85° E. long., across the deserts of Khor and of Katchi, or Katche. Thence they run north-east and east, until they reach the eastern frontier at that point which we have mentioned above, as situated in $38^{\circ} 25'$ N. lat. and 100° E. long. The whole length of the northern frontier, including the larger bends, amounts to about 1300 miles. It is however doubted whether the extensive country of Khu-khu-Nor, in north-eastern Tibet, belongs to Tibet in the political sense of the word; and if so, the northern frontier of Eastern Tibet will not extend beyond 36° N. lat. (Ritter, iv., p. 173.) But geographically speaking, Khu-khu-Nor belongs to Tibet. It is a very remarkable fact that the northern frontiers, as they have been here described,

form a curve almost parallel to the curve of the Himalaya, although they diverge in proportion as they stretch towards the east. From this parallelism we may conclude that these northern frontiers are perhaps identical with the natural frontier of the Tibetan table-land. Thus Tibet is bounded on the west by Independent Turkistan; on the south-west and south by Punjab, British Hindustan, Nepal, Bootan, and Assam; on the south-east by Assam and China; on the east by China; and on the north by the desert of Gobi and Chinese Turkistan.

Tibet, comprised between these limits, resembles an immense cornucopia, the handle of which is in the west, between the Hindu Kush and the mountains of Kárákorum, and through its wide opening, 1500 miles to the east, the largest rivers of eastern Asia flow, and carry fertility and abundance to Burma, Siam, and China.

Mountains.—Tibet is a table-land, the highest plains of which are more than 10,000 feet above the level of the sea. This table-land is divided into three great and distinct parts. The first, which is long, and not very wide, begins in the east, near Mount Kailasa, in the Himalaya, and stretches to the north-west, between parts of the Himalaya and of the Hindu Kush in the south-west, and the range of the mountains of Kárákorum in the north-east. It is traversed in its whole length by the upper part of the Indus. Its lower or north-western part, Balu or Baltistan, is also called the First Tibet, or Little Tibet, and is an independent state. Its upper or south-eastern part has the name of Ladakh, and is also called the Second Tibet, or Great Tibet, because it is larger than Baltistan. Sometimes the name of Little Tibet is given to the whole valley of the Indus. Ladakh is also an independent state, but the most eastern part of it, as far as Teshigang on the Indus, belongs to China. Baltistan and Ladakh have been described under the heads of Himalaya and Hindustan vol. xii., p. 219, &c.). Baltistan and Ladakh belong only to Tibet in the most extensive sense of the word. The second great division of Tibet begins in the south, near Mount Kailasa, and is an immense elevated desert, the western part of which is called Khor, and the eastern part Katchi. Its boundaries are the range of Kárákorum on the west; the Kuenlun mountains on the north; the snowy mountains around the sources of the Kincha Kiang, the Om-Tsiu, and the lake of Tengri-Nor in the east; and the mountains of Dzang and Ngari in the south. Khor and Katchi have never been visited by Europeans, though the eastern part is traversed by the great road which leads from H'Lassa to Yarkand, in Chinese Turkistan. The third great division of Tibet contains the remainder of this country, which lies east and south of Khor and Katchi.

The second and third natural divisions have the common name of Eastern or Third Tibet, or Tibet in the proper sense of the word. Eastern Tibet is subject to China.

All that we can say about Khor and Katchi is that they are an immense table-land, some parts of which are 10,000 feet above the level of the sea. This table-land, however, is not a level plain. It is a country traversed by chains of mountains, which have a height varying from 3000 to 4000 feet above their base, or from 13,000 to 14,000 feet above the sea. The middle part seems to be less elevated than the boundaries, as the country contains several rivers which terminate in the table-land; and the southern and western parts are higher than the eastern and northern parts, the direction of the greater number of these rivers being from the west to the east, and from the south to the north.

The aspect of the southern and eastern parts of Third Tibet is very different from that of Khor and Katchi. Third Tibet is traversed by numerous ranges of lofty mountains, the direction of which is from west to east and from north-west to south-east. From these ranges lateral branches run out in different directions, and contain deep valleys between them. In proportion as the principal chains advance towards the south-east, they converge towards one another, and thus the valleys between them gradually become narrower, until at last, on the frontiers of Yunnan and Burma, they are mere mountain-passes. At this spot there are four parallel valleys, traversed by four of the greatest rivers of the world, and the breadth of the four valleys together seems not to be more than one hundred miles. But the range of the mountains of Ngari and Dzang diverges from the Himalaya; and the valley between them, which is traversed by the Danangbo, be-

comes broader as it advances towards the east. The chain which, in the south-eastern corner of Tibet, separates the Kincha-Kiang in the east from the Lang-tsang-Kiang in the west, has the name of Ning-tsing-Shan, or Mang-li (Moung-lan); and, since 1727, the frontiers between Tibet and China run along the foot of this chain, the summits of which are covered with eternal snow. The height of the mountains in south and eastern Tibet is much greater than in the northern and central parts of the country, and the whole tract towards China, Nepaul, and Bootan, is an immense alpine country. Several passes in the Mang-li mountains are from 10,000 to 11,000 feet above the sea; the region of perpetual snow seems to begin at 12,500 feet, and as the snow always covers an immense number of summits and whole ranges, it is evident that the number of summits which have an absolute elevation of above 12,500 feet must be very considerable. Some of them probably attain the height of 26,000 feet above the sea. The extent of the Mang-li mountains between Bathang on the Kincha-Kiang, and Tsiampo on the Lang-tsan-Kiang, according to the Chinese itineraries, is 1405 li, of 250 to a degree. (Ritter, iv. 202.) All this country is intersected by deep valleys and chasms. The summits of the mountains are covered with eternal snow, and the traveller crosses the chasms by means of bridges which are enveloped in the clouds. The mountains north of the Mang-li, around the sources of the Lang-tsan-Kiang, in the province of Tsiampo, are no less elevated, but they have never been visited by Europeans. A very extensive range begins at Mount Kailasa in the Himalaya, and stretches to the east as far as the ninetieth degree of east longitude, in a direction diverging from the Himalaya in Nepaul and Bootan. These are the mountains of Ngari and Dzang, the most western part of which is called Gangdisir, or the country of the snow mountains. At the beginning of this westernmost part, and in the north-eastern part of the province of Ngari, is situated the celebrated Mount Kailasa, which is said to be higher than the Dhavalagiri. The Kailasa is steep on all sides, and is 140 li in circumference; its summit is always covered with snow, and the water tumbles down from it in cataracts into the surrounding valleys. This mountain has also the name of Oneuta. East of the Kailasa are situated four mountains, or perhaps groups of mountains, the K'habhabhs, each of which resembles a different animal. The first is the Horse-mountain, or Tam-tsiogh-K'habhabh; the second is the Elephant-mountain, or Lang-tsieng-K'h; the third is the Lion-mountain, or Sengghe-K'h; and the fourth is the Peacock-mountain, or Mabghia-K'h. The length of these four mountains is said to be 800 li, and with respect to the valleys which begin at their foot and stretch in different directions, they resemble Mount St. Gothard in Switzerland. The mountains on the southernmost part of Tibet have been described in the article HIMALAYA.

Rivers.—The sources of the Dzangbo are on the east side of the K'habhabhs, in the province of Ngari. Its complete name is Yaru-Dzangbo-tsu, that is, the pure frontier river of the west. According to the Chinese geographers, the source of the Dzangbo is on Mount Tam-tsiogh, in 30° 10' north latitude, and 79° 35' longitude east of Paris. It flows in an east-south-eastern direction, through the whole of Southern Tibet, a distance of about 700 miles, and waters the provinces of Ngari, Dzang, and Wei. The valley of this river is formed by the Himalaya on the south, and the mountains of Ngari and Dzang on the north. The country through which it flows being very extensive, and all the mountains being covered in winter with snow, of which an immense quantity melts in the summer, the volume of water in this river must be very considerable. The tributary rivers of the Dzangbo, on its left or northern side, are: the Nauk-Dzangbo; the Dzang-tsu, or Galdjao-muren, that is, the 'furious river,' which has its sources in the north-east, about 200 miles from its junction with the Dzangbo near H'Lassa, and which is sometimes confounded with the Dzangbo itself. There are five considerable rivers between the Nauk-Dzangbo and the Dziang-tsu. The tributary rivers on the right or southern side are: the Guyang, which has its source near Mastang, in the Himalaya (there are five other considerable rivers, which come down from the Himalaya of Nepal); and the Pai-nom-tsu, or Fuang-dze, along which Turner travelled, from its source at Phari to its junction

with the Dzangbo, and which has a fine iron bridge of thirteen arches. An iron suspension-bridge is thrown over the Dzangbo, south of H'Lassa, on the great road from the west to this town. The course of the Dzangbo is known as far as a point which is situated about 100 miles east of H'Lassa, in 26° 30' N. lat. according to D'Anville; in 28° 30' N. lat. according to Klapproth; and in 29° 15' N. lat. according to Berghaus. It has been conjectured that the Brahmaputra is the continuation of the Dzangbo [BRAHMAPUTRA], but it is now known that they are different rivers. The continuation of the Dzangbo is the Irawaddy. We owe this discovery to Julius von Klapproth, who published several memoirs on the course of the Irawaddy, of the Brahmaputra, and the Dzangbo.

All that we know about the Southern Nu-kiang is conjectural. Ritter says that the Nu-kiang is a southern tributary river of the Dzangbo, but this is impossible, and instead of 'southern' we must read 'northern.' (Ritter, iv., pp. 212-223.) The sources of the Gakbo-dzangbo-tsu, or the clear river of Gakbo, are situated in 31° 30' N. lat., between the mountains of Sangtsen-sum-do-ri and Barkala, on the frontiers of the provinces of K'ham and of Wei. Its upper course has the name of Sang-chu or Dziangbo-tsu. Its direction is at first south-east. The great road from China to H'Lassa crosses this river some distance east of the celebrated temple of H'Lari. The Gakbo-dzangbo-tsu then enters the country of Gakbo, where it receives a considerable river called Bo-Dzangbo, which enters it on the left or eastern side. After having entered the country of H'Lokba, it probably takes a southern direction, but we have no positive knowledge of it. According to the Chinese map of the emperor Khien-Long, of which the 'Carte de l'Asie Centrale' of Klapproth is a reduction, the Gakbo-dzangbo-tsu enters the Chinese province of Yunnan, and there receives the name of Lung-chuan-Kiang. As to the Om-tsu, or Oui-tsu, another great river, there is great difference of opinion. According to the Chinese maps, the Om-tsu is formed by the junction of three rivers, the Ser-Sumbu, or Ser-tsu, in the east, the Uir-chu in the west, and the Kára-us-su, the largest river, in the middle. The source of the Kára-us-su is said to be in the table-land of Middle Tibet, about 32° 30' N. lat. and 90° to 91° E. long. The Om-tsu has a south-east course, and flows in a very deep and narrow valley, enclosed by steep rocks of an immense height; it enters the province of Yunnan in China, where it receives the Chinese name Nu-Kiang, that is, 'the river of the barbarians.' The latter part of its course within Tibet is unknown to European geographers. The Lang-tsang-Kiang traverses almost the whole extent of eastern Tibet, from north-west to south-east. Two rivers, the Om-chu in the west, and the Dzo'chu in the east, the sources of which are situated north of the upper part of the Om-tsu, in the province of K'ham, join at Tsiampo, and thus form the Lang-tsang-Kiang, the direction of which is from north-west to south-east. From the 30th to the 27th degree of N. lat. the Lang-tsang-Kiang traverses a country quite unknown to Europeans. This river is also called La-chou, La-tsu, Lo-tsau, and Lo-tsu. After having traversed Yunnan, it enters Lao, forms the frontier between Siam and Cochinchina, and flows into the Chinese Sea in 10° N. lat., after a course of more than 1700 miles. The sources of the Kincha-Kiang, or Yang-tse-Kiang, which traverses China from west to east, are situated between 37° and 38° N. lat., and between 89° and 92° E. long., on the table-land towards the north-western frontiers of Eastern Tibet. Its upper part is called Muru-us-su by the nomadic Mongols of that country; its middle part has the Tibetan name of Bourei-tsu; and it is only in China that it is called Kincha-Kiang. Its direction is east as far as 95° E. long.; from this point to Batang the direction is south-east and south; from Batang to its junction with the Litchou (the old frontier of Tibet), it is again south-east. This latter part of the Kincha-Kiang forms a part of the present frontier between Tibet and China. The Ya-long-Kiang is an important tributary of the Kincha-Kiang. Its sources are about 29° N. lat. and 97° 30' E. long., in the Bayan-Khara, a range of high and wild mountains stretching in a south-east direction, between the Kincha-Kiang and the Ya-long-Kiang in the south, and the sources of the Hoang-Ho in the north. The direction of the Ya-long-Kiang is at first south-east for about 200 miles: east of 100° E. long. it runs southward for about 300 miles: during the latter part of its course the direction is at first east, as it seems,

and then again south for about 100 miles. But all this is conjectural. The Hoang-Ho, or Yellow River, has its sources north of the Bayan-Khara, in the province of Sifan. Only its sources and a part of its upper course are in Tibet and in Khu-Khu-Nor (Köke-Nor), the most northern part of Tibet, of which we have already spoken. The description of this river has been given under CHINA. The whole country between the upper part of the Hoang-Ho in the north and in the west, the Ya-long-Kiang in the south-west, and the frontier of China in the east, or the eastern parts of Sifan and Khu-Khu-Nor, is traversed by ranges of high mountains covered with perpetual snow; it is an unknown country to us.

Lakes.—The Tengri-Nor, the largest lake of Tibet, is nine days' journey north of H'Lassa. The Chinese call it Thian-chhi, or the Celestial Lake. This lake appears to be surrounded by high mountains and rocks covered with snow and ice. It receives the Tarku-Dzangbo, a river which comes from the west. The lake of Palte, which is situated south-west of H'Lassa, in the valley of the Dzangbo, resembles a large ditch surrounding an extensive island which fills up the middle of the lake. On the Tibetan maps it has the name of Bhaldi-Yumtso, and the Chinese call it Yar-brok-Yumtso. According to the Chinese geographers there is a nunnery on that island which has the name of Dhordze-phaghi-mo, or the 'Palace of the Holy Sow,' which is said to be one of the finest in Tibet. It is said that north of this lake there is a high mountain called Kambala, from the summit of which extensive ranges of high snowy Alps may be seen to the north. These are most probably the mountains which surround Lake Tengri-Nor. In the extreme north of Tibet is situated the Lake Khu-Khu-Nor, or Köke-Nor, that is, 'the Blue or the Celestial Lake,' which name has been given to all the surrounding country. The lakes of Kailasa, in the southern part of Tibet, have been described under HIMALAYA.

Climate.—Tibet is known in India and China as a country of hunger and misery, and as such it is represented by the Mongol historian Sanang Setsen. However cold and barren the table-lands and the mountains may be, on account of their extreme elevation and of the snow which perpetually covers whole tracts, the climate of the valleys, and especially of the valley of the Dzangbo, is hot. From March to September the weather is fair, interrupted only by some showers; the winds are not regular, as in India. In H'Lassa the trees bud at the end of April and in the beginning of May. Corn and peas are sown towards the end of the spring and in the beginning of the summer; and the harvest is reaped in the months of August and September. Dew falls in the summer nights; it hails often; the snow is not deep in the winter. On the high table-lands the climate is very different. Turner, who visited a part of them on his way from Bootan to Teshu Lumbu, gives an interesting description of it. From May to October the sky is always clear, and the sun shines with uncommon brightness. From October to May there are violent gales. The surface of the weather-beaten rocks breaks in pieces, which the air dissolves into fragments as small as dust; and clouds of this dust, raised by whirlwinds, are driven from the plain to the summits of the mountains, and from the mountains down to the houses of the inhabitants. The air is excessively dry, and its effects resemble those of the dry heat of the Sahara. The trees wither; their leaves may be ground to powder between the fingers; planks and beams break, and the inhabitants cover the timbers of their houses with wet towels in order to preserve them against the destructive effects of excessive dryness. The timber never rots. The flesh of sheep exposed to the open air becomes dry, and may be ground like bread, and thus preserved during years. This flesh-bread is a very common food in Tibet.

Productions.—Among the minerals there are gold, silver, copper, tin; salt, which is taken from the salt-lakes of Jayek and Deng-tsavga; corundum stone, lapis lazuli, turquoise, and agate. Besides a great number of grasses which are common in Europe, Tibet produces a kind of grey barley, grapes in Bathang, and, near H'Lassa, Ingwer, assafœtida, rhubarb, madder, safflower, apples, nuts, apricots, peaches, pomegranates, and figs in the valleys. The cedar grows in Tibet. Among the animals there are wild-oxen with long hair, buffaloes, the buffalo which is called the yak, goats with a very fine fleece, goats with long

fine hair, silk-worms, wild-cats, tigers, leopards, lynxes, argali with horns of one hundred pounds weight, peacocks, white eagles, and swans. All our domestic animals are known in Tibet, and the horses are excellent. Fish are abundant in the rivers, but they are not eaten, being prohibited by the religion of Buddha.

Political Division.—1. The territory of the Dalai-Lama contains the eastern and north-eastern parts of Tibet. The capital, H'Lassa or Lassa, is situated in a beautiful plain on the banks of the Dzang-tsu, about twelve leagues from its junction with the Dzangbo. It is a populous and very commercial town, and distinguished by many fine public buildings, especially convents, among which there is the first temple of the Buddhists. There are a small-pox hospital, a printing-office, and several schools, especially for divinity. The town has walls and five fortified gates. In the neighbourhood of the town, in the north, the east, the south, and the west of it, are four magnificent convents, the largest among the 3000 convents of Tibet, a great number of which contain several thousand monks. The residence of the Dalai-Lama is in the convent of Pobrang-Marbu (the red town) on Mount Botala, north-west of H'Lassa. It is said that the principal building of this residence, or the Lapranga, is 367 feet high, and that it contains 10,000 rooms. (Ritter, iv. 243.) On the walls of one of its large rooms are most probably suspended those chorographical tables which Father de la Penna admired when he was in H'Lassa. The environs of H'Lassa are full of convents and palaces, of which the most magnificent is that of Dzundzio-lu-Khang. Besides the capital we only know some points on the great roads which lead to H'Lassa from the east and from the west, but no considerable towns are mentioned on these roads, except Yiga-gung-chu, a town which is inhabited by 20,000 families, and which is situated east of H'Lassa on the Dzang-bo.

2. The territory of the Teshu-Lama contains the provinces of Dzang and Ngari, and perhaps also the countries of Khar and of Katchi. His residence is at the palace, or rather the convent of Teshu-H'Lumbu, in 29° 4' N. lat. and 89° 7' E. long., according to Turner, who visited this place in 1783. It was founded in 1447, on a small plain surrounded by lofty mountains; but as this plain is a part of the high table-land, the environs are cold and desolate. Teshu-H'Lumbu lies almost opposite to a pass across the Himalaya of Bootan, which is defended by the fortress of Dzigidze-Jeung. Teshu H'Lumbu, or, more correctly, Iachi H'Lumbo, contains from 300 to 400 houses, convents, temples, and palaces, which are surrounded by a wall, and all communicate with each other. The chief building, where the Lama resides, has the name of Lapranga, the most remarkable part of which is the mausoleum of the Teshu-Lama, who died in February 1781. This mausoleum, of which Turner gives a careful description, has a most beautiful appearance, and is a fine specimen of Tibetan sculpture. It is said that 300 Gyeken or monks are daily occupied in the performance of the various religious duties in the palace of Teshu H'Lumbu. The greater part of the country between Teshu H'Lumbu and H'Lassa is a fertile and beautiful tract, which extends along the river Dzangbo from west to east. At one day's journey east of Teshu H'Lumbu is Pina Baiman, a small town with a fortified castle. Baldi or Bedi, another small town, lies on the northern bank of Lake Palte.

Inhabitants and History.—According to the legend Tibet was originally inhabited by animals and demons. At a certain period God sent to Tibet the king of the monkeys, who led there the life of a hermit: his exclusive occupation was the performance of religious duties, and he was absorbed in the pursuit of the knowledge of nonentity. When he was just on the point of attaining the object of his pursuit, he was disturbed in his contemplations by the visit of a female Manggus. The Manggus, whose Sanscrit name is Rakshas, are ugly demons, who however can adopt any figure they please. The Manggus who came to the king of the monkeys had assumed a beautiful figure, and proposed to the king to marry her. The king at first alleged his monastic duties, but at last he married the Manggus, and their descendants are the people of Tibet. (Schmidt, *Forschungen*, p. 211.) This account however, ridiculous as it may appear to a European, is of importance to a nation which believes in the metempsychosis, and is proud of its descent from a monkey, because he is one of the most cunning of animals. The first ac-

nants of the history of Tibet are in the annals of the Mongols and of the Chinese. The Tibetans belong to the Mongol race: they were at first divided into many independent tribes which led a nomadic life, like all the other Mongol tribes before the time of Genghis Khan. The first king of Tibet, according to Sanang Setsen, was Seger-Sandilituhaghan-Tül-Esen, whose youth resembles that of Moses, or he was exposed by his father, and afterwards found in a copper box swimming on the river Ganga. He became king in 313 B.C., and united the four great tribes of Ngari, Dzang, of Kham, and of H'lassa or Wei. One of his descendants was H'latotori, who was born in 348 A.D., and he became king in 367 A.D. In the fortieth year of his reign (407) Buddhism was introduced into Tibet. **BUDDHA.**] The history of Tibet becomes more certain on the reign of king Srongdsan-Gambo, who was born in 17, and who ascended the throne in 629. He founded the town of H'lassa, where he held his residence, and he built a splendid palace on Mount Pudala. His reign is particularly remarkable for the invention, or rather introduction, of the Tibetan alphabet. Tongmi Sambhoda invented his alphabet, which is only a modification of the Sanscrit alphabet; and he made the first Tibetan grammar. Srongdsan-Gambo, who is also renowned as a legislator and administrator, died in 699. His successors carried on war with China, in which they were often successful; but in 21 Tibet was compelled to pay tribute to China. Under King Dharma, who ascended the throne in 901, Buddhism was almost destroyed, the king having adopted the Black Religion, or the Islam. Buddhism again became the dominant religion after Dharma had been murdered by a priest in 925.

In the beginning of the eleventh century each of the seven grandsons of king Bilamgur-Dzang became an independent prince; and from this event dates the entire decline of the kingdom of Tibet, the power of which had been already broken by the civil troubles which accompanied the persecution of Buddhism. One of the new kingdoms was Tangut, in the northern part of Tibet. Genghis Khan subdued all Tibet in 1206, according to Sanang Setsen, but Schmidt affirms that the Chinese and Mohammedan historians do not mention this fact. It is nevertheless a fact that Tibet was conquered and ravaged by the Mongols; and it was not before the end of the thirteenth century that the country recovered from the calamity of the Mongol war by the careful administration of Khublai-Khan. The easternmost parts of Tibet, which during the middle ages extended much farther to the east than they do at present, were gradually conquered by the Chinese in 1125, 1255, 1362, and 1371; and in 1727 another part of Tibet was incorporated with China, which has been mentioned above. Since the year 1720 all Tibet has been a vassal state of China, and Chinese garrisons are in its towns, and they watch the passes in the frontier mountains: the number of Chinese troops in Tibet amounts to 64,000 men. The tribute which Tibet pays to the emperor of China is composed of a great many different articles, which Ritter (iv., p. 233, 234) enumerates. The national government of Tibet is supported by a perfectly organized hierarchy. The name of the chief priests is Lama; and the Dalai-Lama is the first of them. The second is the Teshu, or Bogdo-Lama. The people are kind, tolerant, polite, and much more civilized than the Mongols, although they are generally poor. They live in a state of polyandry, that is, several men cohabit with one woman; but it is only brothers who are allowed thus to have one woman in common. Arts and literature are cultivated, but the works and the language of the Tibetans are almost unknown in Europe. The extreme north of Tibet is inhabited by nomadic Mongols, and Turkish hordes sometimes appear in the deserts of Khor and of Katchi. Both the Lamas are absolute princes in religious matters, but their sovereignty is checked by the authority of the emperor of China, who has two lieutenants or generals in Tibet, who control the Lamas, and who have the command of the army and the direction of temporal affairs. The high functionaries are almost all Chinese. A great number of officers are employed in the administration of the studs for breeding horses, and of the stores for the army.

(Ritter, *Erdkunde*, vol. iv.; Turner, *Embassy to the Court of Teshoo Lama in Tibet*; Moorcroft, in *Asiat. Journ.*, 1826, vol. xxi.; Klaproth, *Tubleaux Historiques de l'Asie*; Abel Remusat, *Recherches sur les Langues*

Tartares, vol. i.; Kircher, *China Illustrata*, cap. iv.; Sanang Setsen, *History of the Mongols*, ed. Schmidt; Schmidt, *Forschungen im Gebiete der Völker Mittelasiens.*)

TIBIA. [**SKELETON.**]

TIBIA'NA, a genus of Polypriaria. [**SERTULARIÆA.**]

TIBULLUS, A'LBIUS, lived in the time of Augustus, and was a friend and contemporary of Horace. He was of equestrian rank, and originally possessed considerable property, of which he lost the greater part (Tibull., i. 1, 19, &c.; iv. 1, 128, &c.), probably, as it is conjectured, in consequence of the assignments of lands among the veterans of Augustus; and this supposition is rendered still more probable by the circumstance that Tibullus never celebrates the praises of Augustus, like the other poets of his time. He was not however reduced to absolute poverty; the estate on which he resided at Pedum (Horace, *Ep.*, i. 4), a town between Præneste and Tibur, appears to have been his own, and to have descended to him from his ancestors. (Tibull., i. 10, 15, &c.) Here he passed the greater part of his time in the enjoyment of a quiet country-life, which had for him the greatest charms. He left it however to accompany his patron, Valerius Messalla, into Aquitania, and was present with him through the campaign, either in B.C. 28 or 27. (Tibull., i. 7, 9.) He afterwards set out with him to Asia, but was taken ill at Corcyra; but that he died at Corcyra, as is stated by some modern writers, is only a conjecture, unsupported by any antient authority, and is directly contradicted by what Ovid says. It appears from an epigram of Domitius Marsus (in Tibull., iv. 15), who lived in the age of Augustus, that Tibullus died soon after Virgil; and as Virgil died in B.C. 19, we may perhaps place the death of Tibullus in the following year, B.C. 18. It has been already mentioned that Tibullus was the friend of Horace; two poems have come down to us addressed to him by the latter (*Carm.*, i. 33; *Epist.*, i. 4). Ovid too laments his death in a beautiful elegy, from which it appears that his mother and sister were present at his death (*Amor.*, iii. 9).

It is difficult to determine at what time Tibullus was born; and we can but at best make some approximation to it. In the epigram of Domitius Marsus, already referred to, he is called *juvenis*, and Ovid deplors his untimely death. We must not however be misled by the expression *juvenis* into supposing that he was quite a young man, in our sense of the word, at the time of his death, since the antients extended the meaning of *juvenis* to a time which we consider to be that of mature manhood. Several circumstances tend to show that he could not be much less than forty at his death. Ovid speaks of Tibullus as preceding Propertius, and of Propertius as preceding himself; and as Ovid was born B.C. 43, we must place the birth of Tibullus a few years at least before that time. Again, Horace in the first book of his Odes addresses Tibullus as an intimate friend, which hardly allows us to suppose that Tibullus was a mere youth at the time. If Bentley's supposition is correct, that the first book of the Odes was published about B.C. 30 or 28, Horace was then about 35, and Tibullus may have been a few years younger. Moreover he does not appear to have been a very young man when he accompanied Messalla into Aquitania in B.C. 28 or 27. We may therefore perhaps place his birth at about B.C. 57. There are indeed two lines in Tibullus (iii. 5, 17, 18), which expressly assign his birth to B.C. 43, the same year in which Ovid was born; but these are, without doubt, an interpolation derived from one of Ovid's poems (*Trist.*, iv. 10, 6).

We have thirty-six poems of Tibullus, written, with one exception, in elegiac metre, and divided into four books. The first two books are admitted by all critics to have been written by Tibullus, but of the genuineness of the last two, considerable doubts have been raised. J. H. Voss and others attribute the third book to a poet of the name of Lygdamis, but the style and mode of treating the subjects resemble the other elegies of Tibullus, and there do not appear sufficient reasons for doubting that it is his composition. There are however stronger grounds for supposing the first poem in the fourth book, written in hexameters, not to be genuine. It differs considerably in style and expression from the other poems, and is attributed by some writers to Sulpicia, who lived under Domitian, by others to a Sulpicia of the age of Augustus; but we know nothing with certainty respecting its author. Of

the other poems in this book, almost all bear traces of being the genuine works of Tibullus.

The elegies of Tibullus are chiefly of an amatory kind. In the earlier period of his life Delia seems to have been his favourite, and afterwards Nemesis, and their names occur most frequently in his poems. Several of his elegies are devoted more or less to celebrating the praises of his patron Messalla, but these are the least pleasing parts of his works, for he does not appear to have excelled in panegyric.

Tibullus is placed by Quinctilian at the head of the Roman elegiac poets (*Iust. Orat.*, x. 1). His poems are distinguished by great tenderness of feeling, which sometimes degenerates into effeminacy, but they at the same time excite our warmest sympathies. He seems to have been of a melancholy temperament, and to have looked at things from a gloomy point of view; hence we find the subject of death frequently introduced, and the enjoyment of the present interrupted by dark forebodings of the future. He constantly describes the pleasures of a country-life and the beauties of nature, for which he had the most exquisite relish; and there is in these descriptions a naturalness and truthfulness which place him above his contemporary Propertius. His style too is not of the artificial character which distinguishes the elegies of Propertius; and his subjects are not, like the latter, mere imitations or translations of the Greek poets, but essentially original works.

Tibullus was formerly edited together with Catullus and Propertius, the earlier editions of which are mentioned under PROPERTIUS. The principal separate editions are by Brockhusius (Amst., 1708, 4to.), Vulpius (Padua, 1749, 4to.), Heyne (Leipz., 1777, 8vo., often reprinted, of which the fourth edition, containing the notes of Wunderlich and Dissen, appeared in 1817-19, 2 vols. 8vo., Leipz.), J. H. Voss (Heidelberg, 1811, 8vo.), Bach (Leipz., 1819, 8vo.), Goldbéry (Paris, 1826, 8vo.), Lachmann (Berlin, 1829, 8vo.), and Dissen (Göttingen, 1835, 2 vols. 8vo.), of which the two last contain the best text.

Tibullus has been translated into English by Dart (1720), and Grainger (1759). The most modern German translations are by J. H. Voss (Tübingen, 1810), Günther (Leipz., 1825), and Richter (Magdeburg, 1831). There are also French and Italian translations.

Respecting the life of Tibullus and the Roman elegy in general, the reader may consult with advantage Gruppe's 'Die Römische Elegie,' Leipz., 1838.

TIBUR. [TIVOLI.]

TIC DOULOUREUX. [NEURALGIA.]

TICFIELD. [TITCHFIELD.]

TICHO'DROMA. [CREPPER, vol. viii., p. 147.] Mr. Swainson places the genus in the subfamily *Troglodytinae* (family *Certhiidae*). (*Classification of Birds*.) Mr. G. R. Gray arranges it under the subfamily *Certhinae*, between *Clamatoris*, Temm., and *Geobates*, Sw. (*List of the Genera of Birds*.)

TICINO, CANTON OF (*Tessin*, in French and German), one of the cantons of the Swiss Confederation, is situated south of the Lepontine and Rhaetian Alps, and the surface slopes towards and merges in the great plain of Lombardy. It is the only Italian canton in the Confederation; and the inhabitants speak a Lombard dialect resembling the Milanese, and are Italian in their habits and manners: they are all Roman Catholics. The canton takes its name from the river Ticino, which has its sources in the great central group of the St. Gothard, flows southward along the Val Leventina, passes by Bellinzona, and then enters the Lago Maggiore at its northern extremity, and issues out of it at the opposite end by the town of Sesto in Lombardy. [PO. BASIN OF.] The canton is very mountainous, being intersected by several offsets from the great chain of the Lepontine and Rhaetian Alps. A number of valleys, large and small, lie between these offsets, the largest running nearly parallel to each other, and sloping towards the south. The principal valleys are—1, the Val Leventina, already mentioned, called Livinen Thal in German, which runs in a southern direction through the centre of the canton. East of the Val Leventina are—2, the Val Blegno, drained by the river of the same name, which flows from the southern slope of the Grisons Alps and joins the Ticino below Poggio; 3, the Val Moesa, which is a continuation of the Val Misocco, belonging to the canton of the Grisons; 4, the Val Morobbia, which

slopes down from the Iöri Berg on the frontiers of Val Leventina, and the water-drain of which falls into Ticino below Bellinzona. West of the Ticino are—5, the Val Maggia, one of the largest in the canton, which in its upper part is called Val Lavizzara; it is drained by the river Maggia, a rapid Alpine stream, which enters the Lago Maggiore near Locarno; 6, the Val Verzatica, which lies between the Val Leventina and the Val Maggia, and runs parallel to them, but is not so large as either: 7 and 8, the Val d'Ontenone and the Centovalli, west of the Val Maggia, which they both join at its lower end near the Lago Maggiore.

A ridge called Monte Cenere runs across the southern part of the canton of Ticino from north-east to south-west. It detaches itself from the Iöri Berg, and runs to the east bank of the Lago Maggiore. South of this ridge lies the basin of the lake of Lugano, which is thus separated from the rest or northern part of the canton, the waters of which run into the Lago Maggiore. The lake of Lugano, called also Ceresio, lies within the territory of the canton, with the exception of its north-east extremity, which stretches into Austrian Lombardy. Its form is very irregular: its length is about 20 miles, but the breadth is little more than a mile, except in front of the town of Lugano, where it is about two miles wide: the surface is about 800 feet above the sea, and the greatest depth is 500 feet. A number of trading-boats ply on the lake. Its outlet is formed by the river Tresa, which runs into the Lago Maggiore. The lake of Lugano separates the southern part of the canton, consisting of the district of Mendrisio and the circle of Ceresio, which form part of the district of Lugano, from the rest of the canton, which lies north of the lake.

Only the northern extremity of the Lago Maggiore belongs to the canton Ticino. [LAGO MAGGIORE.] The canton of Ticino is bounded on the north by the cantons of Uri, Valais, and the Grisons; on the east partly by the Grisons and partly by the province of Como in Austrian Lombardy, on the south by the province of Milan, and on the west by the Sardinian states. The surface of the canton of Ticino may be divided into five regions: 1, the region of the vine, the fig, and the peach, which includes the lower valleys and hills, and extends to the height of 2400 feet above the Lago Maggiore. The olive, orange, and lemon-trees thrive in some favoured spots. 2, the region of the chestnut, the pear, the apple, and cherry-tree, which rises about 1000 feet higher. 3, the region of the fir-tree, which rises to about 4500 feet above the level of the lake. 4, the Alpine pastures, which reach as high as 6000 feet. 5, the region of perpetual snow, which includes several Alpine summits between 8000 and 9000 feet high. There is consequently a great variety of climate as well as of productions in the canton, but the people are not generally speaking, as industrious as they might be. The horned cattle amount to about 52,000 head, the sheep to 23,000, goats to 75,000, and pigs to 27,000. The number of horses and mules is about 2000. Wolves and bears are hunted in the mountains. The rivers and lakes abound in fish. The principal articles of export are cattle, cheese, wine and fruits, hay, hides, and marble from the numerous quarries. Corn is imported from Lombardy. The manufactures are of no very great importance; they consist chiefly of coarse cloth, leather, platted straw, and tobacco. The silkworm is reared in some localities.

The population of Ticino amounted in 1833 to 1 The area is computed at about 1100 square miles. thousand people emigrate every year to various countries, as masons, porters, glaziers, choppers, and sellers of barometers. Many of them return after a year or two, bringing with them...

The canton is divided into eight districts, which are divided into circles. The districts are—1, Val Leventina, the northernmost part of the canton, lying between the high Alps; 2, Bellinzona, south of Locarno, at the northern extremity of the canton; 3, Locarno, at the northern extremity of the canton; 4, Val Maggia; 5, Val Blegno, on the borders of the canton of the Grisons; 6, Mendrisio, which stretches on both banks of the lake of Lugano; 7, Lugano, which stretches on both banks of the lake of the same name; 8, Mendrisio, south of Lugano, and which upon the lowland of Lombardy. The principal towns are—1, Lugano, a pretty-looking thriving town on the west bank of the lake of the same name, in a lovely situation, enjoying an Italian climate, has some fine...

with paintings by Luvini, a pupil of Leonardo da Vinci, some large mansions or palaces, as they are called in Italy, an hospital, a theatre, manufactories of silk, paper, wool, leather, and iron and copper works, and 4500 inhabitants. There are at Lugano many merchants, it being one of the great high roads between Switzerland and Italy. The fair, which is held in the month of October, is well attended. Lugano has a college under the direction of Fathers Somaschi, which is attended by more than one hundred pupils, several elementary schools, a school of drawing, a reading-room, and three newspapers in the Italian language. The country around Lugano is planted with vines, olives, and other southern trees, and full of country-houses. 2, Bellinzona, a walled town situated in the valley of the Ticino, on the high road of the St. Gotthard, has a very fine church, a college, an arsenal, and about 1500 inhabitants. There are several ruined castles of the middle ages in the neighbourhood. 3, Locarno, a small town with a fort on the Lago Maggiore, in a romantic situation, has several churches worthy of notice, a library, a theatre, and a government-house, and about 1000 inhabitants. It was once a thriving town with 5000 inhabitants, but many of the principal families, being ruined about the middle of the sixteenth century, for having embraced the doctrines of the Reformation, carried away their fortunes and their industry to Zürich and other places, and Locarno has never since recovered from the loss. The families of Orelli and Muralt, long established at Zürich, were originally from Locarno. 4, Mendrisio, a town of 1700 inhabitants, in a fertile country, and on the road to Como and Milan, has a college, several churches and convents, a printing-press, and some silk manufactories. 5, Capolago, at the southern extremity of the lake of Lugano, known for its printing-press, where many Italian works are printed to avoid the censorship of the government of Italy.

The valleys and highlands of which the canton of Ticino consists were inhabited in the ante-Roman times by the Ligurians and other aboriginal tribes of mountaineers, who were gradually reduced to subjection under Augustus. After the fall of the empire, the Longobards spread their dominion over the country. After several more vicissitudes in subsequent centuries, we find the country partly under the dominion of the Visconti, dukes of Milan, and partly under the feudal barons of Sax and other Rhetian lords, till the thirteenth century, when the Swiss of the Forest cantons conquered the Val Leventina, and soon after acquired Bellinzona and the country north of Mount Cenere by a formal cession from the barons of Sax. In the Italian wars of Louis XII., at the beginning of the sixteenth century, the Swiss obtained possession of Locarno, Lugano, and the rest of the country, which they formed into several Landvogteyen, or bailiwicks, some of which were under the exclusive dependence of the three Forest cantons, and others, such as Lugano and Locarno, were subject to the whole Swiss confederation. This state of things continued till the French invasion of Switzerland and the dissolution of the old confederation in 1798; the Cisalpine republic attempted to annex them by force to its territory, but the people of Lugano stood firm to their Swiss connection and expelled the Cisalpines, and took from them several standards, which are still seen in the church of San Lorenzo at Lugano. The distinction between sovereign and subject states having at the same time disappeared from Switzerland, the whole district was united into one canton of the new Swiss confederation by the name of Ticino, and as such it was acknowledged by Bonaparte in his Act of Mediation, and afterwards by the allied powers in 1814. In June, 1830, the canton of Ticino changed its constitution and adopted one by which the franchise is given to all natives of the canton not younger than twenty-five years, and who are burghesses of a commune and are possessed of real property or capital placed at interest of the value of at least 300 francs. The qualification required for members of the Great Council is four thousand francs. The Great Council, or legislature, consists of 114 members, elected for four years, and appoints the members of the Little Council, or Executive, as well as the judges of the various courts. In ecclesiastical matters the canton of Ticino depends partly on the bishop of Como and partly on the archbishop of Milan. The public revenue amounts to about 800,000 francs, derived chiefly from customs, stamps,

salt monopoly, and other taxes. There is a public debt of about four millions of francs. New codes have been lately framed, but much remains to be done to ensure the proper administration of justice in the canton, where venality, corruption, and infractions of the laws are evils of ancient date, and still of not unfrequent occurrence. The standard of the intellectual and moral condition of the people in general is considered to be lower than that of most other cantons of Switzerland. Yet the canton of Ticino has produced several distinguished men in various branches, such as Professor Soave, the Abbé Fontana, Francini, who is still living, the architects Fontana, Borromini, Maderna, Albertolli, and Bianchi, several sculptors and painters, several members of the family of Quadri, one of the principal families in the canton, and others. The people of Ticino are not deficient in intelligence, but they want instruction.

(Leresche, *Dictionnaire Géographique Statistique de la Suisse*; Francini, *Statistica della Svizzera*, and his more especial description of his native canton.)

TICINO, River. [PO, BASIN OF THE.]

TICKELL, THOMAS, an English poet of unblemished mediocrity. He was born in 1686, at Bridekirk in Cumberland. He was sent to Queen's College, Oxford, and he took his degree of Master of Arts in 1708. Two years afterwards he was chosen fellow of his college, and as he did not comply with the statutes by taking orders, he obtained a dispensation from the crown for holding his fellowship, till he vacated it by marrying in 1726.

His praises of Addison were so acceptable that they procured him the patronage of that writer, who 'initiated him,' says Johnson, 'into public affairs.' When the queen was negotiating with France, Tickell published 'The Prospect of Peace,' in which he raised his voice to reclaim the nation from the pride of conquest to the pleasures of tranquillity. This, owing perhaps to Addison's friendly praises of it in 'The Spectator,' had a rapid sale, and six editions were speedily exhausted.

On the arrival of King George I. Tickell wrote 'The Royal Progress,' which was printed in the 'Spectator.' Johnson says of it that 'it is neither high nor low,' a very equivocal criticism, considering Johnson's habitual tastes.

The translation of the first book of the 'Iliad' was the most important thing in Tickell's poetical career, having been published in opposition to Pope's; both appeared at the same time. Addison declared that the rival versions were both excellent, but that Tickell's was the best that was ever made. This praise ceases to surprise us when we find strong suspicions of Addison himself being the translator, as Pope, Young, and Warburton asserted. Dr. Johnson says, 'To compare the two translations would be tedious; the palm is now universally given to Pope. But I think the first lines of Tickell's were rather to be preferred; and Pope seems since to have borrowed something from them in connection with his own.'

During the dispute on the Hanoverian succession Tickell assisted the royal cause with his 'Letter to Avignon,' of which five editions were sold. Addison now employed him in important public business, and when, in 1717, he himself rose to be secretary of state, he made Tickell under secretary. On Addison's death, Tickell published his works, to which he prefixed an elegy on the author, which Johnson pronounces to be equal to any funeral poem for sublimity and elegance in the English language. Considering that we have the 'Lycidas' of Milton, this sounds oddly: on turning to this elegy, we are forced to admit, with Steele, that it is only 'prose in rhyme,' and very bad prose too. Such lines as—

'O'er my dim eyeballs glance the sudden tears.'

indicate the substitution of sound for sense, which writers like Tickell delight in. He never asked himself whether it was his eyeballs that were dim or whether tears glanced: all he knew was that dim, eyeballs, glance, tears, were common poetical phrases, and therefore suited his purpose. In 1725 Tickell was made secretary to the Lords Justices of Ireland, a place of honour in which he continued till his death, on the 23rd April, 1740.

(Johnson's *Lives of the Poets*; Campbell's *Specimens of British Poets*.)

TICKHILL. [YORKSHIRE.]

TICONDEROGA. [NEW YORK.]

TICOZZI, STEFANO, born in 1762, in the Val Sassina, in the province of Como, studied at Milan, and afterwards at Pavia, took priest's orders, and afterwards was appointed incumbent of a country parish near Lecco, in his native province. When the French invaded Lombardy in 1796, he and his brother Cesare Francesco, who was an advocate, favoured the revolutionary movement; but when the Austrians came back in 1799, Ticozzi was obliged to emigrate into France, and his brother was seized and sent prisoner to Cattaro. Ticozzi returned with the victorious French in the following year, and was appointed to several political offices under the Italian republic, and in 1806 was made sub-prefect of the department of the Piave under Napoleon's administration. In 1810 he published some disquisitions on monastic institutions: 'Degli Istituti Claustrali Dialoghi Tre,' 8vo., Belluno. He lost his situation on the fall of Napoleon, and retired to Milan, where he lived mainly by literary labour. He translated into Italian Sismondi's 'History of the Italian Republics,' Llorente's 'History of the Inquisition,' Agincourt's 'History of the Arts,' and other works. In 1818 he published his 'Dizionario dei Pittori dal Rinascimento delle Arti fino al 1800,' which he afterwards merged in his larger work, 'Dizionario degli Architetti, Scultori, Pittori, Intagliatori in rame e in pietra, Coniatori di Medaglie, Musicisti, Niellatori, Intarsiatori d'ogni Età e d'ogni Nazione,' Milan, 4 vols. 8vo. This is a really useful compilation, although not always exact about dates. He also published—1, 'Memorie Storiche,' Florence, 12 vols. 8vo., being a series of historical tales taken from the history of Italy in the middle ages; 2, 'Viaggi di Messer Francesco Novello da Carrara, Signore di Padova, e di Taddea d'Este, sua consorte, a diverse parti d'Europa,' 2 vols. 8vo., a work also illustrative of the same period; 3, a continuation of Corniani's biographical work, 'I Secoli della Letteratura Italiana,' down to our own times, and also a continuation of Bottari's collection of letters concerning the arts: 'Raccolta di Lettere sulla Pittura, Scultura, ed Architettura, scritti dai più celebri Personaggi dei Secoli xv., xvi., e xvii., continuata fino ad nostri Giorni,' 8 vols. 8vo.; and likewise a continuation of Verri's 'History of Milan: Storia di Milano del Conte Pietro Verri, dai suoi più rimoti Tempi fino al 1525, continuata fino alla presente Età,' Milan, 6 vols. 12mo., besides several dissertations upon various paintings and other minor works. He left unedited and unfinished a Life of Correggio, and 'A Treatise on the Art of distinguishing Copies from the Originals in Paintings.'

Ticozzi died in 1836. He married a granddaughter of the historian Giannone, by whom he had several children. (Tipaldo, *Biografia degli Italiani Illustri*.)

TIDE-MILL, a kind of water-mill in which the machinery is impelled by the alternate flow and ebb of the tide, instead of a stream continually flowing in one direction and at a nearly uniform level. Although tide-mills have never been brought into very common use in this or in other countries, they are by no means of recent origin. Beckmann, in his 'History of Inventions' (English edition of 1814, vol. i., p. 245), states that 'at Venice and other places there were mills which righted themselves by ebbing and flowing of the tide, and which every six hours changed the position of the wheels;' and he adds that 'Zanetti has shown, from some old charters, that such mills existed about the year 1044, and with still more certainty in 1078, 1079, and 1107.' Belidor, in his 'Architecture Hydraulique,' describes a tide-mill which was used at Dunkerque early in the last century, and attributes the invention to a master-carpenter of that place, named Perse. The expense attending the construction of tide-mills renders their adoption unadvisable in ordinary cases; but in many situations in which other mills are inapplicable, owing to the want of a sufficient current, or the necessity of avoiding any interference with the navigation of a stream, they may be erected with advantage. The water required for impelling their machinery may be admitted either from the side of a tidal river or immediately from the sea.

The late Dr. Gregory, in the second volume of his 'Treatise on Mechanics,' has devoted several pages to an account of various plans for obtaining a moving-power from the rising and falling of the tide: and, although he does not pretend to notice all the contrivances which have been proposed for the purpose, he divides the most im-

portant into four classes, varying from each other in the manner in which the motion of the water-wheel is effected, and applied to the machinery of the mill. In the first these the wheel turns in one direction while the tide is rising, and in the opposite direction while it falls: in the second the passage of the water is so regulated by sluices, that the wheel may always turn in one direction: in the third the wheel itself rises and falls with the tide, so as to preserve a tolerably equal degree of immersion, or a uniform head of water to act upon its float-boards; and in the fourth the axle of the wheel is permanently fixed at one level, and the wheel is so constructed as to revolve whether partially or completely immersed in the water. Of these conditions it is observed that the first and third have been usually exemplified in one machine, and that the second and fourth may readily be united in another. Dr. Gregory therefore treats of tide-mills under two heads, which are as follow:—1. Tide-mills in which the water-wheel rises and falls, and turns one way with the rising tide, and the contrary when it ebbs; and 2. Tide-mills in which the axle of the water-wheel neither rises nor falls, and in which that wheel is made always to revolve in the same direction.

Of the first of these varieties of tide-mill a good example is given from a corn-mill erected on the bank of the Thames, at East Greenwich, by Mr. Lloyd. The details of the mechanism are fully explained by Gregory, and also by Professor Barlow, in his 'Treatise on Manufactures and Machinery' in the 'Encyclopædia Metropolitana'; but the essential features of the contrivance may be briefly described. The side of the mill which is parallel to the river is forty feet wide, and is capable of being opened to the river by sluice-gates, which are carried down to low-water mark. Thus there is a water-way forty feet wide through the mill, by which the rising tide enters a reservoir, which covers about four acres of land. A smaller reservoir beyond the principal one affords the means for cleansing the whole apparatus by flushing or scouring at low-water. The water-wheel is a cylinder twenty-six feet long and eleven feet in diameter, with thirty-two float-boards, arranged in four divisions on the same principle as the divided paddle-wheel described under *Stream-Wheel*, vol. xxii., p. 509, in order to equalize the action of the water; and its axis is laid in a position parallel to the side of the river, so that it may be turned with equal facility by a stream flowing from the river into the reservoir, or from the reservoir into the river, according to the direction in which the tide is moving, and the positions of the sluices for admitting the head of water on one side, and allowing free vent for the tail-water on the other. At each end of the water-wheel is fixed, upon the same axis, a large bevil-wheel, from which the rotatory motion is communicated to an upright shaft, by means of two small horizontal bevil-wheels, called wallowers, either of which may be readily thrown into connection with the large wheel, while the other revolves freely, without coming in contact with it. Thus, by throwing the upper wallower into gear while the water-wheel revolves in one direction, and the lower one when its motion is reversed, the vertical shaft is made to revolve continually in one direction. The water-wheel, and the parts immediately connected with it, forming an apparatus of the weight of nearly twenty tons, are so mounted as to rise and fall by the action of the water, with very little attention; the bottom of the wheel-frame being connected with a kind of horizontal folding-door, which prevents any communication between the river and the reservoir, excepting in the required direction, whatever may be the position of the wheel-frame. The motion of the vertical shafts is communicated to the machinery of the mill by large horizontal wheels which turn with the shafts, but do not rise and fall with them. The weight of these horizontal wheels is supported by a series of friction-rollers resting upon a stationary part of the machinery, so that the vertical shafts, which are squared to fit the rollers, may slide freely up and down, although they cannot turn round without turning the wheels.

Of the means for effecting the objects required in the second of the above-mentioned varieties of tide-mills a very slight notice will suffice. Belidor describes a water-wheel contrived by M. Gosset and De la Daulie, in which the float-boards are hinged in such a manner that, while at the bottom of the wheel, they would press against

radii or arms of the wheel, and would present their surface to the action of the current, while in any other position they would, by turning on their hinges, present little more than their edges to it. Such a wheel will revolve completely immersed in water, although an ordinary water-wheel would be quite stationary. Gregory describes a bucket-wheel invented by Mr. Dryden, which will revolve with nearly equal force, whether the head of water above it is thin one or two feet of the top of its periphery, and the tail-water above the level of the axle, or the tail-water below the bottom of the wheel, and the head at a prominent elevation, but below the level of the axle. The boards, or divisions between the buckets, are all set at an angle with the radii of the wheel, and a small space is left between each float and the drum-boarding, or support of the wheel, to allow air to enter the buckets freely as they rise out of the water, and thereby to prevent the loss of power occasioned by the formation of a partial vacuum in the rising bucket, causing it, in the language of a miller, to 'suck up the tail-water.' The uniform motion of the wheel in one direction must be provided for by having two passages, provided with sluices, from the end of the water-way in which the wheel is placed; one passage leading to the river, and the other to the reservoir. By opening and closing the sluices alternately, the current, whether from the river to the reservoir or the reservoir to the river, may always be made to pass under the wheel in the same direction. M. Navier, in his notes to the new edition of Belidor, published in 1819 (in which tide-mills are treated of at considerable length), states that the former kind of wheel, hinged floats, had been tried successfully in Spain, by Dussaussoy, an officer of artillery. A work by Alton, on the tide as a moving-power for mills was published in the present century.

DEMAN, PHILIP, was a native of Nürnberg, where he was born in the year 1657. He studied first under a teacher named Nicholas Raes, with whom he remained several years, and was distinguished by his diligent application to his art, in which he attained great proficiency. In order however to improve his knowledge and taste, he went to Amsterdam to study the capital works of the great masters in the collections in that city.

Lairesse being at that time in great esteem at Amsterdam, Tideman resolved to place himself under his direction, and so gained the good opinion of his teacher by his ingenuous manners and his talents, that Lairesse conceived a great affection for him, and not only gave him the best instruction in the art, but employed him to assist in some important works on which he was engaged. In executing these works Tideman gave such evident proof of his ability that he soon obtained sufficient employment independent of Lairesse.

His compositions of fabulous history and allegory indeed were lively fancy, genius, and invention; inasmuch as in this respect his designs have been recommended as models to succeeding artists. Two of his capital compositions were Venus complaining to Jupiter of Juno's persecution of Æneas, and Juno applying to Æolus to destroy Trojan fleet. He died in 1715, at the age of fifty-eight, leaving a very great number of sketches and designs, which afford proofs both of his industry and the fertility of his invention.

(Kingston; Fuseli; Bryan.)

DES. [WAVE.]

DESWELL. [DERBYSHIRE.]

DORE, one of the Moluccas, is situated in the strait which divides the island of Gilolo from that of Celebes, and is traversed by 45° N. lat. and by 127° 25' E. long. It is about 21 miles in circumference. Near the southern extremity rises a mountain in the form of a cone, which is of volcanic origin. According to an estimate its summit may be about 4000 feet above the sea-level. The soil is composed of volcanic matter mixed with a considerable portion of vegetable mould, and abundantly watered by numerous rivulets which descend from the mountain: it is of great fertility, well cultivated, and produces rice in abundance. The sago-tree, as well as the clove and nutmeg-grow wild, though the Dutch have been at great pains to extirpate the trees, to secure the monopoly in the island. The island is very populous, and governed by a sultan, who also possesses the southern and middle portions of Gilolo, where the towns of Maba Wida, and Patang

P. C., No. 1542.

belong to him. He claims also the islands which are situated between Gilolo and Papua, namely, Wageow, Battanta, and Mysole, and lives in great state. The inhabitants are Malays and Mohammedans. At the time of Forrest's visit (1774) there were twenty-five mosques on the island.

This island was first visited by the vessels with which Magalhaens sailed round the globe in 1521, and the Spaniards loaded their ships with spices. They returned five years after, and found that the Portuguese had begun to establish their authority on the Moluccas. This gave rise to a war between the Spaniards and Portuguese, which ended, in 1529, by the emperor Charles V. renouncing his rights to the Moluccas, and receiving from the king of Portugal as an equivalent a loan of 350,000 ducats. Tidore was visited by Sir Francis Drake in 1579. In 1613 the Dutch took all the Portuguese settlements on these islands, and began to subject their sovereigns to a more strict obedience for the purpose of establishing their monopoly in the spice trade. They treated them for some time with great harshness. In 1778 the sultan of Tidore was dethroned and exiled to Batavia, but he was afterwards re-established. In 1796, when the British took Amboyna under Admiral Rainier, Tidore, being dependent on its government, fell also into their power: it was restored by the peace of 1801. In 1808 the sultan of Tidore, disagreeing with the Dutch at Amboyna, was expelled and obliged to fly to Papua. He applied to the English for assistance, and with their aid he recovered the greater part of his possessions. Soon afterwards (1810), the English having again taken possession of Amboyna, the sultan of Tidore became dependent on them; but in 1814 all the settlements on the islands of the Indian Archipelago which had been taken by the English, were again restored to the Dutch, and the sultan of Tidore is now dependent on the Dutch government.

(Forrest's *Voyage to New Guinea and the Moluccas*; Stavorus, *Voyages to the East Indies*.)

TIEDEMANN, DIETRICH, a German philosopher, was born the 3rd of April, 1748, at Bremervörde, near Bremen, where his father was burgomaster. He received his earliest education at home, and as he was scarcely allowed to have any intercourse with other children, his leisure hours were spent in reading. His father sent him in 1763 to Verden, where he was chiefly engaged in acquiring a knowledge of the ancient and some modern languages. After a stay of two years there he entered the Athenæum of Bremen. The system of education and the distinguished masters of this institution had great influence on young Tiedemann. It was here that he first conceived a love for philosophy and its history, and he began his philosophical studies by reading the works of Descartes, Locke, Helvetius, and Malebranche. After spending eighteen months at Bremen, he entered the university of Göttingen, with the intention of studying theology pursuant to his father's wish; but he continued the study of classical literature, mathematics, and philosophy. The study of philosophy raised in his mind strong doubts respecting certain main points of the Christian religion, which he was unable to overcome, and this led him to abandon the study of theology. He now tried jurisprudence, but notwithstanding the entreaties of his father to devote himself to some profession, he abandoned the study of the law also, and at last determined to follow his own inclinations, and to give himself up entirely to philosophy and its history. His father, dissatisfied with his son's conduct, refused to send him further means of subsistence. After having spent two years and a half at Göttingen, Professor Eyring proposed to him to take the place of tutor in a nobleman's family in Livonia, which Tiedemann accepted very reluctantly. In 1769 he entered his new situation, in which he remained four years, although he was shut out from all means of prosecuting his own studies, and had to devote almost all his time to his pupils. Nevertheless he found time to write a little work on the origin of language, a favourite topic with the philosophers of that time. It was published under the title, 'Versuch einer Erklärung des Ursprungs der Sprache,' Riga, 1772, 8vo. In the year following he returned to his native place, and after having spent a year there in studying various subjects which he had neglected in Livonia, he again went to Göttingen. His friend Meiners, who was now a professor in the university, introduced him to Heyne, who immediately made him a member of the philological seminary. The small income

VOL. XXIV.—3 K

derived from this institution and from private instruction, together with what he got by writing, enabled him to live in independence. His work on the Stoic philosophy appeared under the title of 'System der Stoischen Philosophie,' Leipzig, 1776, 8vo., with a preface by Heyne, who had recommended the publication. In this year Heyne was applied to in order to recommend a competent person for the professorship of ancient literature at the Carolinum in Cassel. Heyne recommended Tiedemann, and accepted the place for him without telling him of it. Tiedemann was delighted with the place, as it did not occupy too much of his time, and put him in connection with some of the most distinguished men in Germany. The study of philosophy and its history was now prosecuted with fresh zeal and vigour. The philosophical views which he had imbibed from the authors whom he had most studied tended towards materialism; but his friend Tetens vigorously counteracted them, and at length succeeded in turning his mind in a different direction. In the year 1786, when the Carolinum was broken up, Tiedemann was transferred with the other professors to Marburg. Here he lectured at different times on logic, metaphysics, the law of nature, on moral philosophy, psychology, universal history, history of philosophy, and sometimes also on some classical Greek writer. His lectures were very popular, and his kind disposition made his hearers look upon him more as a friend than as a master. Sometimes, especially during the last period of his life, he did not conduct himself with the calmness and dignity of a philosopher in combating the philosophy of Kant, to which he was opposed. He died in the midst of literary undertakings, after a short illness, on the 24th of May, 1803.

Tiedemann was beloved and esteemed by all who knew him. His life was spent in intellectual occupations and bodily exercise, of which he was very fond. His striking qualities were great self-control, cheerfulness, and a total absence of all pretension to literary superiority, although his works were extremely popular. Besides the works already mentioned, the following deserve notice:—'Untersuchungen über den Menschen,' Leipzig, 1777, &c., 3 vols. 8vo.; 'Griechenlands erste Philosophen, oder Leben und Systeme des Orpheus, Pherecydes, Thales, und Pythagoras,' Leipzig, 1780, 8vo.; 'Hermes Trismegistus Poemander, oder von der göttlichen Macht und Weisheit,' Berlin and Stettin, 1781, 8vo. This work is a translation from the Greek of Hermes Trismegistus. 'Geist der Speculativen Philosophie,' Marburg, 1791-97, 6 vols. 8vo. This work is a history of philosophy from the time of Thales down to Leibnitz and Christian Wolff, and is still useful for the materials which it contains. In style and arrangement it is deficient, and the author did not possess that critical and profound knowledge of philosophy which would have enabled him to perceive the organic connection and the necessary succession of the various philosophical systems. 'Theaetet, oder über das menschliche Wissen,' Frankfurt, 1794, 8vo.; 'Handbuch der Psychologie.' This work was edited after the author's death (Leipzig, 1804, 8vo.) by L. Wachler, who has prefixed to it a biographical memoir of Tiedemann. Besides these greater works Tiedemann wrote numerous smaller treatises and made many translations from the French: he also contributed papers to several periodicals. He is the author of some Latin dissertations, among which we may mention three programs: 'De Antiquis quibusdam Musei Fridericiani Simulacris,' Cassel, 1778-80, 4to.; 'Dialogorum Platonis Argumenta exposita et illustrata,' Bipont, 1786, 8vo.; 'Dissertatio de Quaestione: quae fuerit artium magicarum origo, quomodo illae ab Asiae populis ad Graecos atque Romanos et ab his ad caeteras gentes sint propagatae,' &c., Marburg, 1787, 4to.

(L. Wachler's Memoir of Tiedemann, in his *Handbuch der Psychologie*; Creuzer, *Memoria Diderici Tiedemanni*, Marburg, 1803, 4to.; and Jörden's *Lexikon Deutscher Dichter und Prosaisten*, vol. v., p. 76-86.)

TIEDGE, CHRISTOPH AUGUST, 'The Nestor of German Poetry,' and one who has now taken his place among the German classics, was born at Gardelegen in Altmark, Dec. 14th, 1752. His early prospects in life were by no means flattering, for the death of his father (Conrector at the Magdeburg gymnasium), in 1772, left him and a family of younger children in a very destitute situation. He completed however his legal studies at Halle; but notwithstanding the favourable opinion his talents

had acquired for him, he soon abandoned the profession for which he had prepared himself, and, in 1776, accepted the situation of private teacher in the Arnstadt family at Elrich in Hohenstein. The choice he had made proved a fortunate one, since it eventually led to connections and friendships that proved very advantageous. The immediate result of the course he had adopted was an intimacy with Gökings, Gleim, and other literary persons of that day, including the Baroness von der Recke. The friendships thus formed, laid the foundation of the prosperous and unruffled tenour of his after-life. On quitting Elrich he was invited by Gleim to reside with him at Halberstadt, which he continued to do until 1792, when he became private secretary to Domherr von Stedern; and though he died in the following year, Tiedge remained in the family upon the same footing during the life of Madame von Stedern, who, at her death, in 1799, secured to him a handsome competency. Being thus placed perfectly at ease in his circumstances, he travelled through the north of Germany, and visited Berlin, where it was his good fortune again to meet with Madame von der Recke, and the intimacy thus resumed continued for life. Though not in accordance with the ordinary usages of society, it was entirely free from the slightest suspicion of impropriety, and no more open to it than was the similar domestication of Cowper with Mrs. Unwin. This union, of a kind so exceedingly rare that no name has been invented for it, was that of two noble and pure minds, congenial in their tastes, and equally inspired with a feeling for poetry and those pursuits which, while they refine, also elevate our nature. The author of 'Urania' was as well shielded from scandal as was the author of the 'Task;' for although very different in form, the first-mentioned poem is, like the other, deeply tinged by religious sentiment; and its merits were more immediately recognised, for it went through several editions within a very short time from its first appearance in 1801.

In 1804 Tiedge and his female friend visited Italy, when they remained about two years; and of this journey we have an account from the pen of Madame von der Recke herself, 'Tagebuch einer Reise,' &c., 4 vols. 8vo., with a preface and notes by Böttiger, which, besides being very superior to the general class of tour-books, affords evidence of her being a zealous though candid Protestant, and a woman of strict piety. On their return to Germany, Madame von der Recke made Berlin, and afterwards left Dresden, her chief place of residence, passing the summer months at Teplitz or Carlsbad. The only change Tiedge henceforth experienced was that occasioned by the loss of his companion and benefactress, for she had taken care that her death (1833) should cause no change whatever in his outward circumstances, not even that of his residence, as she directed that her establishment should be kept up for him precisely as before, and that he should continue to enjoy the luxuries and comforts he had so long been accustomed to. Nor was her anxious solicitude for her friend's welfare useless; for so pre-eminently was Tiedge favoured beyond the ordinary lot, that he not only attained an unusual age, but nearly free from all infirmities of either body or mind. In his eighty-ninth year, says one who appears to have known him personally, he did not seem to be much more than sixty: the only alteration in him was, that for some years he could not take exercise on foot, or stir out except in a carriage or a wheel-chair. Even but a week before his death (March 8th, 1841) he was at the birth-day fête of one of his friends.

Soon after his death, his 'Life and Literary Remains' were given to the world by Dr. K. Falkenstein, in 4 vols. and an entire edition of all his works, in 10 vols., is now in course of publication. After his 'Urania' his most original production is perhaps his 'Wanderungen durch den Markt des Lebens,' 1836, which, like the other, may be said to be lyric-didactic, and similar in tendency, though of a less decidedly religious character, the seriousness of its moral precepts being relieved by the tone of playful irony which pervades many parts of the poem. His principal other productions are his 'Poetical Epistles,' in 'Elegeries,' and his 'Frauenspiegel,' all which have contributed to his reputation. The esteem in which the poet of 'Urania' is held is proved by the fact that, in honour of his memory, a 'Tiedge Verein,' or Tiedge Institution, has just been established at Dresden, one object of which, it appears, is to give a literary prize every five years, and

another to make some provision in their declining years for meritorious writers who may have fallen into adversity in consequence of age and infirmities.

(*Conversations Lexicon*; Wolff's *Encyclopädie*; *Morgenblatt*, 1842; *Litteraturblatt*, 1842.)

TIEL. [THIEL.]

TIEPOLO, GIOVANNI BATTISTA, a celebrated Italian painter of the eighteenth century, was born of a good family at Venice in 1693. Tiepolo, says Lanzi, was the last of the Venetians who acquired a European fame; celebrated in Italy, in Germany, and in Spain. He studied as a boy under Gregorio Lazzarini, painted at first in his manner, then imitated the style of Piazzetta, but attached himself eventually to that of Paul Veronese. Already at the age of sixteen he was known even out of Venice, and when still young he received invitations from various Italian cities to decorate their churches and their public buildings. His works in the north of Italy, both in oil and in fresco, are numerous: one of his first works of note was the Shipwreck of San Satiro, in the church of St. Ambrose, at Milan: he excelled chiefly in fresco, and his colouring and the folds of his draperies bear great resemblance to those of Paul Veronese. In Germany also Tiepolo executed several works: at Würzburg he painted the staircase and the saloon of the bishop's palace and two altar-pieces. He was afterwards invited by Charles III. to Spain, where, in Madrid, he painted the ceiling of the saloon in the new palace of the king, and the hall of the royal guard, by which he is said to have excited the jealousy of Mengs: he executed also the chief altar-piece in oil for the convent church of St. Paaschal, at Aranjuez. He died in Madrid in 1769 or 1770.

Tiepolo's style was slight and brilliant, yet his colouring was not glaring: the effect of his paintings was not produced by a recourse to bright colours, but by a judicious contrast of tints: his drawing was however feeble, yet this weakness was nearly concealed by the gracefulness of his attitudes. One of his best pictures in oil is the Martyrdom of St. Agatha, in the church of St. Antonio, at Padua. He etched several plates in a very free and spirited manner. He left two sons, Giovanni Domenico and Lorenzo, who were both painters: the elder etched some of his father's designs.

(Zanetti, *Della Pittura Veneziana, &c.*; Lanzi, *Storia Pittorica, &c.*; Fiorillo, *Geschichte der Malerey*, vol. ii.)

TIFLIS, or TEFLIS, the capital of the Russian province of Georgia, is in about 41° 43' N. lat., according to Capt. Monteith. In 1829 Mr. Federof, who accompanied Professor Parrot on his visit to Mount Ararat, found the latitude of the cathedral church to be 41° 41'. The longitude, according to Birdin, is 62° 34' E. from Ferro, or 44° 56' E. of London. Professor Parrot fixes the elevation of the stone bridge over the river Kur at exactly 1100 feet above the level of the Black Sea, and 31 feet above the mean level of the river. The Kur flows through a valley confined between two ranges of lofty mountains. The river enters the valley on the north, and 'at the extremity of the defile,' says Sir R. K. Porter, 'we saw the capital of Georgia, the massy towers of Tiflis rising on the precipitous and sublime banks of the Kur. But the effect produced here is of a deeper tinge. The town itself stands at the foot of a line of dark and barren hills, whose high and caverned sides gloomily overshadow it. Every house, every building within its walls, seems to share the dismal hue of the surrounding heights; for a deep blackness rests on all. The heavy battlements above, and the still majestic towers of the ancient citadel, the spires of Christian churches, and other marks of European residence, could not for some time erase the horrible dungeon impression of Asiatic dirt and barbarism received at first view of the town.' This was written in 1817.

The town is built on both sides of the river; but the larger portion, which is on the right or west bank, contains the houses of the wealthiest inhabitants, the great bazar, the principal squares, the finest churches, the public offices, the residence of the military governor, and of the commander-in-chief. This is the city properly so called, which again is divided into two parts, the old and new town. The limits of the old town are distinctly marked by the ruins of the antient fortifications. The new town extends to the north and west beyond these walls, and is distinguished from the old town by its new buildings in the European style and broader streets. The greater part of it

is called by the Georgians Goretuban, that is, the street out of the city. On the left bank is the extensive suburb Awlabar, a large caravansary, the barracks, a long row of houses inhabited by colonists from Southern Germany, and the fortress or citadel, built by the Turks in 1576. Toward the south the town leans against the chain of hills running from the south-west, on the summit of which are extensive ruins of a very antient fortress; its highest point at the western end of the old wall is 392 feet above the bridge; towards the west it rises higher, and from thence a small stream of water is conducted to the city the bed of which however is generally quite dry, except immediately after rain.

There are in Tiflis 15 Greek churches, 20 Armenian, and 2 Roman Catholic, some of which are very handsome. At a point where the river in its course through the town is hemmed in by rocks, a bridge of a single arch connects the town with the suburb of Awlabar. Here also are the ruins of an antient fort, church and houses, and about two miles farther from this side of the city stand the remains of another sacred edifice, on the summit of a lofty hill.

The houses in Tiflis are ill-built, and the streets so narrow that only one carriage can pass through the widest, and in the smaller streets there is scarcely room for a horseman. We must not however derive our ideas from the description of travellers, before or for a few years after the incorporation of Georgia with the Russian empire in 1801. The letters on the Caucasus and Georgia in 1812, written by the wife of a Russian envoy, speak of Tiflis as 'a mass of ruins, melancholy monuments of the ravages of Aga Mahomet and the Persians.' Sir Robert Ker Porter, in 1817, says that the governor was making great improvements, ordering all ruinous houses to be repaired, or entirely pulled down to make way for the erection of new ones. Among these improvements are the alterations in the great bazar, a long narrow winding street with shops on both sides, which he had caused to be entirely roofed in, with circular apertures to admit air and light. Professor Eichwald, who visited Tiflis in 1825 and 1826, and gives some particulars as late as 1829, says, 'Since the year 1801 tranquillity and security have returned, and are now firmly established in Georgia; civilization and commerce increase every year; since that time Tiflis has been improving in its appearance, is continually enlarged by new buildings, and its inhabitants have easily become familiar with all the comforts and even the luxuries of European life.' Professor Parrot, who was there in 1829, speaks in similar terms of the improvements introduced by the Russian government, but does not appear to be so satisfied with the introduction of European fashions.

One of the worst effects of the habitual intercourse with Europeans is the change that has been made in the manners of the women, who have thrown off their former Asiatic restraint, without adopting the reserve and decorum of European manners. This effect is much more decided among the lower orders, because the troops are quartered in the houses of the inhabitants, so that the customary line of separation between the women and the men could no longer be preserved. This circumstance greatly disgusts the Georgians, and they accordingly hailed with delight the judicious ukase of 1829, by which the proprietors of newly-built houses are exempted from receiving soldiers into their houses for six years.

Tiflis has been chiefly indebted for its celebrity to its warm baths, and its Georgian name, Tphilisk Alaki, is equivalent to 'warm town.' Parrot says, its name is derived from the Georgian word *ibili*, warm, which may have been given it either on account of the warm springs, or from the contrast of the great warmth of the climate of Tiflis, with the preceding residence of the Georgian kings at Mzchet, which lies on the declivity of the Caucasus, and has a much cooler temperature. The building of Tiflis and the transferring of the royal residence to this place were effected about the year 455, by king Waktang I., Gork-Aslan. (Klaproth, *Reise*, i. 715; ii. 164.) The mineral springs rise in considerable numbers at the south end of the city, between the strata of limestone, whence they are conducted into the cavern excavated in the solid rock, under one immense roof, divided into different apartments for the men and the women, into which not a ray of day-light is admitted, and which are merely rescued from total darkness by the faint glimmerings of a few

twinkling lamps struggling with the vapour arising from the water. The stench of the place and the disorder and filth which this meagre illumination renders visible, show, says Sir R. K. Porter, sufficient argument for the whole having been left in shade. He observes however that this want of order and cleanliness is not to be wondered at, since the entrance to the baths is free to all, and they crowd indiscriminately into every chamber. Sir Robert went to look at these baths, and was much surprised at being urged by a gentleman who accompanied him, to view the baths of the women, to which they were shown by an old woman. Their entrance did not seem to cause any alarm or astonishment. These waters are reputed to be very beneficial in rheumatic complaints and cutaneous disorders. No chemical analysis that can be depended on has yet been made. Professor Parrot, who examined 17 springs in four different baths, states the hottest at 37°, and the coolest at 19° Réaumur. There are only two springs below 30°; the temperature of the air in the shade, out of the baths, was from 15° to 16° Réaumur.

The situation of Tiflis would certainly make it one of the most delightful spots in the world, if the mountains between which it lies were not totally destitute of trees. They now only reflect the rays of the sun from the southern slope of the Caucasus (which also keeps off the cooling north and north-east winds), and thus produce in the valleys an oppressive heat, which often strikes like the glow of a furnace, and may perhaps be the cause of the bilious diseases prevalent here. The greatest heat during the residence of Professor Parrot was on the 28th of July, between 3 and 5 in the afternoon, 30° 4' Réaumur.

Though Professor Parrot states that 'notwithstanding the great advantages held out by the Russian government, which entices many persons from Russia and other countries, yet all, from the counsellor of state and general down to the clerk and common Cossack, often long in a few weeks to return to their native country as to a lost paradise'; yet the population is constantly and rapidly increasing. In 1820 it was stated not to exceed 15,000, and is now probably nearly 45,000, it having been 40,000 three years ago. Full one-half are Armenians, the remainder chiefly Georgians, that is, old Greek Christians, some Roman Catholics, and about a hundred Mohammedans. It is the residence of a Georgian patriarch, a Georgian metropolitan, and an Armenian archbishop. There are some manufactories of woollen, cotton, and silk.

Tiflis is most favourably situated to be the medium of an extensive trade between Europe and Asia, but it is only since the arrival of the Russians and the peace of Gulistan that there has been any direct commerce with Georgia. At first, and till the emperor Alexander granted free trade to the trans-Caucasian province, the Armenians merely purchased such goods as they wanted for common use at the fair of Nishnei Novgorod, to which they brought Persian goods, raw silk, Cashmere shawls, and pearls, which they exchanged for woollens, linen, printed calicoes, &c.: they often bought with ready money. In 1821 the Ukase granting freedom of trade was published, and commerce greatly increased. In 1823 a rich Armenian went to Odessa, where he purchased goods to the amount of many thousand pounds, which he disposed of to great advantage at Tiflis.

In the following year for the first time, six Armenian merchants came to Leipzig fair, where they purchased European manufactures to the amount of 600,000 rubles banco (25,000*l.*), which they conveyed through Galicia and the south of Russia to Odessa, where they were embarked for Redout Kale. In the year 1825 the value of the goods purchased at Leipzig was 1,200,000 rubles, and in the following year twice as much. Professor Eichwald says it is much to be wished that some European merchants might settle in Tiflis, and endeavour to improve the trade from that city to Persia, Afghanistan, Bokhara, and Tibet. Then the caravans from Cashmere, Cabul, and Tibet would no longer go to Tauris and Ispahan, but cross the Caspian Sea, and so up the Kur to Tiflis, whence the goods would be forwarded over the Black Sea to Europe.

The trade with Persia is very important, and is almost entirely in the hands of the Armenians of Bushire on the Persian Gulf and of Tiflis. The former trade chiefly to the East Indies: the greater part of the ships which navigate between Bushire and Bombay belong to the Imam of Muscat: only a few English ships come to Bushire. The

value of goods brought from India to Persia was two millions of ducats in 1826, and the exports from Persia to India 500,000 ducats. A considerable part of this trade takes the way of Basrah, from which place the manufactures of England and India go up the Euphrates and are disposed of in Turkey. The transit trade of foreign goods, which chiefly come from Leipzig, is an important branch of the trade between Tiflis and Persia. On the whole the commerce of Tiflis is increasing every year in extent and value.

(Sir Robert Ker Porter, *Travels in Georgia*, &c.; *Lettres sur le Caucase et la Géorgie*, 1812; Klapproth, *Reise in den Caucasus und Georgie*; Parrot, *Reise zum Iman-Berlin*, 1834; Eichwald, *Reise in den Kaukasus*, Stuttgart, 1837.)

TIGA, Professor Kaup's name for a genus of birds (*Chrysonotus*, Sw.; *Picus*, Hornf.), placed by Mr. G. R. Gray in the subfamily *Celeinae* (the 5th of the *Picidae*). [WOODPECKERS.]

TIGER-BITTERNS. [TIGRISOMA.]

TIGER-CATS. [TIGRIS.]

TIGERS. Although there is but one species of *Tiger*, properly so called, the *Tiger-Cats*, or those species of the genus *Felis* in which the tigrine character predominates, may be also treated of under the title before us.

The *Royal Tiger*, *Felis Tigris*, claims our first notice; and, although poets and poetical zoologists have joined to elevate the lion with his majestic mane to the sovereignty, it may be doubted whether the *Tiger* is not the type of the ferocious and blood-thirsty genus *Felis*.

Some have thought that this species was but little known to the ancients; but, we think, with no sufficient grounds. The numerous passages in which the word *Tigris* occurs in Greek and Latin authors, leave little room for doubting this knowledge; and Hyrcania, with which it is so frequently associated by the latter, is a locality well suited to what we now know of its geographical distribution.

When Aristotle (*Hist. Anim.*, viii. 28), treating of hybrid animals which spring from an intermixture of different races, says that people pretend that the dogs of India are bred from the tiger (*τῷ τίγρι*) and a bitch, not indeed at the first union, but at the third, we see no reason for considering the locality which he assigns to the *tigris*, as the opportunities which the conquests of Alexander gave him of knowing the animals of India, why the word should be rendered otherwise than by *Tiger* in our present acceptation of the term. 'The tiger,' writes Pliny (*Nat. Hist.*, viii. 18), 'is produced in Hyrcania and India;' following this up with an allusion to the 'famous swiftness' of the animal, and the strong attachment which the Tigress, notwithstanding accidental exception, is known to manifest for her cubs. *Agrius* (*Ibid.*, vi. 20), he notices the Indian nations as abounding in wild tigers. Of course he does not omit the story of the origin of the Indian dogs from the *Tiger*, and the rejection of the two first litters as too ferocious, while the third is taken and brought up. (*Ibid.*, viii. 40.) But, further, it is quite clear from the same authority, that the *Tiger* had been exhibited at Rome, and that Pliny and others well knew the distinction between that species and leopard and panthers. After mentioning the two last, and referring to an ancient decree of the senate that African bears should not be imported, but stating that the tribune Cneius Aufidius caused a plebiscitum to be passed which permitted their importation for the Circensian games, he states the numbers brought, first by Scaurus, and then by Pompey the Great and Augustus; adding that Augustus was the first who showed a tame tigress (*tigris*) in a den at Rome, upon the dedication of the Theatre of Marcellus during the consulship of Q. Tubero and Fabius Maximus; and that the emperor Claudius showed four together. (*Ibid.*, viii. 17.) Suetonius (*Aug.*, xliii.) states that it was the habit of Augustus, besides the exhibitions at the great spectacles, to show to the public any new thing that was brought over, 'ut rhinocerotem apud septem tigrim in scena; anguem quinquaginta cubitorum pro comitio:' and Dion remarks that the tigers were first seen by the Romans, and, as he thinks, by the Greeks also, were those sent by the Indians as gifts when they were suing for peace from Augustus. The emperor Philip on one occasion exhibited ten tigers, together with thirty-two elephants, ten elks, sixty lions, thirty

leopards, ten hyænas, one hippopotamus, one rhinoceros, forty wild horses, twenty wild asses, and numbers of deer, goats, antelopes, and other beasts; the brutal exhibition being crowned by the mortal combat of two thousand gladiators.

Gordian III. also exhibited ten tigers, and they were present in the shows of Antoninus and Elagabalus. Aurelian, in his triumph over Zenobia, showed four, together with a giraffe, an elk, and other rare animals.

Oppian cannot be mistaken when he writes (*Cyneg.*, iii. 130),

Παρδάλιες τε θοαί, καὶ τίγριες ἀιολόνωτοι ;

for here we have leopards and tigers in the same line, and the epithet *αιολόνωτος* (having a variegated back) is quite applicable to the latter.

The Latin poets abound with allusions to the *Tigris*, that, in most instances, can hardly be allotted to any animal but the Royal Tiger; for, though Virgil, in his fourth 'Georgic' (l. 407), applies the epithet 'atra' (black) to 'tigris' in the passage where Cyrene is warning Aristæus as to the forms into which Proteus will transform himself, the word, evidently, does not there allude to colour, but to ferocity. In the fourth 'Æneid,' Dido, in her exclamation against Æneas, says,

— Duris genuit te cantibus horrens
Caucasus, Hyrcanæque admorunt ubera tigres.*

The tigers of Bacchus may be considered more doubtful. In the 'Gemma et Sculpturæ Antiquæ' there is a representation of a large female *Felis* with the thyrsus from a carnelian (corniola), with the superscription, 'Tigre di Bacho;' but though the figure, generally, might pass for a Tiger, the tail of the animal is terminated by a shaggy tuft, and no tiger's tail is. Claudian comes much nearer to the mark where he describes Iacchus as marching crowned with ivy, and clad (in the skin) of the Parthian Tiger. When Virgil describes Orpheus, as 'mulcentem tigris' as 'soothing tigers' (*Georg.* iv., l. 510), and Horace, with nearly the same thought, addresses Mercury,

* Tu potes tigris comiteaque sylvas
Ducere†

(*Carm.* iii., *Ode* ii.); and again, in his epistle to the Pisos ('De Arte Poeticâ,' l. 393), says of Orpheus,

* Dictus ab hoc lenire tigris, rabidosque leones ;†

they make the Tiger personify the greatest ferocity, and they certainly could not have chosen a more apt representative.

Martial speaks of the Tiger in the time of Titus and Domitian. (*Spect.*, Epig. 18, and lib. i., Epig. 105.)

To conclude this branch of the subject, we shall advert to one more literary proof, and one piece of pictorial evidence: and we think that no doubt can exist that, although the Royal Tiger was not so abundant in the Roman shows, particularly the earlier ones, as the leopard and the panther, its form and colouring, as distinguished from the other great cats, were as well and familiarly known to that people.

Pliny, in his chapter 'De Atlantis Arboribus et Cedrinis Mensis,' &c. (*Nat. Hist.*, xiii. 15), speaking of the grain or pattern of these tables, says that where it was oblong or lengthened, they were called tigrine, but where it was wreathed or curled (*intorto*), they were termed pantherine.

The pictorial evidence (so to speak) was furnished by the mosaic found at Rome near the arch of Gallienus. In this work of art, executed not improbably in commemoration of the exhibition of Claudius above noticed, four Royal Tigers, each devouring his prey, are well represented.

Our Zoological Societies and menageries have so increased in number during a long period of peace, that it becomes almost superfluous to describe a form so well known. But as a description of an animal holding so important a rank in the animal kingdom may be expected, we select that of Mr. Bennett, who, in the *Tower Menagerie*, remarks that the Tiger, closely allied to the Lion in size, in power, in external form, in internal structure, in zoological characters, in prowling habits, and in sanguinary propensities, is at once distinguished from it, and from every other of their common genus, by the peculiar markings of its coat. 'On a ground which exhibits in different individuals various shades of yellow,' says Mr. Bennett, 'he is elegantly striped by a series of transverse black bands or bars, which occupy the sides of his head,

neck, and body, and are continued upon his tail in the form of rings, the last of the series uniformly occupying the extremity of that organ, and giving it a black tip of greater or less extent. The under parts of his body and the inner sides of his legs are almost entirely white; he has no mane; and his whole frame, though less elevated than that of the Lion, is of a slenderer and more graceful make. His head is also shorter and more rounded.'

There is a paler variety, almost approaching to whitish, and with the stripes visible only in particular lights: this has been exhibited in this country. According to Du Halde, the Chinese Tiger (*Lou-chu*, or *Lau-hu*) varies in colour, some being white, striped with black and grey.

The size of the Tiger varies also; but the dimensions of the form, when fully developed, are, if we are to give credit to some accounts, the veracity of which has not been impugned, most formidable. Buffon notices an individual which was (tail included) 15 feet long; and it is on record that Hyder Ali presented to the Nabob of Arcot one which measured 18 feet in length. The average height varies from about four feet to about three feet, and the length from about eight or nine feet to six.

Geographical Distribution.—Asia only, and not the south of Africa, as Buffon erroneously states; but authors generally agree that the Tiger is now rarely, if ever, met with on this side of the Indus. It is said to be found in the deserts which separate China from Siberia, and as far as the banks of the Ob; and in the south of China, and the larger East Indian Islands (Sumatra, for instance), it is common. Pennant states that it is found as far north as China and Chinese Tartary, and about Lake Aral and the Altaic Mountains. 'It inhabits Mount Ararat,' says the same author in continuation, 'and Hyrcania, of old famous for its wild beasts; but the greatest numbers, the largest, and the most cruel, are met with in India and its islands. In Sumatra the natives are so infatuated that they seldom kill them, having a notion that they are animated by the souls of their ancestors. They are the scourge of the country; they lurk among the bushes on the sides of rivers, and almost depopulate many places. They are insidious, blood-thirsty, and malevolent, and seem to prefer preying on the human race.' Hindustan may be considered the head-quarters of this destructive animal; there it is that he reigns unawed even by the lion, with which he disputes the mastery, and which is comparatively rare in that peninsula.

Habits, Chase, &c.—The bound with which the ambushed tiger throws himself upon his prey is as wonderful in its extent as it is terrible in its effects. Pennant justly observes that the distance which it clears in this deadly leap is scarcely credible. Man is a mere puppet in his gripe; and the Indian buffalo is not only borne down by the ferocious beast, but carried off by his enormous strength. If he fails, it has been said that he makes off. This may be true in certain instances, but in general he does not slink away, but pursues the affrighted prey with a speedy activity which is seldom exerted in vain. This leads us to the observation of Pliny celebrating its swiftness,* for which the Roman zoologist has been censured, most unjustly, apparently; nor is he the only author among the ancients who notices its speed. Oppian (*Cyneg.*, i. 323) speaks of the swift Tigers as being the offspring (*γενέθλην*) of the zephyr. 'Pliny,' says Pennant, 'has been frequently taken to task by the moderns for calling the Tiger "animal tremendæ velocitatis;" they allow it great agility in its bounds, but deny it swiftness in pursuit. Two travellers of authority, both eye-witnesses, confirm what Pliny says: the one indeed only mentions in general vast fleetness; the other saw a trial between one and a swift horse, whose rider escaped merely by getting in time amidst a circle of armed men. The chase of this animal was a favourite diversion with the great Cam-Hi, the Chinese monarch, in whose company our journeyman Mr. Bell, that faithful traveller, and the Père Gerbillon, saw these proofs of the tiger's speed.†

In the 'Ἐκατοντάς, seu Centuria Imaginum Hieroglyphicarum' (c10. loc. xxiii.) is a wood-cut (here copied) that may refer to such a scene.

Ferocious as the Tiger is, and much as it may deserve the odium heaped upon it, the general chorus of the herd of authors who eulogize 'the courage, greatness, clemency, and generosity' of the lion, contrasting it with the unpro-

* *Ante*, p. 436.

† Bell's 'Travels,' ii. 91; Du Halde, ii. 242.



Tiger pursuing a man on horseback.

voked ferocity, unnecessary cruelty, and poltroonery of the Tiger, becomes ridiculous, though led by such names as Buffon and Pennant. The lion has owed a good deal to his mane and his noble and dignified aspect; but appearances are not always to be trusted. Mr. Barrow, with much more truth, characterizes the king of beasts as powerful but treacherous. 'Happy,' says that traveller, 'for the peasantry, the Hottentots, and those animals that are the objects of its destruction, were its noble and generous nature, that so oft has fired the imagination of poets, realized, and that his royal paw disdained to stain itself in the blood of any sleeping creature! The lion, in fact, is one of the most indolent of all the beasts of prey, and never gives himself the trouble of a pursuit unless hard pressed by hunger.'

Pennant gives the following as an instance, after stating that there is a sort of cruelty in the devastations of the tiger unknown to the generous lion, as well as poltroonery in its sudden retreat on any disappointment: 'I was informed by very good authority, that in the beginning of this century some gentlemen and ladies, being on a party of pleasure under the shade of trees, on the banks of a river in Bengal, observed a tiger preparing for its fatal spring; one of the ladies, with amazing presence of mind, laid hold of an umbrella and furled it full in the animal's face, which instantly retired, and gave the company an opportunity of removing from so terrible a neighbour.'

This is a very pretty story, and the heroine deserves all praise, though it is not very clear what is meant by *furling* an umbrella, so as to make the alleged act square with the context, and the tiger was undoubtedly very polite. But tigers spring from a considerable distance, 15 or 20 feet, and from ambush; and we suspect that a cross-examination of the parties concerned might have slightly damaged the anecdote. Granting, however, that this bold lady walked up to a crouched tiger, and suddenly opened an umbrella in its face (for that, we presume, is the action meant), we may easily conceive that the surprise may have utterly confounded him; but this is not poltroonery. Indeed the same author immediately afterwards gives a tolerable proof of the animal's daring: 'Another party had not the same good fortune: a tiger darted among them while they were at dinner, seized on one gentleman, carried him off, and he never was more heard of.'

But there is another story, a very sad one, which is pregnant with proof of the tiger's hardihood; we allude to the distressing death of Sir Hector Monro's son. Mr. Wood (*Zoography*) relates the horrible occurrence in a few words:—

'This unfortunate gentleman,' says Mr. Wood, 'accompanied by three of his friends, went on shore, December 22, 1792, on Sawgar Island to shoot deer. They continued their sport till the afternoon, when they retired to the edge of a jungle to refresh themselves; where they had not remained long before one of the party, who was leaving the rest to shoot a deer, heard a dreadful roar, and saw a large tiger spring on poor Monro, and rush with him into the jungle with the greatest ease, dragging him through everything that obstructed his course, as if all were made to yield to his amazing strength. All that his companions could do to rescue their friend from this shocking situation was to fire at the tiger; and it is evident that their shots took place, since, in a few minutes after, Mr. Monro staggered up to them covered with blood, and fell. Every medical assistance that the ship afforded was procured for him immediately, but in vain: he expired in the course of twenty-four hours in the greatest agonies. His head was torn, his skull fractured, and his neck and shoulders covered with wounds made by the claws of the savage

beast. It is worthy of observation, that neither the fire that was blazing close to them, nor the noise and laughter which it seems they were making at the time, could divert this determined animal from his purpose. Contrast this with the story told by Sparrman, of the adventure of Jacob Kok, of Zee-koe-rivier [*LION*, vol. xiv., p. 32.], in which the Lion, though warmed with the ardour of chasing the terrified Jacob, was daunted when, in his extremity, he faced the infuriated beast from a small heap of stones, presenting the butt-end of his shotless gun to his brave enemy. This was poltroonery, if such a term be applicable to beasts.

But if any doubt as to the courage of the tiger be entertained, Father Tachard's account of a combat between that beast and two elephants at Siam will be sufficient proof. He relates that a lofty bamboo palisade was erected, occupying an area of about 100 feet square. Into this enclosure two elephants were introduced with their heads and trunks shielded by a kind of mask. A large tiger was now brought from its den, and held with cords till one of the elephants approached and inflicted two or three blows on its back with his trunk, so heavily laid on that it fell stunned, as if dead. Then they loosed the tiger. No sooner did he recover than he sprang with a dreadful roar at the elephant's trunk stretched out in act to strike him; but the wary elephant drew up his trunk, and receiving the tiger on his tusks, hurled him into the air. This checked the fury of the tiger, as it well might, and he gave up the contest with the elephant; but he ran several times round the palisade, frequently springing at the spectators. Afterwards three elephants were set upon him, and they in turn dealt him such heavy blows that he again lay senseless, and would have been killed, if the combat, as it is most incorrectly called, had not been stopped. Nothing could be more unfair towards the tiger than the whole of the proceeding; and we will venture to say that no quadruped except a British bull-dog could have shown more pluck to use a vulgar but expressive term, than this shamefully treated beast.

The older authors generally state that after the tiger has secured its prey it plunges its head into the body of the animal up to its very eyes, as if to satiate itself with blood till the corpse is exhausted, before it tears it in pieces. The best modern accounts tend to prove that the tiger is not more bloodthirsty and has no more blood-sucking propensities than the other great cats; and that this blood-drinking habit is grossly exaggerated.

The tigress brings forth three or four, or four or five cubs at a time; and she is a very fond mother, braving every danger for them, and furiously attacking man and beast in their defence. The antients knew this well. See *Martha* (lib. iii., Epig. 44):—

'Non tigris catulis citata raptis,' &c.;

and Juvenal (*Sat.*, vi.):—

'Tunc gravis illa viro, tunc orbe tigride perior:'

and though it is on record that a tigress in modern times devoured her cub, one should remember that this unnatural act was done in captivity, and that rabbits, sows, and cats have done the same. But that in a state of nature the maternal feeling is very strong in the tigress, there can be no doubt. Captain Williamson, for example, relates that two tiger-cubs were brought to him when he was stationed in an Indian district. The country-people had found four in the absence of the tigress. The two brought to the captain were put in a stable, where they made a loud noise for several nights. The bereaved mother arrived at last, replying to their cries with fearful howling, and the cubs were let loose under the apprehension that the infuriated tigress might break in. In the morning it was found that she had carried them away.

For an account of the *hybrids* between the Lion and Tiger, see the article *LION*, vol. xiv., p. 35.

Various devices have been put in requisition to take or annihilate this destructive quadruped, and we shall mention one or two of them before we advert to the chase of the animal upon a grander scale. Ten rupees were formerly offered by the East India Company for every tiger destroyed within the provinces where their power and influence extended; a small reward, but sufficient, compared with the depredations of the animal, to stimulate the poorer classes to destroy it.

A kind of spring-bow was formerly laid in its way as:

discharged a poisoned arrow, generally with fatal effect, when the animal came in contact with a cord stretched across its path, and this method is said still to be in use in some places. Again, a heavy beam was suspended over the way traversed by the tiger, which fell and crushed him on his disengaging a cord which let the beam fall. A Persian device is said to consist of a large spherical strong interwoven bamboo cage, or one made of other suitable materials, with intervals throughout, three or four inches broad. Under this shelter, which is picketed to the ground in the tiger's haunt, a man provided with two or three short strong spears takes post by night, with a dog or a goat as his companion, wraps himself in his quilt and goes to sleep. A tiger arrives, of whose presence the man is warned by the dog or the goat, and generally, after smelling about, rears himself up against the cage, upon which the man stabs him resolutely with his short spear through the interstice of the wicker-work. It seems ludicrous to talk of taking a tiger with birdlime; but it is said to be so captured in Oude. When a tiger's track is ascertained, the peasants, we are told, collect a quantity of leaves resembling those of the sycamore, and common in most Indian underwoods; these they smear with a kind of birdlime which is made from the berries of an indigenous and by no means scarce tree, and strew them with the adhesive substance uppermost in some gloomy spot to which the tiger resorts in the heat of the day. If he treads on one of the limed leaves, he generally begins by trying to shake it from his paw, and not succeeding, proceeds to rub it against his jaw in order to get rid of it. Thus his eyes and ears become agglutinated, and the uneasy animal rolls, perhaps among many more of the smeared leaves, till he becomes enveloped: in this state he has been compared to a man who has been tarred and feathered. The tiger's irritation and uneasiness find vent in dreadful howlings; on which the peasants hasten to the spot, and shoot him without difficulty.

The plan of the box-trap and looking-glass, a device to be found in ancient sculpture according to Montfaucon, is said to be practised among the Chinese at the present day.

So much for the trapping of the Tiger. The tiger-hunt is perhaps the grandest and most exciting of wild-sports. Upon such occasions the whole neighbourhood is on the move, and two hundred elephants have been known to take the field; from ten to thirty of these gigantic animals, each carrying sportsmen armed with rifles, have not unfrequently started for the jungle.

Captain Mundy gives a short but spirited description of a tiger-hunt. The party, he tells us, found immense quantities of game, wild-hogs, hog-deer, and the Neilghie;* they, however, strictly abstained from firing, reserving their whole battery for the nobler game of which they were in pursuit. They had to pass through a thick forest, and the author gives a very interesting description of the power and dexterity of the elephants in overthrowing trees to make a road:—'On clearing the wood,' says he, 'we entered an open space of marshy grass, not three feet high; a large herd of cattle were feeding there, and the herdsman was sitting singing under a bush, when, just as the former began to move before us, up sprang the very tiger to whom our visit was intended, and cantered off across a bare plain dotted with small patches of bush-jungle. He took to the open country in a style which would have more become a fox than a tiger, who is expected by his pursuers to fight and not to run, and as he was flushed on the flank of the line, only one bullet was fired at him ere he cleared the thick grass. He was unhurt; and we pursued him at full speed. Twice he threw us out by stopping short in small strips of jungle, and then heading back after we had passed; and he had given us a very fast trot of about two miles, when Colonel Arnold, who led the field, at last reached him by a capital shot, his elephant being in full career. As soon as he felt himself wounded, the tiger crept into a close thicket of trees and bushes, and crouched. The two leading sportsmen overran the spot where he lay, and as I came up I saw him, through an aperture, rising to attempt a charge. My mahout had just before, in the heat of the chase, dropped his ankors, or goad, which I had refused to allow him to recover, and the elephant being notoriously savage, and further irritated by the goading he had undergone, became consequently unmanageable; he appeared to see the tiger

as soon as myself, and I had only time to fire one shot, when he suddenly rushed with the greatest fury into the thicket, and falling upon his knees, nailed the tiger with his tusks to the ground. Such was the violence of the shock, that my servant, who sat behind, was thrown out, and one of my guns went overboard. The struggles of my elephant to crush his still resisting foe, who had fixed one paw on his eye, were so energetic, that I was obliged to hold on with all my strength, to keep myself in the houdah. The second barrel too of the gun, which I still retained in my hand, went off in the scuffle, the ball passing close to the mahout's ear, whose situation, poor fellow, was anything but enviable. As soon as my elephant was prevailed upon to leave the killing part of the business to the sportsmen, they gave the roughly used tiger the coup-de-grace. It was a very fine female, with the most beautiful skin I ever saw.'

In the 'Asiatic Annual Register,' for 1804, a gentleman who had been present at the killing of above thirty tigers gives an account of a hunting-party of the Nawab Asuf-ud-Dowlah. After describing the immense cavalcade of the Nawab, he says:—'The first tiger we saw and killed was in the mountains; we went to attack him about noon; he was in a narrow valley, which the Nawab surrounded with above two hundred elephants; we heard him growl horribly in a thick bush in the middle of the valley. Being accustomed to the sport and very eager, I pushed in my elephant; the fierce beast charged me immediately; the elephant, a timid animal, turned tail, and deprived me of the opportunity to fire. I ventured again, attended by two or three other elephants; the tiger made a spring, and nearly reached the back of one of the elephants on which were three or four men; the elephant shook himself so forcibly as to throw these men off his back, and they tumbled into the bush; I gave them up for lost, but was agreeably surprised to see them creep out unhurt. His Excellency was all this time on a rising ground near the thicket, looking on calmly, and beckoning to me to drive the tiger towards him. I made another attempt, and with more success; he darted out towards me on my approach, roaring furiously and lashing his sides with his tail. I luckily got a shot and hit him; he retreated into the bush, and ten or twelve elephants just then pushed into the thicket, alarmed the tiger, and obliged him to run towards the Nawab, who instantly gave him a warm reception, and with the assistance of some of his omras, or lords, laid the tiger sprawling on his side. A loud shout of *wha! wha!* proclaimed the victory.'

There is in Bishop Heber's 'Journal' a most graphic description of a tiger-hunt, but our limits will not permit us to indulge in more of these stirring accounts.

Those who have represented the tiger as untameable have no ground for the assertion. It is as capable of being tamed, and of attachment, even to fondness, for its keeper, as any other animal of its kind. We have seen many instances of this mutual good understanding between the man and the beast, and Mr. Bennett mentions a remarkable example in his 'Tower Menagerie.' A tigress of great beauty, in the Tower when he wrote, and scarcely a year old, had been, during her passage from Calcutta, allowed to range about the vessel unrestricted, and had become perfectly familiar with the sailors, showing not the slightest symptoms of ferocity. On her arrival in the Thames, the irritation produced by the sight of strangers instantly changed her temper, rendering her irascible and dangerous. So sulky and savage was she, that Mr. Cops, who then kept the lions in the Tower, could hardly be prevailed on by her former keeper, who came to see her, to allow him to enter her den; but as soon as the tigress recognised her old friend, she fawned on him, licked him, caressed him, and manifested the most extravagant signs of pleasure; and when, at last, he left her, she cried and whined for the remainder of the day. The tame tigers of the mendicant priests, or Fakirs, of Hindustan, are well known.

But whilst there can be no doubt of the tameable qualities of the tiger, and indeed of all the great cats, they are not to be incautiously trusted. The natural disposition is always ready to break out; and the mildest of them, though

—'Ne'er so tame, so cherish'd, and lock'd up,
Will have a wild trick of his ancestors.'

Thus Bontius states that, in 1628, a tiger at Batavia, which had been brought up from a cub, and accustomed

* Nyl-G'au. [ANTHROP, vol. II, p. 76.]

to men all its life, escaped from its cage, fastened on a horse which was feeding near, and killed it; so that the citizens rose upon the tiger with fire-arms and slew it in its turn, to prevent further mischief.

We conclude this part of our sketch with the account given by John Mason, who formerly kept the beasts in Exeter Change, to Mr. Wood, of his fearful encounter with one of these captives.

About the year 1802 a tiger had been purchased by Mr. Alpey to send to the emperor of Germany, and placed in the Tower, there to remain for a few days, till the ship destined to convey the animal abroad was ready. The beast was confined in a large, sufficiently ventilated, wooden case, lined with iron hoops, some of which he ripped off during the first night of his confinement, and gnawed the case partly through. This being perceived, the next day the case was repaired by the addition only of a strong piece of wood nailed on the outside. 'The consequence,' says Mr. Wood, 'might well be expected. The tiger renewed his efforts, and in the course of the following night made his escape, and sprung upon a wall ten feet high, where he remained till Mason came in the morning. The fear of losing such a valuable animal induced this poor fellow, for a reward of ten guineas, to hazard his life in an attempt to secure the tiger. For this purpose he engaged a sergeant and some other persons to assist him, whom he placed in a room, the door of which opened upon the leads, from whence he could reach the animal. He then provided himself with a strong rope, one end of which he gave through the window to his companions, and with the other, having a running noose upon it, he slowly approached the tiger, and threw it over its neck. This was the critical moment: the people within were directed to pull the rope and secure the beast: unfortunately the noose slipped off, and the enraged animal immediately sprung upon the keeper, fixing his teeth into the fleshy part of his arm, and tearing his breast and hand in a dreadful manner with his claws. In this shocking situation the poor man lay under the tiger; while the sergeant cut a bullet into four parts, and, having loaded his musket, he fired through the window at the animal; who, the moment he received the shot, quitted his hold; and, after staggering for a few minutes, expired. The bullet however which destroyed the tiger had nearly been equally fatal to the man, one of the quarters having glanced against his temple, and deprived him of all sense and motion for a considerable time. Nevertheless, after keeping his bed a fortnight, he gradually recovered, and is now (1807) perfectly well, though he will carry the marks of his enemy about with him as long as he lives.' (*Zoography*, vol. i.)



Royal Tiger.

In the East the tiger is associated emblematically with power. Thus the Chinese mandarins covered their seats of justice with its skin. In pl. 17 of the atlas to Sir George Staunton's 'Embassy to China,' representing a military post, two swordsmen are habited and shielded so as to exhibit a tigerine aspect. The tiger soldiers of Hyder Ali and Tippoo Saib were among the choicest of their troops. The tiger's head, gorgeous with jewels, that formed the principal ornament of the throne of Hyder and Tippoo, and was taken by the British among the spoils of the latter at Seringapatam, is well known: as is the automatic representation, clumsy enough it must be admitted, of a

royal tiger tearing to pieces a soldier in the pay of the British, and imitating the growling of the beast and the cries of the man, taken also upon the same occasion. (See the Museum at the India House.)

The term 'Tiger' is locally and erroneously applied to the Jaguar. [*LEOPARDS*, vol. xiii., p. 436.]

FOSSIL TIGERS, &c.

Professor Buckland notices the remains of the Tiger in the cave at Kirkdale, at Plymouth, and in the breccia of Antibes. The great fossil Tiger or Lion (*Felis tigris*, Goldfuss), and other extinct cats, lived before man was in existence. The following fossil cats are enumerated by Von Meyer, besides the great species above-mentioned:—*Felis antiqua*, Cuv.; *F. Issiodorensis*, Croiz. and Job.; *F. brevirostris*, Croiz. and Job.; *F. Pardimensis*, Croiz. and Job.; *F. Arvernensis*, Croiz. and Job.; *F. Megantropus*, Brav.; *F. cultridens*, Brav.; *F. aphanistes*, Kaup; *F. Ogygia*, Kaup; and *F. prisca*, Kaup. [*FELINE*, vol. i., p. 224.]

Dr. Lund, in his 'View of the Fauna of Brazil previous to the last Geological Revolution,' remarks that the Hunting Leopard (*Felis jubata*, Linn.; *Cynailurus*, Wagl.), which differs from the rest of the Cats in many essential characters, has been very properly formed into a separate genus; for its claws are not retractile, it is gregarious, and of so mild a disposition that it is frequently tamed and employed in the chase. But, he observes, as a remarkable contrast to this, that its dental system is upon a more murderous plan than that of the true *Felis*, not having the flat projection on the large tearing molar of the upper jaw, which is found in all the other predaceous genera, and the development of which is in inverse proportion to the animal's carnivorous propensities. Dr. Lund recognised this form of dentition in a small animal of the extinct Fauna of the Brazilian region, which was the scene of his valuable labours, not exceeding a domestic cat in size: and he has named it *Cynailurus minutus*. Besides this he discovered the remains of two species of the normal feline form, one as large as the long-tailed tiger-cat (*Felis macroura*, Pt. Max.), the other larger than the Jaguar *Felis (Imp. Linn.)*, and comparable to the Tiger and the Lion, the largest species of the Old World.

TIGER-CATS.

Under this title may be classed all those lesser striped and spotted Asiatic, African, and American Cats which do not come under the well-understood denominations of Tigers, Leopards, and Panthers.

Before we proceed to any description or illustration of this beautiful group, it will be advantageous to the student to be put in possession of M. Temminck's well-considered and digested monograph of the genus *Felis* divided into two sections according to their geographical distribution.

Section 1.

This comprises the *Felidae* of the Old Continent and the archipelago.

Species.

1. *Felis Leo*, including the three varieties of *Barbary*, *Senegal*, and *Persia*. [*LION*.]

2. *Felis Tigris*, the Royal Tiger (here treated of).

3. *Felis jubata*, the Hunting Leopard. [*LEOPARDS*, vol. xiii., p. 433.]

4. *Felis Pardus*, the Panther. [*LEOPARDS*.] Of this M. Temminck gives the following character:—When adult, less than the Leopard: tail as long as the body and the head, its extremity when turned back reaching to the tip of the nose: colour of the fur deep yellowish fulvous, its internal part marked with rose-like spots of the same hue as the ground-colour of the fur; the numerous spots closely approximated; the rose-like spots from 12 to 14 lines at the utmost in diameter: caudal vertebrae 23. N.B. The number of caudal vertebrae assigned to the Leopard by M. Temminck is 22. It would appear that there is no correct figure of the true Panther.

The Black Tiger, *Felis meias*, *Rimau Kumbang* of Sr Stamford Raffles, is considered as only a dark variety of the Leopard.

Felis Uncia is considered as also to be erased from the list of species, as it is only the young of the Leopard or Panther.

6. *Felis macroctis*, the *Rimau-Dahan*. [*LEOPARDS*, vol. xiii., p. 432.]

7. *Felis Serval*, comprising *F. Serval* and *F. Capensis*, Linn., the *Chat-pard* of Desmarest, and the *Caracal* of Bruce.

8. *Felis cervaria*. For the characters of this and the seven species of LYNX which follow it in M. Temminck's monograph, see LYNX, vol. xiv., p. 217.

16. *Felis Catus*. [FELIDÆ, vol. x., p. 221.]

17. *Felis maniculata*. [FELIDÆ, p. 222.]

18. *Felis minuta*, identical with the *Felis Javanensis* of Horsfield's 'Zoological Researches in Java,' and therefore not to be adopted.

Section 2.

This comprises the *Felidæ* of the New Western World.

19. *Felis concolor*, the *Puma*. [LION.]

20. *Felis Onça*, the *Jaguar*. [LEOPARDS, vol. xiii., p. 434.]

21. *Felis Jaguarondi*.

22. *Felis celidogaster*. Bought by M. Temminck at the sale of Mr. Bullock's collection, for the museum of the Netherlands.

23. *Felis rufa*, Guldenst. Bay-Cat of Pennant: with this M. Temminck describes also a specimen brought from Mexico, which may prove distinct. Bought by M. Temminck at Mr. Bullock's sale for the museum of the Netherlands.

24. *Felis pardalis*, the Ocelot.

25. *Felis macroura*.—N.B. These two last confounded together by Linnæus under the name of *F. pardalis*. The Mexican Tiger of Pennant is said to appear to be a representation of *F. macroura*.

26. *Felis mitis*, the *Chati*, F. Cuv.

27. *Felis tigrina*.

This monograph, as far as it goes, has been of great benefit; but the student should examine the menageries and museums, as well as the works of other authors, and he will find several cats noticed both before and since the publication of M. Temminck's catalogue. Among other authorities the publications of d'Azara, of Sir Stamford Raffles, of M. F. Cuvier, of M. Desmarest, of Mr. J. E. Gray, of Dr. Horsfield, and Mr. Vigors in the *Zoological Journal*, of Dr. Horsfield in the *Zoological Researches in Java*, of Prince Maximilian, of M. Lesson, of Sir William Jardine (*Naturalist's Library, Mammalia*, vol. ii., *Felinæ*), and of Mr. Darwin (*Zoology of the Beagle*), may be consulted with advantage.

Dr. Horsfield and Mr. Vigors (*Zool. Jour.*, vol. iv., p. 390) remark that they are not of M. Temminck's opinion, that the determination of species in such groups as these rests upon any examination, however acute, of preserved specimens in cabinets, or in any research, however extensive, into the stores of furriers. Such examination, they think, leads to conjecture; probable and plausible conjecture, it may be true, but still conjecture, and not facts. They add that we are in this way as likely to fall into the error of confounding true species as into that of creating nominal ones, and they express their opinion that the truth can be satisfactorily attained only by diligent researches in the native country of these animals, or by accurate observations on their changes and differences as to sex, age, and season, when in a living state and in confinement.

M. Temminck, in his *Tableau Méthodique* (1827), states that then there were known thirty distinct species of cats and seven or eight other doubtful indications.

ASIATIC TIGER-CATS.

Example, *Felis Nepalensis*, Horsf. and Vig.

Description.—Size of *Felis Javanensis*, Horsf., but its habit more slender, the tail and neck proportionally elongate. Ground-colour grey, with a very slight admixture of tawny; bands and spots of the head, back, neck, throat, abdomen, and thighs, deep black; superior longitudinal bands resembling those of *F. Javanensis*. Ground-colour of throat and abdomen nearly white; the lower flanks marked with a faint tawny longitudinal streak. Cheeks streaked with two parallel longitudinal lines, at the termination of which follows a transverse lunar mark which passes with a bold curve to the angle of the mouth, near which a very narrow band crosses the throat. Sides of the neck appearing marked with two broad waving bands, at the termination of which stands an oblong regularly transverse band. Neck underneath nearly immaculate. Shoulder and flanks exhibiting irregular, diversified marks, P. C., No. 1543.

the anterior oblong, the posterior angular, of a mixed tawny and black, and, individually, above or posteriorly with a broad dash of saturated black: they are scattered over the sides without any regular longitudinal disposition; but they have generally an oblique direction. Abdomen marked throughout with uniform oval spots; anterior thighs within exhibiting one, the posterior thighs two broad black bands. Rump and thighs marked externally with roundish or oblong spots. Tail above, to within about an inch of the tip, with uniform roundish spots, arranged posteriorly in regular transverse bands. Head above and ears agreeing generally with those of *F. Javanensis*. Length from extremity of nose to root of tail, 1 foot 10½ inches. Length of tail 10½ inches. (Vig. and Horsf.)

Dr. Horsfield and Mr. Vigors observe that the distinguishing characters of this species are, its comparatively lengthened habit; the slenderness and proportional length of the tail; the disposition of the marks on the flanks, and the character of these marks as far as regards their diversified form; and the saturated black patch with which they are individually marked at their upper or posterior edge.

'In the *Bengal Cat*,' say those zoologists, 'these marks have a different disposition; they are oblong, and arranged on the flanks in regular succession longitudinally. The materials contained in the museum at the India House have enabled us to make this statement, which is founded on the examination of a specimen brought by General Hardwicke, and on a careful drawing prepared under the eyes of Dr. Hamilton. We have thus two distinct species of small cats from India, and the elucidation of this point is of some importance, as it appears, from the following remark in M. Temminck's monographs, "*l'existence de cette espèce dans l'Inde n'est pas constatée*," that he entertained some doubts on the existence of the *Bengal Cat*. It is not our intention, at present, to give a comparative analysis of all the species which resemble our animal. The discrimination of many species of *Felis* is at all times a difficult subject; and on many of them naturalists still disagree. Our immediate object is to indicate a new form of *Felis*, from the upper provinces of India, differing essentially from that which is found in the plains of Bengal; and so direct the attention of naturalists in that country to a more careful investigation of the various Oriental species of this interesting genus.'

The same authors state that the specimen in the collection of the Zoological Society of London was presented by Captain Farrer, of the East India Company's service. It came immediately from Calcutta, where it was said to have been sent from Nepal. It lived some time in the Society's gardens, but was extremely wild and savage. It generally remained in a sitting posture, like that of the common *Domestic Cat*, and never paced its den in the manner of most other animals of the group. (*Zool. Journ.*, vol. iv.)



Felis Nepalensis.

AFRICAN TIGER-CATS.

Example, *Felis Serval*, the Serval.

Description.—Upper parts clear yellowish, with black spots; lower parts white, with black spots also, but they are less numerous. Upon the head and neck the markings are most conspicuous, and form symmetrical lines on each side directed towards the shoulders. On the other parts of the body they are placed irregularly. On the back they are lengthened, and show a disposition to form four rows; on the body and thighs they are larger and round, and they are smaller but equally round on the extremities. Upon the face and muzzle they are minute.

Back of the ears black at the base, succeeded by a transverse white bar; tips of the ground-colour of the body. On the inside of the fore limbs two conspicuous black transverse bars; the hind limbs with similar markings, but less defined; last joints of the limbs of a paler tint than the rest of the body, the spots on them round and very small. Tail with eight black rings, tip of the same colour. Length, exclusive of tail, 1 foot 11½ inches; tail 9 inches. Height when standing erect, about 12 inches at the shoulder, and 15 inches at the hind quarters. (F. Cuv.)

The animal from which the above description was taken was a very young male. Its temper was mild and gentle, and its disposition sportive. It played like a domestic cat, or rather kitten, chasing its tail, and amusing itself with anything that it could roll with its paw.

Locality.—The Serval is a native of southern Africa. There are generally some living specimens in our menageries. It has been exhibited in that of the Zoological Society of London, and may be seen there now (1842).



The Serval.

AMERICAN TIGER-CATS.

But it is in America that the tiger-cats are most numerous and beautiful, and there their manners have been best noticed by competent observers: we select three examples of the varieties of form and colouring exhibited by this group in that quarter of the globe.

Felis pardalis, Linn. The Ocelot. This, the most beautiful perhaps of all the tiger-cats, almost defies description. Mr. E. Bennett has however given a very faithful account from two living specimens, one existing when he wrote in the Tower of London, and the other in the garden of the Zoological Society in the Regent's Park.

Description.—Body when full grown nearly three feet in length; tail rather more than one; medium height about 18 inches. Ground-colour of fur, grey, mingled with a slight tinge of fawn, elegantly marked with numerous longitudinal bands, the dorsal one continuous and entirely black, the lateral (six or seven on each side) consisting for the most part of a series of elongated spots with black margins, sometimes completely distinct, sometimes running together. The centre of each spot of a deeper fawn than the ground-colour external to them; this deeper tinge is also conspicuous on the head and neck, and on the outside of the limbs, all of which parts are irregularly marked with full black lines and spots of various sizes. From the top of the head, between the ears, there pass backwards, towards the shoulders, two, or more frequently four, uninterrupted diverging bands, which are full black anteriorly, but generally bifurcate posteriorly, and enclose a narrow fawn-coloured space with a black margin; between these there is a single longitudinal, somewhat interrupted, narrow black line, occupying the centre of the neck above. Ears short and rounded, externally margined with black, surrounding a large central whitish spot. Under parts of the body whitish, spotted with black, and the tail, which is of the same ground-colour with the body, also covered with black spots. (Bennett, *Tower Menagerie*.)

Mr. Bennett remarks that he has, in the above description, stated the length of the tail at more than a foot; and that in all the known ocelots, as well as in all the species (of which there are several) that approach it in form and colouring, the proportionate length of the tail is at least

equal to that which he has given as its average measurement. The tail however of the Tower specimen did not exceed six or seven inches; its extremity was covered with hair, and there was no cicatrix. Still its length throughout and its abrupt stumpiness induced the belief that this abbreviation was purely accidental; and he has by no means inclined to regard that specimen as a new species, to be distinguished by the excessive shortness of that appendage, by the unusually pale colour of its markings, and by some slight peculiarity in the mode of their arrangement, which, he observes, varies in every individual that he had seen.

Locality.—Mexico, Paraguay, and probably Peru.

Habits, &c.—The ocelot remains in the deep woods during the day, sallying forth at night in quest of other quadrupeds and birds, the latter of which it successively chases in the trees, for it is a very expert climber. It has been, as is generally supposed, the *Tlacotal*, *Tlacotal*, *Catus Pardus Mexicanus* of Hernandez, it is said to stretch itself out as if dead on the limb of some tree when it spies monkeys in the neighbourhood. They, urged by curiosity, proceed to examine the supposed defunct and fall victims to their curiosity.

The Ocelot has been so completely tamed as to be left at liberty, and it is said to be capable of strong attachment to its master. Mr. Bennett states that the specimen in the Tower, a male, was perfectly good-tempered, exceedingly fond of play; and had much of the character and manners of the domestic cat. Its food consisted principally of rabbits and birds; the latter it plucked with great dexterity, and always commenced its meal with the head of which it seemed particularly fond; but it did not exhibit the ravenous avidity which characterizes nearly all the animals of this tribe.



The Ocelot.

Felis mitis, F. Cuv.; The Chat. *Chibiguazu* of D'Azara? *Felis Chibiguazu*, Desm.

Description.—About a third larger than the domestic cat: length, exclusive of tail, rather more than two feet. Tail eleven inches. Height to middle of back, about one foot two inches. Ground-colour of fur on the upper parts pale yellowish; on the lower, pure white; at the roots dull grey, and very thick and close. Body covered with a regular dark patches; those upon the back entirely black and disposed longitudinally in four rows; those upon the sides surrounded with black, with the centres of a clear fawn, arranged in nearly five rows. Spots upon the lower part of the body, where the ground-colour of the fur is white, full, and arranged in two lines composed of six or seven patches on each side. Limbs covered with nearly round spots of smaller dimensions: on the fore-legs and the body, two transverse bands. On the throat a sort of half collar, and on the under-jaw two crescent-shaped spots. Behind each eye two bands about two inches long terminating opposite the ear. Forehead bordered by two lines, between which are numerous spots, and at their origin, a blackish mark from which the whiskers spring. Outside of the ear, black, with a white spot upon the small lobe. Base of the tail spotted with small black spots which towards the end run into half-rings, which are broadest on the upper surface. Pupil round. (F. Cuv.)

This animal (a female) was extremely gentle: and if those with whom it was familiar passed its cage or did not approach it, it would express its discontent by a short cry. It manifested great delight when it was caressed. It had



Felis mitis.

ris menagerie, and was procured from a dealer in locality.—South America.

rest and others identify this animal with the Chibiguazu of D'Azara. Temminck, who received a skin de Janeiro, considers it distinct.

a's description comes very near to that above far as colouring is concerned; but he gives the length as three feet six inches; the individual described, the largest male he had seen, was four at an inch in length; tail thirteen inches; heighters one foot and a half, and behind one foot seven id a half. It was so fat that immediately after weighed five-and-thirty pounds; the females, he rather less.

me acute observer, speaking of his *Chibiguazu*, that some of the Guaraneese call the domestic, and others *Mbrucayá*. In the same manner, he e give the wild animal of which he is treating of *Chibi-guazu*, and others that of *Mbarucayá*—both appellations signifying *Great Cat*. Many, he adds, call it *Onza* (Ounce).

es that the species is so common, that his friend aptured eighteen individuals in two years, within nes of his *pueblo*; but he adds that, notwithstanding this abundance, few are acquainted with it, the and dogs never falling in with it, and being y penetrate to its haunts: he very much doubts ny quadruped hides itself more effectually. He it as remaining by day in the most impenetrable id as coming forth after dusk, especially on dark ghts, when the *chibiguazu*s daringly enter the id court-yards, though no instance is known of ction by the dogs. When the moon shines they m visiting inhabited spots, and never are trapped: wait for them with a gun is hopeless, so sharp a do they keep. They carry off domestic fowls; which they climb, sometimes six in one night.

leave several dead. Men and dogs are avoided with extreme caution, and each pair is supposed a separate district, for a male and female, and no always caught in the same place. Nosedá formed strong stakes, with three divisions: in the middle ie placed a white fowl, so that it might not only but seen at a distance: the other divisions were as to shut by the falling of the planks as soon hibiguazu entered. This trap was set in the which they resorted for prey, and those caught ed into a great den in Nosedá's court-yard. Some ot away, and were taken again two or three times ne trap: they were recognised by ear-marks and ois: D'Azara infers from this that the idea of as obliterated from their recollection by their possess the fowl. He remarked that all which t in the den deposited their excrements in their lace, and when he substituted a narrow-necked vent this, they mounted to its edge for that purnever missed the vessel or its immediate neigh-

Nearly the whole day was spent by them in a ball, and, when a *chibiguazu* wished to mself, he first licked the one at his side. When put into their den, or so that they could reach it ng their paws through the bars, it was always t on the day following they had placed it in a

heap, after having divided it into bits some quarter of an inch long, and on this they reposed. The small sticks and twigs with which the inside of their den was furnished were broken and torn to pieces in like manner. Twilight and night were passed in pacing to and fro close to the sides of their den; and if crossed or interrupted by another, theyuffed and gesticulated like an angry cat, but without using their paws. They never quarrelled, unless they were very much irritated, and then they struck at each other with their fore-paws. They devoured five pounds of flesh per day when first caught, but afterwards three sufficed. A portion was prepared for each of the twelve or fourteen individuals confined, and they took it with their paws according to the length of time they had been there, without any interference on the part of the others. If however the animal whose turn it was did not take his portion, or disregarded it, another immediately snatched at it without any defence on the part of the right owner except by sneezing, and sometimes by blows with its fore-paws. A walk was made for them, enclosed by a sort of hurdle, so that rats, fowls, ducks, or young dogs could be introduced into it: upon opening the cage it was observed that usually one only went out for each victim, and almost always according to the order of their confinement. Cats and dogs they seized with their mouth by the nape of the neck, overlaid them, and then kept them so that they could not stir, till they were dead. Cats' flesh appeared to produce the mange, fretting the *chibiguazu*s, making them mew like cats, and, at last destroying them. Snakes, vipers, and toads were also eaten by them, but this diet occasioned violent and continual vomiting; they wasted to skeletons, and died in a few days. If the dog introduced equalled them in size, they touched him not, for it appears that they do not assist each other. If a *chibiguazu* cannot master any prey alone, he leaves it. Birds were caught by the head and neck, and thoroughly stripped of their feathers before they were eaten. No unnecessary cruelty was manifested. Nosedá observed that one did not kill a fowl put into his den till the third day. D'Azara and his friend frequently closed the doors of the yard, and opened the den that the *chibiguazu*s might leave it: those most lately caught went first; and sometimes the old ones would not go out even when their den was entered that it might be swept. They were left at liberty for several hours, during which they examined every crevice, and then lay down to sleep. When boys persecuted them with sticks, they retreated to their den without turning on their persecutors, even when severely beaten. A male on one occasion becoming very lazy, on entering his den he was abused and bitten by his female, as if to punish him. Some individuals were incarcerated for more than a year without exhibiting any sign of love. In the night their eyes shone like those of a domestic cat, and they resembled that animal in their form and habits, in lying down, licking and cleaning themselves, washing their faces with their paws, fuffing, sneezing,—in fact in every way. D'Azara concludes by stating that his friend caught a young one, and it became so thoroughly tame that it slept in the skirts of his clerical gown, and went about loose. He affirmed that no animal could be more tractable: but it devoured the poultry of his neighbours, and they killed it.

Felis Pajeros.—The Pampas Cat, *Pajero*, or Jungle-Cat.

Description.—Fur of great length: longer hairs of the back upwards of 3 inches, and those of the hinder part of the back from $4\frac{1}{2}$ to $4\frac{3}{4}$ inches in length. General colour pale yellow-grey. Numerous irregular yellow or sometimes brown stripes running obliquely from the back along the sides of the body. On each side of the face two stripes of yellowish or cinnamon commencing near the eye, and extending backwards and downwards over the cheeks, on the hinder part of which they join, and form a single line, which encircles the lower part of the throat. Tip of the muzzle and chin white; a spot in front of the eye, and a line beneath the eye, of the same colour; belly, inner side and hinder part of fore-legs, white also. An irregular black line running across the lower part of the chest, and extending over the base of the fore-legs externally: above this line two other transverse dark markings more or less defined on the chest. On the fore-legs three broad black bands, two of which encircle the leg: on the posterior legs about five black bands externally, and some irregular dark

spots internally. Feet yellowish, and under side of tarsus of a slightly deeper hue. On the belly numerous large irregular black spots. Ears moderate, with long white hairs internally; externally of the same colour as the head, except at the apex, where the hairs are black, and form a slight tuft. Tail short, somewhat bushy, and devoid of dark rings or spots—the hairs are in fact coloured as those on the back. On the upper part of the body each hair brown at the base, then yellow, and at the apex black. On the hinder part of the back the hairs almost black at the base, and, on the sides of the body, each hair grey at the base; there is then a considerable space of yellowish-white colour: towards the apex they are white, and at the apex black. The greater number of the hairs of the moustaches white. Length from nose to root of tail, 26 inches; of tail (fur included), 11 inches. Height of body at shoulders, 13 inches. Size about equal to that of the common wild-cat of Europe; but the Pampas cat is stouter, its head smaller, and its tail shorter. (Waterhouse.)

Mr. Waterhouse (*Zoology of the Beagle*) observes that the markings of this animal vary slightly in intensity: those on the body, he remarks, are generally indistinct; but the black rings on the legs are always very conspicuous.

Locality.—D'Azara says that he knows not, nor has he heard, that this species exists in Paraguay, although it formerly may have been seen there; but as the country became tolerably well peopled, and there were fewer plains, the inhabitants probably extirpated it. He caught four in the Pampas of Buenos Ayres, between 35° and 36° S. lat., and three others on the river Negro. He says they are found on both sides of the La Plata.

Darwin (*loc. cit.*) gives as its habitat Santa Cruz, Patagonia (April), and Bahia Blanca (August). He states that it is common over the whole of the great plains which compose the eastern side of the southern part of America; and he says he has reason to believe, from the accounts he received, that it is found near the Strait of Magellan, which would give it a range of nearly 1400 miles in a north and south direction, D'Azara having stated that it extends northward as far as 30° S. lat. One of Mr. Darwin's specimens was obtained in 50° S. lat., at Santa Cruz.

Habits, Food, &c.—D'Azara says that the natives call this animal *gato pajero*, because it lives on the plains, concealing itself in jungles, without entering into the woods and thickets. *Aperous*, or guinea-pigs, according to him, form its principal food. Mr. Darwin states that it takes its name from 'paja,' the Spanish word for straw, from its habit of frequenting reeds. The specimen taken by him at Santa Cruz was met with in a valley where thickets were growing. When disturbed it did not run away, but drew itself up and hissed.



Pampas Cat. (*Zool. of Beagle*.)

We here conclude our notice of the tiger-cats, a race evidently appointed as the principal agents for keeping down the birds and smaller mammalia, which abound in warm climates.

TIGLIUM. [CROTON.]

TIGRANES, king of Armenia, the ally of Mithridates the Great, who gave him his daughter Cleopatra in marriage. He was master of the large tract between Egypt in the south-west and the Caspian Sea in the north-east, which was bounded by Assyria and Media in the east, and by the kingdoms of Pontus and of Cappadocia on the west

and north-west. The earlier history of Tigranes is not known; Strabo (p. 532, Cas.) and Justin (xviii. 3) state that he was sent in his youth as a hostage to the king of the Parthians, who afterwards restored him to liberty. He conquered Gordyene and Mesopotamia, and the Syrians chose him for their king in a.c. 84, or, according to Appian (*De Reb. Syr.*, 70), in b.c. 80. Before b.c. 74 he contracted an alliance with Mithridates, who was then about to begin his third war with the Romans. The conditions of this alliance were, that Mithridates should be master of the countries which they hoped to conquer, and that Tigranes should have the inhabitants and all the moveable property that he could carry off. Plutarch states (*Lucullus*, p. 509, Xyland.) that the army of Tigranes was composed of 200,000 men—20,000 archers, 55,000 horse, 150,000 foot, and 3,000 pioneers and train,—and that Arabs and warlike Albanians from the Caucasus abounded in the Armenian camp. The campaign was opened in b.c. 74. Cappadocia and Bithynia were conquered, and Mithridates laid siege to Cyzicus in Bithynia, but Lucullus came to relieve it, and after various reverses Mithridates was compelled to fly to Tigranes (69). The conduct of the Armenian king had been unscrupulous during these events, and, the Romans being too victorious, he not only refused to receive his son-in-law, but set a prize of a hundred talents on his head, on the pretext that the king had persuaded his son, who was likewise called Tigranes, to rebel against his father and to join the Romans. Mithridates nevertheless succeeded in pacifying his son-in-law, and they joined their armies to meet Lucullus, who had crossed the Euphrates and the Tigris, and had laid siege to Tigranocerta, the new capital of the Armenian kingdom. [TIGRANOCERTA.] A battle ensued near this town, in which Tigranes was completely defeated (6th October, 69), and his capital fell into the hands of the Romans. Tigranes and Mithridates having entered into negotiations with Phraates III., king of the Parthians, for the purpose of drawing him into their alliance, Lucullus, who had now carried his conquest in Armenia as far as Artaxata on the upper part of the Araxes, marched to Mesopotamia to attack the Parthians. But a mutiny of his soldiers compelled him to retreat to Cappadocia, where they dispersed, as it seems, by the instigation of Pompey, who aimed at the supreme command in the war (67). The Romans lost Cappadocia, and Tigranes carried off a great number of the inhabitants of this province, as well as of Cilicia and Galatia. Pompey entered Asia Minor in b.c. 66, and in the same year he defeated Mithridates in a great battle on the Euphrates. Mithridates, having experienced the faithless character of his son-in-law, fled to Phanagoria in the island of Tanais, while Tigranes humiliated himself before the Romans, then encamped in the neighbourhood of Artaxata. He went to the tent of Pompey, and, kneeling before his victorious enemy, took off his royal diadem, which Pompey however would not accept. The policy of the Romans required an independent kingdom between their dominions and the dangerous power of the Parthians. Tigranes therefore was reinstated in Armenia, except the districts of Gordyene and that of Sophene, or the westernmost part of Armenia Magna, which he was obliged to cede to his rebellious son Tigranes, then an ally of the Romans. Besides these districts, he ceded to the Romans his kingdom of Syria, including Phoenicia and all his conquests in Cilicia, Galatia, and Cappadocia; he paid six thousand talents, and he gave half a mina to each Roman soldier, as minæ to each centurion, and sixty minæ, or one talent, to each tribune. (Plutarch, *Lucullus*, p. 637, Xyland.; comp. Appian, *De Bello Mithrid.*, c. 104.) It seems that after this humiliation Tigranes led an obscure and tranquil life, for his name disappears from history, and the year of his



Coin of Tigranes.

British Museum. Actual size. Silver. Weight, 25½ grains.

death is unknown. His successor was Artavasdes. [MITHRIDATES; POMPEIUS; LUCULLUS.]

(Valerius Maximus, v. 1, 9; Velleius Paterculus, ii. 33, 1, and c. 37; Cicero, *Pro Lege Manilia*; Woltersdorf, *Commentatio Vitam Mithridatis M. per annos digestam sistens*, Goettingae, 1812.)

TIGRA'NES, prince of Armenia and lord of Sophene, was the son of Tigranes, king of Armenia. During the last war between the Romans and Mithridates aided by his ally king Tigranes, prince Tigranes forsook his father and went over to the Romans. When his father humiliated himself before Pompey, he sat by the side of the Roman general, but he did not rise before his father, nor did he show him the slightest degree of filial respect. Having been created lord of Sophene and Gordyene, he refused to surrender the treasures of Sophene to Pompey, who suspected him of being in secret communication with Phraates, the king of the Parthians, whose daughter he had married. Tigranes also became suspected of having formed a plan for seizing or putting to death his father, and accordingly he was arrested by order of Pompey, who sent him to Rome. He figured in the triumph of Pompey.

Appian (*De Bello Mithrid.*, c. 105 and 117) states that Tigranes was afterwards put to death in his prison. [TIGRANES.]

TIGRANO'CERTA (Τιγρανόκερτα), for some time the capital of Armenia, was built by king Tigranes after he had extended his dominion over Mesopotamia, Syria, and Phoenicia. Artaxata, the old capital on the Araxes, being situated in the north and the neighbourhood of the Caucasian nations, then the allies of Armenia, Tigranes seems to have thought it convenient to have his capital near those countries, which often required his presence on account of their possession being still insecure. This danger arose principally from the neighbourhood of the Romans, who, from the time when Attalus left them his kingdom of Pergamus by testament (b.c. 133), formed designs on all Asia Minor, and at the time of the foundation of Tigranocerta (between 84 and 74 b.c., but nearer to 84) were at war with Mithridates, the neighbour and ally of Tigranes. Tigranocerta was situated a short distance from the Upper Tigris, on the Nicephorius, a river of considerable breadth, as Tacitus states. Seert or Sered, a small town, surrounded by antient ruins, is generally supposed to be on the site of Tigranocerta. Sered is situated on the banks of a small river, the modern name of which is unknown, and which flows into another river of considerable length, the Bedlis of Hâji Khalfah, which has its sources south-east of lake Van, and flows into the Tigris. This latter river is called Khabur by D'Anville, but this is a mistake, the Khabur, according to Hâji Khalfah, cited by Rennell, being another tributary river of the Tigris nearer its middle course. It has been supposed that the river Centrites was also called Nicephorius, and this opinion is principally founded on the circumstance of the river which passes Sered being a very small stream, while the Nicephorius at Tigranocerta was of a considerable breadth. This opinion however is rejected by Rennell, and indeed no ruins have been found on the banks of the Centrites, though it has not yet been shown that there are none. We are likewise ignorant as to the changes which may have taken place in the direction of the Centrites, which, after having left the mountains at the village of Kala Zerke, flows through an open and level country at some leagues distance east from Sered. According to Tacitus, Plutarch, and Appian, Tigranocerta had very strong fortifications; its suburbs contained gardens and fish-ponds. The town was inhabited partly by barbarians, and partly by Greeks, the inhabitants of twelve Greek towns who were transplanted thither by Tigranes after he had ravaged Cappadocia. The military position of Tigranocerta was admirably chosen. By its situation opposite the passage formed by the narrow alley of the Centrites in the Carduchian Mountains, it commanded one of the principal roads which led and still leads from the valley of the Tigris into Armenia across the mountains. It was also opposite the gorge in the Carduchian Mountains, which, a short distance south of the junction of the Centrites with the Tigris, came so close to the Tigris as to render it impossible for an army to move along the left bank of the river. Xenophon, in conducting the retreat of the ten thousand, apparently intended to enter Armenia by the valley of the Centrites,

but he found this passage between the Tigris and the Carduchian Mountains impracticable; and taking suddenly a north-east direction, he ascended the steep Carduchian Mountains, and crossed the Centrites in its upper part.

Master of Tigranocerta, the king of Armenia could suddenly invade Cappadocia, Mesopotamia, and Syria; and in case of defeat he could retreat under the walls of Tigranocerta and defend the defiles in the mountains against a superior army. Lucullus, in his campaign against Mithridates and Tigranes, laid siege to this key of Armenia before he ventured to enter the defiles. The united kings hastened to relieve the town, but they were beaten, and Tigranocerta with immense treasures fell into the hands of the victor (6th October, 69 b.c.), who sent the greater part of the Greek inhabitants back to their homes in Cappadocia. After the fall of Tigranocerta, all Armenia was open to the Romans, who overran the country as far as Artaxata. But no sooner was Lucullus informed that Phraates, the king of the Parthians, was about to attack him, than, instead of descending the Araxes and making an attack on the northern part of Media, he hastened back to Tigranocerta. If he had remained a little longer on the Araxes, the Parthians would have forced the position of Tigranocerta, and the Roman army would have been shut up within Armenia. Strabo (p. 532, Cas.) says that, when Lucullus took Tigranocerta, it was only half finished, and that after its destruction there was nothing but a little village on the spot. However it soon became again a town, and in the wars of Corbulo, 63 a.d., it was a considerable and well-fortified place. (Tacitus, *Annal.*, xv. 4.) Hesychius, s. v. Κίπρα, says that κίπρα signifies a town, in Armenian, and this opinion is corroborated by Stephanus Byzantinus s. v. Τιγρανόκερτα, who says that, in the language of the Parthians, Τιγρανόκερτα is the same as Τιγρανοίπολις in Greek. The word 'certa' also occurs in Carthiocrerta, a town which is also called Amida, and is now known by the name of Kârâ-Amid and Diyârbekir. Soping, in his notes to Hesychius, says that κίπρα or κάρπα is the root of Carthago. [TIGRANES; LUCULLUS; POMPEY.]

Strabo, p. 532, 539, 747, Cas.; Appian, *De Bello Mithrid.*; Plutarch, *Lucullus*; *Pompeius*; Tacitus, *Annal.*, xii. 50; xiv. 24; xv. 4, &c.; Rennell, *Illustrations of the History of the Expedition of Cyrus, and the Retreat of the Ten Thousand Greeks*; Rennell, *Geography of Asia Minor.*)

TIGRIS, River. [See End of Letter T.]

TIGRISO'MA, Mr. Swainson's name for the *Tiger-Bittern*.

Subgeneric Character.—Bill as in *Ardea*. Face, and sometimes the chin, naked. Legs almost feathered to the knees. Inner toe rather shorter than the outer. Claws short, stout, regularly curved. Anterior scales reticulate or hexagonal. Mr. Swainson considers this to be the rasorial type, and he arranges it as a subgenus of the family *Ardeidae* [HERONS], between *Butor*, Antiqu., and *Nycticorax*. Example *Tigrisoma lineatum*, Pl. Col. 860.

(N.B. According to the principle generally received among zoologists, neither *Butor* nor *Nycticorax* can be retained as generic names. The first is identical with the *Botaurus* of Brisson and Stephens: for the reasons against admitting the second, see *NYCTICORAX*.)

TIJU'CA, M. Lesson's name for a genus of birds (*Chrysopteryx*, Sw.; *Attila*, Less.; *Ampelis*, Nordm.). Mr. G. R. Gray arranges it between *Calyptomena*, Raffl., and *Procnias*, Hoffm., under the *Ampelinae*, Mr. Gray's third subfamily of the *Ampelidae*.

TILBURG is an inland town in the kingdom of the Netherlands, in the province of North Brabant and district of Bois-le-Duc: it is situated in a heath on the banks of the river Ley, 13 miles east of Breda, 14 south-west of Bois-le-Duc, and 38 north-east of Antwerp. It has three churches, a large castle, and 12,000 inhabitants, of whom between 5000 and 6000 are employed in the manufacture of fine woollen cloth and kerseymeres. They likewise manufacture calmuco, beaver coating, baize, and cloth for the army. Extensive barracks have been built by the present king of Holland. Lying out of the great road from Flanders to Holland, it is little visited by travellers.

TILBURY FORT, a fortification erected on the north bank of the river Thames, opposite to Gravesend, for the purpose of commanding the navigation of the river. It was originally formed as a mere block-house in the time of Henry VIII.; but after the Dutch fleet, under De Ruy-

ter, had advanced into the Thames and Medway in 1667, Charles II. converted it into a regular fortification, to which considerable additions have since been made. The fort stands principally in the parish of West Tilbury, but partially in the adjoining parish of Chadwell. It is surrounded by a deep and wide fosse, which may be filled with water when necessary; and its ramparts present formidable batteries of heavy cannon toward the river. The fort is chiefly of brick; but it has a massive stone portal, the elevation of which renders it a prominent object from the opposite side of the river, which is here about a mile wide. Within the fort are commodious barracks and other accommodations for the garrison, which ordinarily consists of a fort-major and a detachment of invalids; and piers toward the river afford facilities for the landing of troops, stores, &c. Owing to the flatness of the shore, the fort is liable to overflowing during floods and spring-tides, and its situation is by no means salubrious. A view of Tilbury Fort, from the river, is given in No. 120 of the Penny Magazine.

TILE, a kind of thin brick, or plate of baked clay, used chiefly for covering roofs, but occasionally for paving floors, constructing drains, &c. The English name, and those by which tiles are known in other European languages, are derived from the Latin *tegula*, which contains the same element as *tego*, to cover. This becomes, in Saxon, *tigle* or *tigel*; in Dutch, *tegel*, *teghel*, *tichel*, or *tichgel*; in German, *ziegel* or *dachziegel*; in Italian, *tegola*; in Spanish, *teja*, *tega*, or *tegilla*; and in French, *tuile*.

An account of the use of tiles among the ancients, illustrated by engravings of roofing-tiles found at Pompeii, is given in the 'Dictionary of Greek and Roman Antiquities,' art. 'Tegula,' in which it is stated that roofing-tiles were originally made like bricks, of baked clay ($\gamma\eta\varsigma\ \delta\pi\tau\eta\varsigma$), and that Byzus of Naxos introduced tiles of marble about the year 620 B.C. In addition to the superior beauty and durability of such tiles, they were made of much larger dimensions than was practicable in clay, and consequently the effect produced by their parallel joints might be brought into harmony with the rest of the building. A still more expensive and magnificent method of roofing occasionally adopted consisted in the use of tiles made of bronze and gilt. Tiles were originally made perfectly flat, or with nothing more than the hook or nozle underneath the upper border, which fulfilled the purpose of fixing them upon the rafters. They were subsequently formed with a raised border along each side, on the upper surface, and the sides of the tile were made to converge towards the lower end, in order that the raised sides or ledges might not prevent the successive rows of tiles from overlapping each other neatly. The lines of junction between the flat tiles were covered by small semi-cylindrical tiles, called *imbrices*, the rows of which, extending from the ridge to the gutter, divided the surface of the roof into a series of channels, along which water descended to the gutter. Both the *tegulae* and the *imbrices* terminated at the edge of the roof in ornamental pieces; and the whole appearance of the roof was handsome. Another kind of ancient tiling, mentioned by Pliny under the name of *parmacum*, consisted of tiles of a semicircular form at their lower edges, which, when laid in overlapping rows, somewhat resembled the feathers in the train of a peacock.

The process of making tiles is so similar to that of brick-making [Brick, vol. v., p. 407], that it will be sufficient to observe that only the best qualities of brick-earth are fit for the purpose. Since the year 1833 no excise-duty has been levied upon the manufacture of tiles, the duty having been found very prejudicial, especially after the repeal of the duty on slates, although it produced a very trifling revenue. The roofing-tiles used in this country are chiefly of two sorts, *plane-tiles*, which are flat, of a rectangular form, and usually about ten inches and a half long, six inches wide, and five-eighths of an inch thick; and *pan-tiles*, which also have a rectangular outline, but are bent in such a manner that, when laid on the roof, the greater part of their surface forms a concave channel for the descent of water, while one side forms a narrow convex ridge, which overlaps the edge of the adjoining tile. These are usually thirteen and a half or fourteen and a half inches long, and about nine inches wide, measured in a straight line from side to side. Plane-tiles are made with a hole near their upper extremity to receive

a wooden peg, by which they are hung upon the laths of the roof, and they are laid either with or without mortar in such a manner that the successive rows overlap each other about six inches. Pan-tiles have no holes, but are hung upon the laths by ledges formed at their upper edges; they do not require so great an overlap as plane-tiles, and consequently form a lighter covering. The comparative weight of the two kinds of tiling, and of other kinds of roofing, and the suitable angles of inclination for each, are given under Roof, vol. xx., p. 143. Tiles of a semi-cylindrical form, laid in mortar with their convex or concave sides uppermost, respectively, are used for covering ridges and gutters.

Drain-tiles are most commonly made in the form of an arch, and laid or bedded upon flat tiles called *soles*. Some useful information will be found in a paper 'On the Economical Manufacture of Draining-Tiles and Soles,' by Mr. Robert Beart, in the second volume of the 'Journal of the Royal Agricultural Society;' and in the same volume is a notice of the admirable tile-making machinery invented by the marquis of Tweeddale, which has been recently brought into extensive operation. Paving-tiles are usually square, and of greater thickness than those used for roofing. In ancient as well as in more recent times paving-tiles were frequently decorated with ornamental devices in various colours, so as to produce an effect resembling that of mosaic pavement.

TILE'SIA, a genus of Polypitaria mentioned by Linnæus.

TILGATE BEDS. A portion of the great series of strata in the Weald of Kent and Sussex, interposed between the green-sands and the Portland oolite, is thus named by Dr. Mantell, who has described the numerous and interesting organic remains which it contains. The reptilian species are described in Professor Owen's 'Report to the British Association,' 1841.

TILIA, the name of a genus of plants belonging to the natural order Tiliaceæ. The trees in England are called *Lime-trees*, in Swedish *Linn*, and in German and Dutch *Linden*. They are characterised by possessing a 5-parted deciduous calyx; 5 petals; numerous free or somewhat polyadelphous stamens; a globose, villous, 1-styled, 3-lobed ovary. All the species are handsome trees, with alternate heart-shaped, acute, serrated, deciduous leaves, and fragrant yellowish panicle flowers. The wood is light, smooth, and white, and their sap possesses a considerable quantity of sugar. They are principally natives of Europe and America.

T. Europea, the European or Common Lime-tree, has petals without scales, and cordate, acuminate, serrated leaves, which are smooth, with the exception of a tuft of hair at the origin of the veins beneath, and as twice the length of the petioles; the cymes are many-flowered, and the fruit is coriaceous and downy. This tree is abundant in the middle and north of Europe. It is very common in Great Britain, although some doubts have been expressed as to its being truly indigenous. It is however admitted into all British Floras: and there can be no doubt, from its wide diffusion, that it is truly naturalised in this country. It was well known to the ancients, and is spoken of by both Theophrastus and Pliny. It is a very general forest tree in Europe, and is planted in public places, parks, and approaches to residences, in France, Germany, Holland, and Great Britain. For this purpose its large and handsome appearance, and profusion of sweet flowers well adapt it. The wood is also in considerable request: it is white, close-grained, soft, light, and smooth, and is used by the cabinet-makers for a variety of purposes. It is easily worked, as well as durable, and on this account has been employed for carving. Most of the fine carvings in this country, as those at Windsor Castle, the library of Trinity College, Cambridge, and at Chatsworth, are of the wood. It is also used for wood-cutting. The fibres of the bark are very tough, and ropes and mats are manufactured from them. They are employed for this purpose in many parts of England, but in Russia and Sweden this manufacture forms a considerable branch of commerce. When used for this purpose the trees are peeled in the beginning of the year, and the bark is steeped in water, after which it is hung up to dry; and the layers of bark, being separated, are cut into ribands for making mats, or the fibres are twisted into ropes. The Russian mats used by gardeners and upholsterers are thus made. The flowers contain

a large quantity of nectar, and exhale a delicious scent. On this account they are great favourites with bees, and when expanded they are constantly beset with these insects. The honey thus procured is in great repute, and has given celebrity to the honey of Kowno, on the Niemen, in Lithuania, a small town which is surrounded by a forest of limes. It is chiefly used for making liqueurs. The seed of the lime possesses a large quantity of albumen, which is nutritious and perfectly innocuous. It was proposed by Missa, a French physician, to use it in the same way as that of the cocoa-tree. It was found to answer this purpose, but when prepared it will not keep; hence any extensive manufacture of it, although it was attempted in Germany, has been abandoned. Cattle will eat the leaves of the lime, but it is said to communicate a bad flavour to the milk of cows. The flowers were considered anodyne and antispasmodic by older physicians, and were administered in fevers when the Cullenian doctrine of spasm prevailed. Hoffman strongly recommended them, and relates cures effected by them, and they entered as an ingredient into most of his prescriptions. They are not much used in modern medicine.

The linden attains a great age; and many specimens, celebrated for their age and size, exist. At Neustadt, in Rhenberg, there is a prodigious lime-tree, which gives name to the town, which is called Neustadt an der Eifel. This tree is said by Evelyn to have had in his time a trunk above 27 feet in circumference, and the diameter of the space covered by its branches to have been 100 feet. It was set about with divers columns and monuments of stone (82 in number, and formerly above 100 more), which several princes and noble persons have adorned, and which as so many pillars serve likewise to support the umbrageous and venerable boughs; and that when the tree had been much ampler, the ruins and distances of the columns declare, which the rude soldiers have greatly impaired. Evelyn adds copies of many of the inscriptions on the columns, the oldest of which is dated 1550, and the column on which it is inscribed now supports one of the largest limbs, but was at a considerable distance from the tree 300 years ago. (Loudon.) This tree still in existence. There are many other very aged individuals in this country and on the Continent. The family name of Linnæus is said to have been derived from an ancient linden that grew near their residence. The principal tree of Berlin is called *Unter den Linden*, from the lime-trees which are planted on each side.

Many varieties of this tree are described; and, as is usual in these cases, some authors have elevated them to the rank and importance of species. The following are found in collections: *T. E. laciniata*, in which the leaves are smaller than those of the common species, and are deeply and regularly cut and twisted. It seldom attains a large size. *T. E. aurea*, which differs only in its twigs having a bright yellow colour. *T. E. dasystyla*, possesses a tomentose style, and differs from the species in the form of its fruit. Some botanists admit only one European species, the *Tilia Europæa*. Koch, in his 'Flora Germanica,' has two, the *T. grandifolia* and *T. parvifolia*, and gives *T. Europæa* as a synonyme of the latter. Hooker, in the 'British Flora,' admits all three; and De Candolle, in his 'Prodromus,' has three species, besides the European, which are as follows:—

T. microphylla, Small-leaved Lime, has its petals without nectaries or scales, cordate, roundish, acuminate, serrated leaves, smooth above and glaucous beneath, with spotted as well as axillary hairy blotches, and compound many-flowered umbels. This is identical with the *T. parvifolia* of Ehrhart and other writers. It is a native of sub-pine districts in the north of Europe. In Great Britain it is common in the woods of Essex and Lincolnshire; and Dr. E. Forster thinks it probable that this is the only true British species.

T. rubra, Red Lime, has cordate leaves, unequal at the base, hairy beneath as well as the petioles, with a tuft of hair at the base of the veins; the fruit globose and smooth. It is a native of Taurida, and some few specimens are growing in England. The young branches are of a beautiful coral-red colour, thence it has been called *T. corallina*. This species is by most other writers considered a variety of *T. Europæa* or *T. grandifolia*.

T. platyphylla, Broad-leaved Lime-tree, has petals without nectaries; cordate, serrated leaves, downy beneath;

origin of the veins, woolly; branches, hairy; umbels, three-flowered; fruit woody, downy, turbinate, with prominent angles. This is the *T. grandifolia* of Ehrhart and other botanists. It is more common than the other species in Switzerland and the south of Europe. There are several specimens of this tree in England and Scotland, but they can scarcely be said to be wild. Specimens of this tree exist in the churchyard of Seidlitz in Bohemia, with leaves contracted to the form of a hood. They are said to have miraculously assumed this character from the time that the monks of a neighbouring convent were all hanged upon them.

All the foregoing species are distinguished by not having nectaries or scales at the base of their petals; there are six other species characterised by possessing nectaries. Four of these are inhabitants of North America.

T. alba, the White or Silvery Lime, has cordate, serrated leaves, unequal at the base, clothed with white down beneath, but smooth above, and four times longer than the petioles; fruit ovate, with five obscure ribs. This is the *T. argentea* of Desfontaines; *T. panonica* of Jacquin; and *T. tomentosa* of Moench. It is a native of the woods of Hungary, and is very readily distinguished from the other species by the whiteness of its leaves, which becomes especially evident when ruffled by the slightest breeze. It was introduced into this country in 1767, and there are now existing several very fine specimens, one at Walton-on-Thames, 60 feet high, and a number at Highclere in Berkshire. *T. petiolaris* was described by De Candolle from dried specimens sent to him from Odessa, where the tree is cultivated in gardens. The leaves are twice the length of the petioles, and their under surface downy like the last.

T. glabra, the Black or Black American Lime-tree, has leaves deeply cordate, serrated, and somewhat coriaceous and smooth; the petals are truncate and crenate at the apex, and equal in length to the style; the fruit ovate and somewhat ribbed. This tree is a native of North America in Canada and the northern parts of the United States; in the Southern states it is only found at a considerable elevation on the Alleghany mountains. In external character it very much resembles the European species; its flowers and leaves are however larger. Although it was introduced into this country by Miller as early as 1752, it is not much grown, and very few specimens exist. In America the wood and bark are used for much the same purposes as that of its representative in Europe.

T. laxiflora, Loose-flowered American Lime, has cordate, serrated, smooth leaves, loose panicles of flowers, emarginate petals, and globose fruit. It is a native of America, from Maryland to Georgia. It has been known in this country only since 1820, and but few specimens are at present planted. Loudon, in his 'Arboretum' (vol. i., p. 374), states his conviction that this and the other species of American limes are only varieties of *T. glabra*, and he has arranged them accordingly. He has however assigned no other reason for this opinion than their general resemblance.

T. pubescens, the pubescent American Lime, has somewhat cordate and oblique leaves, truncate at the base, and pubescent beneath; the petals emarginate, shorter than the style, and the fruit globose. It is a native of the southern parts of the United States, from Virginia to Georgia, where it is found principally on the banks of rivers. It is a much less vigorous tree than the two last, and has much smaller leaves and more slender branches. There is a variety called by Ventenat *T. p. leptophylla*, which has very thin leaves and delicate serratures.

T. heterophylla, the White American Lime, has ovate leaves, downy beneath, sometimes cordate at the base, sometimes obliquely or equally truncate; globose fruit with 5 ribs. This tree is abundant in Maryland, Delaware, and the Western states of America, and is found on the banks of the Susquehanna, Ohio, and Mississippi. The leaves and flowers of this species are larger than any other. It seldom attains a height of more than forty feet in its native districts, and specimens in Europe do not exceed more than twenty feet. It is a handsome ornamental tree, and deserving of cultivation. It has been known in France nearly a century, but was not introduced into England till 1811.

In the cultivation of the lime it should be placed in moist situations, in an argillaceous, loamy soil. It grows

better on plains than hills, and in moist than dry places. The trees may be propagated by seeds, which should be sown as soon as they are gathered; but this is a very slow process, and the more frequent mode of propagating them is by layers. In France a tree is cut down to the roots, and the shoots are encouraged to grow, and in the course of two or three years they may be planted in the positions in which they are to stand. Lime-trees will bear transplanting at a greater age than most trees; when large trees are transplanted, they should have their roots cut round three or four feet from the stem the year before they are taken up. This stunts their growth, and makes them bear removal better.

(Loudon, *Arbor. et Frut. Brit.*, vol. i. and iv.; Bisehoff, *Lehrbuch der Botanik*; Koch, *Flora Germanica*; Hooker, *British Flora*; Don's *Miller's Dict.*, &c.)

TILIACEÆ, a natural order of plants belonging to the syncarpous group of polypetalous Dicotyledons. This order consists of trees or shrubs, seldom of herbaceous plants, with simple, toothed, alternate leaves, furnished with stipules. The flowers are axillary. The calyx consists of four or five sepals, which are valvular in æstivation; the petals four or five, with mostly a little pit at their base; the stamens are hypogynous, mostly indefinite, with oval or roundish two-celled anthers bursting lengthwise; the disk is formed of glands, which are equal in number to the petals and opposite to them; the ovary is single, composed of from four to ten carpels, with a single style and stigma divided into lobes according to the number of the carpels; seeds numerous, with erect embryo, and abundant albumen. This order is nearly allied to Sterculiaceæ and Malvacæ, from which it differs in its glandular disk, distinct stamens, and two-celled anthers. The species, of which there are about two hundred and fifty, are arranged in thirty-two genera, and are generally diffused throughout the tropical and temperate parts of the globe.

Tiliacæ possess no active properties; they abound in a mucilaginous wholesome juice. The fibres of the inner bark are very tough, and are used for a variety of economical purposes. [TILIA.] The wood is generally white, light, and tough; that of *Grewia elastica* is used for making bows in India. The Trincomalee-wood used at Madras for making the Massoola boats is the produce of *Berrya Ammonilla*. The *Corchorus olitorius* is cultivated in Egypt for use as a pot-herb.



Tilia alba.

1. cutting, with flowers and leaf; 2. section of ovary, showing the cells; 3. single flower; 4. stamens.

TILIQUA, Mr. J. E. Gray's name for a genus of *Sauvages*. [SCINDIANS.]

TILLAGE, applied to arable land, is the stirring and preparing of the surface of the soil, so as to render it fit

for the vegetation of the seeds committed to it: it is also the destruction of noxious weeds.

The whole art of cultivation consists in tillage and manuring, and the profit of the husbandman depends on the perfection of the tillage and the economy of labour in producing the effect. A defect in tillage will cause a great deficiency in the crops in ordinary years. To ensure good crops, the soil should be in such a state that the sun and dews may readily be diffused through it, without giving it a wet appearance, or evaporating too rapidly. It requires great knowledge and experience to give any particular soil the exact portion of tillage which is suited to it. A fine garden-tillith, as it is called, is the most perfect for light soils which have been long cultivated and manured; when they can be brought to such a state that after continued rains the surface dries without forming a crust, and crumbles of its own accord, the tillage has been good; and the deeper this soil is stirred, the more it will produce: but where clay abounds in the soil, which in dry weather can be readily pulverised by *crushing* the dry clods, and be reduced to the finest powder, too much tillage may do more harm than good. The fine clay is soon converted into mud at the surface by the sun, because it is not sufficiently porous to let the water pass through it; it dries into a hard crust, which prevents the access of air, and consequently hinders the germination of the seed. It is only by abundant manuring, especially of animal origin, that the tendency in clays to cohere can be overcome. When tillage is effected it is best to stir clay soils as deep as possible by means of subsoil-ploughs, but they should not be pulverised so that the water cannot run down between the lumps and clods, and especially the surface in such a state of roughness that heavy rain will cover it with a coat of mud. The clods which are left on the surface imbibe the moisture more gradually, and fall to pieces, by which the young plants are enabled to stand, and, as it were, moulded up. This is particularly to be observed in winter after a frost, as all clay-land farmers are aware. It is very easily ascertained whether a soil will bear much tillage or not. It is only necessary to try it in a large pot or box; make the surface very rough by breaking the clods, then water it abundantly, and dry it in the sun; if a crust is formed in drying, that soil will not bear too much harrowing and pulverising. If the soil is left in a moderately rough state after sowing the seed; but if, after it dries, the surface is left smooth and porous, then the finer the tillage the better the seed will vegetate. The whole depends on the ready admission of air or its exclusion. When grass-seeds are sown on a surface which has been well pulverised, but this cannot be done if the soil is apt to run together when it dries, soon after the seed is sown. Some plants, especially those whose roots force their way through a very hard surface, are too weak to do so, and their growth is stopped by the least crust on the surface. preparatory tillage of the soil before sowing is a great advantage in the stirring of it, and in the growing. On this depends all the merit of the tillage for every kind of plant, especially those which have long and lent roots or extensive foliage, and which are particularly fitted for the sustenance of cattle. The effect of tillage is here most remarkable. If rows of turnips or bages be sown at such a distance that a subsoil-plough or other stirring implement can be used between the rows, the intervals be stirred more or less, and at different depths, it will be found that the deeper the tillage, until the foliage covers the ground, the larger the bulbs swell to a great size, the more abundant the produce will be. It is worth trying the experiment:—Sow Swedish turnips or bages in rows three feet apart: let some of the rows be kept clear of weeds by surface-hoeing, and some be thinned out to the distance of a foot between the rows; let the intervals be stirred to different depths; some six inches, and some nine inches deep. The result will be, that the first rows will appear to be sown much too far from each other, not being covered with the foliage of the plants; the second will be covered more and more as the plants grow deeper, and the last will completely cover the ground. The roots or bulbs will be found to be much larger to the richness of the foliage, and the

tilled rows will far exceed that of any of the others, while the first will, by comparison, appear a poor and scanty crop, however clear of weeds the surface may have been kept. The soil best suited for this experiment is a good light loam on a dry or well-drained subsoil; for stagnant moisture under any soil will chill the fibres and check the growth of the plants, however dry the surface may be. It was this which led Tull, the father of drill husbandry, to the conclusion that tillage was all that the soil required to maintain perpetual fertility. He carried his conclusion too far; but we shall not be wide of the truth if we assert that with proper tillage the soil will be gradually improved, and a much smaller quantity of manure occasionally added to recruit the waste produced by vegetation will render the soil much more fertile than it would be with more manure and less tillage: and as tillage can be increased by mechanical contrivances where labourers are scarce, whereas the supply of manure must generally be limited, it follows that, as a general rule, the land should be well and deeply tilled, due attention being paid to the nature of the soil and its property of retaining or transmitting moisture. Very loose sands should not be much stirred until they are consolidated by the admixture of marl, clay, chalk, or well-rotten dung; but in all cases the manure should be mixed as intimately as possible with the soil, and as deep as the tillage has gone, not including the stirring of the subsoil; for the roots will always penetrate thus far, and find the nourishment which they require. Those plants which throw out roots from the bottom of the stem, as wheat, barley, and oats, require the surface to be most pulverised and enriched to allow these roots to spread; a spring tillage is therefore highly advantageous, which can only be given when the seed has been deposited in rows by drilling or in patches by dibbling. This last method is found to give much finer crops, from the circumstance that the hoe not only loosens the earth between the rows, but also between the different patches of the growing corn, by which the coronal roots are strengthened and the tilering of the stems so much encouraged, that it is not uncommon to see twenty, thirty, or more strong stems all bearing fine ears arising from one tuft of plants, the produce of one or more seeds, whose roots are matted together and send out fibres in every direction. The crowding of several plants does not prevent their growth, provided the fibres can spread around in a rich mellow soil, well pulverised, and admitting the air and moisture readily.

As a perfect tillage requires much labour and minute attention, and in many situations where the farms are large labourers cannot be procured at moderate wages, nor can they always be depended upon to perform the work with sufficient care, mechanical ingenuity has been taxed to invent implements of tillage by which it may be more perfectly accomplished, and at a smaller expense, by using the power of horses instead of that of men, and making implements which will till a considerable breadth at once, and thus save time.

The old plough, and which, however it may be improved, still acts on the same principle of turning up a fresh portion of the soil, burying that which has for some time been at the surface, will probably always continue to be the chief implement of tillage; but the minuter operations, which are taken from garden culture, require particular contrivances to effect them by instruments. The harrows are but an imperfect substitute for the garden rake, and do not stir the soil to a sufficient depth. Other implements have therefore been invented, which by means of wheels can be regulated so as to act at a greater or less depth. These have received the different names of scarifiers, grubbers, cats-claws, or cultivators, according to the fancy of the inventors. Many of these answer the purpose well, and save labour. They can be used in all directions so as to pulverize the soil to any degree. Heavy rollers with and without spikes around them are used when many clods require breaking; and, although not yet adopted in this country, the Belgian *traineau*, a strong frame of wood boarded over, and loaded with weights if required, is a most effectual instrument in levelling the surface and crushing clods, without pressing them into the soil as the roller frequently does.

It would be endless to enumerate all the implements of tillage which are daily invented: some of the most useful have been already described. [ARABLE LAND; PLOUGH.]

As the cultivation of the soil approaches more to that of the garden, more perfect instruments will be used; such as can be directed with great accuracy between parallel rows of growing plants without danger of injuring them. When the width of the stiches or beds accurately corresponds with the width of the instrument, so that the wheels will run in the intervals and the horses step in the same, the soil may be tilled perfectly, although the rows of plants have but a small interval between them: and the largest field will thus present to the eye extended seed-beds or equal rows of growing plants, as we are accustomed to see in a kitchen-garden. The result will be the same as when for the sake of experiment we sow the common grains and leguminous plants of the fields in a plot of garden-ground: in such case the produce is so far greater, that it quite baffles our calculation when extended to a large surface, and hence the incredible results which we continually meet with in the reports of experiments on some new produce lately introduced: everything is on a magnified scale, owing to superior tillage. No doubt many fields possessed of fertile soils might, by attentive tillage, be made as productive as the best garden-ground. The Chinese have, as we are told, already accomplished this by their incredible numbers and indefatigable labour; but science and mechanical contrivance are a substitute for millions of labourers when judiciously applied—as our manufactures fully prove. The same ingenuity applied to tillage might increase the produce of the earth, if not indefinitely, at least far beyond what we may now suspect.

In the early ages of agriculture tillage was almost confined to the ploughing of fallows to clean the land, which was very imperfectly executed, and in ploughing the stubble of one crop to prepare for the seed of another, as long as the land would give a return for the labour. The idea of tillage for the sake of a permanent improvement of the soil was only entertained by a few men who reflected, and that of encouraging the vegetation while the crop was growing was not even thought of. The plough to stir and the harrows to cover the seed were the only instruments in use, and they were very rude of their kind. A return of three or four times the seed sown satisfied the farmer and the landlord; and yet the first was hardly repaid for his toil, and the landlord received for rent what now would scarcely satisfy the tithe-owner. The present state of agriculture may be contrasted with this, and perhaps hereafter the comparison may be as disadvantageous to us as it now appears in our favour when we look back a few centuries.

TILLANDSIA, the name of a genus of plants belonging to the natural order Bromeliaceæ. Linnæus says of the plants belonging to this genus, 'Tillandsiæ cannot bear water, and therefore I have given this name to the genus from a professor at Abo, who in his youth having an unpropitious passage from Stockholm to that place, no sooner set his foot on shore than he vowed never again to venture himself upon the sea. He changed his original name to Tillands, which means *on* or *by land*; and when he had subsequently occasion to return to Sweden, he preferred a circuitous journey of 200 Swedish miles through Lapland to avoid going eight miles by sea.' Dr. Elias Tilland, whose name and idiosyncrasy have thus been perpetuated, was professor of physic at Abo, and died in 1692, at the age of fifty-two. He published in 1683 an alphabetical catalogue of plants in the neighbourhood of his residence, which was afterwards followed by wood-cuts of 158 of the plants in the catalogue.

The genus Tillandsia of Linnæus comprehends the plants described by Sloane as *viscum caryophylloides*, and by Plumier as *Curagata*, and is characterised by possessing a persistent calyx divided into three oblong, lanceolate, pointed segments; a corolla tubular; longer than the calyx, with the limb divided into three segments; six stamens not so long as the corolla, and inserted into it, and the anthers sagittate; the ovary superior, surmounted by a style with a trifid obtuse stigma; the fruit, a trilocular capsule containing several seeds, each of which is supported on a long stalk of aggregate fibres, which in the end constitutes a feathery wing. The species are most of them parasitical, and are natives of South America.

T. utriculata, the Wild Pine of the colonists of Jamaica, has linear, channelled, recurved, dilated leaves, inflated at the base; stem closely paniced. It is found growing on old and decaying trees in the forests of Jamaica. The stem is three or four feet high, and the leaves are a yard long,

and placed within one another in such a way that the water which runs down them is retained in their expanded bases. The bases then swell out and form a reservoir or bottle, which, being contracted at the neck, prevents the heat of the sun from evaporating the water. These reservoirs will each hold about a quart of water, and during the dry season they are the resort of all kinds of animals for the sake of the water, and travellers are often able to obtain a supply of water from this source when all others fail. Dampier, in his Travels, gives the following account of this plant:—The wild pine is a plant so called because it somewhat resembles the bush of leaves which surround the true pine-apple. The wild pines commonly grow from some bunch, knot, or excrescence of a tree, where they take root and spring upright. The root is short and thick, from whence the leaves rise up in folds one within the other, spreading often to the top of the tree. They are of a good thick substance, and so compact as to catch and hold the rain-water when it falls. They will contain a pint, or a pint and a half, or a quart; and this water refreshes the leaves and nourishes the root. When we find these pines, we stick our knives into the leaves just above the roots, and let out the water, which we catch in our hats, as I have done many times myself to my great relief. The seeds of these plants are furnished with wings, by which they are blown from tree to tree, on which they grow. Unless they possessed such means of transportation, they would fall to the ground, where, being parasitical, the young plants would perish.

T. usneoides, the Long-Moss Tillandsia, or *Barbe de vieillard* of the French, the *Viscum caryophylloides* of Sloane, has a twisted, thread-shaped, scaly stem, much branched, with channelled leaves. This plant is a native of the forests of North America, from Virginia to Florida, also of the West India Islands and the Brazils. It has very minute roots, and its long wiry contorted stems creep over the stems and branches of old trees, sometimes hanging down in a bunch like the hairs of a horse's tail. The flowers are small and of a blue colour, and are developed at the ends of the branches. This plant grows on other trees in dry and arid plains, as well as in alpine districts. It attains a larger size in the more temperate localities. Its filamentous stems, when deprived of their bark, may be used for the same purposes as horsehair, and are used in this manner in America. They are also in some places made into cordage. The only preparation they require previous to being used is being put into water for a fortnight or more, according to the temperature, when, on being taken out and dried, the bark easily separates from the fibres, and they are fit for use. In medicine this plant has been recommended as a remedy in hæmorrhoids, also as an effectual diaphoretic.

T. monostachya, Single-spiked Tillandsia, has the radicle leaves linear, channelled, recurved, broad, and sheathing at the base; the stem simple, clothed with imbricated scales; the spikes simple; the bractæas ovato-concave. This plant is a native of the West Indies. The flowers are of a snow-white colour, appearing in the axils of the bracts, which surround a rachis two or three inches long, and this arises from a mass of leaves arranged in the form of a rosette. As the leaves and bracts are coloured variously, green and red and white, the whole plant looks at a distance like a large flower; and when numerous upon the trees on which they grow, they produce a very handsome and remarkable appearance. The leaves of this as well as most of the other species serve as reservoirs for water. About thirty species have been enumerated by botanists: most of them are inhabitants of South America, especially of Peru, and of the great forests of the Andes; two or three of the species have been found in the southern states of North America.

TILLEMONT, SEBASTIEN LENAIN DE, an historical writer of considerable note, was born at Paris 30th November, 1637. He was the son of Jean Lenain, master of the requests, and his wife Marie le Ragois. His excellence of character was manifested very early; and even as a child he always abstained from those mischievous pranks in which children commonly indulge. When between nine and ten years of age he was placed under the charge of the members of the religious Society then established in the vacant abbey of Port Royal, and under these instructors he devoted himself to the exercises of learning and piety. His favourite author, while at school, was Livy;

a preference indicative of the bias of his mind to the studies. He studied logic and ecclesiastical history, and Nicole; and his questions on the latter subject have evinced the earnestness with which he pursued it, and the knowledge of his instructor to a severe test. He studied the theology of Estius, from which, when about eighteen years of age, he turned with much satisfaction to the study of the Scriptures themselves, and of the Fathers, and while thus engaged he began to collect the historical notices of the Apostles and Apostolical Fathers, and to arrange them after the plan of Usher's *Annales*.

The tenderness of his conscience, and the strictness of his notions of duty, kept him for some time undetermined as to the choice of a profession. At the age of 23 he entered the Episcopal seminary of Beauvais, where he was received with such respect from his reputation for historical knowledge, that, fearing it might be a snare to his humility, he contemplated leaving it, but was persuaded to remain by Isaac de Sacy, one of the members of the Society of Port Royal, whom he had chosen for his spiritual guide. He remained three or four years in the seminary of Beauvais, and then spent five or six with Godefroi Hermant, canon of that city. He was much respected and beloved by the bishop of Beauvais, Choart de Buzanval, and fearing still that this estimation would make him vain, he suddenly left the place and returned to Paris, where he remained two years with his intimate friend and school-fellow at Port Royal, Thomas du Fossé; but not finding in Paris that retirement which he desired, he withdrew to St. Lambert, a country parish in the neighbourhood of that city.

In September, 1672, at the mature age of thirty-five, he became subdeacon, and fifteen months afterwards deacon. The following extract from a letter addressed to his brother (Pierre Lenain, then or afterwards subprior of La Trappe) evinces at once his piety and his humility. After stating that it was at the desire of Isaac de Sacy, his friend and guide, that he had become subdeacon and was about to take on him the deaconship, he goes on, 'I assure you, my dearest brother, that it is with great agitation and fear that I have resolved to comply with his wish, for I feel that I am far from those dispositions which I myself see to be necessary for entering upon this office: and above all, I am obliged to confess that I have profited little from the grace which I might have received from the order and duties of the subdeaconship. But on the other hand I could not resist one whom I believe I ought to obey in everything, and who, I am well aware, has the greatest love for me. I beg of you then, my dearest brother, to pray to God for me, and to ask him either to cause M. de Sacy to see things in a different light, or to give to me such dispositions that the advice of my friend may be for my salvation and not for my condemnation.'

In A.D. 1676 he received priest's orders, at the farther persuasion of De Sacy, who contemplated making him his successor in the office of spiritual director of the Bernadine nuns, now re-established in their original seat, the abbey of Port Royal, to the immediate neighbourhood of which establishment Tillemont removed. He was however, in 1679, obliged to remove, and he took up his residence at the estate of Tillemont, a short distance from Paris, near Vincennes, which belonged to his family, and from which he took his name. In A.D. 1681 he visited Flanders and Holland; and in A.D. 1682 undertook the charge of the parish of St. Lambert, where he had formerly resided, but soon gave it up at the desire of his father, to whom he ever paid the greatest respect and obedience.

Having prepared the first volume of his great work on ecclesiastical history, he was about to publish it when it was stopped by the censor, under whose notice, as a work connected with theology, it had to pass, and who raised some objections of the most frivolous character. Tillemont refused to alter the parts specified, deeming them not justly within the censor's province; and chose rather to suppress the work, upon which however he continued to labour diligently, though without any immediate intention of publishing it.

This exercise of the censorship led to an alteration of his plan: he determined to separate from the rest of his work the history of the Roman emperors and other princes whose actions were interwoven with the affairs of the Christian church, and to publish it separately: the first volume of this work, which, as not being theological, was exempt from the censorship, appeared in 1690, and was

received with general approbation. It excited a desire for the appearance of his Church history, and the chancellor Boucherat, in order to remove the obstacle to its publication, appointed a new censor. Thus encouraged, he brought out the first volume in 1693, under the title of 'Mémoires pour servir à l'Histoire Ecclésiastique des Six Premiers Siècles.' A note to this volume, on the question whether Jesus Christ celebrated the Passover the evening before his death, in which he examined the views of Bernard Lami, a learned priest of the Oratory, on that question, involved him in a controversy with that writer, who read Tillemont's note before publication, and examined the arguments contained in it in a subsequent work of his own. Tillemont in consequence addressed to Lami a letter, which is printed at the close of the second volume of his 'Mémoires,' and is remarkable for its spirit of modesty and meekness. Lami replied, but Tillemont declined to continue the discussion, thinking that he had said enough to enable those interested in the question to form a judgment. Faydit de Riom, an ecclesiastic whom the Congregation of the Oratory had expelled from their body, a man of considerable talent, but of jealous disposition, published at Bâle, A.D. 1695, the first number (28 pp. 4to.) of a work, to be continued every fortnight, entitled 'Mémoires contre les Mémoires de M. Tillemont.' It contained several violent and unjust strictures on the work, to which Tillemont did not reply, though some of his friends with needless apprehension procured the stopping of Faydit's work, which never proceeded beyond the first number. Faydit repeated his attack in a subsequent work, but it produced little effect.

The remainder of Tillemont's life was passed in the quiet pursuit of his studies. He was attacked by a slight cough at the end of Lent, 1697, and in the course of the summer was seized with fainting, owing to a sudden chill while hearing mass in the chapel of Notre Dame des Anges: toward the end of September his illness increased so as to excite the anxiety of his friends. He consequently removed to Paris for the sake of medical advice; and there, after an illness which rendered his piety and submissiveness to the divine will more conspicuous, he breathed his last, on Wednesday, 10th January, 1698, aged sixty years. He was buried in the abbey of Port Royal, in which the Bernardine or Cistercian nuns, to whom the abbey had originally belonged, were now again established.

The works by which Tillemont is known are, his 'Histoire des Empereurs,' and his 'Mémoires pour servir à l'Histoire Ecclésiastique.' The first was published in 6 vols. 4to.; the first four during the author's life, at intervals from 1690 to 1697: the remaining two after his death, in 1701 and 1738. The earlier volumes were reprinted at Brussels in 12mo., in 1707, et seq., and a new edition appeared at Paris, in 4to., in 1720-23, with the author's latest corrections. He explains his plan in the 'Avertissement' to the first volume: his intention was to illustrate the history of the Church for the first six centuries; but instead of commencing with the first persecutor, Nero, he goes back to Augustus, whose edict occasioned the journey of Joseph and Mary to Bethlehem, and thus determined the place of our Lord's nativity. The history ends with the Byzantine emperor Anastasius (A.D. 518). The style is unpretending, and consists for the most part of a translation of the original writers with slight modifications, and with such additions (marked by brackets) as were needed to form the whole into one continuous narrative, or such reflections as the author deemed requisite to correct the false morality of heathen writers. To each volume are appended notes relating to difficulties of history or chronology which require discussion of a kind or extent unsuited for insertion in the body of the work. 'There is nothing,' says Dupin, 'which has escaped the exactness of M. Tillemont; and there is nothing obscure or intricate which his criticism has not cleared up or disentangled.'

The 'Mémoires,' &c. extend to 16 vols. 4to., of which the first appeared in 1693; three volumes more during the author's lifetime, in 1694-5-6; and the fifth was in the press at the time of his death. These five volumes came to a second edition in 1701-2, and were followed in 1702-1711 by the remaining eleven, which the author had left in manuscript. This great work is on the same plan as the former, being composed of translations from the original writers, connected by paragraphs or sentences in brackets. Dupin characterizes it as being not a continu-

ous and general history of the Church, but an assemblage of particular histories of saints, persecutions, and heresies, a description accordant with the modest title of the work, 'Mémoires pour servir à l'Histoire,' &c. The author concerns himself chiefly with facts, without entering into questions of doctrine and discipline; and notices not all the saints in the calendar, but only those of whom there are some antient and authentic records. Each volume has notes of similar character to those given in 'L'Histoire des Empereurs.'

Tillemont supplied materials for several works published by others, as for the Life of St. Louis, begun by De Sacy and finished and published by La Chaise; for the lives of St. Athanasius and St. Basil, by Godefroi Hermant; of Tertullian and Origen, by Du Fossé, under the name of La Mothe, &c.

(*Vie de M. Lenain de Tillemont*, by his friend Troughay, afterwards canon of Laval, Cologne, A.D. 1711; Dupin, *Bibliothèque des Auteurs Ecclésiastiques du Dixseptième Siècle*; *Biographie Universelle*.)

TILLOCH, ALEXANDER, LL.D., was born at Glasgow on the 28th of February, 1759, and was educated with a view to following the business of his father, who was a tobacconist, and for many years filled the office of magistrate in that city. He was, however, more inclined to the pursuit of scientific knowledge than to the routine of business. His biographer states that in early life his attention was greatly attracted by the occult sciences, and that although he was not long subject to their delusions, he never was inclined to treat judicial astrology with contempt. One of the earliest subjects to which Tilloch applied himself was the improvement of the art of printing; his experiments have been alluded to in a previous volume. [STEREOTYPE, vol. xxiii., pp. 42 and 43.] After carrying on the tobacco business for a time in his native city in connection with his brother and brother-in-law, Tilloch abandoned it, and for several years exercised that of printing, either singly or in partnership with others. In 1787 he removed to London, where he subsequently resided; and in 1789 he, in connection with other parties, purchased the 'Star,' a daily evening newspaper, of which he became editor. This office he continued to hold until within a few years of his death, when bodily infirmities and the pressure of other engagements compelled him to relinquish it. The political opinions of Tilloch were temperate. For many years he devoted attention to means for the prevention of the forgery of bank-notes, and in 1790 he made a proposal to the British ministry on the subject, which met with an unfavourable reception. He then offered his invention to the French government, who were anxious to apply it to the printing of assignats; but, after some experiments had been made, and negotiations had been urgently sought by the French authorities, all communication on the subject was cut short by the passing of the Treasonable Correspondence Bill. In 1797 he presented to the Bank of England a specimen note, produced by block or relief printing, which was certified by the most eminent engravers to be impossible of imitation; yet nothing was done towards the adoption of his or of any similar plan.

Considering that there was room for a new scientific journal, in addition to that published by Nicholson, Tilloch published, in June, 1797, the first number of the 'Philosophical Magazine,' a periodical which has ever since maintained a high reputation as a record of the progress of science, and a digest of the proceedings of learned societies at home and abroad. Of this work he was sole proprietor and editor until a few years before his death, when Mr. Richard Taylor, who succeeded him in its management, became associated with him. In the earlier numbers of the 'Star' Tilloch published several essays on theological subjects, some of which, relating to the prophecies, were subsequently collected into a volume by another person, and published with the name 'Biblicus'; and in 1823 he issued an octavo volume entitled 'Dissertations introductory to the study and right understanding of the language, structure, and contents of the Apocalypse, in which he endeavours to prove that that portion of Scripture was written much earlier than is usually supposed, and before most of the apostolical epistles. His views on this and other points are discussed at length in a notice of this work, published soon after his death, in the 'Eclectic Review.' The last work undertaken by Tilloch was a weekly periodical entitled the 'Mechanic's Oracle,' devoted

principally to the instruction and improvement of the working classes. The first number appeared in July, 1824, and it was discontinued soon after his death, which took place at his residence at Islington, on the 26th of January, 1825.

Tilloch married early in life. His wife died in 1783, leaving a daughter, who became wife of Mr. John Galt. His religious opinions were peculiar, and he was one of the elders who acted as ministers of a small body who took the name of Christian Dissenters, and met for worship in a private house in Goswell Street Road. He was a member of many learned societies in Great Britain and elsewhere, and was proposed, about twenty years before his death, as a fellow of the Royal Society of London; but his name was withdrawn before coming to the ballot, in consequence of an intimation that he would be objected to, not on account of any deficiency in talent or character, but solely because he was proprietor of a newspaper. A memoir of Dr. Tilloch appeared in the 'Imperial Magazine' for March, 1825, from which, with the assistance of other obituary notices, the above account is condensed. This was reprinted in the last number of the 'Mechanic's Oracle,' with a portrait.

TILLOTSON, JOHN, D.D. (born 1630, died 1634), a prelate and one of the most celebrated divines of the Church of England. He was born at Sowerby in Yorkshire, a member of the great parish of Halifax, of a Puritan family. His father, who was engaged in the clothing trade, belonged to that extreme section of the Puritans who were for establishing a general system of Independency, and he belonged himself to an Independent church, of which Mr. Root was the pastor. After having been a pupil in the grammar-schools in the country, the writers of his life not having told us what schools they mean, but doubtless the grammar-school at Halifax was one, he became a pensioner of Clare Hall, Cambridge, in 1647, and a fellow of the college in 1651. It appears that he remained in the University till 1657. Puritanism was at that period in the ascendency at Cambridge; but Tillotson very early freed himself from his educational prejudices, became a great admirer of the writings of Chillingworth, and soon showed himself one of a class of persons who were then beginning to be considerable in England, who, taking their stand on the Scriptures, opposed themselves at once to Romanism on the one hand and to Calvinism on the other. This position he ever after maintained, and his celebrity arises principally from the ability with which he illustrated and defended, both from the pulpit and the press, the principles of Protestantism, and of a rational and moderate orthodoxy. It may be added also, that so much of the effects of his original Puritan education remained with him, that he was in politics a Whig, although it must be owned that he entertained and occasionally expressed notions of the duty of submission, which, if acted upon, would have maintained the House of Stuart on the throne.

Before he entered holy orders, he was tutor in the family of Prideaux, the attorney-general to Cromwell. This led to his residence in London, and brought him into acquaintance with several eminent persons. He was thirty years of age before he received ordination, and the service appears to have been performed with some degree of privacy, as it is, we believe, not known when or where it was performed, and only that the bishop from whose hands he received it was not a bishop of the English church, but the bishop of Galway in Scotland, Dr. Thomas Sydserf. All the supposed irregularities and imperfections of his early religious history, for amongst other things it was even asserted that he had never been baptized, were brought before the public by the non-juring party, when they saw him elevated to the primacy, from which Sancroft had retired.

It is said by his biographer, Dr. Thomas Birch, that he was not perfectly satisfied with the terms of ministerial conformity required by the act of 1662, which restored the Episcopal church of England; yet on the whole he judged it proper to accept of the terms, and to become a regular and conformable minister of that church.

He was for a short time curate at Cheshunt, and also for a short time rector of Ketton in Suffolk, a living to which he was presented by Sir Thomas Barnardiston, one of his Puritan friends. But he was soon called to a wider sphere of duty, being appointed, in 1664, the preacher at Lincoln's Inn, and lecturer at St. Lawrence's Church in

the Jewry. Here it was that those sermons were preached which attracted crowds of the most accomplished and learned of the time, and which have been since studied by many succeeding divines of eminence, at this day the basis of his fame.

The course of his preferment in the church during the reign of Charles II. was—1669, a prebendary in the church of Canterbury; 1672, dean of Canterbury; 1674, a prebendary in the church of St. Paul; and 1677, a canon residentiary in the same cathedral. But as soon as King William was established on the throne he was made dean of St. Paul's and clerk of the closet; and in April, 1689, he was nominated by the king to the archbishopric of Canterbury, an appointment which appears to have been really received by him with reluctance, and which exposed him to no small share of envy from very different parties. The truth is, that besides his eminent talents as having been the ablest opposer both of popery and irreligion, in a reign when the tendencies of so many persons in exalted stations were in one of these directions, he had a strong personal interest in the new king's affections, who is said, on credible authority, to have declared that there was no honest man than Dr. Tillotson, nor had he ever a better friend. He was archbishop only three years and a half, dying at the age of sixty-four. He was interred in the church of St. Lawrence Jewry, which had been the chief scene of his high popularity.

He died poor. He had survived both his children; but he left a widow, who was a niece of Cromwell and the stepdaughter of Bishop Wilkins, without any provision except the copyright of his works, which it is said he valued at 2500*l*. The king granted her a pension, first of 400*l*, and afterwards of 200*l* more, which she enjoyed till her death in 1702.

An account of the Life of Dr. Tillotson was published in 8vo., 1717. There is a much larger Life of him by Dr. Birch, prefixed to an edition of the works of Tillotson, and published also in an 8vo. volume, the second edition of which was printed in 1753, containing additional matter. There is also an account of him in Le Neve's 'Lives of the Protestant Archbishops of England.' Birch's edition of the Works is in 3 vols. folio, 1752.

TILLY, or TILLI, JOHN TSCERCLAS, Count, was the son of Martin Tserclas, of Tilly. The Tserclas, whose name is also written Tserclaus, were an old patrician family of Brussels; John, a member of this family, acquired, in 1448, the lordship of Tilly, in South Brabant. John Tilly was born in 1559, at the castle of Tilly, and he early entered the order of Jesuits, from whom he acquired that spirit of fanaticism, of blind obedience, and of absolute command, which distinguished him during his whole life. He soon abandoned his ecclesiastical profession, and entered the army of Philip II., king of Spain and lord of the Netherlands, and he learned the principles of war under Alba, Requesens, the governor of the Netherlands, Don Juan of Austria, and Alexander Farnese. In the war of the Spaniards against the Protestant inhabitants of the northern Netherlands he acquired that hatred of heresy and that warlike enthusiasm for the Roman Catholic religion, which became one of the most prominent features of his character. Towards the end of the sixteenth century he entered the service of the emperor Rudolph II., and distinguished himself, first as lieutenant-colonel, and afterwards as colonel and commander of a regiment of Walloons, in the wars against the Hungarian insurgents and the sultans Murad III. and Ahmed I. After the peace of Sitvatorok in 1606, between Rudolph II. and Ahmed I., he was appointed commander-in-chief of the army of Maximilian, duke of Bavaria, which was in a very disorganized state. In 1609 Tilly commanded the expedition against Donauwerth, an imperial town which had been put under the ban for having persecuted the Roman Catholics, and which surrendered to Tilly without defence. The Liga, or the union of the Roman Catholic states in Germany, appointed him commander-in-chief of the troops, and he held this high office until his death. He gained the first great victory in the Thirty Years' War, which broke out in 1618. [THIRTY YEARS' WAR.] After having conquered the Upper Palatinate with the troops of the Liga and those of the duke of Bavaria, he proposed to the Imperial generals to pursue the army of Frederick, king of Bohemia, instead of taking winter-quarters, and thus losing all the fruits of their conquests. Warlike

winter was, in the seventeenth century, a very uncommon thing, and Tilly met with much opposition to his plan; but at last the Imperial generals consented to continue the war. Tilly attacked the Bohemians, who had taken up a fortified position on the Weisse Berg, near Prague, and in a few hours the Bohemian army was nearly destroyed (8th of November, 1620), while only some hundreds of the Bavarians were killed. Several of the Bohemian nobles, who lived at Prague or resided in their castles, were warned by Tilly to fly if they would avoid the vengeance of the emperor; but they paid no attention to this generous advice, and were surprised: twenty-seven of them were beheaded.

After the brilliant victory on the Weisse Berg, Tilly hastened to the Rhine for the purpose of preventing the count of Mansfield from joining the margrave of Baden. He succeeded in this object by his skillful manoeuvres. The margrave of Baden-Durlach was attacked in the defiles of Wimpfen, and defeated, after an heroic resistance (1622). On the 2nd of June, 1622, he defeated Christian of Halberstadt at Höchst; he pursued Christian and Mansfield to Westphalia; defeated them at Stadt-Loos, near Münster, in a battle which lasted three days (4th to the 6th of August, 1623), and forced them both to disband their troops and to take refuge in England. For his victory at Stadt-Loos, Tilly was created a count of the empire. It has been related, in the article THIRTY YEARS' WAR, how skillfully Tilly first weakened and then destroyed the army of king Christian IV. of Denmark; but the principal glory of this campaign was earned by Waldstein, who, after having joined Tilly on the banks of the Lower Elbe, persuaded Tilly to turn his arms against Holland, and to leave him the conquest of Denmark. After Waldstein had been deprived of his command in 1630, and Gustavus Adolphus, king of Sweden, had landed in Germany, Tilly was appointed field-marshal and commander-in-chief of the imperial army. He appreciated so justly the military talents of his new opponent, that in the assembly of the electors at Ratisbon he declared Gustavus Adolphus to be so great a commander, that not to be beaten by him was as honourable as to gain victories over other generals.

The first great event of the new campaign was the capture of Magdeburg, on the 10th of May, 1631. The Croats and the Walloons in the imperial army committed unheard-of cruelties against the unhappy inhabitants; 30,000 of them were killed, and the town was entirely destroyed after three days' plunder. It has generally been believed that some Imperial officers besought Tilly to stop the atrocities of the soldiers, and that he coolly answered, 'Let them alone, and come back in an hour.' But this is a mere invention, and however severe Tilly was, he cannot be charged with having urged the commission of cruelty, although he considered the plunder of a conquered town as the fair reward of the soldier. On the 14th of May Tilly made his entrance into the smoking ruins of Magdeburg. In a letter to the emperor he said that since the destruction of Troy and Jerusalem there had been no such spectacle as that which Magdeburg presented. Six months later Tilly, who was in a fortified camp at Breitenfeld near Leipzig, was forced, by the impetuosity of his lieutenant, Pappenheim, to engage in battle with Gustavus Adolphus before his reinforcements had arrived. Tilly himself was successful in his attack on the left wing of the Swedes, which was broken, and the elector of Saxony, who commanded it, fled as far as Eilenburg. But Gustavus Adolphus, who had beaten the left wing of the Imperialists, under the command of Pappenheim, stopped the progress of Tilly, and after a long and bloody struggle the imperial army was routed. When Tilly saw the flight of his soldiers, he swore that he would not survive the day on which he, the victor in thirty-six battles, was to fly for the first time in his life. Alone on the field the old field-marshal, bleeding from three wounds, shed tears of despair, and looked for death as his only consolation. However Duke Rudolph of Saxe-Lauenburg persuaded him to withdraw; and Tilly, putting himself at the head of four regiments of veterans, fought his way through the main body of the Swedish army. He narrowly escaped from the bold attack of a Swedish captain, called 'Long Fritz,' who was killed by a pistol-shot at the moment when he was seizing the field-marshal (17th of September, 1631). After the loss of the battle of Leipzig, fortune abandoned Tilly forever. Although he afterwards succeeded in driving the

Swedes from Franconia, Gustavus Adolphus compelled him to retire beyond the Lech. In order to prevent the Swedes from penetrating into Bavaria, Tilly took up a very strong position near Rain, on the right bank of that river. Gustavus Adolphus, having arrived on the left bank opposite Rain, opened a fire from all his batteries on the Bavarian camp, while his pontoons endeavoured to construct a bridge over the river (5th of April, 1632). Tilly made the most active resistance, but a ball broke his thigh, and he was removed from the field and carried to Ingolstadt. After the fall of Tilly, the elector of Bavaria abandoned his invincible position, and the Swedes crossed the river. Tilly died on the day after the battle, in his seventy-third year, without leaving any issue.

Tilly was a little ugly man, with red hair, large whiskers, a pale face, and piercing eyes. He continued to lead a monastic life in the midst of the noise and the licence of his camp; he boasted that he had never touched wine nor women; he spoke little, but thought much; he despised honours and money; the emperor wished to confer the duchy of Brunswick-Calenberg upon him, but Tilly refused it, and he died poor.

(Julius Bellus, *Laurea Austriaca*; Breyer, *Geschichte des Dreissigjährigen Krieges*; Schiller, *Geschichte des Dreissigjährigen Krieges*; Leo, *Universal-Geschichte*.)

TILSIT (more correctly TILSE), the chief town of Prussian Lithuania, is situated in 55° 4' N. lat. and 21° 56' E. long., in a fertile country on the south bank of the river Memel (called in Russia the Niemen). The little river Tilzele (pronounced Tilshelé) forms on the south side of the town a large basin, and discharges itself, between the town and the suburbs, into the Memel, over which there is a bridge of boats, which is 1150 feet long without the approaches. The thirty-six boats or pontoons are removed at the approach of winter into the Tilzele, and replaced in spring. The master of the Teutonic Order built the old castle in 1289, which was repaired and enlarged in 1356; but the present castle, to the east of the town, was not built till 1537. In process of time a considerable town grew up round the castle; favoured by its excellent situation it became the channel for the great trade between the interior of Russian Poland and the port of Memel, so that it was one of the most flourishing towns in the province. The principal buildings and public institutions are, the castle, the town-hall (built in 1752-55), the German Lutheran church, with a very lofty and curious steeple, the very pretty Lithuanian church, the Calvinist church, and the Roman Catholic chapel on an eminence at a short distance from the town; the gymnasium, founded in 1586; a Lutheran and a Roman Catholic hospital, a poor-house and infirmary, and other charitable institutions. The barracks, 600 feet in length, 36 in breadth, and two stories high, were erected in 1794-1800, by a society of the citizens, that the troops might not be quartered in the houses. The inhabitants, about 12,000 (exclusive of the garrison), chiefly draw their subsistence from the trade in corn, linseed, and timber; many are engaged in agriculture (the town possesses lands of its own, and many of the citizens have considerable estates); and there are likewise breweries, distilleries, tanneries, and all the trades usually carried on in large towns. The shoes of Tilsit are celebrated for durability and neatness, and great quantities of them are exported. There are many good gardens in the town and environs, particularly those of the Horticultural Society.

Tilsit has acquired historical celebrity by the treaties of peace concluded on the 7th and 9th of July, 1807, between France, Russia, and Prussia, the terms of which are too well known to be stated in this place: yet in five years after this peace, which seemed to have laid continental Europe prostrate at the feet of Napoleon, a part of that immense army which was to have subdued Russia (Macdonald's division) was seen to return desponding, silent, and miserable over that same river which had so lately witnessed the triumph and splendour of the conqueror.

(Müller, *Handbuch*; Preuss, *Beschreibung von Preussen*; Hassel, *Geogr.-Handbuch*.)

TILT-HAMMER, a large hammer worked by machinery, impelled either by a water-wheel or a steam-engine. Such hammers are extensively used in the manufacture of iron and steel, and the name *till-mill* is sometimes applied to the mechanism of which they form the principal feature.

In the process of *shingling* or *blooming* [IRON, vol.

xiii., p. 34], the heated iron is subjected to a very heavy hammer, the strokes of which not only bring it into a new form, but also force out from its substance considerable quantities of dross. The kind of tilt-hammer formerly used for this purpose is represented by Holland, in his treatise on 'Manufactures in Metal,' in Lardner's 'Cabinet Cyclopædia.' He describes the shaft or helve of the hammer as nine feet in length, and thirty or forty inches in circumference, made of ash, and clamped at intervals with stout iron hoops. This shaft passed through the head of the hammer, which was a mass of cast-iron, weighing seven or eight cwt., and was secured at the opposite end to a massy collar of cast-iron called the *hurst*, the projections or pivots of which formed the axis or centre of motion, and were sustained by a strong frame-work of timber. Above the hammer was placed a very strong but elastic beam, formed of tough ash bound with iron hoops, and against this, which acted as a spring to increase the force of the descending stroke, the head of the hammer was thrown up by the revolution of a ponderous circular frame of iron, with four projecting arms or teeth, which came in contact with the shaft very near to the head of the hammer. This circular frame, or *arm-case*, was fixed immediately upon the axis of the water-wheel which supplied the moving-power. In modern iron-works the shingling-hammers are usually formed entirely of iron, the piece forming the actual head of the hammer being inserted into a ponderous cast-iron helve in such a manner that it may be removed when worn out. The spring-beam is frequently dispensed with, and the hammer is lifted either by cogs or arms acting upon the extremity of the helve, beyond the hammer-head, or by an eccentric, or cam, revolving in contact with a projection from the under side of the helve, between the hammer-head and the axis or centre of motion. Holland represents a tilt-hammer of the latter construction, which is about six tons in weight, and nine feet five inches long from the axis to the centre of the head. The hammer-head itself is circular, and weighs about eight cwt. Such a hammer makes about one hundred and fifty strokes per minute.

The tilt-hammers used in the manufacture of steel are smaller and much more rapid in their action. Instead of receiving the impulse of the cams near their head, such hammers are set in motion by tappets or cogs striking downwards upon the tail of the helve or shaft, which is prolonged beyond the axis. The tail of the helve is thus thrown down forcibly upon an anvil, from which it rebounds with great velocity, causing the hammer to make from three to seven hundred strokes in a minute. Tilt-hammers are applied with great advantage to the forging of anchors, axles, &c.

When tilt-hammers are impelled by water-wheels, it is advisable to fix the cams or arms upon a separate shaft, which may revolve at any required velocity without increasing the velocity of the water-wheel itself, by the intervention of suitable cogged-wheels. Without such an arrangement much of the useful effect of the water may be lost, owing to the necessity of urging the wheel to a high speed.

TIMAEUS (*Τίμαιος*), the son of Andromachus, was born at Tauromenium in Sicily, whence he is sometimes called a Tauromenian, and sometimes a Sicilian, to distinguish him from other persons of the same name. The year of his birth was B.C. 352. He was a disciple of Philiscus of Miletus, who had himself been instructed by Isocrates. He was driven from his native country by Agathocles, the tyrant of Syracuse, whereupon he went to Athens. This seems to have happened in the year B.C. 310, when Agathocles, after the battle of Himera, and before taking his army over to Africa, confiscated under various pretexts the property of his wealthy subjects, and endeavoured to secure his possessions in Sicily by putting to death or sending into exile such as he thought ill-disposed towards him. (Diodorus Sic., xx. 4.) Timaeus spent fifty years at Athens in reading and studying. (Polybius, xii. 25.) About the year B.C. 260, when Athens was taken by Antigonos, Timaeus returned to his native country, either to Tauromenium or to Syracuse, where he spent the remainder of his life, and died, B.C. 256, at the advanced age of ninety-six.

Timaeus wrote a great historical work, the main subject of which was a history of Sicily. It began at the earliest times, and brought the events down to Olympiad 129 (B.C. 264), where the work of Polybius begins. (Polybius,

i. 5.) How many books the history contained is uncertain, though we know that there were more than sixty. It appears to have been divided into large sections, each of which formed in itself a separate work, whence it was spoken of by several writers as so many independent works. Thus one section bore the title of *Σικελία καὶ Ἰταλία* and contained the early history of Sicily in connection with that of Italy; another was called *Σικελία καὶ Ἑλλάς*, and contained the history of Sicily and Greece during the time of the Athenian expeditions to Sicily. Another part again contained the history of Agathocles; and the last the history of Pyrrhus, especially his campaigns in Italy and Sicily. This last section was, according to the testimony of Cicero (*Ad Famil.*, v. 12), a separate work, though it regards the period which it comprehended, it may be viewed as a continuation of the great historical work.

This history of Timaeus, which, with the exception of a considerable number of fragments, is now lost, was commenced by him during his exile at Athens, and at a very advanced age; but he did not complete it till after his return to his own country; and it was here that he added the history of the last years of the reign of Agathocles and wrote the history of Pyrrhus. As regards the character and value of the work the antients do not agree. Polybius is a vehement opponent of Timaeus, and complains of his ignorance of political as well as military affairs; he further states that Timaeus made blunders in the geography even of places and countries which he himself had visited. His knowledge, he says, was altogether derived from books; his judgment was puerile; and the whole work bore strong marks of credulity and superstition. But this is not all that Polybius blames: he even charges him with wilfully perverting the truth. The fondness which Timaeus himself had for censuring others is said to have drawn upon him the nickname of *Ἐπιμαρῆς* (fault-finder). (Athenæus, vi., p. 272.) Most parts of this severe criticism of Polybius may be perfectly just, but as regard to others we should remember that these two historians wrote their works with such totally different views that the work of Timaeus, who knew the world only from his books, must in many respects have appeared absurd to the author of a 'pragmatical' history, and to a statesman and general like Polybius. But the loss of the work of Timaeus, even if he did no more than make an unskilful compilation of what others had told before him, is one of the greatest in ancient history. Other ancient writers such as Diodorus, Agatharchides, Cicero, and others, judge far more favourably of Timaeus. The style of the work, as far as we can judge from the fragments, is justly censured by some antient critics for its rhetorical and declamatory character; although others, like Cicero (*De Orat.*, ii. 14; *Brutus*, 95), speak of it with praise. Timaeus is the first Greek historian who introduced a regular system of chronology, that is, he regularly recorded events according to Olympiads and the archons of Athens; and although, in the early period of his history, his want of criticism led him into gross chronological errors, he set the example which others found very useful and convenient. It must have been with a view to an accurate study of chronology that he wrote a work on the victories in the Olympian Games, of which we still possess a few fragments.

The fragments of Timaeus are collected in Götter's work, 'De Situ et Origine Syracusarum,' p. 207, &c., which also contains (pp. 179-206) an elaborate dissertation on the life and writings of Timaeus. The fragments are also contained in C. and T. Müller, 'Fragmenta Historicorum Graecorum,' Paris, 1841, pp. 193-233. Compare *Vocab. De Historicis Graecis*, p. 117, edit. Westermann; *Class. Fast. Hellen.*, iii., p. 489, &c.

TIMAEUS (*Τίμαιος*), a Greek Sophist, who, according to the supposition of Ruhnken, lived in the third century of the Christian æra. Concerning his life nothing is known, his name has only come down to us in connection with a little vocabulary containing the explanation of words and phrases which occur in the writings of Plato. It bears the title *ἑκ τῶν τοῦ Πλάτωνος λέξεων*, and is dedicated to one Gentianus, of whom likewise nothing is known. Whether we possess the genuine and complete Vocabulary of Timaeus is doubtful; and from the title, as well as from certain articles in it which have no reference to Plato, and must undoubtedly be regarded as interpolations, one might feel inclined to consider the work as it now stands

as an abridgment of the Glossary of Timaeus, if Photius, who must have had the genuine work before him, did not describe it as a very little work (*βραχὺ ποιημάτων ἐν ἐπιλόγῳ*). But notwithstanding its brevity, the work is very valuable; and Ruhnken owns that he has not discovered in it a single instance of a word or a phrase being explained incorrectly. There is only one MS. of this Glossary, which appears to have been made in the tenth century of our æra, and which was unknown until Montfaucon drew attention to it. It was first edited, with an excellent commentary, by Ruhnken, at Leyden, 1754, 8vo.; a second and much improved edition appeared in the same place, 1789, 8vo. Two other editions have since been published in Germany, with additional notes by G. A. Koch (Leipzig, 1828 and 1833, 8vo.).

Suidas (*s. v. Τιμαῖος*) ascribes to Timaeus, the Sicilian historian, a rhetorical work, called *Συλλογὴ ῥητορικῶν ἀφορισμῶν*, in sixty-eight books, which Ruhnken, with great probability, attributes to Timaeus the Sophist, who wrote the Glossary to Plato.

(Ruhnken, *Praefatio ad Timaei Glossarium Platonium*.)

TIMAEUS (*Τιμαῖος*), of Locri, a Pythagorean philosopher. He was a contemporary of Plato, who is mentioned among his pupils, and is said to have been connected with him by friendship. (Cicero, *De Finibus*, v. 29; *De Re Publ.*, i. 10.) There exists a work, *Περὶ τῆς τοῦ κόσμου ψυχῆς* ('De Anima Mundi;' or, on the Soul of the Universe), written in the Doric dialect, which is usually ascribed to Timaeus the Locrian. It contains a brief exposition of the same ideas which are developed in the Dialogue of Plato, which is called after him Timaeus. (Tennemann, *System der Platonischen Philosophie*, i., p. 93, &c.) Separate editions of it have been published by D'Argens, at Berlin, 1762, 8vo., with a French translation; and by J. J. de Gelder, at Leyden, 1836, 8vo.

This Timaeus of Locri is said by Suidas to have also written the Life of Pythagoras; but the usual carelessness of Suidas renders this a doubtful point, as he may possibly have confounded the Locrian with the Sicilian Timaeus, who in his great historical work must have treated of the History of Pythagoras at considerable length.

(Fabricius, *Biblioth. Graec.*, iii., p. 94, &c.; Gøller, *De Situ et Origine Syracusarum*, p. 200, &c.)

TIMALIA, a genus of birds characterized by Dr. Horsfield.

Generic Character.—Bill strong compressed, deep (altum). Nostrils subrounded. Wings short, rounded. Tail elongated and graduated. Feet strong: hind-claw twice as large as the middle anterior claw.

Dr. Horsfield states that a peculiar character is exhibited in both the species of *Timalia* recorded by him, in the structure of the plumes, which cover the back and the upper parts of the neck, as well as the breast, belly, vent, and thighs. He remarks that the separate filaments (*radii* of Illiger), which constitute the vanes or webs of those plumes, are not in close contact, as is generally the case, but, being inserted into the shaft at a small distance from each other, they diverge with perfect regularity. The parts which they cover, says Dr. Horsfield in continuation, are accordingly marked with delicate parallel lines, and wherever several plumes lie over each other, they form a beautiful reticulation. On the posterior part of the abdomen, the vent, and the thighs, the plumes have a similar structure; but the filaments are greatly elongated and pendulous, so as to envelop those parts with a lax plumose covering, which on near inspection appears covered with delicate hairs. This appearance is produced by a series of very minute parallel villi, on each of the separate filaments, arranged with great regularity and beauty. Plumes in which this structure can be discerned with the naked eye are named decompound by Illiger, and described as those whose radii are pinnated with smaller lateral radii; and the effect which the arrangement of these decompound plumes has in the appearance of the bird is exhibited with accuracy both in the figure of *Timalia pileata* and *Timalia gularis*.*

Example, *Timalia pileata*.

Description.—Body ovate, rather stout. General colour above, brown with an olivaceous tint; underneath, testaceous inclining to grey. Head capped with saturated chestnut. Throat and cheeks white. Breast white inclining to grey, marked with intensely black stripes by the

shafts of the plumes. A narrow white band commences at the forehead, near the base of the bill, passes backward, encircles the eye, and unites with the white plumes of the cheeks. Axillæ white; which colour also shows itself in a narrow border of the wing. Quills and tail-feathers of a more pure brown colour than the other parts; very narrow transverse undulations, of a darker colour, observable on the tail-feathers by close examination. Plumes of the hypochondriæ, thighs, and vent, long, pendulous, decompound, and villose. Lesser wing-coverts, as well as the plumes which cover the nape and back, greyish-blue at the base; which colour shows itself on the separate filaments or radii, if the plumes are accidentally deranged. Tail underneath brown, with a hoary tint. Bill black and shining. Feet brown. (Horsf.)

Locality, Habits, &c.—Dr. Horsfield observes that the species is not unfrequent in the groves and small woods which abound throughout Java. It often, he says, approaches villages and plantations, constructing its nest in the hedges; and he speaks of it as one of the social birds that delight to dwell in the vicinity of cultivation. In large forests he did not notice it. He describes its flight as low and interrupted, and adds that wherever it resides it is a welcome neighbour, in consequence of the peculiarity and pleasantness of its note, which consists of a slow repetition of the five tones of the diatonic scale (C, D, E, F, G), which it chants with perfect regularity, several times in succession, and at small intervals of time. Dr. Horsfield further remarked that the sixth tone was sometimes added; but as this required apparently an extraordinary effort, it was by no means so agreeable to a musical ear as the simple repetition of the five notes, which appeared to be the natural compass of the bird's organs. (*Zoological Researches in Java*.)



Timalia pileata. (Horsf.)

TIMALINÆ, Mr. G. R. Gray's name for his third subfamily of *Tuididæ*. [THRUSHES; TIMALIA.]

TIMANEES. [SIERRA LEONE.]

TIMANTHES, a native of Sicyon or of Cythnos, was one of the most celebrated painters of Greece; he was contemporary with Zeuxis and Parrhasius, and lived about 400 B.C. The works of Timanthes were distinguished particularly for their invention and expression, and one of the chief merits of his invention was, that he left much to be supplied by the imagination of the spectator. There is a remark in Pliny (*Hist. Nat.*, xxxv. 36), probably a quotation, which bestows the highest praise upon Timanthes: it says, though in execution always excellent, the execution is invariably surpassed by the conception. As an instance of the ingenuity of Timanthes' invention, the same writer tells us of a picture of a sleeping Cyclops, painted upon a small panel, but in which the painter had conveyed a perfect idea of the giant's huge size, by adding a few satyrs measuring his thumb with a thyrsus.

Though Timanthes was evidently one of the greatest painters of antiquity, antient authors have mentioned only five of his works: Pausanias makes no mention of him at all, and Cicero classes him among the painters who used only four colours.* He painted a celebrated picture of the

* See 'Dictionary of Greek and Roman Antiquities,' art. 'Colours.'

stoning to death of the unfortunate Palamedes, the victim of the ignoble revenge of Ulysses for having proclaimed his apparent insanity to be feigned: a subject worthy of the pencil of a great master. This picture is said to have made Alexander shudder when he saw it at Ephesus. (Tzetzes, *Chil.*, viii. 198; Junius, *Cat. Artif.*, v. 'Timanthes.') Timanthes entered into competition with Parrhasius at Samos, and gained the victory; the subject of the paintings was the contest of Ajax and Ulysses for the arms of Achilles. [PARRHASIUS.] His most celebrated work however was that with which he bore away the palm from Colotes of Teos; the subject was the Sacrifice of Iphigenia; and perhaps no other work of ancient art has been the object of so much criticism, for and against, as this painting, on account of the concealment of the face of Agamemnon in his mantle. The antients have all given the incident their unqualified approbation, but its propriety has been questioned by several modern critics, especially by Falconet and Sir Joshua Reynolds; Fuseli however, in an elaborate and excellent criticism in his first lecture, has probably finally settled the matter in favour of the painter. The Sacrifice of Iphigenia was given as the subject of a prize-picture to the students of the Royal Academy in 1778, and all the candidates imitated the 'trick' of Timanthes, as Sir Joshua Reynolds terms it, which was the origin of his criticism upon the subject in his eighth lecture: he says, 'Supposing this method of leaving the expression of grief to the imagination to be, as it was thought to be, the invention of the painter, and that it deserves all the praise that has been given it, still it is a trick that will serve but once; whoever does it a second time will not only want novelty, but be justly suspected of using artifice to evade difficulties.'

The shallow remark of Falconet about Timanthes' exposing his own ignorance by concealing Agamemnon's face, is scarcely worthy of an allusion. It may be questioned whether Agamemnon, under such circumstances as he was placed, could have been well or even naturally represented in any other way; although many things might combine to render his presence at the sacrifice absolutely necessary, still it is not to be supposed that he could calmly stand by and be an eye-witness of his own daughter's immolation; notwithstanding his firm conviction that his attendance was necessary to sanction the deed, he could not look upon it; it would be unnatural. The criticism of Quintilian, Cicero, and others, that the painter, having represented Calchas sorrowful, Ulysses much more so, and having expressed extreme sorrow in the countenance of Menelaus, was in consequence compelled to conceal the face of the father, is not more pertinent than that of the modern critics. 'They were not aware,' says Fuseli, 'that by making Timanthes waste expression on inferior actors at the expense of a principal one, they call him an improvident spendthrift, and not a wise economist.'

Falconet observes that Timanthes had not even the merit of inventing the incident, but that he copied it from Euripides: upon this point Fuseli remarks—'It is observed by an ingenious critic that in the tragedy of Euripides the procession is described: and upon Iphigenia's looking back on her father, he groans and hides his face to conceal his tears: whilst the picture gives the moment that precedes the sacrifice, and the hiding has a different object, and arises from another impression' (v. 1550).

'I am not prepared with chronologic proofs to decide whether Euripides or Timanthes, who were contemporaries about the period of the Peloponnesian war, fell first on this expedient; though the silence of Pliny and Quintilian on that head seems to be in favour of the painter, neither of whom could be ignorant of the celebrated drama of Euripides, and would not willingly have suffered the honour of this master-stroke of an art they were so much better acquainted with than painting, to be transferred to another from its real author; had the poet's claim been prior.' As far as regards priority, the 'expedient' was made use of by Polygnotus long before either Timanthes or Euripides: in the Destruction of Troy, in the Lesche at Delphi, an infant is holding his hands over his eyes, to avoid the horrors of the scene. (Pausanias, *Phoc.*, x. 26.)

The fifth work of Timanthes mentioned by the antients was the picture of a hero, preserved in the time of Pliny in the Temple of Peace at Rome, an admirable performance.

There was another ancient painter of the name of Timanthes; he was contemporary with Aratus, and distinguished himself for a painting of the battle of Phelous in Arcadia, in which Aratus gained a victory over the Spartans, Olym. 135.1: 240 B.C. Plutarch praises the picture: he terms it an exact and animate representation (Aratus, 32).

TIMBER-TRADE. Several centuries ago the woods and forests of England were sufficient to supply the timber required for the building of ships and houses, as well as for fuel. In the sixteenth century we begin to hear complaints of their exhaustion. An act having been passed in 1531 requiring coopers to sell their barrels at fixed prices (23 Hen. VIII., c. 4), they were a second time another act (35 Hen. VIII., c. 8), passed twelve years afterwards, to increase their prices. Various circumstances rendered this change necessary; but at the time of the greater scarcity of timber, though only one cause, the rise of the material, was regarded as the sole one, the evident from an act passed during the same reign for the preservation of woods (35 Hen. VIII., c. 17), the preamble of which 'the decay of timber and iron-works universally within this realm of England is so grievous and great, that unless speedy remedy in that behalf be provided, there is great and manifest likelihood of want and lack as well of timber for building, making, repairing of houses and ships, as also for fuel and fire-works.' The act relating to the price of barrels required, amongst other things, that the exporters of beer should import casks sufficient to replace the barrels sent out of the country, and the other act was designed to enforce certain regulations respecting the felling of trees, and to prevent the conversion of woodlands into pasture or tillage. The woods of Kent, Sussex, and Surrey, where iron-works had been carried on from very ancient times, were exempt from the provisions of this act. In 1558 however an act was passed (1 Eliz., c. 15), entitled 'An Act that trees shall not be felled to make coles for the making of iron, which prohibited the use of timber one foot square in iron-works within fourteen miles of the sea, or within the same distance of eight of the principal rivers of England, or any navigable stream having an outlet on the coast, but the three southern counties previously mentioned were exempt from the operations of the act. The design was to have been to encourage the trade in timber for building, and to benefit those parts of the country that did not possess a sufficient supply. Iron-works had been subsequently erected not far from London, and within the prescribed distance of the Thames, as well as within other limits, and which required so much timber, the woods 'daily decay and become scanty.' An act was passed in 1580 (23 Eliz., c. 5) to prevent the erection of new iron-works within the limits mentioned by the act of 1558, and the restrictions respecting felling trees were renewed. In 1592 the subject again attracted notice, an act was passed (35 Eliz., c. 11), which, amongst other things, prohibited aliens exporting fish, unless they exported clapboards; and altogether prohibited the exportation of wine-casks. In the following century the same prices turned in favour of pit-coal. Before the discovery of the process of smelting iron with pit-coal, the trade of this branch of industry to the colonies in North America was seriously entertained, and was carried into effect to some slight extent. It was also suggested that the waste lands of England should be planted; and the woods of Ireland being less exhausted than those of England, a considerable quantity of iron was for some time made there.

During the decline in the internal supply of timber, it gradually became an article of extensive demand in other countries. In 1630, according to a statement of Mr. Huskisson, the fir timber used in England for building purposes was nearly all brought from abroad. The proportion of timber of native production used for such objects is not known or even guessed at. The north of Europe, especially the countries on the Baltic, and the colonies in British North America, are the great sources of supply. Teak is brought from the west coast of Africa, mahogany from the Bay of Honduras and other places, and fancy and dye woods from a number of other quarters, but none of these come into competition with the timber of the Baltic or of our North American possessions. The timber of the north of Europe is generally of excellent

quality, and much superior to the colonial timber. Sir Robert Seppings, formerly surveyor of the navy, stated before a parliamentary committee, 'that Canada timber is peculiarly subject to dry-rot; that frigates built of fir, the growth of North America, did not average half the durability of other timber; and that the Royal Navy had suffered so much from the use of Canada or North American timber, that its use was now altogether discontinued, except for deals and masts.' A number of timber-merchants, builders, and carpenters gave evidence before the same committee as to the inferior quality of the colonial timber. One of the witnesses said:—'It is not allowed to be used in government buildings, nor is it ever used in the best buildings in London. It is only speculators who use it, from the price of it being much lower than the Baltic timber.' The inferior colonial timber is forced into use by enormous differential duties, which, before the recent alteration of the tariff, amounted to a bonus of 1000 per cent. in some cases, as the following table shows:—

	Duty on Foreign Timber.			Ditto from Differential British possessions. per cent.		
	£.	s.	d.	£.	s.	d.
Battens, per 120	10	0	0	1	0	0
Deals, ditto	22	0	0	2	0	0
Lath wood, per fathom	4	5	0	0	15	0
Masts, 12 inches and upwards, each	2	15	0	0	10	0
Staves, average duty per 120	3	0	0	0	6	0
Oak planks, per load	4	0	0	0	15	0
Fir timber, ditto	2	15	0	0	10	0
Oak ditto, ditto	2	15	0	0	10	0
Wainscot logs	3	15	0	0	12	0
Unenumerated timber	1	8	0	0	5	0

In 1787 the duty on foreign timber was only 6s. 8d. the load of fifty cubic feet, but it was raised at different times, until, in 1804, it amounted to 25s. In 1810 the duty was raised to 54s. 8d.; and from 1814 to 1820 it was 64s. 11d. and 65s. the load. The trade in colonial timber had scarcely any existence before 1803, although until 1798 it had been admitted free of duty; and the duty imposed in that year was only 3 per cent. *ad valorem*, which was changed in 1803 to a specific duty of 2s. the load. In consequence of the war there was a great rise in the price of European timber, and Memel fir advanced from 78s. to 320s. the load. In order therefore further to encourage the supply from our own colonies, North American timber was again, in 1806, admitted duty free. The stimulus was no doubt justifiable, but it was continued after the temporary causes in which it originated had passed away. The following table shows the effect of the differential duties in substituting colonial timber for that of the north of Europe:—

Average Quantities in periods of Five Years.	Baltic. Lds.	N. A. Colonies. Lds.	Total. Lds.	Per Centage proportion. Baltic Colonial.
1788 to 1792	219,396	2,660	222,057	99 1
1793 1797	161,000	1,225	162,225	99 1
1798 1802	178,019	2,916	180,935	99 1
1803 1807	232,477	16,533	249,070	94 6
1808 1812	73,718	120,537	194,255	38 62
1814 1818	125,855	147,597	273,453	46 54
1819 1823	116,600	335,556	452,156	26 74
1824 1828	191,890	410,903	602,793	32 68
1829 1833	122,783	412,682	535,466	24 76

The return to a sounder principle of taxation has been very slow. In 1821, in consequence of recommendations from both Houses of Parliament, the duty on European timber was reduced from 65s. to 55s. the load, and a duty of 10s. was imposed on colonial timber, leaving a preference duty of 45s. still in operation. In 1831, the government of Earl Grey proposed, by gradual reductions, spread over three years, to lower the duty on European timber 15s., which would still have left it at 40s., or 30s. higher than colonial; but the measure was defeated in the House of Commons by a majority of 236 to 190. A committee of the House of Commons which inquired into the timber duties in 1835, recommended a very inadequate reduction (similar to that proposed by Earl Grey's government), but it was not followed by any result; and in 1841 the government of Lord Melbourne proposed a reduction from 55s. the load to 45s. on foreign timber, and an increase from 10s. the load to 15s. on colonial; but subsequent party changes prevented this alteration being effected. In the tariff of 1842 (5 & 6 Vict., c. 47), the duty on colonial timber has been reduced to a merely nominal sum, namely, 1s. the load, and to 2s. on deals, and 6d. on lath-wood. The reduction on foreign timber is partly prospective. Until the 10th of October, 1843, the duty will be 30s. the load on timber, and after this date 25s.; on foreign P. C., No. 1545.

deals the reduction in the first instance is to 35s., and after October, 1843, it will be 30s., and the duty on lath-wood is at once reduced to 10s. the load. In 1841 the duty on timber produced 1,566,291l., and, without allowing for an increase of consumption in the first year, the loss of revenue is estimated at 601,491l.; and for the year ending October, 1844, when the reduced duties will be fully in operation, the loss to the revenue will be 589,991l. according to the estimate of the minister, who allows for an increase of 12 per cent. on foreign and 20 per cent. on colonial timber, and 20 per cent. on foreign and 24 per cent. on colonial deals. (Speech of Sir R. Peel, 11th March, 1842.) The mode of charging the duty has been improved and rendered less complex under the present arrangement. Planks, deals, and battens were formerly charged by the great hundred (120) in classes, and the duty was disproportionately heavy on the smallest and least valuable kinds. In measuring timber in logs, or unsawn, the cubic contents were, it is alleged, not fairly calculated, but were over-estimated to the extent of from 10 to 20 per cent.; and the sawyers complained that timber partly cut up was charged with a lower proportional duty than in the log, by which their interests were needlessly injured. The public however have still reason to complain that the duties are calculated, as before, to interpose restrictions on the use of superior timber, in order to benefit those who are engaged in supplying the inferior article. The direct loss sustained previous to the recent alteration of duty was estimated at 1,500,000l. annually; and a great sacrifice of revenue has now been made without attaining the benefits which might have attended a return to a better policy, though the disproportion will be only 24s. instead of 45s. the load. Prussia, Norway, Sweden, and other countries are still restricted in the means of exchanging their products for British manufactures; the preference duty on Canadian timber prevents a supply of timber being derived from the forests on the banks of the Danube and on the countries bordering the Black Sea; and the general shipping interests have been sacrificed to the owners of six or seven hundred half worn-out ships. In the colonies the monopoly duty has diverted industry from agriculture. It has been repeatedly shown that neither to any portion of the shipping interest here nor the timber interest of the colonies would a complete equalization of the timber duties be more than temporarily injurious. The fixed capital embarked in saw-mills does not, it is believed, exceed 200,000l., and some descriptions of Canadian timber would command the English market under any circumstances, while there is a growing demand for all kinds in the Northern states of the American union. The floating capital now engaged in the trade of 'lumbering' could of course be transferred with little difficulty to the cultivation of the soil, and the export of flour, tobacco, hemp, flax, and ashes, would fill up the vacuum occasioned by the diminished export of timber, and would require the shipping which had not found full employment in the new channels to which the timber-trade would be directed.

The consumption of timber in the United Kingdom in 1841 was as follows:—

	Great Hands.	Gross Revenue.
Battens and Batten Ends	18,969	£156,120
Deals and Deal Ends from British America	44,148	90,113
Deals and Deal Ends from other parts	24,242	491,960
Staves	89,699	40,777
Timber 8 in. sq. and upwards from British America	613,679	337,795
— from other parts.	131,479	370,302

Other sorts are technically called 'woods,' meaning fancy woods for furniture, &c., and dye-woods. Of mahogany the consumption was 18,170 tons in 1841, having been 20,451 tons in 1840. (*Report of Committee on Timber Duties, 1835; British and Foreign Review, No. 4; Porter's Progress of the Nation, vol. ii.*)

TIMBER AND TIMBER-TREES.—Timber-trees are those the wood of which is used for building or repairing houses. Oak, ash, and elm, of the age of twenty years and upwards, are the trees most generally included under that denomination; but there are many other kinds of trees, such as beech, cherry, aspen, willow, thorn, holly, horsechestnut, lime, yew, walnut, &c., which are, by the

custom of certain parts of England, considered as timber-trees, as being those used in building. (Cruise, *Dig.*, t. 3, c. 2, ss. 6, 7.) Most of the cases upon the question as to what trees are to be considered timber, have arisen in reference to the stat. 46 Edw. III., c. 3, whereby it was enacted that great or grosse wood of the age of twenty, thirty, or forty years, or upwards, should not be titheable, but that *sylvæ cædua*, or underwood, should be titheable. Lord Coke says that two doubts arose on the construction of this statute: first, what should be considered as high or great wood; and secondly, of what age those grosse or timber trees should be. As to the first, the answer was, that in this act the word *grosse* signified such wood as had been or was, either by common law or the custom of the country, timber; for the act did not extend to other woods that had not been or would not serve for timber, though they were of the bigness or greatness of timber. As to the second question, of what age those grosse or timber trees should be, the statute resolved this doubt in these words: 'Great wood of the age of twenty years or upwards;' which words were considered as declaratory of the common law on the subject. (2 *Inst.*, 642, 643; 3 *Rep.*, 12.) It appears now to be settled, though there have been contradictory decisions on the point, that trees of the growth of twenty years and upwards, sprung from old stools or roots, are within the exemption of this statute, and are consequently to be considered as timber. (4 *M. & C.*, c. 600.)

The timber-trees growing upon land belong to the owner of the inheritance. A tenant for life has only a qualified interest in them, in so far as they afford him shade and shelter, and a right to take the mast and fruit. If the tenant for life fells timber-trees on the land to any amount greater than he is entitled to as estovers, that is to say, the allowance of wood necessary for the reparation of houses and fences, he becomes liable to an action of waste [WASTE]; and the trees, which by these or any other means, accidental or otherwise, have become severed from the land, may be seized by the owner of the inheritance, or an action may be brought by him for them. (3 *P. W.* 267.) If, however, the estate of the tenant for life be without impeachment of waste, he has the full right to fell timber, and also the property in all timber-trees felled and blown down during his life.

The Court of Chancery has sometimes directed the timber growing on an estate, whereof a person was tenant for life, to be cut down, for the purpose of paying debts and legacies charged upon the inheritance. (2 *Vern.*, 152.) The Court of Chancery has also directed timber in a state of decay to be cut down for the benefit of the person entitled to the inheritance, provided no damage were done to the tenant for life. (2 *Vern.*, 218.) The practice in these cases is to order the money arising from the sale of the timber to be invested, and the interest of it paid to the tenant for life.

In leases for lives, when timber is included, if the lessor fells the trees, the lessee may maintain an action of trespass against him, because the lessee, though he may not cut down the trees without being subject to an action of waste, has an interest in them for shade and shelter, and a right to take the mast and fruit, and may also lop them if they be not thereby injured. But where the trees are excepted in a lease, which is usually done, the lessee has no interest whatever in them, and the lessor may bring an action of trespass against him if he fells or damages them. The lessor has also a power, incident to the exception, of entering on the land in order to fell and take away the trees; though this power, for the sake of avoiding questions, is often expressly reserved.

The timber growing on copyhold estates is, by the general custom of most manors, the property of the lord, who may cut it down, provided he leaves a sufficient quantity for the repairs of the copyhold, which the copyholder is entitled to of common right. But the general right of the copyholder to have timber for the reparation of houses and for ploughbote and hedgebote may be restrained by custom, namely, that he shall not take it without assignment from the lord or his bailiff. (13 *Rep.*, 68.) Where the custom of the manor is that the copyholder shall employ the timber cut down in the reparation of his tenements, he may sell the tops and bark towards defraying the expenses of the repairs. (3 *Buls.*, 282.) A copyholder in fee may, by the particular custom of the manor, have a

right to cut timber-trees growing on his copyhold and sell them at his pleasure; and the same right may be by custom to a copyholder for life, who is entitled to terminate his successor, as being a *quasi* copyholder in fee; but a custom that a copyholder for life may cut down timber is unreasonable and void, as being a destruction of the inheritance, and contrary to the nature of a life estate.

Ecclesiastical persons being considered in most respects as tenants for life of the lands held by them *jure ecclesie*, are not permitted to cut down timber except for repairs; but by the 56 Geo. III., c. 52, the incumbent of any benefice, with the consent of the patron and bishop, is enabled to pay the moneys to arise by sale of any timber cut from the glebe-lands of such benefice, either for equality of exchange, or for the price of houses or lands purchased by him under the statutory powers vested in him for such purposes.

Trustees to preserve contingent remainders are bound to preserve not only the limitations of the settlement under which they are trustees, but also the inheritance of which the timber is part; and the Court of Chancery will interfere at their suit to prevent the owner of the particular estate joining with the person entitled to the inheritance for the time being to cut down the timber on the estate. (2 *Swan.*, 144.)

TIMBREL, a musical instrument of the highest antiquity; the *tympantum læve* of the Roman poets, and in the opinion of all writers of any authority, the same in an almost unaltered state, as that now known in every part of Europe under the names of tabor, tambourine, *tambour de Basque*, &c.

TIMBUCTU' (TEMBOCTU, TOMBOOKTOO, &c. a place by Mr. Arrowsmith, after careful criticism and calculation of a number of routes, in 17° 8' N. lat. and 2° 56' W. long. Mr. McQueen, to whom we are so much indebted for the extension and correction of our geographical knowledge of Africa, had placed it in 17° 40' N. lat. and 2° 30' W. long.; but readily yields the palm of accuracy to his (Mr. Arrowsmith's) researches in preference to my own. The position assigned by Mr. Arrowsmith may be assumed to be as exact as can be obtained until the point is fixed by astronomical observations on the spot; or even then, unless they may be made by more competent observers than the discrepancies among the statements of those who have attempted to ascertain the positions of places on the Lower Niger show some or all of these gentlemen to have been.

The position of Timbuctú is one which is most important to have ascertained, not merely on account of its being the centre of so many routes, and therefore a useful starting-point whence to calculate the horizontal bearings and distances of many places; but also as being what the circumstance of so many routes meeting there might well have shown, the index of the comparative elevations, slopes, and depressions of the interior of Western Africa. It is for the same reason an important position relative to the history of the migrations of African tribes, of the development of the trade of Africa, and of its progress in general civilization.

The rude map of the northern curve of the Kowm by the schoolmaster of Sultan Bello, the sketch of the position of Timbuctú given to Mr. Park by an old Senegambian Moor, and the delineation of central Libya according to Ptolemy all concur in representing the Niger at the most northern point of its course as forming a great curve—flowing first to the north, then to the east, and ultimately to the south. The discoveries of modern English travellers on the Upper and Lower Niger place it beyond a doubt that these representations must be in the main accurate; and the routes between a great number of different places obtained from Arab travellers from the coast-towns of Morocco, Algiers, Tunis, and Tripoli, to the interior, as well as from the natives of the interior themselves, all harmonize with and corroborate these conclusions. It is because the statements of M. Caillié agree with this view that we feel assured he has not intentionally deviated from veracity, and because we place a reliance on his account of the appearance and condition of individual places and persons which we can by no means accord to his bearings and distances.

Timbuctú appears to stand on the declivity of an inconspicuous eminence about eight miles north of the Niger. 'Nothing,' says Caillié, 'is to be seen in all directions

but immense plains of loose shifting sands of a yellowish-white colour.' From the point where Caillié quitted the Niger, to Cabra, the port of Timbuctú, a distance of three miles, he passed along a narrow canal, and as he remarks that 'the negro slaves hauled the canoe along by a rope, as the pole would not have been sufficient to move it,' the natural inference is that he was proceeding up the stream. Between Cabra and Timbuctú he passed two lakes. These appearances coincide with the statements of Arabian geographers that a wady, filled during the rainy season with a stream of water, extends from north-east of Timbuctú, and, passing to the south of that town, disembogues into the Niger to the south-west of it. The same authorities mention a number of similar wadys at a distance of eight or ten days' journey to the north-east of Timbuctú, extending over a tract of country nearly 60 miles in breadth, and all apparently converging as they descend towards it as to a central point. The Gozen Zair, which falls into the Niger a short way to the south-east of Kabra, flows from the west. All these circumstances concur to indicate a strong analogy between the great northern curve of the Niger south of Timbuctú and the great northern bend of the Hoanghó. Both rivers, descending from elevated mountain ridges in a general northerly direction, are encountered by the slope of an extensive elevated plain, run some time in a direction from west to east at its side, and then turning to the south flow off through mountain defiles. It is this peculiarity in the structure of the plain on which Timbuctú is situated that has rendered that site from a remote antiquity the meeting-place of so many converging lines of traffic. It is the nearest point at which the traders from the commercial districts that skirt the coasts of the Mediterranean west of Barca, and of the Atlantic north of Cape Nun, can strike, after crossing the great desert, the fertile lands extending to the south-east and south-west along the Upper and Lower Niger.

Leo Africanus states that Timbuctú was built by Mansa Suleiman, about the year 610 of the Hejira (A. D. 1214), and that it soon became the capital of a powerful state. Seeing however that Ptolemy places towns of the name of Kúpha (Καφη) and Nigeira Metropolis (Νιγεϊρα Μητρόπολις), the former nearly in the probable meridian of Timbuctú, and the latter somewhat to the east, at the confluence of a tributary with the Niger, there can be little doubt that the town built by Mansa Suleiman was not the first important commercial station in those regions. Indeed an author quoted by Cooley (*Negroland of the Arabs*, p. 68) would lead us to believe that a town bearing the name Tombuti existed in those regions as early as the year 297 of the Hejira. Rulers with the title Mansa continued to govern Timbuctú from 610 to 792 of the Hejira.

The chiefs of Morocco and Fez rendered Timbuctú tributary, and from that time the communications of the Arabs with that country became more frequent and regular. Leo Africanus mentions that the grand mosque of the town and the palace of the king were built by an architect from Granada. The Arab conquerors allowed however the native dynasty to remain on the throne. The expulsion of the Arabs from Spain, and the weakening of the Arab power in North Africa by the Turkish conquests in Tunis, Tripoli, and Algiers, in the course of the fifteenth century, increased the impunity of the predatory nomade hordes; and about the same time, or a little later, the formation of settlements on the west coast of Africa, first by the Portuguese and afterwards by the English and French, by creating a new line of traffic with the interior, diminished the importance of Timbuctú as a commercial entrepôt. About the year 1500 a negro general of Soniheli, king of Timbuctú, raised the standard of revolt on the death of his master, overturned the Moorish supremacy, conquered a number of the neighbouring provinces, and recalled to Timbuctú a part of the trade which had left it for Jenné on the Niger. When Leo Africanus visited this part of Africa, the territories of Abu-Bekr-Ishieh, the negro conqueror, extended from Agadez on the north to Kashnah on the south. Marmol (1573) describes the commerce of Timbuctú as in a flourishing condition in his day. According to the information collected by Mr. Jackson, Timbuctú would appear, about 1668 or 1670, to have fallen under the dominion of the king of Bambarra; for Mullah Arshid, of Taflet, having driven Sidi Ali of Suz from his territories, the fugitive was protected by the king of Bambarra, and created

by him commandant of Timbuctú. Sidi Ali made his peace with Mullah Ismael, successor of Mullah Arshid, and the consequence was that Timbuctú became tributary to the prince of Taflet. This connection terminated with the death of Mullah Ismael (1727), and since that time Timbuctú appears to have been governed by a negro ruler, that is, by one who is neither an Arab, nor a Tuarik, nor a Fellatah. The security of person and property, and the commerce of Timbuctú, appear to have fallen off since the accession of the negro dynasty.

Caillié estimates the permanent inhabitants of Timbuctú at from 10,000 to 12,000. After the arrival of the caravans the town assumes for a portion of the year a much more populous and probably a much more bustling appearance. During his stay it was dull and listless. The streets are clean, and wide enough to allow three horsemen to pass abreast. The houses are of sun-dried bricks, and consist entirely of a ground-floor; in some a sort of closet is constructed over the entrance; the apartments are built on the four sides of an open court in the centre. Both within the town and round about it there are numerous straw huts of a conical form. The town is not walled. In the centre of the town is a square surrounded by circular huts, and planted with a few trees: in the middle of it a large hole is dug as a receptacle for filth. Two enormous heaps outside of the town appeared to be accumulations of rubbish. Some buildings on the east side of the town are overwhelmed with sand. There are seven mosques; two of them large, and part of the largest apparently of considerable antiquity; each is surmounted by a brick tower. To the west-south-west of the town are large excavations from 35 to 40 feet deep, which collect in the rainy season the supplies of water which serve the inhabitants for drinking and culinary purposes throughout the year. There is no spontaneous vegetation near the town except some stunted mimosa-trees. Near the reservoirs are some small plantations of bad tobacco. The inhabitants of Timbuctú draw from Jenné their supplies of millet, rice, vegetable butter, honey, cotton, Soudan cloth, pepper, onions, dried fish, pistachias, &c. Fire-wood and timber for building, and provender for cattle, are brought from Cabra. They purchase cattle from the nomades of the tribe of Zawaf, who possess the country two days' journey distant from Timbuctú to the north-east; from the people of Sala, ten days' journey to the east; and from the Tuariks, who are the most powerful race, on all sides. They procure salt for their own consumption and for the trade with Soudan from Tádéini, which lies twenty days' journey north-west of the town.

The negro and Arab inhabitants of Timbuctú are exclusively engaged in trade. Great part of the Moors are from the sea-coast; they start with an adventure to Timbuctú, reside for some years there, and when they have acquired enough, return to their native country. The negro inhabitants dress like the Moors, and are zealous Mohammedans. They have several wives, whom, as well as their slaves, they employ in menial affairs. The Moors, who are only temporary residents, cohabit with their slaves. Caillié represents all classes of the inhabitants as cleanly both in their persons and houses. Several villages on the Niger are subject to Timbuctú. Cabra, the port of Timbuctú, is secured against the inundations by being slightly elevated above the marshes; the sandy desert commences immediately to the north of it. This place appeared to Caillié to contain about 1000 or 1200 inhabitants, all of the poorer class, engaged in the service of the merchants of Timbuctú. The dwellings are either mean houses or small huts; the street is neat, but the landing-place is dirty. The merchandize is conveyed between the port and Timbuctú on asses and camels: these belong in general to the inhabitants of Cabra; but sometimes the poorer Tuariks hire their camels for the purpose. The Tuariks are the terror of the surrounding country: they exact tribute from the inhabitants of Timbuctú, and tolls from all merchants who pass to the town overland or by the Niger. The nomade Arab tribes appear to stand in awe of them: the Fellatah to the south keep their ground against them; but as they surround Timbuctú for some distance on all sides, they hold the entire trade of these regions at their mercy.

(C. Ptolemaei *Geographia*, lib. viii.; James M'Queen, *A Geographical Survey of Africa*; C. A. Walckenaer, *Recherches Géographiques sur l'Intérieur de l'Afrique*;

Cooley, *Negroland of the Arabs; Travels of Park, Lyon, Denham, Clapperton, Caillié, &c. &c.*)

TIME. This word may be considered either with reference to our abstract idea of the thing signified by it, or to the measures of it which have been contrived for use in the business of life. Something on the first point of view will be found in the article SPACE AND TIME, to which the following may be added.

When we think of time in the usual manner, it is of a real thing external to ourselves, which we cannot help imagining to have an existence and a measure, both of which would remain though those who now speculate upon the conception were annihilated. A little more consideration shows that we are indebted for the idea to successions of observed events, or at least for the power of applying the idea to external objects. No description can be adequate; if we say that *change* necessarily implies *time*, and that the perception of that which *is* being different from that which *was*, suggests the notion of an interval, we see that we have already fully assumed the idea of time in the words *is* and *was*. But we may say that space and the objects which fill it exist independently of ourselves, and would undergo changes though we were not in existence to perceive them, and that therefore the times which those changes require would also exist; this involves the whole of the most abstruse part of metaphysics, and is much beyond the scope of our article. We shall therefore turn to the mode of measuring time; we have a thorough conviction that time is a magnitude, that is, has its *more* and *less*. We must ask ourselves in the first instance what we mean by a greater or a smaller time.

In the perception of time as a magnitude, that is, of intervals of time as containing more or less of duration, we refer in the first instance to a habit derived from continual acquaintance with those great natural successions on which the usual actions of our lives depend, with which we can constantly, though unconsciously, compare the duration of our thoughts and actions. There is no more an absolutely long or short time than there is an absolutely great or little space; these words are only comparative. If, for example, any one were to affirm that the universe was continually growing less and less, all its parts altering in the same proportion, and the dimensions of the human race with the rest, in such manner that the whole solar system would now go into a nut-shell, such as nut-shells were a thousand years ago, it would be impossible either for him to prove it, if true, or for any one else to prove the contradiction, if false. In like manner if any one were to say that the revolutions of all the heavenly bodies were continually accelerating, and that the properties of matter were also continually altering, and the speed with which ideas are formed and communicated, and muscular efforts made, continually increasing: it would be impossible to prove a contradiction. The oriental story is the best illustration of this:—A prince was ridiculing the legend of Mohammed being taken up by an angel, and holding many long conferences with his Creator, and having many views of heaven and hell to the smallest details, in so short a time, speaking with reference to things upon earth, that on his being brought back, the water had not quite flowed out of a jug which he had dropped from his hand when the angel caught him. A magician at the court of this prince checked his laughter by offering to prove the possibility of the story, if his highness would only dip his head into a basin of water. The prince consented, and the instant his head was immersed, found himself lying by the sea-shore in a strange country. After a reasonable quantity of malediction upon the magician, he found himself obliged by hunger to go to a neighbouring town, and seek the means of support. In time he became independent, married, and brought up a family, but was gradually stripped of all his substance by losses, and buried his wife and children. One day he threw himself into the sea to bathe, and on lifting his head out of the water, found that he had only lifted it out of the basin, the magician and the other courtiers standing round. On his bitterly reproaching the magician, the latter assured him, and was confirmed by all the bystanders, that he had done nothing but just dip his head into the basin, and lit it out again. Of course the prince expressed no more doubts about the story of Mohammed, and however much any reader of the two tales

may think that neither is true, a little reflection will show that either *might* be so. Perhaps the allegory may have been suggested by what is known to take place in dreams; there is evidence enough that many of the images of these illusions really occupy no more than, if seen from a second or two by the pendulum. [DREAM, p. 143.]

In the laws of motion it seems as if, so to speak, matter took cognizance of time; a particle of matter would continue to describe equal spaces in *equal times*, not acted on by force from without. Yet it would be possible to state this law as follows, in such a manner as to avoid the comparison of quantities of duration. If two particles acted on by no external forces, are at A and *a* at the same epoch of duration, and at B and *b* at the same subsequent epoch, then if A C be *m* times A B, and if *a c* be *n* times *a b*, the law of motion is that C and *c* will be respectively attained at the same instant. The mathematician will readily see that the equations of motion do not depend upon the absolute recognition of time as a measurable quantity, but that any moving particle, as A, being acted on by no force, the distance A C, described in the time *t*, might be introduced into all formulae instead of the time, without any question as to whether time being physically considered, the space A C varies as the time. It is enough that the uninfluenced motion of any other particle should be connected with that of the standard particle by the law above described. But though we can thus avoid the idea of measurement of time, we cannot get rid of its existence or of the notion of succession of events, and that we can reduce dynamics to a *theory of simultaneous positions* of particles of matter, without reference to the absolute length of time employed in passing from one position to another, there is still the notion of time in the notion of simultaneous. But, nevertheless, the idea of succession thus introduced is hardly, if at all, more physical than that which comes into most of the branches of pure mathematics, a point on which it will be worth while to dwell for a moment.

When Newton, in his doctrine of fluxions or flowing quantities, imagined length, space, solidity, and even number, to be generated by a continual and gradual flow, as a line by the motion of a point, a surface by that of a line, and so on, it was objected that he introduced the ideas of time and motion, both of which were foreign to pure mathematics, and properly belonged to mechanics. To get rid of these intruders, the theory of limits, which the notion of fluxions immediately requires, was attached to flowing quantities, but to variable quantities. Let *x* be a variable quantity, is one of the most common phrases of the systems which have superseded that of Newton. Now variation means change; it is never pretended that a variable has two values at once. All the difference is that by Newton the object of consideration is supposed to grow larger or smaller, while the moderns pass in thought from a larger quantity to a smaller, or *vice versa*, taking the first and the other afterwards. If so slight a difference be worth a contest, the distinction of pure and mixed science must be trivial enough: the fact is, that both systems consider successive values, and *succession* is time. If two computers were to quarrel which was the purer arithmetician, the one who stood still and counted the carriages as they passed by him, or the other who walked from one to another and counted them as they stood still, they would, to us, much resemble some of the disputants for and against the principle of fluxions.

The actual measure of time depends upon our being able to secure successions of similar events which shall form epochs separated by equal intervals of time. We cannot do this by our thoughts, except approximately, and for short periods. The memory of a musician, aided by the sentiment or feeling of time which is part of a good ear for music, will do remarkably well for a short period: a person who could not well preserve the division of a sonata into eight parts at least would make a poor figure in an orchestra. As to the judgment of considerable periods of time, it is materially influenced by the manner in which it has been spent: a time which *seems* to have been acted through weariness *has* been long, and the contrary grounds already alluded to. Thus a year of mature age is really, to the thoughts, of a different length from one of childhood. Again, when we talk of a long period of time having passed quickly or slowly, we speak not of the time, but of our mode of remembering it. A person of apt

recapitulation always says that time has passed quickly, another of a contrary habit the contrary; and this whether the rapidity is a consequence of quickness of ideas, or of having little to recall.

In all the more correct machines which have been invented to measure time, there is but one principle: a vibration is kept up by the constant application of forces only just sufficient to counteract friction and other resistances, and machinery is applied to register the number of vibrations. The remarkable law noted under **ISOCRONISM** and **VIBRATION** makes it comparatively immaterial whether the vibrations are of precisely the same extent. But the imperfections of such instruments, or rather, our ignorance of the precise action of disturbing causes, and particularly of changes of temperature, renders them comparatively useless for measuring long periods, so that if we could not have recourse to the motion of the heavenly bodies, there would be no permanent measure of time. And even in astronomical phenomena there is no absolute recurrence at equal intervals, though nearly enough for common purposes. The value of such phenomena for the most accurate measures consists in most of their irregularities being truly distributed about a uniform mean, so that the excesses of some periods are compensated by the defects of others, giving, in the long run, power of determining that mean with as much accuracy as our modes of measurement can appreciate. The determination of time for civil reckoning may be divided into two parts: first, the mode of making the different periods derived from the sun and moon agree with each other so as to afford an easy method of reckoning co-ordinately by both [**PERIODS OF REVOLUTION**]; secondly, the mode of procuring true and convenient subdivisions of the natural unit consisting of a day and night. To the second of these we now turn our attention.

The actual revolution of the earth, as measured by the time elapsed between two transits of the same star over the meridian, is called a *sidereal* day. It is divided, as are all other days, into twenty-four hours of sixty minutes each, &c. The time so given is called sidereal time. If the sun were a fixed star, this sidereal time would be the common mode of reckoning. But the sun having its own slow motion in the ecliptic, in the same direction as the revolution of the earth, the interval between one meridian transit of that body and the next is [**SYNODIC**] longer than the simple revolution of the earth, for just the same reason that the time which the minute-hand of a watch moves from coincidence with the hour-hand to coincidence again is longer than the hour, or simple revolution of the minute-hand. If the sun moved uniformly, and in the equator, the real solar day, which means the interval between two meridian transits of the sun, would always be of the same length, and a little longer than the sidereal day. But the sun neither does move uniformly, nor in the equator; and each of these circumstances causes a slight irregularity in the absolute length of the solar day, or, as it is called, the *real* solar day. This is the reason why the time shown by a sundial does not agree with the watch. To remedy this inconvenience, a fictitious sun is supposed to move in the ecliptic, and uniformly, while another fictitious sun moves in the equator, also uniformly. Both the fictitious bodies have the average motion of the real sun, so that the years of the three are the same; and the fictitious sun of the ecliptic is made to coincide with the real sun at the perigee and apogee, or nearest and farthest points from the earth; while the fictitious body in the equator is made to coincide with the fictitious body of the ecliptic at the equinoxes from which it arises that there is also a coincidence at the solstices. This fictitious sun of the equator is that to which clocks are adjusted; the interval between two of its transits, which is always of the same length, is called a *mean solar day*, which is divided into twenty-four mean solar hours, &c. The difference between time as shown by the real sun and the fictitious sun in the equator, is called the equation of time.

The determination of the equation of time is a mathematical problem of some complexity: what we have here to notice is, that owing to the joint action of the two sources of difference, it presents a very irregular series of phenomena in the course of the year. If the sun moved regularly, but in the ecliptic, there would be no equation of time at the equinoxes and solstices: if the sun moved with its elliptic irregularity, but in the equator instead of

the ecliptic, there would be no equation of time at the apogee and perigee. Between the two the equation of time vanishes only when the effect of one cause of irregularity is equal and opposite to that of the other; and this takes place four times a year. In this present year (1842) the state of the equation of time is as follows:—January 1, the clock is before the sundial 3^m 51^s, and continues to gain upon the dial until February 11, when there is 14^m 35^s of difference. This then begins to diminish, and continues diminishing until April 15, when the two agree, and there is no equation. The dial then is before the clock until May 14, when the equation is 3^m 55^s, which diminishes until June 15, when there is again no equation. The clock is now before the dial, and the equation increases till July 26, when the equation is 6^m 10^s, which diminishes until the 1st of September, when there is no equation, for the third time. The dial is now again before the clock; and by November 2 the equation has become 16^m 18^s, from which time it falls off until December 24, when it is nothing for the fourth and last time. The clock then gets gradually before the dial till the end of the year. The phenomena of the next year present a repetition of the same circumstances, with some trivial variations of magnitude. There are several slight disturbing causes to which we have not thought it worth while to advert in a popular explanation: in particular, the slow motion of the solar perigee [**YEAR; SUN**], which will in time wholly alter the phenomena. For instance, when the perigee comes to coincide with the equinox, there will be only two periods at which the equation of time vanishes, namely, when the sun is at either equinox.

The sidereal day is 23^h 56^m 4^s.09 of a mean solar day, and the mean solar day is 24^h 3^m 56^s.55 of a sidereal day. We have in this article only to do with the mode of obtaining a uniform measure of time, or of intervals of time; this being premised, the subject will be taken up again in the article **YEAR**.

TIME BARGAIN. [**STOCKS.**]

TIME OF DESCENT, the technical term for the time employed by a material particle in falling down an arc of a curve under the action of gravity, the mode of obtaining which is explained in **VELOCITY**. When any number of curves are drawn from a given point, and another curve is so drawn as to cut off from every one of them an arc which is described by a falling particle in one given time, that curve is called *tautochronous*, or a *tautochron*. But when a curve is such as the cycloid, namely, that a particle, wherever placed, will fall to the lowest point in the same time, such a curve is also called *tautochronous* by various writers, and *isochronous* by others. Our only object in inserting this article has been to note this confusion of language.

TIME (in Music) is:—

- I. The measure of the duration of sound.
- II. That which divides a bar into two or three equal parts, and subdivides these.
- III. The movement—*i.e.* the quickness or slowness—of a composition.

1. The degree of sound, or pitch, is shown by the place on the staff of any one of the characters called notes; but its duration is known by the particular note; that is, as minim, or crotchet, &c. The longest note, in relation to time, used in modern music, is the semibreve, which is considered the measure-note, and its average length is about four beats of a healthy man's pulse. The five other notes are proportionate parts of this. Thus the minim is in duration $\frac{1}{2}$ of a semibreve; the crotchet is $\frac{1}{4}$, &c.: consequently two minims, or four crotchets, &c., are equal to one semibreve, as exhibited in the annexed table:—

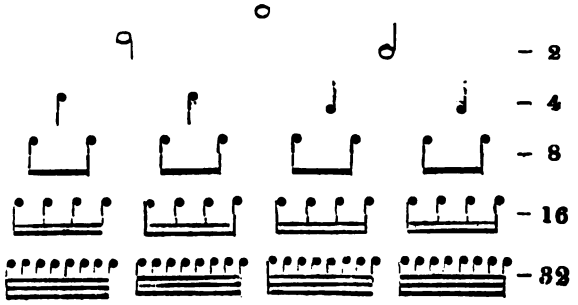

2. Time is either duple or triple. The former divides every bar, or measure, into 2, or 4, &c. equal parts; the latter into 3, or 6, &c. Times are marked by the letter C,—also by this letter barred (\bar{C}), and by figures. The C, whether barred or not, indicates *Common Time*; that is, duple time, having one semibreve, or its equivalent in notes, in each bar. Figures represent the fractions of a semibreve, the upper figure the numerator, the lower the denominator. When the numerator is 2 or 4, the time is duple; when 3, it is triple; when 6 or 12, it is compound-common; and when 9, it is compound-triple. But in reality, there are only two times,—binary and ternary; or, duple and triple; a fact which would long ago have been recognised and acted on, had music, as a system, made those advances which have long been witnessed in the other arts and sciences.

3. The term *Time* has hitherto had a third meaning annexed to it in musical language, by its employment in the sense of movement, a practice which has produced some confusion. The Italian word *Tempo*, signifying the same, is now growing into use—a manifest improvement, which, it is to be hoped, will not have to encounter those professional prejudices under which music has so long laboured. [METRONOMIK.]

On the subject of Time (*Temps*) Rousseau has well remarked, that a succession of sounds, however skilfully arranged as to high and low, produces only vague effects. It is measure, the duration, relative and proportional, of sounds, which fixes the true character of the music, and endows it with all its energy. Time (under which term he, of course, includes rhythm) is the soul of song. Airs whose movement is slow make us pensive; but a gay, spirited, and well cadenced air inspires us with joy, and our feet can hardly be restrained from dancing. Break the measure, confound the relative times of the sounds, and the very same airs which proportion had rendered so agreeable, at once lose all their character, all their charms, and are incapable of exciting the slightest degree of pleasure. Time, on the contrary, possesses a force, a power, in itself, and acts independently of a diversity of sounds. The drum furnishes a proof of this, rough and imperfect as the instrument is, because (the author ought to have said) its beats are in rhythm, though the sound is unvaried.

TIMOLEON (Τιμόλειον), a Greek general and statesman. He was a native of Corinth, and the son of Timodemus and Timariste. Respecting his youth we know nothing, except that he was no less distinguished by his noble character and his love of freedom than by his illustrious descent. When he had grown up to manhood, his elder brother Timophanes, who had been elected general by the Corinthians, assumed the tyrannis in his native city by the help of his friends and his mercenaries. Timoleon at first only remonstrated with his brother, but when this was useless, he formed a plot against him, and Timophanes was killed. Soon after this event, which threw all Corinth into a state of violent agitation, some extolling the conduct of Timoleon as magnanimous and worthy of a real patriot, others cursing and condemning him as a fratricide, there arrived at Corinth ambassadors from Syracuse soliciting the aid of the Corinthians against its oppressors. This was a favourable opportunity for the party hostile to Timoleon to get rid of his followers, while at the same time it opened to Timoleon a field of action in Sicily, where he might act according to his principles and deliver the island from its oppressors. Timoleon was accordingly sent to Syracuse with a small band of mercenaries, which he himself had raised, 344 B.C. Syracuse was then divided into three parties: the popular party, which had engaged the service of Timoleon; a Carthaginian party; and the party of Dionysius, the tyrant, who had returned from Italy in B.C. 346. Dionysius had already been driven out of a part of the city by Hicetas, the tyrant of Leontini, who supported the Carthaginian party. On the arrival of Timoleon, Hicetas was compelled to withdraw to Leontini, and Dionysius, who was reduced to surrender himself and the citadel to Timoleon, was allowed to quit the island in safety, and he withdrew to Corinth, in B.C. 343. [DIONYSIUS.] Syracuse had almost become desolate by the successive revolutions and party warfare. During the winter and the spring following his victory over Dionysius, Timoleon endeavoured as much as was in his power to restore the prosperity of the city by recalling those who had been exiled, and by vitiating colonists

from other parts of Sicily and assigning lands to them. After this he continued to carry on petty warfare partly against the Carthaginians and partly against Hicetas. The Carthaginians in the meantime collected a new army, which is said to have consisted of 70,000 foot and 10,000 horse, and which was conveyed to Sicily by a large fleet. Timoleon could muster no more than 3000 Syracusans and 9000 mercenaries, but in order to strengthen himself he concluded a peace with Hicetas, some of whose troops now joined his army. He marched out against the enemy, and by his superior generalship he succeeded in gaining a brilliant victory over the Carthaginians on the banks of the river Crimessus, and confined them to the part of Sicily between the river Halycus and the western coast, B.C. 339. After this victory and the conclusion of a peace with Carthage he directed his arms against the tyrants in other towns of Sicily, whom he compelled to surrender or withdraw, partly by the terror of his name and partly by force of arms. Hicetas was made prisoner, and condemned to death by the Syracusans, with his wife and family.

After freedom and the ascendancy of Syracuse were thus restored in the greater part of Sicily, Timoleon directed his attention to the restoration of the prosperity of the towns and the country. The former, especially Syracuse, were still thinly peopled, and he invited colonists from Corinth and other parts to settle there, and distributed lands among them. He himself, with the consent of the Syracusans, undertook to revise and amend their constitution and laws, and to adapt them to the altered wants and circumstances of the state. Although it would have been easy for him to establish himself as tyrant and to secure to his descendants the kingly power at Syracuse, he fulfilled the duties of the office entrusted to him with a fidelity which has rarely been equalled. He had no other end in view but the establishment of popular liberty, for which he prepared and trained the people. Some acts of cruelty and apparent injustice with which he is charged, find their excuse in the character of those whom he had to deal with, for the Syracusans at that time were a motley and demoralized people, who could not be managed without Timoleon's assuming at times the very power which it was his wish to destroy. But Syracuse and Sicily felt the benefits of his institutions for many years after his death, and continued to enjoy increasing prosperity.

During the latter part of his life Timoleon was blind and lived in retirement, respected and beloved by the Sicilians as their liberator and benefactor. He died in the year B.C. 337, and was buried in the Agora of Syracuse, where subsequently his grave was surrounded by portico and adorned with a gymnasium called the *Timoleion*. (Plutarch, and C. Nepos, *Life of Timoleon*; and Diodorus Siculus, lib. xvi.)



Decadrachm of Syracuse, inserted as a sample of the Coins of Syracuse. British Museum. Actual size. Silver. Weight, 625 grains.

TIMOMACHUS, a celebrated ancient painter, a native of Byzantium, and said to have been the contemporary of Julius Cæsar. Pliny (*Nat. Hist.*, xxxv. 40) informs us that Cæsar purchased two pictures in encaustic by Timomachus, for 80 Attic talents, about 17,280*l.*; one representing Ajax the son of Telamon brooding over his misfortunes; the other, Medea about to destroy her children: He dedicated them in the temple of Venus Genetrix. These pictures have been much celebrated by the poets; there are several epigrams upon them in the Greek anthology, and they are alluded to by Ovid in the two following lines:—

'U'que sedet vultu fœvus Telamonius imas,
Inque oculis facinus barbarum matris habet.' (Ovid, *l. 88*.)

(Ajax the son of Telamon is seated, showing his anger by his countenance and the barbarous mother betrays by her eyes her intended crime.)

We learn from Pliny also that the picture of Medea was not finished; its completion was interrupted apparently by the death of the painter, yet it was admired, he says, more than any of the finished works of Timomachus, as was the case likewise with the Iris of Aristides, the Tynlaridæ of Nicomachus, and a Venus by Apelles, which were more admired than any of the finished works of their respective masters. This picture is noticed also by Plutarch (*De Aud. Poet.*, 3) in a passage where he speaks of the representation of improper subjects, but which we adhere on account of the excellence of the execution.

In the common text of Pliny, Timomachus is said to be the contemporary of Cæsar ('Julii Cæsaris ætate'), but Durand, in his 'Histoire de la Peinture Ancienne,' &c., expresses an opinion that the word *ætate* is an addition of the copyist, for which he assigns several reasons. The conjecture has much in its favour; the price of these pictures (17,280*l.*) is enormous, if we suppose it to have been paid to a living painter; but on the contrary it is a case with no parallels if we suppose the money to have been paid for two of the reputed masterpieces of ancient painting. The fact of the Medea being unfinished puts it beyond a doubt that the picture was not purchased of the painter himself; and from a passage in Cicero (*In Verr.*, l. i., c. 60) it seems equally clear that both pictures were purchased of the city of Cyzicus; and from the manner in which they are mentioned with many of the most celebrated productions of the ancient Greek artists, it would appear that they were works of similar renown, and were likewise productions of an artist long since deceased. Timomachus was therefore most probably a contemporary of Apollonius, Nicias, and other encaustic painters, about 300 B.C. Pliny himself, elsewhere speaking of Timomachus, mentions him together with the more ancient and most celebrated painters of Greece, with Nicomachus, Apelles, and Aristides, as in the passage above quoted.

Pliny mentions also the following works of Timomachus: an Orestes; an Iphigenia in Tauris; Lecythion, a gymnasiast; a 'cognatio nobilium,' two philosophers or others, with the pallium, about to speak, one standing, the other sitting; and a very celebrated picture of a Gorgon.

TIMON (*Τίμων*), a Greek poet and philosopher who lived in the reign of Ptolemaeus Philadelphus, about 270 B.C. He was the son of Timarchus, and a native of Phlius in the territory of Sicyon. He studied philosophy under Stilpo, at Megara, and under Pyrrho, in Elis. He subsequently spent some time in the countries north of the Ægean, and thence went to Athens, where he passed the remainder of his life, and died in the ninetyeth year of his age.

Diogenes Laertius, who has written an account of Timon (ix., c. 12), ascribes to him epic poems, 60 tragedies, lyric dramas, 30 comedies, silli (*σῆλλοι*), and cinaedi (*κίναεδοί*) or licentious songs. The silli however appear to have been the kind of poetry in which he excelled. They were satires directed against the arrogance and pedantry of the learned. Timon wrote three books of silli (*Athæticus*, vi., p. 251; vii., p. 279), in which he parodied all dogmatic philosophers of Greece: he himself was a sceptic. The metre of these poems was the hexameter, and it appears that sometimes he took whole passages from Homer which he applied as parodies. In the first book Timon spoke in his own person; in the second and third the form of the poems was that of a dialogue, in which he conversed with Xenophanes of Colophon, who was supposed to have been the inventor of the silli. (*Diogenes Laert.*, ix. 111.) We now only possess a few fragments of these poems, which show that in their way they must have been admirable productions. They are collected in L. Stephanus, 'Poesis Philosophica;' in F. Paul, 'De illis Græcorum,' Berlin, 1821, p. 41, &c.; in Brunck's *Analecta*, ii. 67; and iv. 139. Respecting the other works ascribed to him we possess no information.

(J. F. Langheinrich, *De Timone Sillographo*, in 3 parts, Lipsiæ, 1720-23.)

TIMON (*Τίμων*), surnamed the Misanthrope, was a son of Echekratides, and a native of Colyttus, a demos in Attica. (*Lucian, Timon*, c. 7; *Tzetzes, Chil.*, vii. 273.) He lived during the Peloponnesian war, and is said to have been disappointed in the friendships he had formed, a consequence of which he conceived a bitter hatred of all mankind. His conduct during the period that his mind was in this state was very extraordinary. He lived almost

entirely secluded from society, and his eccentricities gave rise to numerous anecdotes, which were current in antiquity. The sea is said to have separated even his grave, which was on the sea-coast, from the mainland, by forming it into an island and thus rendering it inaccessible. (*Plutarch, Anton.*, 70; *Suidas, s. v. ἀνορέπῳ*.) The comic poets, such as Phrynichus (*Bekker. Anecdota*, p. 344), Aristophanes (*Lysistr.*, 809, &c.; *Aves*, 1548), Plato, and Antiphanes, ridiculed him in their comedies. Antiphanes wrote a comedy called 'Timon,' which perhaps furnished Lucian with the groundwork for his dialogue in which this misanthrope acts the most prominent part. His name has remained proverbial to designate a misanthrope down to the present day, and is immortalized by the genius of Shakspeare.

(Hemsterhuis, *On Lucian*, vol. i., p. 99, of the smaller edition.)

TIMOR. [SUNDA ISLANDS, LESSER.]

TIMORLAUT. [SUNDA ISLANDS, LESSER.]

TIMOTE'O DA URBI'NO, or DELLA VITE, a celebrated Italian painter of the Roman school, was born at Urbino in 1470, or rather 1480. In about his 20th year, by the advice of a brother living in Bologna, he repaired to that city to learn the business of a jeweller, &c.; but displaying a power of design worthy of a greater purpose, he devoted himself to painting, and according to Malvasia attended the school of Francia in Bologna for about five years: Vasari however says that Timoteo was his own master. At the age of 26 he returned to Urbino, where in a short time he so far distinguished himself, says Vasari, as to receive an invitation from his cousin Raphael in Rome to repair thither and assist him in some of his extensive works. This statement creates a difficulty not easy to be cleared up: Vasari says that Timoteo died in 1524, aged 54; yet we find him in his 27th or 28th year, consequently in 1497 or 1498, going to Rome to assist Raphael, who however did not go to Rome himself until 1508: 1524 was very probably therefore a misprint for 1534 in the original edition of Vasari, and the error has found its way into all the later works. By this supposition and by allowing a year or two to have elapsed between his return to Urbino and his visit to Rome, the various dates may be easily reconciled, and what Vasari says about Timoteo's assisting Raphael to paint the Sibyls in the Chiesa della Pace, which were painted in 1511, becomes quite consistent. He did not remain long in Rome, but returned to his native place at the solicitation of his mother, much to the displeasure of Raphael. He remained however quite long enough to learn to appreciate and to imitate the beauties of Raphael's style, and to become one of the most distinguished painters of the Roman school; yet there are in all his works traces of the style of Francia, a certain timidity of design, a delicacy of execution, and a richness of colouring. His chief works are at Urbino, at Forlì, and in the neighbourhood; he executed many of them in company with Girolamo Genga, as a chapel at Forlì and part of the paintings in the chapel of San Martino in the Cathedral of Urbino; the altar-piece was painted entirely by Timoteo: he executed also some excellent works in fresco at Castel Durante. Further, in Urbino there are—in the Cathedral, a Magdalen; in San Bernardino, outside the city, a celebrated picture of the Annunciation of the Virgin; and another fine picture with several figures in Santa Agata; also in the residence of the Dukes of Urbino, an Apollo and two of the Muses, extremely beautiful; besides many other works. Vasari remarks that he left some works unfinished at his death, which were afterwards completed by others, and he adds that there could not be a more satisfactory evidence of the general superiority of Timoteo. He was of a cheerful disposition, and used to play every kind of instrument, but especially the lyre, which he accompanied with his voice, with extraordinary grace and feeling. Lanzi says that the Conception at the Observantines at Urbino, and a *Noli me tangere* in the church of Sant' Angelo at Cagli, are perhaps the best of his works that remain. The same writer observes that Pietro della Vite, the brother of Timoteo, also a painter, was probably the priest of Urbino mentioned by Baldinucci (vol. v.) as Raphael's cousin and heir.

(Vasari, *Vite de' Pittori*, &c.; Lanzi, *Storia Pittorica della Italia*.)

TIMOTHEUS (*Τιμόθεος*), son of Conon of Athens. He inherited from his father a considerable fortune, and if we

may judge from his intimacy with Isocrates, Plato, and other men of talent, and from the manner in which others speak of him, he received a most excellent education; but no important particulars are known respecting his earlier life. The first time that he comes prominently forward in the history of his country, was during the war between Thebes and Sparta. In the year B.C. 375, after the battle of Navos, the Thebans, who were threatened with an invasion by the Lacedæmonians, requested the Athenians to avert this danger by sending a fleet round Peloponnesus, as they had done at the beginning of the Peloponnesian war. The request was readily complied with, and Timotheus was appointed commander of a fleet of sixty ships, with which he was to sail round Peloponnesus and along the western coasts of Greece. In this expedition he first took Coreyra, which he treated with the utmost mildness and without making any use of his right as conqueror. The consequence was, that he had very easy work with Cephalonia and Acarnania, and that even Alcetas, king of the Molossians, was induced to join the Athenian alliance. But while Timotheus was thus reviving the power of Athens in that part of Greece, the Lacedæmonians sent out a fleet against him, under the command of Nicolochus. A battle was fought near the bay of Alyzia, in which the Spartans were defeated. Soon after Nicolochus offered another battle, but as the fleet of Timotheus had suffered too much to allow him to accept it, Nicolochus raised a trophy. But Timotheus soon restored his fleet, which was increased by reinforcements of the allies to seventy ships, against which Nicolochus could not venture anything. The original object of the expedition however was now accomplished, as the Spartans had not been able to make their projected invasion of Bœotia, and Thebes was thus enabled to direct her forces against the Bœotian towns which asserted their independence. Timotheus at the head of his large fleet had no means of maintaining it, for Thebes herself had contributed nothing towards it, and Athens, which was not in a very prosperous condition, had been obliged to bear all the expenses of the fleet, with the exception of what Timotheus himself had furnished from his private purse. Athens therefore concluded a separate peace with Sparta, and sent orders to Timotheus to return home. On his way thither he landed at Zacynthus a body of exiles who probably belonged to the democratical party of the place, and who had sought his protection. He provided them with the means of opposing and annoying their enemies, the oligarchical party of Zacynthus, which was in alliance with Sparta. The oligarchs sent envoys to Sparta to complain, and Sparta sent envoys to Athens to remonstrate against the conduct of her admiral. But no satisfaction was given, as the Athenians would not sacrifice the Zacynthian exiles for the purpose of maintaining the peace. The Spartans therefore looked upon the peace as broken, and prepared for new hostilities.

Soon after these occurrences Coreyra was hard pressed by the Peloponnesian fleet, and implored the Athenians for protection. Timotheus, who, on his former expedition, had given such great proofs of skill and talent, was again entrusted with the command of sixty ships. But Athens, which was itself in great financial difficulties, had not the means to equip them, and Timotheus in the spring of 373 B.C. sailed to the coasts and islands of the Ægean to request the Athenian allies to provide him with the means of assisting the Coreyraeans. He appears to have received some support from Bœotia (Demosth. in *Timoth.*, p. 1188.), and in Macedonia he formed friendly relations with king Amyntas. His proceedings however went on very slowly, and apparently without much success, for he was of too gentle a disposition to force the allies to furnish what they could not give conveniently. At last however he had sailed as far as the island of Calauria, where his men began to murmur because they were not paid. The state of affairs in Coreyra had grown worse every day. His enemies at Athens seized upon the slowness of his progress as a favourable opportunity for aiming a blow at him. Iphicrates and Callistratus came forward to accuse him, whereupon he was recalled, and the command of his fleet given to his accusers and Chabrias. His trial was deferred till late in the autumn; but he was acquitted, not indeed on account of his innocence, though it was well attested, but on account of the interference of Alcetas, the Molossian, and Jason of Pheræ, who had come to Athens to protect him.

In B.C. 361, after the removal of his rival Iphicrates, Timotheus received the command of the fleet on the coast of Macedonia. He took Potidea and Thracian Olynthus, and these conquests were followed by the reduction of all the Chalcidian towns. From thence he proceeded to the Hellespont, where, with the assistance of Artabazanes, he again gained possession of several towns. In the year following he commenced his operations against Amphipolis, in which however he had no success, probably on account of the interference of the Macedonians, who supported the town, and Timotheus was nearly compelled to take to flight.

In the year 357 B.C. Timotheus and Iphicrates, who had for some time been reconciled to each other through the marriage between a daughter of the former and a son of the latter, obtained the command of a fleet of 60 ships against the rebellious allies of Athens, especially against Samos. But the Athenian arms were unsuccessful, and a treaty was concluded between the belligerents, which put an end to the Social War. The Athenian generals however, Timotheus, Iphicrates, and Menestheus, were charged with having caused the ill-luck of the Athenians, and brought to trial. Timotheus in particular was accused of having received bribes from the Chians and Rhodians. His colleagues, who were themselves in the greatest danger, were so convinced of his innocence, that they declared they were willing to take all the responsibility upon themselves. But he was nevertheless condemned to pay a fine of 50 talents. As he was unable to pay the sum, he withdrew to Chalcis in Eubœa, where he died soon after, in B.C. 354. The injustice of this sentence was tacitly acknowledged by the Athenians after the death of Timotheus, by the manner in which his son Conon was allowed to settle the debt of his father.

Timotheus was no less distinguished as a man than as a general. He was of a very humane and disinterested character. He sacrificed all his property in the service of his country, while other men of his age used public funds only as a means of enriching themselves. When Alcetas and Jason came to Athens to protect him, they lodged in his house, at which time he was so poor, that he was obliged to borrow furniture to receive his illustrious guests in a manner worthy of their station. Even his enemies when they came to know him, could not help bear attachment and esteem for him.

(Nenophon, *Hellen.*, v. 4, 63, 83, &c.; vi. 2, 11, &c.; Isocrates, *De Permutatione*; C. Nepos, *Timotheus*; *Diodorus Sic.*, xv. and xvi.; compare Thirlwall, *History of Greece*, vol. v.)

TIMOTHEUS (Τιμόθεος) of Miletus, a Greek musician and lyric poet. The time when his reputation had reached its height was about the year B.C. 394. *Diodorus Sic.* xiv. 46.) He was a contemporary of Euripides, and spent the last years of his life at the court of Macedonia, where he died in B.C. 357, at the advanced age of 67. He increased the number of the strings of the lyre to eleven, an innovation which was considered by the Spartans as would not go beyond the number of seven strings to be a corruption of music, and a decree was passed at Sparta, which is still extant in Boethius, condemnatory of his innovation. (Plutarch, *De Mus.*, p. 1141, ed. Franke; *Athenæus*, xiv., p. 636.) Suidas mentions a great number of poetical compositions of Timotheus, which were at the time very popular in Greece; among them are rhapsodies, thirty-six proœmia, eighteen dithyrambs, and twenty-one hymns. All these works are now lost, with the exception of a few fragments which are preserved in Athenæus and the grammarians.

(Vossius, *De Poetis Græcis*, p. 46; Bode, *Græchische Lyrische Dichtkunst der Hellenen*, vol. ii., p. 36 &c.)

TIMOTHEUS (Τιμόθεος), an Athenian poet of the so-called middle comedy. Suidas mentions the titles of several of his plays, and Athenæus (vi., p. 243) has preserved a fragment of one which bore the title 'The Life of Dog.' (Compare A. Meineke, *Historia Critica Comœdiarum Græcarum*, p. 424.)

TIMOTHY, EPISTLES OF ST. PAUL TO. Timothy to whom these Epistles are addressed, was a native of Lystra, a city of Lycaonia, in Asia Minor. His father was a Greek, or Gentile, but his mother, Eunice, was a Jewess. Both his mother and grandmother Lois were Christian believers (2 *Timoth.*, i. 5), who were probably converts

to the faith by the preaching of Paul and Barnabas on the occasion of their first apostolical journey among the Gentiles. Whether Timothy was himself converted by St. Paul or by the teaching of his mother does not appear; but it is certain that she had taken great pains with her son's education, for from a child, as St. Paul says, 'he had known the Holy Scriptures.' (2 *Timoth.*, iii. 15.) His devotion to his new faith was so ardent, and the progress he made in the knowledge of the gospel so great, that he gained the esteem and good word of all his Christian acquaintance. Accordingly when St. Paul paid his second visit to Lystra, the believers both of that city and Iconium commended him so highly to Paul, that he 'would have Timothy go forth with him' as the companion of his travels. Previously to commencing them however St. Paul circumcised Timothy, 'because of the Jews,' who were numerous and powerful in those parts, and likely to take offence at the preaching and ministrations of an uncircumcised teacher. (*Acts*, xvi. 1-3.) He was then solemnly admitted and set apart to the office of an evangelist, or preacher of the gospel, by the elders of Lystra and St. Paul himself laying their hands upon him (1 *Tim.*, iv. 14; 2 *Tim.*, i. 6), though he was probably not more than twenty years of age at the time. From this period (A.D. 46) mention is frequently made of Timothy as the companion of St. Paul in his journeys, as assisting him in preaching the gospel, and in conveying his instructions to the different Christian churches. His first mission was in company with St. Paul and Silas, when they visited the churches of Phrygia and delivered to them the decrees of the council of elders at Jerusalem, by which the Gentiles were released from the obedience to the law of Moses as a requisite for salvation. From Phrygia he proceeded in the same company to Troas, and thence to Macedonia, where he assisted in founding the churches of Philippi, Thessalonica, and Berea, at the last of which cities he and Silas were left when St. Paul was driven from Macedonia by the persecution of the Jews in that country and retired to Athens. In this city St. Paul was subsequently joined by Timothy (1 *Thess.*, iii. 1), who gave him such an account of the afflicted state of the Thessalonian Christians as induced him to send Timothy back to 'establish and comfort them, concerning their faith': a charge both of difficulty and danger. From Athens St. Paul went to Corinth, where he was joined by Timothy and Silvanus, who both assisted him in converting the Corinthians and establishing the Corinthian church, for a period of a year and a half. (2 *Cor.*, i.) When St. Paul left Corinth, Timothy appears to have accompanied him on his return to Asia, where they resided nearly three years, without interruption, except during the visit of St. Paul to Jerusalem, to keep the feast there, in which however it does not appear that he was accompanied by Timothy. Towards the expiration of their residence at Ephesus, St. Paul despatched Timothy and Erastus together to precede himself on a journey to Macedonia. (*Acts*, xix. 22.) It would also seem (1 *Cor.*, iv. 17) that St. Paul at the same time charged Timothy to visit the church of Corinth. On returning from Corinth to Macedonia, Timothy was joined by St. Paul from Ephesus, and henceforward they were frequently together, till Timothy was appointed by St. Paul to govern the church of Ephesus. In the interval between St. Paul's joining Timothy in Macedonia and the appointment of the latter to the superintendence of the church at Ephesus, Timothy appears either to have accompanied St. Paul on his first journey to Rome, or to have visited him there. St. Paul, as is well known, was a prisoner at Rome, though under but little restraint, and from *Hebrews* (xiii. 23) we may conclude that Timothy also suffered imprisonment either at Rome or elsewhere in Italy; and that he was released before St. Paul left that city. The subsequent history of St. Paul and Timothy is not clearly given either in the *Acts of the Apostles* or the Epistles of the New Testament; but it is reasonable to suppose that when they were both set at liberty, they renewed the journeys made for founding new churches and revisiting old. (See *Hebrews*, xiii. 23; *Philipp.*, i. 1; ii. 19; 1 *Tim.*, i. 3.)

Timothy was eventually left with the charge of the church at Ephesus, where St. Paul had made his headquarters in Asia. How long Timothy exercised this office is not known, nor can we determine the time of his death. An ecclesiastical tradition relates that he suffered martyrdom, being killed with stones and clubs (A.D. 97)

P. C., No. 1546.

while he was preaching against idolatry in the neighbourhood of the temple of Diana at Ephesus. His supposed relics were removed to Constantinople, with great pomp, A.D. 356, in the reign of the emperor Constantine. Shortly after Timothy's appointment to the superintendence of the church at Ephesus, St. Paul wrote to him his first Epistle; the date of which was probably about A.D. 64, after St. Paul's first imprisonment at Rome. Some critics indeed assign to it as early a date as A.D. 56, supporting their opinion by 1 *Tim.*, i. 3, from which it appears (1.) that Timothy was in Ephesus when the Apostle wrote his first letter to him; (2.) that he had been left there when Paul was going from Ephesus into Macedonia. A careful examination however of the narrative in the *Acts* will convince the reader that the contemplated journey into Macedonia, of which the Apostle speaks (1 *Tim.*, i. 3), is some journey not mentioned in the *Acts*, and therefore subsequent to St. Paul's release from his first confinement at Rome. But whatever doubt there may be as to the date of the first, there is none about the genuineness of either of the two Epistles to Timothy. They have always been acknowledged to be the undisputed production of the Apostle Paul. The object and design of the First Epistle to Timothy were such as we might have expected from the relation between St. Paul the writer, and Timothy, to whom it was addressed. It was written with the view of guiding and directing the latter in his responsible and difficult ministry as the head of the church at Ephesus, to instruct him in the choice and ordination of proper officers, and to warn him against the false teachers (Michaelis thinks they were Essenes) who had 'turned aside' from the simplicity of the gospel, to idle controversies and 'endless genealogies,' and who, setting themselves up as teachers of the Law of Moses, had insisted upon the necessity of obedience to it as a requisite for salvation.

In chap. i., accordingly, St. Paul alludes to the commission given by him to Timothy at parting, and specifies the particular errors which he was to condemn, together with the truths which he was to inculcate.

In chap. ii. the apostle describes the manner in which the public worship of the church at Ephesus was to be conducted.

In chap. iii. St. Paul explains the qualification of the persons whom Timothy was to ordain as bishops and deacons, and tells him that he had written the letter with a view of teaching him 'how he ought to behave himself in the house of God, which is the church of the living God, the pillar and the ground of truth.'

The last verse of this chapter has occasioned much controversy respecting the reading of the word *Θεός*, or 'God,' for which one MS. has *ὅς*, 'who,' and another *ὃ*, 'which.' The majority of the MSS. read *Θεός*, or 'God,' and several of the antient versions express the *ὃ* or 'which,' instead of *Θεός*.

In chap. iv. St. Paul foretells the heresies which were to arise in the church in after-times, and strongly condemns them. He also exhorts Timothy to a faithful and exemplary discharge of his duties, and to a steadfast continuance in the doctrines of the Gospel.

In chap. v. St. Paul instructs Timothy in the right method of admonishing the old and the young of both sexes. He also describes the age and character of such widows as were to be employed by the church in teaching the younger women the principles of religion, for which it would seem that the former received some recompense from the funds of the church.

In chap. vi. St. Paul describes the duties which he wished Timothy to inculcate on Christian slaves, as owing from them to their masters, whether infidels or believers. He also reprobates strifes about words, and perverse disputings, which seem to have been rife in the Ephesian church; condemns an inordinate love of money, exhorts Timothy to charge the rich to be 'rich in good works,' and concludes with a most solemn charge before God and Jesus Christ, that he should keep 'the commandment,' without spot and unblameable.

The Epistle was written from Nicopolis in Macedonia (*Titus*, iii. 12), and not from Laodicea, as the subscription informs us. The undesigned coincidences between it and the *Acts of the Apostles* are given in Paley's 'Horæ Paulinæ,' p. 323-338.

The Second Epistle of Paul to Timothy.—From chap. i., VOL. XXIV.—3 O

vers. 8, 12, 17, it appears that this Epistle was written by St. Paul while he was a prisoner at Rome; but whether he wrote it during his first imprisonment, recorded in *Acts*, xxviii., or during a *second* imprisonment, has been much questioned. According to the uniform tradition of the ancient church, it was written during the second confinement. The modern critics, who refer it to the time of the *first*, are for the most part anti-episcopalians or Romanists: the former being concerned to deny the permanency of Timothy's charge at Ephesus; the latter not knowing how to account for the omission of Peter's name in the salutations from Rome. The arguments adduced by Macknight (Preface to 2 *Timothy*) in support of the opinion of the ancient church are, we think, conclusive. St. Paul, it is generally agreed, returned to Rome after his first imprisonment, early in A.D. 65; where, after being kept in bonds as an 'evil doer' for more than a year, he is believed to have suffered martyrdom, A.D. 66. As therefore the Apostle requests Timothy (iv. 21) to come to him at Rome before winter, it was probably written in July or August, A.D. 65; and it is generally supposed that Timothy was at Ephesus when St. Paul addressed it to him.

The immediate design of St. Paul in writing this Epistle was, it would seem, to apprise Timothy of the circumstances that had recently happened to himself at Rome, and to request his immediate presence there. Accordingly we gather from the last chapter of this Epistle, that St. Paul was closely confined as a malefactor for some crime laid to his charge; that when he was brought before the Roman magistrates to make his first answer, 'no man stood by him, but all men forsook him;' that only Luke was with him: that being thus deserted by almost all, he was greatly desirous of seeing Timothy, 'his dearly beloved son in the gospel,' before the 'time of his departure,' which he knew 'was at hand.' He therefore requested him to come to Rome immediately, but being uncertain whether he should live to see Timothy again, he gave him in this Epistle a variety of admonitions, charges, and encouragements. This Epistle in fact is an appropriate and affecting sequel to the first, the principal injunctions and warnings of which it repeats, but with additional earnestness and fervour. St. Paul, as if for the last time (chap. i.), conjures Timothy to apply himself with all his gifts of grace to his holy work, to hold fast the doctrine which he had received from him, and not to be ashamed either of the testimony of the Lord or of St. Paul's own sufferings.

In chap. ii. St. Paul again cautions Timothy against heretics and 'foolish questions,' and exhorts him to personal holiness. In chap. iii. he gives a description of the 'perilous times which should come,' and which were to be anticipated by every possible exertion in performing the duties of a Christian minister. To this work, in chap. iv., he exhorted him by a solemn charge before 'God and the Lord Jesus Christ, the judge of the quick and the dead.' He then depicted his own present state, and his presentiment of an approaching martyrdom; and after requesting the immediate presence of Timothy, concluded by sending to him the greetings of some of the brethren of the Church at Rome. Whether Timothy arrived at Rome in time to find St. Paul alive, does not any where appear: the latest authentic information we have concerning him being given in this letter.

The Epistles to Timothy, in conjunction with those to the Thessalonians and Titus, are extremely valuable, as furnishing very strong evidence to the truth of many of the facts related in the *Acts of the Apostles*. The undesigned coincidences between the *Second Epistle to Timothy* and the *Acts* are given by Paley, in his 'Horæ Paulinæ,' pp. 339-356. Their value in another respect is thus described by Macknight, Preface to 1 *Timothy*—'These Epistles are likewise of great use in the church, as they exhibit to Christian bishops and deacons in every age the most perfect idea of the duties of their functions: teach the manner in which these duties should be performed: describe the qualifications necessary in those who aspire to such offices, and explain the ends for which they were instituted, and are still continued in the church.'

To the *Epistle to Timothy*, that addressed by St. Paul to Titus, nearly at the same time, is both a companion and an illustration. The subject matter is nearly the same in both, and it is important to observe, that in none of these Epistles, addressed to intimate and tried friends, do we perceive any doctrine or precept at all different from what

is enforced in the Epistles addressed to and designed for whole churches. The views and hopes and motives of action are the same in both: a proof of the Apostle's sincerity, and an evidence that he did not teach a double doctrine, one for the learned and the other for the vulgar.

(Horne's *Introduction to the Critical Study of the Scriptures*, vol. iv., p. 378; Macknight, vol. iii.; Brown, Preface to 1 and 2 *Timothy*; Evans's *Scripture Biography*.)

TIMOTHY-GRASS, so called from a person of that name who successfully cultivated it in North America, where it seems to grow more luxuriantly than any other kind of grass. Its botanical name is *Phleum pratense*, and its common English name is *Meadow Cat-tail Grass*. It has been highly extolled by many agriculturists for the profusion of hay which it makes, and also for its rapid growth when depastured. It is but a coarse grass when allowed to stand till it is fit for hay; and in rainy weather it so readily imbibes moisture, that the harvest is very precarious. This is a principal reason why its cultivation has not been much extended in England. It is said to give a very sweet and early herbage for sheep in spring, and mixed with other grasses, may be very useful in laying down land to pasture for a few years.

The soil which suits timothy-grass best is a good mud and rather stiff loam. On gravel or chalk it soon dies off. It is scarcely to be recommended without a mixture of other grasses, although very heavy crops of it have been grown; and from its strong stem, when full grown, it should always be fed off when young, or cut for feeding horses and cattle before the stem has acquired its full growth. That it is not a grass naturally suited to the climate of Great Britain appears from its not being generally found in the best natural pastures. In rich land which is tired of clover it may form a very good substitute to cut up green and depasture afterwards. The experiments which have been made with timothy-grass are not sufficiently satisfactory to form a decided opinion of its real merits, and it well deserves the attention of experimental agriculturists.

TIMUR, SULTAN, KIAMRAM KOTB-ED-DIN GURGAN SA'HEB-KIRA'N JIHA'NGIR, that is 'Sultan Timur, the fortunate, the axis of the faith, the great wolf, the master of time, the conqueror of the world.' This name which frequently occurs among the princes of the Eastern Turks, signifies 'iron' in the Jagatai dialect, and corresponds to the Osmanli 'demur.' Timur was born on the 5th or 25th of Sha'ban, 736 A.H. (A.D. 1325), at Sebz, a suburb of Kesh, a town south-east of Samkand. He was the son of Tarāghai-Nowian, who was chief of the Turkish tribe of the Berlas, which inhabited the district of Kesh. Timur was descended from a younger son of Bardam-Khan Behadir, or Baghatir, whose eldest son, Yessugai, was the father of Genghis-Khan and he was a direct descendant of Genghis-Khan on the female side. He was consequently of Mongol origin and, being of royal blood, he held a high rank among the Mongol nobility which was founded by Genghis-Khan among the Eastern Turks. [TARTARS.] This rank is expressed by the title Nowian, which was added to the name of his father. Yet the power of his family was not great. Timur was a soldier at the age of twelve years, and he spent his youth in the continual feuds between the nobles of those different kingdoms and principalities into which the empire of Genghis-Khan was divided by his successors. After the death of his father, his uncle Seif-ed-din became chief of the Berlas, being the eldest of the family; but war having broken out between Husein, khan of Northern Khorāsān, and Mawarainnehr (Mawar-el-nahr), or Jaghān and Timur-Toghluk, khan of the Getes (Getæ), in Northern Turkistan, young Timur actively supported Husein, and was appointed chief of the tribe of the Berlas in A.H. 765 (A.D. 1361). In this war Timur received a wound in his thigh in consequence of which he became lame. From this he was called Timur-lenk, or the lame Timur, which he been corrupted by Europeans into Tamerlane, by which name Timur is as well known in Europe as by his real name. Husein rewarded him also with the hand of his sister Turkan, A.H. 765 (A.D. 1363). Notwithstanding these favours, Timur intrigued against his protector; and after the death of his wife he openly rebelled against him A.H. 767 (A.D. 1365). With a body of only 200 horsemen

he surprised and took Nakhshab, a town which was defended by a garrison of 12,000 men, among whom there were most probably a great number of traitors. In A.H. 768 (A.D. 1366) he defeated Husein near his capital, Balkh, and this prince was murdered by some emirs, who, seeing their former master forsaken by fortune, endeavoured to obtain the favour of Timur by putting his rival to death. Balkh, which was defended by the adherents of Husein, was taken by storm and destroyed by fire after a siege of three years, A.H. 771 (A.D. 1369), and Timur was proclaimed khan of Jagatai in the same year by the Kurultai, or the general assembly of the people. He chose Samarkand for his capital. Husein-Sofi, khan of Khowaresm (Khiwa), having imprisoned Timur's ambassadors, was attacked by Timur, who, after five campaigns, at last succeeded in taking the town of Khowaresm, in A.H. 781 (A.D. 1379). The town was destroyed, and the principal inhabitants, especially artists and scholars, were transplanted to Kesh, which became the second capital of Timur's empire. Previously to this the khan of the Getes, who was master of the country between the Sihun, or Jaxartes, and the Irish, had likewise been compelled to pay homage to Timur, who thus became master of a part of Siberia and of the whole country which we now call Turkistan, and which was formerly known by the name of Great Tartary. After these conquests Timur thought himself strong enough to carry into effect the plan of making himself master of all those countries which had once obeyed his ancestor Genghis-Khan. He first attacked Khorasan, or the north-eastern part of Persia, which was then divided between Gaiyath-ed-din Pir-Ali, who resided at Herat, and Khojah-Ali-Murjid, whose capital was Sebsewar. Khojah-Ali-Murjid, whose dominions were on the boundaries of Jagatai, paid homage to Timur as soon as he was summoned; but the master of Herat prepared a vigorous resistance. Timur took Herat by storm, but did not destroy it. He carried off as his only trophy the iron gates of this town, which were noted for their beautiful workmanship, and which he ordered to be transported to his birthplace, Kesh. The larger towns of Khorasan surrendered without resistance, and Timur was only checked by several strong fortresses, such as Shaburkhan, Kabushan, and especially Kakhaha, between Balkh and Kelat, in the mountains of the Hindu-Kush. When these fortresses fell, all Khorasan was under his yoke. The inhabitants of Sebsewar having revolted, Timur took the town by storm: two thousand of the inhabitants were placed alive one upon the other, till they formed a mass like a tower, and each layer of human beings was fastened to the rest by mortar, as if they were so many bricks.

Beginning his career at an age when other conquerors are satisfied with their laurels, Timur had employed twenty years in reflecting on the principles of warfare. He led his armies with the prudent boldness of an experienced general, but not with the superiority of genius. The differences between the numerous successors of Genghis-Khan enabled Timur to attack them one after another, and each was pleased with the fall of his rivals. He employed the same policy in his war against Persia. This country was governed by several princes. Shah-Sheja, of the dynasty of Mozaffer, who reigned in Fars and southern Irak, or in that part of Persia which was most exposed to any army from the east, submitted to Timur without resistance. Thus Sultan Ahmed, of the house of the Ilkhans, the master of Northern Irak and Azerbaijan, or Western Persia, had alone to sustain the attacks of the Tartars, A.H. 788 (A.D. 1386). Timur entered the dominions of Ahmed by following the coast of the Caspian Sea. In one campaign he conquered the provinces of Mazanderan, Rei, and Rustemdar, and took the towns of Sultania, Tabris, and Nakhshivan. He crossed the Araxes at Julfa on a magnificent bridge, which was strongly fortified on both sides, but which is now destroyed. Kars, now the key of Eastern Turkey, fell into his hands; Tiflis surrendered, and the prince of Georgia purchased his protection by adopting the Mohammedan faith. The prince of Shirwan sent tribute to the camp of Timur, nine pieces of each thing sent (nine was a holy number among the Mongol princes), but only eight slaves; the ninth was himself. On these terms he was allowed to remain in possession of his dominions. Taherten, king of Armenia, submitted to Timur without any resistance; but Kara-Yusuf, prince of Diyarbekir, and master of the country round Lake Wan, prepared

to defend himself. A body of Timur's army marched against him, and took the fortresses of Akhlai and Adiljuwaz by storm; and Timur himself conducted the siege of Wan. This famous fortress fell after a siege of twenty days, the garrison was cast from the steep rock on which this town is situated, and the fortifications were razed by ten thousand miners and pioneers. Ready to cross the Carduchian Mountains and to descend into the valley of the Upper Tigris, Timur was obliged, by a revolt of the inhabitants of Ispahan, to march suddenly to southern Persia. He took Ispahan by a general assault: he spared the lives and the houses of artists and scholars, but the remainder of the city was destroyed, and the inhabitants were massacred. More than 70,000 heads were laid at the feet of the conqueror, who ordered his soldiers to pile them up on the public places of the town, A.H. 789 (A.D. 1387).

Satisfied with having conquered the greater part of Persia, Timur turned his arms towards the north, and overran the kingdom of Kiptshak, which was then governed by Toktamish-Khan. This war lasted from A.H. 780 to 790 (A.D. 1387 to 1396). [TARTARS, *Kiptshak*.] We shall here only mention the march of Timur in the campaign of A.H. 793 (A.D. 1391). According to Sheref-ed-din, Timur started from Tashkend, on the Jaxartes, on the 13th of Safer, A.H. 793 (10th of January, 1391). He marched in a northern direction, and passed by Kara-suma, Yazi, Kara-chuk, and Sabran, until he reached Sarik-Uzen, on the river Arch: thence he proceeded as far as Mount Kuchuk-dagh, and subsequently crossed Mount Ulu-dagh, or the range of the Altai. He then took a north-western direction until he reached the upper part of the river Tobol in Siberia, and thence proceeded westward, crossing the Ural Mountains, and the upper part of the river Ural, or Yaik, where he drew up his army on the banks of the Bielaya, a southern tributary of the Kama, which flows into the Wolga. Toktamish, who awaited Timur in the environs of Orenburg, was not a little astonished to find him so far advanced towards the north; but being informed of his having taken that direction, he hastened to the country of the Bielaya (Baahkiria), and fought that dreadful battle which took place on the 15th of Rejeb, A.H. 793 (18th of June, 1391), in which his whole army was slaughtered.

In the following year (A.H. 794; A.D. 1392) Timur returned to his residence at Samarkand, and he left the war with Kiptshak to his lieutenants; he only appeared in the field in A.H. 797 (A.D. 1315) in order to stop the progress of Toktamish in the Caucasian countries. Meanwhile troubles broke out in northern Persia, which were put down by Timur's generals, who committed unheard-of cruelties, especially in the town of Amul, where the whole tribe of the Fedayis was massacred. Timur himself attacked southern Persia after his first return from Kiptshak. The country of Fars was governed by several princes of the dynasty of Mozaffer, vassals of Timur, who aimed at independence. After having occupied Loristan, Timur entered Fars by the mountain-passes east of Shiraz, which were defended by the stronghold of Kalai-zefid; but this fortress and the capital Shiraz were taken, the princes were put to death or fell in battle, and Timur's son Miran-Shah was invested with the government of Fars and Khuzistan. From Shiraz Timur marched westwards to attack the king of Bagdad, Ahmed Jelair, of the house of Ilkhan. Bagdad surrendered without resistance, and Sultan Ahmed and his family fled towards the Euphrates, accompanied by a small body of cavalry. Timur and forty-five emirs mounted on the swiftest Arabian horses pursued the sultan, and came up with him before he had reached the Euphrates. In the engagement which ensued Ahmed was again defeated and compelled to fly, leaving his harem and one of his sons in the hands of the victor. The scholars and artists of Bagdad were transplanted to Samarkand; Timur remained at Bagdad for two months, allowing so little licence to his soldiers that he ordered all the wine which was found in the town to be thrown into the Tigris.

During this time Kara-Yusuf, prince of Diyarbekir, had recovered part of those districts round Lake Wan which Timur had taken from him in a former campaign; and several princes in Armenia and Georgia were still independent. Timur resolved to bring them to submission, and after having succeeded in this, to attack the kingdom of Kiptshak on its boundaries in the Caucasus. Starting from Bagdad in A.H. 797 (A.D. 1394), he marched to the Upper

Tigris by Tekrit, Roha or Edessa, Ho-su, and Keif, all situated in Mesopotamia. He laid siege to Mardin, a strong place in the mountain-passes south-east of Diyarbekir, but not being able to take it, he contented himself with the promise of an annual tribute which Sultan Iza, the master of Mardin, engaged to pay, and he marched to Diyarbekir. This town was taken and plundered. From Diyarbekir Timur marched to Akhlat, north of Lake Wan, crossing the mountains, as it seems, by the passes of the Bedlis, or Centrites. [TIGRANOCERTA.] After having subdued all Armenia and Georgia, Timur reached the river Terek in the Caucasus, and there fought another bloody battle with the khan of Kiptshak. In A.D. 1395 and 1396 Timur conquered all Kiptshak, and penetrated as far as Moscow, whereupon he left the command of these countries to his lieutenants, and returned to Samarkand, in order to prepare for a campaign against India.

After the death of Firuz-Shah, the master of India between the Indus and the Ganges, several pretenders made claims to the vacant throne. At last Mahmud succeeded in making himself master of Delhi, and in establishing his authority all over the empire of Firuz-Shah. Under the pretext of supporting the rivals of Mahmud, Timur declared war against India; and such was the renown of his name, that ambassadors from all the countries of the East arrived at Samarkand and congratulated him on his new conquests before he had obtained any triumph. Timur left his capital in A.H. 801 (A.D. 1398). He took his way through the passes in the Ghur Mountains, or the western part of the Hindu-Kush; and on the 8th of Moharrem, A.H. 801 (19th of September, 1398), he crossed the Indus at Attock, where Alexander had entered India [ALEXANDER THE GREAT], and where Genghis Khan had been compelled to give up his plan of advancing farther. Timur traversed the Punjab in a direction from north-west to south-east, crossing the rivers Behut, Chunab, Ravee, the Beeah, the Hyphasis of the ancients, where Alexander terminated his conquests, and the Sutlej, the easternmost of the five great rivers of the Punjab. Although no great battle had been fought, the Tartars had already made more than 100,000 prisoners; and as their number daily increased, Timur ordered them all to be massacred, to prevent any mutiny, which might have become fatal to him in case of a defeat. At last the Indian army was defeated in a battle near Delhi, and this town, with all its immense treasures, fell into the hands of the conqueror. Delhi was plundered, and a part of it was destroyed, the inhabitants having set fire to their houses, and thrown themselves with their wives and children into the flames. Several thousands of artists and skilful workmen were transplanted to Samarkand. Timur pursued the army of Mahmud as far as the sources of the Ganges, and after having established his authority in the conquered countries, returned to Samarkand in the same year in which he had set out for the conquest of India.

Meanwhile troubles had broken out between the vassal princes in Persia and the countries west of it; and Timur's own sons, who were governors of this part of his empire, had attacked each other, and one of them was accused of having made an attempt to poison his brother. These events became as many occasions of new conquests for Timur, who overran the whole country between Persia and Syria. Siwas (Sebaste), one of the strongest towns of Asia Minor, which belonged to the Osmanlis, was taken after a siege of eighteen days. The Mohammedan inhabitants were spared; the Christians, among whom were more than 4000 Armenian horsemen, were interred alive. (A.H. 803; A.D. 1400.) Among the prisoners was Ertoghul, the son of Bayazid, sultan of the Osmanlis, who defended the town for his father, and who was put to death after a short captivity. The fall of Siwas and the murder of Ertoghul were the signals for war between Timur and Bayazid, who had filled Europe with the terror of his name, and who was then besieging Constantinople. The rapidity of his marches and the impetuosity of his charges had procured him the surname of 'Ilderim,' or the 'Lightning;' and accustomed to victories over the knights of Hungary, Poland, France, and Germany, he did not dread the Tartars of Timur. Previously to the siege of Siwas, he had negotiated with Timur about some Turkish emirs in Asia Minor, and especially about Taherten, king of Armenia, a vassal of Timur, who had been deprived by Bayazid of several of their best towns, and

whom Timur protected. To humble his pride, Bayazid imprisoned the Tatarian ambassadors, and Timur made a rage carried devastation into the dominions of the Osmanlis.

Before Bayazid had crossed the Bosphorus, Timur, assisted by Ferruj, Sultan of Egypt, overran Syria, then a dependent of Egypt. The army of Ferruj was routed with dreadful slaughter at Haleb, and this populous town was taken by the Tartars, who entered it with the flying Egyptians. Plunder, bloodshed, and cruelties signalized this new conquest (11th to 14th of Rebuil-er-rawal, A.H. 803; 30th of October to 2nd of November, 1400 A.D.); which was followed by the fall of Damascus (9th of Sha'ban, A.H. 803; 25th of March, 1401). Artists and workmen were as usual carried off to Samarkand and other towns of Turan. Ferruj became a vassal of the Tartars. Bagdad having revolted, Timur took it by storm on the 27th of Zilkahe, 803 A.H. (9th of July, 1401 A.D.), and 90,000 human heads were piled up on the public places of the town.

Hitherto negotiations had still been carried on between Timur and Bayazid, who had advanced into Asia Minor with a well-disciplined although not very numerous army. But Bayazid having discovered that Timur had landed several regiments of Turkomans that were in the army of the Osmanlis, the negotiations were broken off, and the two greatest conquerors of their time advanced to meet each other in the field.

After the fate of Haleb, Damascus, and Bagdad, Timur had assembled his army near Haleb, and, crossing the range of the Taurus, he had proceeded north-westwards to the northern part of Anatolia. At Angora he met with Bayazid. The battle, one of the most eventful which have ever been fought, took place on the 18th of Zilkahe, 804 A.H. (20th of July, 1402 A.D.). After an obstinate resistance the Osmanlis, who were much less numerous than the Tartars, were routed. Old Bayazid, to whom flight was unknown, despised every opportunity of saving himself, and so strong was the habit of victory in him, that he could not conceive his defeat even when he saw the general rout of his warriors. At the head of his janissaries, Bayazid maintained himself on the top of a hill; his soldiers died of thirst or fell by the sword and the arrows of the Tartars, at last he was almost alone. When the night came he tried to escape; his horse fell, and Bayazid was made prisoner by the hand of Mahmud Khan, a descendant of Genghis Khan, and who was under-khan of Japan. One of his sons, Muza, was likewise made prisoner; another, Mustafa, fell most probably in the battle, for he was never more heard of; three others, Soliman, Mohammed, and Iza, escaped with part of their troops. Timur received his royal prisoner with kindness and generosity. Afterwards, when some faithful Osmanlis tried to save their master, he was put into chains, but only at night. Accompanying Timur on his march, he sat in a 'kafes,' that is, in a cage hanging between two horses, and this was the origin of the fable that Timur had put Bayazid in an iron cage like a wild beast, a fable which has chiefly been propagated by Arabshah and the Byzantine Phraases (l. 26). Bayazid died in his captivity at Akshehr, about a year after the battle of Angora (14th of Sha'ban, 805 A.H. 8th of March, 1403 A.D.), and Timur allowed Prince Muza to carry the body of his father to Brusa.

The sons of Timur pursued the sons of Bayazid as far as the Bosphorus, but having no fleet, they did not cross this channel. They ravaged the country, and afterwards joined their father Timur, who with the main body of his army took Ephesus and laid siege to Smyrna. This town, which belonged to the Knights of St. John at Rhodes, fell after a brilliant resistance, in the month of December, 1402. Hence the conquest of Asia Minor from the Osmanlis was only a temporary triumph, for a short time afterwards it was recovered by Mohammed I., the son and successor of the unfortunate Bayazid. After having thus carried his arms as far as the shore of the Ionian Sea, Timur withdrew to Persia to quell an insurrection, and then retired to Samarkand. He was preparing for the conquest of China, but he died on his march to that country, at Otrar on the Jamna, on the 17th of Sha'ban, 807 A.H. (19th of February, 1405), in his seventy-first year, after a reign of thirty-six years, having thirty-six sons and grandsons, and seventeen granddaughters. A considerable part of Timur's western and northern conquests, Asia Minor, Bagdad, Syria, Georgia, Armenia, and the whole kingdom of Kiptshak, were lost to his successors almost immediately after his death. It

Persia and Jagatai his descendants reigned for a century; and for three centuries they ruled over Northern India under the name of the Great Moguls.

Timur has been compared with Alexander, but he is far below him. It is true, that except in India, Alexander found only effeminate nations on his way, while Timur fought with the most warlike nations of the world; but the enemies of Alexander formed great political bodies which were governed by one absolute master, while the warlike nations which were subdued by Timur were divided into a multitude of tribes and governed by numerous princes, each of whom was jealous of his neighbour. Timur overran the territory of two mighty nations, the Turks-Osmanlis, and the Tartars of Kiptshak, but he was not able to subdue them. Both Alexander and Timur protected the arts and sciences, but Timur could only transplant them by force from one place to another, while poets and scholars flocked to Alexander because he could appreciate their talents. Timur's cruelty was the consequence of his savage and barbarous temper; Alexander only forgot the laws of humanity when he was overpowered by wine or by passion. Timur was a man of extraordinary talents, who accomplished great things after long experience and severe struggles: Alexander, a true genius, came, saw, and vanquished. The greatness of Timur inspires awe, and we shrink from it with terror; the greatness of Alexander attracts us because it is adorned with the amiable qualities of his character.

The life of Timur is the subject of many valuable works. Sheref-ed-din-Ali wrote the history of Timur in Persian, which has been translated into French by Pétis de la Croix, under the title 'Histoire de Timur-Bec, connu sous le nom du Grand Tamerlan,' &c., Paris, 1722. This is the best work concerning Timur, although the author often flatters Arabshah, a Syrian, on the contrary, depreciates the character of Timur; his history, or rather his epic, has been translated under the title 'Ahmedis Arabsiadae Vitæ et Rerum Gestarum Timuri qui vulgo Tamerlanes dicitur, Historia,' Lugduni-Batavorum, 1636. Longdit, Argote de Molina, Petrus Perundinus Pratensis, Boekler, Richerius, &c. have also written the life of Timur. Among the Byzantines, Ducas, Chalcondylas, and Phranzes contain many valuable accounts, though Phranzes is less critical than the others. A very interesting book is 'Schildberger, eine Wunderbarliche und Kurzwellige Historie,' &c., 4to. The same book was translated into modern German by Penzel, München, 1813. Schildberger, a German soldier, was made prisoner by the Turks in the battle of Nicopolis (1396), when he was only sixteen years old. In the battle of Angora he was taken by the Tartars, and became a kind of secretary to Shalrokh and Miran-Shah, the sons of Timur. He finally returned to Germany in 1427, after a captivity of thirty years, and then wrote the history of his adventures.

Gibbon gives a splendid view of Timur's conquests in the 'Decline and Fall,' chap. lxx. Another most valuable work is Clavijo, 'Historia del gran Tamerlan, e Itinerario,' &c. Clavijo, ambassador of king Henry III. of Castile at the court of Timur, was present at the battle of Angora. (Desguignes, *Histoire des Huns*, vol. ii.) Timur may be considered as the author of the 'Tufukat, or the Code of Laws.' This work was originally written in the East-Turkish language, and was translated into Persian. The Persian version, with an English translation and a most valuable index, was published by Major Davy and Professor White, Oxford, 1783, 4to.; and Langles has translated the Persian version into French, under the title, 'Instituts Politiques et Militaires de Tamerlan,' Paris, 1787. This work is of great importance for the history of Timur; we see that this Tatarian conqueror was provided with maps and works concerning geography, which were composed by his order.

TIN. This metal is one of those which were earliest known, though it occurs in comparatively few countries: the acquaintance of the ancients with this metal, though it does not occur in the native state, is accounted for by the circumstances that the ore is found frequently near the surface, and is easily reduced by charcoal and a moderate degree of heat to the state of metal.

According to Berzelius, tin is found in England, Saxony, Bohemia, Hungary, the isle of Banca, the peninsula of Malacca, in Chili, and Mexico: Malacca furnishes the purest tin, and Cornwall the largest quantity,

Tin occurs in two states of combination, the peroxide and double sulphuret of tin and copper: this last is rather a rare substance, and it is from the former that the metal is almost entirely obtained.

The peroxide of tin is found in Cornwall in two forms:—
1. In veins in primitive countries, where it is intimately mixed with several other metals, as arsenic, copper, zinc, and tungsten: this is common *tinestone*. 2. In loose rounded masses, grains, or sand in alluvial soil, in which state it is called *stream-tin*. The former, when reduced to the metallic state, yields *block-tin*; while the latter yields *grain-tin*, which is the purer of the two.

Oxide of Tin—Tinstone.—Occurs in attached and imbedded crystals, and massive. Primary form a square prism, which is commonly terminated by four-sided pyramids. Cleavage parallel to the lateral planes and both diagonals. Fracture uneven or imperfectly conchoidal. Hardness 6 to 7: gives sparks with steel, and is brittle. Colour white, yellow of various shades, red, brown, and black. Streak paler. Lustre adamantine, vitreous. Transparent, translucent, opaque. Specific gravity 6.96. Insoluble in acids. Before the blow-pipe, in powder on charcoal, it is reduced to the metallic state. Fine crystals of this substance occur, more especially in Cornwall and Saxony.

Analysis of the oxide of tin of Cornwall by Klaproth:—

Tin	77.5
Oxygen	21.5
Iron	0.25
Silica	0.75

100.0

The *Massive Varieties* of oxide of tin are called *stream-tin*. What is termed *wood-tin* is found in reniform and botryoidal masses, or in wedge-shaped pieces, which have arisen from their partial destruction: the surfaces are generally water-worn. Wood-tin exhibits various shades of brown, which sometimes appear in concentric bands, giving it a ligneous appearance, whence its name.

Stream-tin has evidently been derived from the destruction of tin veins or lodes, the lighter portions of stony matter having been carried away by the water, which has rounded the fragments of the ore.

At Finbo in Sweden oxide of tin has been met with containing nearly 2.5 per cent. of oxide of columbium.

Tin Pyrites.—Sulphuret of Tin, a double Sulphuret of Tin and Copper, is a rare substance, having been found only in Cornwall at Huel Rock, in the parish of St. Agnes.

Occurs crystallized and massive. Primary form of the crystal a cube. Cleavage parallel to the faces of the primary form. Fracture uneven, with a metallic lustre. Hardness: readily scratched and reduced to powder; brittle. Colour steel-grey, mixed with yellow. Specific gravity 4.35.

Massive Variety.—Fracture granular and uneven, with a metallic lustre. Hardness 4. Brittle. Opaque. Specific gravity 4.35 to 4.76.

Analysis by Klaproth:—

Tin	34
Copper	36
Iron	2
Sulphur	25

97

Having now described the ores, we proceed to state the *Properties of Tin*.—This metal is of a silver-white colour, very soft, and so malleable that it may be reduced into leaves 1-1000th of an inch thick, called *tin-foil*: it suffers but little change by exposure to the air, and that which does occur arises rather from impure sulphurous vapours than from oxidation; for it is not oxidized even by the combined action of air and moisture. Its tenacity is but slight, so that a wire 1-15th of an inch in diameter is capable of supporting only about 31 pounds: a bar a quarter of an inch in diameter was broken by 296 pounds weight. Tin is inelastic, but very flexible, and when bent it produces a peculiar crackling noise. When rubbed it imparts to the fingers a peculiar smell, which remains for a considerable time. Its specific gravity is about 7.29; at 442° Fahr. it fuses, and if exposed at the same time to the air, its surface is tarnished by oxidization, and eventually a grey powder is formed. When

heated to whiteness it takes fire, and burns with a white flame, and is converted into peroxide of tin. If slowly cooled after fusion, it exhibits a crystalline appearance on solidifying.

Oxygen and Tin do not readily combine at common temperatures: they unite in three proportions, forming the protoxide, sometimes called stannous acid, the sesquioxide, and the per- or bin-oxide, frequently termed stannic acid. Protoxide of tin cannot be procured perfectly pure by direct action: the best method of preparing it is to procure a solution of protochloride of tin, evaporate it carefully to dryness, and then triturate it in a mortar with excess of crystallized carbonate of soda, which decomposes the chloride, and leaves the protoxide of tin.

When this has been washed, and dried carefully on the sand-heat, it is of a fine bluish-black colour, is very soluble in hydrochloric acid, and when heated in the air it takes fire, burns, and is converted into peroxide: the density of protoxide of tin is 6.666: it is soluble in solution of potash and soda, but not in ammonia, nor do the alkaline carbonates dissolve it. It is composed of—

One equivalent of oxygen	8
One equivalent of tin	58
Equivalent	66

The alkaline solutions of this oxide gradually deposit metallic tin, and peroxide remains in solution. Its salts very readily absorb oxygen from the air, and form compounds which readily yield oxygen; and it is on this account that it converts the sesquioxide of iron into protoxide, and precipitates silver, mercury, and platina in their metallic state. With gold a purple compound is formed, known by the name of the purple powder of Cassius. The hydrate of this oxide of tin is white.

Sesquioxide of Tin is formed by mixing fresh precipitated and moist hydrate of peroxide of iron with a solution of protochloride of tin, as free as possible from hydrochloric acid: by the mutual action of these substances a slimy grey matter is thrown down, which is generally slightly yellow, from the presence of a little peroxide of iron. It is composed of—

One equivalent and a half of oxygen	12
One equivalent of tin	58
Equivalent	70

It is soluble in hydrochloric acid, and also in ammonia, which last property distinguishes it from the protoxide; and it is distinguished from the peroxide by giving a purple precipitate with the salts of gold.

Peroxide or Binoxide of Tin, or Stannic Acid.—This is readily prepared by the action of strong nitric acid slightly diluted upon tin: violent action occurs, and the binoxide formed remains in the state of hydrate: after washing and drying and exposure to a red heat, the binoxide remains pure, and is of a straw-yellow colour: the perchloride of tin, when decomposed by an alkali, also yields binoxide of tin: when it has been rendered red-hot it is quite insoluble in acids, and acts as an acid by forming soluble compounds with the alkalis, which are called *stannates*: the moistened hydrate acts as an acid also in reddening litmus-paper. When melted with glass it forms a white enamel.

It is composed of—

Two equivalents of oxygen	16
One equivalent of tin	58
Equivalent	74

Chlorine and Tin combine to form the protochloride and the perchloride. The protochloride is prepared by dissolving the metal in hot hydrochloric acid till the evolution of hydrogen gas ceases: the solution is colourless, and deposits crystals, which sometimes are acicular, and at others prisms of considerable size. They consist of—

One equivalent of chlorine	36
One equivalent of tin	58
Three equivalents of water	27
Equivalent	121

When heated to about 212°, the whole of the water is nearly expelled; at a higher temperature hydrochloric acid is evolved, and oxichloride of tin remains. It is soluble in a small quantity of water, but decomposed by a large quantity, oxichloride of tin being precipitated.

The protochloride of tin is used as a mordant in calico-printing, and in chemical investigations as a de-coloring agent, acting in the mode already described.

Protochloride of tin may also be obtained by dissolving a mixture of equal weights of granulated tin and bichloride of mercury, or of protochloride of mercury, or by transmitting hydrochloric acid gas over tin heated in a glass tube; in all these cases it is procured free from water, and is a grey solid, of a resinous lustre, which fuses below redness and sublimes at a high temperature.

Bichloride of Tin may be prepared in several modes: first, by heating the protochloride in chlorine gas; second, by dissolving the hydrated peroxide in hydrochloric acid; third, by putting tin into the mixture of hydrochloric and nitric acid, called *aqua regia*, which yields nascent chlorine; fourth, when a mixture of 1 part of tin with 4 parts of bichloride of mercury is distilled with a gentle heat, a colourless limpid liquid is obtained, which fumes strongly in moist air; this is the bichloride of tin, formerly known by the name of the fuming liquor of Libavius: it boils at 248°, is rendered solid by the addition of one third of its weight of water, and dissolves in a larger quantity: by the action of alkalis it is decomposed, hydrated peroxide of tin being precipitated.

It consists of—

Two equivalents of chlorine	72
One equivalent of tin	58
Equivalent	130

A solution of this salt under the name of nitromurate of tin is extensively used in dyeing and calico-printing.

Sulphur and Tin combine in three proportions: the protosulphuret is prepared by adding to melted tin an equal weight of sulphur, and stirring the mixture till combustion is effected; the product is to be powdered when cold, mixed with an equal weight of sulphur, and thrown in small portions into a hot crucible and eventually heated to redness. Its properties are, that it is of a bluish-black colour, has a metallic lustre, fuses at a red heat, and when cooled has a lamellated texture. When hydrosulphuric acid gas is passed into a solution of protochloride of tin, a similar compound is obtained; hydrochloric acid dissolves protosulphuret of tin with the evolution of hydrosulphuric acid gas, a solution of the protochloride of tin being formed.

It is composed of—

One equivalent of sulphur	16
One equivalent of tin	58
Equivalent	74

Sesquisulphuret of Tin.—To prepare this, finely powdered protosulphuret of tin is to be mixed with a third of its weight of sulphur, and the mixture is to be heated to moderate redness until sulphur is no longer volatilized. It has a deep greyish-yellow colour, and when strongly heated is reconverted to the state of protosulphuret; when heated in hydrochloric acid, hydrosulphuric gas is given out.

It is constituted of—

One and a half equivalent of sulphur	24
One equivalent of tin	58
Equivalent	82

Bisulphuret of Tin may be prepared in different modes when hydrosulphuric acid or hydrosulphate of ammonia is added to a solution of bichloride of tin, a bulky precipitate of a dirty yellow colour is obtained; this is hydrated bisulphuret of tin: in the dry way it is procured by heating a retort twelve parts of tin amalgamated with six parts of mercury, rubbed up with seven parts of sulphur and six of hydrochlorate of ammonia; the mercury facilitates the combination of the tin and sulphur, and the ammonia, becoming so high as to decompose the bisulphuret of tin formed. This substance, formerly known to the alchemists by the name of *Aurum murorum*, or *Murair Gold*, is in crystalline scales, and sometimes in six-sided plates of a golden-yellow colour and metallic lustre. It is not soluble in any acid, but nascent chlorine, in the form of what was formerly called *aqua regia*, dissolves it; it is soluble also in solution of potash and soda, forming what have been called *sulphur salts*.

It consists of—

Two equivalents of sulphur	82
One equivalent of tin	58
Equivalent	90

Phosphuret of Tin is readily formed by adding phosphorus to the melted metal; it is of a silvery-white colour, and soft enough to be cut with the knife. After fusion it crystallizes on cooling; when thrown upon a red-hot coal, the phosphorus burns. This compound does not appear to have been accurately analyzed; but when phosphuretted hydrogen is made to act upon a solution of protochloride of tin, a terphosphuret is formed, which is readily oxidized by the action of the air.

It consists of—

Three equivalents of phosphorus	48
One equivalent of tin	58
Equivalent	106

Iodides of Tin.—To prepare the protiodide, two parts of granulated tin are to be heated with five parts of iodine; the resulting iodide is a red translucent substance, very fusible, soluble in water, and volatile at a high temperature.

It consists of—

One equivalent of iodine	126
One equivalent of tin	58
Equivalent	184

The *Periodide of Tin* is formed by dissolving the hydrated peroxide of tin, precipitated by an alkali from the solution of the bichloride, in hydriodic acid; it forms crystals of a silky lustre, which are resolved by boiling water into peroxide of tin and hydriodic acid.

Seleniuret of Tin.—When tin is fused with selenium, they combine with the evolution of light. The compound formed is a spongy mass, of a grey colour and metallic lustre; when heated, selenium is expelled and peroxide of tin remains.

OXISALTS OF TIN.

Protonitrate of Tin is formed by dissolving either the metal or the protoxide in dilute nitric acid; a yellow uncrystallizable solution is obtained; by exposure to the air it absorbs oxygen, and peroxide of tin is precipitated.

It is probably composed of—

One equivalent of nitric acid	54
One equivalent of protoxide of tin	66
Equivalent	120

Pernitrate of Tin.—When tin is acted upon by strong nitric acid, the peroxide formed remains entirely insoluble in the acid; to procure the pernitate it is best to cause the hydrated peroxide to dissolve in dilute nitric acid. The solution is colourless and yields no crystals; when diluted or heated, it is rendered turbid.

Sulphates of Tin.—By boiling excess of tin in sulphuric acid, a solution is obtained from which colourless acicular crystals of sulphate of tin are deposited. When, on the other hand, tin is boiled in excess of sulphuric acid, or hydrated peroxide of tin is dissolved in the acid, persulphate of tin is obtained in solution, but it cannot be made to crystallize.

Carbonate of Tin.—When carbonate of potash is added to protochloride of tin, a white precipitate is formed, which, supposing it to contain carbonic acid while moist, loses it during washing and drying; it appears therefore that a permanent carbonate of this metal is not attainable.

Phosphates of Tin.—When phosphate of soda is added to a solution of protochloride of tin, an insoluble white precipitate of protophosphate is obtained; the perphosphate, also an insoluble colourless precipitate, may be procured by adding the phosphate of soda to a solution of perchloride of tin.

Having described the principal and best known oxisalts of tin, we shall mention the characters of the salts of tin, as given by Dr. Thomson; they are as follows:—The proto-salts of tin are white, and the solutions of them are usually colourless; their taste is astringent and metallic, and highly disagreeable; when in solution, they rapidly absorb oxygen, and are converted into the corresponding persalts.

When a plate of lead or zinc is put into a solution of tin, it is thrown down in the metallic state. Ferrocyanide

of potassium occasions a white gelatinous precipitate when dropped into these solutions, and sulphuret of potassium occasions a coffee-brown precipitate in the salts of the protoxide of tin; but neither gallic acid nor infusion of galls occasions any precipitate. When chloride of gold is poured into solutions of protoxide of tin, a purple-coloured precipitate falls. A solution of potash throws down a white precipitate, which dissolves in excess of the alkali. If the solution be boiled, a black powder falls, which is metallic tin; while a compound of peroxide of tin and potash remains in solution. Ammonia throws down a white precipitate, not soluble in excess of the alkali.

ALLOYS OF TIN.

Most of the malleable metals are rendered brittle by alloying with tin; it combines readily with potassium and sodium, forming brilliant white alloys, which are less fusible than tin; the potassium alloy burns readily when it contains more than one-fifth of potassium. With arsenic it forms a metallic mass which is whiter, harder, and more sonorous than pure tin. With antimony tin forms a white, hard, and sonorous alloy. Bismuth forms with tin an alloy which is more fusible than either of the metals separately, a mixture of equal weights melting at 212°; this compound is hard and brittle. Copper and tin form alloys which are well known and highly useful; they are bell-metal and bronze. With mercury tin readily amalgamates, and the compound is used for silvering mirrors. With iron tin forms white compounds which are more or less fusible according to the proportion of iron they contain; tinsplate is of all the alloys of tin the most useful, and the preparation of this and of pewter are the most extensive applications of this very valuable metal.

TIN, MANUFACTURE OF. Under this head may be noticed, first, the processes required to bring tin into a marketable state, embracing the smelting and refining of the metal; secondly, the manufacture of tin-ware, or of articles of tin-plate; and, thirdly, a few of the manufactures of compound metals in which tin forms the principal ingredient. The process of **TINNING**, or of covering plates of iron, the inner surfaces of vessels of iron or copper, &c., with a thin coat of tin, forms the subject of a separate article.

Smelting and Refining of Tin; preparation of Block and Grain Tin.—The processes by which tin-ores are mechanically separated from the grosser impurities which are usually found with them, and broken into fragments convenient for the subsequent operations, are briefly noticed in the article **MINING**, vol. xv., pp. 244 and 245. After being thus reduced to a coarse powder, the ore is roasted or calcined in a reverberatory furnace, until it ceases to exhale arsenical vapours, by which, together with some subsequent processes, it is further cleansed from the admixture of foreign matter and prepared for smelting. A very full account of all the processes connected with the preparation and smelting of tin-ore, as practised about sixty years since, is given in the 'Mineralogia Cornubiensis' of Fryce, of Redruth; but, although most of the processes are still performed with little alteration, we have depended more for the following account of them upon an extensive article on 'Tin,' in Dr. Ure's recently published 'Dictionary of Arts, Manufactures, and Mines,' in which the previous operations of mining are also minutely described.

The ores of tin raised in Cornwall and Devonshire are always reduced, or smelted, within those counties, their exportation being prohibited; but this arrangement is stated not to be injurious to private interests, because the vessels which bring the fuel from Wales for the smelting-furnaces return to Swansea and Neath laden with copper-ores. The smelting-works do not generally belong to the proprietors of the mines, but to other parties who purchase the ore from them, their value being determined by a kind of assay. When several bags of ore, of nearly uniform quality, are taken to the smelting-works, a small sample is taken from each, and these samples, after being blended together, are mixed with about four per cent. of ground coal, placed in an open earthen crucible, and heated in an air-furnace until the ore is reduced. As the furnace is made very hot before the crucible is introduced, the assay is finished in about a quarter of an hour; after which the melted metal is poured into a mould, and the drossy substances which remain in the crucible are pounded

in a mortar, in order to separate, and to add to the ingot, any minute granules of tin remaining among them. Dr. Ure observes that a more exact assay would be obtained by fusing the ore, mixed with five per cent. of ground glass of borax, in a crucible lined with hard-rammed charcoal. A gentle heat should be applied to the crucible during the first hour, a stronger heat during the second hour, and, finally, an intense heat for a quarter of an hour. This process brings out from four to five per cent. more tin than the other; but it is stated that it has the inconvenience of reducing the iron, if any be present, which may be readily ascertained by subsequent solution in nitric acid. This mode of assaying, it is admitted, would be too tedious for ordinary adoption, as the smelter may have occasion to try several samples in one day; and that first described, while imperfect in a chemical point of view, affords a similar result to that realised by the smelter on a large scale.

The smelting of tin-ores is effected by two different methods, which may be briefly described by stating that in the first and most common, the ore, previously mixed with culm, is exposed to heat upon the hearth of a reverberatory furnace, in which pit-coal is used as fuel; while in the second, which is applied merely to *stream tin* (the tin procured from stream-works), and which is followed in order to obtain tin of the finest quality, the ore is fused in a blast-furnace, called a blowing-house, in which wood-charcoal is used for fuel.

In the former process the prepared ore, which is called *schlich*, is mixed with from one-fifth to one-eighth of its weight of powdered anthracite, or culm, to which a little slaked lime or fluor-spar is sometimes added as a flux. These substances are carefully blended together, and a little water is added to the mixture to facilitate the operation of charging the furnace, and to prevent the charge from being blown away by the draft at the commencement of the smelting process. From twelve to sixteen cwt. of the above mixture forms an ordinary charge; but in the smelting-furnaces at St. Austle, or Austell, in Cornwall, of which representations are given by Dr. Ure, each charge amounts to from fifteen to twenty-four cwt. The charge is spread upon the concave hearth of the furnace, and then the apertures by which it is inserted are closed and luted, and the furnace is gradually heated, and kept hot for six or eight hours, by which time the reduction of the ore is complete. The gradual application of the required temperature is necessary to prevent the tin oxide from uniting with the quartz of the gangue, or refuse portion of the ore, and forming a kind of enamel. When the fusion or reduction of the ore is considered to be finished, one of the apertures of the furnace is opened, and the melted mass is stirred up to complete the separation of the tin from the scoriae, which are then drawn out by means of an iron rake. These scoriae consist principally of masses of refuse matter from which no more tin can be profitably extracted, and which are therefore immediately thrown away; but among them are pieces which yet retain a considerable quantity of tin, and which are separated and reserved for further processes. So soon as these refuse matters are removed, a channel is opened, by which the melted tin flows from the hearth into a large vessel called the basin of reception, where it is allowed to rest for some time, in order that the impurities yet remaining with the metal may separate, by their different specific gravities. When it has settled, the tin is ladled into moulds, so as to form it into large blocks or ingots.

The ingots produced by the above process frequently contain portions of iron, copper, arsenic, and tungsten, together with small quantities of sulphurets and arseniurets that have escaped decomposition, unreduced oxide of tin, and earthy matters which have not passed off with the scoriae. To remove these the tin is subsequently exposed to the process of *refining*, which commences by placing the blocks or ingots on the hearth of a second reverberatory furnace, similar to that used for reducing the ore, and applying a moderate heat, which causes the tin to melt, and to flow into a basin provided for it, leaving upon the hearth a residuum which consists of a very ferruginous alloy. Fresh blocks are then placed in the furnace, without removing the unmelted remains of the former, until about five tons of tin have flowed into the basin. This part of the process is termed a *liquation*, and is followed by the actual refining, which is usually effected by plung-

ing billets of green wood into the melted tin in the basin, by means of an apparatus erected by it. This occasions the disengagement of considerable volumes of gas from the wood, and thus a kind of ebullition is produced in the tin, which causes the lighter impurities to rise to the surface in a frothy form, and the heavier to sink to the bottom. The froth or scum, which consists chiefly of the oxides of tin and foreign metals, is skimmed off and returned into the furnace; and when the tin is sufficiently boiled, the green wood is lifted out, and the whole is allowed to settle, in doing which the purest tin rises to the top, that with a trifling admixture of foreign metals remains in the middle, while the foulest portion sinks to the bottom. When the mass becomes so clear that no further separation can take place, the tin is again ladled into moulds; the quality of the blocks thus produced varying according to the order in which the moulds are filled. The blocks formed from the lowest part of the tin are usually so impure as to need a repetition of the refining process. The operation as above described requires four or six hours; of which the first is occupied in filling the basin, the three following in boiling the tin with the billets of wood, and the remaining time in subsidence. A similar effect is sometimes produced by an operation called *stirring*, in which, instead of the ebullition produced by the green wood, the mass of melted tin is agitated by a workman repeatedly lifting a quantity of tin in a ladle, and letting it fall into the basin from a considerable height. After continuing this agitation for some time, the surface is skimmed carefully; and if the upper part of the tin be yet too impure for the market, the refining is rendered more perfect by keeping the metal in a fused state, without agitation, until the impurities separate spontaneously. After refining, the tin is cast into blocks of about three cwt. each. The moulds used for this purpose are frequently made of granite; and the tin thus prepared is called *block tin*. From a very remote period, almost to the present time, a duty was paid upon all tin raised in Cornwall to officers appointed by the duchy, who required the blocks, before being sent to market, to be taken to them for the purpose of being *coined*, or marked with a distinguishing stamp. The mode of collecting the duty in this way was very inconvenient, as it required all tin to be cast into blocks for coining, although it might have to be subsequently re-cast into some other form for sale in foreign markets; besides which the miner or smelter had to bear the expense of sending it to one of the places appointed for coining, and the inconvenience of waiting for one of the periodical coinages, which were usually three months apart. These duties were abolished by 1 & 2 Vict. c. 120, which settles a perpetual annuity on the duchy of Cornwall equal to the average produce of the tin duties for ten years previous to its coming into operation.

It has been stated that the richer portion of the scum left by the process of smelting is reserved for further operations. Such as contain small grains of tin among the scum or refuse are taken to a stamping-mill, and broken up and washed in a similar manner to the ore; while those that contain much tin are re-smelted without any previous preparation. From these scoriae, which are called *prills*, an inferior kind of tin is produced by a second smelting. The inferiority of this product may be readily ascertained, observes Dr. Ure, since the metal which forms the scoriae is what, being less fusible than the pure tin, solidified quickly, and could not flow off into the metallic bath, or basin of reception. The dross or residuum of the refining furnace is fused by increasing the fire after the removal of the refined tin, and is then run out into a separate basin, in which it is allowed to settle. The upper portion is then cast into moulds as impurities, which needs a second refining, and the inferior part of the mixture becomes deposited on the bottom and sides of the vessel in the form of a brittle white alloy, with a crystalline fracture, which contains so large a proportion of foreign metals that no use is made of it.

The average quality of the tin-ore, as prepared for the smelting-furnaces, is such that 20 parts of it yield from 15 to 13 parts of metallic tin, or from 62½ to 65 per cent., and the quantity of coal required for producing one ton of

* So Dr. Ure; but Pryce, in his 'Mineralogia Cornubiensis,' uses the term *pillion*, or *pillion-tin*, and defines it (p. 325), 'The tin which remains in the scoriae or slags after it is first smelted, which must be separated and re-smelted.' He applies the name *prill* to copper in a similar state.

tin is about a ton and three-quarters. Respecting the time when this economical fuel was substituted for wood-charcoal in the smelting of tin-ores, authorities are at variance. Pryce, in his 'Mineralogia Cornubiensis,' p. 282, says that 'Necessity at last suggested the introduction of pit-coal for the smelting of tin-ore, and, among others, to Sir Bevil Granville, of Stow, in this county (Cornwall), temp. Car. I., who made several experiments, though without success;' and he adds that the 'effectual smelting of tin-ore with pit-coal' did not take place till the second year of Queen Anne, 'when a Mr. Liddell, with whom Mr. Moulton, a noted chemist, was concerned, obtained her majesty's patent for smelting block tin with fossil coal in iron furnaces.' 'The invention of reverberatory furnaces built with brick, stone, sand, lime, and clay, soon followed this discovery; the form of which,' he states, writing about 1778, 'has admitted little improvement to the present time.' Holland, after observing that the commencement of this important substitution is generally supposed to have been about 1680, states that the question as to the discovery of the fitness of pit-coal for the purpose lies between Pryce's account, as above cited, and that of Becher (whose name he incorrectly gives Beecher), an ingenious German who, in consequence of persecutions in his own country, visited England in the reign of Charles II., and introduced several improvements in the art of mining; and he quotes a passage, but without referring to his authority, in which Becher claims for himself the credit of the introduction of coal for smelting tin. Whatever may have been the precise time or manner of this improvement, its importance is indisputable; and such is the effect of the superior economy of this and other metallurgic operations as performed in England, that experiment has shown the possibility of bringing tin-ore from the Malay countries to this island for the purpose of smelting, and sending the tin back to the East at a lower price than it can be produced for on the spot.

The smelting or reduction of tin by the blast-furnace, with wood-charcoal, is practised on a limited scale for the production of tin of the greatest possible purity. The finest ores supplied by stream-works, and the finer tin sands, are selected for this operation, and as these are free from many of the impurities found in other ores, they do not require calcination. The works in which blast-furnaces are employed are commonly called *blowing-houses*. The furnaces used are about six feet high, from the concave hearth to the throat, or commencement of the long narrow chimney, which, after proceeding for some distance in an oblique direction, contains a chamber in which the metallic dust carried off by the blast is deposited. The furnace is lined with a vertical cylinder of cast-iron, coated internally with loam; and it has an opening called the *tuyère* near the bottom, by which the blast is introduced, either from large bellows or from cylinders. No substance is added to the ore and charcoal, unless it be the residuary matter of a previous smelting; and the proportion of charcoal consumed is about one ton and six-tenths for every ton of tin produced. The melted tin runs from the furnace into an open basin, whence it is run off into a large vessel in which it is allowed to settle. The scoriæ which run with the metal into the basin of reception are skimmed off, and separated into two portions, one consisting of such as retain tin oxide, and the other of such as have no oxide, but contain tin in a granulated state. The subsequent operations of refining by allowing the mass of metal to rest, and then submitting the upper and purer portion to the refining basin, and re-melting the lower part, and of agitating the tin by the green-wood ebullition, are much the same as with block tin prepared in a reverberatory furnace with pit-coal. In order to convert the blocks of tin produced by the blast-furnace process into the form known as *grain tin*, or, according to the more appropriate French term, *étain en larmes*, 'tears of tin,' they are heated until they become brittle, and made to fall from a considerable height in a semi-fluid state, thus producing an agglomerated mass of elongated grains.

From a comparison of the results of the two methods of smelting above described, Dr. Ure shows that the reverberatory furnace with pit-coal occasions less loss of metal than the blast-furnace, and is by far the most economical. To produce a ton of metal by the former process requires, as before stated, a ton and three-quarters of pit-coal, while a ton and six-tenths of wood-charcoal is consumed in pro-

ducing the like quantity of metal by the blast-furnace; and as one ton of wood-charcoal is about equivalent, in calorific effect, to two tons of pit-coal, the difference in favour of the reverberatory plan is very great. The superior quality of the tin produced by the other process is attributable partly to the greater purity of the fuel, and partly to the finer quality of the ore selected for the purpose.

Manufacture of Tin-ware.—It is unnecessary here to enumerate the various purposes to which tin is applied in the useful arts, either as an ingredient in many useful alloys, for which its ready fusibility, its cleanliness, and its beautiful appearance render it especially valuable, or as the basis of chemical compounds used in dyeing, &c. It is rarely employed alone in our metalline manufactures, but when laid in a thin coat upon the surface of sheet-iron by the process of **TINNING**, it produces a material of such extensive use in the manufacture of culinary and other articles, that a more detailed notice may be given. Holland observes that in this country the greater portion of the tin used in the manufacture of articles composed exclusively of that metal is that which is expanded by rolling or hammering, or by a combination of the two operations into leaves or sheets barely one-thousandth part of an inch in thickness, under the name of *tin-foil*. This is the substance which is laid upon the back of glass mirrors, and there amalgamated with mercury, so as to form what is called the *silvering*.

The art of tin-plate working, or of forming sheets of tinned iron into an almost endless variety of useful vessels and utensils, depends more, observes the author just cited, on the manual dexterity of the workman than upon any peculiarity in the tools which he requires, which are few and simple, consisting of bench and hand-shears, mallets and hammers, steel heads and wooden blocks, soldering-iron and swages. In the formation of a vessel the first operation is to cut the plate to the proper size and form with shears; and when the dimensions of the article require it, to join them together, which is done either by simply laying the edge of one plate over that of the other, and then soldering them together, or by folding the edges together with laps, and then soldering them. Similar joints are required when gores or other pieces are to be inserted, and also at the junction by which a cylinder is closed in. The usual method of forming laps, bends, or folds for this or other purposes is to lay the plate over the edge of the bench, and to bend it by repeated strokes with a hammer; but as it is impossible by this means to make the bend as even, or at as true an angle as is desirable, Mr. J. Basset, of Birmingham, contrived a simple and effectual apparatus for the purpose, for which he was rewarded by the Society of Arts in 1831. An end view of this apparatus is given in the subjoined cut, in which *aa* represents a metal block screwed down firmly to a bench, and having a longitudinal cylindrical cavity, within which is laid a long iron cylinder, the end of which is distinguished in the cut by a tint. The

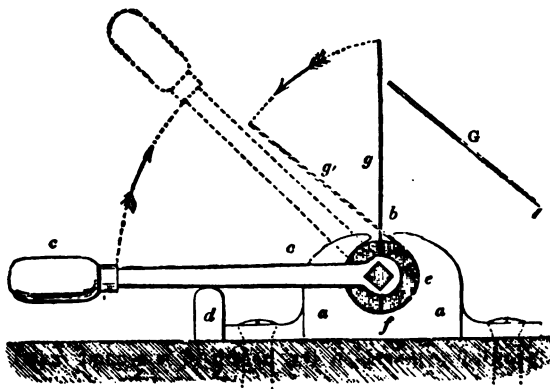

diameter of the cylinder is such that it will turn freely upon its axis within the cavity in which it lies, and which has a slit or opening about half an inch wide along the top of the cylinder at *b*. A squared axis projects from each end of the cylinder to receive a handle *cc*, which, when the instrument is at rest, lies in an horizontal position, and is supported by the block *d*. These handles are not fixed to the square axes of the cylinder, but are capable of being

taken off and put on again in any position of the cylinder, the length of which should be equal to that of the longest laps or bends. Longitudinal cuts, wide enough to receive the edge of a tin-plate, are made in the cylinder from the circumference towards the centre to any required depth or at any required angle, as at *b*, *c*, and *f*. In order to make a right-angled lap, such as is shown in the marginal figure G, the cylinder is turned into the position shown in the figure, with one of the radial cuts under the longitudinal opening in the block *aa*; the handles are put on, and the edge of the tin-plate *g* is inserted in the uppermost slit in the cylinder. The handles are then moved in the direction indicated by the arrow and dotted lines, and the plate is forced to assume the position of the dotted lines *g'*, receiving at the same time the required lap or bend. By returning the handles towards their original position, the plate may be easily removed. If, in addition to the making of the lap, the plate is to be bent so as to form a hollow cylinder or tube, the motion of the handles is continued until the cylinder is turned completely round, by which means the plate will be wrapped or rolled round it. The cavity in the block *aa* is made large enough to receive the cylinder with this addition to its thickness; and if this operation be intended, one side or cheek of the cavity is made moveable on a pivot, so that it may be opened for the purpose of lifting out the cylinder. The pipe is subsequently removed from the cylinder by detaching the handles and sliding it off longitudinally. Appended to the description of this apparatus, in the Society's 'Transactions,' is an account of a method of bending pipes of tin, copper, or brass, by filling them with hard solder, and passing them through two thick rings of the same substance, one of which is fixed in a vice or work-bench, while the other is attached to a handle of such length as to give the operator sufficient leverage for bending the pipe in that portion which intervenes between the rings. As the solder is softer than the material of the pipe, the rings will give way to any dangerous pressure sooner than the pipe itself. When the required curvature is obtained, the solder is melted from the inside of the pipe. It is observed that in performing this operation upon brass pipes, they should be previously tinned on the inner surface, in order to secure a perfect union between the tube and the core of solder.

After a tin vessel has been rounded upon a block or mandril, by striking it with a wooden mallet, and the seams finished as above described, all its exterior edges are strengthened by bending a thick iron wire into the proper form, applying it to what would otherwise be the raw edges of the metal, and dexterously folding them over it with a hammer. By this means the appearance of the articles is improved, and their durability and strength are greatly increased. A superior kind of tin-ware, commonly known as block-tin, is carefully finished by beating or planishing with a polished steel hammer upon a metal stake; by which means the surface, which otherwise appears somewhat wavy, is made very smooth and silvery, especially after it has been polished with dry whiting. It is principally in the production of block-tin wares that *swaging* is resorted to as a ready means of producing grooved or ridged borders or other embossed ornaments. This process consists in striking the metal between two steel dies or swages, the faces of which bear the desired pattern, and are made counterparts to each other. The mouldings round the edges of dish-covers and other similar articles are produced in this way; the swages embossing the pattern in short lengths, and the article being gradually turned round until every part of its circumference has been submitted to their action. It was formerly usual to make such mouldings separately for large articles, and to attach them with solder; and Holland states that the practice of swaging was introduced by Mr. King, a tinman in Holborn, who executed very bold and handsome mouldings by placing the outside of the article upon a concave bed of lead, having a hollow line or groove sunk into it, into which the rim of the cover or vessel was forced by the application of a huge hammer on the inner side, until the required degree of projection was obtained. The border was then completed by the application of swages, as before described. The lower die is usually fixed in an apparatus to which moveable guides are attached to insure the correct position of the article to be operated on, and the upper is made in the form of a hammer, the handle

of which is pivoted so as to insure its descent in precisely the right position. Sometimes the requisite power is applied by simply working the upper swage or swage-hammer itself; but in other cases the head of the swage-hammer is struck with a mallet. Very many ornamental articles are produced by embossing or stamping tin-plate, in the same manner as other metallic sheets, with a sypress or other machinery. Many cheap coffee-plates are manufactured at Birmingham in this way; and these and similar articles are sometimes lacquered, painted, or japanned. A very beautiful method of ornamenting tin wares by producing a crystallized appearance on the surface was much practised a few years since, under the name of *moiré métallique*, or crystallized tin-plate. It consists in applying diluted nitro-muriatic acid to the surface of the plate while slightly heated, and then washing with water, and covering with a lacquer varnish, without which the lustre of the crystalline appearance is speedily lost by the action of the air. Dr. Ure observes that 'it would seem that the acid merely lays bare the crystalline structure really present on every sheet, but masked by a film of redundant tin;' and he gives the following directions for performing the process:—The tin-plate, slightly heated, is to be placed over a tub of water, and to have its surface rubbed with a sponge dipped in a liquor composed of four parts of aquafortis and two of distilled water, holding one part of common salt or sal-ammoniac in solution. When the crystalline spangles appear to be thoroughly brought out, the plate should be immersed in water, washed with a feather or a little cotton (taking care not to rub so hard as to disturb the crystallized film of tin which constitutes the feathered surface), dried with a gentle heat, and immediately coated with lacquer. If the whole surface be not plunged at once in cold water, but partially cooled by sprinkling cold water upon it, the crystallization will be variegated with large and small figures. 'Similar results will be obtained,' he adds, 'by blowing cold air through a pipe on the tinned surface, while it is just passing from the fused to the solid state; or a variety of delineations may be traced by playing over the surface of the plate with the pointed flame of a blow-pipe.' (*Dict. of Arts*, p. 863 and pp. 1253, 1254.) By using coloured varnishes very beautiful boxes and other ornamental articles may be produced by this process.

Manufacture of Tin Alloys.—*Britannia Metal.*—Zinc forms the principal ingredient in various kinds of pew and other white metallic alloys, which are manufactured into domestic utensils by casting, stamping, and other processes in which much ingenuity is displayed. Holborn gives an interesting account of the manufacture of teapots and similar articles of Britannia metal, which may be briefly noticed here. This manufacture was commenced on a large scale at Sheffield, where it is still carried on, about the year 1770, by two individuals of the names of Jessop and Hancock; and the brilliancy, lightness, and cheapness of the wares, which, when well made, greatly resemble silver, have secured for them a very extensive sale in this and other countries. The extreme facility with which such alloys may be worked into any shape leads however to the manufacture of many articles of a flimsy character that they speedily lose their form and beauty. Various authorities differ greatly as to the composition of Britannia metal, but the proportions given by Holland are $3\frac{1}{2}$ cwts. of the best block-tin, 28 lbs. of antimonial regulus of antimony, 8 lbs. of copper, and 8 lbs. of brass. The tin is first melted and raised to a red heat in a stout cast-iron pot, and then the antimony, copper, and brass are successively poured into it from the crucibles which they have been melted; the mass being stirred during the operation, to complete the mixture. The heat being completed by the continued application of fire under the pot, the metal is removed by ladles to cast-iron basins or moulds, in which it is cast into slabs fifteen inches long, six inches wide, and one inch thick; or if for casting small articles, into smaller moulds to form it into convenient ingots. The thick slabs of metal are then extended by passing them between polished steel rollers until they are reduced to the required degree of tenacity. This operation is performed without any annealing or softening; and the edges of the sheet become a little altered or cracked by it.

Although most articles manufactured in silver are also produced in Britannia metal, and in other alloys of lead

character, the principal consumption is in candlesticks, tea-pots, coffee-biggins, and other vessels for containing liquids. The feet of candlesticks, the bodies of tea-pots, and other articles containing embossed work, are stamped between dies; and when the shape of the article will not allow it to be stamped in one piece, as in the case of a cylindrical vessel with raised work upon the sides, it is sometimes stamped in halves, which are subsequently fitted and soldered together. Articles approaching the globular form may in like manner be stamped in three or more pieces. In stamping brass, silver, and plated metal the dies must in almost every case be of steel, and the patterns upon them are executed at a very great expense, but in the manufacture of Britannia metal a cheaper process is followed. Plaster casts are produced of the required patterns, either from original models or designs, or from manufactured articles of silver, and from these are made moulds or dies of fine hard pig-iron, which, with a very little finishing, form dies fit for stamping so tractable a metal. When very thin, it may even be stamped in dies of brass or of spoon-metal.

The great facility with which this alloy may be moulded to any required form is illustrated by the operation termed *spinning*, by which the bodies of tea-pots with concentric circular swells are usually formed. A wooden chuck or model of so much of the intended vessel as may be slipped off the chuck when completed is fixed in a lathe worked by steam-power, and to this is applied a circular piece of sheet-metal cut to the proper size with shears. This is pressed against the centre of the chuck by a circular piece of wood with a blunt centre-pin; and as the whole revolves rapidly, the workman bends the plate over the model-chuck by pressing it with tools of hard wood or polished steel until it is brought into precisely the same form. The tools are applied at first very gently, so as to avoid crumpling or lacerating the metal; and such is the dexterity acquired by some workmen, that Holland states that some individuals can spin twenty dozen of these tea-pot bodies in a day. The form is perfected upon a second chuck; and in some cases articles are partially formed by a stroke in a die previous to the spinning. Spherical articles are, as in the case of stamping with dies, usually formed in two or more parts; but in some instances they are made to overlap the model, which is then composed of several segments, that may be taken out of the finished vessel by removing a centre-piece, in a similar manner to a boot-last.

Many small vessels, spoons, and other articles are cast in an alloy somewhat harder than that which is rolled into sheets. The facility with which Britannia metal may be run into any shape and cut in the lathe, as for turning measures and small vessels previously formed by casting, is a great recommendation to the manufacturer. Articles of this metal are cleaned from the oil, rosin, and other impurities acquired during their formation, by boiling in water containing sweet soap; after which they are polished, either by hand, or more commonly by the buff and brush set in motion by a steam-engine. The buff is a solid cylinder of wood, resembling a grindstone in form, the rim or periphery of which is covered with buff leather dressed with fine sand from the bed of the river Trent, which, after being dried and sifted, is mixed with oil. The brush is a similar but smaller circle of wood set all round with four or five rows of bristles; it, as well as the buff, is dressed with sand and oil, and afterwards for finishing with powdered rotten-stone and oil. The brush is used generally for such articles as from their form cannot be applied to the buff, and also for all stamped or embossed work. After buffing and brushing, the articles are boiled in a solution of pearlsh, and finally hand-brushed and hand-polished by an application of soft soap, a little oil, and powdered rotten-stone. This operation is usually performed by females, as it is found that no instrument can supply an effectual substitute for a soft hand, which is one of the first requisites inquired into when persons apply for work in this department.

(Ure's *Dictionary of Arts, &c.*; *Manufactures in Metal* (by Mr. Holland), in *Lardner's Cabinet Cyclopædia*, vol. iii.; *Transactions of the Society of Arts*, vol. xlviii., pp. 244-248.)

TIN TRADE. The history of the trade in tin commences with the very earliest records of commercial intercourse with the British islands. [CASSIETIDES; and *Pict.*

History of England, vol. i., pp. 91-95.] We shall only notice this trade as it has existed within the last two centuries. Davenant gives some interesting information concerning it soon after the middle of the seventeenth century. In 1663 our exports of tin to all foreign countries amounted to 153 tons; in 1669 to 240 tons; in the three years of peace, from 1698 to 1700, on an average to 1297 tons; and in the ten years of war, from 1700 to 1710, on an average to 1094 tons. In these last ten years the annual purchases of the Dutch amounted to 300 tons, of the estimated value of 21,374*l.* Davenant accounts for the great increase in the exportation as follows:—'All our neighbours,' says he, 'as well as ourselves, have increased in the luxurious way of living; such who heretofore were content with pewter are now served in plate; and such as made use of trenchers, wooden platters, and earthenware, will now have pewter; all which is visible within forty years, and has occasioned this great call of a commodity almost peculiar to us.' But the produce of the mines more than kept pace with the increased demand; and when Davenant wrote, Queen Anne had between 4000 and 5000 tons of tin on hand, a quantity equal to four or five years' consumption. 'As the case stands at present,' he adds, 'Holland is the great magazine for tin: the necessities of such as have it upon their hands, either in merchandize or security, drive it thither, and the Dutch set what price they please upon this rich product of England, to the damage of the public.' He proposed that a thousand tons of the dead stock should be coined into tin half-pence and farthings. The produce of the mines went on increasing, and the accumulation to which Davenant alludes is only about a year's produce of the mines at present.

In the 'Journal of the Statistical Society of London' (vol. ii., part iv.), there is a valuable paper, by Joseph Carne, Esq., on the 'Statistics of the Tin-Mines in Cornwall, and of the Consumption of Tin in Great Britain,' from which we borrow some of the following statements. From 1750 to 1785 the produce of the mines varied from 2273 tons, the lowest amount, to 3005 tons, which was the greatest quantity in any one year: the average production for this period was 2757 tons, and the average price 64*s.* 6*d.* per cwt. From 1789 to 1816 the annual average quantity was 2875 tons, at 79*s.* 9*d.* per cwt. From 1817 to 1837 inclusive, the annual average was 4211 tons, and the average price paid to the tinner was 73*s.* the cwt. In 1787 Banca tin was imported into this country for the first time, and the price of Cornish tin soon fell to 56*s.* the cwt., and would have declined still further if a new market had not been opened. It appears that the purser of an Indian, who took some tin from the Molucca islands to China in 1787, found the speculation so profitable that the East India Company were induced to direct their attention to the trade, and the Company shortly entered into arrangements with the Cornish tinner for an annual supply. The purchases of the Company were made at low prices, but the tinner were indemnified by the artificial scarcity which raised prices in the home market. At first the Company paid only 68*l.* 13*s.* 4*d.* the ton, delivered on board in London; in 1792 they gave 71*l.*; and on the renewal of the Company's charter they agreed to purchase 800 tons annually at 75*l.*, and offered to take half as much more at 68*l.* 13*s.* 4*d.* In 1809 the difference between the prices paid by the Company and the prices in the home market was so great that the tinner refused to supply the Company, and their exports ceased; but in 1811 they agreed to pay 78*l.*, and in 1812, 80*l.* per ton. The connection finally ceased in 1817, as the supply of the home market had become more profitable.

The gradual increase in the consumption of tin in Great Britain is shown in the following table:—

Periods.	Annual Average.
1783 to 1790	926 tons.
1791 to 1800	754
1800 to 1810	1118
1811 to 1820	1600
1821 to 1830	2616
1830 to 1837	3363

Until 1838 all the Cornish tin paid a duty of 4*s.* per 120 lbs. to the duchy of Cornwall, which, with the fees, was equivalent to 5*s.* This duty is now abolished. About 10,000 men, women, and children are supposed to be employed in the Cornish mines.

From 1783 to 1790 the proportion of British tin exported

was 7-10ths of the produce of the mines; in the next ten years it was 3-4ths; from 1800 to 1820 one half; from 1820 to 1830 it had diminished to 2-5ths; and from 1830 to 1837 to 1-5th. The quantity of foreign tin imported, the greater part of which is intended for re-exportation, since 1815, was as follows:—From 1815 to 1831 the annual average quantity imported was 213 tons; exported annually during the same period 224 tons. From 1831 to 1838 the imports of foreign tin averaged annually 1527 tons, and the exports were 1482 tons. This foreign tin can be supplied cheaper in Europe and America than the Cornish tin. In 1841 the imports were 28,434 cwt., or 1421 tons, of which 17,915 cwt. were from Singapore, 6197 cwt. from Java, and 5324 cwt. from the East India Company's territories. In the same year the exports of foreign tin were 25,344 cwt., or 1267 tons, principally to the United States, Holland, Russia, France, Italy, and Germany. The exports of British tin in 1841 were 1267 tons. France took 8905 cwt.; Turkey, 4061 cwt.; Russia, 2780 cwt.; the United States, 1753 cwt.; and Italy, 1329 cwt.; being more than three-fourths of the whole. In the Custom-House records the quantity of tin manufactures exported is not distinguished, but in 1840 the exports of 'tin and pewter wares and tin plate' were valued at 360,816*l*. Under the tariff of 1842 (5 & 6 Vict., c. 47), foreign tin-ore will be admissible for the first time, on paying a duty, which is 10*s*. the ton if from a British possession, and if of a foreign, 50*s*. But as none of the British possessions contain tin likely to be brought into the English market, the real duty is 50*s*. The former duty of 10*s*. the cwt. was prohibitory. The quantity of tin annually produced in Banca is estimated at 2700 tons, and in the Malayan peninsula about 1300 tons; and these are the parts from which a supply of ore, if any, is likely to be received.

TIN (Medical Properties of). It cannot be confidently asserted that tin in a metallic state has no influence over the human system, as many respectable writers affirm that tin-filings are decidedly anthelmintic, and that this is not owing to mechanical irritation of the worms causing them to be detached from the surface of the intestines; it is stated that water in which tin has been boiled, and wine digested in a tin vessel, are also anthelmintic. Others, denying to tin any inherent power over worms, have attributed these effects to the presence of a small portion of arsenic. Be this as it may, it is a very crude method of treating worms to exhibit such a material as tin-filings. [**ANTHELMINTICS.**] Even oxide of tin is of doubtful efficacy, as might be expected from its extreme insolubility. Its powers may be heightened by occasionally meeting with acids in the stomach, such as the hydrochloric, and therewith forming a chloride. Two compounds of chlorine with tin are known, one the protochloride, the other the bichloride. Both of these are exceedingly soluble; the latter so much so that it can with difficulty be kept in the solid state, and more frequently occurs in the liquid state, and is then called the spiritus fumans Libavii, or butter of tin. The former is much used by dyers, among whom, when in the solid state, it is called *salt of tin*, and when liquid, *spirit of tin*. In the former condition, it has sometimes been mistaken for common salt: it has thus been the source of poisoning, though it is not very active when introduced into the stomach. A few grains of it injected into the jugular vein prove rapidly fatal to dogs. In case of any of it being swallowed, emetics or the stomach-pump, demulcent drinks, and, if necessary, moderate venesection, may be employed, followed after a time by vital stimulants. It has been thought by some to be dangerous to allow fluids containing acids, such as the weak acid wines, or cyder, or even fatty, saline, or albuminous substances, to remain long in tin-vessels, as an injurious action of these on the tin is supposed to occur. If any serious effects have ever followed from such a cause, it is most likely that these vessels were only coated superficially with tin, which being rubbed off, exposed the more potent metal beneath to the solvent power of these substances. It is therefore prudent to examine from time to time all copper and other vessels to see that the tinning is entire.

TIN PLATE. [TINNING.]

TIN PYRITES. [TIN.]

TINACTOR, Prince Maximilian's name for one of the Ant-Thrushes (*Formicarinæ*, G. R. Gray). This genus is the *Oxypyga*, Menetr. (1834), and belongs to *Myiothera*, Cuv., and *Thamnophilus*, Vieill.

Example, *Tinactor fuscus*, Guer. *Mag. & Zool.* [**THRUSHES.**]

TINAMIDÆ. [TINAMOU.]

TINAMOTIS, Mr. Vigors's name for a genus of birds (*Eudromia*, D'Orb. and J. Geoffr.). [TINAMOU.]

TINAMOU (*Tinamus*, Lath., *Tetrao*, Linn., *Tinamylus*, Lacép., *Crypturus*, Ill., *Perzus*, Spix, &c.) is a group of birds placed by Cuvier, Mr. Vigors, and Mr. Swainson among the TETRAONIDÆ, in which article the utility to man will be found.

The Prince of Canino (*Birds of Europe and North America*) has a family *Crypturidæ*, noticed in the TETRAONIDÆ (vol. xxiv., p. 255), and, we presume, to place there the Tinamous.

Mr. G. R. Gray makes the *Tinamidæ*, the sixth order of the *Gallinæ*, according to his arrangement, consist of the following subfamilies and genera:—

Subfam. 1. *Turninæ*.

Genus:—*Turnix*, Bonn.

Subfam. 2. *Tinaminæ*.

Genera:—*Tinamus*, Lath.; *Nothura*, Wagl.; *Rischorchotus*, Spix; *Tinamotis*, Vig.

This family is placed by Mr. G. R. Gray next to the *Chronididæ*, and at the end of the *Gallinæ*, the next order to which is formed by the *Struthionidæ*.

We proceed to illustrate the present article by the Tinamous properly so called.

Generic Character of Tinamus.—Bill moderate, compressed, broader than high, tip obtuse, back broad. Nostrils lateral, medial, ovate, expanded, and open. Feet four-toed, cleft; hind toe very short. Tail moderate, short, concealed by the rump-feathers. Wings short. (Sw.)

Example, *Tinamus Tataupa*, Var.

Description.—Tinamou with the body above buff-rufous, immaculate. Head and neck dusky-black; throat, neck, and breast cinereous; body beneath whitish; vent and flanks rufous-black, the latter margined with white. Bill and irides red. Total length 9 inches. (Sw.)

Mr. Swainson, in his work on the 'Classification of Birds,' expresses his opinion that the Tinamous probably represent the group of Bustards in the New World (TETRAONIDÆ, vol. xxiv., p. 255); but in a previous volume (*Zoological Illustrations*, 1st series), he says that they there 'seem to hold the same scale in creation as the partridges do in the Old Continent.' He refers in the book last mentioned, to the work of M. Temminck (*Fig. Gall.*), who, he observes, has described twelve species, and he states that the bird under consideration is the smallest of its family. He found it only once in the interior of Bahia, where, he says, it must be very frequent in particular districts only. Though differing in some respects from M. Temminck's description, he declined to consider it only a variety.



Tinamus Tataupa, Var. (Sw.)

Mr. Darwin, in his graphic description of the ground around Maldonado, when he had reached the island

point which he was anxious to examine, says:—'The country wore the same aspect, till at last the fine green turf became more wearisome than a dusty turnpike-road. We everywhere saw great numbers of partridges (*Tinamus rufescens*). These birds do not go in coveys, nor do they conceal themselves like the English kind. It appears a very silly bird. A man on horseback, by riding round and round in a circle, or rather in a spire, so as to approach closer each time, may knock on the head as many as he pleases. The more common method is to catch them with a running noose or little lazo, made of the stem of an ostrich's feather, fastened to the end of a long stick. A boy on a quiet old horse will frequently thus catch thirty or forty in a day. The flesh of this bird, when cooked, is delicately white.' (*Journal of Researches in the Countries visited by H. M. S. Beagle.*)

TINCA, a genus of fishes founded by Cuvier, and which has for type the common tench, *Cyprinus tinca*, Linn.; *Tinca vulgaris*, Cuv. This fish belongs to the carp family (*Cyprinidae*), and is separated generically on account of the small size of the scales with which the body is covered, combined with the small antero-posterior extent of the dorsal and anal fins, both of which are destitute of the anterior bony spine or any such as are observable in some allied fishes—as in the dorsal fin of the barbel for instance; the barbules to the mouth are very small.

The tench, observes Mr. Yarrell, inhabits most of the lakes of the European continent. In this country, though frequent in ornamental water and ponds, it is but sparingly found in the generality of our rivers. There is some doubt whether, like the carp, its origin be not foreign, and whether those rivers that can now boast of it are not indebted for it to the accidental escape of fish from the preserved waters of neighbouring gentlemen. The rivers it is mostly in are those which are slow and deep, and in such situations it does not appear to be so prolific as in ponds. Cuvier observes that the tench inhabits by preference stagnant waters. This is in accordance with the observations of Mr. Yarrell, and, rivers being an unnatural habitat for the fish, will account for their being less prolific in such situations.

The author of the interesting work on British Fishes, just mentioned, quotes the following account illustrative of the habits of the tench and of its tenacity of life: it is from Daniel's 'Rural Sports':—'A piece of water which had been ordered to be filled up, and into which wood and rubbish had been thrown for years, was directed to be cleared out. Persons were accordingly employed; and, almost choked up by weeds and mud, so little water remained, that no person expected to see any fish, excepting a few eels, yet nearly two hundred brace of tench of all sizes, and as many perch, were found. After the pond was thought to be quite free, under some roots there seemed to be an animal which was conjectured to be an otter; the place was surrounded, and on opening an entrance among the roots, a tench was found of most singular form, having literally assumed the shape of the hole, in which he had of course for many years been confined. His length from eye to fork was thirty-three inches; his circumference, almost to the tail, was twenty-seven inches; his weight eleven pounds nine ounces and a quarter; the colour was also singular, his belly being that of a char, or vermilion. This extraordinary fish, after having been inspected by many gentlemen, was carefully put into a pond, and at the time the account was written, twelve months afterwards, was alive and well.'

Experiments have shown that a tench is able to breathe when the quantity of oxygen is reduced to a five-thousandth part of the bulk of the water: ordinary river water generally containing one per cent. of oxygen.

The general colour of the tench is greenish brown, or olive having a golden hue, which latter tint is most conspicuous on the under parts of the fish. From the carp it is readily distinguished by the small size of its scales, and also the small extent of the dorsal fin: its form is rather less deep in proportion to the length. It spawns usually about the middle of June, and deposits its ova on weeds.

TINCTURES are solutions of the active principles, mostly of vegetables, sometimes of saline medicines, and more rarely of animal matters, in certain solvents. From possessing more or less of colour, they have obtained this name. They are distinguished according to the kind of solvent employed. When alcohol is used, they are termed

alcoholic tinctures, or more generally simply *tinctures*; when sulphuric æther is used, they are denominated *ætherial tinctures*. When wine is used, though differing little from pure alcohol, the term *medicated wines* is applied to them; and when the process of distillation is employed to aid the extraction, particularly of volatile oils, the result is termed a *spirit*, such as of rosemary. Ammonia is sometimes conjoined, and the proceeds termed an *ammoniated tincture*. In some cases less of the principal ingredient is taken up or dissolved when ammonia is used, than when simple alcohol is employed, as in the *tinctura guaiacum ammoniatum*. Formerly some tinctures were called *essences*, from the term *esse*, it being thought that they contained only the purer or more refined portion, the alcohol leaving all the baser principles, such as the starch, gum, woody fibre, &c., undissolved: *quintessence* was a still higher degree of this. These terms are now disused by pharmacologists, though retained by the people. *Elixirs* differ only from being of a greater consistence: they are not unfrequently turbid from the extractive matter suspended in them. Tinctures are further distinguished into simple and compound. They are called *simple* when one substance only is submitted to the solvent; *compound*, when two or more are. Another important distinction among tinctures is founded upon the degree of strength of the alcohol employed. Where the active principle is nearly pure resin, a strong spirit is needed; when much gum is associated with the resin, a weaker is required. Hence some tinctures are prepared with *proof spirit*, as the greater number; a few with *spirit above proof*; and some with *rectified spirit*.

A well-prepared tincture should be clear, possessing the colour of the article which is its base, and partaking in an eminent degree of its characteristic odour and taste. As a general rule, five or six parts of the liquid chosen is to be used for one part of the solid material, which is to be bruised or comminuted before being submitted to maceration. The maceration, which should be conducted in well-stopped glass vessels, is generally continued for fourteen days, during which the ingredients are to be frequently shaken, and at the end strained. The pure tincture is then to be preserved in a tightly-stopped bottle, which should be opaque, or sheltered from the light. From several tinctures a deposit falls down, either from some slow chemical change taking place among the ingredients, or from the evaporation of some of the spirit. This renders old tinctures not unfrequently turbid, and of variable strength. Thus tincture of opium when newly prepared contains one grain of opium in nineteen minims, but after some time one grain of opium is contained in only fourteen minims. This inconvenience may be avoided with all recent vegetables, by forming what are termed 'vegetable juices.' These are merely the juices of the fresh plant expressed by a powerful wooden press, and the juice allowed to stand twenty-four hours, during which a copious precipitation of feculent matter takes place, which is further promoted by adding alcohol 56° over proof, in the proportion of four fluid ounces to every sixteen fluid ounces of the juice. After standing for twenty-four hours, the juice is to be filtered through bibulous paper (prepared from wool), when it will keep unimpaired for a length of time.

These vegetable juices always retain their purity, and are of the same degree of strength at last as at first. By this means not only is the process simplified, and the time required for their preparation greatly abridged, being reduced from fourteen days to two; but their medicinal efficacy is greater than that of the ordinary tinctures, and, from containing less alcohol, they can be given in cases where the stimulating action of this principle interferes with the effect of the substance dissolved in it, or renders its exhibition improper, as in the case of young children.

In preparing the official *spirits*, the directions of the Pharmacopœia are rarely complied with. Most chemists content themselves with dissolving some of the essential oil of the plant in alcohol of the requisite strength, by which much expense and trouble, as well as loss of time, are avoided.

(See a pamphlet on *The Best Method of Obtaining the Most Powerful Vegetable Preparations for Medical Use*, by Edward Bentley.)

TINDAL, MATTHEW, LL.D., was the son of the Rev. John Tindal, parish clergyman at Beer-Ferres in Devon-

shire, where Matthew was born about the year 1657. In 1672 he was admitted of Lincoln College, Oxford, where Dr. Hickee was his tutor; but he afterwards removed to Exeter College; and he was finally elected to a law fellowship at All Souls, soon after he had taken his degree of B.A., in 1676. He proceeded LL.B. in 1679, and was created LL.D. in 1685. If we may believe certain charges which were long afterwards made in print by the opponents of his theological opinions, his debaucheries while he resided at Oxford were so scandalous as to have drawn down upon him on one occasion a public reprimand from his college. Soon after he obtained his doctor's degree he went over to the Church of Rome, not without subjecting himself to the imputation of having an eye to the worldly advantages which such a step might seem to promise under the popish king just come to the throne. It does not appear however that he actually obtained any court favour or patronage by his change of religion; and, according to his own account, given in a pamphlet he published in his own defence in 1708, he reverted to the Church of England some months before the Revolution, having attended mass for the last time at Candlemas, 1698, and publicly received the sacrament in his college chapel at Easter following. He asserts that his mind, which came a *tabula rasa* to the university, had been prepared for being seduced by James's Romish emissaries by the notions as to the high and independent powers of the clergy which then prevailed there, and which he had adopted without examination. Accordingly, when he threw off popery, he abandoned his high-church principles at the same time; or rather, as he puts it, he discovered that these principles were unfounded, and that at once cured him of his popery. 'Meeting,' he says, 'upon his going into the world, with people who treated that notion of the independent power as it deserved, and finding the absurdities of popery to be much greater at hand than they appeared at a distance, he began to examine the whole matter with all the attention he was capable of; and then he quickly found, and was surprised at the discovery, that all his till then undoubted maxims were so far from having any solid foundation, that they were built on as great a contradiction as can be, that of two independent powers in the same society. Upon this he returned, as he had good reason, to the Church of England, which he found, by examining into her constitution, disclaimed all that independent power he had been bred up to the belief of.' The Revolution having taken place, he now also, naturally enough, became a zealous partizan of that settlement. The history of the rest of his life, during which he appears to have resided mostly in London, consists almost entirely of that of his successive publications and of the controversies in which they involved him.

He first appeared as an author in November, 1693, by the publication, in 4to., of 'An Essay concerning Obedience to the Supreme Powers, and the Duty of Subjects in all Revolutions, with some considerations concerning the present juncture of affairs.' This was followed in March, 1694, by 'An Essay concerning the Law of Nations and the Rights of Sovereigns,' a second edition of which, with additions, was brought out in the same year. This year also he published 'A Letter to the Clergy of both Universities,' in recommendation of certain alterations which there was then some talk of making in the Liturgy; and in 1695 another pamphlet in support of the same views. But the first work by which he attracted general attention was an 8vo. volume which he published in 1706, entitled 'The Rights of the Christian Church Asserted, against the Romish and all other priests who claim an independent power over it.' This work, which is an elaborate attack upon the theory of hierarchical supremacy, or what are commonly called high-church principles, immediately raised a vast commotion. It is related that to a friend who found him one day engaged upon it, pen in hand, he said that he was writing a book which would make the clergy mad. Replies to it were immediately published by the celebrated William Wotton, by Dr. Hickee (Tindal's old college tutor), and others; the controversy continued to rage for several years: a bookseller and his shopman were indicted for selling the book. In 1707 Tindal published 'A Defence' of his work, and, a few months after, 'A Second Defence,' both of which he republished together, with additions, in 1709: the same year he also reprinted his two Essays on Obedience and the Law of Nations, along

with 'A Discourse for the Liberty of the Press, and an Essay concerning the Rights of Mankind in matters of Religion:' about the same time he came forth with a second pamphlet, entitled 'New High Church turned Presbyterian,' in exposure of the pretensions put forward by Sacheverell and his party; upon which the House of Commons, which the day before had condemned Sacheverell's sermons to be burned, on the 25th of March, 1710, actually ordered Tindal's 'Rights of the Christian Church' and the second edition of his two 'Defences' to be committed to the flames at the same time. This proceeding drew from Tindal the same year three more pamphlets:—the first, entitled 'A High-Church Catechism; the second, 'The Jacobitism, Perjury, and Popery of the High-Church Priests'; the third, 'The Merciful Judgments of High Church triumphant, on Offending Clergymen and others, in the reign of Charles I.' The next year, on the Lower House of Convocation having drawn up and printed 'A Representation of the present state of Religion, with regard to the late excessive growth of Infidelity, Heresy, and Profaneness,' Tindal forthwith replied in 'The Nation Vindicated from the Aspersions cast on it' in the next representation. The second part of this performance is occupied with an explanation and defence of what has since been called the doctrine of philosophical necessity, in opposition to the assertion of the Convocation, that such views went to overturn the foundations of all morality, and of all religion, natural as well as revealed. For some years from this date Tindal's active pen was exclusively occupied with the politics of the day; but his performances do not appear to have been very effective at the time, and have been long forgotten. It is remarkable however that in so voluminous a work as Coxe's 'Memoirs of Sir Robert Walpole,' no notice should be taken of a personal controversy in which Tindal became involved with that minister after his resignation in 1717, and which produced various pamphlets on both sides. Tindal considered himself to have been ill-used by Walpole, who, according to his account, had first courted his alliance, and then suddenly dropped him after he had so far committed himself to a writing that it was imagined his hostility in print was not to be dreaded. Walpole, on the other hand, or his friends, accused Tindal of a treacherous desertion to the opposite faction as soon as he found that Walpole had been about to be deprived of power. It is probable that there was some misunderstanding on both sides. In any case this ministerial rupture was merely a personal quarrel, in which little or no public principle was involved; and it implies therefore no political versatility or inconstancy in Tindal that a few years after this, in 1721, 1722, and 1723, when Walpole was at the head of the ministry, he came forward as a strenuous defender of his government in a succession of pamphlets. He did not return to his original field of theological polemics till 1728, when he published 'An Address to the Inhabitants of the two great Cities of London and Westminster,' in reply to a pastoral letter which the bishop of London, Dr. Gibson, had addressed to the people of his diocese on the subject of Anthony Collins's 'Scheme of Literal Prophecy Considered,' and other recent deistical writings. A 'Second Pastoral Letter,' soon after published by the bishop, called forth a 'Second Address' from Tindal; and both addresses were reprinted the same year, in an 8vo. volume, with alterations and additions.

From this date Tindal seems to have remained quiet till the year 1730, when he produced, in a 4to. volume, the work by which he is now chiefly remembered, his 'Christianity as Old as the Creation, or the Gospel a Reprobation of the Religion of Nature.' The object of this work, as is indeed sufficiently declared in its title, is to contend that there is nothing more in Christianity, properly understood, than what the human reason is quite capable of discovering for itself, and by implication to deny that any special revelation has ever been made by the Deity to man. It did not however contain any express denial of the truth of Christianity; of which indeed the author and his partizans rather professed to think that he had found out a new defence stronger than any that had been previously thought of. 'Tindal,' said Warburton, some years after, 'a kind of bastard Socrates, had brought our speculations from heaven to earth; and, under pretence of advancing the antiquity of Christianity, laboured to undermine its original.' The book made a great noise, and

various answers to it soon appeared, the most noted of which were—Dr. Waterland's 'Scripture Vindicated,' 1730; 'The Usefulness, Truth, and Excellency of the Christian Revelation defended,' by Mr. (afterwards Dr.) James Foster (the eminent dissenting clergyman), 1731; 'A Defence of Revealed Religion,' by Dr. Conybeare (afterwards bishop of Bristol), 1732; and 'An Answer to Christianity as Old as the Creation,' by the Rev. John (afterwards Dr.) Leland (another learned and distinguished dissenting divine), 1733. The book is also discussed in the last-mentioned writer's more celebrated work, his 'View of the Principal Deistical Writers,' published in 1754. Tindal defended himself in 'Remarks on Scripture Vindicated, and some other late Writings,' published along with a new edition of his 'Second Address to the Inhabitants of London and Westminster,' in 1730. But this was his last publication; his health now began to give way, and he expired on the 16th of August, 1733, at a lodging in Cold Bath Fields, to which he had been prevailed upon to remove a few days before from his chambers in Gray's Inn. Tindal never held any preferment except his fellowship; but it is stated, in the 'Biographia Britannica,' that in the reign of King William he frequently sat as judge in the Court of Delegates, and had a pension of 200*l.* a year granted to him by the crown for his services in that capacity. It is added that he 'rarely, if ever, practised as an advocate in the courts of civil or ecclesiastical law; which would seem to imply that he had been called to the bar, or been admitted an advocate at Doctors' Commons, although that fact is not mentioned. A new edition of his 'Essay on the Law of Nations' was published the year after his death; but the publication of a second part of his 'Christianity as Old as the Creation,' which he left ready for the press, is said to have been prevented by the interference of Bishop Gibson. A will, in which he left nearly all he had to Eustace Budgell, in whose hands he was for some time before his decease, was contested by his nephew, the Rev. Nicholas Tindal, and was at last set aside: the will was printed in a pamphlet, with a detail of circumstances connected with it, in 1733.

Of the amount of talent and learning shown in Tindal's writings very different estimates have been formed by his admirers and his opponents. Waterland, in the Introduction to his 'Scripture Vindicated,' characterises his antagonist in the following terms:—'His attacks are feeble, his artillery contemptible; he has no genius or taste for literature, no acquaintance with the original languages, nor so much as with common critics or commentators; several of his objections are pure English objections, such as affect only our translation: the rest are of the lowest and most trifling sort.' Dr. Conyers Middleton, on the other hand, in a letter which he addressed to Waterland immediately after the latter had published his book, says, 'For my own part, to observe our English proverb, and give the devil his due, I cannot discover any such want of literature as you object to him; but, on the contrary, see plainly that his work has been the result of much study and reading; his materials collected from a great variety of the best writers; his pages decently crowded with citations; and his index of authors as numerous as that of most books which have lately appeared.' Tindal's English style is unaffected and perspicuous.

TINDAL, REV. NICHOLAS, was the son of a brother of Dr. Matthew Tindal, and was born in 1687. Having died at Exeter College, Oxford, and taken his degree of M.A. in 1713, he was afterwards elected a Fellow of Trinity College in that university. In 1722 he was presented by his college to the vicarage of Great Waltham in Essex; in 1738 Sir Charles Wager, then first lord of the admiralty, with whom he appears to have some years before sailed for a short time as chaplain, appointed him chaplain to Greenwich Hospital; in 1740 he is said to have been presented to the rectory of Colbourne in the Isle of Wight, upon which he resigned Great Waltham; and very soon after he appears to have obtained his last preferment, the rectory of Alverstoke in Hampshire, from the bishop of Winchester (Hoadley). He died at Greenwich Hospital on the 27th of June, 1774.

Mr. Tindal's first literary attempt was a work published in monthly numbers in 1724, under the title of 'Antiquities, Sacred and Profane, being a Dissertation on the excellency of the History of the Hebrews, &c.,' which is described as a translation from the French of Calmet. This was fol-

lowed by two numbers of a History of Essex, which was then dropped. He then engaged in his most memorable undertaking, the translation, from the French, of Rapin's 'History of England,' which appeared in a succession of octavo volumes in 1726 and following years, and was reprinted in two volumes folio in 1732. This second edition was dedicated to Frederick, prince of Wales, who in return presented the translator with a gold medal of the value of forty guineas. In 1744 a Continuation of Rapin, by Tindal, began to be published in weekly folio numbers, which was completed in two volumes (commonly bound in three), in 1747, the history being brought down to the end of the reign of George I. A second folio edition of this Continuation appeared in 1751, and a third, in 21 vols. 8vo., in 1757, with the addition of the reign of George II. down to that date. The translation and continuation of Rapin were very successful speculations; and the publishers, the Messrs. Knapton, of Ludgate Street, evinced their gratitude by making Tindal a present of 200*l.* It is generally stated that he was assisted in both undertakings by Mr. Phillip Morant, to whom solely is attributed the Abridgment or Summary of the History and Continuation given at the end of the latter, and also printed in 3 vols. 8vo. in 1747; but it does not appear upon what authority it is asserted by Coxe, in the Preface to his 'Memoirs of Sir Robert Walpole,' that the Continuation, though published under the name of Tindal, 'was principally written by Dr. Birch.' There is no hint of this in the very full and elaborate Life of Birch, in the second edition of the 'Biographia Britannica,' which is stated to be compiled from his own papers and the communications of surviving relations and friends. 'His papers,' Coxe proceeds, 'in the Museum and in the Hardwicke Collection, which I have examined with scrupulous attention, and various other documents which were submitted to his inspection, and to which I have had access, prove great accuracy of research, judgment in selection, and fidelity in narration. He derived considerable assistance from persons of political eminence, particularly the late Lord Walpole, the late earl of Hardwicke, and the Honourable Charles Yorke. The account of the Partition Treaty was written by the late earl of Hardwicke. The account of Lord Somers's argument in Barker's case was written by his great-nephew the late Mr. C. Yorke. I can also trace numerous communications by Horace Walpole, though they cannot be so easily specified. Birch was a staunch Whig, but his political opinions have never led him to forget his duty as an historian. He has not garbled or falsified debates, or misstated facts; he has not wantonly traduced characters, or acrimoniously reviled individuals because they espoused the cause which he disapproved; but in his whole work, whether he praises or blames, there is a manly integrity and candid temperance, which must recommend him to the discerning reader.' This is a sufficiently just character of the Continuation of Rapin: but, although in some parts the work has a claim to be considered as an original authority, it is in the greater part not only a compilation, but a mere transcription from preceding writers. The authors indeed frankly state in their prefatory notice that they have not scrupled to copy or imitate any part of the several authors they have made use of, when conducive to the usefulness of the work, or where there was no occasion to alter or abridge. The numerous documents inserted at full length make the Continuation a convenient repertory of authentic information; and the notes which accompany the translation of the preceding part of the work add greatly to the value of the original text. Tindal's other publications were—the pamphlet relating to his uncle's will, an abridgment of Spence's 'Polymetis,' under the title of 'A Guide to Classical Learning for Schools,' and a translation, from the Latin, of Prince Cantemir's 'History of the Growth and Decay of the Othman Empire,' which appeared in a folio volume in 1734.

TINIAN is one of the Ladrone or Mariane Islands [vol. xiii., p. 269]: it lies near 15° N. lat. and 140° E. long. It is uninhabited and of small extent. It owes its name in the world not to its real importance, but to the circumstance that Lord Anson, just one hundred years ago, remained there nearly two months, from 26th of August to the 21st of October, 1742, and that in the account of his voyage a description of the island is given in glowing colours. It extends about 12 miles from south-south-west

to north-north-east, and the breadth is about half as much. The soil is somewhat sandy, but very dry and healthy. The land rises in gentle slopes from the beach to the middle of the island, but the ascent is often interrupted by small level valleys, many of which wind irregularly through the country. These valleys and the gradual swellings of the ground are most beautifully diversified by an alternation of woods and lawns, which traverse the island. The woods consist of tall and well-spread trees, mostly without under-wood, and the lawns are covered with a clean turf composed of very fine trefoil and intermixed with a variety of flowers. There are no running streams, but good water is found by digging a few feet below the surface, and near the middle of the island there are three small lakes. Black cattle, in a wild state, are numerous, and at the time of Anson's visit the number was computed to amount to at least ten thousand. Our common domestic fowl is plentiful in the woods, and several kinds of wild fowl are found in the lakes. There is also an abundance of wild hogs. Besides the cocoa-nut palm and the bread-fruit tree there are guavas, limes, and sweet and sour oranges, and antiscorbutic plants in great abundance, by the use of which the crew of the Centurion, the vessel commanded by Lord Anson, which suffered much by the scurvy, was restored to health in a short time. There is no harbour, but only an open roadstead near the south-western extremity of the island, which is dangerous during the prevalence of the western monsoon, from June to October, but tolerably safe during the remainder of the year.

(Anson's *Voyage round the World*; Kotzebue's *Voyage of Discovery into the South Sea, &c.*)

TINNEVELLY. [HINDUSTAN, p. 203.]

TINNING, TIN-PLATE MANUFACTURE. The art of tinning, or of coating other metals with a thin layer of tin, so as to protect them from oxidation, was known to the ancients, although it does not appear to have been very extensively practised. Professor Beckmann, in his investigation into the early history of tin and tinning (*History of Inventions*, English edit. of 1814, vol. iv., pp. 1-45), states that we have no account of the process antiently employed in tinning, although the use of the words *incoquere* and *incoctilia* by Pliny seems to indicate that it was performed by immersing the vessels in melted tin. The degree of perfection to which the process was carried is indicated by his statement, accompanied by an expression of wonder, to the effect that the tinning did not increase the weight of the vessels, which shows that the tin must have been applied, as at present, in a very thin layer.

The art of tinning plate-iron is more modern than that of coating copper vessels with tin, and is supposed to have been invented either in Bohemia or in Germany. Mr. Parkes, in a paper on the manufacture of tin-plate, or tinned sheet-iron, addressed to the Literary and Philosophical Society of Manchester, in 1818, which was published in their *Memoirs* (Second series, vol. iii., pp. 347-380), states that our ancestors, from time immemorial, procured that article from Bohemia and Saxony, where the manufacture was established near the tin-mines of the Erzgebirge mountains, which were the most extensive in Europe after those of Cornwall. From the time of the invention of tin-plate down to the close of the seventeenth century, if not later, both England and the whole continent of Europe depended upon the above-named countries for their supply of tin-plate; but about the year 1665 an attempt was made to introduce the manufacture into England, by some gentlemen who sent the ingenious Andrew Yarranton into Saxony to obtain information respecting it. Yarranton's account of the experiment, which is quoted at length by Parkes, was published in 1681, in the second part of his curious work entitled *'England's Improvement by Sea and Land,'* now very rare. He was allowed freely to inspect the tinning establishments, and he became so well acquainted with the process, that after his return to England he made many thousand plates of iron, from the Forest of Dean, tinned with Cornish tin, the quality of which was admitted to be even superior to that of the German tin-plates, which they surpassed in toughness and flexibility. Before however the new manufacture could be fairly established, its promoters were stopped by a patent, which Yarranton says was 'trumped up' for the purpose by parties possessing court influence. The patentees did not understand the art sufficiently to enable

them to succeed, and thus England remained dependent for some years upon the Continent for a manufacture in which she possessed the greatest facilities. Parkes states that he does not find that any manufacture of tin-plate was established in this country until between 1720 and 1730, and that the first was at Pontypool, in Monmouthshire, where, according to Watson's *'Chemical Essays'* it was practised as early as 1730. Shortly before that time the art was introduced into France by M. Réaumur, who communicated an account of the process, as practised by the Germans, to the French Academy of Sciences in the year 1725, in a paper which was translated by Ruty and published in the 35th volume of the *'Philosophical Transactions'* (No. 406, published in December, 1725). In his introductory remarks Ruty states that the making of tin-plates, or, as they were sometimes called, *latten* or *latun*, was not commonly practised in England, notwithstanding the great consumption; and that we were obliged to export our own tin to Germany, and to receive it back again when manufactured. Anderson (*Hist. of Commerce*, vol. iii., p. 226) states that about 1740 the manufacture of tin-plate was brought to such perfection in England that very little was imported from foreign countries, and that the British manufacture was superior to the foreign in toughness of surface, owing to the plates being drawn under a rolling-mill, instead of being hammered, as was common in those made beyond sea. The difficulty of extending iron, in what may be deemed the infancy of the manufacture, into thin uniform sheets, with a perfectly smooth and clean surface, which is essential to the adhesion of the tin in an equal film, was one of the principal obstacles to the progress of this department of the art of tinning.

The process of tinning depends upon the strong affinity which exists between tin and the metals to which it is applied, and it consists, essentially, in rendering the surface to be tinned perfectly clean and free from oxide, and then bringing it into contact with melted tin, which forms an alloy with the harder metal, imparts to it a bright silvery appearance, and protects it from oxidation. The tinning of sheet-iron, as the most important application of the process, will be first noticed. This operation is exactly described by Mr. Parkes, in the paper above cited, and which, with occasional reference to more recent accounts, the following description is condensed. Réaumur's account of the German process, in the *'Philosophical Transactions'* may also be consulted by those who are curious as to the details of the earlier method of tinning, which resembles that about to be described in all essential points.

The finest English or Welsh bar-iron, prepared with charcoal, instead of mineral coke, and known to the trade as *tin-iron*, is used for making tin-plates. This material is first made into flat bars, or slabs, about thirty inches long, six inches wide, and weighing eighty pounds. These bars are made red-hot, and extended by passing them repeatedly between rollers, until they are reduced to about three-eighths of an inch in thickness. When cooled, these pieces are cut by shears, worked by machinery, into plates about ten inches by six, which are repeatedly re-heated and rolled, until they are reduced to as thin a state as the process will conveniently allow. The sheet is then doubled and again rolled until reduced in thickness one-half, after which it is doubled again, and rolled until still further diminished in thickness. When thus brought to the required tenuity, the thin sheet is cut into plates of the size required to suit the market (most commonly about thirteen inches by ten), and then the several thicknesses or *latten* are separated.—an operation which needs the application of considerable force, as the compression of the rolls causes them to adhere strongly together. Parkes states that the cutting of the plates was, when he wrote, usually performed with hand-shears, but that an ingenious Welsh smith in Glamorganshire had invented a machine for the purpose, which was impelled by a water-wheel, and would cut a quantity equal to a hundred boxes (of two hundred and twenty-five plates each) in a day, which is four times as much as a hand-shearer could accomplish. After shearing, the plates are piled in heaps, one being laid cross-wise at intervals, to separate the number required to form a box. That name is technically applied to the number of plates just mentioned in all the subsequent processes, although it is not until they are completed that the plates are actually placed in boxes.

The next operation to be performed is the removal of every particle of oxide or other impurity from the surface of the plates. For this purpose each is bent to an angle of about 60°, so as to bring it into the form of an inverted Λ or Ω , and then steeped for a few minutes in a leaden trough containing a weak solution of muriatic acid. Four pounds of acid to three gallons of water makes a mixture of the proper strength, and sufficient for eighteen hundred plates. After being immersed for four or five minutes in this cleansing liquid, the plates are taken out, arranged on the floor in rows, and then removed, by means of an iron rod, to a reverberatory furnace or oven, in which they are submitted to a red heat. The reason for bending the plates now becomes obvious, because if they were flat, the two sides could not be equally exposed to the flame by which the furnace is heated; whereas by bending them, and placing them upon their edges, the flame is allowed to play upon both sides. The heat to which the plates are exposed, combined with their previous washing in the acid, causes them to throw off a scale of rust or oxide, whence this operation is termed *scaling*. If well performed, it gives to the iron a mottled blue and white surface, somewhat resembling marbled paper. The plates are then flattened by beating them upon a cast-iron block, and submitted to a second or *cold* rolling, which removes any warping acquired in the previous processes, gives a high degree of smoothness to their surfaces, and imparts elasticity to the iron. The rollers, or *rolls*, employed in this operation are formed of cast-iron, rendered very hard by passing in thick cold iron boxes or moulds, and their surfaces are carefully polished. Parkes states that rollers of about thirty inches diameter are much better than those of smaller dimensions for this purpose: the length of the rolls is usually seventeen or eighteen inches. After the *cold rolling* the plates are immersed singly, in a vertical position, in an acidulous preparation called the *lyes*, consisting of water in which bran has been steeped for nine or ten days, until it has fermented and become slightly acid. In this the plates are kept for ten or twelve hours, and occasionally turned, to insure an equal exposure of every part of their surface; and from the lye-trough they are transferred to a leaden vessel containing diluted sulphuric acid, the strength of which is varied according to the judgment of the workman. This trough is divided into compartments, which will contain a box of plates each; and both it and the lye-trough are slightly heated by flues, to assist the action of the acid menstrua. Parkes states that a temperature of 90° or 100° Fahrenheit is sufficient for this operation, which is called *pickling*, and which requires some nicety, to prevent the plates from being strained or blistered by remaining too long in the acid. They are usually agitated in the weak sulphuric acid for about an hour, until they become bright and free from black spots. They are then removed into pure water, in which they are scoured with hemp and sand, to remove any remaining oxide; and in this bath of pure water the plates remain until wanted for tinning, because, even if left for months, they will remain perfectly free from rust.

As the sole object of these operations is to cleanse the iron plates from rust and dirt, it is evident that the details may be varied considerably; but it is not necessary to notice particularly any deviations from the usual process. The *tinning* of the plates is effected in a range of cast-iron pots heated by flues, and forming together an apparatus called the *stow*. The plates are removed one by one from the last-mentioned bath of pure water, and dried by rubbing with bran, after which they are immersed singly in a pot filled with melted tallow or grease, in which they are left for about an hour. The grease preserves the surface from oxidation, and appears also to increase the affinity of the iron for tin; and for this purpose burnt grease, or any kind of empyreumatic fat, is found preferable to pure fresh tallow. From the grease-pot the plates are removed, with the grease which adheres to their surfaces, into the metallic bath, which contains a mixture of block and grain tin, covered with a quantity of grease sufficient to form a layer four inches deep. Parkes states that the mixture of block and grain tin usually contains about equal quantities of each; but he conceived that manufacturers would find it advantageous to use grain-tin alone; since, although it would be rather more expensive, its greater purity and fluidity would occasion it to adhere to the iron in a thinner film. The tin-bath or pot is heated

P. C., No. 1548.

to such a degree as almost to inflame the fatty mixture upon the surface of the tin; and its dimensions are such that it will receive two or three hundred plates standing upright on their edges. The precise size is immaterial, so that the number of plates put in is such as to prevent any from falling down; but it is convenient to make it large enough to hold a box and a half of plates, or about three hundred and forty. When the plates have remained in the tin-bath a sufficient time (usually about an hour and a half, but more for thick plates), they are lifted out with tongs, and placed upon an iron grating, to allow the superfluous tin to drain off; but as there still remains upon them much more than the proper quantity of tin, they are afterwards subjected to a process called *washing*, which consists in dipping them into a pot containing a quantity of pure grain-tin in a melted state, then rubbing them with a peculiar kind of brush made of hemp, plunging them again for a moment into the melted tin in the wash-pot, and then into a pot filled with clean melted tallow, or lard free from salt, which contains pins, to prevent the plates from touching each other. The heat of this second tin-bath melts and detaches the superfluous and coarser portions of the tin from the plates, and the drossy impurities rise to the surface; while the other portions unite with the grain-tin, and so deteriorate its quality, that, after washing sixty or seventy boxes, it becomes necessary to remove about three cwt. of tin from the wash-pot, and to supply its place by a block of pure grain-tin. The impure tin thus removed from the wash-pot is put into the bath in which the plates receive their first tinning. As it is desirable, in the final dipping of the plate, to preserve it from contact with the dross or scum which collects upon the surface of the bath, a partition is inserted in the wash-pot, to keep one compartment free of scum. The last dip serves to eradicate the marks of the brush, and to replenish the coat of tin wherever it may have been rubbed too thin; and the subsequent immersion of the plates in the grease-pot causes any superfluous metal to run off. The heat of the tallow-bath, and the period of immersion in it, must be regulated with care. Thick plates require the tallow to be cooler than for thin ones, because they retain more heat in themselves; and if a thick plate were placed in a bath of proper temperature for thin plates, it would come out of a yellow instead of a silvery-white colour; while, on the contrary, a bath intended for thick plates would be too cool to effect the required purpose upon thin sheets. Too short a period of immersion has a similar effect, and leaves too much tin upon the surface, and that in a wavy irregular film; while if left too long in the grease-pot, the tin would run off to such a degree as to render another dipping necessary. So soon as the workman employed in washing has placed five plates in the grease-pot, a boy lifts the first from it into a draining-pan with a grated bottom; and when the man has placed the sixth in the tallow, the boy removes the second. Notwithstanding the apparently complicated character of the operations just described, they are performed so rapidly, that an expert wash-man will wash and brush twenty-five boxes, or five thousand six hundred and twenty-five plates, in twelve hours.

Owing to the vertical position of the plates during the preceding operations, a selvage of tin accumulates along their lower edge, which is removed by the process called *listing*. This is performed by taking the plates one by one, as soon as they are cool enough to handle, and dipping their lower edges into a pot called the *list-pot*, or *listing-pot*, which contains enough melted tin to form a layer a quarter of an inch thick. The selvage of tin being thus melted, is shaken off by a smart blow with a stick, leaving only a faint stripe, which may be discerned upon all finished tin-plates. After listing, the plates are cleaned from grease by rubbing them, while yet warm, with dry bran; after which they are packed in boxes of wood or sheet-iron.

The tinning of the inner surfaces of cooking utensils and other vessels of capacity is performed by scouring the surface until it is perfectly bright and clean; then heating the vessel, pouring in some melted tin and rolling it about, and rubbing the tin all over the surface with a piece of cloth or a handful of tow: powdered rosin is used, as in soldering, to prevent the formation of oxide, which would impair the mutual affinity of the metals. Pure grain-tin should be used for this purpose, but it is frequently adulterated with lead. By this means vessels

of copper, brass, and cast-iron are tinned internally, and thereby rendered fit for the most delicate culinary operations; and in a similar way any small portions of iron-plate may be coated with tin. Bridle-bits, stirrups, and many other small articles, are tinned by immersing them in fluid tin. Mr. Gill, in the eleventh volume of the 'Technical Repository,' p. 230, describes an ingenious method of tinning nails or tacks and other small wares, which consists in cleaning the surface by pickling the articles in diluted sulphuric, muriatic, or nitric acid, washing them afterwards in water, and then putting them into a gallon bottle of stone-ware, with an oval body and a narrow neck, together with a quantity of bar or grain tin, and of sal-ammoniac. This vessel is then to be closed, and laid on its side over a charcoal fire, made upon a forge-hearth, and by turning it round, and frequently shaking it, the tin is to be uniformly distributed over the surfaces of the inclosed articles. When tinned they are taken out, washed in water to remove the sal-ammoniac, and dried in warm sawdust. The great advantage of the process consists in the employment of the stone-ware bottle, which prevents the dissipation of the fumes of the sal-ammoniac, and gives up the whole of the tin, which no metallic vessel would do. The method of tinning pins is described under PIN, vol. xviii., p. 161.

(Memoirs of the Literary and Philosophical Society of Manchester, second series, vol. iii., pp. 347-80; Philosophical Transactions, December, 1728; Manufactures in Metal (in Lardner's 'Cabinet Cyclopædia,' vol. iii.); Ure's Dictionary of Arts, &c.)

TINNITUS AU'RIMUM, ringing in the ears, may arise from many different conditions. It is sometimes due to an unnatural state of the circulation in some part of the ear, the movement of the blood producing a vibration of the nerve which the mind does not distinguish from that produced by sonorous vibrations of the air. But most frequently the sensation is due to some disordered state of the auditory nerve, and is entirely subjective. It is thus perceived in some diseases of the brain, in nervous persons, and in those who are much debilitated; and is a common sign of organic disease of the auditory nerve itself. It is analogous, in these cases, to the subjective sensation of sparks and flashes of light which is perceived in cases of disease of the retina or optic nerve. It may therefore be a sign of a dangerous condition, or a prelude to complete deafness; but in the great majority of cases it is unimportant, depending on some local temporary affection of the ear, or on some disturbance of the digestive organs with which part of the brain sympathizes.

TINNUNCULUS, Vieillot's name, after the antients, for a genus of *Falconidae*. Type, *Tinnunculus alaudarius*, Briss.; *Falco Tinnunculus*, Linn., of which we proceed to give M. Temminck's

Description.—Wings reaching to three-fourths of the length of the tail; upper plumage of the male varied with numerous black spots; quills striped internally; claws always black.

M. Temminck states that this short indication is inserted to enable the observer to distinguish at the first glance this species from the *Falco tinnunculoides* (*Cresserelle*, or *Lesser Kestrel*), and he then proceeds to give the following details relating to the former:—

Male.—Top of the head bluish-grey; upper parts reddish-brown, regularly sprinkled with angular black spots; lower parts white, slightly tinged with reddish and with oblong brown spots; tail ash-coloured, with a wide black band towards its extremity, and terminated with white; bill bluish; cere, space around the eyes, iris, and feet yellow. Length about 14 inches.

Female, larger than the male; all the upper parts of a brighter reddish; lower parts yellowish rusty, with oblong black spots; tail reddish, with nine or ten narrow black bands, and with a large band of that colour near its extremity, which is terminated with reddish-white.

Varieties.—With the upper parts of a reddish hue spotted with black; the top of the head more or less clouded with bright blue; the plumage variegated with white; sometimes entirely white.

The *Young* have the top of the head, the nape, and the mantle brown-rusty streaked with black; these streaks form the angle of the back; on the first quills are seven reddish and whitish spots; tail reddish, undulated with grey-ash and transversely striped as in the female; throat

reddish-white; at the opening of the bill a small black stripe which is prolonged on the upper part of the cere; the rest of the lower parts whitish-rusty with oblong black spots; iris brown; cere yellowish-green.

This is, there can be little or no doubt, the *Lynx* (*Cenchrus*) of Aristotle (*Hist. Anim.*, ii. 17; vi. 1; vii. 3), and so most zoologists are disposed to consider it, as well as that it is the *Tinnunculus* of the antient Latins (Pliny, *Nat. Hist.*, x. 37.) It is the *Foustevent*, *Cambius*, *Tristunculo*, *Acertello*, *Falchetto di Torre*, *Gheppo*, and *Gavinello* of the modern Italians; *Cerrelle*, *Quercelle*, *Cresserelle*, and *Epervier des Alouettes* of the French; *Turnfalke*, *Roethel-geyer*, *Mausfalke*, *Windweh*, *Büchweyer*, and *Wannen-weher* of the Germans; *Ärke-falk* of the Swedes; *Kestrel*, *Stannel*, *Stonegall*, and *Windweh* of the modern British; and *Cudyll côch* of the antient British.

Geographical Distribution.—Europe generally, but not habitually beyond the regions of the arctic circle, where its place is occupied by the MERLIN. England, Scotland, and Ireland. Smyrna, in winter at least. Africa, from the north to the south, according to Temminck. Senegal, according to the same authority. The Zoological Society have received it from the Cape of Good Hope, Asia, India (Selby); banks of the Ganges YARROW (Horsf.); Japan (Siebold and Bürger). Mr. Yarrow says that figures of it occur in drawings from China.



Kestrel, male and female. (Gould.)

Habits, Food, &c.—The provincial name 'Windrow' well expresses the most striking characteristic of the hawk. With its head to windward, whence Mr. Mode suggests that one of its designations should be written 'Standgale,' not 'Stonegall,' it remains with outspread tail and winnowing wings suspended high in air, so that its piercing eye may include a considerable area, in which no field-mouse is safe: when the bird sees one, it drops unerringly on the surprised prey. When thus poised above the fields, it sometimes is within the range of a gun, and we have heard farmers exult in bringing one down, but thinking that the bird was then on the watch for one of their greatest enemies. Mr. Waterton has pleaded the cause of the Kestrel well, and shown how greatly it is the friend of the agriculturist. But though mice are its staple, it undoubtedly preys upon small birds, and also on bees and their larvae and earthworms. Mr. Selby saw a hawkling after cockchafers (*Melolontha vulgaris*) late in the evening. He watched one with a glass, and saw the

bird dart through a swarm of those insects, seize one in each claw, and eat them on the wing. The kestrel returned to the charge again and again, and Mr. Selby ascertained the fact beyond doubt, for he afterwards shot the bird.

If a kestrel can find the nest of a crow or a magpie as a receptacle for its eggs, it will not take the trouble to make one; indeed, it probably never does build: sometimes it lays upon the bare ledges of rocks and in old ruined towers. The number of eggs is four or five, and their ground-colour reddish-white, which is mottled closely with dark reddish-brown and sometimes blotched with reddish-brown. The young come forth from the egg towards the end of April or beginning of May, and are covered with a yellowish-white down.

In the *Portraits d'Oyseaux*, the following quatrain sums up the qualities of the Kestrel:—

' Mulots, Lezars, Rats, et autre vermine
Sont la viande à nostre Cre-serelle.
Elle est amve avec la Colombelle,
Qu'elle deffend des oyseaux de rapine.'

The allusion here made to the friendship of the Kestrel for the Dove is probably taken from the passage in Pliny to which we have above called attention.

N.B. M. Brehm would make three distinct species from this hawk, under the names of, 1st, *Hochköpfiger* (high-headed); 2nd, *Mittlerer* (middle); and 3rd, *Platthöpfiger* (flat-headed). Upon this M. Temminck drily observes, that those who wish to multiply the catalogue of names and of species in favour of each accidental or local variety, may consult the work of M. Brehm. [*FALCONIDÆ*, vol. x., p. 182; KESTREL.]

TINO. [TENOS.]

TINO'PORUS. [*FORAMINIFERA*, vol. x., p. 348.]

TINTAGELL. [BOSSINEY.]

TINTERN ABBEY. [MONMOUTHSHIRE.]

TINTORETTO, JA'COPO, one of the most celebrated painters of modern times, and one of the heads of the Venetian school, was the son of a dyer (Tintore), whence the agnomen of Tintoretto: his family name was Robusti; and he was born at Venice in 1512. He exhibited a remarkable facility for drawing at a very early age, which induced his parents to place him in the school of Titian. Ten days however after young Tintoretto had entered the school of the great painter, he was sent home again to his parents; Titian's attention being attracted by some very spirited drawings he saw in his studio, he inquired who did them, and upon Tintoretto's acknowledging himself the author, Titian ordered one of his scholars to conduct the boy home.

This remarkable rebuff in the career of the young painter seems to have added vigour to his energies, and he commenced a course of indefatigable application. He purchased some casts from the antique and some from the models of Daniel da Volterra, from the statues of Michael Angelo of Morning, Twilight, Night, and Day, at the tomb of the Medici, in San Lorenzo at Florence, resolving to follow the style of Michael Angelo in design, and to combine with it the colouring of Titian,—which intention he proclaimed to his visitors by the following line, which he wrote upon the wall of his apartment:—

' Il disegno di Michel Angelo, e 'l colorito di Tiziano.'

By day he copied pictures by Titian; and by night he made drawings upon coloured paper, with chalk, from his casts, lighted merely by a candle; by which means he acquired a taste for strong contrasts of light and shade, a peculiarity for which all his works are conspicuous. To these studies he added the occasional study of the living model and of anatomy; and to attain a still greater mastery of chiar'oscuro, he used to make models of figures in wax, and place them in pasteboard cases, making apertures for the light as he required it: he also suspended models and casts from the ceiling, for the purpose of becoming familiar with various perspective views of the figure. In addition to these studies, he is said to have received much gratuitous assistance from Schiavone in colouring. Tintoretto's first picture which attracted notice was one containing portraits of himself and his brother, by candle-light, himself holding a cast in his hand, and his brother playing the guitar. He exhibited this picture in public, and shortly afterwards he exhibited a large historical piece upon the Rialto, which gave him a rank amongst the great painters of Venice. He undertook every commission which offered itself, and frequently painted large works merely for the price of the

materials. It would be impossible to enumerate all his works here; they amounted to many hundreds. One of his first great works in fresco was a façade in the Arsenal, which he painted in 1546, representing Balshazzar's Feast and the Writing upon the Wall. Of his first oil pictures, the following were most remarkable:—The Tiburtine Sibyl, for the church of Santa Anna; the Last Supper, and the Washing of the Disciples' Feet, for the church of Santa Marcola; for San Severo, a Crucifixion, very large; and in the church of the Trinità, the Temptation of Eve and the Death of Abel, besides some others.

Tintoretto was so eager for employment, and so desirous of public notice and applause, that rather than be inactive or unoccupied with any public work, he frequently volunteered his services, or at most required no further outlay from his employer than would cover the cost of the materials. He painted upon such terms the façade in fresco of a large house near the Ponte dell' Angelo; on the lower part of the house he painted a very spirited representation of a cavalry battle, above which he placed an ornamental cornice in bronze; over this he painted a large historical composition containing many figures; between the windows he introduced various figures of women; and at the top a rich frieze: the great extent and the boldness of these paintings astonished the Venetian painters of that period. Upon very similar terms he executed two of his greatest works, at Santa Maria dell' Orto, where he painted, for 100 ducats, two immense pictures fifty feet high. In one was the Procession of the Jews with the Golden Calf, and Moses upon a rock in the background receiving the Tables of the Law, which were supported by a group of naked angels; the other was a representation of the Last Judgment, containing an immense number of figures; an extraordinary work, which, in the opinion of Vasari, would have been perhaps without its rival as a work of art, if the execution of the parts had been equal to the conception of the whole.

The following works also are accounted amongst Tintoretto's masterpieces:—Saint Agnes restoring to life the son of the Præfect, painted for the chapel of Cardinal Contarino; the Miracle of St. Mark, called 'Il Miracolo dello Schiavo,' where the saint delivers a Venetian, who had become a Turkish slave, from a punishment ordered by his master, by rendering him invulnerable, so that hammers and other instruments of torture were broken upon his body without hurting him; this picture, which is generally considered the best of all Tintoretto's works, was painted in his thirty-seventh year, for the brotherhood of St. Mark, and when it was finished and put up, the worthy friars disputed with one another about the price, a dispute which Tintoretto settled by ordering the picture to be taken down and sent home, and telling the brotherhood that they should not have it at any price. He however, after some entreaty, restored it to its place and received his own price, and the friars further gratified him by ordering him to paint three other subjects from the life of the same saint,—the Exhumation of the Body of the Saint at Alexandria, through the two Venetian merchants Buono da Malamocco and Rustico da Torcello; the Transport of the Body to the Ship; and the Miraculous Preservation at Sea of a Saracen Sailor through the Saint: the miracle of the slave is in the Academy of Venice; it has been engraved by J. Mathan; the other three are in the Scuola di San Marco. Pietro di Cortona is reported to have said, that if he lived in Venice, he would never pass a holiday without going to see these works; he admired chiefly the drawing. The pictures he painted for the Scuola di San Rocco are equally celebrated: they consist of the famous Crucifixion, which was engraved by Agostino Carracci, to the greatest satisfaction of Tintoretto; the Resurrection of Christ, engraved by E. Sadeler; the Slaughter of the Innocents and the Miracle of the Loaves and Fishes, engraved by L. Kilian; and several others of less note. To these must be added three painted for the Padri Crociferi, an Assumption of the Virgin, and a Circumcision of the Infant Christ, painted in competition with Schiavone; and a Marriage at Cana, now in the church of Santa Maria della Salute. The Miracolo dello Schiavo, the Crucifixion at San Rocco, and the Marriage at Cana, are said to be the only pictures to which Tintoretto put his name. There is an engraving of the Marriage at Cana, by Volpato, and a spirited etching by E. Fialetti.

Tintoretto executed many great works for the govern

ment of Venice, both in oil and fresco; and such was his activity, perseverance, and success, that he left little to be done by others. He was always occupied, and he worked with such unexampled rapidity that he used to be called *Il Furioso*. Sebastian del Piombo said that Tintoretto could do as much in two days as he could do in two years. He painted for the senate, in the council-hall, the Coronation of Frederick Barbarossa, by Pope Adrian IV., at Rome; and in consequence of Paul Veronese painting a picture in the same hall, Tintoretto procured permission to paint another, in which he represented Pope Alexander III. surrounded by cardinals and prelates, excommunicating the same emperor: the pope was represented throwing the extinguished candle amongst the populace, and a crowd of people was rushing forward to endeavour to catch it. He painted also for the senate, in the hall dello Scrutinio, the celebrated naval victory of the Venetians over the Turks in 1571. He painted many other works in the ducal palace, historical and allegorical, commemorating the history of Venice, of which the most famous are the capture of Zara by storm; and the great picture of Paradise, upon canvas, 74 feet by 34, containing a surprising number of figures. This was his last great work; he commenced it in several pieces in the Scuola Vecchia della Misericordia, and finished it, with the help of his son, in its place on the ceiling of the great council-hall of the Senate, now the library.

Tintoretto painted at Venice eight friezes for the duke of Mantua, recording the duke's feats, to be placed in his castle, and he visited the duke at Mantua, with all his family, and was splendidly entertained by him. He painted also the portrait of Henry III. of France and Poland, when that king visited Venice; of which picture Ridolfi relates a curious history. Tintoretto was engaged with Paul Veronese in painting some figures in chiar'oscuro upon the arch of triumph erected by Palladio at Venice in honour of the landing of Henry III., king of France and Poland; but wishing to take a portrait of the king as he landed, he prevailed upon Paul Veronese to complete the arch; and he dressed himself as one of the doge's attendants, and went in the Bucintoro, the state barge, with the others to receive the king, whose portrait he drew in small, in crayons, unknown to the king, whilst he was proceeding in the barge to the landing-place. This portrait he afterwards enlarged in oils, and procured permission from the king to retouch it from life. The king expressed himself very much pleased with the portrait, and accepted it from the painter, whom he wished to create a cavaliere; but Tintoretto declined the honour, upon the plea that to bear a title was inconsistent with his habits. Henry III. afterwards presented the portrait to the doge Luigi Mocenigo. Tintoretto painted many portraits, all in a remarkably bold style; he painted several of the series of doges' portraits along the frieze of the great council-hall.

It has been said above that Tintoretto was a remarkably rapid painter: he was however as careless about the execution of the parts as he was bold. There are pictures by him painted in his youth that are extremely carefully finished, but these are very few: Susanna at the Bath with the two Elders, is of this class; several of his large pictures are merely dead coloured, and many of them were painted off without the slightest previous preparation. His rapidly-executed and low-priced productions were a frequent source of complaint to his fellow-artists. Upon one occasion, when the brotherhood of San Rocco requested Paul Veronese, Salviati, Zuccaro, Schiavone, and Tintoretto to send them designs for a picture of the Apotheosis of San Rocco, that they might select the best of them, Tintoretto sent his finished picture as soon as the others sent in their designs, affirming that he had no other way of drawing; and to ensure its being fixed in its destined place, he made the institution a present of the work. Although Tintoretto professed to draw in the style of Michel Angelo, and to colour like Titian, there are few traces of either quality in the great majority of his works; they are however all conspicuous for his own peculiar style of chiar'oscuro, which is frequently both heavy and cold. In his larger compositions a principal characteristic is the number of figures, which are often crowded and confused, and the spectator looks in vain for a spot of repose to relieve the mind: this is however not the case with such pictures as the *Miracolo dello Schiavo* and other earlier productions. Anibal Carracci has eloquently expressed the inequality of

this great painter—that if he was sometimes equal to Titian, he was often inferior to Tintoretto. The Venetians used to say that he had three pencils, one of gold, one of silver, and the other of iron. In his design Tintoretto was accurate, but lean, and often incorrect; and in the use of his draperies frequently mean and confused; his colouring was not gaudy, like that of many of the Venetians, but was often even cold, and shadow predominates in perhaps all his pictures. He was once asked which were the prettiest colours, and he answered 'black and white.' It was also a maxim of his that none but experienced artists should draw from the living model, as they were not capable of distinguishing between the beauties and the imperfections of an individual model. Tintoretto painted Arctin's portrait, and Ridolfi relates the following anecdote connected with it:—Arctin was a great friend of Titian's, and was in the habit of abusing Tintoretto occasionally: the latter one day meeting the poet, invited him to come and sit to him for his portrait, to which Arctin assented; but he had not sooner seated himself in the painter's studio, than Tintoretto pulled out with great violence a pistol from underneath his vest and came towards him: up jumped Arctin in a great fright, and cried out 'Jacopo, what are you about?' 'Oh! don't alarm yourself,' said Tintoretto, 'I am only come to measure you;' and suiting the action to the word he said, 'you are just two pistols and a half.' 'What a mountebank you are!' returned Arctin; 'you are always up to some frolic.' The poet was afterwards more cautious, and they became friends. Ridolfi records a few other whimsical feats of Tintoretto's. He died at Venice in 1644, aged eighty-two. He had two children—a son Domenico, and a daughter, Marietta—who both practised painting. Domenico was born in 1562, and died in 1637. He followed in the steps of his father both in history and portrait; but, says Lanzi, as Ascanius did those of *Æneas*, *passibus æquis*. Marietta was born in 1560, and died before her father, in 1590. She painted very excellent portraits.

(Ridolfi, *Le Maraviglie dell'Arte, ovvero le Vite degli Illustri Pittori Veneti, e dello Stato; Zanetti, della Pittura Veneziana, e delle Opere pubbliche de' Veneziani Maestri*, &c.)

TIOOMEN. [SIBERIA.]

TIPERAH MOUNTAINS. [HINDUSTAN. p. 216 SECT.]

TIPPERARY, an inland county of the province of Ulster in Ireland. It is on the northern border of the province, and is bounded on the north-east by King's County and Queen's County, and on the east by the county of Kilkenny, all in the province of Leinster. On the south-east and south it is bounded by the county of Waterford, on the south-west by that of Cork, and on the west by those of Limerick and Clare, all in Munster. On the north-west it is bounded by the county of Galway in Connaught, from which, as well as from Clare, it is separated by the river Shannon or the lakes through which it flows. It is one of the largest of the Irish counties, being exceeded only by those of Cork and Kerry in Munster, Galway and Mayo in Connaught, and Donegal in Ulster: its greatest length is from north to south, from the junction of the Lower Bross with the Shannon to the Arra glen, 68 miles; the greatest breadth is from the border of the county of Limerick, between Tipperary and Bruff (in Limerick), to the border of the county of Kilkenny, north of Carrick-on-Suir, about 41 miles. The area is variously estimated. In the Population Returns (*Parl. Papers*, 1833, vol. xxxix.), and in the table annexed to the *Useful Knowledge Society's Map of Ireland*, it is given at 834,910 English acres (= 1306 square miles); by Dr. Beaufort (*Memoir of a Map of Ireland*, 1808) at 882,398 English acres (= 1379 square miles); and by Mr. R. Griffith, in his evidence before the Lords' Committee on Tithe (*Lords' Sessional Papers*, 1831-2, at 1013) at 819,698 acres (= 1291 square miles of cultivated land), 182,147 acres (= 284 square miles of unimproved mountain or bog, and 11,328 acres = 18 square miles) of lakes. The excess of this last estimate above the previous ones is remarkable, and would render it liable to suspicion if it were supported by an eminent authority. The population, in 1831, was 222,264, giving 308, 292, or 254 inhabitants to a square mile, respectively, to the three estimates of the area of the county. Clonmell or Clonmel, the chief town, is on the Suir, 30 miles

in a direct line south-south-west of Dublin, or 103 miles by the road through Naas, Castle-Dermot, Carlow, Leighlin Bridge, Kilkenny, and Callen.

Surface; Geology; Bogs.—The Knockmeledown Mountains, on the south border of the county, where it is continuous with Cork, rise to the height of 2700 feet above the level of the sea. They are placed in 'a table-land of clay-slate, partly bordered on the flanks by sandstone, and on the higher grounds sustaining isolated caps of the same rock, or upholding more continuous mountain-masses.' The position of the sandstone on the flanks is generally conformed to the inclination presented by the surface of the subjacent clay-slate, but the masses on the higher grounds approach more and more to a horizontal arrangement. This tract (of clay-slate) is surrounded by floetz limestone on the north, the west, and the south: 'this limestone tract on the north separates the Knockmeledown Mountains from the Galtees, of which the principal summits (3000 feet high) are in this county. The general direction of these two ranges is nearly east and west: the intermediate limestone plain or valley is watered by two streams (with their respective affluents), one, the Tar, flowing eastward into the Suir; the other, the Funcheon, westward into the Blackwater. North of the Galtees, from which they are separated by a narrow valley (the Glen of Aherlow), rise the Slievh-na-Muck Mountains, which form a subordinate and lower range, and have the same general direction of east and west. Both the Galtees and the Slievh-na-Muck are composed wholly of sandstone, and the intermediate valley or glen appears to be occupied by the same formation. The northern face of the Galtees, towards this narrow valley, is in many parts extremely precipitous, and even inaccessible: the southern face, towards the broader valley or limestone plain, which separates them from the Knockmeledown Mountains, is of a tamer character. The strata of the sandstone are, in the upper region of the Galtees, almost horizontal, yet gently curved, following the form of the summit, and precipitously broken off on the sides, where they frequently crop out. On the flanks, where they are not abruptly broken off, they become more inclined, and appear to be conformed to the surface of the clay-slate on which they rest. The sandstone varies much in character, but in general it is a fine-grained rock, composed of grains of quartz closely aggregated. The sandstone of Slievh-na-Muck yields excellent flags.

In the south-eastern corner of the county, north of Clonmell and Carrick-on-Suir, is a group of hills called Slievh-na-Man, the geological character of which is similar to that of the mountains already described: the group 'consists of a nucleus of clay-slate, surrounded and surmounted by sandstone.'

In the centre of the county is another important range. It commences in the county of Limerick, north of the little river Mulkerne, or Bilboa, which joins the Shannon a short distance above Limerick. At this extremity the range is known as the Doon Mountains; but as it extends north-eastward into Tipperary, the most important summits are known as the Bilboa and Keeper Mountains (the latter 2100 feet high) and the Devil's Bit: it crosses the county of Tipperary in a north-eastern direction by Temple-derry and Roscrea, becoming narrower as it advances, and enters Queen's County and King's County, which it separates from each other, and where it is known under the designation of Slievh Bloom. The geological character of these mountains is similar to those already described: Keeper and Bilboa and the adjacent parts of the range consist of clay-slate, generally flanked by sandstone, except for a small space on the north-west side, near the village of Silvermines, where, at the foot of the hills, the clay-slate comes in contact with and immediately supports the floetz limestone. To the north-east of Temple-derry the range is entirely composed of sandstone. The direction of the strata of the clay-slate varies in this mountain-range. The sandstone in one part, near Newport, on the west side of the range, is a coarse red conglomerate, and rests unconformably on the clay-slate. Copper was formerly dug in these mountains, at Lackamore, five miles east of Newport. There are three veins, one of them thicker than the rest, and bearing rich copper-ore in bunches. The workings on this vein extended above 700 feet in length and 150 feet in depth. An attempt was made early in the present century to renew the works, but the machinery was insufficient to keep the mine free from water.

Considerable quantities of lead mixed with silver were obtained last century in an opening at the junction of the clay-slate with the floetz limestone, near the village of Silvermines. This opening had been filled with clay, sandy clay, sand, decomposed slate, and scattered blocks of limestone, Lydian-stone, and sandstone, the whole mass being penetrated or cemented by metallic depositions of various kinds; and in this 'softness,' as the miners termed it, the operations were conducted.

Near the lower part of Lough Derg, one of the lakes through which the Shannon flows, are the Arra Mountains, a group occupying a small part of this county on the western side, and extending across the Shannon into the county of Clare (where they are known by the name of Slievh Bernagh); they consist partly of clay-slate and partly of sandstone. There are quarries in these mountains which yield slate not inferior to that of North Wales.

The rest of the county is occupied by the floetz limestone, except a portion of the district between the southern groups of mountains (Slievh-na-Man and the Galtees) and the Central range, which is occupied by the coal-field of Killenaule; and one or two small tracts on the western side of the county, where trap rocks appear interstratified with the limestone. This floetz limestone presents in its connection with other rocks and in its organic remains several features similar to those of the mountain limestone of Derbyshire and the north of England; but differs in this, that the tract occupied by it forms an extensive plain, marked only by slight undulations.

The coal-field of Killenaule extends about eighteen miles in length from north-east to south-west, from near the river Nore to the neighbourhood of Cashel, and about six miles in breadth. It is partly in this county and partly in that of Kilkenny. There are two very small outlying portions near Cashel. This coal-field forms a low range of hills, placed upon the floetz limestone, and elevated above it. It varies in its elevation, being highest and most abrupt on the north-western side, where the hills rise from 300 to 600 feet above the limestone plain. On this side the dip both of the limestone and superincumbent coal strata is greater than on the other side. Towards the south-east the surface declines gradually, and the streams which water the tract mostly flow in that direction. The strata are more gently inclined here. The aspect of the hills varies, but they are commonly rounded with intervening hollows. The junction of the limestone with the coal-formation is generally at the foot of the hills, but sometimes half-way up their side. Immediately above the limestone, shale and gritstone alternate, there being two beds of each: the upper gritstone, when not covered by the superior beds, constitutes the main body of the elevated part of the coal-hills: it is marked by repeated undulations, forming unequal ridges, with intervening hollows or troughs, having their greatest extension or length generally from north-east to south-west. In these troughs the coal-beds are found resting upon fire-clay, which intervenes between them and the gritstone and forms the floor of the coal, and covered by shale, grit, and then shale again. Sometimes this series is repeated so as to give two seams of coal. The troughs are generally from fifty to seventy yards deep from the surface to the coal, near the centre of the trough, and from 500 to 700 yards wide at the surface. The coal is of the nature of blind-coal or anthracite. The coal-works have been carried on with increased activity of late years: before 1825 the yearly produce was valued at about 12,000*l.*; since that period it has been nearly doubled.

The principal bogs are in the eastern and central part of the county: one continuous line of bog extends from near the border of the coal-field, near Killenaule, to the south-eastern foot of the central range of hills at Roscrea, a distance of nearly 30 miles; and there are smaller detached bogs westward of this, and some in the northern part of the county, between the Lower Brusna and the Shannon.

Hydrography and Communications.—The greater part of the county is comprehended in the basin of the Barrow and the Suir, two rivers which unite in Waterford Haven. A small part on the eastern border is drained by the Minster, or King's River, a small affluent of the Nore, which itself is an affluent of the Barrow. The Nore rises in this county, but has its course chiefly in that of Kilkenny. But most of the waters flow into the Suir, which rises north of Templemore, on the south-eastern slope of the mountains that there cross the county, and flows by Thurles, Golden,

and Cahir, to the junction of the little river Nier; after which it flows along the border of this county and Waterford, first northward, and then westward, by Clonmell and Carrick, below which it quits the county altogether. Its course in Tipperary may be estimated at about 76 miles. It receives a number of tributaries, most of them small. On the right bank the Multeen joins it above Golden Bridge; and the river which waters the glen of Aherlow, between the Galtees and Sliev-na-Muck, and the Tar, which drains part of the limestone valley between the Galtees and Knockmeledown, join it lower down. The Nier, which joins it on the border of the county, on the same bank, belongs to the county Waterford. Two streams join it on the left bank, one below Clonmell, and another on the border, below Carrick. The Suir is navigable by large barges up to Clonmell.

That part of the county which lies north-west from the central chain of mountains (the Keeper, Bilboa, and Devil's Bit) belongs to the basin of the Shannon. The Shannon itself, and Lough Derg, through which it flows, skirt the north-western border for about 45 miles, being navigable throughout. The streams which flow from the north-western slope of the central chain are affluents of the Shannon, but none of them are navigable: the principal are the Nenagh, which passes the town of Nenagh, and the Lower Brusna or Brosna, which skirts the north-eastern border, and unites with the Shannon at the northern point of the county.

There are no lakes in this county; but Lough Derg is on its border. There are no navigable canals. The road from Dublin to Cork enters the south-eastern side of the county, and passes through Clonmell and Clogheen. Another road from Dublin to Cork by Athy passes through Cashel and Cahir. The road from Dublin through Kildare and Maryborough (Queen's County) to Limerick crosses the northern part through Roscrea, Toomevara, and Nenagh: another road from Dublin through Tullamore and Parsonstown (both in King's County) unites with the foregoing at Nenagh. The road from Waterford to Limerick enters the county on the south-east at Carrick-on-Suir, and passes through Clonmell, Cahir, and Tipperary. There are roads from Clonmell to Cashel and to Cahir, and from Tipperary to Cashel, besides other roads of less importance, which do not require description. In the evidence taken before the Irish Poor Commissioners (*Parl. Papers*, 1836, vol. xxxiii.), the roads in the barony of Middlethird—which, as comprehending part of the mountainous country (including Sliev-na-Man) and part of the valley or plain between the central and southern mountains, may be taken to represent the county at large—are described as good and sufficiently numerous.

Agriculture and Condition of the People.—The information which we give under this head, extracted from the Appendix to the Irish Poor Commissioners' Report (*Parl. Papers for 1836*, vol. xxxiii.), has reference to the barony of Middlethird, from which alone witnesses were examined; but it may probably be regarded as in a great degree applicable to the rest of the county.

The land in the barony was estimated in the county books (though the measurement was old, and regarded as inaccurate) at 58,833½ plantation acres: the plantation or Irish acre being equal to about an English statute acre and five-eighths, or accurately, to 1a. 2r. 19½p. The land was held as follows:—

70	persons	held	above	100	acres.
20	"	"	from	80	to 100.
127	"	"	50	to 80.	
551	"	"	20	to 50.	
759	"	"	10	to 20.	
745	"	"	5	to 10.	
1056	"	"	1	to 5.	
290	"	"	less	than	1 acre.

The soil of the barony is chiefly a rich loam of some depth on a substratum of limestone, and is equally adapted to tillage or pasture ground. There is no public common land, nor any woodland except from 150 to 200 acres in gentlemen's demesnes: there are only about 500 or 600 acres of bog, and that in the northern part of the barony: in the southern part the want of fuel is severely felt. Of the remainder of the barony, after these trifling deductions, one-third or one-fourth is pasture-land, and the rest in tillage. Grazing-farms are chiefly

large, and are occupied by gentlemen, but there are not many of them: the quantity of grazing-land had increased in the five years preceding the inquiry, but previously to that period the converse had taken place, pasture having been converted into tillage. Farms are generally bounded by double ditches; fields are divided by single ditches. These fences are generally in good condition, and the loss from cattle trespassing is trifling. The quantity of land wasted in fences in this barony is greater than in others.

Rents have been decreasing: it was estimated that they had fallen in the twelve years preceding the inquiry from 20 to 30 per cent. The Irish acre is in general less than at the time of the inquiry were generally held under lease, but the granting of leases was going into disuse, and farms of which the leases had fallen in during the preceding six years were generally held by tenants at will. The ordinary term of farm leases is thirty-one years, or three lives. Cottage and glebe lands are commonly let for twenty-one years. Since the subletting act, it has not been usual to grant leases to tenants in common; such leases had been found injurious; they had prevented draining and inclosing, and other improvements. About one-fourth of the barony was at the time of the inquiry held under middle-men, but the system is going into disuse; and though leases do not usually contain any prohibitory clause, yet there is an understanding that the lessee is not to sublet. There has been a disposition in the landowners to consolidate small holdings; but where ejectments have taken place they have been resisted by the peasantry, and threats have been used and outrages committed upon those who succeeded to the occupation of the vacated land: considerable difficulty has thus been placed in the way of consolidation.

The average rent of land is not given; the competition for small holdings is however so great that when a vacant occurs men will bid more than will allow them to make a subsistence from the land: and in most cases the tenant cannot obtain more than a bare subsistence. The rent of these small holdings is generally paid in kind. This competition for land has been a fruitful source of crime. Good land may probably be worth from 2l. to 3l. per acre; but when let as con-acre it brings in a large rent, which is usually paid in money, except when a farmer lets land to his own labourers. Dairy-land is worth an acre more than tillage-land, and grazing-land is more valuable.

The usual rotation of crops is threefold; potatoes, wheat, and oats form the series, and if the land will bear it is repeated. The potatoes are manured chiefly with cow-manure, which sells in the towns for 2s. and 2s. 6d. per cwt. The farmers, especially the smaller ones, keep very little stock; and stall-feeding for the purpose of making manure is not practised in the district: but weeds, turf, and bog-earth are carried to the dung-yard to be trampled down. Manure is the great want of the farmer, and various expedients are resorted to in order to procure it. The potatoes grown both by the farmers and the peasantry are commonly the white potatoes, because, though of inferior quality, they grow more freely and on more exhausted land. Potatoes are generally cultivated with the spade, but the practice of drilling them in by the plough is becoming more common: fallows are occasionally resorted to, though as much to give rest to the land exhausted by the frequent use of the potato crop as to clean it from weeds: fallows are generally manured with lime, which is burned with coal or small-coal from the collieries in the county.

Wheat is more commonly grown after potatoes than after fallow: the seed is generally steeped in brine to preserve it from smut; and the crop while growing is once weeded once, and rolled. Many of the smaller farmers break the lumps with a wooden mallet. None of the wheat is of the first quality: a good deal is threshed out by the small farmers immediately after harvest to pay their rent or other debts: the large farmers do not off-thresh before November.

The cultivation of clover, rye-grass, and vetches is much increased of late years; but neither turneps or mangel-wurzel are cultivated: the potato is generally used for feeding cattle. The clover is left on the ground one year, and is mown twice and then ploughed in.

After the common rotation of crops has been taken once or twice, or on some of the best lands three or four times, the ground is left to grass for six or eight years.

Grass or clover seeds are usually sown with the oats the last crop of the tillage course; and for the two following years the produce is mown, and then grazed until the land is again broken up by the plough. Small farmers frequently do not sow any grass seeds nor mow the crop; they also break up the ground after a shorter interval. Owing to the warmth and moisture of the climate, and from the later period (the month of August) at which they are cut, the crops of hay are heavier than would be produced by land of equal goodness in Great Britain; but it is probable that from its more succulent nature the hay will not support or fatten cattle better than a smaller quantity of English hay.

The long-horned Leicester breed of cattle was introduced many years ago; but the Durham and Hereford breeds are more in request. The common Irish (Limerick) breed is however most generally used, as being the most hardy. The stock of all kinds is very good. There are not so many cattle fattened for export as there were formerly, still some are fed for the English market, and are exported from Waterford to Liverpool. Cattle are fit for slaughter from three years and a half old; they weigh when fat from four cwt. to six cwt. Many young bullocks are sold at a year old to Roscommon and Galway men; others for grazing are bought in the neighbourhood or at Ballinasloe. The Ayrshire and Kerry cows are not much used except by gentlemen. The quantity of butter made is not great, but the quality is in general good, and the mode of preserving it is improving: Clonmell is the principal market. Very little cheese is made.

There are not many sheep kept: they are in general a cross of the Leicester breed, and are large well-made animals. There are no large flocks, and folding sheep is not in use; the small farmers keep two or three sheep for the sake of the wool; and those who have dairies mix some sheep in their pastures with their horned stock.

The horses are of an active light-boned sort, very useful for all farming purposes. Oxen are never employed in labour. Pigs are numerous, and of an improved breed: they are considered to be still improving.

Agricultural implements have undergone much improvement of late years. An iron plough, after the form of the Scotch plough, has superseded the old-fashioned one, which is now seldom seen in use: the harrows, though not so well made, yet, from the friable nature of the soil, do their work efficiently: rollers are getting more common every year; and these, as well as the harrows, are borrowed by the farmers from each other. The carts are of cheap construction, with narrow wheels and low sides formed of rails; they carry only a small load, and are drawn by one horse. The plough is used in the cultivation of every crop except potatoes, for which, among the small farmers, the spade is used; but the use of the spade is diminishing every year. The flail is used in threshing, except when the straw is wanted for thatching, and then the corn is often knocked out against a board by the hand.

The dairy-farmers have in general more capital than other farmers. They have better houses, and these, with their cattle-sheds and other farm buildings, are usually in good condition. Mud-walls are found to answer best for dairies, and little air is admitted.

Many of the resident gentry have set an example of superior cultivation, and have been the means of introducing improved stock and implements. They crop the land less severely than the common farmers, and give it longer intervals of rest or more manure, in which they are followed by the larger farmers.

The con-acre system is common; these allotments are commonly taken by the cottiers to raise their own food, but a considerable number are taken by servants and women with a view to profit from the sale of the produce. The usual quantity taken by a family is a quarter to half an acre; and the labouring class are always anxious to obtain it.

The demand for labour at the time of the inquiry was considered to have decreased, while the population had increased. Wages, which had in the course of ten years undergone a diminution of about two-pence per day, were usually for men 6*d.* a day with food, and in harvest 1*s.* a day with food; or when hired for a whole year, 7½*d.* a day in summer, and 6*d.* a day in winter, without food. Boys under sixteen received 8*d.* a day in harvest-time, or if hired by the year 15*s.* per quarter, or in some baronies 20*s.* per

quarter. If a labourer worked 250 days in the year, at 8*d.* a day, he received 8*l.* 6*s.* 8*d.*, which may be considered as the full average of the yearly earnings of the class. In the seasons when work is slack, mid-winter and a month before harvest, many of them resort to begging. To this the labourer may add a little by eggs and about 3*l.* by his pigs. When food is dear, the labourer has to work sometimes for six weeks in July and August, merely for his food, consisting generally of potatoes and milk. When a farmer feeds his labourer, he gives him commonly better food than he would have at home. If a labourer has a cottage, potato-garden, and milk from his employer, as is usual, these are considered equivalent to a third or a half of his wages. The labourers in the richest grazing districts are the worst off. The labourers when they obtain permanent employment, at fixed wages, exhibit generally increased cleanliness and decency of appearance, and their cabins are better furnished.

There is no employment for women, except in some of the baronies in harvest-time, and perhaps in the potato-planting and digging seasons, when they earn about 6*d.* a day. Formerly they spun wool for their own clothes, but this practice has ceased for several years, probably because the manufactured article can now be purchased cheaper. The rearing of fowls is the source of some profit; and a couple of pigs will bring in about 3*l.*, which is depended upon to pay the rent of the potato-garden. There is no work for children under fourteen years of age: they are not employed in hoeing or weeding corn or other crops.

The cottier tenants, occupiers of less than ten acres of land, are enabled to feed and clothe their families better than a labourer, but are themselves worse fed than the labourers who are dieted by the farmers. Cottiers seldom keep a cow; they hold their land from year to year, and are generally in arrear for rent, which is always (if a man holds five acres or more) expected to be paid in money.

The potatoes which the labourer or small cottier grows constitute the food of his family; he himself is frequently fed by his employer. Milk is not used in more than one half of the families. The greatest expenditure on tobacco is 6*d.* a week. Candles for six months amount to 3*d.* per week, and other necessaries, under the general designation of 'kitchen,' cost from 1*l.* 10*s.* to 2*l.* 10*s.* for the year. The labourers do not consume any description of groceries. The fees to the Roman Catholic clergy form an important item in a labourer's outlay. The fee for marriage is 25*s.*, for churching a woman 2*s.* 6*d.*, and for blessing the clay and saying mass at a funeral 5*s.*; at confession at Easter and Christmas 1*s.* is expected: but these fees are often remitted.

The dwellings of the labourers are of the most wretched description, nor has any perceptible improvement taken place of late years. During the alarm of cholera they were whitewashed, but that is now neglected. They are generally 20 feet long by 12 broad, with walls from 7 to 8 feet high, divided into two or perhaps three very small apartments, and never having a second story; covered only with a thatch of straw, and having nothing but the bare ground for the floor, and that often full of holes, which in wet weather become little pools of water. A hole in the roof allows the escape of the smoke, and their windows, 15 inches square, are more commonly without glass than with it, and almost universally destitute of shutters. They have rarely any outhouse except a pigsty, and in many cases where they have not even that, the pig sleeps in the house. These wretched hovels usually cost in erection about 10*l.*, and the tenant pays from 20*s.* to 30*s.* a year as rent; with a rood of land, the rent is near 2*l.* 10*s.* The cabins are always kept in repair by the tenant. They are usually built separate, not grouped in villages or hamlets, and for convenience near the road-side.

It rarely happens that there is more than one bed for the whole family; a bedstead, a dresser, two chairs, a large iron pot, and some crockery, all of the worst description, usually complete the catalogue. In some wretched cabins even these are not found, and the family lie on the floor.

The chief article of food is the potato: the peasantry grow this in preference to corn, because it yields a more abundant supply with less care and less manure. A labourer, when employed, gets three meals of potatoes a day, his wife and children only two. In July and August, when the old potatoes have become unfit for food, and the

new crop is not ready, colic or other bowel complaints are produced by the unwholesomeness of the diet; and the failure of the potato crop is always productive of great distress: the labourer is then obliged to procure provision upon credit, which he obtains with great difficulty and by paying double the market-price.

In respect of clothing, considerable improvement has taken place, though the peasantry are still very indifferently clad. No material for clothing is of home manufacture, but the women generally make up their own dresses: sometimes however they are unable to do this, and have to pay for getting them made. The use of shoes and stockings is increasing. Old clothes, brought from London and Liverpool, are much worn. The yearly expenditure of a labourer's family on clothes is seldom less than a pound.

The ordinary fuel is turf: near the bogs this is cheap, but to one living at a distance of 8 or 10 miles from a turbary, the cost is doubled. When fuel is scarce, pilfering and the destruction of woods and fences are common. Straw and dried cow-dung are used as a substitute for turf. The county has always been one of the most disturbed in Ireland; 'although there is an ebb and flow of crime in other counties, Tipperary has always kept up steadily to high-water-mark.' This was the statement of the resident police magistrate of Cashel. (See *Parliamentary Papers* for 1836, vol. xxiii., p. 357.)

Divisions, Towns, &c.—The county is divided into eleven baronies, as follows:—

Barony.	Situation.	Pop. in 1831.
Clanwilliam	W.	48,152
Eliogarty	Central	38,531
Iffa and Offa (East)	S.E.	38,702
Iffa and Offa (West)	S.W.	40,192
Ikerin	N.E.	27,077
Kilnemanagh	W.	30,774
Middlethird	Central	44,103
Ormond (Lower)	N.	45,006
Ormond (Upper)	Central	24,807
Owney and Arra	W.	32,454
Slievardagh	E.	32,765

402,563

It contains the county-town of Clonmell or Clonmel [CLONMEL]; the city of Cashel [CASHEL]; the ex-borough (formerly parliamentary) of Fethard; the market-towns of Cahir, Carrick-on-Suir [CARRICK-ON-SUIR], Clogheen, Killenaule, Nenagh, Roscrea, Templemore, Thurles, and Tipperary; the post-towns of Burris-o'-Leagh, Burris-o'-Kane, CloghJordan, Golden, Littleton, New Birmingham, and Newport; and the villages of Ballina, Emly, Mullinahone, Silvermines, Toomavara, and others. Some of these are described as referred to above: of the others we give some account here.

Fethard is in the barony of Middlethird, 100 miles from Dublin by Kilkenny and Callen, and 9 miles north from Clonmell. The town contained, in 1831, 582 houses, inhabited by 689 families; 39 houses uninhabited, and 5 building, with a population of 3405: the whole parish contained 678 houses, inhabited by 797 families; 41 houses uninhabited; and 7 building; with a population of 4050. The town is irregularly laid out on both banks, but chiefly on the left or north-eastern bank of a small stream, the Glashall, which ultimately joins the Suir below Clonmell. Fethard is an antient and decayed town, in a bye situation, with little trade. Of the houses about 120 are slated, and chiefly of two stories: the rest are thatched cabins, and of the poorest description. There are a parish church; a Presbyterian and a Primitive Methodist meeting-house; two Roman Catholic chapels, one the regular parish chapel, the other attached to an Augustinian friary. The parish church, of which the chancel is in ruins, and the friary chapel, are antient structures. There is a good slated school-house. The town was formerly walled, and some portions of the walls and of the gateway towers remain. There are (or were lately) four mills and a tan-yard or two: the principal trade is shoemaking; but the chief occupation of the labouring class is agriculture.

The town was incorporated at an early period: the oldest known charter is dated 49 Edward III., A.D. 1376; but the corporation has been dissolved by the late Irish Municipal Reform Act. The borough sent two members to the Irish parliament, but was disfranchised at the Union. There is a market on Saturday, but it is of minor impor-

tance: the yearly sale of wheat is about 8000 barrels of oats about 3000 or 3500 barrels. There are a dispensary and a charitable loan-fund: and (by returns to the House of Commons, printed in 1835) ten schools of all kinds including a national school with 186 boys on the books and an average daily attendance of 130.

Cahir, or Caher, is in the barony of Iffa and Offa West, 111 miles south-west from Dublin by Clonmell, from which it is distant 7 miles west. The town had, in 1831, 515 houses, inhabited by 706 families; 61 houses uninhabited, and 16 building, with a population of 3408: the whole parish had 1291 houses, inhabited by 1625 families; 30 houses uninhabited, and 23 building, with a population of 8594. Cahir is pleasantly situated on the banks of the river Suir, at the eastern end of the valley, between the Gales and the Knockmeledown Mountains: it is, for an Irish town, very clean, and has been steadily increasing, though not rapidly: the new houses are chiefly of a good description, worth from 10*l.* to 40*l.* per annum, and are respectably tenanted. There are a parish church, a Roman Catholic chapel, and a Quakers' meeting-house. Near the town are extensive cavalry barracks; and on the banks of the Suir are the demesne and residence of the Earl of Glengall. An attempt was made many years ago to establish the iron-manufacture, but it failed: since then the straw-plant has been introduced, and gives employment to a number of females: there are also some extensive flour-mills. The market is on Friday, and is an important corn-market: the yearly sales of wheat had increased from 23,662 barrels, in 1826, to 56,131 in 1835: the sale of oats had continued steady through the same period, at 37,000 barrels. There is a bridewell, and a body of constabulary are posted in the town: there are also a dispensary and fever-hospital, and (by returns to parliament in 1835) fifteen schools of all kinds; one of them a national school, with 26 scholars (boys and girls) on the books, and an average attendance of 150; and two others on Erasmus Smith's foundation, one with 51 girls on the books, and an average attendance of 25; the other containing 11 boys. Near the town, on an island of the Suir, are the picturesque ruins of the castle of Cahir.

Clogheen is in the barony of Iffa and Offa West, 120 miles south-west of Dublin through Clonmell, and 14 miles from Clonmell. The town is chiefly in the parish of Shanraghan: it contained, in 1831, 291 houses, inhabited by 357 families; 17 houses uninhabited, and 3 building, with a population of 1928: the whole parish had 187 houses, inhabited by 1199 families; 39 houses uninhabited, and 4 building; the parish of Tullaghorton, into which the town extends, had 297 houses, inhabited by 36 families; 5 houses uninhabited, and 5 building, with a population of 1965. What portion of these belong to the town we have no means of ascertaining. There is a Roman Catholic chapel in the town: the parish church of Shanraghan is in the immediate neighbourhood. Tullaghorton parish has no church. A large corn-market is held on Saturday, at which the yearly sale of wheat had increased from 42,125 barrels in 1826, to 62,824 in 1835: but the sale of barley had decreased from 3200 barrels in 1826, to 204 in 1835: there are seven flour-mills in and round the town, the flour from which is sent by land to Clonmell, and from thence down the Suir to Waterford, where it is shipped. There is also a large brewery. A body of constabulary are posted in the town; and there are a small cavalry barrack, a small bridewell, and a dispensary and fever-hospital. Near the town are the ruins of an antient parish church and of an antient abbey. Shanbally Castle, the seat of Lord Lismore, is also in the neighbourhood. By the returns to parliament in 1835 there were in the two parishes eight private schools, but not any national or other schools supported by subscription or endowment.

Killenaule is in the barony of Slievardagh, 92 miles south-west from Dublin by Urlingford, and 16 north from Clonmell by Fethard. The town, in 1831, contained 25 houses, occupied by 321 families; 34 houses uninhabited, and 2 building, with a population of 1578: the rest of the parish had 279 houses, inhabited by 300 families; 9 houses uninhabited, and 3 building, with a population of 1987, making a total population of 3467. There are a church, a Roman Catholic chapel, and a dispensary: the church is small and antient. There is a weekly market, and several yearly fairs are held: a portion of the county constabulary is stationed in the town. Several of the collieries &

the Killenaule coal-field are in this parish. By the returns to parliament, A.D. 1835, there were in the parish six schools, all supported by the payments of the children: school-houses had been built by subscription for two of these schools.

Nenagh is partly in Upper Ormond, but chiefly in Lower Ormond barony, between 95 and 96 miles south-west of Dublin, on the road to Limerick. The town contained, in 1831, 1282 houses, inhabited by 1703 families; 55 houses uninhabited, and 9 building, with a population of 8466: the remainder of the parish contained 104 houses, inhabited by 104 families, and 2 houses uninhabited, with a population of 693; making a total population of 9159. This town antiently belonged to the Butler family, who had a strong castle here: it had two ecclesiastical foundations; an hospital for the canons of St. Augustin, founded A.D. 1200; and a friary for conventual Franciscans, deemed the richest foundation of that order in Ireland, founded in the reign of Henry III. The town was burned, A.D. 1550, by the natives under O'Carroll, and the friary was included in the destruction, but the castle was saved by the garrison. The town was repeatedly taken and retaken in the great civil war in the reign of Charles I. It was taken by the native forces of James II., A.D. 1688, but after a time abandoned and burned by them. The town stands on the river Nenagh, which flows with a circuitous course from the Keeper Mountains into Lough Derg, and consists of four streets meeting in the centre. The ruins of the castle, consisting chiefly of a large circular donjon or keep, called Nenagh Round, are on one side of one of the streets, Castle Street. There are a barrack for cavalry; a fever-hospital and dispensary; a church, rebuilt some years since; a Roman Catholic chapel; and a bridewell, unless it has been disused since the completion of the county gaol, lately erected here. Some remains of the Franciscan friary may be traced. A portion of the county constabulary are stationed here. There is a well-attended market on Thursday for corn and cattle. The number of barrels of wheat sold on the average of the years 1826 to 1835 was above 45,000, of barrels of oats about 4500, and of barrels of barley 1300. The sale of here, which was about 1000 barrels in 1826, had quite ceased before 1835. There are in or near the town a brewery, a flour-mill, and a small stuff manufactory. There are several yearly fairs. There were in the parish, by the return made to parliament in 1835, eight schools of all kinds, including a national school, with an average attendance of 190 boys; a parish free-school, with an average attendance of 40 boys and girls; and a school on Erasmus Smith's foundation, with an average attendance of 28 boys and girls.

Roscrea is in the barony of Ikerin, 75 miles west-south-west of Dublin, on the road to Limerick, and about 50 to 52 north of Clonmell. A monastery for regular canons is said to have been founded here by St. Cronan as early as the beginning of the seventh century, which became subsequently the seat of a bishopric, afterwards united to Killaloe. According to Keating (*History of Ireland*) there was antiently a great fair held at Roscrea on the festival of St. Peter and St. Paul, at which fair, about the middle of the tenth century, an army of Danes, collected from Limerick and Connaught, attempted to surprise the natives; but these, having some suspicion of the attack, had brought arms with them, and made so stout a resistance, that they repulsed the enemy, with the loss of their leader and four thousand men. In 1213 King John erected a castle at Roscrea, of which a circular tower remains; and there is in the centre of the town a square castle of the Ormond family, occupied as a depôt for the troops quartered in the infantry barracks. About A.D. 1490 a Franciscan friary was founded.

The town of Roscrea is in a fertile and pleasant situation: it consists of several streets, irregularly laid out, and had, in 1831, 907 houses, inhabited by 1136 families; 61 houses uninhabited, and 6 houses building, with a population of 5512: the whole parish, which extends into the baronies of Ballybrit and Clonlisk in King's County (Leinster), had 1546 houses, inhabited by 1797 families; 79 houses uninhabited, and 12 building; with a population of 9199. The parish church is an antient building, with Norman doorways and niches, and several sepulchral crosses and curious architectural decorations. Near the church is a round tower 80 feet high and 15 feet in diameter, with a window with an arch of the usual form, 15 feet from the ground, P. C., No. 1549.

and a window with a pointed arch, about 30 feet from the ground. There are some remains of the antient monastery of canons of St. Augustin, consisting of the western gable, having an arched doorway, which forms an entrance to the present churchyard. There are also some remains of the Franciscan convent, which are (or at least were some years since) in good preservation: the tower of the conventual church forms the entrance to the present Roman Catholic chapel. There are a Primitive and a Wesleyan Methodist chapel and a Quakers' meeting-house in the ecclesiastical union of Roscrea (comprehending the parishes of Roscrea and Kyle), but we are not aware whether they are in the town.

The town has considerable trade as the mart for the surrounding district. Formerly there was a considerable manufacture of woollens, especially serges and stuffs, in which a thousand looms are employed; but this had so fallen off about 1835, that it gave employment only to a hundred looms. There were at that time a distillery and three breweries. There are two weekly markets and several yearly fairs for cattle and farming stock: there are public shambles and a commodious market-house. The sale of grain at the markets is considerable: the average yearly sale of wheat had increased in the ten years from 1826 to 1835, both inclusive, from 4140 barrels to 6700; and that of oats from 18,500 to 22,100 barrels; the yearly sale of barley had continued steady at 13,000 barrels. There is a savings' bank, the deposits in which had (in 1835) considerably increased: the depositors were chiefly farmers, small tradesmen, and servants: there were at the same time a fever hospital, a cholera hospital, and a dispensary. The number of places where spirits were sold was very great, amounting to above two hundred in the town alone; of these nearly half were licensed public-houses. There are a small bridewell, an infantry barrack, and a station of the county constabulary. There were, by the Parliamentary Returns for 1835, ten day-schools in the parish, including a national school, with an average attendance of 52 boys; a school on Erasmus Smith's foundation, with an average attendance of 91 boys; and a day-school for young girls in connection with the Ladies' London Association and the Hibernian Society, with an average attendance of 45.

Templemore is in the barony of Eliogarty, about 87 miles south-west of Dublin, and about 39 or 40 north of Clonmell. It is supposed to derive its name from the Knights Templars, who had a house here, of which the remains form an entrance to the demesne of the Carden family. There were in the town, in 1831, 404 houses inhabited by 609 families; 12 houses uninhabited and 7 building; with a population of 2936: the whole parish had 664 houses, inhabited by 885 families; 15 houses uninhabited, and 18 building; with a population of 4583. The town is pleasantly situated near the right or west bank of the Suir, and is (comparatively at least) a well-built and neat town. The church, which has a handsome tower and spire, was rebuilt about fifty or sixty years ago; there are a handsome and spacious Roman Catholic chapel, a good market and court-house, a bridewell, extensive barracks, a fever hospital and dispensary, and ball and news-rooms. The town is approached on all sides by avenues of ash-trees; and there are several gentlemen's seats and the remains of some very antient castles in the neighbourhood. There were, according to the returns of 1835, seven schools in the parish, including a free-school on Erasmus Smith's foundation, with an average attendance of 47 scholars, boys and girls.

Thurles is in the barony of Eliogarty, 96 miles south-west from Dublin by Templemore, and about 32 from Clonmell. It is a place of considerable antiquity, and was in the tenth century the scene of a severe battle between the native Irish and the Danes. There is a tradition that the Knights Hospitallers had a house here, but no record of it has been discovered. A Carmelite monastery was founded here about A.D. 1300; and in the fourteenth century a castle was built by the Butler family, which in the civil war of Charles I. was garrisoned by the Royalists and taken by the Parliamentary forces. Of these buildings there are some remains: a tower and some part of the north transept of the church of the monastery stand on the east side of the Suir; and there are considerable portions of the walls of the castle, inclosing an extensive area, and flanked by towers, some round, others square. There were not long since (and perhaps still are) some remains of St. Mary's church, built in the fifteenth century, and very

much dilapidated; there is an extensive mansion, formerly belonging to the earls of Llandaff, now converted into a barrack. There are a neat modern church, a handsome Roman Catholic chapel, which is the cathedral of the Catholic archbishop of the diocese of Cashel and Emlly, a Roman Catholic college, two nunneries, one of Ursulines, the other of the order of the Presentation, a Baptist meeting-house, a good market-house, a small barrack for infantry, a neat sessions-house, a well-arranged bridewell, and a dispensary. Considerable trade is carried on in the town: there are two market-days in the week, a monthly fair, and three yearly fairs: the sale of corn in the market is considerable; the wheat sold in the year increased from 30,400 barrels in 1826 to 50,600 in 1835; and that of barley from 9400 barrels in 1826 to 11,000 in 1835: that of oats had continued stationary at from 3000 to 4000 barrels. Some brewing and tanning are carried on. There were, by the Parliamentary Returns of 1835, seventeen schools; including one of 300 girls, taught by the nuns of the Presentation convent; a boarding-school of 60 girls, and a day-school of 120 girls, kept by the nuns of the Ursuline convent; a day-school with an average attendance of 200 boys, under the direction of the Religious Brothers; and a day-school under the superintendence of the curate of the established church and some of the parishioners, with nearly 40 children.

Tipperary is in the barony of Clanwilliam, 110 miles south-west of Dublin, and 23 miles west-north-west of Clonmell. A monastery for Frenites of the rule of St. Augustin was founded here in the reign of Henry III. In the reign of Edward III. (A.D. 1329), the town was burned by the natives under Brien O'Brien. Its former importance is indicated by its having given name to the county, and by the fact of its having been antiently incorporated; but it no longer possesses the same relative importance, and the corporation has long ceased to exist. The town is chiefly in the parish of Tipperary, but extends into those of Curdangan and Kilshane; it had, in 1831, 988 houses inhabited by 1244 families; 36 houses uninhabited and 18 building; with a population of 6572: the whole parish of Tipperary had 1113 houses, inhabited by 1379 families; 36 houses uninhabited, and 16 building; with a population of 7936.

The town of Tipperary stands near the little river Arra, which flows into the Suir, and consists of one principal street, from which smaller streets branch off at right angles. Several of the houses are well built, and of handsome appearance: many old buildings have been taken down and new ones erected in their place, so that the town has a neat and thriving appearance. The inhabitants are supplied with water from a public fountain. The church is a modern structure, and there is a Roman Catholic chapel. There are some remains of the Augustinian monastery, chiefly consisting of an arched gateway in front of the building occupied by Erasmus Smith's classical school, which has obtained from this circumstance the popular designation of 'the abbey school.' The principal trade is in butter, of which a large quantity is sent to Limerick and to Waterford for exportation. There are two weekly markets (for which there are a neat market-house with a news-room over it, in the centre of the town, and shambles and four yearly fairs. The sale of wheat is small; but it had increased in the ten years from 1826 to 1835, from 1125 to 3160 barrels; that of oats had increased from 7708 to 10,675 barrels; but the sale of barley had declined from 610 to 256 barrels. There are a dispensary, a fever hospital, a temporary barrack, and a small bridewell: a portion of the county constabulary are stationed here. There were in Tipperary parish, according to the return made to parliament in 1835, nineteen schools of all kinds, including a classical boarding-school on Erasmus Smith's foundation (the Abbey School, with about 30 scholars, another school on the same foundation with about 34 children, boys and girls, and national schools for boys and for girls, attended each by about 110 scholars. Kilshane parish had no school, and Curdangan only one, a hedge-school, with 24 scholars in winter and about 70 in summer.

Burris-o'-Leagh, or Burrisillegh, is in the parish of Glankeen, in the barony of Kilmacanagh, 92 miles south-west of Dublin. It had, in 1831, 219 houses, inhabited by 260 families, 14 houses uninhabited and 4 building, with a population of 1304. The parish church and the Roman Catholic chapel are both in the town. There is a small

brewery: three yearly fairs are held, one of them a considerable fair for pigs. A body of the county constabulary are posted in the town, and there is a dispensary. There were (*Parl. Returns*, 1835) in the whole parish 20 schools, including three national schools, with an average attendance of from 210 to 220 children: and a school with 23 children, partly supported by private contributions.

Burris-o'-Kane, or Burris-o'-Kean, or Burris-o'-Kane, is in the barony of Lower Ormond, 91 miles west-north-west of Dublin. The town had, in 1831, 206 houses inhabited by 217 families; 14 houses uninhabited and 1 building, with a population of 1185: the whole parish had 465 houses inhabited by 477 families, 24 houses uninhabited and 1 building; with a population of 2634. The town has been much improved of late years; many new houses have been built. There are a Roman Catholic chapel and a Wesleyan chapel, besides the parish church, a plain modern building; a dispensary and fever hospital, and a small bridewell. There are some remains of a square castle of ancient construction, called Tumbriane. Four fairs are held in the year. There were in the parish, by the return of 1835, six schools, including three free-schools, one with about 100 children, connected with the Baptist Irish Society, another with 30 boys, in connection with the Society for countenancing Vice; and a third, with an average attendance in summer of 80 girls, supported by private subscription.

CloghJordan is in the parish of Modereny, in the barony of Lower Ormond, nearly 90 miles west-north-west of Dublin. It had, in 1831, 129 houses inhabited by 165 families, 6 houses uninhabited and 3 building, with a population of 824. There are a district church of the establishment, of light and elegant architecture, built in 1830; and meeting-houses for Baptists, Wesleyans, and Primitive Methodists; also a dispensary and fever hospital. There is a considerable distillery. Three yearly fairs are held. A society for the relief and diminution of pauperism, called 'the deacons' poor fund,' exists in the town and the adjacent parishes. There were no schools in the district parish of CloghJordan in 1835; but in the parish of Modereny there were five day-schools, including two parochial schools, one with about 50 boys and the other with about 60 girls; there were also three Sunday-schools for religious instruction.

Golden is in the parish of Reliekmurry, or Rielickmurry, in the barony of Clanwilliam, about 102 miles S.W. of Dublin, between Cashel and Tipperary. There were, in 1831, in the town, 101 houses inhabited by 105 families, 2 houses uninhabited, and 5 building; with a population of 684. It is a neat and improving place, situated in the Golden Vale, one of the most fertile districts of the county, and is divided into two parts by the river Suir, over which is a stone bridge. It has the ruins of an old castle, and in the neighbourhood are the remains of Athassel Augustinian Abbey, originally one of the most splendid ecclesiastical structures in the kingdom; the ruins are extensive and worthy of notice. The parish church and a Roman Catholic chapel are in the town. There are flour and oil mills; and four fairs are held yearly. There is a dispensary. A body of the county constabulary are posted here. The united parishes of Reliekmurry and Athassel had, in 1835, six day-schools; one, with 60 children, partly supported by Lady Elizabeth Mathew.

Littleton is in the parish of Borrisleigh, in the barony of Eliogarty, 90 miles S.W. of Dublin. It contained, in 1831, 44 houses inhabited by 54 families, 3 houses uninhabited and 1 building; with a population of 283. It is a place quite of modern origin, chiefly erected by the late Rev. Thomas Grady. The parish-church, a handsome building, is in the town; and there is also a dispensary: a body of the county constabulary are stationed here. There were, in 1835, five day-schools; one of them was the parochial school with about 30 children; one of the others was held in a school-room erected by subscription.

New Birmingham is in Killooley parish, in the barony of Slievardagh, 95 miles S.W. of Dublin. This town was its origin to the late Sir Vere Hunt, who obtained patents for two weekly markets and twelve yearly fairs; but they have been discontinued, and the place is comparatively deserted. There are a Roman Catholic chapel and a small prison. There were, in 1831, 48 houses inhabited by 62 families, and 1 house uninhabited; with a population of 298.

port is in Kilvolane, or Killevolane, parish, in the barony of Owney and Arra, 109 miles S.W. of Dublin, on the road to Limerick. It had, in 1831, 127 houses inhabited by 162 families, 24 houses uninhabited, and 125 acres; with a population of 852. The houses are for the most part neatly built. The parish-church is in the town and there are a Roman Catholic chapel, a bride-dispensary, and infantry barracks. There are four fairs, one of them a large cattle-fair.

There is a fair in Templechally, Temple Ichally, or Temple-arish, in the barony of Owney and Arra, on the banks of the Shannon, near where it leaves Lough Derg, and the Killaloe. This village is connected with Killaloe, and it may be considered as a suburb, by a bridge of five arches over the Shannon. The population of the town in 1831, was 832. There is a Roman Catholic chapel, and a body of the county constabulary are posted there. There is a yearly fair for pigs. Near the bridge remains of a castle erected to defend the passage over the river.

There is a fair in the barony of Clanwilliam, near the western extremity of the county, about 9 miles west of Tipperary. It is of great antiquity. An abbey of regular canons of the order of Austin was early founded here; and the town subsequently became the seat of a bishop's see. Some prelates appear to have exercised temporal power as well as spiritual; and one of them in particular, in the 13th century, distinguished himself as a warrior and a statesman. King John granted to the town the privilege of holding markets and fairs; but the privilege of holding a market, if ever used, is now disused. The diocese was bounded to that of Cashel A.D. 1568, and the removal of its cathedral seat caused the decline of the place. It had, in 1831, a population of 701. A body of the county constabulary are posted here; and there are two yearly fairs. The parish-church is in the village, and there is a Roman Catholic chapel. There are the ruins of a church and a large stone cross. Some antiquities have been discovered in the neighbourhood.

There is a fair in Kilvemnon parish, in the barony of Upper Ormond, on the road between Callen and Fethard; and between Carrick-on-Suir and the Killenaule tract, so that it is a common resting-place for drivers in their way from Carrick. A considerable quantity of butter is sold here in a weekly market (the place ranks only as a village), held on Thursdays sent to Kilkenny, Clonmell, or Carrick. There are several well-attended yearly fairs for cattle and sheep, and a body of the county constabulary are posted there. There are a Roman Catholic chapel and a dispensary.

The population of the village, in 1831, was 701.

Mines are in the parish of Kilmore and the barony of Upper Ormond, about 5 or 6 miles south of Nenagh. The foot of the north-western slope of the county, and takes its name from the lead-mines formerly worked, the produce of which yielded an unusual quantity of silver. The population, in 1831, was 791. The houses are neatly built: the parish church and a Roman Catholic chapel are in the village, and there are several yearly fairs.

There is a fair in the barony of Upper Ormond, between Nenagh and Carrick-on-Suir, and a body of the county constabulary are posted there. There are a Roman Catholic chapel and a dispensary in the village. There are at least two yearly fairs, and a body of the county constabulary are posted there.

Divisions for Ecclesiastical and Legal Purposes.—This division was formed at what is commonly deemed to be the establishment of counties in Ireland, by King Henry II. in 1210: though Sir James Ware has shown that some or some equivalent divisions must have existed at that time. The county was subsequently enlarged by the annexation of what was called 'Cross-Tipperary,' a division having a sheriff and other officers distinct from the county. Antient records speak of the 'Vice-Comes Tipperary.'

It contains the whole or part of a hundred and sixty parishes. (*Pop. Returns for 1831.*) These parishes are either wholly or are comprehended in one hundred and ninety other ecclesiastical benefices, in several dioceses, as follows:—

Diocese.	Total Number of Benefices.	Rectories and Vicarages.	Perpetual Cures.	Improperiate Cures.	Parishes without cure of souls
Cashel	49	39	2	6	2
Emly	9	7	1	..	1
Killaloe	28	24	2	..	2
Lismore	22	20	..	1	1
Meath	1	1
	109	91	5	7	6

Cashel was an archbishopric, having in its province the united dioceses of Cashel and Emly, the diocese of Cloyne, the united dioceses of Cork and Ross, of Killaloe and Kilfenora, of Limerick, Ardferd and Aghadone (which last two were incorporated), and of Waterford and Lismore. By the Act 3 and 4 William IV., c. 37, a further union of the dioceses of Cashel and Emly with Waterford and Lismore was enacted, to take place on the next avoidance; and this union has now been effected. The greater part of the county is in this united diocese. The same Act deprived Cashel of its archiepiscopal rank, on the decease of the then existing holder of the see, and added the province to that of Dublin: this change has been effected. The only part of the county in the diocese of Meath is the parish of Eglishe, which is partly in this county and partly in King's County, and is comprehended in the ecclesiastical union of Fircal. The diocese of Meath is in the ecclesiastical province of Armagh; but with the exception of the small part included in that diocese, the rest of the county is in the ecclesiastical province of Dublin.

In the Roman Catholic church the archbishop of Cashel retains his dignity, and is primate of Munster. His cathedral is at Thurles. His province includes the united dioceses of Cashel and Emly, of Cloyne and Ross, and of Waterford and Lismore, and the dioceses of Cork, Kerry, Killaloe, and Limerick. In which of these dioceses the county is included we have no means of ascertaining exactly; but the greater part, if not the whole, is included in those of Cashel and Emly, Killaloe, and Waterford and Lismore.

The county is included in the Leinster circuit; the assizes are held at Clonmell: the county-gaols are at Clonmell and Nenagh, the latter very lately erected; and there are bridewells at Cahir, Clogheen, Tipperary, Cashel, New Birmingham, Thurles, Templemore, Roscrea, Nenagh (we are not sure if this is continued since the completion of the county-gaol), Burris-o'-Kane, Newport, and Carrick-on-Suir. The county-gaol at Clonmell comprehends a gaol, house of correction, and sheriff's-prison: the house of correction is under very good management; the silent system of prison discipline is acted upon, the prison not being adapted for the introduction of the separate system. Considerable improvements had been made in the sheriff's-prison according to the 'Nineteenth Report of the Prison Inspectors' (1841), the last we have seen; but a complete system of discipline could not be introduced until the removal of part of the prisoners to Nenagh gaol, which was not then completed. The bridewells are many of them in a bad state; those of Cahir, Cashel, and Templemore are miserably dilapidated, and that at Cahir very badly managed; those of New Birmingham, Burris-o'-Kane, and Tipperary, insecure and altogether insufficient: Carrick bridewell, though new, is badly finished and ill-managed by the keeper; and that at Clogheen, though in tolerable good order, falls very far short of the well-regulated bridewells of other counties: those of Newport, Nenagh, Roscrea, and Thurles (the last a large prison) are in good order. (*Inspectors' Report, 1841.*) It is stated in a note to that Report, that great improvement has been made in several of these prisons since the inspectors' visit.

The number of criminal offenders committed for trial in 1839 was 2110, being greater than in any county of Ireland, except the metropolitan county (including the city) of Dublin; and more than twice as great as in any other county, except only Cork (including the city of Cork); Galway (including the town of Galway); Limerick (including the city of Limerick), and Kerry; and of these the only one which approached it was Cork (1932 commitments), which had more than twice the population; the others barely exceed half the number in Tipperary, though Galway rather exceeds it in population; Limerick has about three-fourths of the population of Tipperary, and Kerry nearly two-thirds. So far therefore as the number

of committals is a test of the state of crime, Tipperary that year exceeded all other counties in Ireland, except that of Dublin, and in most cases very far exceeded them. Of the 2110 persons committed, 946 were convicted, and 1164 acquitted or discharged; 9 of the convictions were for capital offences, and 4 of the criminals were executed. In 1840 the number of committals was 1642, the county still retaining, or nearly so, its unhappy pre-eminence: of the persons committed, 718 were convicted, and 924 acquitted or discharged; 5 of the convictions were for capital offences, but no persons were executed. A large proportion of the offences were murders, manslauughters, assaults, riots, and other violent offences, indicative of the prevalent tendency to disturbance and insubordination.

The county returns two members to parliament, who are elected at Clonmell; and one member each is returned from the borough of Clonmell and the city of Cashel. The number of registered electors for the county in February of each of the years 1835, 1837, and 1841, was as follows:—

	50l. Free-holders.	20l. Free-holders.	10l. Lease-holders.	10l. Free-holders.	10l. Lease-holders.	Holders of a rent-charge.	Total.
1835	600	361	2	1459	2	1	2485
1837	854	437	15	1773	51	5	3135
1841	792	316	13	1217	120	44	2502

The number of voters in Clonmell and Cashel, in the same three years, was as follows:—

CLONMELL.				
	10l. Household-ers.	5l. Household-ers.	Freemen.	Total.
1835	601	..	84	685
1837	699	..	96	795
1841	587	..	100	687

CASHEL.				
	10l. Household-ers.	5l. Household-ers.	Freemen.	Total.
1835	302	..	6	308
1837	353	353
1841	267	267

Before the Union the county returned eight members to the Irish parliament, namely, two for the county itself, and two each for Clonmell, Cashel, and Fethard, but the last was disfranchised at the Union, and Cashel and Clonmell reduced to one member each: no change in the number of members was made by the Reform Act.

The amount of grand jury presentments for the years 1839 and 1840 was as follows:—

	1839.			1840.		
New roads, bridges, &c.	£ 2,219	13	5	£ 3,165	13	0
Repairs of roads, &c.	19,871	17	7	24,831	8	1
Court and Sessions houses, erection and repairs of	950	0	0	6,093	10	0
Gaols, bridewells, &c., erection and repairs of	3,999	17	1	4,698	0	11
County gaol and bridewell, and prison expenses	6,776	8	1	8,001	13	2
Salaries to officers in gaols	237	0	8	302	13	0
Constabulary police, payments to witnesses, &c.	17,195	11	2	17,537	15	4
Salaries to county officers, collectors' poundage, &c.	5,074	3	3	5,548	6	1
Public charities	6,408	17	1	7,423	18	1
Repayments to government	1,959	1	11	2,307	11	9
Miscellaneous	2,834	13	7	2,338	13	6
	£67,527	3	10	£82,249	2	11

The county constabulary on the 1st January, 1840, and 1841, consisted of the following:—

County	Sub-Inspectors.	Sub-Inspectors.	Head Constables.	Constables.	Constables.	Sub-Constables.	Horses.
	1st rate.	2nd rate.	1st rate.	2nd rate.	1st rate.	2nd rate.	
1840	2	4	4	5	2	15	109
1841	2	3	7	3	2	14	122

The whole expenditure on the constabulary force in the year 1839 was 36,276*l.* 9*s.* 1*d.*, and in 1840, 36,595*l.* 15*s.* 10*d.* The amount of the constabulary force and the cost of maintaining it are greater than in any other county in Ireland.

There is a county lunatic asylum at Clonmell; which in the year from March, 1840, to March, 1841, contained 94 patients, and was maintained at an expense of 2227*l.* 3*s.* 3*d.*, or 2*3*s.** 6*d.* for each patient. There is a county in-

firmery at Clonmell, into which the following number of patients were admitted:—

	In-Patients.	Out Patients.	Total.
1835	322	4386	4708
1836	278	4759	5037
1837	328	7760	8088

There are fewer hospitals at Burris-o-Kane, Caher, Carrick-on-Suir, Cashel, Clogheen, Clonmell, Cloghane, Nenagh, Roscrea, Templemore, and Tipperary: and dispensaries at Ballingarry, Ballymackay, Ballymore, and Kilcooley, Ballyporeen, Birdhill, Bourney, Burris-o-Kane, Burris-o-Kane, Caher, Cappaghwhite, Carrick-on-Suir, Clogheen, Clonmell, CloghJordan, Drangan, Fethard, Fethard, Golden, Grangemockler, Killenale, Killenale, Littleton, Lorrha, Mullinahone, Nenagh, Newcastle, Newport, Portroe, Poulmuca, Roscrea, Rosegreen, Silverman, Templemore, Templetuohy, Thomastown, Thurles, Tipperary, and Toomavara.

History and Antiquities.—Sir James Ware supposes that the Coriandi (*Kopivdov*) and the Udine, or rather Uodine (*Uodina*), of Ptolemy, occupied this county and the adjacent ones to the west and south-west. We think it not improbable that the Brigantes (*Boiyavris*) may have occupied the south-eastern parts, while the Uodine occupied the south-western.

In the division which prevailed before the English conquest the following territories are noticed by Sir James Ware as corresponding to portions of this county:—

Aradh-Cliach: probably the half-barony of Arna, in the western part of the county, on the bank of Lough Derg and of the Shannon.

Corca-Eathruch: the territory round Cashel, comprehending part of the Vale of Goulin, or Golden Vale. Some writers consider the territory of North Desies to be identical with this.

Eoganacht: a name common to a sept or clan, the territory occupied by them near Thurles.

Hy-Fogarta: the country of the sept of O'Fogarty the neighbourhood of Thurles.

Hy-Kerin: the country of the sept of O'Meagher. This territory has retained its name with little alteration, being now the barony of Ikerin.

Muscraige-Thire, or *Muscraige-Thire*: the country the sept of Kennedy, now the baronies of Upper and Lower Ormond, a name which signifies East Munster.

In the early periods of Irish history these territories appear to have been divided between the kingdom of Thomond or North Munster, governed by princes of the Dalcassian race; and Desmond, or South Munster, held by princes of the Eoganacht or Eugenician family; the princes of which two kingdoms appear to have possessed in alternate succession the paramount dominion of Munster. Early in the ninth century, soon after the landing of the Northmen or Danes (or as they are usually termed in Irish history, from the position of their original country with reference to Ireland, the Ost-men, or East-men under their king Turgesius, Feidlim Mac-Crimthan, king of Desmond, held the paramount sovereignty of Munster. The capital of his kingdom was Cashel. His course, which was one of violence and tyranny, was marked by success; he was victorious over the chieftains of Connaught and over the king of Meath, the nominal sovereign of all Ireland. At the commencement of the tenth century the regal and sacerdotal characters were united in Cormac MacCulinan, bishop of Cashel and king of Munster, of the Eoganacht race. He was not the first of his family in whom these characters had been combined. In 907 he defeated Flann-Siona, king of Meath and titular monarch of Ireland, on the heath of Moylena, in King's County; but having attempted to enforce the tribute which the people of Leinster had been compelled reluctantly to pay to the kings of Munster, he was defeated and slain (A.D. 906) by the Leinster forces, supported by the monarch of Ireland and the princes of the northern part of the island. Cormac built a chapel at Cashel, which still retains his name, and was the reputed author of the history commonly called 'The Psalter of Cashel.'

Callachan, who was king of Cashel towards the middle of the tenth century, appears in the history of this tract as an active but unprincipled warrior. He was rendered by his own subjects into the hands of Murkertach, heir apparent to the monarchy of Ireland. In the latter part of the same century the throne of Munster was occu-

pled successively by Mahon and his brother Brian Boromh, or Boruimhe, or Boru, two princes of the Dalcassian family, the latter of whom acquired the monarchy of Ireland. At the commencement of the twelfth century (A.D. 1101) Murkertach, king of Munster, gave over the city of Cashel to the church, dedicating it to God and St. Patrick. The holders of the see of Cashel had previously assumed the rank of archbishops.

In the English invasion, Henry II. (A.D. 1172) summoned an assembly of the Irish prelates and princes at Cashel, where the sovereignty of the English king was recognised, and various regulations made, increasing the power of the clergy, and more completely assimilating the practices of the Irish church to those of the church of Rome. Tipperary, or part of it at least, seems to have remained under the dominion of Donald of the sept of O'Brien, native prince of Thomond and Ormond, subject to the nominal sovereignty of the English king. In the irregular warfare which followed Henry's departure from Ireland, a body of Anglo-Normans under Richard, earl of Strigul, surnamed Strongbow, and governor or commander in Ireland, and of Hervey of Mount-Morris, entered the county (A.D. 1174) to attack Donald O'Brien, and advanced as far as Cashel, where they were to be joined either by a detachment from the Anglo-Norman garrison of Dublin or by a body of Ost-men from that city: but this detachment was surprised near Thurles by Donald, and put to the sword almost without resistance; and Strongbow and Hervey retreated to Waterford. The invaders appear to have crossed the county again the same year, in their march to Limerick (which was also under the dominion of Donald), which they succeeded in taking. In A.D. 1175 a considerable Anglo-Norman force with a body of native allies entered the county under Raymond Le Gros, marching to the relief of Limerick, to which Donald O'Brien had laid siege. The Irish, hearing of their approach, advanced, and entrenched themselves in a defile near Cashel, where they were defeated with great slaughter: the garrison of Limerick was relieved, and on the banks of the Shannon or of Lough Derg, near Killaloe, the victorious Raymond received the submission not only of Donald O'Brien, but of Roderick O'Connor, titular king of Ireland; and exacted hostages from both for the faithful performance of the engagements into which they entered.

This county was probably included in the grant of the principality of Thomond to Philip de Braosa (A.D. 1177), but the prudence or the cowardice of that noble prevented his dispossessing Donald O'Brien, who still retained possession. In A.D. 1185, while prince (afterwards king) John was in Ireland, sent over by his father, as lord of the island, the Anglo-Normans erected castles at Tipperary and Ardfinnan in this county; that of Ardfinnan was however soon taken by Donald, who, in A.D. 1190, defeated the Anglo-Normans under William, earl-marshal (who had married Strongbow's only child and succeeded to the Irish estates of that nobleman) near Thurles. Donald died A.D. 1194. The oldest part of the present cathedral of Cashel was built by him. Tipperary appears to have passed in the course of a few years afterwards into the hands of the Anglo-Normans, as it was one of the counties erected by King John (A.D. 1210), during his expedition to Ireland, at the head of a considerable army. It is probable that the northern part at least of the county was part of the seat of war (A.D. 1274-1277) between the O'Briens, who retained a portion of Thomond, and the Anglo-Norman, or as we may now term them, Anglo-Irish family of the De Clares.

It is probable that the Scots and their Irish allies were in this county (A.D. 1317) in the invasion of Ireland by Edward Bruce and his brother King Robert, since they ravaged the country from Kilkenny as far as Limerick. In A.D. 1323 the royal privileges in the county were granted to James Butler, earl of Carrick, now created also earl of Ormond; these royalties were long retained by the earls of Ormond. In A.D. 1330 Brien O'Brien, prince of Thomond, ravaged the county and burned the towns of Athassel (near Cashel) and Tipperary to the ground. In the period of anarchy which was contemporaneous with the war of the Roses in England, and continued long after that war was closed, the county was included in the scene of the frequent contests between the rival septs or families of the Geraldines, to which belonged the earls of Desmond and Kildare, and of the Butlers, at the head of which was

the earl of Ormond. The burning of the cathedral of Cashel was one of the charges brought against the Earl of Kildare in his examination before the privy council (A.D. 1496). His reply to the charge was characteristic: 'Spare your evidence,' said he; 'I did burn the church: for I thought the bishop had been in it.'

In the great civil war in 1642, Clonmell, Cashel, Carrick-on-Suir, Fethard, and all the other towns in Tipperary, were seized by the insurgents, or, as they were termed, 'the Confederates,' almost at the first outbreak in the central and southern provinces. At Cashel, Fethard, and Silvermines there were some murders committed: those at Cashel were perpetrated by the relatives of some persons recently put to death by Sir W. St. Ledger, president of Munster, who had previously entered the county with two troops of horse and exercised great severity. The Earl of Inchiquin, who commanded in Munster for the parliament, invaded the county A.D. 1647, took Cahir by capitulation, and stormed Cashel, where he mercilessly slaughtered twenty priests and an unresisting multitude who had taken shelter in the cathedral. He levied contributions in all the neighbourhood, and was prevented from taking Clonmell only by want of provisions. When Cromwell invaded Ireland, and (A.D. 1649) was opposed by the Royalists and Confederates, now united under the Earl of Ormond (to whom Lord Inchiquin, shocked at the execution of the king, had joined himself), a detachment from his army took Carrick-on-Suir, where Cromwell himself crossed the river to besiege Waterford. A body of Royalists under Lords Inchiquin and Taafe, attempting to retake Carrick (24th October), was repulsed with severe loss. Ormond with the main body of his army was about this time near Clonmell watching Cromwell, whom sickness and the approach of winter obliged to raise the siege of Waterford; soon after which Ormond withdrew to Kilkenny, having posted a considerable body of Ulster men at Clonmell.

About the latter end of February, 1650, Cromwell opened the campaign by taking Cahir, Cashel, Fethard, Ologheen, and other places in this or the adjacent counties; and in the course of the following April laid siege to Clonmell. This siege cost him more trouble and loss than any other part of his Irish expedition: he lost above 2000 men in a fruitless assault; however after a siege of two months, the place was obliged to surrender for want of ammunition: the garrison had previously withdrawn to Waterford without Cromwell's knowledge, and the townsmen obtained good conditions, Cromwell supposing that the garrison was still in the town. In 1651 Ireton, who was after Cromwell's departure, general-in-chief for the parliament, concentrated his army at Cashel and marched to the bank of the Shannon, over which he forced a passage at Killaloe. On the restoration of royalty in Ireland, which rather preceded its restoration in England, Clonmell was one of the towns occupied by the Royalists.

In the war of the Revolution Clonmell was abandoned by the Jacobites on William's advance toward the south, after the battle of the Boyne (A.D. 1690). William, after his unsuccessful siege of Limerick, retired with his army to Clonmell, and there leaving them, proceeded to Duncaannon, and embarked for England.

In the rebellion of 1798 this county was not involved; and though it has been the scene of much agrarian disturbance, there has been no serious outbreak to require particular record.

(*Map of Ireland*, by the Society for the Diffusion of Useful Knowledge; *Second Report of the Irish Railway Commissioners*; *Geological Transactions*; Lewis's and Carlisle's *Topographical Dictionaries of Ireland*; *The Traveller's New Guide through Ireland*; *The Scientific Tourist in Ireland*; *Parliamentary Papers*; Ware's *History and Antiquities of Ireland*; Cox's *Hibernia Anglicana*; Moore's *History of Ireland*; Gordon's *History of Ireland*; Dr. W. C. Taylor's *Civil Wars of Ireland*; &c.)

TIPPOO SAIB, sultan of Mysore, was born in the year 1749. His father Hyder Aly Khan [HYDER ALY], sensible of the disadvantages under which he himself laboured from want of education, procured for his son the best masters in all the sciences which are cultivated by the Mohammedans. But Tippoo, although he had acquired a taste for reading, did not make any considerable progress, and he preferred martial exercises, into which he was initiated at an early age. The French officers in the employment of his father instructed him in tactics: and in 1767, when

Hyder Aly overran the Carnatic, Tippoo was entrusted with the command of a corps of cavalry. He was at that time nineteen years of age; but the success with which he carried on the war in the neighbourhood of Madras sufficiently proved how much he had profited by his European teachers. During the war with the Mahrattas, which lasted from 1775 to 1779, Tippoo acquired the universal esteem of the army; and he rose so high in the favour of his father and his counsellors, that the left division of the Mysore army, consisting of 18,000 cavalry and 6000 regular infantry, was put under his command. With this force Tippoo attacked Colonel Bailey in the neighbourhood of Perimbakum, on the 6th of September, 1780. He was obliged to retire; but on the 10th of the same month an engagement, in which Tippoo Saib is said to have taken an active part, ended in the entire defeat of the English army. The whole of the war in the Carnatic gave him opportunities of perfecting himself in the art of war; and on the 18th of February, 1782, he showed his skill in the attack and complete defeat of Colonel Braithwaite, on the banks of the Kolerun. This was undoubtedly his greatest stroke of generalship. A few months afterwards he was obliged to move towards the south, in order to meet the English troops in the provinces of Tanjore and Malwa, under the command of Colonel Humbertson. On the 20th of November Tippoo found the English at Paniyan. He made a vigorous attack, but was repulsed and compelled to retreat. He crossed the river Paniyan, and prepared himself for another engagement, when, on the 11th of December, 1782, he received intelligence of the death of his father. On the 20th he was at Seringapatam, where he mounted the musnud without much display or ceremony. He had scarcely performed the funeral rites of his father when he returned to Arcot, and assumed the command of his army. But whilst he was engaged in the Carnatic General Matthews took Onore, and the country of Bednore was in the hands of the English. In order to regain these more valuable possessions, Tippoo was obliged to relinquish his conquest in the Carnatic, and by the end of March, 1783, scarce a Mysorean was left in that country. His operations were so rapid and successful, that on the 28th of April Tippoo Saib had already reduced the garrison of Bednore to the necessity of capitulating. General Matthews and several of the principal officers were barbarously put to death. After the reduction of this city, it was Tippoo's object to repossess himself of Mangalore, the principal seaport in his dominions. But the place was well defended; and in the midst of his preparations for the assault accounts were received in the camp of peace having been concluded between England and France. It was early in July, 1783, when M. de Bussy, in consequence of this news, declined to act any longer against the English. He quitted the camp with his detachment. A considerable reinforcement having arrived under General Macleod, Tippoo agreed to a suspension of arms; and early in the year 1784 Sir George Staunton and two other ambassadors from Madras arrived in the camp, and on the 11th of March a treaty of peace, which stipulated for the liberation of all the prisoners and the restitution of all places taken by either party during the war, was concluded. About the end of the same year Tippoo concluded a treaty of peace with the court of Poonah. He then returned to Seringapatam, and assumed the title of Sultan, thereby throwing off all dependence on or allegiance to the captive Raja (imprisoned by his father) or the Great Mogul.

In 1786 he occupied himself with internal regulations; and from an inventory made at this period we find that the treasure, jewels, and other valuable articles were estimated at eighty millions sterling. He had also 700 elephants, 6000 camels, 11,000 horses, 400,000 bullocks and cows, 100,000 buffaloes, 600,000 sheep, 300,000 firelocks, 300,000 matchlocks, 200,000 swords, and 2000 pieces of cannon, and an immense quantity of gunpowder and other military stores. His regular army consisted of 19,000 cavalry, 10,000 artillery, and 70,000 infantry. He had also 5000 rocket-men, and 40,000 irregular infantry.

During the years 1787 and 1788 the attention of the Sultan was principally engaged in the conversion and subjection of the Nairs, or chiefs of Malabar. He is said to have carried away from that province 70,000 Christians, and to have made Mussulmans of 100,000 Hindus. This he effected by forcible circumcision, and compelling them to eat beef.

It was about this time that he published an edict for the destruction of all the Hindu temples in his dominions, excepting those of Seringapatam and Mail Chinn. Fortunately his officers did not enforce this barbarous prohibition.

Although Tippoo Sultan did not show any overt hostility toward the English after he had signed the treaty of 1784, yet in 1787 he sent an embassy to France, to enter into an offensive and defensive alliance, and to stimulate the court of Versailles to a speedy renewal of hostilities with England. The ambassadors returned to Seringapatam in the month of May, 1789, without having obtained their object. The disappointed Sultan vented his rage by putting two of them to death as having betrayed his interests. Tippoo hated the British power in India, and he took every opportunity to annoy such of the native kings as were under its protection. The Raja of Travancore had by the treaty of Mangalore stipulated for the security of his territories. In April, 1790, Tippoo invaded the country and subjected the whole of the northern district. The reasons assigned by Tippoo for the infraction of the terms of the treaty were that two forts, Cranganore and Jyacotta, which were on the northern boundary of the Raja's possession, had belonged to his father. This aggression was considered by the English equivalent to a declaration of war, and Colonel Hartley was sent with a considerable detachment to the assistance of the Raja. At this intelligence Tippoo withdrew his army from Travancore, and returned to Seringapatam, when, to his dismay, he heard that the Mahrattas and the Nizam had procured the English a zealous co-operation with their forces.

On the 15th of June, 1790, the English troops, under the command of General Medows, entered the Sultan's territory, and took possession of the fort of Carur without resistance. Daraporam and Coimbatore were shortly afterwards reduced. About the same time a detachment, under Colonel Stuart, captured Dindigul and Paligauchery. The movements and operations of the English forces were so well conducted, that Tippoo found himself unable to oppose them, and he resolved to follow the plan of warfare adopted by his father: instead of defending his own territories, to lay waste those of his enemy. This he did with considerable ability; for in the beginning of 1791 the English, instead of being masters of great part of Mysore, as they had expected, found themselves attacked and annoyed in the very neighbourhood of Madras.

On the 29th of January, 1791, Lord Cornwallis assumed the command of the army, and on the 11th of the same month he was at Vellore. On the 21st of March the fort of Bangalore was taken by storm. On this event Tippoo retired to some distance, and wrote to Lord Cornwallis requesting a truce. This was refused, and he proceeded to Seringapatam, leaving his army under the command of some of his generals, to watch the motions of the English. On the 3rd of May Lord Cornwallis was at Arakery, within sight of the Sultan's capital; but his troops had suffered great deal from want of food and forage, and he was compelled to retreat towards Bangalore. The Mahrattas came however to his assistance, and the warfare was carried on with great success.

However, whilst the English were carrying on their successful operations in the north-west part of Mysore, the Sultan made a diversion towards Coimbatore, situated to the south of Seringapatam; and Lieutenant Chaimen, with the whole of his party, were made prisoners. The skill of Tippoo Sultan enabled him to protract the war to the month of February, 1792, when the allies—the English, the Mahrattas, and the troops of the Nizam—encamped in sight of the capital. But it was not until General Abercromby had united his forces to those of Lord Cornwallis, and had determined to take the town by storm, that the haughty mind of the Sultan was humbled. He agreed to give the allies one half of his dominions, and to pay them in the course of twelve months the sum of three lakhs and thirty laes of rupees (3,030,000*l.*), to restore all the prisoners, and to deliver up as hostages two of his sons. Abdul-khalik and Moaz Aldeen were the names of the two princes, and the attention and kindness evinced by Lord Cornwallis towards them were such as to afford the highest gratification to the Sultan, his father. By signing the definitive treaty of the 16th March, 1792, the Sultan lost one half of his dominions. Soon after this the allies quitted the neighbourhood of Seringapatam, and Tippoo sought

he means of replenishing his treasury. This was soon done by imposing exorbitant and extraordinary taxes, which were chiefly levied upon the agriculturists.

Notwithstanding this seeming tranquillity from 1792 to 1796, the Sultan was engaged in inciting all the native chiefs against the British power in India; but it was not until 1798 that the whole extent of his secret machinations and intrigues became known. At the commencement of this year ambassadors were sent from Seringapatam to the Mauritius. Their object was to renew the Sultan's relations with France, and to solicit the aid of 10,000 European and 30,000 negro troops. The proceedings of the embassy were first made known in the month of June to the Marquis Wellesley, the governor-general. About the same time intelligence was received in India of the operations of the French in Egypt. Circumstances like these left no doubt as to the intentions of the Sultan, and on the 3rd of February, 1799, orders were issued for the British armies and those of the allies immediately to invade the dominions of Tippoo. Hostilities commenced on the 5th of March; and, on the 5th of April, General Harris took a strong position opposite the west side of Seringapatam. After besieging the place some time, a general attack was made on the 4th of May, 1799. The Sultan had scarcely finished his repast when he heard the noise of the assault. He instantly repaired towards a breach which the English had succeeded in making a few days before. His troops fled; he endeavoured to rally them; and so long as any of his men remained firm, he continued to dispute the ground against an English column which had forced the breach and gained the ramparts. Finding all his efforts against the enemy fruitless, he mounted his horse, and, in endeavouring to effect his retreat, arrived at a bridge leading to the inner fort; but the place was already occupied by the English, and in his attempts to proceed he was met by a party of Europeans from within the gate, by whom he was attacked. Owing to two wounds which he received in his breast, he fell from his horse; his attendants placed him upon a palanquin, in one of the recesses of the gateway, and entreated him to make himself known to the English. This he disdainfully refused to do. A short time afterwards some European soldiers entered the gateway, and one of them attempting to take off the Sultan's sword-belt, he wounded prince, who still held his sword, made a thrust at him and wounded him in the knee; upon which he soldier levelled his musket and shot him through the head. On the afternoon of the 5th of May he was buried in the mausoleum of Hyder Aly. Four companies of European troops escorted the funeral procession, which was strikingly solemn.

When Tippoo met his death he was in his fiftieth year. He was of dark complexion, and about five feet nine inches high; he had a round face, with large black eyes, and an aquiline nose, which gave much animation and expression to his countenance. Although after his misfortunes in 1792 he oppressed the people more than they had ever been in the time of his father, he was nevertheless very popular; and even now the Mysoreans consider him as a martyr to the faith, and as a prince who fell gloriously in the cause of his religion. He used to pass a great portion of his day in reading, and his library, consisting of about 12,000 volumes, was well selected. About one-half of this collection is preserved at the East India House, London; the other half was left at Fort William for the use of the college. The Museum and the Library of the East India House contain many articles both of value and curiosity which once belonged to Tippoo Saib.

(*Memoirs of Tippoo Sultan*, in Stewart's *Descriptive Catalogue of the Oriental Library of the late Tippoo Sultan of Mysore*, Cambridge, 1809. This is the most authentic account of Tippoo's life.)

TIPTON. [STAFFORDSHIRE.]

TIRABOSCHI, GIROLAMO, born at Bergamo in 1731, studied in the college of Monza, and afterwards entered the order of the Jesuits. About 1766 he was made professor of rhetoric in the university of Milan, where he wrote his first work, the history of a monastic order long since suppressed, under peculiar circumstances: *Vetera Humiliorum Monumenta*, Milan, 1766. In 1770 he was appointed by the duke of Modena librarian of his rich library, in the place of Father Granelli, deceased. He now applied himself to the undertaking of his great work, *Storia della*

Letteratura Italiana, published at Modena, 1772-1783, which he completed in eleven years. The subject was vast and intricate; the only author who had yet attempted to write a general history of Italian literature, Gimma of Naples, had only sketched a rough and very defective outline of it in his *Storia dell'Italia Letterata*. There were however local histories and biographies concerning particular towns and districts, and the rest of the materials had to be sought among the archives and libraries of Italy. Tiraboschi undertook to write the history of the literature of ancient and modern Italy in the most extended sense of the word, including most of, if not all, the individuals deserving of mention in every department of learning, who have flourished in Italy, from the oldest times on record, beginning from the Etruscans and the Greek colonies of Magna Græcia and Sicily, and then proceeding with the history of Roman literature through its rise, progress, and decay, down to the invasion of the northern tribes, with which the second volume concludes. The author distributes the great divisions of learning in separate chapters; poetry, grammar, oratory, history, philosophy, medicine, jurisprudence, and the arts; he gives an account of the principal libraries, and of the great patrons of learning, and although he does not profess to write biography, properly speaking, yet he gives biographical notices of the more illustrious writers and of their productions. The third volume comprises the literary history of Italy during the dark ages, as they are commonly called, from the fifth to the twelfth century. The author makes his way through the scanty and obscure records of those times, and brings to light much curious information concerning the intellectual state of Italy under the Goths, the Longobards, and the Franks. The ecclesiastical writers come in for a great share of this part of the work. The fourth volume includes the period from 1183 to the year 1300. The revival of studies, the formation of the Italian language, the foundation of universities, notices of the civilians and canonists who flourished in that age, an account of the Italian troubadours, of the earliest Italian poets, and of the Italian Latinists, and a view of the splendid architectural works of Arnolfo di Lapo, of Niccolò and Giovanni of Pisa, and other artists, impart a cheering aspect to this period. The fifth volume embraces the 14th century, the age of Dante, Petrarca, and Boccaccio. The author is particularly diffuse in speaking of Petrarca. The sixth volume concerns the 15th century, an age of classical studies; the age of Cosmo and Lorenzo de' Medici, of Poggio, Filelfo, Niccoli, Palla Strozzi, Coluccio Salutati, Paolo Manetti, Cardinal Bessarion, and other collectors of MSS., founders of libraries, and encouragers of learning, and the age also of distinguished jurists and ecclesiastical writers. This volume is very large and is divided into three parts, whilst the preceding volumes are divided each into two parts, each part being subdivided into books and chapters. We cannot help thinking that this mode of division is too formal and cumbersome, and that it might have been simplified and made clearer.

The seventh volume of Tiraboschi's history treats of the 16th century, the age of Leo X., the Augustan age, as it is sometimes called, of Italian literature. This volume, which is still more bulky than the one preceding, is divided into four parts. After giving a sketch of the general condition of Italy during that period, of the encouragement to learning afforded by the various princes, of the universities, academies, libraries, and museums, the author treats first of the theological polemics which arose with the Reformation, then of the philosophical and mathematical studies, of natural history and medicine, of civil and ecclesiastical jurisprudence, of historical writing, and of the Italian Hellenists and Orientalists. He passes next in review the Italian poets, among whom Ariosto and Tasso hold a conspicuous place, and afterwards the Latin poets, the grammarians, rhetoricians, and pulpit orators, and lastly the artists, among whom Michael Angelo, Raffaello, Tiziano, and Correggio stand prominent. It is impossible to peruse this long list of illustrious names without being struck with the seemingly inexhaustible fertility of the Italian mind in almost every branch of knowledge.

The eighth volume embraces the 17th century, which in Italy is scornfully styled the age of the 'seicentisti,' or the age of bad taste, a reproach however which applies mainly to the poets, and not even to the whole of them. The department of history is filled with good names, as well as

that of the mathematical sciences, in which Galileo holds the first rank. With the 17th century Tiraboschi concludes his work. Various reasons prevented his entering the field of contemporary history. This however has been done of late years by Lombardi, in his continuation of Tiraboschi's work: 'Storia della Letteratura Italiana nel Secolo xviii.'

Tiraboschi's work was highly esteemed, and went through numerous editions in various parts of Italy. The author himself superintended the second edition of 'Modena,' 1787-94, in which he made corrections and additions, chiefly in the shape of notes to the text. Antonio Landi made an abridgment of the work in French, which was published at Paris, and at Bern, in 1784; and J. Retzer made a similar abridgment of it in the German language. When the work of Tiraboschi appeared, no other country of Europe had a general history of its own literature. The learned Benedictines of St. Maur had begun a work of this kind concerning the literature of France, which however they left imperfect. The work of Tiraboschi does not give all the information that one might wish, but it contains probably as much information as could be collected and compressed together by any one man upon the subject. It has been said to be deficient in criticism, and in the analysis of conspicuous works, of which he has not given extracts; but this, as he says in his preface, did not form part of his plan, which was already extensive enough, or the work would have had no end. His accuracy and conscientiousness are undisputed. The tone of his remarks, especially on religious matters, is perhaps as temperate as could be expected from a man of his profession, times, and country, who was a sincere believer in the tenets of his church, though not a bigot. For a proof of this we might refer the reader to Tiraboschi's letter to Father Mamachi, a Dominican, who edited at Rome an edition of Tiraboschi's great work with corrections and notes to those passages which were not consonant with his own high notions of Papal prerogative and Roman supremacy, both spiritual and temporal. Tiraboschi's letter was published at Modena in 1785, and was afterwards inserted at the end of the last volume of the second Modena edition of the 'History of Italian Literature.' A tone of refined cutting irony, half veiled, under a most courteous style of language, pervades the whole of the letter. The French writer Ginguené has followed closely Tiraboschi's footsteps in his 'Histoire Littéraire d'Italie,' which however contains only the modern part, or the history of the literature of the Italian language. [GINGUENÉ.]

The duke of Modena, Ercole III. of Este, in consideration of Tiraboschi's useful labours, made him a knight, and appointed him member of his council in 1780. By the suppression of the order of Jesuits, Tiraboschi had become a secular priest. In 1781 he began to publish another work of bibliography and biography: 'Biblioteca Modenese, o Notizia della Vita e delle Opere degli Scrittori nati degli Stati del Serenissimo Duca di Modena,' 6 vols. 4to., Modena, 1781-86; to which he afterwards added a seventh volume, containing notices of the artists who were born in the dominions of the house of Este. Having thus illustrated the literary history of Modena, and of the other territories of the house of Este, he afterwards wrote the political history of the same country, in his 'Memorie Storiche Modenesi, col codice diplomatico, illustrato con note,' 3 vols. 4to., Modena, 1793. He also published the history of the antient monastery and abbey of Nonantola in the duchy of Modena, founded about the middle of the eighth century by Anselmus, Duke of Friuli, and afterwards greatly enriched by Charlemagne and other princes, and which became a powerful community during the middle ages: 'Storia dell' augusta Badia di S. Silvestro di Nonantola, aggiuntovi il codice diplomatico della medesima, illustrato con note,' 2 vols. folio, Modena, 1784. The other works of Tiraboschi are: 1. 'Vita del Conte D. Fulvio Testi.' Testi was a lyric poet of the seventeenth century, and enjoyed for a time a high office at the court of Modena, but ended his days in prison for state reasons. 2. 'Lettere intorno ai viaggi del Sigr. Bruce,' inserted in the 'Notizie Letterarie' of Cesena, 1792; 3. 'Memoria delle cognizioni che si avevano delle sorgenti del Nilo prima del Viaggio del Sigr. Jacopo Bruce,' inserted in the 1st vol. of the 'Memorie dell' Accademia delle Scienze di Mantova'; 4. Two memoirs on Galileo, his discoveries, and his condemnation by the Inquisition, inserted in the last

vol. of the second Modena edition of the 'History of Italian Literature'; 5. 'Notizie della Confraternita di S. Pietro Martire'; 6. 'Vita di Sant' Olimpia, Diaconessa della Chiesa di Costantinopoli'; 7. 'Storico di Rambaldo de Copti Azzoni Avogaro'; other minor writings, especially in answer to a request of his 'History of Italian Literature.' He published: 1. 'Dizionario Topografico degli Stati published since at Modena, 1824-5; 2. 'Catalogo dei Libri del già Collegio dei Gesuiti di Brera'; 3. 'Vita della Venuta di Gustavo Adolfo in Italia'; 4. 'Vita di Andrea Barotti Ferrarese'; 5. 'Notizie sulla vita di Bressello, sopra alcuni Luoghi del Modenese, e della casa Montecuccoli'; besides several discourses and orations. His voluminous correspondence served in the Modena Library.

Tiraboschi died at Modena, in June, 1794, of a fever brought on by sedentary life and constant application. He was buried in the church of SS. Faustino e Jovita, outside of the city, and a Latin inscription was placed on his tomb, written by Father Pozzetti, who considered him as librarian, commemorative of his labours and virtues, among which modesty and charity were the most conspicuous.

(*Elogio di Girolamo Tiraboschi*, by Pozzetti, published in the later editions of the 'History of Italian Literature'; Ugoni, *Storia della Letteratura Italiana nella metà del Secolo XVIII.*; Lombardi, *Storia della Letteratura Italiana nel Secolo XVIII.*)

TIRA'NO. [VALTELLINO.]

TIRHUT. [HINDUSTAN, p. 217.]

TIRIDATES, prince of Media, and king of Armenia, was the brother of Vologeses, a Parthian, that is, of Media. He first appeared in A. D. 53, in the first war of Corbulo against the Parthians (Tacitus, *Hist.*, xii. 50), who was compelled by his schemes upon Armenia in A. D. 54. In A. D. 55 the Parthians again overran Armenia, having been driven by the inhabitants of that country, and by the conquest to his brother Tiridates, who was king of Armenia. As the Romans would not permit the country to become a possession of the Parthians, Tiridates directed his forces against the royal brothers, and Vologeses was prevented from employing him in consequence of an insurrection of the Hyrcanians. Corbulo therefore soon persuaded Tiridates to submit to the emperor Nero, and to prefer his independence to an uncertain and dangerous dependence upon Nero. When they were about to meet, in order to settle the conditions of the peace, Tiridates suddenly became some treacherous design on the part of the Parthians, he therefore broke off the negotiations and returned to war. Corbulo however defeated him at Artaxata, and destroyed this old capital of Armenia, and forced the new capital, Tigranocerta [Tigranocerta] to surrender after a short siege. (Tacitus, *1st Annals*, Frontinus, *Stratag.*, ii. 9, exempl. 5.)

Tiridates fled to his brother, who had taken command of a new army, with which Tiridates expelled the Romans from Armenia. He attacked the side of Mesopotamia, but the strong position which the Romans kept at Tigranocerta, and the care which Corbulo showed in watching the passages of the Euphrates, prevented him from either penetrating into the valley of the Upper Tigris, or from invading Syria, a man which Corbulo would have been obliged to have relieved of this province, and to leave Armenia to the disposal of Vologeses. Tiridates therefore listened to the pacific proposals of the Romans, who were desirous to avoid any war with the Parthians if they could obtain conditions which would secure their influence in Armenia. Their intention was not to make a Revolt in Armenia. Ambassadors from Tiridates went to the camp of Corbulo, and they declared, in the name of Tiridates and his brother Vologeses, that Tiridates was ready to submit to Nero, as a vassal-king, and that Vologeses would keep in future a better understanding with the Romans than before. In order to settle the conditions of the peace, it was fixed on which Tiridates was to appear in the camp of Corbulo, who sent Tiberius Alexander [TIBERIUS ALEXANDER] and his son-in-law Vivianus Antonius into the camp of Tiridates (A. D. 63).

and the tent of Corbulo, he took off his royal diadem, and had it at the foot of a portrait of the emperor Nero, giving an oath that he would not exercise any right of sovereignty in Armenia till he had again received the diadem from the hands of the emperor in Rome. (Tacitus, *Hist.*, xv. 28, 29.) Tiridates arrived in Rome in 66, and when he approached the city a great number of people came out from the gates to behold the entrance of an oriental king descended from the mighty sovereigns the Parthians. In Zumpt, 'Annales veterum Regum et Populorum, imprimis Romanorum,' the Armenian king who entered Rome in A.D. 66 is called Tigranes, this is a typographical error. (Tacitus, *Hist.*, xvi. 23.) The latter circumstances of the life of Tiridates are unknown. [PARTHIA.]

TIRLEMONT (in Dutch, *Tienen*), situated in 50° 50' lat. and in 4° 50' E. long., is an inland town in the kingdom of Belgium, in the province of South Brabant, a small river called the Great Geete. It is a pretty well-built town, and has 8000 inhabitants, who have considerable manufactures of flannel and stockings. There are also brandy distilleries, and breweries which produce celebrated kind of beer. It is said to have been formerly more populous and thriving than at present. In the wars of the French revolution, several battles took place here between the French and the Austrians; first, in November, 1792, when the Austrians were defeated; secondly, on the 16th of March, 1793, when they again sustained a check, for which they took ample revenge two days afterwards by the decisive victory of Neerwinden. (Hassel; Stein; Cannabich; Hirschelmann.)

TIRO. [CICERO.]

TIRVALORE, TABLES OF. [VIGA GANITA.]

TIRY, or TYREE. [HEBRIDES.]

TIRYNS was an ancient city of Argolis, in the Peloponnesus, situated in 37° 40' N. lat. and 41° 1' E. long., at no great distance from the head of the Argolic Bay, now the Gulf of Napoli di Romania. According to a legend in Strabo (viii., p. 373, Casaub.), it was built by Prætus, an ancient king of Argolis, who in the construction of the citadel employed masons from Lycia, who were called Cyclopes. The Greeks attributed most architectural works which were characterised by rude massiveness and great antiquity to the Cyclopes, and such works were consequently described as Cyclopean. Homer (*Iliad*, ii. 559) calls Tiryns the 'walled,' or rather the 'wally' Tiryns; and Pausanias (ii. 25), 1000 years after him, thus describes the remains, as they existed in the second century of our æra. 'The ruins of Tiryns,' he observes, 'were on the right of the road leading from Argos to Epidaurus. The wall of the fortification, which still remains, is the work of the Cyclopes, and is built of unwrought stones, so large that not even the least of them could be even moved by a pair of mules. The intervals between them have been long since filled up with smaller stones, so as to make the whole mass solid and compact.' No cement or mortar was used in these constructions, and it is evident that they were the first rude attempt at building with stone among the Pelasgic Greeks, and constituted their first style of architecture. The second is still visible in the remains of MYCENÆ.

The ruins of Tiryns are thus described by Col. Leake, in his 'Morea,' vol. ii., p. 350:—'They occupy the lowest and flattest of several rocky hills, which rise like islands out of the level plain. The length of the summit of that of Tiryns is about 250 yards, the breadth from 40 to 80; the height above the plain from 20 to 50 feet; the direction nearly north and south. The entire circuit of the walls still remains more or less preserved. Some of the masses of the stone are shaped by art, some of them are rectangular; but these are probably repairs, and not a part of the original work described by Pausanias. The finest specimens of the Cyclopean masonry are near the remains of the eastern gate, where a ramp, supported by a wall of the same kind, leads up to the gate. The ruined wall of the fortress still exists to the height of 25 feet above the top of the ramp; but this is the only part in which the walls rise to any considerable height above the table summit of the hill within the fortress. On one side of this gateway I measured a stone of 10.6 by 3.9 by 3.6. Here the wall is 24½ feet in thickness; in other parts from 20 to 23. But the principal entrance was not here, I think, but on the southern side, adjacent to the south-east angle of the P. C., No. 1530.

fortress, where a sloping approach from the plain is still to be seen, leading to an opening in the walls.'

In its general form the fortress appears to have consisted of an upper and a lower enclosure of nearly equal dimensions, with an intermediate platform. The southern entrance led, by an ascent to the left, to the upper level, and by a direct passage between the upper inclosure and the eastern wall of the fortress into the lower inclosure, having also a branch to the left into the middle platform, the entrance into which last was nearly opposite to the eastern gate already described. There was also a postern on the western side. In the eastern, as well as in the southern wall, there were galleries in the body of the wall of singular construction, the angle of the roof being formed by merely sloping the courses of the masonry. In the eastern wall there are two parallel passages, of which the outer has six recesses in the exterior wall. These niches were probably intended to serve for the protracted defence of the gallery itself, and the galleries for covered communications leading to places of arms at the extremities of them. One of these places of arms still exists at the south-west angle of the fortress, and there may have been others on either side of the great southern entrance. The passage which led from this entrance to the lower division of the fortress was about 12 feet broad; and about midway there still exists an immense door-post, with a hole in it for a bolt, showing that the passage might be closed upon occasion. In these contrivances for the progressive defence of the interior we find a great resemblance not only to Mycenæ, which was built by the same school of engineers, but to several other Grecian fortresses of remote antiquity. A deficiency of flank defence is another point of resemblance: it is only on the western side, towards the south, that this essential mode of protection seems to have been provided. On this side, besides the place of arms at the south-western angle, there are the foundations of another of a semicircular form, projecting from the same wall, fifty yards farther to the north; and at an equal distance, still farther in the same direction, there is a retirement in the wall, which serves in aid of the semicircular bastion in covering the approach to the postern of the lower inclosure. This latter division of the fortress was of an oval shape, about 100 yards long and 40 broad: its walls formed an acute angle to the north, and several obtuse angles on the east and west. Of the upper inclosure very little remains.

The fortress itself is only a third of a mile in circumference, so that in all probability it must have been no more than the citadel of the Tirynthii, the town itself being situated in a plain of two or three hundred yards in breadth, on the south-west of the fortress: beyond this plain lies a marsh, extending a mile farther towards the sea.

Prætus, the reputed founder of Tiryns, was succeeded by his son Megapenthes, who is said to have transferred it to Perseus. Perseus transmitted it to his descendant Electryon, whose daughter Alcmena married Amphitryon. The latter prince was expelled from Tiryns by Sthenelus, king of Argos; but his son Hercules recovered his inheritance, and was in consequence called Tirynthius. (Diodorus, iv. 10; Pindar, *Olymp.*, x. 37.)

From Perseus to Amphitryon, Tiryns was a dependency of the neighbouring city Mycenæ. At the time of the Trojan war, Homer (*Iliad*, ii. 559) represents it as being subject to the kings of Argos. Subsequently it was partially destroyed by the Argives. The date of that event is uncertain; but from two passages of Herodotus (vi. 83, and ix. 28), in which mention is made of Tiryns, it appears that it existed up to B.C. 480, and it is probable that it was overthrown about the same time as Mycenæ, B.C. 468. (Clinton, *Fasti Hell.*, ii., p. 425.) According to Strabo (viii., p. 373), the Tirynthians, on leaving their homes, retired to Epidaurus: according to Pausanias (ii. 25), the greater part of them were sent to Argos.

Pausanias also notices what he calls the chambers (*θάλαμοι*) of the daughters of Prætus lying between Tiryns and the sea; but he gives no description of them. Strabo speaks of some artificial caverns near Nauplia, which he places at the distance of only 12 stadia from Tiryns, and says that they were attributed to the Cyclopes. It is not improbable that he alludes to the same excavations as Pausanias; but Strabo had probably not seen them, for he never saw Mycenæ. The Tirynthian citadel was also called Licymnia, from Licymnius, a son of Electryon, and brother of Alcmena. (Pindar, *Olymp.*, vii. 49.)

(Leake's *Morea*, ii. 353; Cramer's *Greece*, iii. 253; Sir W. Gell's *Itinerary of the Morea and Argolis*; Dodwell, *Class. Tour*, ii., p. 250.)

TISCHBEIN, JOHN HENRY, called the Elder, one of the most celebrated painters of the eighteenth century, was the fifth son of a baker of Hayna near Gotha, where he was born in 1722. He was first apprenticed to an uncle on the mother's side, who was a locksmith; but he displayed so much talent for drawing, that an elder brother, John Valentine, took him away from his uncle and placed him, in his fourteenth year, with a paper-stainer and decorator in Cassel, of the name of Zimmermann. He received also some instruction from Van Freese, the court painter at Cassel, and soon gave proof of his ability. Tischbein met with an early and a valuable patron in Count Stadion, through whose assistance he was enabled, in 1743, to visit Paris, where he remained five years with Charles Vanloo, and acquired his style of painting. From Paris he went to Venice, and there studied eight months with Piazzetta: from Venice he went to Rome, where he remained two years; he again visited Piazzetta in Venice, and after a short time, in 1751, he returned to Cassel, where, in 1752, he was appointed cabinet painter to the landgrave.

Tischbein excelled in historical and mythological subjects, in which lines are his best pictures, painted from about 1762 until 1785; he died in 1789, as director of the Academy of Cassel, and a member of the Academy of Bologna. A biographical notice of Tischbein with criticisms upon his works was published in Nürnberg in 1797, eight years after his death, by J. F. Engelschall, entitled 'J. H. Tischbein, als Mensch und Künstler dargestellt.' In that work there is a list of 144 historical pieces by Tischbein, of which the following have been considered the best:—the Resurrection of Christ, very large figures, painted in 1763, for the altar of St. Michael's church at Hamburg; the Transfiguration, in the Lutheran church at Cassel, 1765; Hermann's Trophies after his Victory over Varus in the year 9, in the palace of Pyrmont, 1768; ten pictures of the Life of Cleopatra, painted in the palace of Weissenstein, 1769-70; sixteen from the life of Telemachus, in the palace of Wilhelmsthal; an Ecce Homo, in the Roman Catholic chapel at Cassel, 1778; a Deposition from the Cross, and an Ascension, altar-pieces in the principal church of Stralsund, 1787; Christ on the Mount of Olives, an altar-piece presented by him to the church of his native place Hayna, 1788; the Death of Alceste, 1780; and the Restoration of Alceste to her husband by Hercules, 1777.

Tischbein painted many pictures from the ancient poets, and some from Tasso; several of which are now in the Picture-gallery at Cassel. He painted also a collection of female portraits, selected chiefly for their beauty, which is now at the palace of Wilhelmsthal near Cassel. He also frequently copied his own pictures. Nearly all his works remain in his own country, on which account he is little known out of it. It is remarkable that of all the great galleries of Germany, Munich is the only one that possesses a specimen of his works, and that is only a portrait.

Tischbein painted very slowly, but he was very industrious: he was generally at his easel by five in the morning in the summer time, and he painted until four in the afternoon. He painted in the French style; his colouring was a mixture of the French and the Venetian, and in large compositions very gaudy, but his drawing and chiar-oscuro were very good. In costume however he was incorrect, yet he was as correct perhaps as his sources of information would allow him to be, and it is a fault that he had in common with most of the great painters, especially the Venetians; but according to the critics he generally contrived in his ancient pieces to make his actors look much more like Frenchmen and Germans than Greeks or Romans. In his religious pieces he was more successful: he was no follower of Lessing's theory of beauty; he considered beauty of little consequence. He etched several plates after his own pictures:—Venus and Cupid; Women Bathing; Hercules and Omphale; Menelaus and Paris; Thetis and Achilles; and his great picture of the Resurrection of Christ, at Hamburg.

Tischbein was a man of very domestic habits: he had an old servant named Conrad Otto without whom he used to say he should be helpless; he had a cook also who lived with him 21 years. He was twice married, and yet was a husband scarcely four years: he married his first wife in 1756, by whom he had two daughters; he lived with her

three years, when she died, and in 1759 he married her sister, with whom however he lived only a few years. His elder daughter Amalia was a clever painter, elected, in 1780, a member of the Academy of Cassel, and selected to sit to her father for many of the historical works. After Tischbein's death, Cassel purchased all the works that were in the possession of the landgrave, and they were placed together in the palace of W. Meusel, *Miscellaneous Artistischen in gemeines Künstler Lexicon; &c.*

TISCHBEIN, JOHN HENRY WILLI-

Younger, the youngest son of John Conrad, nephew of the preceding, with whom he is founded, was born at Hayna in 1751.

He was educated by his uncle John Henry at Cassel in 1768, and he afterwards studied landscape painting with his uncle John Jacob at Hamburg; he returned to Holland, where he remained two years, and in 1770 he returned to Cassel and painted portraits and he visited also Hanover and Berlin, and painted portraits in both places. In 1779 he left Cassel, by the order of the Landgrave, for Italy, but he spent about two years in Zürich, where he painted many portraits and design of his celebrated picture of Conradin, after playing, after his sentence to death, a game with Frederick of Austria. In 1781 he returned to Rome, and his first studies were some copies of Raphael and Guercino, and some drawings of Domenichino, and Lionardo da Vinci.

His first picture was Hercules choosing between Virtue and Vice, after which he painted his picture of *Conradin of Swabia*, now in the palace of Pyrmont. In 1787 he went to Naples, and the next year painted the portrait of the crown-prince for the queen, who presented Tischbein with a valuable snuff-box and 200 ducats, expressing her complete satisfaction with the picture. In Naples he appears to have acquired laurels rapidly, for in 1790 he was appointed director of the Academy with a salary of 800 ducats per annum, which however he lost again in 1791 at the breaking out of the revolution at Naples, but he found no difficulty in obtaining permission from the French authorities to return to Germany with what property he chose to take with him. He accordingly embarked, with the painter Hackert and another, for Leghorn, taking with him the plates of his illustrations to Homer, his design for Sir W. Hamilton's second collection of vases, and some other works of art: but the ship was driven by a storm upon the coast of Corsica, and was captured by a French ship of war; it was however set at liberty again, and after a troublesome journey of four months Tischbein at last reached Cassel in safety. During his residence in Naples he published there, in 1796, a remarkable work upon animals, in two parts, folio, entitled 'Têtes des Différents Animaux, dessinés d'après Nature, pour donner une idée plus exacte de leurs caractères.' The first part contains 10 designs of animals, and the first plate of this part is the celebrated design called in Italy Tischbein's *Laocoon*; it represents a large snake attacking and destroying a hero and her young in their den; a design of remarkable power and spirit: the second part contains 8 plates only, consisting of characteristic heads of men and gods, as—*Correggio*, *Salvator Rosa*, *Michael Angelo*, *Raphael*, *Scipio Africanus*, *Caracalla*, *Jupiter*, and *Apollo*. Tischbein after his return to Germany lived principally at Hamburg and at Esten in Oldenburg near Lübeck; the majority of his works are in the possession of the grand-duke of Oldenburg; the following paintings are three of his most celebrated works—*Ajax and Cassandra*, painted in 1805; 'Let the Luth Children come unto me,' painted in 1806, for the altar of the church of St. Angari at Bremen; and *Hector taking leave of Andromache*, painted in 1810. He painted also the portraits of Klopstock, of Heyne, and of Blücher.

In Göttingen in 1801-4 he published in royal folio his favourite work on Homer, with explanations by Heyne—'Homer, nach Antiken gezeichnet von Heinrich Tischbein, Direktor, &c., mit erläuterungen von Chr. Gottl. Heyne, i.-vi., each number containing 6 plates: the portraits of the Homeric heroes were engraved by R. Morghen. Tischbein's drawings for Sir W. Hamilton's second collection of vases, published at Naples from 1791, in 4 vols. folio, amount to 214: the work is entitled 'A Collection of Engravings from Ancient Vases, mostly of pure Greek workmanship, discovered in Sepulchres in the Kingdom of the

Two Sicilies, but principally in the environs of Naples, during the years 1780 and 1790; now in the possession of Sir W. Hamilton, published by William Tischbein, director of the Royal Academy of Painting at Naples. The text, which is in French and English, is by Italinsky. Tischbein published other works, and etched also several plates, after Paul Potter, Roos, Rosa di Tivoli, Rembrandt, &c. As a painter his drawing was correct, and his expression and colouring good, and he excelled in drawing animals. He died in 1829. There were many other artists of this family, of various degrees of merit, but they are unknown beyond their own circles.

(Füssli, *Allgemeines Künstler Lexicon*; Kugler, *Handbuch der Geschichte der Malerei*.)

TISSIAS. [ORATORY.]

TISSAPHERNES. [CYRUS THE YOUNGER.]

TISSOT, SIMON ANDREW, an eminent Swiss physician, was born at Lausanne, in the canton de Vaud, in 1728. He studied first at Geneva, and then at Montpellier, from 1746 to 1749, where he took his degree of Doctor of Medicine. He then returned to Switzerland and settled at Lausanne, where he joined to an extensive practice a considerable degree of theoretical knowledge. His reputation spread rapidly through Europe in consequence of his medical publications, and caused him to be consulted from all parts. He was also offered at various times several important situations at different foreign courts and universities, all which he declined, and remained satisfied with the respect and comfort which he enjoyed at home, and with the office of professor of medicine at the college of Lausanne. However, in 1780, he could not resist the warm solicitations of the emperor Joseph II., who conferred on him the professorship of clinical medicine at the university of Pavia. Being thrown thus late in life into so difficult a post, and being naturally of a modest and shy disposition, he did not at first answer the expectations formed of him. However there soon after broke out in the province an epidemic bilious fever, as to the treatment of which the physicians of the place were not agreed. On this occasion the Count de Firmian, the celebrated minister under the archduke, gave orders that Tissot's directions should be followed, as he had treated a similar disorder with great success in the canton of Le Valais in 1755. His system was again successful, and the students not only celebrated his triumph with fêtes, but, wishing to render the memory of it more durable, they caused a marble inscription, beginning with the words *Immortali Præceptorum*, to be placed under the portico of the school. After holding his professorship for three years, Tissot obtained permission to retire from office. During his stay in Italy he had made use of the vacations to travel through the finest parts of that country, and was everywhere received with the most marked and flattering attention. Pope Pius VI. signified his desire of seeing so estimable and eminent a man; he accordingly received him with much kindness, excused him (as being a Protestant) from the ceremonial customary at presentations at the Papal court, and made him a present of a set of the gold medals struck during his pontificate.

Having always lived economically and without any display, Tissot had saved while in Italy a sum of money sufficient for the purchase of a country-seat, which he intended to be the retreat of his old age. He had only engaged himself in the Austrian service for a very limited period; he had now finished the medical education of a favourite nephew; and, lastly, as he himself with characteristic playfulness expressed it, having received the title of 'Immortal,' he thought it prudent not to run any risk of descending from such a height, and of outliving (as he might easily do) his apotheosis. He was succeeded in his professorship at Pavia by the celebrated J. P. Frank, and died unmarried, on the 15th of June, 1797, in his native land, at the age of sixty-nine. A complete list of his works is given in the 'Biographie Médicale,' from which work the above account is taken: of these the following are the most interesting: 'Tentamen de Morbis ex Manustupratione Ortis,' Louvain, 8vo., 1769; which was translated into French, and has been frequently republished. 'Dissertatio de Febribus Biliosis, seu Historia Epidemice Lausanensis anni 1755,' Lausanne, 1758, 8vo. 'Avis au Peuple sur sa Santé,' Lausanne, 1761, 12mo., which was translated into no less than seven different languages, and in less than six years reached the tenth edition. It has since been

frequently reprinted, and contributed more than any of his other works to make the author's name known throughout Europe. It served also as the model and foundation for many similar popular works in more recent times. 'De Valetudine Litteratorum,' Lausanne, 8vo., 1766, which was translated into French, and frequently reprinted, and of which the latest and best edition is that by F. G. Boisseau, Paris, 1826, 18mo., with notes by the editor, and a memoir of the author. 'Essai sur les Maladies des Gens du Monde,' which has also gone through several editions. There is a complete edition of his works by J. N. Hallé, in 11 vols. 8vo., Paris, 1811, with notes by the editor and a memoir of the author. Besides these original works Tissot edited at Yverdon, 1779, in three volumes 4to., the treatise of Morgagni, 'De Sedibus et Causis Morborum per Anatomem Indagatis,' to which he prefixed a history of the Life and Works of the author.

TISSUES, VEGETABLE. The various organs of plants, as the leaves, flowers, roots, stem, &c., are composed of certain ultimate structures, which are called elementary organs or vegetable tissues. Most parts of a plant, when cut into, present to the naked eye an almost perfectly homogeneous character; and it is only by calling to our aid the microscope that we can distinguish the various structures of which they are composed. On taking a leaf or a portion of the stem of one of the higher plants, and submitting it to the microscope, it will be found to consist, 1, of a thin transparent homogeneous membrane, which is arranged in the form of cells or cylindrical tubes; 2, or fibres, which are arranged in a spiral form in the interior of the cells or tubes; and 3, a fluid of varying density, filling the cells and existing between them, and containing in it globules of various sizes and kinds. These parts constitute what are known respectively as 'elementary membrane,' 'elementary fibre,' and 'organic mucus.' Elementary membrane, and the fluid from which it is developed, are the only two which are constantly present in all plants. Fibre is only found in the higher forms of plants.

The primary form in which organization appears is that of a simple cell containing or surrounded by a fluid; and however complicated may be the forms which the tissues of plants may assume, they mostly originate in this primitive form. Some late researches on the development of tissues in animals seem to lead to the conclusion that some of these tissues are formed from a primitive fibre; and from analogy it has been supposed that the same may occur in vegetable organization. Whether however the cell or the fibre shall be determined to be the primitive form of tissue in the animal kingdom, there can be little doubt that the cell is so in the vegetable kingdom.

The development of the cell itself is a subject of much interest, and great light has been thrown on this obscure department of physiology by the late researches of Dr. Schleiden. It was long since observed by Robert Brown that in the cells of the tissue of Orchidaceous plants there was an opaque spot, or 'areola,' in the interior of the cell: Schleiden, finding this spot very constant in the cells of certain plants, concluded that it must have some important relation to them, and submitted it to a very strict examination. He found that these bodies were the original particles from whence the cells were formed; hence he called them cytoblasts. The best parts of the plant for observing the phenomena to which these bodies give rise are, the large cell which exists between the embryo and the membranes of the seed, and in which the albumen is subsequently deposited, the embryonal sac, and the end of the pollen-tube, from which the embryo itself is developed. In the gummy fluid that exists in these parts in the process of growth a number of granules are developed, rendering this transparent homogeneous fluid opalescent, or almost opaque. It is among these granules, which assume a brownish-yellow colour under the influence of tincture of iodine, that the cytoblasts make their appearance. Whilst in this state the cytoblasts increase considerably in size, becoming larger than the granules of the gum; and as soon as they have attained their full size, a delicate transparent vesicle rises upon their surface: this is the young cell, which at first represents a very flat segment of a sphere, whose plane side is formed by the cytoblast, and the convex side by the young cell, which is situated on it, somewhat like a watch-glass on a watch. In its natural medium it is almost distinguished by this circumstance alone, that the space between its convexity

and the cytoblast is perfectly clear and transparent, and probably filled with an aqueous fluid, and is bounded by the surrounding mucous granules, pressed back by its expansion. But if these young cells are isolated, the mucous granules may almost entirely be removed by shaking the stage of the microscope. This cannot however be long observed, as they entirely dissolve in a few minutes in distilled water, leaving the cytoblasts behind. The vesicle gradually gets larger and becomes more consistent, its parietes being formed entirely of vegetable gelatine (Gallerte), except the cytoblast, which always forms a portion of the wall. The whole cell now gradually enlarges beyond the edges of the cytoblast, and gets so large, that at last the latter appears as a small body enclosed in one of the side walls. At this point the cytoblast assumes the character of the areola described by Brown. The young cell frequently presents great irregularities, a proof that the expansion does not proceed regularly from a fixed point. The cell grows progressively, and becomes, under the influence of surrounding objects, more regular, and most frequently assumes the form of a rhomboidal dodecahedron. The cytoblast still remains in the cell, partaking of the life inherent in the cell, unless it is in cells destined to a higher development, when it is either reabsorbed in the walls of the cell, or cast off into the cell as a useless member, and there reabsorbed. It is only after the reabsorption of the cytoblast that secondary depositions are observed to commence on the inside of the walls of the cell. (Schleiden.)

The cytoblast remains in the cells in only a small number of cases. They are found in a portion of the cellular tissue of Orchidaceæ, also of Cactaceæ. In hairs likewise, and cells in which the function of cyclosis is carried on, they are very frequently permanent; also in the pollen granules of Abietinæ. Dr. Schleiden always found them present in recently-formed cellular tissue.

The increase of the bulk and size of plants depends upon the development, in the interior of the old or originally formed cells, of several new cytoblasts, each of which develops a new cell, and causes by its presence the absorption or destruction of the old one.

But all the parts of plants do not consist of simple cells; the cells become elongated, forming fibrous or woody tissue, and spiral fibres are generated both in cells and tubes, constituting the various forms of fibro-cellular and vascular tissue, and it will be necessary to say a few words on their development. One great error that has arisen from the naming and classification of the tissues of the plants has been the supposition that they were essentially distinct and possessed a different origin. This is seen in the theories of the origin of wood. Woody fibres are nothing more than elongated cells with thickened walls; but they were supposed to originate in a different manner from the cellular tissue; and an ingenious theory of Du Petit Thouars has been adopted by many eminent botanists for the purpose of explaining this phenomenon.

In referring to Du Petit Thouars' views, Dr. Lindley says, 'The wood is not formed out of the bark as a mere deposition, but it is produced from matter elaborated in the leaves sent downwards, either through the vessels of the inner bark along with the matter for forming the liber, by which it is subsequently parted with, or it and the liber are transmitted distinct from one another, the one adhering to the albumen, the other to the bark. I know of no proof of the former supposition; of the latter there is every reason to believe the truth.' And again, 'It is not merely in the property of increasing the species that buds agree with seeds, but that they emit roots in like manner; and that the wood and liber are both formed by the downward descent of bud-roots, at first nourished by the moisture of the cambium, and finally imbedded in the cellular tissue which is the result of the organization of that secretion.' This theory then supposes that woody tissue is sent down as a deposit from buds and leaves. But it is much too general, and whatever may be the agency of the leaves in elaborating the sap, and preparing the secretions of plants, they are certainly not the only agents engaged in developing the woody tissue. There are many parts of plants that possess no leaves, and some whole orders, as Cactaceæ, that possess no leaves that yet develop woody tissue. Trees also that have the bark removed in a circle from the stem at the spring of the year, before the leaves are developed, will at the end of the year exhibit between the

bark and wood new woody tissue. This was proved by a series of experiments performed on beech-trees by Dr. Lankester. The existence of woody excrescences in the bark of trees is also another fact opposed to Dr. Petit Thouars' theory. These excrescences exist in the form of knobs, and are most frequent on the beech, projecting from the bark of the tree. On examining them it will be found that they have no connection with the wood of the tree, and consist of several layers of contorted woody tissue, developed in a bark of their own, consisting of liber and cellular integument. They are of all sizes, from a mere point to that of an orange. The smallest consist of cellular tissue, in the centre of which a darker spot is seen, as though the tissue was injured or diseased. It is around this spot that the fibres of woody tissue develop themselves. These bodies appear to have their origin in an undeveloped bud, hence they are called by Dutrochet *embryo-buds*, as they go on increasing in size, and development occurs in a circular, rather than a longitudinal direction, they are described by Lankester as *abortive branches*. From the researches of Schleiden there can be little doubt but that elongated tissue is developed in the same manner as such. A question that still arises, and requires solution, is as to whether the single fibres of woody tissue are the product of a single cytoblast or of several. In the tissue called pitted or Bothrenchyma, there are evident indications of its cylindrical tubes being formed of several cells united together, and the walls, being absorbed at their point of union, have thus produced a continuous tube.

The above observations of Schleiden have set aside the supposition that the cell is composed entirely of spiral fibres intimately superposed. But still the question recurs as to whether fibre may not be generated independent of membrane. Meyen found fibres without membrane in the genus *Stelis*; Lindley observed them in *Colobus*; and many other instances are known in which fibres are found in plants without any apparently enveloping membrane. The late researches of Dr. Martin Barry on the development of animal tissue from the spiral fibre of the blood-globule have induced some botanists to examine this question; and Dr. Willshire, in a paper in the 5th volume of the 'Annals of Natural History,' has endeavoured to prove that the irregular-shaped bodies marked with dark lines and found in the juices of many plants, are the contents of pure fibrous tissue. If such a development of fibrous place, it can be only in exceedingly rare cases. Schleiden in his memoir on Phytogenesis states that fibres are never formed free, but always in the interior of cells, and the walls of these cells in the young state are simple and a very delicate texture.

Whether fibre is formed independent of membrane or not, there is no doubt of its formation in a large number of organs in the inside of cells and tubes forming the fibro-cellular and fibro-vascular tissues. According to Schleiden the cells in which the development of fibre takes place are in the commencement of the formation of the fibres filled with starch, rarely with mucus or gum, although the starch passes into the state of mucus or gum, and then into that of gelatin (gallerte). From this latter vegetable fibre is formed which in their development always follow the direction of a spiral line, whose coils are narrower or wider according to circumstances. The development of the fibre is the same in the spiral vessel as in the spiral cell, there being no difference between the two but in their dimensions. In the first volume of the 'Transactions of the Microscopical Society of London' (1842), Mr. Quoy gives the following account of the development of fibre in the vascular tissue of plants:—When the young vessels (that is, membranous tubes) are recognised, they appear as pellucid glossy tubes, with a cytoblast in some part of their interior; earlier than this they are not to be distinctly recognised from cells. As they grow older the cytoblast diminishes, and the contents, which at first were clear and gelatinous, become less transparent from containing thousands of granules, which are too small to allow of the passage of light, and consequently appear as dark points. These atoms are about the size of an inch in diameter, and have the motion known as "active molecules." If the vessel be wounded at this period, the gelatinous contents pass slowly out, and then the singular movements of these molecules are still more clearly seen. These atoms, in their freedom of motion, are arranged indiscriminately in the interior of the vessel, but in a short time some of them

ge, and then transmit a little light, which, on account of their minute dimensions, is not suffered to pass as a pencil, but is decomposed in its course, the granule thereby becoming of a greenish hue. The granules existing in this greenish hue are now in a fit state to enter the composition of the fibre that is to exist in the interior of the membranous tube.' This is effected in the following manner:—The granules which are in active motion in the viscid fluid near one of the ends become gradually attracted to the inner wall of the vessel, beginning at the very point; those granules first attracted appear as if cemented to the spot by the viscid fluid in that position losing some of its watery character; for there arises a string of a whitish colour, besides granules, in the interior of which the fibre is to occupy. As the other granules are attracted to those already fixed in an inclined direction, the spiral course is soon to be seen, and the same action successively goes on from the end where it began towards the other, around the interior of the tube in the form of a spiral; the fibre being produced, like a root, by having the matter added and continually attached to the growing point, thereby causing its gradual elongation.' Spiral vessels thus formed exhibit a great variety of arrangement, depending on the period in the age of the tube or tube at which the development of the fibre takes place, as well as the modifications that occur in the chemical changes of the substances from which the fibres are formed. The cause of the arrangement of the parts in a fibrous form is still not satisfactorily explained, but it is most commonly referred to an attraction between the sides of the membrane, of the cell, and the particles it contains, but why they form a spiral is a mystery yet to be solved. [SPIRAL STRUCTURE OF PLANTS.] The various forms of vegetable tissue found in the different organs of plants are included in the following arrangement:—

I. FIBROUS.

Tissue in which elementary fibre is alone apparent.

II. CELLULAR.

Tissue composed of membrane in the form of cells whose length does not greatly exceed their breadth.

Merenchyma, the cells of which touch each other only at a few points.

Parenchyma, the walls of the cells of which are generally united.

Prosenchyma, the cells of which are always fusiform, and overlap each other at their ends.

III. VASCULAR.

Tissue composed of cylindrical tubes of membrane continuous, or overlying each other at their ends.

Pleurenchyma, with the sides of the tubes thickened and tapering to each end.

Sinenchyma, the sides of the tubes of which anastomose and convey a peculiar fluid.

IV. FIBRO-CELLULAR.

Tissue composed of cells, in the inside of which fibres are generated.

a. Genuine.

1. Fibrous cells.
2. Spurious.
3. Porous cells.
4. Dotted cells.

V. FIBRO-VASCULAR.

Tissue composed of tubes, in the inside of which one or more spiral fibres are more or less perfectly developed.

a. Genuine.

1. Spiral vessels.
2. Annular vessels.
3. Moniliform vessels.
- b. Spurious.
4. Scleriform vessels.
5. Porous vessels.
- (Bothrenchyma.)
6. Dotted vessels.

This arrangement includes the principal forms of tissue found in plants, but the divisions are not founded upon any essential difference in the structure or functions of the different tissues. The most important distinction exists

between membrane and fibre, which are apparently developed under the influence of different forces. The cell and the tube differ but in their dimensions, and the same is true of them when fibre is generated in their inside.

Fibrous Tissue.—Although the development of fibre independent of membrane is still undecided, many of the parts of plants exhibit fibres divested of membrane. Fibres spirally arranged and adhering only together by vegetable mucus, which is dissolved away by the application of water, were discovered by Brown, in the seed-coat of *Casuarina*, and by Lindley, in the same position in *Collomia linearis*. Meyen, who maintains that all cells may be composed of minute fibres, records many instances of vegetable structure in which fibre of a spiral form alone is most apparent, as the parenchyma of a species of *Stelis*, in the external layer or bark of the aerial roots of many species of *Orchidaceæ*, and also in species of *Melocactus* and *Mammillaria*. Fibres not assuming a spiral form, and independent of cells or tubes, have been described by Purkinje. In the lining of the anthers of *Polygala Chamæbuxus* they are found short, straight, and radiating; in the anthers of *Linaria cymbalaria* they form distinct arches; and in those of some species of *Campanula*, they are arranged like the teeth of a comb. The fibre in all cases is very minute, varying from $\frac{1}{2000}$ to $\frac{1}{10000}$ of an inch in diameter. It is most commonly transparent and colourless, but in some cases has been observed of a greenish colour. Purkinje, who has recently investigated it very attentively, asserts that it is hollow; but Lindley, Schleiden, and Morren are of opinion that it is solid.

Cellular Tissue; also called *utricular* and *vesicular tissue*. The Parenchyma of Lindley and Morren, *tela cellulosa* of Link, and *contextus* and *complexus cellulosus* of older writers; *Zellgewebe*, Germ.; *Tissu cellulaire*, French.—This tissue consists of cells or cavities, which are closed on all sides, and are formed of a delicate, mostly transparent membrane developed from a cytoblast. It is present in the whole vegetable kingdom; and all the lower forms of plants, constituting the class Acrogens, are composed entirely of it, and have hence been called *Cellulares*. In the higher plants it is most abundant in fruits and succulent leaves. It exists in larger quantity in herbs than trees, and the younger the plant is the more it abounds, and constitutes the entire structure of the embryo.

The normal form of the cells is spheroidal, and when they exist in this or in an elliptical form, and only touch each other at a few points without exerting pressure, they constitute the tissue called by Meyen *Merenchyma*. The cells in this case may form a regular or irregular layer, a distinction which may be of some importance. Such tissue is found in many parts of plants, especially those which are delicate and easily torn, as in the pulp of fruits like the strawberry, in the petals of the white lily, in the stem of *Cactus pendulus*, where they are spheroidal, and in the leaf of the *Agave Americana*, where they are elliptical. The cells also which constitute the entire of many of the lower plants belong to this division of cellular tissue. They are seen separate or loosely adhering to each other in the *Protococcus nivalis*, the plant of the Red snow [SNOW, RED], in many of the smuts and brands, as *Ustilago* and *Uredo*. *Chroolepus*, and many of the lower forms of algae and fungi, consist of filaments which are entirely composed of spheroidal cells arranged one upon another.

In the higher forms of plants the vegetative force is greater, and a greater number of cells being generated in a given space, they press on each other on all sides, assuming a variety of forms, and constituting the tissue called by Meyen *Parenchyma*. The most common form which the cells present under these circumstances is the rhomboidal dodecahedron, which is the mathematical form that a globe assumes when subjected to the pressure of a number of globes touching each other at the same time. These cells when cut through, as in the section of a portion of pith, or the leaf of a plant, will present their cut margins, when seen through the microscope, in the form of hexagons. (a and b, Fig. 1.) But the pressure is not always equal on all sides of the cells, so that a great number of secondary forms are the result. When the vesicles are elongated, the dodecahedrons assume the form of right-angled prisms, terminated by four-sided pyramids, whose faces replace the angle of the pyramids at varying degrees of inclination to the axis. Many of the forms thus assumed characterise parts of plants, and are very constant in the

same species of plants. The principal varieties of Parenchyma distinguished by Meyen are

Fig. 1.

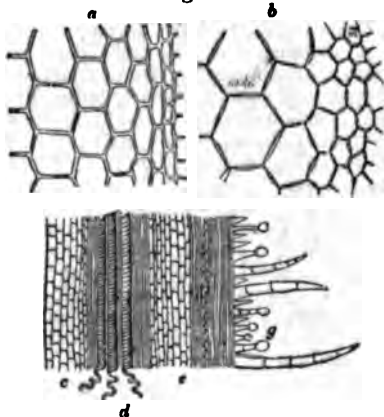

1. The *cubical*, which exists in the cuticle of some leaves, and is not unfrequently met with in bark and pith, as in the pith of *Viscum album*. (c, Fig. 1.)

2. The *columnar*, of which there are two varieties: the *cylindrical* (*cylindrenchyma* of Morren), examples of which may be seen in *Chara* and in *Agaricus muscarius*; the *prismatical* (*prismenchyma*), frequently seen in the pith and the bark of plants, and when compressed it becomes the muriform tissue (e, Fig. 1), which is constantly found in the medullary rays, and has its name from the cells being arranged as bricks in a wall.

3. The *dodecahedral*: the natural form of parenchyma when the cells are of equal size and exert on each other equal pressure, and when cut present a hexagonal form. (a, c, Fig. 4.)

4. The *stellated* (*actinenchyma*), in which the cells, from the irregularity of their walls, assume a star-like form, seen in *Musa*.

5. The *tabulated*, seen in the epiphæum of many plants: other forms, as conical (*conenchyma*; h, Fig. 1), oval (*ovenchyma*), fusiform (*atractenchyma*), sinuous (*colpenchyma*), branched (*cladenchyma*), entangled (*dædalenchyma*), have been described by Morren.

Prosenchyma differs from *Parenchyma* in the cells always having an elliptical form which taper to their extremities, where they overlie each other. This form of tissue is found only in the bark and wood, and is a transition from cellular to what is called woody tissue. Meyen applies this term especially to the tissue forming the wood of *Coniferæ* and *Cycadacæ*. In these families this tissue is marked with dots, which are surrounded by a circle.

Fig. 2.

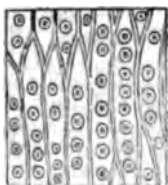

(Fig. 2.) These dots were formerly supposed to be glands, and to secrete the resinous matter which abounds in them, and hence it was called 'glandular woody tissue.' The researches of Mohl and others have however shown that these dots are the result of the development of fibre within the walls of the cells, and in this view the *Prosenchyma* not only constitutes a transition from cellular to vascular tissue, but also a transition from fibro-cellular to fibro-vascular tissue.

Contents of Cells.—The vesicle of cellular tissue when it rises from its cytoblast is a thin transparent membrane, which as it enlarges becomes thickened from within by the appropriation of proper nutriment which is contained in the cell. This cell in the early stages of its growth is filled with a fluid, at first clear, but afterwards opalescent from the development in it of minute granules. These granules are of various shapes and sizes, and always excessively minute. In their early stages they possess the

characters of starch, more particularly the property of assuming a blue colour when brought in contact with the tincture of iodine. In the older cells many of the granules lose the character of starch, and possess other properties. Some of them, and these more minute than those of starch, are not coloured by iodine, and are soluble in alcohol, and partake of a resinous character. They give a blue colour to the elaborated sap, whatever it be. In plants with milky juices constitute a large part of which they yield. They seem also to be the source of the volatile oils, resins, balsams, gums, &c. which are yielded. [SECRECTIONS, VEGETABLE.] Another class of granules are also found present in old cells, and which is what is called *chlorophyl*, or *chromule*, and is found in the cells of plants on their surface, giving to them peculiar colours. [SAP.] It is from the remaining part of starch that the cells are nourished. Previous to their being appropriated by the walls of the cell they are converted into a substance called by Meyen vegetable jelly. It is from this substance, varying in almost every instance of plants, that the cells are thickened, by which the delicate membrane in many cases becomes excessively hard, as in the stones of many fruits, the seed of the *Physalis*, *Macrocarpa*, and the wood of many trees. In simple cellular tissue and in woody tissue this material is applied equally to the whole surface of the cell, forming regular layers: in the fibro-cellular and fibro-vascular tissues it is appropriated in the form of fibre.

Another class of bodies found in the interior of cells, and which appear to have nothing to do with the nutrition of the plant, are those crystalline bodies called *Raphides*. They occur singly or in bundles, and have an acicular form, and are long or short according to circumstances. In length they measure from $\frac{1}{16}$ th to $\frac{1}{8}$ th part of an inch. These crystals were first observed in the proper tissue of plants, and have been subsequently found in all parts of plants where cellular tissue exists. They were formerly supposed to exist between the cells, but later observers have seen them in cells, and they probably exist in both situations. The form of these bodies is not satisfactorily determined. Mohl describes them as right-angled four-sided prisms vanishing into points. Quekett, who is one of the latest observers on this point, says they are generally four-sided prisms, but not always right-angled. Some which are conglomerated are called crystal-glands (*krystaldrüsen*) by Meyen. They seldom present more than a pyramid of each little crystal composing them. The proportion in which they exist in plants is sometimes very great. In some species of *Cactacæ*, according to Quekett, the crystals equal the weight of the dried tissue. One hundred grains of Turkey rhubarb-root yield between 20 and 40 grains of raphides; the same quantity of tissue of *Scilla maritima* yielded 10 grains. In most plants these crystals are composed of either oxalate or phosphate of lime. Raspail says the crystals of the oxalate of lime are four-sided prisms with pyramids of the same base: those of the phosphate, six-sided prisms. In *Chara* crystals of carbonate of lime occur in great abundance on the outside of the tissue, and we have observed them in the intercellular passages immediately under the epidermis, but they do not occur in the interior parts of the plant. Schübler found that the crystal-glands of *Hydrurus* (*Cratellophorus*) consisted of carbonate of lime, and Saugy and De la Fosse found silica in the crystals of the *Murice* of Jalapa. Silica is a very prominent constituent of the *Graminacæ*, but is seldom found crystallized. It gives the hardness to the epidermis of the Dutch rush, and is secreted in large quantities in the joints of the stem of the bamboo, and is used as an article of commerce under the name of *Tabasheer*. From the variable form of the crystals in plants it may be inferred that other salts form them besides the above. These bodies do not appear to be necessary parts of the tissues in which they occur, and they have been compared by Link to *calculi* and other concretions of the animal kingdom. This view is rendered very probable by the fact that they are always composed of those elements which the plants take up from the soil as necessary nutriment. Meyen has pointed out the fact that plants growing near the sea will throw off the superabundance of chloride of sodium in their tissues in the form of crystals: and we have found crystals of carbonate of lime most abundant in *Chara flexilis*, where the water in which it grew contained most of that substance. Phosphate of lime

is necessary to the nutrition of many plants, and the elements of oxalic acid exist in the sap of all plants; and when these are in greater abundance than the vital energies of the plant can appropriate, the laws of chemical affinity come into play, and crystallization is the result.

Growth, Form, &c.—The vesicles of cellular tissue are very small, and cannot be distinguished with the naked eye; and in fact all investigations on the structure, development, and functions of the tissues of plants, can only be conducted with the aid of the microscope. The measurements of the cells give them a size varying from $\frac{1}{16}$ th to the $\frac{1}{4}$ th of an inch in diameter. In the lower tribes, as in the Fungi, their generation is very rapid, and it is well known that mushrooms, puffballs, &c. will attain a great size in the course of a single night. The force too with which they are generated is very great, and there are many well-authenticated instances of agarics springing up beneath pavements and displacing stones of great weight and size.

The walls of the loose spheroidal cells in merenchyma consist of a single membrane, but the walls of the more closely-pressed cells of parenchyma consist of two membranes, originally distinct, but fused into one by growth. It frequently happens that the walls of the cells are not accurately applied to each other, and consequently spaces of various kinds occur between the cells. These are called *intercellular passages*. They occur in the greatest abundance in the loose merenchymatous tissue. When these passages exist between the walls of two cells whose sides are united in their middle and recede towards their margins, they are called by Link *meatus intercellulares*. These are most frequently met with in the epidermis of plants. Where the passages are formed of three or more cells the sides of whose walls do not touch, they are called *ductus intercellulares*. These are very well seen in the parenchyma of the stem of the iris and hyacinth, and Heracleum. These passages have been supposed by De Candolle and others to convey the sap; but this has probably arisen from an error in observation, as they are easily filled with sap when cut through. Others again confound these passages with the peculiar vascular tissue described by Schultes as Laticiferous tissue (Cinenchyma).

Another kind of intercellular formation are the *air-cells*, the *lacunæ intercellulares* of Link, which are large cavities formed in the tissue of plants, and whose walls are entirely formed of cellular tissue. They may be very distinctly divided into two kinds, the *regular* and the *irregular*. The regular exist under the epidermis of many plants and vary in size, but have in all cases a regularity of structure, their sides being formed of equal-sized cells of cellular tissue. They may be seen in the leaf-stalk of Calla ethiopicæ, the stem of Cenanthe Phellandrium, and the petioles of Nymphæa. They are very common in water-plants. They are always filled with air in these plants, and serve as a means of buoying them up in the water. The irregular air-cells, *lacunæ* of Link, are found in old plants; they arise from the growth of the plant tearing under the cellular tissue, or from a deficient development or even the absorption of this tissue in particular directions. They may be seen in the stem of the fronds of the Aspidium Filix Mas, of Hippuris and Equisetum, and in nearly the whole of the family Umbelliferae.

The other organs which are formed by and found in the midst of the cellular tissue are the *sup-cells* and *glands*. The sap-cells, the *opangia* of Link, consist of enlarged cells of tissue, varying much in size, but always filled with laborated sap. They are found in the skin of the fruit of the citron, pomegranate, &c. These are regular in form, but in the roots and rhizomata of such plants as the ginger, Archangelica, and Aristolochia, they are found of an irregular form. The glands, which are by some supposed to be the agents by which the peculiar secretions of the plant are immediately separated from the latex, are composed of cells pressed together, and assuming a variety of forms. When examined, these cells are found to contain in many instances the resin, gum, oil, &c. which give to the plant some of its peculiar physical properties.

The organs just enumerated as present in the cellular tissue are met with chiefly in the merenchymatous and parenchymatous forms.

Vascular or Tubular Tissue consists of continuous tubes of simple membrane, and comprehends the woody and the laticiferous tissues. On the one hand they are distinguished

by their length from the forms of cellular tissue, and on the other hand by their plane membrane from those tissues of which fibre forms a constituent element.

Pleurenchyma, or Woody Tissue (*vasa fibrosa* of Link, and *Fasergefässe*, German), is found abundantly in the wood, and especially the liber, of all plants. It is composed of very long, thin, tough, transparent, membranous tubes. No bars or dots are seen in their walls, although when they cross each other the points at which they touch may be taken for such markings. They taper acutely to each end, and do not appear to have any communication one with the other, although they are occasionally seen with open extremities, which Slack supposes to arise from the breaking off of one fibre where it was united to another. In the wood and bark of dicotyledonous plants they are frequently mixed with prosenchyma, and in monocotyledonous plants with parenchyma. They grow by increasing in length both above and below. Their diameter varies from $\frac{1}{15}$ to $\frac{1}{1000}$ of an inch. The walls increase in thickness by the deposition of vegetable jelly, called by Turpin *sclerogen*, to their insides, and in the woody tissue of *Betula alba* and other trees the sclerogen may be seen forming successive layers around the sides of the tubes. Their form is mostly cylindrical, but in *Cycas revoluta* Link has observed them assuming a prismatic form.

The tubes of woody tissue are very tough, and will resist considerable force without breaking. It is on this account that they are used extensively in the manufacture of cloths of various kinds. The plants used most commonly for this purpose are the hemp and flax. The fibres of *Tilia*, *Daphne*, *Lagetta*, and of many of the plants of the order of Malvaceæ, are used for making mats, cordage, whips, &c. The following is a comparative statement of the relative strength of silk and some woody fibre:—

Silk supported a weight equal to	34
New Zealand Flax	23½
Hemp	16½
Flax	11½
Pita Flax (Agave Americana)	7

Woody tissue gives firmness and tenacity to the plant, and assists in conveying the sap from the roots to the leaves.

Cinenchyma, or Laticiferous Tissue, consists of tubes which are mostly branched and anastomosing; their walls are exceedingly delicate in young plants, and thicker in old ones; and they are characterised by conveying a fluid called the *latex*, which differs from the sap in other parts of the plant. [SAP.] The older botanists, Spigelius, Malpighi, and Grew described them, but they were generally confounded with woody tissue, till they were very fully investigated by Schultes. In older writers they are called *vasa propria* or *peculiararia*; by Link, *vasa opophora*. Some writers have supposed that they are nothing more than intercellular passages, and have denied that they possess membranous parietes; but their existence has been ascertained, and the observations of Schultes on their structure confirmed by Link, Meyen, Mohl, and others. The walls of these vessels are mostly plain, but have been sometimes observed marked with bars and fibres. They do not exist in all plants, and have not been found at all in the lower forms of Cryptogamia, nor in some of the Phanerogamous plants, as *Valisneria* and *Stratiotes*. Their most frequent position is on the sides of spiral vessels, or amongst the bundles of this tissue found in the midrib and nerves of leaves. They are most obvious in the order Euphorbiaceæ, where the latex is of a white colour. This juice is not always coloured or opalescent, but is sometimes quite clear. The tubes are not always regular in size. In some species, as in *Glycine Apios*, they are irregularly contracted and expanded; in *Papaver nudicaule* they have a moniliform appearance; in *Acer platanoides* they are very regular. In the stem they are generally simple, but in very young plants and the younger parts of plants they are branched, and anastomose. (Fig. 3.) Link has observed their terminating in blind extremities. In their distribution they gradually diminish in size, and have been traced into the most delicate parts of plants, as the hairs.

Schultes supposes that these vessels perform the same functions in the plant as the arteries and veins in animals. The fluid in them has a peculiar motion, which he calls *cyclosis*. [SAP.]

Fibro-cellular Tissue, or Inenchyma, consists of cells formed of membrane, in the inside of which fibre is de-

Fig. 3.

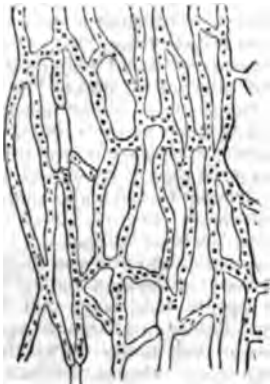

veloped. This tissue may be divided into two kinds, *genuine* and *spurious*; the genuine being that in which the fibre is distinctly marked on the inside of the cell, and the spurious that in which the fibre, either by absorption or the union of its various parts, forms rings, bars, dots, and other appearances on the sides of the cell. The genuine fibro-cellular tissue is mostly found in parenchymatous and proenchymatous cells. It has been known for a long time amongst botanists, and was first described by Hedwig, who was followed by Moldenhawer and others. They are abundant in the external parchment-like layers of aerial roots of Orchidaceæ, and have been described by Meyen in *Oncidium altissimum*, *Acropera Loddigesii*, *Brassavola cordata*, &c. They occur in the hairs of the pericarp of many of the Compositæ, as in *Perdicium taraxaci*, *Senecio flaccidus*, and *Trichocline humilis*. Horkel has described them in the epidermis of many Labiatae, as *Ziziphora*, *Ocimum*, and many *Salviæ*. The seed-coats of many plants possess them, as *Gilia Ipomopsis*, *Polemonium Cantua*, and *Caldaria*; and Kippist has lately demonstrated their presence in many of the species of *Acanthaceæ*. In some of these cases, and many others might be mentioned, the fibre appears to constitute the whole of the cell, as stated under fibrous tissue.

The fibre in these cells varies in its position and form. In the cells of the leaf of *Oncidium altissimum* they are very distinct, and occasionally branched. In the testa of the seed of *Maanandya Barclayana*, where they were first pointed out by Lindley, the fibres run in different directions over each other, forming a network. In the endothecium of *Calla æthiopiaca* they are parallel, and in this form are very common in the same organ of other plants. In the endothecium of *Nymphæa alba* the fibres form regular arches arising from a plane base. In the elaters of *Jungfermannia* and in the testa of *Acanthodium* the cells are greatly elongated, with a single spiral fibre in their interior.

The spurious fibro-cellular tissue includes the porous and dotted cells of many authors; the *cellule porose et punctatæ* of Link. If a portion of the parenchyma of *Viscum album* be examined, the inside of the cells will be found to possess a number of bright spots. They were first discovered by Treviranus in *Cycas revoluta*, and supposed by him to be granules. They were thought by other observers to be pores; hence their name porous cells. Sprengel, Mohl, and Link consider them little vesicles, but Meyen has given a different explanation of their nature. He ascribes their existence to a metamorphosis of the fibres generated in cells. They are often met with in the same cells as fibres, and it is by the union of some parts of the fibre and the absorption of others that the spaces are produced, which when first viewed appear as though they were granules, pores, or vesicles. The same appearance is frequently found in the various forms of fibro-vascular tissue, where there can be little doubt of the spots arising from the irregular formation of the fibres. Even those botanists who do not subscribe to Meyen's view on this point with regard to cellular tissue, admit its correctness in vascular tissue. As it must be admitted that there is no essential difference between the cellular and vascular tissues, it is undoubtedly a correct inference that these spots have the same origin in both tissues.

A transition from porous cells to porous tubes is seen in the tissue which has been called *Bothrenchyma*. In this

tissue, which can be well seen in *Phytocrene*, as in *Cycas*, a number of truncated porous cells are placed on the other so as to form a cylinder, which becomes by the absorption or removal of the cellular part. Porous vascular tissue is referred to this form by Link under the name of continuous *Bothrenchyma*, as the junctions or union of the cells are not visible. When the points of union of the cells are evident, he calls it *labeled Bothrenchyma*.

Dotted cells have their walls marked with dark spots. These cells have been observed in the pith of *Calceolaria floridus* and in the stem of *Dracæna terminalis*. They appear only to differ from the porous cells in the manner in which they are formed having greater opacity, transmitting the light so freely.

Fibro-vascular Tissue, or *Trachenchyma* (*rassa* of Link), consists of tubes, in the inside of which fibres are generated. The fibres of this tissue, like all others, are subject to metamorphosis, the consequence of which is, the tubes present the appearances of rings, bars, and bright and dark spots.

The tubes consist of a very delicate membrane, which is mostly cylindrical; it may however assume a prismatic form when the tubes are in bundles and closely packed together, as in ferns and many monocotyledonous plants. The fibres generated in this tissue are mostly composed of a spiral membrane, which when the membrane is broken, the fibre in most cases is unrolled. It is in the younger tubes that this is most effected; as in the older tubes those changes go on which convert the membrane and the fibre firmly together, and convert the latter into bars, dots, &c. The fibres included in a tube varies; it is frequently counted. They have no fixed direction; some run right to left, others from left to right. Some opinion has existed as to whether the fibres are simple or compound. Schleiden says in most instances they are simple, where they are formed from large globules of fluid, they appear to be tubular in both vascular and cellular tissue.

Link divides fibro-vascular tissue into *genuine* and *spurious*; the former includes all those tubes which possess perfect fibres. The principal forms of fibro-vascular tissue are the *spiral*, *annular*, and *moniliform vessels*. The *spiral vessel* consists of a tube, in which one or more fibres are generated continuously along its sides from one end to the other (d, e, f, Fig. 4.) When the fibres are single, they are

Fig. 4.

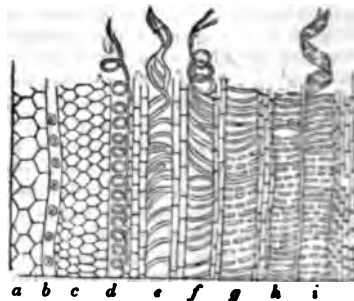

simple; when there is more than one, *compound*. The *annular vessels* are most abundant in young plants; their character becomes changed by age. When the fibres are broken to the sides of the membrane, they are said to be *closed*. The spiral vessel was at one time considered a very important tissue, performing especial vital functions. From the circumstance of air being frequently found in them, and this air containing a larger quantity of oxygen than the atmosphere, they were supposed to carry out the function of respiration. Subsequent observation has proved that they as frequently convey liquid as air. Meyen supposes that they are only filled with air, and that a larger quantity of fluid ceases to be required by the plant.

Annular vessels or ducts consist of tubes with rings of fibre on their sides. (g, Fig. 4.) These vessels are formed from the interruption of the spiral vessel, the union of the broken ends, as they are frequently present with a spiral fibre in the same tube. They are mostly larger than the spiral vessels, and the fibres are thicker: they are very abundant in monocotyledonous

ts; amongst dicotyledons they are found chiefly in the growing plants, as Cucurbitaceæ.

Onitiform vessels have successive dilatations and constrictions of the tube, and a perfect spiral fibre in their interior.

It has been proved by Slack that these vessels derive their peculiar form from accidental compression. They are found in the knots of trees where branches are given in roots, and other parts where they meet with obstacles to their longitudinal development.

Spurious fibro-vascular tissue includes *scalariform*, *annular*, and *dotted vessels*. The spurious vessels are not found in the tissues of young plants, and are either developed after the appearance of the genuine spiroids, or formed from them. Meyen maintains the latter view, Link and other botanists are still inclined to give to the annular and dotted tissues an original development. In the medullary sheath, the spurious spiroids are first found in the young plant, although they are sometimes in the albumen and bark; but it is not necessary that a pure spiral fibre should always be visible previous to being converted into some one of the forms of spurious vessels. If in a very large number of cases there is evidence that rings, bars, and dots are formed from the amorphosis of spiral fibres, we may fairly conclude that those cases where no observation proves to the contrary, the same effects are to be attributed to the same cause.

Scalariform vessels consist of tubes mostly prismatical, with spots on their walls resembling bars or straps. These are placed one above another in a ladder-like form; hence their name. They are abundant in ferns, where the matric form of the spiroid is most frequently seen.

Annular vessels are tubes with bright spots upon their interior walls (*h, i, Fig. 4*); they constitute the continuous Bothrymya of Lindley. They are found in greatest abundance in the old wood of Coniferae, in the same positions where spiral vessels are found, in the young wood, and in the roots of plants. The dots constituting what is erroneously thought to be pores, have the same character as those of fibro-cellular tissue. These vessels do not attain a great size, measuring as much as a quarter of an inch in diameter.

Dotted vessels constitute the tissue which has been called *annular woody tissue*, and to which Meyen applies peculiarly the term *Prosenchyma*. (*Fig. 3; b, Fig. 4*.) The dotted vessel, like the dotted cell, has dark spots on the interior of its membranous walls; but in addition to the dotted vessel is also a circle. This dot does not appear to be formed from the remains of a partly-absorbed fibre, or the crossing of fibres, as in some of the forms of porous cells and vessels, but from the sinuous flexures of one or more vessels uniting together and forming between them a little cavity or depression: this is attended with depression of the external membrane, which gives the appearance of a larger circle surrounding the depression. (*Fig. 2; Fig. 4*.) These phenomena make their appearance very early in the tissues of Coniferous plants; but if buds and young plants are examined, the sinuous spiral vessels, described by Link *vasa spiroida fibrosa*, may be easily seen.

Function.—The function of the tissues of vegetables is so varied as their forms have led botanists to suppose. In a summary of them we give the following. In the simple cell we have the type of all the other tissues, and the lowest forms of plants it alone performs all the functions of the higher plants. The cell of the Ustilago absorbs nutriment from without: this nutriment undergoes changes that fit it for becoming a part of the structure of the cell. This is the process of nutrition. Within this cell another is generated, which is capable of performing the same functions as its parent. This is reproduction. As we ascend in the scale of organization of plants, the structure becomes more complicated. Cells are accumulated together; some simply absorb sap, others expose the surface to the atmosphere; whilst others separate peculiar secretions, and another set are employed as the depositaries of these secretions. As the functions of the plant become more localised in the organs called leaves and flowers, the vessels strong enough to bear them up in the air are required, and the cells are elongated and strengthened by an increase of thickness in their membrane, and woody tissue is formed. Where the same objects are required, but at the same time space for a large quantity of fluid to pass through the cells, fibre is generated within the membrane.

P. C., No. 1551.

brane; and for this reason fibro-cellular, and especially fibro-vascular, tissue is found abundant in succulent plants, and in those which require a large supply of moisture. These tissues are absent or very small in dry plants, as well as those which are constantly immersed in water. In the higher plants the conveyance of the prepared juices from one part of the plant to another is provided for by the Laticiferous tissue. It is upon the cell of the ovule in the Dicotyledonous and Monocotyledonous plants that the mysterious dynamic agency is exerted by another cell from the anther, the result of which is the production of another plant, similar to the one from which it is developed. It will thus be seen that all the tissues of plants partake more or less of the functions of the simple cell, which, as the fundamental form of vegetable organization, performs in all cases the most important functions. It is not so much by a difference in the form as by a difference in the function of particular cells that the complicated organs of the highest plants are distinguished from one another.

(The principal works consulted in preparing this article have been Meyen, *Pflanzen-Physiologie*, band i.; Link, *Elementa Philosophiæ Botaniciæ*; De Candolle, *Organographie Végétale*; Lindley, *Elements of Botany*, and *Introduction to Botany*; Guadichaud, *Recherches sur l'Organographie, &c. des Végétaux*; Bischoff, *Lehrbuch der Botanik*. Papers:—Quekett, *On the Development of Vascular Tissues of Plants*, in 'Trans. Microscop. Soc.', vol. i., 1842; Kippist, *On the Spiral Cells of Acanthaceæ*, 'Linnæan Transactions,' vol. xix., 1842; Schleiden, *Beiträge zur Phyto-genesis*, Müller's 'Archiv,' 1838; Willshire, *On Vegetable Structure*, 'Annals of Natural History,' vol. ix.; Schultes, *Sur la Circulation dans les Plantes*; Lankester, *On the Origin of Wood*, 'Ann. of Nat. Hist.,' 1840.)

TITANIC ACID. [TITANIUM.]

TITANIUM. This metal was first recognised by Mr. Gregor, in 1791, as a distinct substance; he detected it in a black sand found in the bed of a rivulet near Menaccan in Cornwall. In 1795 Klaproth discovered it in some other minerals, and he gave it the name it now bears. The properties of titanium were not however satisfactorily determined until 1822, when Dr. Wollaston examined and described it as it occurred in its perfect metallic and crystallized state, in the slag of an iron-furnace at Merthyr Tydfil in South Wales. The form of the crystals is the cube; their colour resembles that of bright copper; they are sufficiently hard to scratch rock-crystal, and their specific gravity is 5.3.

Titanium is not acted upon by nitric, hydrochloric, or sulphuric acid, either cold or hot, concentrated or diluted; aqua regia, or nascent chlorine, is also powerless, but a mixture of nitric and hydrofluoric acid dissolves titanium: for fusion an extremely high temperature is required: when strongly heated with nitre, titanium is oxidized and rendered soluble in hydrochloric acid, and it is precipitated from solution by the alkalis in the state of a white oxide.

We shall now describe the principal minerals known to contain titanium, except PYROCHLORE, POLYMIENITE, ZIRCONIA, &c., which are described under these heads.

Anatase, Octaedrite, or Oisanite.—This is protoxide of titanium nearly pure. It occurs in attached and imbedded acute octohedral crystals. Primary form a square prism. Cleavage parallel to the terminal planes, and to those of the octohedron. Fracture conchoidal, indistinct. Hardness: scratches phosphate of lime, and is scratched by quartz. By friction becomes negatively electrical, and when heated gives out a reddish yellow phosphorescent light. Colour, various shades of brown, more or less dark, sometimes indigo blue. Streak white. Lustre adamantine. Translucent, transparent. Specific gravity 3.826. It occurs in Cornwall, in Dauphiny, at Bourg d'Oisans, in Spain, Switzerland, and some other places. It consists almost entirely of oxide of titanium, probably the protoxide.

Rutile, or Titanite: Peroxide of Titanium, or Titanic Acid.—Occurs crystallized and in crystalline masses. Primary form a square prism. Cleavage parallel to the lateral planes. Crystals frequently geniculated. Fracture uneven. Hardness: scratches glass, and sometimes quartz. Colour red, reddish brown, and occasionally yellowish. Streak very pale brown. Lustre adamantine. Translucent, transparent, opaque. Specific gravity 4.249 to 4.4. Occurs not unfrequently inclosed in quartz, in fine red filamentous

VOL. XXIV.—3 T

crystals. Rutile is found in Perthshire, Bohemia, Switzerland, especially at St. Gothard, and in various other parts of Europe; and also in Brazil and North America. It consists of, according to H. Rose—oxygen, 33.95; titanium, 66.05. It is frequently more or less mixed with oxide of iron and of manganese, and sometimes with oxide of chromium.

Brookite.—Probably a dimorphous variety of rutile. Occurs in attached crystals. Primary form a right rhombic prism. Cleavage parallel to the lateral planes and short diagonal. Fracture uneven. Hardness: scratches fluor-spar, and is scratched by phosphate of lime. Brittle. Colour, deep red, and reddish or yellowish brown. Streak yellowish white. Lustre adamantine. Translucent, transparent, opaque. Specific gravity unknown. Occurs in Dauphiny and Switzerland, but in larger crystals at Snowdon in Wales. It has not been completely analyzed, but appears to be titanitic acid with traces of iron and manganese.

The minerals which we shall next describe are the titanates of iron: they vary greatly both in form and composition, some being crystallized and others granular; the latter are frequently termed titaniferous iron-sand.

Kibdelophan; Axotomous Iron.—Occurs in imbedded crystals. Primary form a rhomboid. Cleavage perpendicular to the axis; distinct. Fracture conchoidal. Hardness 5.0 to 5.5. Brittle. Colour dark iron black. Streak black. Lustre imperfect metallic. Opaque. Specific gravity 4.661. Found at Gastein in Salzburg; in Sweden, and Siberia. Analysis of a specimen from Gastein, by Kobell:—titanic acid, 59.00; protoxide of iron, 36.00; peroxide of iron, 4.25; protoxide of manganese, 1.65.

Ilmenite.—Occurs in imbedded crystals. Primary form a right rhombic prism. No cleavage observed. Fracture uneven to conchoidal, with a vitreous lustre. Hardness 5.0; scratches glass slightly. Colour black. Opaque. Specific gravity 5.43. It is found near Lake Ilmen in Siberia. Analysis by Mosander:—titanic acid, 46.92; protoxide of iron, 37.86; peroxide of iron, 10.74; protoxide of manganese, 2.73; magnesia, 1.14.

Crichtonite.—Occurs in attached crystals. Cleavage parallel to the axis. Fracture conchoidal, splendent. Hardness: scratches fluor-spar, but not glass. Brittle. Does not obey the magnet. Colour shining black. Streak black. Lustre imperfect metallic. Opaque. Specific gravity 4. It has not been completely analyzed; but, according to Berzelius, it consists of titanitic acid and oxide of iron.

Mohsite.—Occurs in attached maced crystals. Primary form a rhomboid. No visible cleavage. Fracture conchoidal, shining. Hardness: scratches glass readily. Brittle. Does not affect the magnet. Colour iron black. Streak black. Lustre metallic. Opaque. Found in Dauphiny. It appears to be a titanate of iron, but has not been completely analyzed.

Of granular titanate of iron and titaniferous iron-sand, we shall describe three varieties:—

Nigrin.—Occurs in flat rounded grains of about the size of a pea, with occasional indications of a crystalline form. Structure foliated. Very hard. Brittle. Colour greyish black. Lustre metallic. Specific gravity 4.445. Analysis by Klaproth:—titanic acid, 84; protoxide of iron, 14; protoxide of manganese, 2. Found in Transylvania.

Menaccanite.—Occurs in small angular grains. Structure imperfectly lamellar. Fracture fine-grained, uneven. Hardness—yields to the knife. Colour greyish black. Lustre glistening. Opaque. Specific gravity 4.927. Occurs in rivulets in the parish of St. Keverne, Cornwall; it has also been found in New South Wales. The picked grains, analyzed by Dr. Colquhoun, gave—titanic acid, 67.187; protoxide of iron, 39.780; protoxide of manganese, 2.175.

Iserine.—Occurs in very small flattish angular grains, which have a rough glimmering surface. Structure lamellar. Cross fracture conchoidal. Very hard. Slightly attracted by the magnet. Opaque. Lustre semi-metallic. Specific gravity about 4.5. Found on the Riesengebirge, near the origin of the river Iscr in Silesia; in Bohemia; in the river Don in Scotland, and that of the Mersey opposite Liverpool. By the analysis of H. Rose, it consists of—titanic acid, 50.12; protoxide of iron, 49.88. It is probably a variety of Menaccanite.

Greenovite: Titanate of Manganese.—Occurs in small amorphous masses and crystallized. Primary form prob-

ably an oblique rhombic prism. Hardness, greater than that of fluor-spar or phosphate of lime, but does not scratch glass. Colour deep rose red: the crystals are splendent except the terminal faces, which are often dull and unfinished. Specific gravity 3.41. It is found in the manganese deposit of St. Marcel in Piedmont. Analysis by M. Carcarié:—titanic acid, 74.5; oxide of manganese, 24.8.

Sphère; Spinhère: Silico-titanate of Lime.—Occurs in attached and imbedded crystals, and massive. Primary form an oblique rhombic prism. Cleavage indistinct. Fracture even, slightly conchoidal. Hardness: scratches phosphate of lime, but is scratched by felspar. Colour, various shades of grey, green, yellow, and brown. Streak white or greyish-white. Lustre adamantine, resinous. Transparent, translucent, opaque. Specific gravity 3.66 to 3.6. Sphère is found interspersed in primary rocks in granite and gneiss, and more particularly in syenite in Norway, Germany, Switzerland, and also in America. The results of the analysis of sphère vary considerably. The following is by Klaproth:—titanic acid, 33; silicic acid, 35; lime, 33.

Aeschynite.—Titanate of zirconia and cerium. Occurs crystallized. Primary form a right rhombic prism. Cleavage difficult, and only parallel to the base of the primary form. Fracture conchoidal. Hardness: scratches phosphate of lime, and is scratched by felspar. Colour black; streak greyish-black. Lustre resinous. Opaque. Specific gravity 5.14. Found at Miask, in the Ural Mountains, Siberia. Analysis by Hartwall:—titanic acid, 56.0; zirconia, 20.0; oxide of cerium, 15.0; lime, 3.8; oxide of iron, 2.6; oxide of zinc, 0.5.

The principal natural substances containing titanium being now described, we proceed to consider artificial compounds.

Oxygen and Titanium.—It has already been stated that these combine with difficulty by direct means. When rutile, or titanitic acid, is dissolved in hydrochloric acid, a piece of zinc immersed in the solution occasions the formation and precipitation of a deep purple-coloured powder, which is protoxide of titanium: so great however is the facility with which it returns to the state of peroxide, that it cannot be collected; and hence the composition of its oxide has not been perfectly determined. It is however probably composed of—

One equivalent of oxygen	8
One equivalent of titanium	24
Equivalent	32

When also titanitic acid is exposed to a strong heat a portion of it loses oxygen, and a black mass is formed which is the protoxide; it has an earthy fracture, is insoluble in acids, and difficult to reconvert to the titanitic acid. It has been already mentioned that anatase is probably the protoxide of titanium.

Peroxide of Titanium, Titanic Acid.—Rutile is titanitic acid nearly pure: when it is reduced to fine powder and fused in a platina crucible, with three times its weight of carbonate of potash, titanate of potash is obtained, and with some excess of carbonate of potash; this is to be removed by washing with water, and titanitic acid is precipitated by dilution and heat; and after being washed with dilute hydrochloric acid, is nearly pure titanitic acid. Its properties are, that when pure it is quite white, very infusible, and after it has been heated is soluble only in hydrofluoric acid. Its acid powers are feeble; it is insoluble in water, and does not act on vegetable blues; it combines however with alkalis and metallic oxides, forming salts which are termed titanates. It is probably composed of—

Two equivalents of oxygen	16
One equivalent of titanium	24
Equivalent	40

Chlorine and Titanium combine when the gas is passed over metallic titanium at a red heat. It is a colourless transparent fluid, and boils at a little above 212°, is volatilized, and condenses unchanged. When exposed to the air it deliquesces, and when a few drops of it are mixed with an equal bulk of water, combination takes place with considerable violence and the evolution of intense heat. It absorbs dry ammoniacal gas, and from the compound a

d Liebig prepared metallic titanium. It appears
 list of—

Two equivalents of chlorine	72
One equivalent of titanium .	24

Equivalent 96

ure of galls, when added to a solution of titanic
 occasions an orange-red colour, probably owing to
 nic acid which the tincture contains; this is very
 eristic of the presence of titanic acid.

Other compounds of titanium are but little known;
 oxide, or titanic acid, unites both with bases and
 form saline compounds: the former are called
 es.

TITANS (*Titānes*, fem. *Titānides*) is the name by which
 mythology of antient Greece a certain class of sons
 of Uranus and Gaea are designated. The
 name of Gaea was said to have been Titaea, from
 Titans was derived. (Diodorus Sic., iii. 56.) The
 generally comprised under the name of Titans were
 s, Coeus, Crius, Hyperion, Iapetus, Cronus, Thetys,
 Themis, Mnemosyne, Phœbe, Dione, and Theia.
 dor., *Biblioth.*, i. 1, 3; Diodorus Sic., v. 66.) Other
 as Stephanus of Byzantium (*s. v. Ἄδανα*), Pausa-
 ii. 37, 3), and others, differ both in the names and
 s of the Titans. Uranus had by Gaea two other
 children, viz. the Hecatoncheires (centimani, or
 with a hundred arms), and the Cyclops; and these
 cast into Tartarus, at which Gaea, their mother,
 indignant, that she induced the Titans to revolt
 their father, Uranus, and gave to Cronus an ada-
 sickle with which he castrated his father. Ocea-
 k no part in this rebellion. After Uranus was
 l of the sovereignty, and the Hecatoncheires to-
 geth the Cyclops were led back from the lower world,
 ume power was given by the brothers to Cronus.
 nus again threw them into Tartarus, and married
 r Rhea; as however Gaea and Uranus had prophe-
 m that he would be deprived of the sovereignty
 own children, he devoured all the children whom
 ore him. But when she was pregnant with Zeus,
 drew to Crete, where she gave birth to him in a
 and afterwards had him educated by the Curetes
 mphs. To deceive Cronus, she had given him a
 rapt up like a child, which he devoured. When
 d grown up, he took Metis, the daughter of Ocea-
 l with her assistance he administered a poison to
 which made him vomit out the children he had
 ed, viz. Hestia, Demeter, Hera, Pluto, and Poseidon,
 h their aid Zeus now commenced a war against his
 hich lasted for ten years. This struggle, celebrated
 ology as the war of the Titans, was terminated by
 iving the Cyclops from Tartarus, and by his gain-
 ing their weapons the victory over the Titans, who
 w cast into Tartarus, and were guarded there by
 atoncheires. Zeus and his brothers now divided
 reignty of the world among themselves. (*Apollo-*
biograph., i. 1 and 2.)

ame Titan has also been given to those superhuman
 who were descended from the Titans, such as Pro-
 s, Hecate, Latona, Pyrrha, Helios, &c. It more-
 ours as a designation of a very early race of men in
 id Egypt.

ck. *Agloophamus*, p. 763; Böttiger, *Ideen zur*
ythologie, p. 217, &c.; Völcker, *Mythologie des*
hen Geschlechtes, p. 280, &c.)

HFIELD. [HAMPSHIRE, vol. xii., p. 32.]

ES are the tenth part of the increase yearly
 and renewing from the profits of lands, the stock
 nds, and the personal industry of the inhabitants,
 offerings payable to the church by law.

r the theocratic government of the Jews the tenth
 he yearly increase of their goods was due to the
 by divine right. 'And behold I have given the
 of Levi all the tenth in Israel for an inheritance,
 r service which they serve, even the service of the
 cle of the congregation.' (*Numbers*, xviii. 21.) And
 'Thou shalt truly tithe all the increase of the seed,
 e field bringeth year by year.' (*Deut.*, xiv. 22.)
 ll the tithe of the land, whether of the seed of the
 of the fruit of the tree, is the Lord's; it is holy
 e Lord.' 'And concerning the tithe of the herd or
 flock, even of whatsoever passeth under the rod,

the tenth shall be holy unto the Lord.' (*Levit.*, xxvii.
 30, 32.)

In the earliest ages of the Christian church offerings
 were made by its members at the altar, at collections, and
 in other ways, and such payments were enjoined by decrees
 of the church and sanctioned by general usage. For many
 centuries however they were voluntary, and not enforced
 by any civil laws. When the church was struggling
 against persecution, the Christians brought all their
 worldly goods into a common stock for the benefit of all.
 'And the multitude of them that believed were of one
 heart and of one soul: neither said any of them that aught
 of the things which he possessed was his own; but they
 had all things in common.' 'Neither was there any among
 them that lacked; for as many as were possessors of lands
 or houses sold them, and brought the prices of the things
 that were sold, and laid them down at the apostles' feet:
 and distribution was made unto every man according as
 he had need.' (*Acts*, iv. 32, 34, 35.) They then had no
 other object than the defence and support of their faith;
 they required no compulsion to make offerings to their
 infant church. But when the church had increased in
 power, and began to number amongst its members many
 who adhered to it because it was the prevailing religion,
 rather than on account of any enthusiasm or reverence for
 its divine origin and doctrines, it was found necessary to
 enforce certain fixed contributions for the support of the
 ministers of religion. The church relied upon the example
 of the Jews, and required a tenth to be paid. Meanwhile
 the conversion of temporal princes to Christianity, and their
 zeal in favour of their new faith, enabled the church to
 obtain the enactment of civil laws to compel the payment
 of tithes. In England the first instance of a law for the
 offering of tithes was that of Offa, king of Mercia, towards
 the end of the eighth century. He first gave the church
 a civil right in tithes, and enabled the clergy to recover
 them as their legal due by the coercion of the civil power.
 The law of Offa was at a later period extended to the
 whole of England by king Ethelwulph. (Prideaux, *On*
Tithes, 167.)

At first, though every man was obliged to pay tithes,
 the particular church or monastery to which they should
 be paid appears to have been left to his own option. In
 the year 1200, however, Pope Innocent III. directed a
 decretal epistle to the archbishop of Canterbury, in which
 he enjoined the payment of tithes to the parsons of the
 respective parishes in which they arose. This parochial
 appropriation of tithes has ever since been the law of
 the land. (Coke, *2 Inst.*, 641.) The same pope gave
 similar instructions in other countries at about the same
 time.

The tithes thus payable were of three kinds, viz. *prædial*,
mixed, and *personal*. *Prædial* tithes are such as arise
 immediately from the ground, as grain of all sorts, fruits,
 and herbs. *Mixed* tithes arise from things nourished by
 the earth, as colts, calves, pigs, lambs, chickens, milk,
 cheese, and eggs. *Personal* tithes are paid from the
 profits arising from the labour and industry of men engaged
 in trades or other occupations; being the tenth part of the
 clear gain, after deducting all charges. (Watson, *On*
Tithes, c. 49.)

Tithes are further divided into *great* and *small*. The
 former consist of corn, hay, wood, &c.; the latter of
 the prædial tithes of other kinds, together with mixed and
 personal tithes. This distinction is arbitrary, and not de-
 pendent upon the relative value of the different kinds of
 tithe within a particular parish. Potatoes, for instance,
 grown in fields have been adjudged to be small tithes, in
 whatever quantities sown (Smith v. Wyatt, *2 Atk.*, 364),
 while corn and hay, in the smallest portions, still continue
 to be treated as great tithes. The distinction is of ma-
 terial consequence, as great tithes belong, of right, to the
 rector of the parish, and small tithes to the vicar.

No tithes are paid for quarries or mines, because their
 products are not the increase, but are part of the substance
 of the earth. Neither are houses, considered separately
 from the soil, chargeable, as having no annual increase.
 By the common law of England no tithe is due for things
 that are *feræ naturæ*, such as fish, game, &c.; but there
 are local customs by which tithe has been paid from such
 things from time immemorial, and in those places such
 customary tithes may be exacted. Tame animals kept for
 pleasure or curiosity are also exempt from tithes.

Tithes were all originally paid in kind, *i.e.* the tenth wheat-sheaf, the tenth lamb or pig, as the case might be, belonged of right to the parson of the parish as his tithe. The inconvenience and vexation of such a mode of payment are obvious. The practice could only have originated in times and in countries in which barter formed the only means of exchange, and the products of the earth were the sole test of value. The improved habits and civilization of centuries were nevertheless unable to alter what had been sanctioned by custom since the memory of man, and no attempt had been made in this country, until very recently, to introduce a general improvement in the mode of collection. The inconvenience of paying tithes in kind must long since have been felt, and certain modes of obviating it were occasionally practised. Sometimes the owner of land would enter into a composition with the parson or vicar, with the consent of the ordinary and the patron of the living, by which certain land should be altogether discharged from tithes, on conveying other land, or making compensation. In other words, the owner of the land purchased an exemption from tithes. Such arrangements between landowners and the church were recognised by law, but it was found that they were often injurious to the church by reason of an insufficient value being given for the tithes. The acts 1 Elizabeth, c. 19, and 13 Elizabeth, c. 10, were accordingly passed, which disabled bishops, colleges, chapters, parsons, and vicars from making any alienation of church property for a longer term than twenty-one years or three lives. In order to establish an exemption from tithes on the ground of a real composition, it is therefore necessary to show that such composition had been entered into before the statute of Elizabeth. Since that time compositions have rarely been made, except under the authority of private acts of parliament.

Another method of avoiding the payment of tithes in kind was that of a *modus decimandi*, commonly known as a *modus*. This consists of any custom in a particular place, by which the ordinary mode of collecting tithes has been superseded by some special manner of titling. In some parishes the custom has prevailed, time out of mind, of paying a certain sum of money annually for every acre of land, in lieu of tithes. In others a smaller quantity of produce is given, and the residue is made up in labour, as every 12th sheaf of wheat instead of the 10th, but to be housed or threshed by the owner.

A large portion of the land of this country is tithe-free, from various causes. Some has been exempted under real composition, as already explained, and some by prescription, which supposes a composition to have been formerly made. The most frequent ground of exemption is that the land once belonged to a religious house, and was therefore discharged in this manner. All abbots, priors, and other chief monks originally paid tithes from the lands belonging to them, until Pope Paschal II. exempted all spiritual persons from paying tithes of lands in their own hands. This general discharge continued till the time of King Henry II., when Pope Adrian IV. restrained it to the three religious orders of Cistercians, Templars, and Hospitalers, to whom Pope Innocent III. added the Praemonstratenses. These four orders, on account of their exemption, were commonly called the privileged orders. The Council of Lateran, in 1215, further restrained this exemption to lands in the occupation of these religious orders of which they were in possession. Hence that council's Bulls were however obtained for discharging particular monasteries from the payment of tithes, which could not otherwise have been exempted, by which means much land has been ever since tithe-free. Another mode by which lands belonging to religious houses became not liable to the payment of tithes, was that of *modus decimandi*, as was where the lands and the rectory belonged to the same establishment, which would not, of course, pay tithes to itself. Yet the lands were not absolutely discharged by this mode of possession, but upon many instances the payment of tithes was now and then, and the king only suspended the payment. Thus, in 31 Hen. VIII. c. 13, which dissolved the monasteries, the king's letters confirmed the discharge of lands belonging to them, though in the possession of the king or any other person. Many instances of this kind are given in the act of parliament, but as the same was not the case in the reign of Hen. VIII. and some instances of such acts, the lands

of the monasteries dissolved by them became free with tithes.

We have stated enough concerning the nature of tithes, and the various circumstances affecting them, to show that the complicated nature of the laws, and how entangled the interests of different parties who had to pay or receive them. But apart from such considerations it may be said to inquire whether tithes be, in their original nature, a mode of supporting a religious establishment: and if so, in what manner they might be made so. There scarcely be a doubt that the payment of tithes in kind is a cause of constant irritation and dispute between a husbandman and his parishioners. With the best intention on both sides, the very nature of tithes is such, that such and difficulties must arise between them: and even when there is no doubt, the form and principle of payment is odious and discouraging. The hardships and injustice of tithes upon the agriculturist are well described by Paley:—Agriculture is discouraged by every circumstance of landed property which lets in those who have no concern in the improvement to a participation of the profit of all institutions which are in this way adverse to its cultivation and improvement, none is so noxious as that of tithes. A claimant here enters into the produce which is distributed no assistance whatever to the production. Many years perhaps of care and toil have matured an improvement; when the husbandman sees new crops ripening to his skill and industry: the moment he is ready to put his sickle to the grain, he finds himself compelled to share his harvest with a stranger. (*Moral and Political Philosophy*, chapter xii.)

If tithes then be in principle an injurious and vexatious tax upon agriculture, and if the mode of collection be vexatious and unpopular, it became the duty of a legislature to provide a remedy for these evils. But this is not like any other tax, which being found injurious to the state, may be removed on providing others. They are not the property of the state, but of its subjects; they are payable not only to the church, but to lay proprietors: they have been the subject of innumerable private bargains, and have been sold at a higher price on account of its exemption from tithes: the value of the patronage of the greater part of the livings of this country is dependent upon the exemption of land from tithes: in short, the various interests of society have been for centuries so closely connected with the receipt and payment of tithes, that to have abolished them would have been a gross injustice and a great loss to many, and no advantage to the community, because the profit would immediately have been enjoyed by those whose lands were discharged from payments to which they had always been liable, and subject to which they had not probably been purchased.

As for these reasons the extinction of tithes was unpracticable, a commutation of them has been attempted and has been found most successful. Dr. Paley, who very clearly the evils of tithes, himself suggested this improvement. No measure of such extensive concern appears to me so practical, or any single alteration so beneficial, as the conversion of tithes into commutation. In commutation, I am convinced, might be so adjusted as to secure to the tithe-holder a complete and perpetual equivalent for his interest, and to leave to industry its full reward, and to the clergy their just reward. (*Moral and Political Philosophy*, chapter vii.) This principle of commutation is first proposed to be applied by the legislature to lay impropriety, to the common evils of a tithe system, the country was labouring under another. Its people were paying tithes for the support of a clergy possessing a revenue unvaried with their own. Resistance to the payment of tithes occasioned by this appropriation of the land to the clergy, was so general, that a commutation was deemed absolutely necessary for the safety of the church of England. It was recommended by committees of both houses of parliament in 1822, but not finally carried into effect in 1835.

The statutes for the general commutation of tithes in England are the 6 & 7 Will. IV. c. 71, the 7 Will. IV. c. 11, the 1 & 2 Vict. c. 64, the 2 & 3 Vict. c. 32, and the 5 & 6 Vict. c. 54. Their object is to substitute a fixed sum, payable in money, for the tithes according to the average price of corn for seven preceding years, or all tithes, whether payable under a real composition, or not. A voluntary agreement betwixt

the owners of the land and of the tithes was first promoted, and in case of no such agreement, a compulsory commutation was to be effected by commissioners. In case of dispute, provision was made for the valuation and apportionment of tithe in every parish. The rent-charge was to be thus calculated:—The comptroller of corn returns is required to publish in January the average price of an imperial bushel of British wheat, barley, and oats, computed from the weekly averages of the corn returns during seven preceding years. Every rent-charge is to be of the value of such number of imperial bushels and decimal parts of an imperial bushel of wheat, barley, and oats, as the same would have purchased at the prices so ascertained and published, in case one-third of such rent-charge had been invested in the purchase of wheat, one-third in barley, and the remainder in oats. For example, suppose the value of the tithe of a parish to have been settled by agreement or by award at 300*l.*, and that the average price of wheat for the seven preceding years had been 10*s.* a bushel, of barley 5*s.*, and of oats 2*s.* 6*d.*; the 300*l.* would then represent 200 bushels of wheat, 400 bushels of barley, and 800 bushels of oats. However much the average prices of corn may fluctuate in future years, a sum equal in value to the same number of bushels of each description of corn, according to such average prices, will be payable to the tithe-owner, and not an unvarying sum of 300*l.* The quantity of corn is fixed, but the money payment to the tithe-owner varies with the septennial average price of corn. Land not exceeding 20 acres may also be given by a parish, on account of any spiritual benefice or dignity, as a commutation for tithes to ecclesiastical persons, but not to lay impropriators. (6 & 7 Will. IV., c. 71, s. 26-28.)

By the last Report of the tithe commissioners, it appears that already voluntary proceedings have commenced in 9381 tithe districts; 6348 agreements have been received, of which 5804 have been confirmed; 2178 notices for making awards have been issued; 1355 drafts of compulsory awards have been received, of which 1030 have been confirmed; 5220 apportionments have been received, of which 4347 have been confirmed. Of the whole business of assigning rent-charges and apportioning them, about half is completed.

The complete and final commutation of tithes must be regarded as a most valuable measure. It is perfectly fair to all parties, and is calculated to add security and permanence to the property of the church, and to remove all grounds of discord and jealousy between the clergy and their parishioners. Nor must we omit to mention an improvement in the mode of recovering tithes, consequent upon the commutation. There were formerly various modes of recovery, in the ecclesiastical as well as in the civil courts, and before justices of the peace, all more or less leading to unseemly litigation. The present mode of recovering the rent-charge, if in arrear, is by distraining for it in the same manner as a landlord recovers his rent; and if the rent-charge shall have been forty days in arrear, possession of the land may be given to the owner of the rent-charge until the arrears and costs are satisfied. Indeed the whole principle of the tithe commutation Acts is to strip tithes of the character of a tax, and to assimilate them as much as possible to a rent-charge upon the land.

[AGRICULTURE; BENEFICE; FIRST-FRUITS; IMPROPRIATIONS; TAX, TAXATION; TAXATIO ECCLESIASTICA; TENTHS.]

TITHING (*Tithinga*; from the Saxon, *Theothunge*) is an ancient municipal division of land in England under the Saxon kings. The whole country was divided into tithings and hundreds by Alfred the Great. The former was a district containing ten heads of families; the latter comprised ten tithings, or one hundred heads of families. Every tithing had its chief man annually appointed to preside over the rest, who was called the tithing-man or borsholder, and sometimes the headborough or borough's elder. Each of these little communities was bound to keep the peace within their own jurisdiction, and the members were responsible for each other. So important were these associations deemed to be, that no man was allowed to abide in England above forty days without being enrolled in some tithing. Although the institution has long ceased, the name and division are still retained in many parts of England.

TITI, SANTI DI, an Italian painter and architect, born of a noble family at Borgo San Sepolcro in Tuscany, 1538,

was a scholar of Bronzino's, and, according to Lanzi, also studied under Cellini. While at Rome he was employed upon some subjects in the chapel of the Palazzo Salviati, and painted a St. Jerome in San Giovanni de' Fiorentini, besides executing several works in the Belvedere of the Vatican. He returned to Florence in 1566, with a reputation for great ability in design; nor was such reputation at all diminished by the works he there produced, for among them are some of his best, including his Resurrection and Supper at Emmaus, in Santa Croce; of which, and of his other performances, a full account is given by Borghini, in his 'Reposo.' It was also at Florence that he chiefly exercised his profession of architect. The Casa Dardanelli, the Villa Spini at Peretola, and his own house at Florence, are enumerated among his works of that class, but without much commendation; although he is said to have displayed great taste in some of his architectural backgrounds in painting, in which he also showed great knowledge of perspective. His pencil was frequently employed on merely temporary decorations, either on occasions of solemn funeral obsequies or splendid festivities, of which latter kind were those which he painted at the celebration of the nuptials of the duke of Bracciano. Santi died in 1603, leaving a son named Tiberio, who was also an artist, and who did not long survive him.

(*Biogr. Universelle*; Lanzi; Milizia; Vasari.)

TITIAN. [VICELLIO, TIZIANO.]

TITICA'CA, LAKE. [BOLIVIA, vol. v., p. 86.]

TITLARKS. Mr. Swainson characterises the *Titlarks* (genus *Anthus*) as slender-shaped birds, having the plumage and long hinder toes of the true larks, but with the slender bills of the *Wagtails*; and he places the former next to the East Indian genus *Enicurus*, which in his view succeeds to the *Wagtails* (*Motacilla* and *Budytes*). *Anthus* indeed seems to him to have its position at the very extremity of the *DENTROSTRES*, just as the family of the *Alaudinæ*, or True Larks, is in the circle of the *Conirostres*; 'in other words, they are not only analogous, but this analogy actually blends into an affinity.' (*Classification of Birds*. [LARKS.] In the *Synopsis*, at the conclusion of the work, *Anthus* is arranged as the last genus of the *Motacillinæ*, with the following

Generic Character.—Bill very slender, the sides compressed, the upper mandible longest, with the tip deflected over the lower, and distinctly notched. Wings moderate; the four first quills nearly equal: tertials obtuse, lengthened. Tail moderate, slightly forked. Legs slender, black. Tarsus and middle toe equal. Lateral toes and claws of the same length and size. Example, *Anthus aquaticus* (*Fauna Boreali-Americana*, pl. 44). The Prince of Canino also places the genus *Anthus* among the *Motacillinæ*, which, in his arrangement, is the sixth subfamily of the *Turdidæ*.

The True Larks are placed by the Prince, in the same highly useful work (*Birds of Europe and North America*), under the *Alaudinæ*, the fourth subfamily of the *Fringillidæ*, standing between the *Emberizinae* and the *Lozinae*.

The *Alaudinæ* of the Prince comprise the following Genera.—*Certhilauda*, Sw.; *Alauda*, Linn.; *Galerida*, Boie; *Phileremos*, Brehm (*Eremophilus*, Boie); and *Melanocorypha*, Boie. Mr. G. R. Gray (*List of the Genera of Birds*) also makes *Anthus* one of the genera of his *Motacillinæ*, placing it between *Ephthianura*, Gould, and *Corydalla*,^{*} Vigors. The *Motacillinæ*, in Mr. Gray's arrangement, form the seventh subfamily of his *Luscinidæ*.

The True Larks (*Alaudinæ*) are arranged by him as the sixth subfamily of the *Fringillidæ*, with the following

Genera.—*Alauda*, Linn.; *Galerida*, Boie; *Otocoris*, Bonap.; *Melanocorypha*, Boie; *Saxilauda*, Less.; *Erana*, G. R. Gray; *Mirafra*, Horsf.; *Calandrella*, Kaup; *Fringalauda*, Hodgs.; *Megalophonus*, G. R. Gray; *Macronyx*, Sw.; and *Certhilauda*, Sw.

The *Alaudinæ* are placed by this zoologist between the *Emberizinae* and the *Pyrhulinae*.

But we must now return to the *Titlarks*, and we quite agree with Mr. Yarrell, who, in his *British Birds*, observes that it would assist correct definition if, among ourselves, the term *Titlark* could be discontinued entirely; 'the Tree

* In the Appendix Mr. Gray states that *Pipastes*, Kaup, and *Leinopteris*, Kaup, should come next to *Anthus*, and that Mr. Swainson's genus *Agrudroma* should be placed here.

Pipit being called the Titlark by some, the Meadow Pipit a Titlark by others; and round the sea-coast, where the Rock Pipit is generally the most frequent of the three, that is also called Titlark.

Bechstein separated the Pipits from the true Larks, giving the former the generic appellation of *Anthus*, and Mr. Yarrell elevates them into a family, *Anthidæ*.

The following species are British:—

The Tree Pipit, *Anthus trivialis*; the Meadow Pipit, *Anthus pratensis*; the Rock Pipit, *Anthus obscurus* (*Anthus petrosus*, Flem., Jen.; *Anthus aquaticus*, Selby, Gould; *Alauda obscura*, Auct.); and *Richard's Pipit*, *Anthus Richardi*.

The *Titlark* of Pennant is the *Meadow Pipit* of the above list; and Mr. Yarrell well observes that scarcely any two British birds have been so frequently confounded together as the Tree and the Meadow Pipits; but when the two species are examined in hand, obvious and constant distinctions appear; and there are, he adds, besides, differences in the habits of these birds, as well as in the localities they each frequent. 'The Tree Pipit is rather the larger bird of the two; the beak is stouter and stronger; the spots on the breast longer and fewer in number; the claw of the hind toe is not so long as the toe itself; the tertial feathers of the wings are rather longer in proportion to the primaries; the white on the outer tail-feather on each side is neither so pure in colour, nor is it spread over so large a portion of the feather; and, as far as my own observation goes, it does not appear to be so numerous as a species as the Meadow Pipit.'

Unlike the Meadow Pipit, the *Tree Pipit* is a summer visitor, only arriving in our well-wooded enclosures towards the end of April. The male generally begins his agreeable song from the top of a bush or an upper branch of some 'hedge-row elm'; from his perch he rises into the air, his wings shivering, till he has reached an elevation about as high again as the tree from which he started. As soon as he has attained his greatest height he poises his wings, spreads his tail and slowly descends, singing all the while, to the same station whence he rose, or the top of some neighbouring tree. The nest, placed generally on the ground, is framed of moss, root-fibres, and withered grass, lined scantily with bents and hairs. The eggs, four or five in number, vary much in colour in different nests.

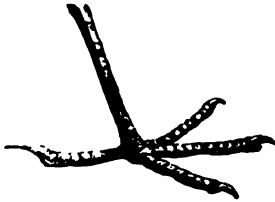

Foot of the Tree Pipit. (Yarrell.)



Tree-Pipit. (Gould.)

Mr. Yarrell considers the most characteristic greyish-white clouded and spotted with purple purple-red; the length of the egg about 10 lines 8. Food, insects and worms. Total length about 6½ inches. This bird must not be confounded with the WOOD-LARK.

The winter-quarters of this species are pro Northern and Western Africa. It is a *Madeira* also inhabits Japan.

The *Meadow Pipit* remains with us throughout and is the smallest and most common species, length being 6 inches only. It haunts heathy districts, as well as meadows and marsh-lands; Yarrell thus describes its habits:—'When from place to place, the flight of this bird is performed in unequal jerks; but when in attendance on its nest, it rises with an equal vibratory motion, singing some musical soft notes on the wing, whilst hovering over its nest, and returns to it after singing. Occasionally it may be seen to alight on low bush; but is rarely observed sitting on the tree, or perched on a rail, which is the common habit of the Tree Pipit. The Meadow Pipit, when on the ground, sits on a slight mound of earth, a clod, or a stone, frequently with his tail up and down like a wagtail; and Wood mentions that he has heard him sing situated on or very near the earth. The Meadow Pipit seeks its food on the ground, along which it runs in pursuit of insects, worms, and small slugs. In the month of one of these birds, examined in the month of Mr. Thompson, of Belfast, found two specimens of *Moss-cheeper* of the north of Ireland, which Sibbald gives as applied to it in Scotland.'

Nest on the ground, generally among grass-dried bents on the outside, with a lining of fine dried bents; eggs from four to six, reddish brown with darker; length nine lines by seven.

Pennant gives *Cor Hedydd* as the Welsh name of the Titlark, and *Hedydd y cae* as that of the Field-lark minor.

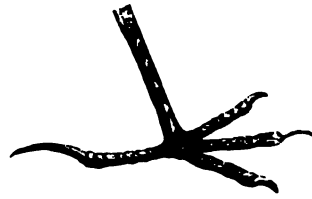

Foot of Meadow Pipit. (Yarrell.)



Meadow Pipit, male and female. (Gould.)

TITLE. [VENDORS AND PURCHASERS.]
TITLE DEEDS. [VENDORS AND PURCHASERS.]

END OF VOLUME THE TWENTY-FOURTH.







