





THE LIBRARY  
OF  
THE UNIVERSITY  
OF CALIFORNIA  
LOS ANGELES

The RALPH D. REED LIBRARY



DEPARTMENT OF GEOLOGY  
UNIVERSITY OF CALIFORNIA  
LOS ANGELES, CALIF.

The RALPH D. REED LIBRARY

DEPARTMENT OF GEOLOGY  
UNIVERSITY OF CALIFORNIA  
LOS ANGELES, CALIF.

*Gift of* Oil Companies of Southern California, Alumni and Faculty of Geology Department and University Library.

1940

R. D. REED  
1478 PENNSYLVANIA AVE  
COLUMBUS, OHIO.

RALPH D. REED

Digitized by the Internet Archive  
in 2007 with funding from  
Microsoft Corporation





1877

1878

1879

1880

1881

1882

1883

1884

1885

1886

1887

## American Science Series

### Physics.

By GEORGE F. BARKER.

### Chemistry.

By IRA REMSEN, President of the Johns Hopkins University.

### Astronomy.

By SIMON NEWCOMB and EDWARD S. HOLDEN.

### Geology.

By THOMAS C. CHAMBERLIN and ROLLIN D. SALISBURY, Professors in the University of Chicago.

### Physiography.

By ROLLIN D. SALISBURY, Professor in the University of Chicago.

### Geography.

By ROLLIN D. SALISBURY, HARLAN H. BARROWS and WALTER S. TOWER, of the Department of Geography, the University of Chicago.

### General Biology.

By WILLIAM T. SEDGWICK, Professor in the Mass. Institute, and EDMUND B. WILSON, Professor in Columbia University.

### Botany.

By CHARLES E. BESSEY, Professor in the University of Nebraska.

### Zoology.

By A. S. PACKARD, Professor in Brown University.

### The Human Body.

By H. NEWELL MARTIN.

### Psychology.

By WILLIAM JAMES, Professor in Harvard University.

### Ethics.

By JOHN DEWEY, Professor in Columbia University, and JAMES H. TUFTS, Professor in the University of Chicago.

### Political Economy.

By FRANCIS A. WALKER.

### Finance.

By HENRY C. ADAMS, Professor in the University of Michigan.

For full descriptions of the Advanced, Briefer, and Elementary Courses published under each topic, see the publishers' Educational Catalog.

**HENRY HOLT & CO.** 34 West 33d Street, N. Y.  
623 S. Wabash Ave., Chicago



*AMERICAN SCIENCE SERIES—ADVANCED COURSE*

---

# PHYSIOGRAPHY

BY

ROLLIN D. SALISBURY

*Professor of Geographic Geology and head of the Department of Geography  
in the University of Chicago*

*THIRD EDITION, REVISED*



NEW YORK  
HENRY HOLT AND COMPANY

1913

COPYRIGHT, 1907  
BY  
HENRY HOLT AND COMPANY

GB  
55  
S 16p 3  
1913

## PREFACE

THIS volume is intended for students of early college or normal-school grade, who have no purpose of pursuing the study of physical geography beyond its elements, but who are yet mature enough for work beyond the grade appropriate for the early years of the secondary schools—the stage when physical geography is usually studied previous to college or normal-school work. No book heretofore prepared has been intended especially for this class of students. The work outlined here is essentially the work covered in the University of Chicago in a twelve weeks' course, taken most largely by students who have but recently entered college. The work outlined might appropriately be expanded to a half-year course, where so much time is available.

In the preparation of the text, the effort has been to shape it, where practicable, so as to lead the student into the subject under discussion, rather than to tell him the conclusions which have been reached by those who have made the subject their special study. This point is illustrated, for example, by the treatment of isothermal maps. This method of work has been found by the author, and by numerous other teachers as well, to be eminently successful in practice; but the author is far from assuming that every teacher will approve of it, or that it is the best for every teacher. That method is best for any teacher which he can use most effectively. If some method other than that of this text leads to better results, the teacher who uses the book should be free to follow it, for text-books should be servants, not masters.

The book contains no specific suggestions to teachers. It assumes that the teacher does not need them. It is the author's belief that if a text were to suggest the means which any ingenious teacher may devise for arousing interest and for holding it through the development and the solution of problems, it would attempt to do much which should be left to individual initiative. The author does suggest, however, that the leading of the student (1)

to raise questions pertinent to the topic under discussion, (2) to formulate them into definite problems, and (3) to discover the means (*a*) of solving the problems, and (*b*) of testing the correctness of his solution, must always be, in large part, the work of the teacher, not of the text-book, and that no thoroughly successful teaching can leave these things undone. The text-book can, at best, hope merely to supply the setting for such problems and such work.

The map exercises which are suggested at various places in the book are essentially those which are used by the author and his colleagues. These exercises may be readily extended, if time permits. These particular exercises have grown up from small beginnings, through the collaboration of Dr. Wallace W. Atwood and Mr. Harlan H. Barrows.

Another phase of work which should not be neglected is work out of doors. This must form a part of the work of every strong course in this subject. Directions for local field work cannot be outlined profitably in a text-book, for the work must be shaped with reference to the specific locality where the subject is studied. Both field work and map work should have for their aim the application of the principles studied, in such a way as to make the subject vital. The aim of every laboratory exercise carried out in connection with this subject should be the same, and any laboratory work which does not either illustrate and enforce principles, or lead to them, is not worth development. The student who cannot apply what he has learned in the class-room to his out-of-door surroundings, has not secured the maximum good from his study of the subject.

It may seem to some teachers into whose hands this volume may fall that some parts are unnecessarily simple, and especially that some things are introduced which the student should know before entering college. In the abstract, the author is in sympathy with this view; but it is to be remembered that large numbers of students enter colleges and normal schools without any knowledge of this subject except that acquired in connection with general geography, as studied in the elementary schools.

The writer is indebted to various colleagues for suggestions of one sort and another in the preparation of this volume, but especially to Mr. Harlan H. Barrows, who has read the manuscript with great care and intelligence, and has made many useful sug-

gestions. Dr. Atwood has also rendered important assistance at various points. Many of the illustrations of the volume have been taken from the larger work on Geology by Professor T. C. Chamberlin and the author. Many others have been taken from the publications of the United States Geological Survey, and a few from other sources, acknowledged in the text.

UNIVERSITY OF CHICAGO, December, 1906.



# CONTENTS

	PAGE
INTRODUCTION.....	3

## PART I

### *THE LITHOSPHERE*

#### CHAPTER I

##### RELIEF FEATURES

RELIEF FEATURES OF THE FIRST ORDER.....	5
The continental platforms, 10. Continuity and discontinuity of continental platforms and oceanic basins, 11. Grouping of the continents, 11. Origin of relief features of the first order, 12.	
RELIEF FEATURES OF THE SECOND ORDER.....	15
Great relief features of the land, 15. Great relief features of the sea bottom, 15.	
<i>Plains</i> .....	16
Coastal Plains, 17. Explanation of contour map, 19. Relief, 19. Drainage, 21. Culture, 21. Interior plains, 22. Topography of plains, 24. Extent and habitability, 25.	
<i>Plateaus</i> .....	28
Position and area of plateaus, 30. Relief of plateaus, 30. Other features of plateaus, 30. Origin, 31.	
<i>Mountains</i> .....	33
Mountains in history, 38. Origin, 39.	
SUBORDINATE TOPOGRAPHIC FEATURES.....	42
Land surface and ocean bottom, 42. The development of minor topographic features, 42. Changes now taking place on the land, 43.	

	PAGE
THE MATERIALS OF THE LAND. . . . .	45
Mantle rock, 46. Rock, 47. Classes of solid rock, 48.	
Sedimentary rocks, 48. Igneous rocks, 51. Metamorphic rocks, 53.	

## CHAPTER II

## THE WORK OF THE ATMOSPHERE

MECHANICAL WORK.—THE WORK OF THE WIND. . . . .	55
<i>Dust</i> . . . . .	55
Universality, 55. Sources of dust, 56. Volcanic dust, 56. Loess, 58. How held in the air, 61. Distribution, 62. Gradational effect of winds, 62.	
<i>Sand</i> . . . . .	62
Sources of sand, 62. Lodgment of wind-blown sand, 62. Dunes, 63. Distribution of dunes, 63. Configuration of dunes, 65. Destructiveness of eolian sand, 65. Migration of dunes, 67. Not all eolian sand in dunes, 69. Ripple-marks, 69. Gradational effects, 69. Abrasion by the wind, 70.	
THE CHEMICAL WORK. . . . .	71
Weathering, 72.	
CHANGES BROUGHT ABOUT UNDER THE INFLUENCE OF THE AIR . .	72
Freezing and thawing, 72. Expansion and contraction of rock; rock-breaking, 73.	
SUMMARY . . . . .	78

## CHAPTER III

## THE WORK OF GROUND-WATER

GENERAL FACTS . . . . .	80
Source of land-water, 80. The fate of rain-water, 81. The existence of ground-water, 83. The source of ground-water, 83. Descent of ground-water, 84. The ground-water surface, 85. Amount of ground-water, 86. The movement of ground-water, 86.	
<i>Springs</i> . . . . .	89
Temperature, 89. Mineral and medicinal springs, 90. Geysers, 90. Artesian and flowing wells, 94.	
THE WORK OF GROUND-WATER . . . . .	96
<i>Chemical Work</i> . . . . .	96
Solution, 96. Deposition, 99. Other changes, 105. Summary, 105.	



	PAGE
<i>Mechanical Work</i> . . . . .	105
Abrasion, 105. Slumping, sliding, etc., 105.	
<i>Weathering</i> . . . . .	110
Conditions affecting weathering, 111.	

CHAPTER IV

THE WORK OF RUNNING WATER

Sources of stream water, 116.	
<b>THE EROSIIVE WORK OF STREAMS</b> . . . . .	120
Load and loading, 122. Carrying, 127. Amount of load, 128. Erosion defined, 129. Deposition a necessary consequence of erosion, 129.	
<i>Changes Made by Rivers in their Valleys</i> . . . . .	129
The deepening of valleys, 129. Depth-limit, 131. The widening of valleys, 131. Width-limit, 134. Valley flats, 135. The lengthening of valleys, 140. Summary, 141.	
<i>The History of a River System</i> . . . . .	141
The courses of valleys, 144. The permanent stream, 145. Not all valleys are grown-up gullies, 146. Growth of tributaries, 147. Stages in the history of a valley, 148. Cycle of erosion, 153. Peneplains, 153.	
<i>Rate of Land Degradation</i> . . . . .	154
Conditions affecting the rate of erosion, 155.	
<i>Exceptional Features Developed by Erosion</i> . . . . .	156
Canyons and gorges, 156. Bad lands, 160. Natural bridges, 161. Rapids and falls, 163. Narrows, 169. Rock terraces, 171. Monadnocks, rock ridges, etc., 171.	
<i>Accidents to Streams</i> . . . . .	173
Drowning, 173. Rejuvenation, 174. Ponding, 175. Piracy, 176.	
<i>Consequent and Antecedent Streams</i> . . . . .	177
<b>DEPOSITION BY RUNNING WATER</b> . . . . .	179
<i>Causes of Deposition</i> . . . . .	180
Loss of velocity, 180. Excess of load from tributaries, 181.	
<i>Location of Alluvial Deposits and their Topographic Forms</i> . . . . .	182
At the bases of steep slopes, 182. In valley bottoms, 184. Flood-plain meanders, 187. Fertility of alluvial plains, 191. River floods, 195. At debouchures, 198. Ill-defined alluvium, 202.	
<i>Alluvial Terraces</i> . . . . .	203

## CHAPTER V

## THE WORK OF SNOW AND ICE

	PAGE
MINOR FORMS OF ICE .....	207
Ice beneath the surface, 207. The ice of lakes, 207.	
Ice on the sea, 210. Ice-foot, 212. Ice in rivers, 213.	
Ground-ice, 214. Snow, 214. Snow-fields, 215. The snow-line, 217. Ice-fields, 218.	
GLACIERS .....	219
<i>The Valley Glacier</i> .....	223
Its surface, 223. Waste and supply of ice, 229. Rate of movement, 229. Conditions affecting rate of movement, 230. Nature of glacier movement, 231.	
<i>Ice-caps</i> .....	234
<i>Piedmont Glaciers</i> .....	240
THE WORK OF GLACIERS .....	242
Erosion, 242. Materials gathered, 251. Deposition of debris in transit, 253.	
<i>Deposition by Glaciers</i> .....	255
The terminal moraine, 257. The ground moraine, 257. Lateral moraines, 257. Distribution and disposition of the drift, 258. Résumé, 260.	
<i>Fluvio-glacial Deposits</i> .....	265
<i>Icebergs</i> .....	269
ANCIENT GLACIERS AND ICE-SHEETS .....	270
<i>Cause of Glacial Epochs</i> .....	273
CHANGES PRODUCED BY THE CONTINENTAL GLACIERS .....	274
<i>Changes Produced by Erosion</i> .....	274
On elevations, 274. In valleys, 274. Rock basins, 275.	
<i>Changes Produced by Deposition</i> .....	275
General distribution of the drift, 275. Terminal moraines, 276. The ground moraine, 278. Effect of drift on topography, 278. Effect of drift deposits on drainage, 280. Stratified drift, 287. Effects of glaciation on human affairs, 287.	

## CHAPTER VI

## LAKES AND SHORES

GENERAL FACTS .....	292
<i>Distribution of Lakes</i> .....	293
In latitude, 293. In mountains, 293. Along rivers, 293. Along coasts, 294. On plateaus, 294. Other situations, 295.	

	PAGE
<i>Area, Topographic Position, Depth, etc</i> . . . . .	295
Area and topographic position, 295. Depth, 296.	
Volume, 297. Movements of lake water, 300. Changes of level, 300.	
<i>Conditions Necessary for the Existence of Lakes</i> . . . . .	301
The sources of lake water, 301.	
<i>Changes now taking Place in Lakes</i> . . . . .	302
The filling of their basins, 302. The lowering of their outlets, 303. Fate of lakes, 303.	
<i>The Origin of Lake Basins</i> . . . . .	303
Diastrophism, 303. Vulcanism, 305. Gradation, 305.	
River lakes, 308. Shore lakes, 311. Glacial lakes, 311.	
Glacial lakes an index of topographic age, 313. Lakes due to slumping, 313. Solution, weathering, wind, etc., 313.	
<i>Salt Lakes</i> . . . . .	314
<i>The Climatic Effect of Lakes</i> . . . . .	316
<i>Economic Advantages and Disadvantages</i> . . . . .	316
<b>THE TOPOGRAPHIC FEATURES OF SHORES</b> . . . . .	317
<i>Gradational Changes now taking Place along Shores</i> . . . . .	317
Waves, undertow, shore currents, 318. Rivers, 329.	
Winds, 330. Glaciers, 330. Shore ice, 333. Extinct lakes, 333.	

## CHAPTER VII

## VULCANISM

<i>Examples of Active Volcanoes</i> . . . . .	341
Stromboli, 341. Vesuvius, 341. Krakatoa, 348. Mont Pelée and Soufrière, 350. Hawaiian volcanoes, 361. Common phenomena of an eruption, 366.	
<i>The Products of Volcanoes</i> . . . . .	367
Lava, 367. Cinders, ashes, etc., 368. Gases and vapors, 368.	
<i>Number, Distribution, etc.</i> . . . . .	368
Number, 368. Distribution, 368. Historical, 371.	
<i>Igneous Phenomena not Strictly Volcanic</i> . . . . .	371
Fissure eruptions, 371. Intrusions of lava, 374.	
<i>Causes of Vulcanism</i> . . . . .	375
<i>Topographic Effects of Volcanic Action.</i> . . . . .	378
Volcanic cones, 378. Destruction of volcanic cones, 382. Examples of fresh cones, 382. Examples of worn cones, 382. Mt. Shasta, 382. Mt. Rainier, 383. Mt.	

	PAGE
Hood, 383. The Marysville Buttes, 384. San Francisco Mountain, 384.	
<i>Indirect Topographic Effects of Vulcanism</i> . . . . .	385
Volcanic necks, 385. Columnar structure, 388.	
<i>Mud Volcanoes</i> . . . . .	388

## CHAPTER VIII

### CRUSTAL MOVEMENTS. DIASTROPHISM

<b>SECULAR CHANGES</b> . . . . .	392
<i>Evidences of Elevation (Relative) of Land</i> . . . . .	393
Human structures, 393. Rocks, 393. Measurements, 393. Organic remains, 393. Raised beaches, 394. Sea cliffs, 394. Sea caves, 394.	
<i>Evidences of Relative Depression</i> . . . . .	395
Human structures, 395. Submerged forests, 396. Submerged valleys, 397. An Italian temple, 397.	
<i>Is it the Land or the Sea which Changes its Level?</i> . . . . .	398
<i>Why the Sea-level Changes</i> . . . . .	400
Sedimentation, 400. Submarine volcanic extrusions, 401. Diastrophism, 401.	
<i>Why the Land Changes Level</i> . . . . .	402
<i>Changes of Level in the Interiors of Continents</i> . . . . .	402
General facts, 402. Extent, 403. Ancient changes of level, 403. Future changes of level, 404.	
<i>Crustal Deformation</i> . . . . .	405
Warping and folding, 405. Faulting, 406.	
<b>EARTHQUAKES</b> . . . . .	408
Definition, 408. Strength and destructiveness, 408. Examples, 412. Earthquakes starting beneath the sea, 420. The earthquake wave, 424. Frequency, 427. Distribution, 429. Causes of earthquakes, 430. Surface changes caused by earthquakes, 432.	

## CHAPTER IX

### ORIGIN AND HISTORY OF PHYSIOGRAPHIC FEATURES

<b>PLAINS</b> . . . . .	435
<b>PLATEAUS</b> . . . . .	437
<b>MOUNTAINS</b> . . . . .	437
Distribution of mountains, 439. Heights, 440.	

	PAGE
Oceanic mountains, 442. Changes taking place in mountains, 443.	
<i>Origin of Mountains</i> . . . . .	445
Volcanic mountains, 445. Mountains produced by erosion, 445. Mountains produced by intrusion and uplift, 447. Mountains produced by folding, 447. Mountains produced by faulting, 448. Summary, 449.	
<i>Effects of Mountains on Mankind</i> . . . . .	450
Climatic effects, 450. Barriers to transportation, 452. Barriers to animals and plants, 452. Ores, 452. Agriculture in mountains, 456. Scenic effects, 456.	
THE OUTLINES OF THE CONTINENTS . . . . .	457
Size, 457. Position, 460. Relief, 460. Distribution of various types of irregularities, 461. Agents of gradation, 462. Diastrophism 463. Vulcanism, 464. Historical bearing 465.	
ISLANDS . . . . .	466
By diastrophism, 466 By vulcanism, 466. By gradation, 466. By combinations of diastrophism, gradation, and vulcanism, 467. By organic processes, 468.	

CHAPTER X

TERRESTRIAL MAGNETISM

Declination, 477. Dip, 479. Intensity, **479.**

PART II

CHAPTER XI

EARTH RELATIONS

Form of earth, 482. Size, 484.	
<i>Motions</i> . . . . .	484
Rotation, 484. Effect of rotation, 488. Revolution, 488.	
<i>Latitude, Longitude, and Time</i> . . . . .	490
Latitude 490. Longitude, 491. Longitude and time, 492. Lengths of degrees, 494. Inclination of axis and its effects, 497. Apparent motion of the sun, 499. Latitude and sun altitude, 502.	
<i>The Solar System</i> . . . . .	504

## PART III

*THE ATMOSPHERE*

## CHAPTER XII

## GENERAL CONCEPTION OF THE ATMOSPHERE

Substantiality, 506. Relation to the rest of the earth, 507. Density and altitude, 507. Height, 508. Volume, 510. Mass, 510. History, 510.

PAGE

## CHAPTER XIII

## CONSTITUTION OF THE ATMOSPHERE

Principal constituents, 512. Minor constituents, 512. Impurities, 513. Relations of constituents to one another, 513.  
*The Functions of the Atmospheric Elements*..... 513  
 Nitrogen, 513. Oxygen, 514. Carbonic-acid gas, 514.  
 Water vapor, 517. Dust, 518.

## CHAPTER XIV

## TEMPERATURE OF THE AIR

The thermometer, 520.

THE HEATING OF THE ATMOSPHERE..... 521

Sources of heat, 521. Sun heating: insolation, 522. Primary distribution of heat, 523. Radiation, 526. Conduction, 526. Convection, 527. How the sun heats the atmosphere, 529.

THE SEASONS..... 531

Differences between summer and winter, 532. Why we have summer when we do, 532. Change of seasons, 533. Seasons in other latitudes, 534. Effect of varying distance of the sun, 536. Effect of altitude on temperature, 537.

REPRESENTATION OF TEMPERATURE ON MAPS..... 539

Isotherms, 539. Isothermal charts, 539. What determines the positions and courses of isotherms? 540. Altitude, 545. Isothermal surfaces, 546.

RANGE OF TEMPERATURE..... 553

Daily, 553. Seasonal, 559.

	PAGE
<b>ATMOSPHERIC TEMPERATURE AND ATMOSPHERIC MOVEMENT.....</b>	<b>561</b>
Land- and sea-breezes, 561. Monsoons, 562. Mountain and valley breezes, 562. Vertical movements and temperature, 563.	

## CHAPTER XV

### THE MOISTURE OF THE AIR

Function of atmospheric moisture, 564. Sources of water vapor: evaporation, 565. Rate of evaporation, 566. Function of the atmosphere in evaporation, 568. Evaporation takes up heat, 568. Amount of water vapor in the air, 568. Distribution of water vapor, 569. Atmospheric moisture and atmospheric movements, 569. Saturation, 569. Humidity and dew-point, 570. Condensation, 572. Condensation and temperature, 572. Dew and frost, 573. Clouds and fog, 574. Forms of clouds, 576. Precipitation, 579. Rain-making, 580. Summary, 580.

## CHAPTER XVI

### ATMOSPHERIC PRESSURE

The barometer, 582. Air pressures unequal, 583.  
*Representation of Pressure on Maps and Charts* ..... 584  
 Isobars, 584. Isobaric surfaces, 587. The courses of isobars, 588. Isobars and parallels, 589. Relation of isobars to land and water, 589. Isobars and temperature, 590. Isobars and humidity, 594. High-pressure belts, 594. Permanent areas of low pressure, 597. Temporary and local variations of pressure, 597.

## CHAPTER XVII

### GENERAL CIRCULATION OF THE ATMOSPHERE

Prevailing and periodic winds, 598. The general effect of unequal insolation, 598. Effect of the extra-tropical belts of high pressure, 600. The high-latitude areas of low pressure, 601. Direction of winds, 602. The circumpolar whirl, 605. Unequal heating of land and water a disturbing factor, 605. Summary, 612. Gradient, velocity, and directions of wind, 613.

	PAGE
<i>The General Circulation and Precipitation</i> .....	614
Rainfall in the zone of the trades, 616. Rainfall in the zones of the prevailing westerlies, 617.	

## CHAPTER XVIII

### WEATHER MAPS

<i>Aperiodic Changes of Pressure</i> .....	620
Isobars, 620. Wind, 622. Cloudiness, precipitation, etc., 623. Temperature, 624. Movements of cyclones and anticyclones, 632. Winds incidental to cyclones and anticyclones, 645. Origin of cyclones and anticyclones of intermediate latitudes, 648. Tropical cyclones, 648. Weather predictions, 656. Failure of weather predictions, 660. Property saved by predictions of storms, frosts, floods, etc., 663.	
<i>Special Types of Storms</i> . . . . .	663
Thunder-storms, 663. Whirlwinds, 666. Tornadoes, 667. Waterspouts, 673. Foehn winds, Chinook winds, etc., 673.	

## CHAPTER XIX

### CLIMATE

Definition, 676. Uniformity and variability, 677.	
<i>Classification of Climates</i> .....	683
<i>Climatic Zones</i> .....	684
Zones defined by latitude, 685. Zones defined by winds, 686. Zones defined by isotherms, 687. Oceanic climates, 688. Continental climates, 690. Mountain and plateau climates, 691. Climatic effect of forests, 692.	
<i>The Climates of the Several Zones</i> .....	693
The tropical zone, 693. Climate of intermediate zones, 695. Climate of the polar zones, 700. Rainfall and agriculture, etc., 701. Climate and life, 702.	
<i>Changes of Climate</i> . . . . .	703
Within historic time, 703. In geologic time, 704.	



## PART IV

## THE OCEAN

## CHAPTER XX

## GENERAL CONCEPTIONS

PAGE

The sea-level, 707. What the physical geography of the sea includes, 709. Distribution of the ocean waters, 710. Depth, 711. Mass, 712. Topography of the bottom, 713.

## CHAPTER XXI

## COMPOSITION OF SEA-WATER

The mineral matter in solution, 717. Withdrawal of mineral matter from the sea, 718. A suggestion as to the age of the ocean, 718. Gases in sea-water, 718. Salinity, density, and movement, 719. Salinity and color, 720.

## CHAPTER XXII

## THE TEMPERATURE OF THE SEA

Temperature of the surface, 721. Temperature and movement, 722. Temperature beneath the surface, 722. The ice of the sea, 726.

## CHAPTER XXIII

## THE MOVEMENTS OF SEA-WATER

<i>Causes of Movement</i> . . . . .	727
Inequalities of level, 727. Wind, 728. Differential attraction of sun and moon, 728. Occasional causes, 729.	
<i>Types of Movement</i> . . . . .	729
<i>Waves</i> . . . . .	729
<i>Currents</i> . . . . .	730
Cause of ocean currents, 733. Climatic effects of ocean currents, 733. Gradational effects of ocean currents, 734. Historical suggestions, 735.	
<i>Tides</i> . . . . .	735
The periodicity and the cause of tides, 736. Solar tides, 741. Spring tides and neap tides, 744. Other variations	

in the height of high tides, 744. Cotidal lines, 748. Rate of movement, 748. Effects of tides on shores, 748. PAGE

## CHAPTER XXIV

THE LIFE OF THE SEA..... 749

## CHAPTER XXV

MATERIALS OF THE SEA BOTTOM. .... 753

## CHAPTER XXVI

RELATION OF THE SEA TO THE REST OF THE EARTH. 756

## PLATES

PLATE	FACING PAGE
I A narrow coastal plain in Oregon . . . . .	20
II A well-drained plain in Kansas. . . . .	24
III An ill-drained plain in Wisconsin. . . . .	25
IV Fig. 1. The Canyon of the Yellowstone River. Fig. 2. The Grand Canyon of the Colorado River. . . . .	30
V Fig. 1. Dunes on coast of New Jersey. Fig. 2. Dunes along Arkansas River in Kansas. Fig. 3. Dunes in plains of Nebraska. . . . .	66
VI Limestone sinks due to solution by ground-water. Near Pikeville, Tenn. . . . .	98
VII Streams disappearing in the sand, gravel, etc., at the base of mountains in an arid region. . . . .	132
VIII A stream widening its valley by lateral planation. . . . .	133
IX Fig. 1. A meandering stream. The Missouri River. Fig. 2. A further stage in the development of a meander. The Schell River, Missouri. Fig. 3. A plain in old age. . . . .	138
X A well-developed river flat. Valley of the Mississippi, near Prairie du Chien, Wis. . . . .	138
XI Stream flats. The Missouri and Big Sioux Rivers. . . . .	139
XII Fig. 1. Youthful Valleys. Shore of Lake Michigan just north of Chicago. Fig. 2. A region in a mature state of erosion. . . . .	150
XIII The Niagara Gorge. . . . .	151
XIV Entrenched Meanders. . . . .	174
XV A piedmont alluvial plain or compound alluvial fan in Southern California. . . . .	184
XVI The alluvial plain of the Platte Rivers in Nebraska. . . . .	185
XVII Glaciers on Glacier Peak, Washington. . . . .	248
XVIII A portion of the Bighorn Mountains, showing glaci- ated valleys. . . . .	249
XIX Characteristic drift topography. . . . .	278
XX Fig. 1. Coastal lakes formed by the blocking of the ends of drowned valleys. Fig. 2. A group of lakes on the coastal plain of Florida. . . . .	294

PLATE		FACING PAGE
XXI	The upper end of Seneca Lake, New York. ....	295
XXII	Fig. 1. A coast line developed chiefly by wave erosion.	
	Fig. 2. An island tied to the mainland by a "beach" . . .	322
XXIII	A section of the California coast, showing lands, near the coast, which have recently emerged. ....	394
XXIV	Cushetunk and Round Mountains, New Jersey. ....	395
XXV	Dunning Mountain, Pennsylvania. ....	438
XXVI	An area southwest of Denver showing a mountain ridge dissected by erosion. ....	439

# PHYSIOGRAPHY



# PHYSIOGRAPHY

## INTRODUCTION

**Definition.** The science of *physiography* has been variously defined, and while there is still much difference of opinion as to the precise limits that should be set to it, there is a strong disposition, in the school world at least, to regard physiography as one with physical geography. In England, physiography is often regarded as a general introduction to science, and is made to include the elements of all the physical and biological sciences. In some other quarters physiography is regarded as the physical geography of the land.

If physiography be regarded as another name for physical geography, it has to do with (1) the solid part of the earth, the *lithosphere*, (2) the water of the earth, the *hydrosphere*, and (3) the air or *atmosphere*. Physiography, however, does not deal with these several spheres exhaustively. The science of the atmosphere is *Meteorology*; the science of the ocean, which contains the larger part of the water of the hydrosphere, is *Oceanography*; and the science of waters in general is *Hydrography*. The complete study of the lithosphere includes several subordinate sciences, all of which may be considered to be parts of the broad science of *Geology*, which has to do, to some extent, with the atmosphere and the hydrosphere, as well as with the lithosphere.

Physiography may be said to deal with the atmosphere only in so far as the atmosphere affects the land, the water, and life, and it deals with the water primarily in its relations to the land and to life. So far as concerns the lithosphere, physiography deals with its surface only, though it is more than a mere description of the surface; it involves a consideration of the conditions and processes which have brought the surface to its present state. The processes involved are largely the result of the activity of the water and the air, and of the life conditioned by them; but other factors,

such as volcanic forces, and the forces which cause the slow warpings of the outer part of the lithosphere, are also involved. In other words, *physiography has to do primarily with the surface of the lithosphere, and with the relations of air and water to it. Its field is the zone of contact of air and water with land, and of air with water.*

Physiography is not sharply separated from *geology*. Geology has to do with the history of the earth; while physiography has to do with a late chapter only of that history,—the history of the present surface. Every period of the past has had its physiography, and the history of the successive physiographies, could they be fully known, would give, in large part, the history of the earth.

Physiography is also closely related to *geography*, but it departs from that science in that it has to do primarily with the relations of the lithosphere, atmosphere, and hydrosphere, and with the physical results of these relations, while geography, as contrasted with physical geography, concerns itself primarily with the distribution of life (including man) and human industries, as affected by the condition of the land surface, climate, resources, etc. Physiography may be said to be, on the one hand, a special phase of geography, namely, physical geography, and, on the other, a special chapter of geology, namely, the latest. Since physical geography affects the distribution of life and all its activities, it is not out of place, in its study, to touch again and again the biological and historical bearings of the subject.

Although the lithosphere, the hydrosphere, and the atmosphere seem very distinct from one another, they are in reality somewhat less sharply separated than they seem, for though the larger part of the hydrosphere is contained in the ocean, lakes, and rivers, a not inconsiderable part has sunk into the soil and rocks, while a smaller amount always exists in the form of vapor in the atmosphere. The water therefore invades both the lithosphere below and the atmosphere above. So, too, a part of the atmosphere penetrates the soil and the rocks of the land, and is mingled with the water of the ocean, lakes, and rivers. Again, solid matter from the lithosphere is found in suspension in streams, lakes, etc., often making them muddy, and dust is always present in the atmosphere. In spite of the interpenetration of these three spheres, they remain so distinct that the boundaries between them are usually well defined.

In the development of our subject, the lithosphere, the atmosphere, and the hydrosphere will be considered in order.



# PART I

## THE LITHOSPHERE

### CHAPTER I

#### RELIEF FEATURES

THE oceans cover nearly three-fourths of the surface of the earth, while but little more than one-fourth of the lithosphere rises above the level of the seas, forming land. The volume of the water in the oceans is so great that if the surface of the lithosphere were reduced to a common level, that is if the protuberant parts were planed down and the material deposited in the depressed areas, there would be no land at all, but a universal ocean nearly two miles deep. The existence of land therefore results from the fact that the surface of the solid part of the earth is uneven, and that the water has settled in the depressions.

It would help us to get a true picture of the surface of the solid part of the earth, if we could see it without the oceans; but since the oceans cannot be withdrawn, some conception of its surface may be gained from a relief model of the earth which does not represent the water (Figs. 1 and 2); or, if such a model is not available, relief maps and charts of the ocean are serviceable.

#### RELIEF FEATURES OF THE FIRST ORDER

The most significant feature in the surface of the lithosphere is the contrast between the great depressions, which we call the *ocean basins*, and the broad elevations, which we call the *continental platforms*. The continental platforms and the ocean basins are *topographic features of the first order*. The contrast between them is emphasized by the fact that there is almost everywhere a rather steep slope from the one to the other,—a steep descent from the

continental platforms to the ocean basins, or, looked at from the other point of view, a steep ascent from the ocean basins to the continental platforms (Figs. 1, 2, and 3).

The ocean basins and the continental platforms divide the surface of the earth between them. Both the basins and the platforms are irregular in shape and irregular in distribution. The larger part of the elevated areas is in the northern hemisphere, while the depressed areas are far in excess in the southern.

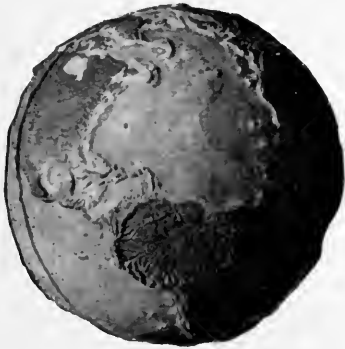

FIG. 1.



FIG. 2.

FIG. 1.—Photograph of the Jones Relief Globe, showing the North Atlantic Basin depressed notably below the continents about it. The vertical scale of the globe is exaggerated.

FIG. 2.—Photograph of the Jones Relief Globe, showing the basin of the Indian Ocean, with its distinctly marked borders.

The continental platforms are somewhat larger than the continents (Fig. 3), and the ocean basins are somewhat smaller than the oceans. The oceanic area (more than 143,000,000 square miles) is nearly three times the land area (nearly 54,000,000 square miles), but the area of the ocean basins proper (about 133,000,000 square miles), is only about twice as great as the area of the continental platforms (about 64,000,000 square miles). The discrepancy between the area of the oceans and that of the ocean basins results from the fact that there is more water on the earth than the true ocean basins will hold, and this excess overruns the rims of the basins, and spreads itself out on the low borders (the continental shelves) of the continental platforms (Figs. 4 and 6).

Some 10,000,000 square miles about the borders of the continental platforms are thus covered by shallow water. The result is that the area of the continents falls short of the area of the continental platforms by this amount, while the area of the oceans correspondingly exceeds that of the ocean basins. The waters which

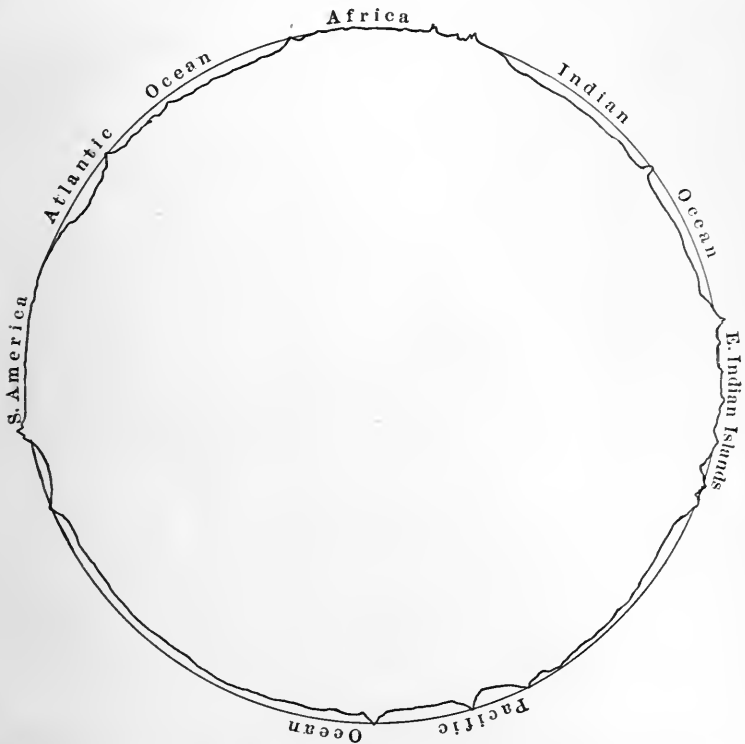

FIG. 3.—A diagrammatic section of the earth about the equator, showing the elevated segments (continents) and the depressed segments (ocean basins). Vertical scale  $\times 40$ . (Based on section in Stanford's Atlas of Universal Geography.)

lie on the low borders of the continental platforms have been called *epicontinental* (upon the continent) *seas*.

If all lands were graded to a common level without increasing or decreasing either their area or the amount of material they contain, their height above sea-level would be about 2300 feet. If the bottom of the sea were graded to a common level, its area remaining as now, the water would be between 12,000 and 13,000

feet deep everywhere. The average height of the land is therefore a little less than half a mile above sea-level, while the average

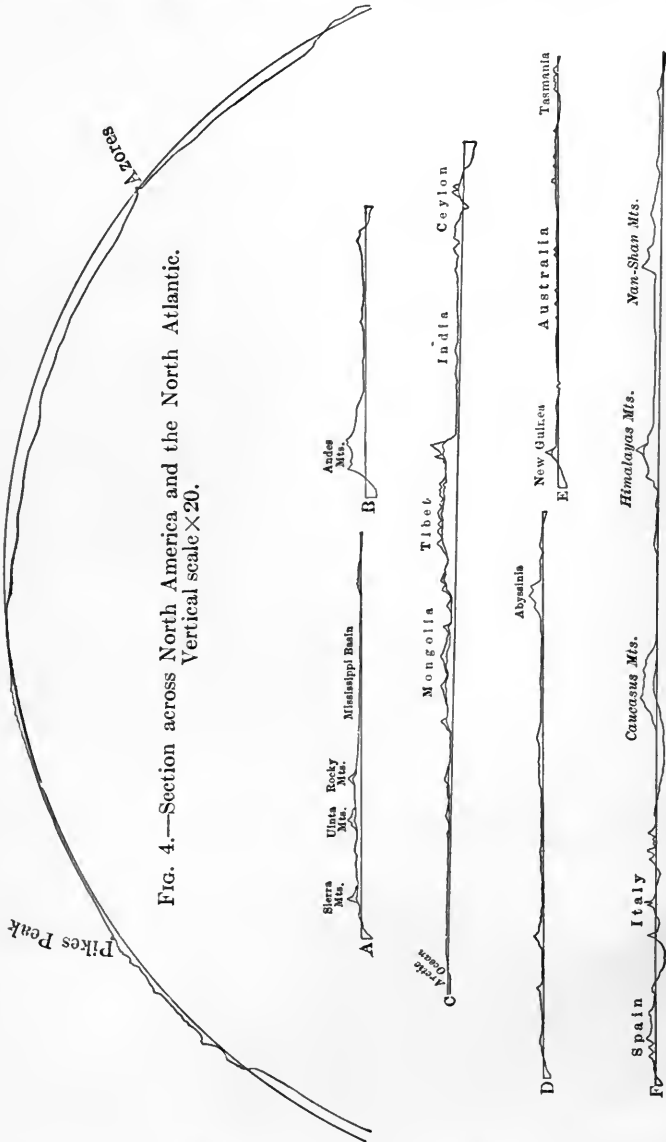

FIG. 4.—Section across North America and the North Atlantic.  
Vertical scale  $\times 20$ .

FIG. 5.—Sections across several continents, in latitudes indicated by the names.  
Vertical scale exaggerated.

depth of the ocean bottom is but little less than two and a half miles below sea-level. The difference between the average height

of the continental platforms and the ocean basins is therefore about three miles. In other words, *about two-thirds of the surface of the solid part of the earth is sunk about three miles below the other third.* Three miles is a little less than  $\frac{1}{13\frac{1}{10}}$  of the radius of the earth.

The surfaces of both the continental platforms and the ocean basins are uneven, and as a result, the maximum unevenness, or relief, of the surface of the lithosphere is much more than three miles. Its lowest known point, near the Fiji Islands, is nearly six miles (about 31,000 feet) below the level of the sea, while its highest point (Mt. Everest in the Himalayas) is nearly as much (about 29,000 feet) above the same plane. The maximum relief of the lithosphere is therefore nearly twelve miles, or about  $\frac{1}{3\frac{1}{3}}$  of the earth's radius. The areas of those parts of the ocean basins which approach a depth of six miles are, however, very limited in extent, and the areas of land which approach the height of six miles are hardly more than points.

The following table gives some idea of the relief of the lithosphere:

	Approximate percent. of total area of the earth.
Area of land more than 6000 feet above sea-level	2.3
Area of land between 6000 and 600 feet above sea-level	18.6
Area of land between 600 feet above sea-level and sea-level	6.9
Area of ocean where water is less than 600 feet deep	7.
Area of ocean where water is between 600 and 6000 feet deep	7.
Area of ocean where water is between 6000 and 12,000 feet deep	14.8
Area of ocean where water is between 12,000 and 18,000 feet deep	39.4
Area of ocean where the depth of the water exceeds 18,000 feet	3.1



Fig. 6.—Diagram to show the distinction between an elevated continental segment and an ocean basin. The steep slope (much exaggerated) at the left of the ocean basin is the line of contact between the two, and is the real border of the continental segment. The ocean covers the lower part of the continental segment, namely, the *continental shelf*. The diagram also shows the general relation between low mountains, such as the Appalachians, a low plateau, and a coastal plain. The continental shelf is seen to be a continuation of the coastal plain.

This table shows that more than half the lithosphere is more than a mile below sea-level.

The following table shows the proportion of land at various elevations above the sea:

	Percent. of land.
Less than 600 feet.....	about 21.90
Between 600 and 1,500 feet.....	about 21.63
Between 1,500 and 3,000 feet.....	about 21.34
Between 3,000 and 6,000 feet.....	about 19.51
Between 6,000 and 12,000 feet.....	about 12.34
Between 12,000 and 18,000 feet.....	about 2.95
Above 18,000 feet.....	about .33

This table shows that about two-thirds of the land has an elevation of less than 3000 feet. About six-tenths of the land is less than 500 meters<sup>1</sup> (1640 feet) above sea-level, and upon it the larger part of the population of the earth lives. The facts shown in the above table are expressed diagrammatically by Fig. 7.

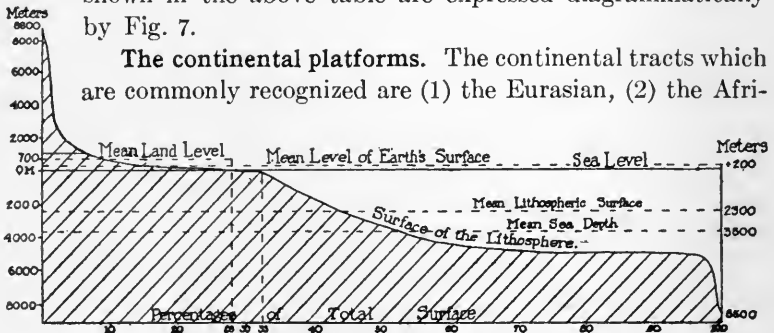

FIG. 7.—Diagram showing the relative areas of the lithosphere at various levels above and below sea-level. Less than 10 percent. of the lithosphere is as much as 700 meters above the sea, and only 28 percent. is above the sea. About half the total surface of the lithosphere is more than 3500 meters below sea-level. The diagram also shows that the mean surface of the lithosphere is about 2300 meters below sea-level, the mean ocean depth about 3500 meters, and the mean elevation of the land above the sea-level about 700 meters. (After Wagner.)

can, (3) the North American, (4) the South American, and (5) the Australian, which includes New Guinea on the north. Besides these elevated segments whose summits are the recognized continents, there are other lesser though still great segments not commonly recognized as continental. Of these the largest is (6) Antarctica, which should probably be regarded as a continent, and (7) Greenland, which is universally regarded as an island. Islands, in

<sup>1</sup> It is serviceable to remember that 1 meter = 3.281 (approximately) feet.

general, are not to be looked upon as relief features of the first order, and will be referred to in other connections.

**Continuity and discontinuity of continental platforms and oceanic basins.** The great land areas are notably discontinuous, while the sea is continuous, though its parts bear separate names, as Atlantic, Pacific, etc. In contrast with the lands and the seas, the continental platforms are much more nearly continuous than the continental lands, while the ocean basins are less continuous than the oceans. Thus the American continental protuberance is connected at the northwest with the Asian protuberance, and is but slightly disconnected at the northeast from the European, while the elevated Eurasian platform is connected with the Australian and the African. Of the continental protuberances, Antarctica alone seems to be really isolated. Of the ocean basins, the Arctic is measurably isolated. It is of interest to note that the most isolated basin is about one pole, and the most isolated protuberance at the other, so far as present knowledge of the polar regions allows of generalization. Some of the smaller deep basins, such as those of the Mediterranean and the Gulf of Mexico, have some such measure of isolation as some of the larger islands, as, for example, Greenland and New Zealand.

**Grouping of the continents.** The northern hemisphere con-

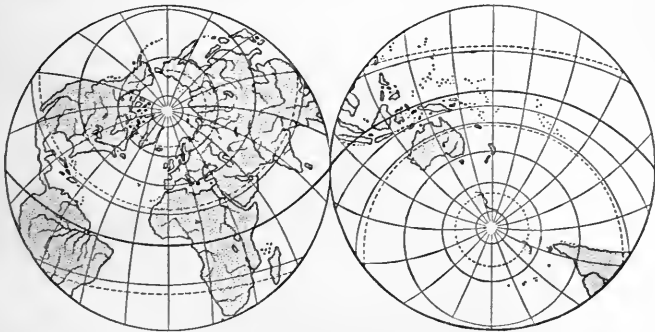

FIG. 8.—Land and water hemispheres.

tains more than twice as much land as the southern. If the earth be divided into two hemispheres having their poles in England and New Zealand, respectively (Fig. 8), the first would contain about  $\frac{3}{4}$  of all the land, and might be called the land hemisphere, while the latter would contain only about  $\frac{1}{4}$  of the land, and might

be called the water hemisphere. Even in the land hemisphere, however, the water would cover rather more than  $\frac{1}{2}$  the surface, while in the water hemisphere it would cover about  $\frac{1}{3}$  of it (Fig. 8). Since the northern hemisphere contains  $\frac{2}{3}$  of the land and a still higher proportion of the economically efficient land, it has always supported the larger part of the human race.

Taken together, the continents may be looked upon as forming a great horseshoe-shaped protuberance of the lithosphere, extending around the Atlantic from Cape Horn through the Americas and Europe to the Cape of Good Hope in Africa, with a spur stretching to the southeast to the East Indies and Australia.

If Europe and Asia be regarded as separate, the continents, except Antarctica, may be grouped in pairs. The Americas form one pair, Europe and Africa another, and Asia and Australia a third. Considered in this way, the longest line of each pair is in a general north and south direction. The continents are often said to be triangular in shape, with their broadest ends to the north, and their apexes to the south. This is conspicuously true of South America, and less conspicuously true of North America and Africa; but it is not true of Europe and Asia, either by themselves or combined, or of Australia or Antarctica.

**Origin of relief features of the first order.** The origin of the ocean basins and the continental platforms is not known with certainty. It is not certain that they have always existed, and it is not likely that the former have always been depressed as much as now below the latter, though there has apparently been little change for ages. The best opinion seems to favor the view that the sinking of the ocean basins, rather than the elevation of the continental platforms, has been the important factor in the development of the topographic features of the first order. The chief reason for this view is the general fact that the earth is cooling, and therefore shrinking. Shrinking means that the outside is getting nearer (on the average) to the center. This must result in the depression of the surface on the average, though not necessarily at every point.

If the subsidence of the ocean basins be the principal factor in developing the great relief features of the lithosphere, we might think of the continental platforms as having been (1) wedged up (Fig. 9), or warped (Fig. 10) up between the sinking parts; (2) as having remained where they were before the sinking of the depressed



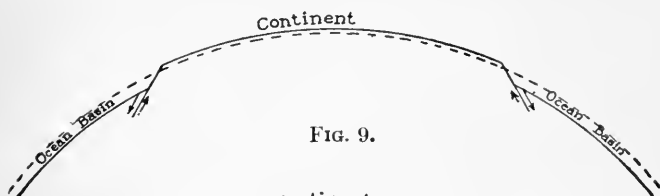

FIG. 9.

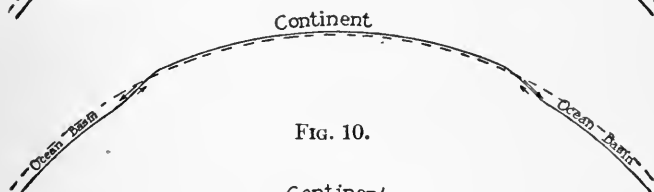

FIG. 10.

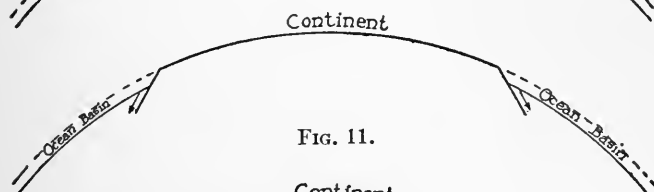

FIG. 11.

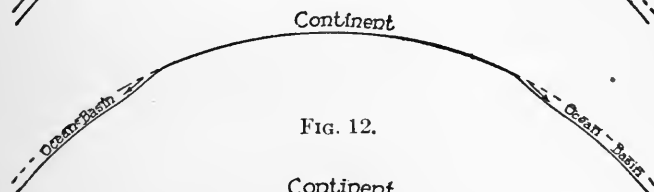

FIG. 12.

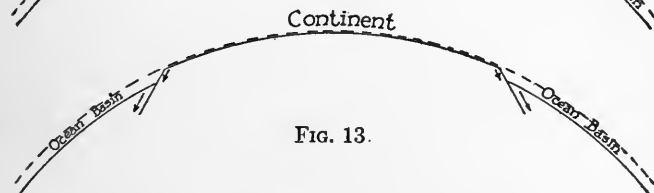

FIG. 13.

Fig. 9 expresses diagrammatically the conception that the continents were elevated and the ocean basins depressed by movement along definite sliding planes or *fault planes*. The dotted line may be taken to represent a somewhat uniform original surface, which may be looked upon as the hypothetical surface before continents and ocean basins were developed. The diagram indicates that the continents have risen above this surface, while the ocean basins have sunk below it.

Fig. 10. This diagram represents the same conception as Fig. 9, except that the movement was by warping instead of faulting.

Fig. 11. This diagram represents the same conception as Fig. 9, except that the continental segment is represented as not having risen.

Fig. 12. This diagram represents the same conception as Fig. 10, except that the continental segment has not risen.

Fig. 13. This diagram represents the same conception as Fig. 11, except that both ocean basin and continental segment are represented as having sunk below the original level, the former much more than the latter.

parts (Figs. 11 and 12); or (3) as having sunk, but as having sunk less than the basins (Fig. 13). All these conceptions imply change in the relative positions of continental platforms and ocean basins. All may have elements of truth in them, and all may have been combined, so far as now known, in the evolution of the continents. Present knowledge, however, does not permit of a definite statement of their relative value, nor does it exclude other conceptions of the origin of the topographic features of the first order. It is, for example, possible, or even probable, that the surface of the lithosphere was never uniform, and that the topographic features of the first order are not entirely the result of deformation.

One conception of the origin of ocean basins and continental platforms is based on the view that the earth grew to its present size from a smaller ancestral body by the ingathering of matter which was once outside itself, and that this growth was not equal in all places. On this view, its surface may never have been smooth. Even if this conception be the true one, it is altogether probable that movements in the outer parts of the earth have set off the ocean basins and the continental platforms from each other more and more sharply in the course of the long history of the earth.

Even if we suppose that the ocean basins have sunk, or that the continents have been upraised, the times of movement are no better known than the methods; but it is probable that the movements have been intermittent rather than constant, and that periods of movement, for example periods of sinking of the ocean basins, have been followed by periods of quiet.

Geological history reveals the fact that the areas of the ocean and land have changed somewhat from time to time, but it is not known that the relative positions of ocean basins and continental platforms have changed notably. If the bottom of the sea were to sink, the ocean basins would hold more water, and some part of the epicontinental sea would be drawn off the submerged parts of the continental platforms, that is off the continental shelves. If the bottoms of the ocean basins were to sink about 600 feet, the water would be drawn off the continental shelves, and the continental lands would correspond with the continental platforms. If the continental tracts, on the other hand, were to sink, the waters of the sea would encroach upon their borders farther than now, and the area of the land would be diminished. Geology

teaches that such changes as these have taken place at various times in the past, so that the lower portions of the continental platforms have been alternately submerged, and converted into land.

#### RELIEF FEATURES OF THE SECOND ORDER

The continental platforms and the ocean basins are the relief features of the first order. The more strongly marked lineaments of these two great divisions of the lithosphere are the relief features of the second order.

**Great relief features of the land.** The continental platforms are made up of *plains*, *plateaus*, and *mountains*. The plains are the lowlands of the continents, and the plateaus and mountains are the highlands; but no one of these great types can be defined in terms of altitude alone. Most continental lands may be readily classed in some one of these three divisions, but many small islands do not seem clearly referable to any one of them. The difficulties which they present need not, however, be considered at this point.

**Great relief features of the sea bottom.** The major topographic divisions of the land may be contrasted and compared with those of the sea bottom. The continental shelves which, it will be remembered, are really parts of the continental platforms, are submerged plains. They are below the sea-level by an amount comparable to the elevation of the land-plains above it. Some of the land-plains are, however, much higher above the sea than

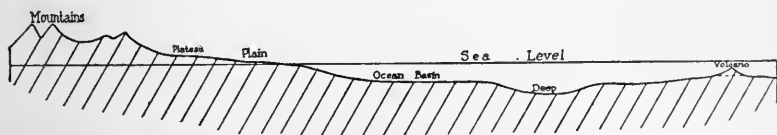

FIG. 14.—Diagram to illustrate the relations of mountain, plateau, plain, ocean basin, ocean deep, etc.

any continental shelf is below it. The great areas of ocean bottom covered by water one to three and a half miles deep may be compared to the higher plains and the plateaus of the land, in reverse; while the very deep tracts of limited extent on the ocean bottom may be compared to very high plateaus, such as Tibet, in reverse. Deep holes in the sea-bed, corresponding to mountain peaks in reverse, are not known to exist. From the tables on page 9, and from Fig. 7, it will be seen that the very deep areas

of the sea, say more than 12,000 feet, are much more extensive than the correspondingly high areas of the land (p. 10), while the low areas of the land (plains) are much more extensive than the shallow (epicontinental) part of the sea.

The relation between the topography of continental platforms and ocean basins may be made clear in another way. Extensive areas of plateaus and lesser areas of mountains rise above the average level of the continental platforms, while a few relatively small basins, some of them occupied by lakes, sink far below it. Similarly, ridges and peaks, roughly comparable to the mountains of the land, and broad areas such as the continental shelves, comparable to the plateaus, rise well above the general level of the ocean floor, while relatively small basins (deeps) are depressed far below it. These relations are expressed diagrammatically in Fig. 14. Fig. 7 expresses the relations of the surface of the lithosphere to sea-level both in extent and in relief.

### Plains

The plains are the lowlands of the earth, yet they can hardly be defined in terms of altitude above sea-level, the datum to which all elevations are commonly referred. They may be but a few feet above sea-level, or they may be thousands of feet above it. In the latter case, however, they are generally far from the sea, and distinctly lower than other lands on at least one side. Fig. 15 is intended to give some idea of the relations of large plains. It will be seen that plains may be as high



FIG. 15.—Diagram showing section across North America. The area between the Sierra and the Uinta Mountains is a great plateau, though with minor mountain ranges. The "Great Plains" are really a plateau, and are much higher than the Cumberland Plateau farther east. Parts of the Great Plains are higher than the Appalachian Mountains.

above sea-level as low plateaus are, or even as low mountains, though this is not usually the case. They are never as high as plateaus or mountains in their own vicinity.

Plains differ widely among themselves, not only in height, but in position, in size, in topography, in fertility, in origin, and in various other ways. Various names are applied to various types of plains, the names being intended to direct attention to one or another distinctive feature. Considered as topographic features of the second order, the most important classes of plains are *Coastal Plains*, which border the sea, and *Interior Plains*, which are far from the sea, or separated from it by high lands.

**Coastal Plains.** These plains occur on the borders of many continents, as along the eastern coast of the United States south of New York. They may be narrow or wide. A narrow plain is shown in Fig. 16, which represents a diagrammatic plain, not an actual

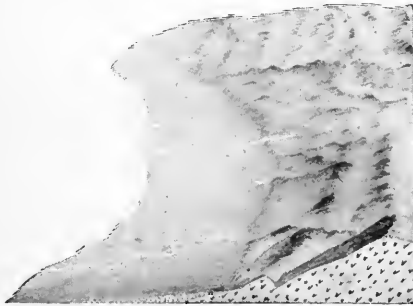

FIG. 16.—A narrow coastal plain.

one. It is low, and has a nearly plane surface which slopes gently toward the sea. Its surface is made uneven by the shallow valleys of the streams which flow across it. The inner edges of coastal plains are not always so clearly defined as in this illustration.

A narrow coastal plain may have originated in either of two ways: (1) It may be a part of the former continental shelf from which the sea has withdrawn, or (2) the sediment washed down from the land may have been deposited in the shallow water of an epicontinental sea, building up (aggrading) its bottom above the surface of the water, and thus converting it into land. Coastal plains have been made in both these ways, and both processes have often been concerned in the making of a given plain. Coastal

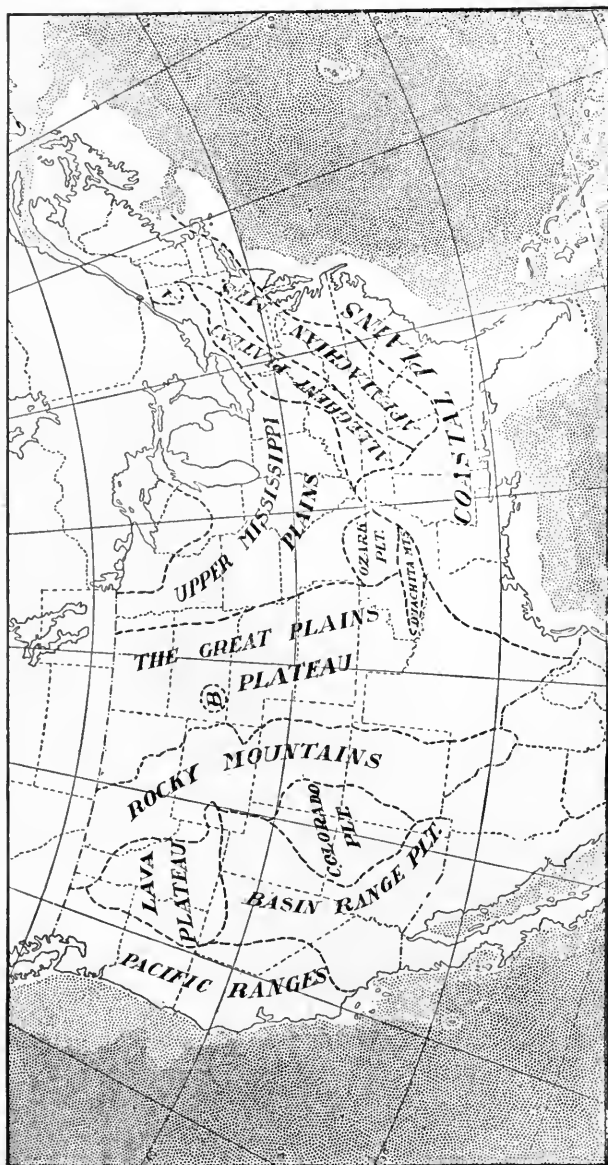

Fig. 17.—Map showing the principal physiographic subdivisions of the United States. (After Davis, with slight modifications.)

plains may also be made by the degradation of coastal lands which were once high.

Plate I represents, in another way, a part of the narrow coastal plain of Oregon, and Fig. 17 shows the Coastal Plain of the Atlantic and Gulf coasts of the United States. Since illustrations of the sort shown in Plate I will be used frequently in the following pages, the principles on which it is based must be clearly understood.

#### EXPLANATION OF CONTOUR MAP

“The features represented on the topographic map are of three distinct kinds: (1) inequalities of surface, called *relief*, as plains, plateaus, valleys, hills, and mountains; (2) distribution of water, called *drainage*, as streams, lakes, and swamps; (3) the works of man, called *culture*, as roads, railroads, boundaries, villages, and cities.

“**Relief.** All elevations are measured from mean sea-level. The heights of many points are accurately determined, and those which are most important are given on the map in figures. It is desirable, however, to give the elevation of all parts of the area mapped, to delineate the horizontal outline, or contour, of all slopes, and to indicate their grade or degree of steepness. This is done by lines connecting points of equal elevation above mean sea-level, the lines being drawn at regular vertical intervals. These lines are called *contours*, and the uniform vertical space between each two contours is called the *contour interval*. On the maps of the United States Geological Survey the contours and elevations are printed in brown (see Plate I).

“The manner in which contours express elevation, form, and grade is shown in the following sketch and corresponding contour map, Fig. 18.

“The sketch represents a river valley between two hills. In the foreground is the sea, with a bay which is partly closed by a hooked sand-bar. On each side of the valley is a terrace. From the terrace on the right a hill rises gradually, while from that on the left the ground ascends steeply in a precipice. Contrasted with this precipice is the gentle descent of the slope at the left. In the map each of these features is indicated, directly beneath its position in the sketch, by contours. The following explanation may make clearer the manner in which contours delineate elevation, form, and grade:

“1. A contour indicates approximately a certain height above sea-level. In this illustration the contour interval is 50 feet; therefore the contours are drawn at 50, 100, 150, 200 feet, and so on, above sea-level. Along the contour at 250 feet lie all points of the surface 250 feet above sea; and similarly with any other contour. In the space between any two contours are found all elevations above the lower and below the higher contour. Thus the contour at 150 feet falls just below the edge of the terrace, while that at 200 feet lies above the terrace; therefore all points on the terrace are shown to be more than 150 but less than 200 feet above sea. The summit of the higher hill is stated to be 670 feet above sea; accordingly the contour at 650 feet surrounds it. In this illustration nearly all the contours are num-

bered. Where this is not possible, certain contours—say every fifth one—are accentuated and numbered; the heights of others may then be ascertained by counting up or down from a numbered contour.

"2. Contours define the forms of slopes. Since contours are continuous horizontal lines conforming to the surface of the ground, they wind smoothly about smooth surfaces, recede into all reëntrant angles of ravines, and project in passing about prominences. The relations of contour curves and angles to forms of the landscape can be traced in the map and sketch.

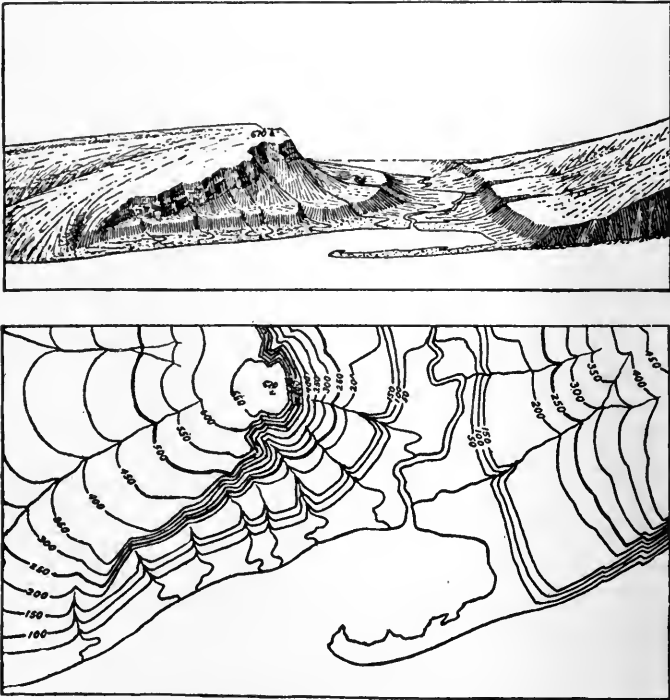
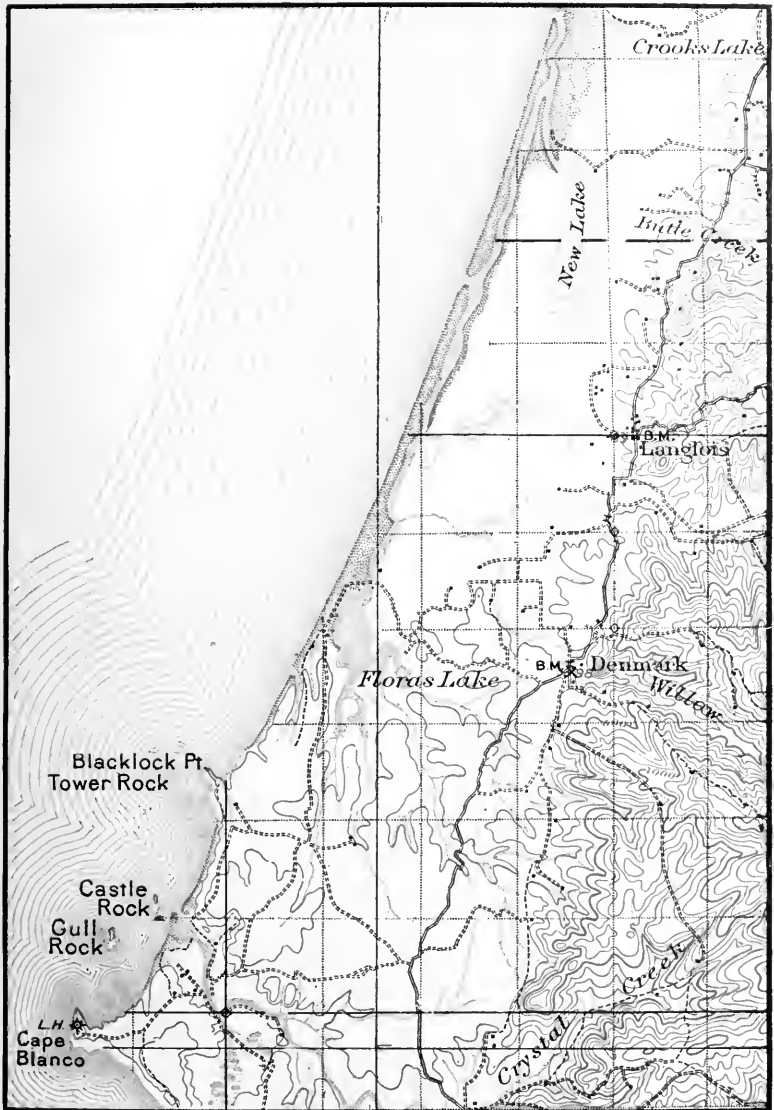

FIG. 18.—Sketch and map of the same area to illustrate the representation of topography by means of contour lines. (U. S. Geol. Surv.)

"3. Contours show the approximate grade of any slope. The vertical space between two contours is the same, whether they lie along a cliff or on a gentle slope; but to rise a given height on a gentle slope one must go farther along the surface than on a steep slope, and therefore contours are far apart on gentle slopes and near together on steep ones.

"For a flat or gently undulating country a small contour interval is used; for a steep or mountainous country a large interval is necessary. The smallest interval used on the atlas sheets of the Geological Survey is 5 feet. This is used for regions like the Mississippi delta and the Dismal Swamp. In mapping great mountain masses, like those in Colorado, the interval may





A narrow coastal plain in Oregon. Scale 2 — miles per inch. (Port Orford Sheet, U. S. Geol. Surv.)



be 250 feet. For intermediate relief contour intervals of 10, 20, 25, 50, and 100 feet are used.

**“Drainage.** Watercourses are indicated by blue lines. If the streams flow the year round the line is drawn unbroken, but if the channel is dry a part of the year the line is broken or dotted. Where a stream sinks and reappears at the surface, the supposed underground course is shown by a broken blue line. Lakes, marshes, and other bodies of water are also shown in blue, by appropriate conventional signs.

**“Culture.** The works of man, such as roads, railroads, and towns, together with boundaries of townships, counties, and states, and artificial details, are printed in black.”<sup>1</sup>

### CONTOUR-MAP EXERCISE<sup>2</sup>

1. Draw a contour-line map of a conical mountain the top of which is 2000 feet high, making the contour interval 200 feet.

2. Draw a contour-line map of a plain five miles square, one edge of which is at sea-level and the opposite one at an elevation of 100 feet. The otherwise uniform seaward slope of the land is scarred by a single valley, without tributaries, which extends across the entire width of the plain. Use a 10-foot contour interval, and a horizontal scale of one inch to the mile.

The Coastal Plain of the eastern part of the United States has a width ranging from a few to 60 miles in New Jersey, to 100 miles or more in the Carolinas and Georgia (Fig. 17), and would be counted a wide coastal plain. The Coastal Plain bordering the Gulf of Mexico is still wider, reaching a maximum width of several hundred miles in the vicinity of the Mississippi. The Coastal Plain of northern Eurasia is still wider, though locally interrupted by mountains, such as the Urals.

At their seaward edges coastal plains are commonly but little above the sea. Their inland borders, on the other hand, especially if they be wide, may be hundreds of feet above the sea. At its landward edge a coastal plain may abut against a plateau or against mountains by a slope somewhat steeper than that of the plain itself (Fig. 6). It is this steep slope, rather than any particular altitude above the sea, which limits a coastal plain to landward. The landward border of the Atlantic Coastal Plain has an altitude ranging from 100 feet or so to several hundred feet. The relatively steep slope marking its landward edge is

<sup>1</sup> From folio preface, U. S. Geol. Surv.

<sup>2</sup> The author's experience has been that students come to an appreciation of topographic maps most readily by making them.

known as the *Fall Line*, and along it are located many important cities, among them Trenton, Philadelphia, Baltimore, Washington, Richmond, Raleigh, Camden, Columbia, and Augusta. The location of these cities was determined largely by the fact that the streams were readily navigable in the Coastal Plain, but not above. The position of the Fall Line was determined by the inequalities of hardness of the underlying rocks. Those to the west of it are much harder than those to the east. The landward margin of the Coastal Plain of the Gulf of Mexico west of Alabama is less well marked than that of the Atlantic border.

Such coastal plains as exist along the eastern side of North America north of New Jersey, and along the western coast of the continent, are narrow and discontinuous, and for considerable stretches are wanting altogether. Coastal plains are therefore to be looked upon as common, but not as universal, features of continental borders.

If the epicontinental seas were withdrawn from the submerged parts of the continental platforms, the coastal plains of the present land would be seen to be continuous, topographically, with the continental shelves. These submerged parts of the great continental protuberances of the lithosphere are therefore to be looked upon as *submerged coastal plains*. Many of the existing coastal plains of the land have emerged from the sea in very late stages of the earth's history. The submerged coastal plains are more nearly continuous about the continents than the coastal plains which are above sea-level.

**Interior plains.** These plains are often higher, and sometimes much higher, than coastal plains. A large part of the great area between the Appalachian Mountains on the east, and the Rocky Mountains on the west, is an interior plain. *At the south* it is relatively low, and merges into the Coastal Plain bordering the Gulf. *At the north* this Interior Plain is much higher, attaining an elevation of more than 1000 feet; but its rise is so gradual that it nowhere ceases to have the general effect of a great lowland. *At the east*, also, it rises until the Appalachian Mountains are approached. Along the western border of these mountains there is a higher area, about 1000 feet above sea-level, often known as the Cumberland, or Allegheny, Plateau (Fig. 17). This tract is called a plateau, rather than a part of the plain, not more because of its altitude than because it is often somewhat distinctly set

off from the lower area to the west. *To the west* the interior plain rises gradually, and without any conspicuous increase of slope, until it attains an altitude of several thousand feet. In spite of this very considerable elevation, far greater than that of the Cumberland Plateau, the area east of the Rocky Mountains is usually called the *Great Plains*. The western part of this region is perhaps more properly a plateau than a plain; but it is notably lower than the mountains against which it abuts on the west, and between its higher parts, next to the Rockies, and its lower parts, adjacent to the Mississippi, there is no abrupt change of slope. It is clearly a topographic unit. If the western part of this area be classed as plateau, the area affords a good illustration of the gradation of a plain into a plateau, for the line separating the plain-part from the plateau-part would be an arbitrary one. Even if the higher western part of the Great Plains be regarded as plateau, it is still true that portions of the interior plain are higher than many areas which are called plateaus. Areas like the Great Plains are classed as *plains*, not primarily because of their altitude above sea-level, but because they do not stand conspicuously above their surroundings on any side.

The general topographic relations of the Great Plains are illustrated diagrammatically by Fig. 15. If the general slope of the area between the Rocky Mountains and the Mississippi River had been that of the dotted line shown in the middle of this figure, its western part would doubtless have been classed as a plateau, and the line of separation between plateau and plain would have been a natural one.

Here and there mountains, such as the Black Hills of South Dakota, the Ozark Mountains (plateau) of Missouri, and the Ouachita (pronounced Wash'-i-ta) Mountains of Arkansas, Indian Territory, and Oklahoma, rise distinctly above the general level of this great Interior Plain. The Ozark and Ouachita Mountains do not attain an elevation equal to that of the western margin of the Great Plains, but they are so distinctively and conspicuously above their immediate surroundings that they are not regarded as parts of the plains, and the summit area of the Ouachita Mountains, at least, is so limited that they cannot be regarded as a plateau. The Ozark Mountain tract, on the other hand, might equally well have been called the Ozark Plateau, for the character of the region which bears this name is intermediate between that

of a well-defined mountain group and a plateau. The Black Hills are higher, and more distinctly set off from the plains, than are the Ozark and the Ouachita Mountains. They are mountains, in spite of their name.

Interior plains have come into existence in various ways. Some of them are former coastal plains, now partially shut off from the sea by the development of highlands between. Some of them represent areas which were once high, but which have been worn down by rivers, and by the other agents which degrade lands; others may have originated in other ways.



FIG. 19.—A plain with little relief. Valley plain of the Cimarron River, southwestern Kansas. (U. S. Geol. Surv.)

**Topography of plains.** The surfaces of plains are, on the whole, much less uneven than the surfaces of plateaus and mountains. The surfaces of plains may indeed be nearly flat, though more commonly they are somewhat uneven. The relief is sometimes slight and sometimes considerable, and in general high plains are rougher than low ones. To this general statement there are, however, local exceptions, for considerable areas of high plains are sometimes nearly flat.

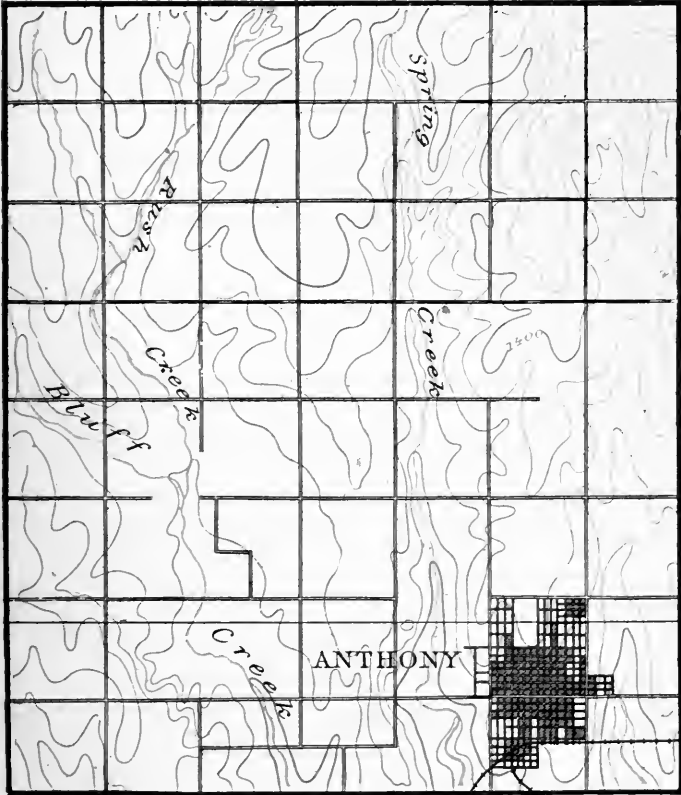

A well-drained plain in Kansas. Scale 2- miles per inch.  
 (Anthony, Kan., Sheet, U. S. Geol. Surv.)

PLATE III

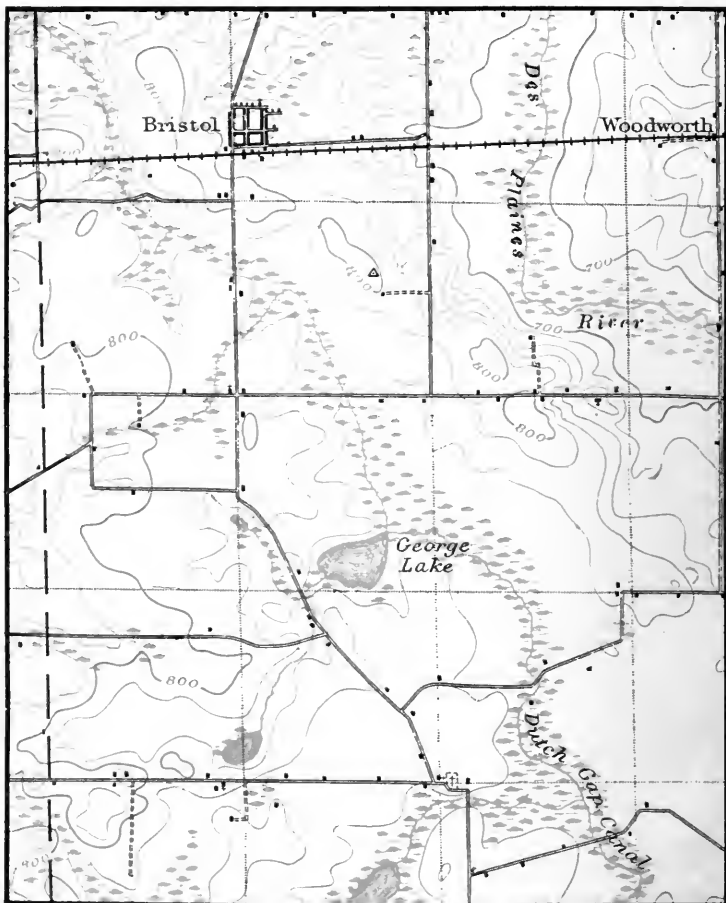

An ill-drained plain in Wisconsin. Scale 1— mile per inch (Silver Lake Sheet, U. S. Geol. Surv.)



The unevennesses of surface differ in kind, as well as in amount. Thus in some plains, or in some parts of plains, all depressions have outlets through which the surface water flows away, while in others numerous depressions have the form of basins which contain ponds and lakes. Plains of the former type are *well drained*, if the depressions are numerous, while those of the latter are *ill drained*. Well-drained areas (Pl. II) of plain prevail in the southern part of the United States, as south of the Ohio and the Missouri, while ill-drained areas (Pl. III) abound farther north.

The topographic features of plains are relief features of the third order, and will be considered later; but the points here mentioned have a bearing on the topic of the next paragraph.



FIG. 20.—A plain with notable relief. Iowa. (Calvin.)

**Extent and habitability.** Plains constitute the larger part of the area of the land, and the larger part of the population of the earth lives upon them (Figs. 21 and 22). They are the principal theatres of human activity, partly because the climate is on the whole more favorable than in higher regions, and partly because there is a greater proportion of land which is nearly flat, or which has but gentle slopes. As compared with higher lands, a larger proportion of the surface of plains is arable, for (1) their flats and gentle slopes are more generally covered with soil than the steeper slopes of higher lands are, and (2) a larger proportion of their surfaces is not too steep for cultivation. The larger part of the agriculture of the world is therefore on plains.

When the population of the United States was about 50,000,000<sup>1</sup> (1880), it was distributed as follows, with reference to altitude:

<sup>1</sup> Later data on this point are not available.



FIG. 21.—Map showing density of population in different parts of the United States.  
(After Gannett. U. S. Census.)



Less than 100 feet above sea-level .....	15.9%
Between 100 and 500 feet above sea-level.....	21.8%
Between 500 and 1000 feet .....	38.7%
Between 1000 and 1500 feet .....	14.7%
Between 1500 and 3000 feet .....	6.2%
Above 3000 feet .....	2.7%

Plains also favor transportation and intercommunication, for (1) the construction of roads, railways, canals, etc., is vastly easier in plains than in higher and rougher regions, and (2) the streams of plains are much more commonly navigable than those of mountains and plateaus. For these reasons, and also because the larger part of the raw materials used in manufacturing is grown upon the plains, the larger part of the manufacturing of the world is on plains. It is noteworthy that the extensive plains most favored by climate and soil border the Atlantic Ocean, and, largely for this reason, the borders of this ocean have been the theatres of the world's culture and commerce.

Not all plains support an abundant population. Thus the northern parts of the great Eurasian and North American plains are too cold to be hospitable to varied industries or productions, and their populations are likely to remain small.

### *Plateaus*

Plateaus are tracts of land so situated as to appear high from at least one side, and which have, at the same time, considerable areas at or near their summit levels. Thus if a coastal plain rises gradually from the sea to a height of 200 feet, and then joins by a steep slope another tract of more or less level land which rises 100 or 200 feet higher (Fig. 6), the upper tract would commonly be called a plateau, not primarily because of its altitude above sea-level, but because of its distinct rise above the plain along one side of it. Traced landward, the low slope of the Atlantic Coastal Plain of the United States gives place to a steeper one at the Fall Line, and the tract above, beyond the Coastal Plain, is the *Piedmont Plateau*. The elevation of much of this plateau is, however, less than that of much of the great interior plain of the continent.

Though plateaus are on the whole higher than plains, it may be pointed out again that the distinction between them is not

more one of elevation than of relations. A tract of land is rarely called a plateau unless it rises distinctly above adjacent land or adjacent water on one or more sides.

In spite of the broad distinction between plateaus and plains,



FIG. 23.—Relief-map of the Northern Appalachians and their surroundings. (U. S. Geol. Surv.)

these two great topographic types grade into each other so completely that it is often hard to say whether a given region should be classed as the one or the other, and a tract which, in its surroundings, is a plateau, might in other surroundings be a plain.

Distinctions in nature are often less sharp than we seem to make them by arbitrary (though often necessary) definitions.

**Position and area of plateaus.** Plateaus often lie between mountains on the one hand and plains on the other, as in the case of the Piedmont and Cumberland plateaus already cited. They also lie between mountains, as the plateaus of Central Asia (Fig. 24), Mexico, and the western part of the United States, and they sometimes rise directly from the sea, as in the case of Greenland and parts of Africa (Fig. 25).

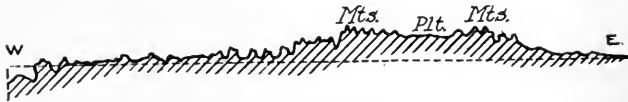

FIG. 24.—Section across Asia along the 35th parallel. Vertical scale greatly exaggerated. The plateau between mountains is marked Plt. (After Heidrich.)

The aggregate area of plateaus is less than that of plains, though they constitute a very considerable fraction of the land.

**Relief of plateaus.** The surfaces of plateaus usually have greater relief than the surfaces of plains, because the valleys are deeper. The plateau of the Colorado in northern Arizona has an elevation of about 7000 feet, and a relief of a mile or more, for the Colorado River has a valley (canyon) of that depth (Figs. 27 and 27*a*). From the bottom of this valley, its slopes look like mountains. They are indeed much higher and bolder than many mountains;

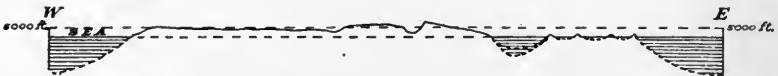

FIG. 25.—Section across Africa along the parallel of 10° S. Vertical scale exaggerated about fifty times.

but since there are great stretches of land about the canyon at about the elevation of the tops of these slopes, the area is a plateau region, rather than a mountain region. No plain has such great relief as this plateau.

**Other features of plateaus.** Except for the greater average relief of plateaus, their surfaces have much in common with the surfaces of plains. There are flat plateaus, broken plateaus, rolling plateaus, etc., and these topographic terms are often applicable to different parts of the same plateau. There are plateaus which

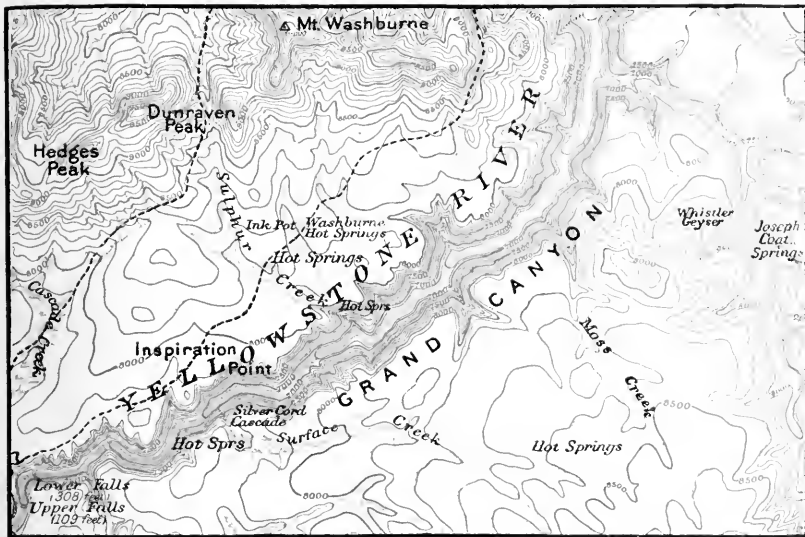

FIG 1.—The canyon of the Yellowstone River. Scale 2— miles per inch. (Canyon, Wyo., Sheet, U. S. Geol. Surv.)

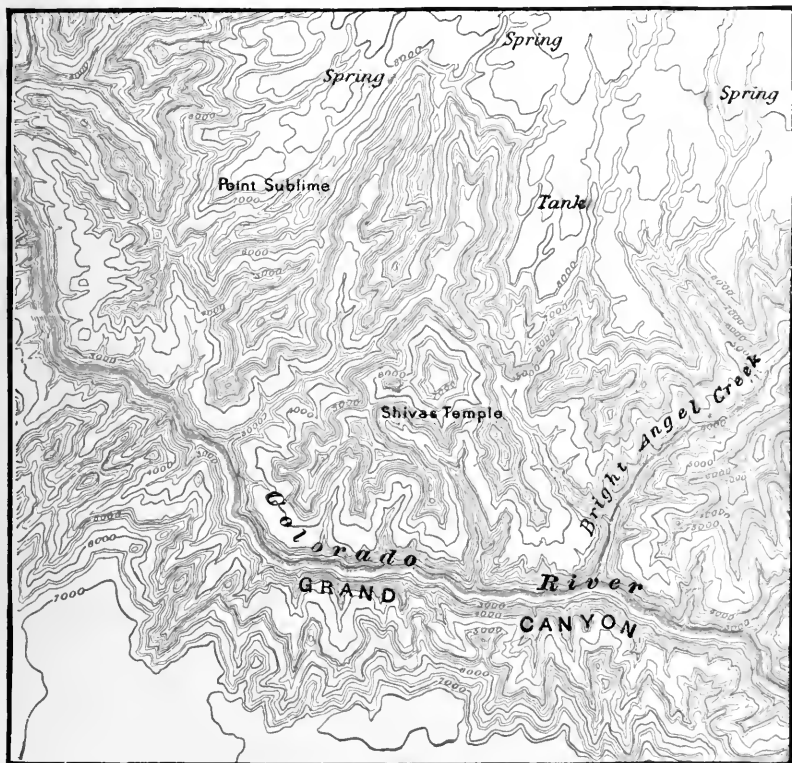

FIG. 2.—The Grand Canyon of the Colorado River. Scale 4— miles per inch. (U. S. Geol. Surv.)





are well drained, and plateaus which are ill drained; there are plateaus which are relatively fertile, and plateaus which are essentially desert. The relief features of plateaus, like those of plains, are relief features of the third order.

The climate of plateaus, especially that of high ones, is distinctly colder than that of plains in similar latitudes, and their precipitation is generally less. Except in low latitudes, they are too cold to be well adapted to human habitation, and their rainfall is often insufficient for agriculture. Their deep valleys are barriers to trans-



FIG. 26.—A valley (canyon) in a plateau. Snake River below the mouth of Rattlesnake Creek. (U. S. Geol. Surv.)

portation. For these and other reasons, high plateaus are, on the whole, less well adapted to human habitation than plains, and the population of high plateaus is generally scanty. On the other hand, the altitude of low plateaus, such as the Piedmont and the Cumberland plateaus, is too slight to affect the climate adversely, and such plateaus may be as fertile as plains, so far as climate is concerned. Plateaus in low latitudes may have a favorable temperature, and may be so situated as to have an adequate supply of water, as illustrated by some parts of the plateau of Mexico.

**Origin.** Plateaus attain their height in various ways. (1) In some cases their surroundings probably sank away from them. If, for example, the eastern half of the Great Plains was to sink a few hundred feet, while the western half did not, the latter would doubtless be called a plateau (Fig. 15). (2) Some plateaus may have attained their height by elevation above their surroundings,

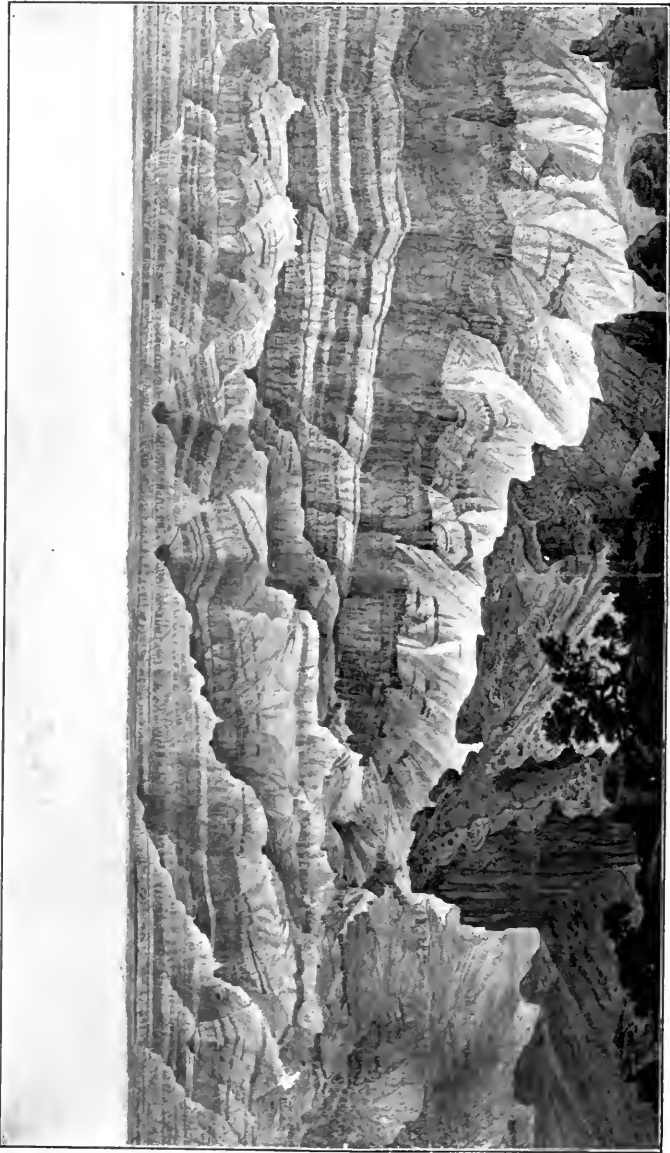

FIG. 27.—Sketch of a part of the Grand Canyon of the Colorado. A glimpse of the river is to be had at the left. (Holmes, U. S. Geol. Surv.)

while still others (3) have been built up either from plains or from lower plateaus, by the outpouring of lavas. Such is the lava plateau of the northwestern part of the United States (Fig. 401).

The term plateau is often applied, and properly, to small areas which may owe their plateau character to other causes, such as



FIG. 27a.—The Grand Canyon of the Colorado. The inner gorge in the foreground, and the more distant cliffs in the background. The canyon is about a mile deep. (Hull.)

isolation by the degradation of the surrounding surface. Such plateaus are topographic features of a lower order, and are not here considered.

### *Mountains*

Mountains are *conspicuously high lands which have but slight summit areas*. Conspicuously high lands must be interpreted to mean lands which are conspicuously high in their surroundings,—not necessarily those which have great elevation, measured in feet or meters.

Though the tops of the highest mountains are between five and six miles above the level of the sea, most mountains have not half

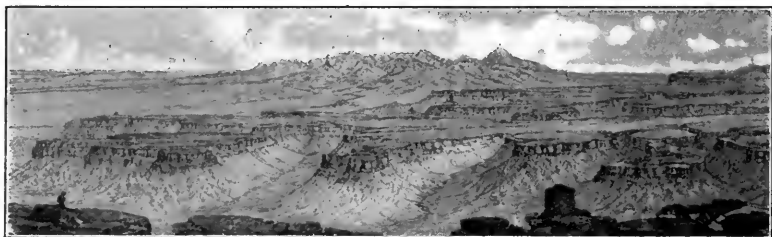

FIG. 28.—Sierra el Late Mountains, Colo., with dissected mesa in the foreground. (Holmes, U. S. Geol. Surv.)

this height. The highest mountains are higher than any plateaus, but many mountains are not so high as the highest plateaus. Relatively few, for example, reach the height of the Plateau of Tibet, 15,000 to 16,000 feet. Many elevations called mountains are not even so high above sea-level as the higher parts of the higher plains.

Mountains differ from plateaus of similar elevation in that



FIG. 29.—The Needle Mountains of Colorado. An illustration of mountain topography. Taken from an elevation of about 10,700 feet. (U. S. Geol. Surv.)

they have little extent of surface at the summit level. In the case of mountain *peaks* this is indicated by the name. A moun-

tain ridge or range may be long, but, as its name implies, its crest is usually narrow. The several ridges shown in Fig. 23 are ex-



FIG. 30.—Lake Agnes, Canadian Pacific Railway. (Photograph by Church.)

amples. Numerous peaks or ranges are often associated, making a mountain group (Fig. 28) or a mountain chain (Fig. 23); but



FIG. 31.—Cascade Pass in the Cascade Mountains, Washington. An illustration of mountain topography. (Willis, U. S. Geol. Surv.)

even in great mountain groups there is no great continuous area of high land. Land 10,000 feet high would generally be called a



FIG. 32.—A portion of the Elk Mountains of Colorado.  
(Holmes, U. S. Geol. Surv.)

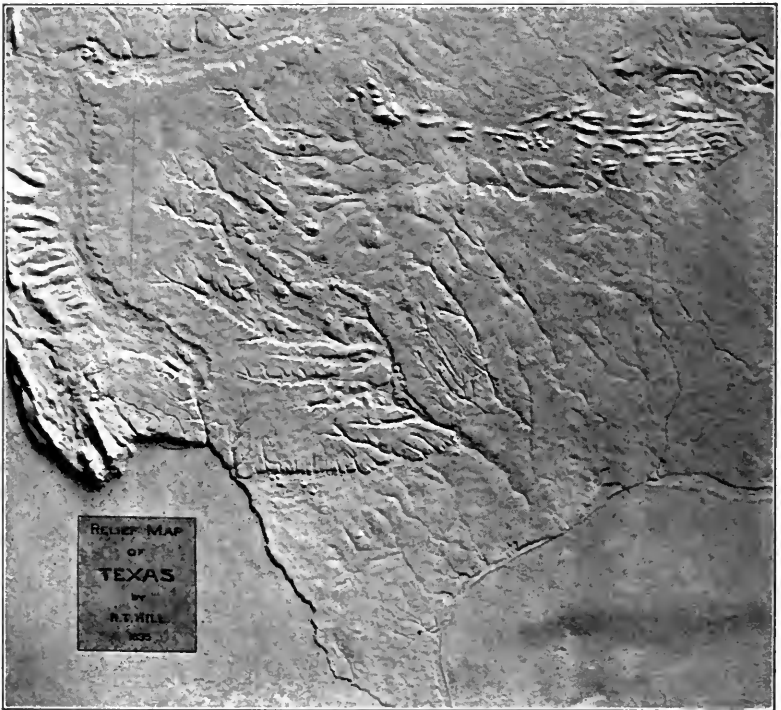

FIG. 33.—Photograph of relief-model of Texas and surroundings. The area near the coast is a part of the Coastal Plain. Inland this plain gives place to a plateau tract, while at the north and west mountains rise above the plateau level. The valleys are deep, and the relief is greater in the mountains than in the plateau, and in the plateau greater than in the plain. (Hill.)

*plateau* if its summit area were extensive, a mountain if its summit were a peak, a mountain ridge or range if its crest were a narrow ridge, or a mountain area, a mountain group, or a mountain system, if composed of a succession of peaks and ridges.



FIG. 34.—Topographic map of California. The State is largely mountainous, but the central plain is conspicuous. (Model by Drake.)

Considered in a large way, mountains are in contrast with plains and plateaus, and are the third of the three topographic types of the second order, as they appear on the lands of the earth.

High mountains are on the whole the most impressive and awe-inspiring features of the earth's surface. This is especially

the case where they rise abruptly to great heights above their surroundings. In not a few cases they rise from low warm plains to such heights that their summits are continually covered with snow. Nowhere else are such contrasts of climate found in such close proximity.

In this grouping of mountains, as the third great topographic features of the lands, it must be noted that only great groups or systems of mountains, such as the Appalachians, the Rockies, the Sierras, the Alps, the Caucasus, the Himalayas, the Andes, and others of comparable extent and magnitude are included. Since the term mountain is applied to any point or ridge of such steep slopes and so much above its surroundings as to be very conspicuous, if, at the same time, its summit area is so small that it is not a plateau, it follows that many elevations called mountains do not belong to the great physiographic type which is to be brought into contrast with plains and plateaus. From this category we must exclude many minor and isolated elevations called mountains, especially those of such small size that, in surroundings other than their own, they would not be regarded as mountains.

**Mountains in history.** Mountains are always more or less formidable barriers, and as such have played important rôles in history. They have sheltered nascent civilizations from invasion, and they often determine the boundaries of political states. The mountains of western and southwestern Europe were an important factor in producing the many small political divisions of those sections, so in contrast with Russia. Mountainous highlands have frequently become a refuge for weak peoples, driven by their stronger enemies from the more desirable lowlands. The relatively inaccessible highlands of Scotland, Wales, and parts of India enabled such peoples to maintain their independence for long periods. The Appalachian Mountains confined the English settlements to the rim of the continent for nearly a century and a half, and influenced their life in many ways. Later, grave political dangers arose from the effectual isolation of the Ohio Valley settlements from the Atlantic seaboard.

The scant soils and low temperatures of most mountains inhibit agriculture, while the difficulties of communication help to restrict commerce and social intercourse. Poverty is, accordingly, the common lot of the mountaineer, save in certain mining and lumbering areas. Shut out from the progressive life of the plains,



mountain peoples are proverbially conservative, maintaining old customs and habits, and supporting the established order of things. In the Civil War the Southern Appalachians became a zone of disaffection through the heart of the Confederacy, sending 100,000 men to the northern armies.

The most distinctive industry of the mountains is mining; yet many mountains have no ores or mineral matter of commercial value, while many ores and many mineral substances which are not ores are mined in plains and plateaus. This is true, for example, of most of the iron and coal now mined in the United States.



FIG. 35.—Cross-section illustrating the structure of the Appalachian Mountains. (After Rogers.)



FIG. 36.—Section of the Alps from Saint Gothard South. (After Heim.)



FIG. 37.—Cross-section of the Elk Mountain Range, Colo. (Holmes, U. S. Geol. Surv.)

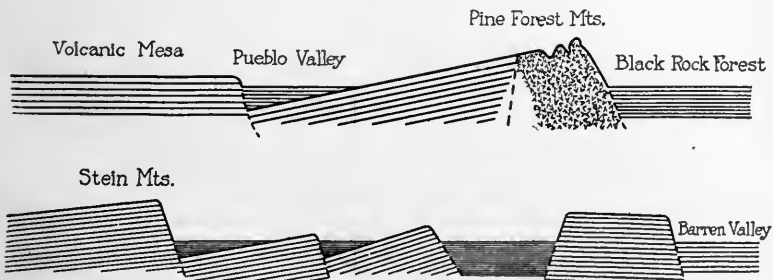

FIG. 38.—Faulted Mountain (Block Mountain) structure, Nevada. (Russell, U. S. Geol. Surv.)

**Origin.** Mountains have originated in various ways. In their formation, the layers of rock of which they are composed were

often folded and crumpled, sometimes on a grand scale. Figs. 35-37 illustrate types of mountain structure common to the great

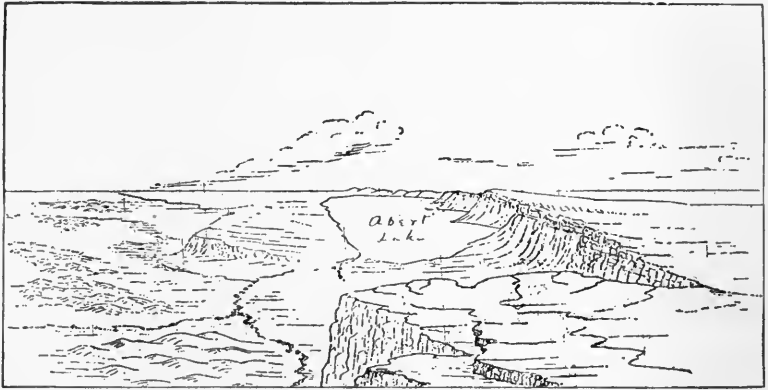

FIG. 39.—Sketch of the Abert Lake, Ore. (Russell, U. S. Geol. Surv.)

ranges which belong to the topographic features of the second order.

#### TOPOGRAPHIC MAPS<sup>1</sup> SHOWING GREAT PHYSIOGRAPHIC TYPES

*Note.* The conventions used on the topographic maps are explained on their backs. The meaning of each should be noted.

**A Plain Region.** *Maumee Bay, Ohio Sheet.* This map shows a nearly level plain whose surface slopes very gently to the northeast. The general flatness may be read at a glance from the fewness of the contour lines (only four appear upon the entire map), and also from the fact that the railroads run long distances in straight lines. Calculate the average slope of the surface per mile. *4.8 ft/mi*

**A Plateau Region.** *Echo Cliffs, Ariz. Sheet.* The numbers upon the contour lines show this to be an elevated region, and the disposition of the contours shows that there are considerable areas of the high land, and that the region is therefore a plateau. The very deep valley of the Colorado River also indicates great height of land, for such valleys are found only in regions far above sea-level. Note that the Paria Plateau, at the northwest, is bordered by an abrupt descent. This is often true of plateaus upon at least one side.

<sup>1</sup>These maps are topographic maps of the U. S. Geological Survey. They may be had of the Director of that Survey, Washington, D. C., at \$3.00 per 100. Many of these maps will be referred to in the following pages. See list at end of Part I.

**A Mountain Region.** *Hummelstown, Pa. Sheet.* The massing of the contours along northeast-southwest lines in the northern part of the area shows a series of relatively steep slopes extending in that direction. The crests between the steep slopes are narrow. The numbers on the contour lines show that the elevations are of mountainous heights.

#### SUBORDINATE TOPOGRAPHIC FEATURES

It has already been noted that the surfaces of plains and plateaus are often somewhat uneven, while the very name of mountain suggests roughness of surface. In many cases the degree of unevenness of surface is more or less closely related to altitude above sea-level, increasing roughness going with increasing altitude, though altitude is by no means the only factor which determines roughness and smoothness of surface. The minor unevennesses of surface which affect plains, plateaus, and mountains are *topographic features of the third order*. Some of these irregularities of surface consist of elevations above the general level of their surroundings, and some of depressions below it. Thus on the plains there are *ridges* and *hills* above the general level, and *valleys* and sometimes *basins* (depressions without outlets) below it, while *flats* may be interspersed among the uneven tracts. The elevations and the depressions are bordered by *slopes*, which, when steep, are *cliffs*. These subordinate features, ridges, hills, valleys, basins, flats, etc., affect plateaus as well as plains; but the corresponding features of plateaus are often more pronounced, sometimes so much more pronounced that they receive different names. Many of the same features, often on a still larger scale, affect mountains; but here the more or less isolated elevations, instead of being merely ridges or hills, are often of mountainous size, and receive individual names. And so, as terms are now used, it is difficult to distinguish, *in words*, between mountains which are topographic features of the second order and mountains which are topographic features of the lower order, though in reality the distinction is clear enough. Thus the Appalachian Mountains are a topographic feature of the second order, but any minor ridge or peak in the system, though still a mountain, is a feature of the third order, and is to be compared with the hills and buttes of plains and plateaus.

The depressions in the surface of plains or plateaus are of different sizes, shapes, and origins, and will be the object of future

study. Similarly the hills and ridges of plains and plateaus, and the larger, mountain-big hills of mountainous regions, are of different sizes, shapes, and origins, and their history is often intimately connected with the history of the depressions with which they are associated. Slopes were developed when elevations and depressions were developed, and largely by the same means. The origin of the topographic features of the third order is in general well understood, for the processes which have developed them are still in operation, and their results in past times may be inferred with much confidence. These processes we shall study in some detail.

**Land surface and ocean bottom.** Were the water removed from the ocean basins, the surface of the ocean bed would appear much less uneven than the surface of the land. While its aggregate relief is a little greater than that of the land (p. 9), much larger tracts of it are nearly plane, and minor irregularities, such as hills and valleys with their accompanying slopes, the most widespread of the minor irregularities of the land, are of much less common occurrence; are, indeed, entirely absent from the larger part of the ocean's floor.

Why this difference between land and sea bottom? Without discussing this subject at this point, it may be noted that the atmosphere and running water, both of which are in almost constant motion, are always in contact with the surface of the land, while the atmosphere is excluded from the ocean bottom, and the water which covers it is practically motionless, except where the water is very shallow. It will be seen in the sequel that the differences in topography between the land and the sea bottom are largely due to the contact with air and running water in the one case, and with standing water in the other.

#### *The Development of Minor Topographic Features*

Since the minor topographic features of plains, plateaus, and mountains have been developed in similar ways, their origin and history may be considered independently of their association with one or another of these great physiographic divisions. The key to the history of topographic features of the third order is found in the changes which the surface of the land is now undergoing, or which it has undergone in such recent times that their records are still clear.

**Changes now taking place on the land.** Certain familiar changes are always taking place on the land. Some of them are brought about by the atmosphere, some by water, some by ice, and some by the life of the earth. The same agencies produce, directly or indirectly, certain changes on the sea bottom, but the changes there are not only less important than those on land, but they are essentially different in their effects on the topography.

1. The air is nearly always in motion, and whenever it blows over a surface on which there is dust, some of the dust is picked up and blown to some other place. Even sand, the particles of which are much larger than those of dust, is blown about in the same way. The wind is, therefore, one of the forces which is changing the surface of the land. The winds also help to distribute the moisture of the atmosphere, and so influence the amount and the distribution of rain and snow. Though winds do not blow at the bottom of the sea, dust and sand blown out from the land are dropped into the ocean and sink to its bottom, and the winds generate water waves which work upon the shores of the seas, and affect their bottoms where the water is very shallow. The winds therefore are not without their effects on the sea bottom, though these effects are slight compared with those on the land.

2. On both the land and sea, rains and snows fall. The rain which falls on the land disappears in various ways, but a part of it runs off over the surface. When the snow of the land melts, the water follows the same course. The water which runs off over the land in streams is the most important single agent modifying the land surface. The streams carry much sediment from the land to the sea, and its deposition has its effect on the sea bottom, especially near the land.

The rain- and snow-water which sinks beneath the surface of the land dissolves more or less mineral matter, which appears in spring water and in well water. This solution of mineral matter beneath the land, and its transfer by the water to the surface, and thence through streams to the sea, also help to lower the land.

While the waters which fall on the land have an indirect effect on the bottom of the sea, as indicated, those which fall on the sea itself have little influence on its bed. Precipitation, therefore, whether in the form of rain or snow, modifies the surface of the land notably, but has little influence on the ocean bottom, except near its borders, where most of the sediment from the land is left.

3. Great bodies of ice, called *glaciers*, move slowly over the surface of the land in some places, especially on high mountains and in high latitudes. Glaciers, which originate in perennial fields of snow, work notable changes on their beds. They sometimes push out into the sea for short distances, but they never advance into deep water. At most they only affect the submerged edge of the continental platform.

The winds, the streams, and the glaciers all tend to develop unevennesses of surface on the land. Since this is the case, and since these agents are not in operation beneath the sea, we infer that they have had much to do with developing the differences between the topography of the land and that of the sea bottom.

4. The waves of the sea and of the many lakes which lie on the land are continually modifying the position and the outlines of their shores. The changes thus effected are slight in short periods of time, but they have been very great in the course of the long ages of the earth's history. They change the outlines of the land rather than its relief, but they alter the relief of the sea or lake bottom near shore in an important way.

The winds, rivers, glaciers, and waves are *agents of gradation*. They degrade the surface at some points, and aggrade it (build it up) at others. In general they degrade the land more than they aggrade it, for much of the material moved by them finds its resting-place in the sea. Conversely, they aggrade the sea bottom more than they degrade it. Waves may degrade it effectively, but only where the water is shallow.

5. Still another series of changes in the surface is being brought about through the agency of life. Man, for example, grades down elevations, and he grades up depressions, as along railroads. He makes dams across rivers, converting portions of them into ponds, or at the outlets of lakes, raising their levels; he raises and changes the banks of streams, modifying their natural courses and their natural work; he drains marshes and lakes, and, more important than all else, he clears (removes the forests) and tills the land, and in so doing destroys the native vegetation and stirs up the soil, thus preparing the way for the more effective action of wind and running water. Man's direct influence on the sea bottom is slight.

Plants and animals affect both land and sea bottom. Deposits due to organisms of one sort and another, especially those due

to plants, are somewhat wide-spread in the marshes and shallow lakes of the land; but they are, on the whole, of little consequence compared with the deposits of shells, skeletons, and other solid matter made by marine animals on the sea bottom, more especially in shallow water. Organic agents are in some sense gradational, chiefly aggradational; but they belong to a different category from the inorganic gradational agents.

Various forms of life have a protective effect on the surface. This is especially true of vegetation on the land. The forests, and even the prairie vegetation, greatly restrict the erosive work of wind and running water, and so decrease the rate of degradation which would otherwise obtain.

6. Volcanoes affect both land and sea bottom, and with approximate equality. Volcanoes often give rise to mountain heights, but the mountains to which they give rise are topographic features of the third rather than the second order. The great *processes of vulcanism*, that is the movement of liquid rock from great depths up to or toward the surface, affect the surface of land, and doubtless of sea bottom, in other ways, which will be mentioned in other connections.

7. It is well known that the surface of the lithosphere seems to be rising in some places and sinking in others. This has been true in the past, for beds of sediment (sand, clay, etc.), containing sea-shells, etc., and therefore once beneath the sea, occur at levels high above it, and areas once land are now beneath the sea. Crustal movements are probably responsible in large measure for the ocean basins and continental platforms, and for plains, plateaus, and mountains, that is for the *topographic features of both the first and second orders*. All sorts of crustal movements, of whatever nature, are grouped together under the name *diastrophism*.

The processes of gradation, vulcanism, and diastrophism will be taken up in order, but before entering upon the study of gradation, the materials on which the agents of gradation act must be briefly reviewed.

#### THE MATERIALS OF THE LAND

The land is nearly everywhere covered with vegetation. In some places it is dense enough to form a thick mat over the surface, while in others it is meagre, or even wanting. The surface well clothed with vegetation is the surface with which we are most

familiar; but there are tracts of sand on which little or nothing grows, and cliffs where the rock is bare, save for scattered patches of moss or lichen. In the polar regions and on lofty mountains also, the land is often covered by thick beds of snow on which there is no vegetation of the types with which we are familiar.

**Mantle rock.** Beneath the vegetation there is, in most regions, a layer of loose material, composed of clay, loam, sand, gravel, etc., of variable thickness. This layer of earthy matter may be a few inches in thickness, or it may be scores or even hundreds of feet deep. This loose material is *mantle rock*, because it covers and conceals the solid rock which lies below. It is also known by other names, among which are *rock waste* and *regolith*.

The uppermost portion of the mantle rock is commonly called *soil*. In color the soil may be black, gray, brown, or even dull red or yellow. It may be either clayey and compact, or sandy and porous. In most cases it is made up largely of small particles of mineral or rock. If a piece of any common sort of rock be put into a mortar and ground to powder, this powder will somewhat resemble soil. In general we cannot recognize the kinds of rock from which the mineral particles of the soil came, for they are usually very small. In addition to the mineral matter, the soil contains more or less partly decayed vegetable matter. Bits of roots may often be seen in it, and sometimes fragments of decayed leaves. Both the mineral and the organic matter are necessary parts of a good soil, but their proportions vary within wide limits. The mineral matter is usually far in excess of the organic, but locally, as in bogs and marshes which have been drained, the organic matter is the more abundant. That part of the mantle rock which is properly called soil ranges from a few inches to a few feet in thickness.

The distribution and prosperity of population often bear a very direct relation to the fertility of the soil. The fertile "Blue Grass" region of Kentucky was the first extensive area to be settled in the Ohio basin; its inhabitants have always been progressive and well-to-do. Some of the hilly land to the east was slowly occupied by a sparse population, condemned by a poor soil to financial and intellectual poverty. The cotton and tobacco lands of the Coastal Plain were partly responsible for the institution of slavery.

Where the mantle rock is thicker than the soil, the soil grades



down into earthy matter of somewhat different composition, known as *subsoil*. Between the two there is commonly no distinct separation, but the subsoil is often, though not always, more compact than the soil, and its color is often different. Like the soil, it contains both mineral and organic matter, though the latter is less abundant than in the soil. Only the larger roots, and the roots of the larger plants, penetrate the subsoil in great numbers. The thickness of the subsoil is often much greater than that of the soil, but, on the other hand, it is sometimes absent altogether.

**Rock.** Beneath the subsoil is *rock*. When a geologist speaks of rock, he does not necessarily mean solid rock, for sand, gravel, clay, etc., in large quantities and in the proper relations are included under this term. The subsoil itself is a sort of rock. As commonly used, however, the term rock implies solid rock, and beneath the mantle rock the larger part of the earth down to the



FIG. 40.—Soil grading down into rock. Sandstone, south central Wisconsin. (MacNeille.)

lowest accessible depths, and far beyond, is solid rock. It is probable indeed that the body of the earth is solid to the core.

In many places the mantle rock grades down into the solid rock in such a way as to show that the former was made by the decay of the latter (Fig. 40). It is this fact which makes the name *rock waste* appropriate for the mantle rock. Mantle rock of this sort is *local*. It is made up of materials derived from the rock below. In other places the plane of separation between the subsoil and the solid rock below is distinct, with no suggestion of gradation (Fig. 41). In such cases the mantle rock often con-

tains materials which could not have been derived from the rock below. They have been *transported* to their present position from some other source.

**Classes of solid rock.** The solid rocks of the earth are of many kinds. They differ from one another in color, in strength, in



FIG. 41.—Section showing loose material (glacial drift) on solid rock. Des Moines County, Ia. (Ia. Geol. Surv.)

texture, in composition, in origin, etc.; but the common rocks may be grouped into three great classes, namely, sedimentary rocks, igneous rocks, and metamorphic rocks.

1. *Sedimentary rocks.* These rocks were once sediments not unlike the muds, sands, and gravels now being deposited in rivers, lakes, and seas. They are generally arranged in layers or beds, varying from a few inches to several feet in thickness. Because of this structure they are often called *stratified rocks*. The layers or strata are sometimes horizontal (Fig. 42), but in other cases they are tilted or inclined at various angles.

Among the common forms of stratified rock are *conglomerate*, *sandstone*, and *shale*. Conglomerate is gravel, the pebbles and stones

of which are cemented together. Similarly, sandstone is sand, the grains of which are cemented together, while shale is mud, the particles of which are so compacted or cemented that they cohere into a solid mass. Various sorts of mineral matter serve as cement for sedimentary rocks. In general the cementing matter was

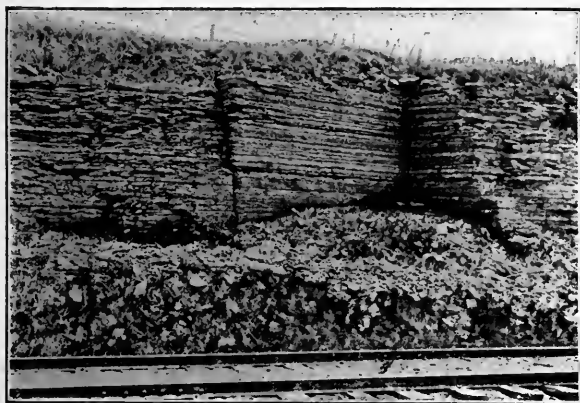

FIG. 42.—Stratified rock. Trenton Limestone, Fort Snelling, Minn. (Calvin.)

deposited between the grains or particles of sediment, from water which held it in solution, and which at some time overlay, filled, or passed through the sediments. The stones of the gravel, the grains of the sand, and the tiny particles of the mud, were all derived from some older rock which was, in some way, broken to pieces. The destruction of one kind or generation of rock therefore furnishes the material for another and younger generation of rock.

*Limestone* is another common sort of stratified rock, but in this case the mineral matter which makes the rock was chiefly derived from the shells or other hard parts of animals which lived in the sea. It is not of pebbles, sand grains, or mud particles derived directly from the breaking up of older rock. Even the material of the limestone, however, comes from older rock, from which it was dissolved, and taken in solution to the sea.

Great layers of gravel, sand, mud, shells, etc., are being formed in the ocean, in lakes, etc. We conclude, therefore, that conglomerate, sandstone, shale, and limestone were formerly beds of gravel,

sand, mud, shells, etc., accumulated in similar situations. Since these materials, as now deposited, are arranged in nearly horizontal layers, it is inferred that a nearly horizontal position is the original position of the beds of sedimentary rock.



FIG. 43.—Massive rock. The Upper Yosemite Falls. Compare the structure of the rock with that shown in Fig. 42.

Stratified rocks are more wide-spread beneath the mantle rock than the rocks of the other classes. They are found even in very elevated mountain regions, where the strata are sometimes tilted and folded in a very complicated way. Even in these high places they often contain the shells or other relics of animals which once lived in the sea.

From these facts the following conclusions may be drawn:

(1) The materials of which many of the rock formations of the land are composed were laid down beneath the sea; and (2) these deposits have been consolidated, many of them tilted out of their original positions, and some of them raised to great heights, since

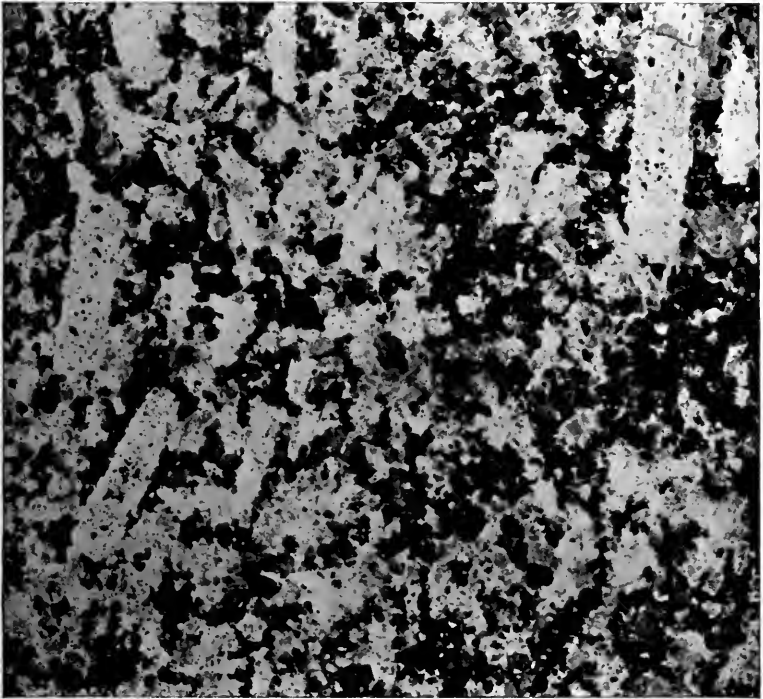

FIG. 44.—Granitic rock, about half natural size. The white patches represent crystals of one or two kinds of mineral, and the dark parts represent crystals of others.

their formation. Such rocks contain parts of the record of the earth's history, and point to very notable changes in its surface.

2. *Igneous rocks.* From volcanoes, hot liquid rock frequently comes to the surface from unknown depths. This liquid rock is *lava*. Some of the lava which rises from within the earth stops before it reaches the surface, and cools where it stops, and becomes solid rock. All sorts of rock formed by the solidification of lava are known as *igneous rocks*. They do not commonly occur in

distinct beds or strata, and so are said to be *non-stratified* or *massive* (Fig. 43).

Lavas vary much in composition. They also harden under different conditions, all of which have their effect on the character of the rock. The result is that there are many sorts of igneous



FIG. 45.—Metamorphic rock. (Ells. Can. Geol. Survey.)

rock. One of the best known is granite. It is composed chiefly of three or four minerals which have the form of imperfect crystals. The minerals are sufficiently different in color and outline to be readily distinguished, if the crystals are large enough to be distinctly seen (Fig. 44); but in some igneous rocks they are so small as not to be distinct. When lava cools very quickly, the mineral matter of the liquid lava sometimes fails to crystallize. It then forms a glassy sort of rock.

When igneous rocks decay, as all igneous rocks do, the decayed particles at the surface may be blown or washed away, and may

then accumulate as sediment in proper situations. Igneous rocks may therefore give rise to sedimentary rock.

3. *Metamorphic rocks.* This is the name given to the third class of rocks, and means rock which has been notably altered from some previous condition. Either sedimentary rocks or igneous rocks may be changed into metamorphic rocks, especially through (1) the influence of great pressure, which alters the structure of the



FIG. 46.—Columnar structure in igneous rock. Sierra Nevada Mountains

rock (Fig. 45); (2) the action of water, which, by dissolving out some parts and depositing new matter, changes the composition of the rock; and (3) heat, which sometimes causes the mineral matter to crystallize anew in new forms. In these ways either sedimentary rock or igneous rock may be greatly changed.

All large bodies of rock, whether sedimentary, igneous, or metamorphic, are traversed by cracks or joints which break them up into larger or smaller masses. The joints may be vertical or inclined at any angle. Sometimes they are close together (Fig. 46) and sometimes they are far apart (Fig. 42).

## EXERCISE IN THE READING OF TOPOGRAPHIC MAPS

I. Study the following maps in preparation for conference on the maps:<sup>1</sup>*List of Maps*<sup>2</sup>

- |                         |                         |
|-------------------------|-------------------------|
| 1. Mt. Mitchell, N. C.  | 7. Glassboro, N. J.     |
| 2. Harrisburg, Pa.      | 8. Watrous, N. M.       |
| 3. Shasta Special, Cal. | 9. Marsh Pass, Ariz.    |
| 4. Tooele Valley, Utah. | 10. Mesa de Maya, Colo. |
| 5. Donaldsonville, La.  | 11. Muskego, Wis.       |
| 6. Fargo, N. D.—Minn.   |                         |

*Note.* In studying a topographic map, notice at the outset:

- (a) In what part of the country the region is situated.
- (b) The contour interval used.
- (c) The horizontal scale used.

## II. Apply the following questions to each of the above maps:

1. Is the region represented by the map a plain, a plateau, or a mountain tract? If more than one of these great types is shown, indicate the fact, and locate each definitely.
2. What range in elevation is shown on the map?
3. Is the climate of the region wet or dry? Basis for answer.
4. Is the region thickly or sparsely settled?
5. What occupations seem to be favored in this region?

REFERENCES.—The following globes, models, and charts are useful in the study of the topics discussed in this chapter:

1. The *Jones' Relief globe*, known as "*The Model of the Earth*": Chicago.
2. *Howell's models of the United States, North America, South America, Eurasia, Africa, and Australia*: Washington, D. C.
3. *Coast Survey Charts*. The illustrated catalog of these charts may be had of the U. S. Coast and Geodetic Survey, Washington, D. C., and from it charts may be selected intelligently.

<sup>1</sup>The author has carried on the conference work here referred to as follows: The class is divided into groups of four, and each group meets the instructor for a half-hour or for an hour, as the case may be, for the discussion and interpretation of the maps assigned. The maps (also relief-models, photographs, etc.) are studied in advance by the students. This sort of work is regarded as of the utmost importance.

<sup>2</sup>As in the preceding and following lists, these are sheets of the topographic maps issued by the U. S. Geological Survey. See foot-note, page 40.



## CHAPTER II

### THE WORK OF THE ATMOSPHERE

THE atmosphere is nearly everywhere in direct contact with the surface of the land, and it penetrates the soil and the rock beneath to considerable depths. Its effects on the soil and rock are many and varied, and only a few of the more important ones will be noticed here. Some of them are brought about by the movements of the air, some by the chemical activity of the elements of the air, while some are conditioned by the air, rather than accomplished by it.

#### MECHANICAL WORK.—THE WORK OF THE WIND

##### *Dust*

**Universality.** The atmosphere is never free from dust. On windy days in dry regions the amount of dust in the air is so great that it may be readily seen. Even when the air seems perfectly still, dust is present. This might be inferred from the fact that even on still days dust settles in houses and in enclosures of all sorts, and it may be seen directly by allowing light to enter a darkened room through a narrow crack or a small hole. In the light thus entering, myriads of dust-motes may be seen. Dust extends high up in the atmosphere, for it is found in abundance in the air over even the highest mountains. It is carried far from its sources, for it often falls at sea many miles from land, and it occasionally settles on the decks of vessels, even in mid-ocean, in such quantities as to be readily seen.

The universality of dust in the atmosphere may be shown in another way. If rain-water which has just fallen be evaporated, a slight amount of sediment remains. This sediment represents the dust which was brought down by the falling drops. Similarly, if fresh-fallen snow be melted and evaporated, there is a residue

of dust. This is the case even if the snow be taken from mountain tops, or from such a place as Greenland, far from the cultivated lands and streets which furnish much of the dust in regions which are thickly settled. Since all rains and snows bring down dust, we infer that dust is everywhere present in the lower part of the atmosphere.

**Sources of dust.** All the small particles of solid matter held in suspension in the atmosphere are called dust. Fine particles of earthy matter caught up from the surface of the land are most abundant, but the solid particles of smoke, the pollen of flowering plants, the spores of plants which, like the puffball, do not blossom, and minute organisms of other sorts are also abundant in the dust of the air. Fine particles of rock blown out of volcanoes are abundant in the vicinity of many active volcanoes, and a trifling amount of dust reaches the earth from extra-terrestrial sources.

On windy days quantities of dust are gathered from streets and plowed fields, and from any dry land surface which is not well covered with vegetation. Where the surface is very dry, as in desert regions, and the wind strong, such "clouds" or "whirls" of dust are sometimes swept up by the rising currents of air, so as to be seen for miles. From surfaces densely covered with vegetation the air gets little dust, except pollen. Little or none is gathered from surfaces which are wet, or from surfaces covered with snow or ice.

**Volcanic dust.** Volcanoes whose eruptions are explosive often



FIG. 47.—Particles of volcanic dust.

send quantities of mineral matter, broken up into fine particles, high into the air. This is *volcanic dust*, or *volcanic "ash."* The latter name is not a good one, because the dust is not the product of burning. It is lava, blown into tiny bits by explosion (Fig. 47). The force of explosion is sometimes so great that the dust is sent up high into the air, and once in that position it is blown hither and thither by the winds, sometimes being carried great distances.

In August of 1883 a violent volcanic eruption took place on the island of Krakatoa, between Java and Sumatra. Half of

the island was blown away, and enormous quantities of dust were projected high into the air. The course of this dust in the air was traced, roughly, by means of its effects upon the coloring of the sunsets. In this way it was estimated to have been blown completely around the earth in about fifteen days. The course of most of the dust was around the earth in latitudes near the equator, but from this low latitude it spread notably toward the poles. It has been estimated that some of the dust was still in



FIG. 48.—Thick layer of volcanic dust (5 or 6 feet) on the Richmond estate, Island of St. Vincent, five miles from the crater of the Soufrière. After the eruption of 1902. (Hovey, Am. Mus. Nat. Hist.)

the air three years after the eruption, and that some of it went several times around the earth before settling. It is probable that the dust from this single volcanic eruption found its way to nearly all parts of the earth. This example may serve to illustrate the extent to which dust is carried in the upper part of the air, and the length of time it may be held in suspension. Dust in the lower part of the air is not usually held so long or carried so far, partly because the winds are less strong, and partly because the dust encounters all sorts of obstacles, such as hills, trees, etc., against which it lodges. Large quantities of dust were ejected

from the Soufrière and from Pelée, in the West Indies, in the eruptions of 1902 (Fig. 48).



FIG. 49.—Bluff of loess at Kansas City. (Mo. Geol. Surv.)



FIG. 50.—Vertical face of loess near Huang-tu-Chai in northern Shan-si. (Willis, Carnegie Institution.)

**Loess.** In some parts of China, in parts of Europe, and over considerable areas in the Mississippi basin there are considerable thicknesses of a distinctive earthy material, the particles of which



FIG. 51.—A bluff of loess in China on which stands a temple.  
(Willis, Carnegie Institution.)

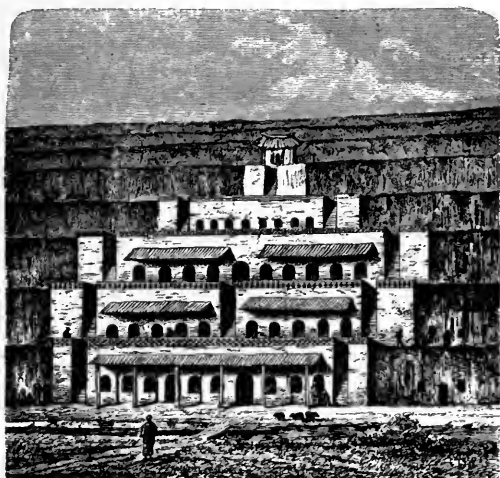

FIG. 52.—Façade of a group of buildings in a bluff of loess, Province of Shan-si, China. (Richthofen.)

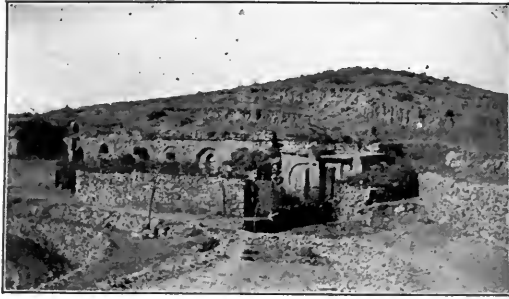

FIG. 53.—Dwellings in loess, Province of Shan-si, China.  
(Blackwelder, Carnegie Institution.)



FIG. 54.—A roadway in China which has been deepened by the removal of loess by wind and water. (Willis, Carnegie Institution.)

are smaller than sand grains, but larger than the particles of clay. It is known as *loess*, and much of it, at least, was deposited by the wind. From the flood plains of such rivers as the Missouri clouds of dust are swept up and out over the adjacent high lands at the present time, whenever the surface of the flood plain is dry and the wind strong. This dust is very like loess, if, indeed, it be not loess. The loess has the remarkable property of standing with



FIG. 55.—Slopes of loess in China, terraced for agricultural purposes.  
(Willis, Carnegie Institution.)

steep or vertical faces (Figs. 49-51) for long periods of time. In China the loess is said to be several hundred feet thick locally, but in the Mississippi basin it rarely reaches a thickness of more than 30 to 50 feet. In parts of China the people have excavated houses in successive tiers along the faces of the soft though steep slopes of the loess (Figs. 52 and 53).

**How held in the air.** Though made up largely of mineral matter which is much heavier than the air, dust is kept in suspension, first, because the particles are so small that their surfaces are large in proportion to their masses, so that the friction involved in their descent through the air is great; and second, because there are numerous upward currents in the atmosphere, and these

rising currents carry particles of dust upward in spite of gravity, which is always tending to bring them down. As a matter of fact, the dust of the atmosphere is always settling somewhere, and the supply is being constantly renewed.

**Distribution.** In view of what is known concerning the movements of dust in the air, it would probably involve little exaggeration to say that every square mile of the earth's surface may have received dust from every other square mile which is capable of furnishing dust to the atmosphere. Much of the dust of the atmosphere falls into the ocean, or into other bodies of water, where it is safe from further disturbance by winds; but that which lodges on land may be picked up and blown about again and again.

**Gradational effect of winds.** Since dust is being blown constantly from the land to the sea, and since the sea is making no commensurate return to the land, the shifting of dust by the wind tends, on the whole, to lower the land and to build up the sea bottom. Locally, however, the wind-deposited dust aggrades the land.

### *Sand*

**Sources of sand.** Even gentle winds pick up and carry dust; strong ones pick up and carry grains of sand, and even tiny pebbles. Like the finer material, sand is blown about only when it is dry. Abundant sand is found along many shores of seas and lakes, along the bottoms of some valleys, in desert regions, and in some other situations. In most of these places it is dry at times, and in some of them it is dry most of the time.

**Lodgment of wind-blown sand.** Sand grains are not often carried up to such great heights as particles of dust, nor do they remain so long in the air. Because of their greater mass, they drop through the atmosphere more promptly when the velocity of the wind is checked. Because they are carried chiefly in the lower part of the atmosphere, they are much more likely than dust to be stopped by obstacles on the surface of the land. Thus every tree, log, stump, building and fence, and every mound and hill against which sand is blown, is likely to cause the lodgment of some of it, just as they are likely to cause the lodgment of wind-blown snow. It follows that sand, instead of being somewhat evenly distributed, as dust is, is often accumulated in mounds and ridges, which begin their growth about almost any sort of obstacle on the surface.



**Dunes.** Mounds and ridges of wind-blown or eolian sand are *dunes* (Fig. 56). Once started, a dune becomes an obstacle to blowing sand, and the lodgment of more sand causes the dune to grow. In this way, mounds and ridges of sand, scores and sometimes even hundreds of feet high, are built up by the wind. Small dunes are much more numerous than large ones.



FIG. 56.—A ripple-marked sand dune in a western valley. (U. S. Geol. Surv.)

**Distribution of dunes.** Dunes are found principally near the sources of abundant sand. Thus they are common along the Atlantic Coast of the United States south of New York. The sand is here washed up on the beach by the waves, and whenever it dries it may become the prey of the wind. Winds from the west blow the sand into the sea; those from other directions, but especially from the east, drift it up onto the land, making dunes. Dunes abound along the eastern side of Lake Michigan, and some of them are very large; but they are essentially absent from the west shore of the lake. This is because both the prevailing and the strongest winds are from the west. Dunes are also more common on the leeward than on the windward sides of valleys. Thus where west-

erly winds prevail, dunes are more common on the east sides of valleys than on the west sides. They are on the whole more com-



FIG. 57.—A group of dunes at the head of Lake Michigan. Dune Park, Ind. (Meyers.)

mon on the south than on the north sides of valleys, because the storm winds of winter are from the north of west, rather than from the south of west. Dunes abound over tracts of thousands

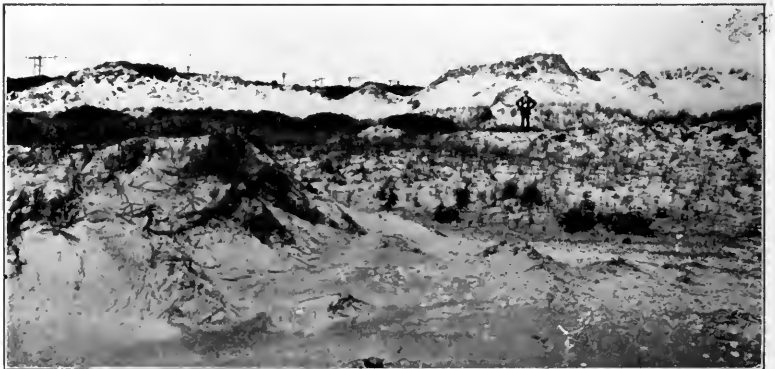

FIG. 58.—Dunes at Longport, coast of New Jersey, showing the irregular forms developed by winds which erode.

of square miles in extent in the semi-arid tracts of the Great Plains, as in western Nebraska and western Kansas. The dune area be-

tween the Arkansas River and the Cimarron was the most difficult portion of the famous Santa Fé trail. Dunes of great size occur also in the west-central part of Wyoming. They reach their greatest development in still more arid regions, such as Sahara.

Locally dunes are the most conspicuous feature of the surface. They are, on the whole, more common on plains and low plateaus than in mountains.

**Configuration of dunes.** The shapes of dunes vary widely. When they take the shape of mounds, they may be round or oval, or they may be very irregular in outline. When they take the form of ridges they may be short or long, straight or curved. In general one slope, the leeward, is steeper than the other, the windward. The shape of the same dune, however, shifts from time to time. When dunes are in process of destruction by the wind, their forms are often very irregular (Fig. 58). This is sometimes because the vegetation growing on them holds the sand in which it is rooted.

Associated with the dunes there are often depressions (Pl. V). Some of them are without outlets, while others have outlets. Some of these depressions were scooped out by the wind, and some of them were enclosed by the building up of dunes about them.



FIG. 59.—Lee side of a sand dune, Cape Henry, Va. The dune is advancing on a forest and burying the trees. (Hitchcock.)

**Destructiveness of eolian sand.** The piling up of sand into dunes sometimes does great damage. Narrow tracts of arable



FIG. 60.—Sand dune showing the effect of a building on the disposition of the sand. The wind reflected from the building keeps sand from accumulating against it. Manistee, Mich. (Hitchcock.)



FIG. 61.—Sand drifted over railway. Rowena, Wash. (Dept. of Agr.)

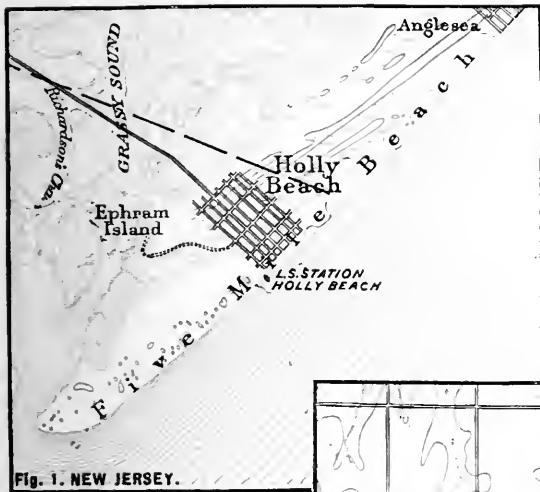

FIG. 1.—Dunes on coast of New Jersey. Scale 1—miles per inch. (Cape May Sheet, U. S. Geol. Surv.)

Fig. 1. NEW JERSEY.

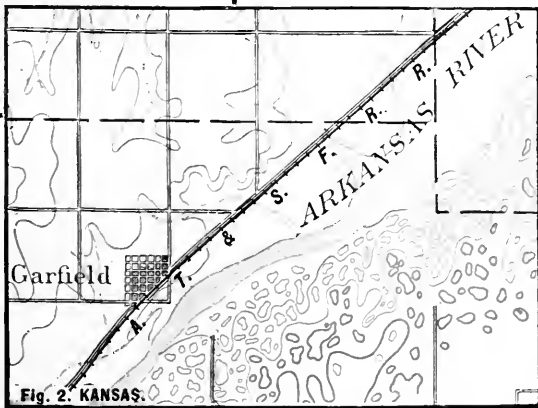

FIG. 2.—Dunes along Arkansas River in Kansas. Scale 2—miles per inch. (Larned Sheet, U. S. Geol. Surv.)

Fig. 2. KANSAS.

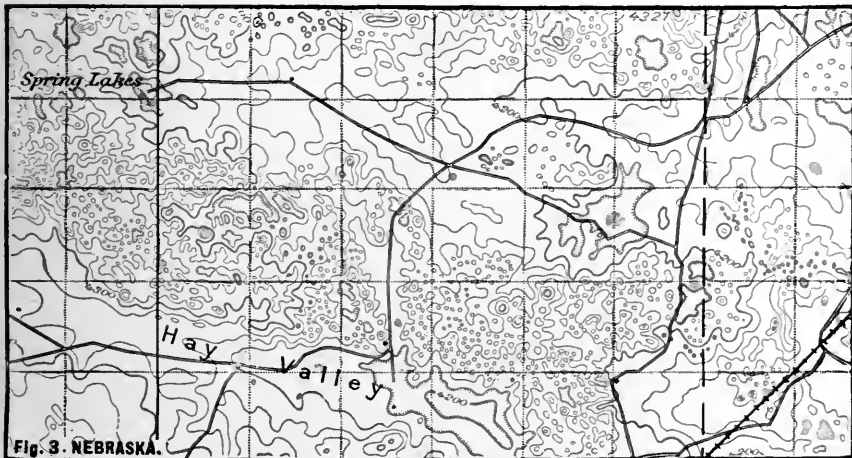

Fig. 3. NEBRASKA.

FIG. 3.—Dunes in plains of Nebraska. Scale 2—miles per inch. (Camp Clarke Sheet, U. S. Geol. Surv.)



land along seacoasts have been made desolate by the formation of dunes. Even forests of large trees are sometimes buried beneath them (Fig. 59). Some sorts of trees make heroic efforts to maintain their life against the burying sands by throwing out roots far above their original bases. In this way some of them survive until they are nearly covered up; but if the sand finally covers their tops, they are killed. Occasionally, too, the sand buries abandoned buildings. It rarely accumulates so rapidly about a building that it may not be kept away by human effort. Drifting sand is sometimes the occasion of much trouble along railways, as shown in Fig. 61. Many caravans have been destroyed in the African desert by sand storms, and an army of Cambyses numbering 50,000 is said to have been overwhelmed and buried.

**Migration of dunes.** Dunes are often migratory. Sand is blown from their windward sides and dropped on the leeward sides. The continued shifting of sand from the windward to the leeward side causes the slow movement of the dune in the direction of the prevalent winds. The migration of dunes, like their first de-



FIG. 62.—A resurrected forest. After burying and killing the forest, the sand was blown away, exposing the dead trees. (Meyers.)

velopment, often works destruction to cultivated lands, to forests, to buildings, etc.

Some idea of the extent to which dunes migrate may be gained both from natural phenomena and from historic records.\* Thus when dunes which have buried forests move on, the forests which

were buried and killed are again discovered. This is illustrated by Fig. 62. The movement of the dune sand may discover other things also. At one locality on the coast of North Carolina a sand area was utilized for a cemetery. The wind has now blown the



FIG. 63.—Migration of dune sand, exposing bones in a cemetery. Hatteras Island, N. C. (Cobb.)

sand away to such an extent as to expose the bones of the bodies buried (Fig. 63). Buildings buried by dunes are sometimes again revealed after the dune has moved on. This is shown by Fig. 64.

Recent discoveries indicate that “there are hundreds, perhaps thousands, of square miles of buried towns and cities”<sup>1</sup> in Central Asia. At least a part of these cities have been buried by migrating dunes.

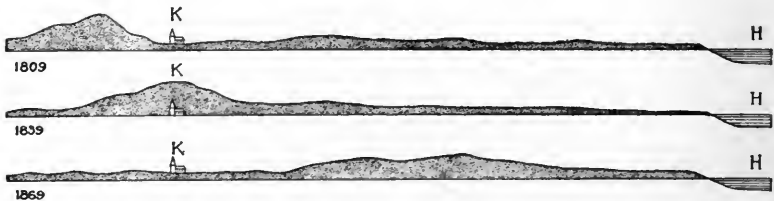

FIG. 64.—Diagram illustrating the migration of dunes. Kurische Nehrung. (Credner.)

So disastrous is the migration of dunes along some coasts that steps are taken to prevent their movement. If a dune becomes clothed with vegetation, its position is not likely to be changed so long as the vegetation remains, for the plants have the effect of

<sup>1</sup> Nat. Geog. Mag., Vol. XVI, 1905, p. 499.



pinning the sand down. Trees, shrubs, etc., adapted to such situations are sometimes planted in the sand to prevent its further drifting (Fig. 65). This is done at various points along the western coast of Europe, where land is valuable. It has been done to some extent in our own country, as at San Francisco, where shrubs have been planted on the coastal slope to prevent

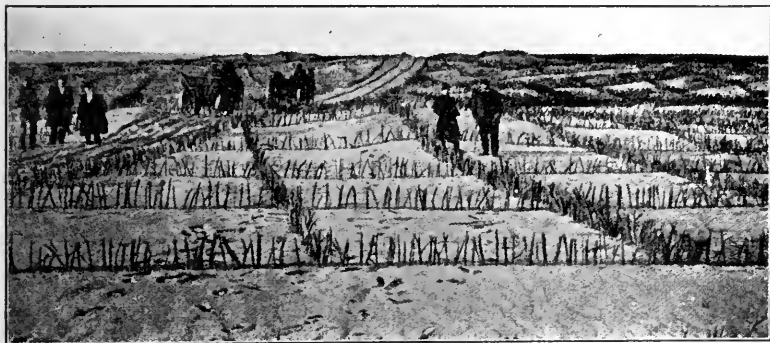

FIG. 65.—Dune sand held by brush-fences on Kurische Nehrung.

the sand of the shore from blowing over the Golden Gate Park. Between 1826 and 1838 the Government spent \$28,000 to fasten the dune sands on the harbor shores of Provincetown, Mass. Even in such cases, however, additional sand may be deposited on the plant-covered dune.

**Not all eolian sand in dunes.** Eolian sand is not always built up into dunes. It is sometimes spread somewhat evenly over the surface where it lodges. Eolian sand is probably much more wide-spread than dunes are.

**Ripple-marks.** The surface of wind-blown sand is often marked by pronounced ripple-marks (Fig. 56), very like those which affect the surface of sand deposited beneath water.

**Gradational effects.** Much sand is blown from the land into the sea; but the waves wash some of the sand up on the beach again. The one process reduces the volume of the land, while the other increases it. The relative importance of these two processes is not known. On the whole, the degradation effected by the blowing of sand exceeds the aggradation effected by its deposition, so far as the land is concerned. The aggradational effects are, however, very conspicuous locally.

The amount of dust and sand shifted about on the land, or from the land to the sea by the wind, is very great. It has been estimated that in violent dust-storms the amount of dust and

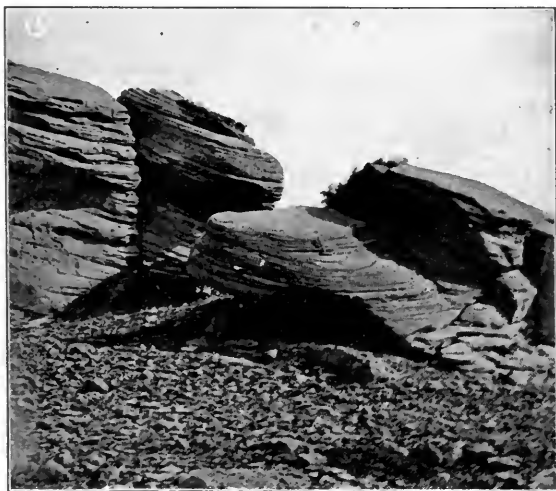

FIG. 66.—A phase of wind-carving on sandstone. Wyoming. (Bastin.)



FIG. 67.—A phase of wind carving near Klondike, Wyo. (Leffingwell.)

sand in the air may amount to as much as 126,000 tons per cubic mile of air. The average amount of dust in the air, however, is probably but a very small fraction of one percent. of this amount.

If we knew how many tons of sand and dust were blown from the land to the sea each day, the figures would doubtless be most impressive, but the amount has never been measured or even estimated.

**Abrasion by the wind.** Sand and dust blown against a surface of rock have the effect of a sand-blast, and wear away even hard rock. If the surface against which sand is driven is of unequal hardness, the softer parts are worn more rapidly than the harder.



FIG. 68.—Erosion Columns in Monument Park, Colo.; partly the product of wind erosion. (Fairbanks.)

In regions where abundant sand is driven by the wind, projecting rocks are often carved into fantastic forms (Figs. 66-68). Abrasion by wind-driven sand is of little consequence in a plain country where the climate is moist, and where bare rock is rarely exposed; but it is of much consequence in semi-arid regions where the topography is rough, and where hills and points of bare rock are numerous. Wind-driven dust is much less efficient than sand in the wear of rock surfaces.

#### THE CHEMICAL WORK OF THE AIR

One of the principal constituents of the atmosphere is oxygen, and oxygen is a substance which is chemically active, especially in

the presence of moisture. This is readily seen when a piece of steel, such as a knife-blade, is exposed to the air. It promptly *rusts*. This means that both oxygen from the air, and water, have entered into combination with the iron, and the iron-rust contains all three substances, united into one. It is a matter of common knowledge that the iron-rust scales off, and that a knife-blade will soon be "eaten away" by this process, that is converted entirely into rust. When oxygen unites with iron the iron is said to be *oxidized*. If water enters into combination at the same time, as it does when iron rusts, the iron oxide is said to be *hydrated*. Iron-rust is therefore the *hydrated oxide of iron*. The amount (weight) of oxygen and water in iron-rust is greater than the weight of the iron.

Similar changes go on in the rocks. Iron, in some combination or other, is abundant in some rocks, and present in most of them, and the iron in the rocks is subject to changes similar to those suffered by the knife-blade; and in the rocks, as in the knife-blade, the oxidation of the iron generally leads to the crumbling of the rock of which it is a constituent. Other substances in the rocks also are oxidized and hydrated, usually with the result of tending to break up the rock.

Other constituents of the atmosphere are also active in changing some of the minerals of the common rocks. This is the case, for example, with the *carbonic acid gas* ( $\text{CO}_2$ ) of the atmosphere, which enters into combination with certain constituents of the rock. The union of carbonic acid gas with constituents of the rock is known as *carbonation*. Like oxidation, carbonation usually results in the crumbling of the rock affected.

**Weathering.** All changes which, like oxidation and carbonation, lead to the breaking up of the rock are phases of the general process of *weathering*, which includes most of the natural processes by which rock at or near the surface is caused to crumble. The processes of weathering are very important. Much of the soil and subsoil (mantle rock) of the earth have been produced by them. Furthermore, the weathering of the rock is a necessary preparation for its ready transportation by wind and water.

#### CHANGES BROUGHT ABOUT UNDER THE INFLUENCE OF THE AIR

The surface of the land is subject to great changes of temperature, and these changes are of importance in its physiography. The effects of temperature changes on the rocks of the earth are

much more obvious in some regions than in others; but, directly or indirectly, they are of more or less importance everywhere.

**Freezing and thawing.** In many regions where the surface is well covered with soil, the soil freezes in winter; that is, the water in the soil freezes, so that the soil becomes solid. While the soil is frozen it cannot be blown or washed away. In low temperatures, too, the precipitation falls as snow instead of rain, and the snow does not immediately have the same effect as rain on the land. When it is melted the water runs over the surface much as rain-water would; but if the soil beneath the melted snow be frozen, the effect of the running water is relatively slight.

Where the soil is thin, the waters which sink beneath the surface may freeze in the cracks of the rock below. Since water expands about one-tenth of its volume on freezing, the ice which forms in the cracks (joints) of the rock when they are nearly full of water, acts like a wedge, widening the cracks and forcing the parts of the rock asunder. The effect is illustrated by the frequent breaking of bottles or other vessels in which water is allowed to freeze. This process of rock-breaking is most important where there is abundant moisture, and where the changes of temperature above and below the freezing-point of water are frequent, that is in middle latitudes, or in altitudes which have the temperatures of middle latitudes.

**Expansion and contraction of rock; rock-breaking.** When solid rock has little or no covering of loose material, as is often the case on steep slopes, it is heated by day and cooled by night. At high altitudes, and especially on slopes and cliffs exposed to the noonday sun, the daily changes of temperature of the surface of the rock are great. In such places the surface of the rock may become very hot while the sun shines. Since rock is a poor conductor of heat, only its outermost portion is heated notably. Heat expands rock, and as the heated part expands it is likely to scale off from the cooler, unexpanded or less expanded part beneath. As the sun descends, the surface cools and contracts. The outermost film of rock cools first, and most, and tends to break. The breaking of cool glass by touching it with hot water, or of hot glass by touching it with cold water, involves the same principle.

The breaking of rock by heating and cooling, even when ice is not formed, is a very common phenomenon. Thus on hot days in summer the blocks of cement in cement walks sometimes

expand so much as to break (Fig. 69). The heat of the sun sometimes so expands the rock in the floor of a rock quarry that it is similarly bowed up and broken. This has been seen repeatedly in the limestone quarries about Chicago, and on the floor of the Drainage Canal before the water was turned in. Many boulders which lie on the surface are seen to be "shelling off" (Fig. 70),



FIG. 69.—A cement walk broken under expansion by sun-heat.

and the same process is sometimes seen on mountain tops (Fig. 71). In high mountain regions where the changes of temperature of the rock are great and sudden, the exposed rock is often much broken. So far has this gone that the surface of many a sharp mountain peak is covered with cracked and broken rock, so insecure that a touch or a step will loosen numerous pieces and start them down the mountain (Fig. 72). Quantities of such debris



FIG. 70.—Concentric weathering, or exfoliation of boulder. Eastern California. (Fairbanks.)

(called *talus*) bury the bases of many of the western mountains many hundreds of feet (Fig. 73). The pieces of talus range in size from tiny bits up to masses tons in weight.

The breaking of rock through changes of temperature is not the



FIG. 71.—Exfoliation on a mountain slope. Mount Starr-King, Cal.



FIG. 72.—Crumbling on a mountain top. Kearsarge Pass, Sierra Nevada Mountains.

work of the atmosphere; but the atmosphere has much influence on the changes of temperature, on which the process depends.

This process of rock breaking is a phase of *weathering*. The debris loosened in this way moves from higher to lower levels under the influence of gravity, if it moves at all. The general effect of the process is to make high places lower, and to build up the lower surfaces about the bases of steep slopes.

There are many other phases of weathering not due to the atmosphere, and not altogether conditioned by it. Some of these are illustrated by Figs. 74 and 75.



FIG. 73.—Talus slope.

The roots of the plants penetrate the soil, loosening it, and thereby make it easier for water to get below the surface. Roots sometimes grow in cracks in the rock, and as they grow they act like wedges (Fig. 74). Large masses of rock are sometimes loosened in this way. When a tree is uprooted, the ground is torn up, and rock material to the depth of several feet is sometimes exposed to the action of freezing water, air, and rain (Fig. 75). Again, when plants decay, acids are formed which increase the dissolving power of ground-water. Burrowing animals of all sorts loosen the ground and develop channels for the entrance of water. Even





FIG. 74.—Tree growing in crack in a rock, and by its growth splitting the rock.



FIG. 75.—Uprooted tree, showing the disturbance of soil and rock.  
(U. S. Geol. Surv.)

such small animals as ants and earthworms perform an important work in this connection. In Massachusetts the ant has been estimated to bring one-fourth of an inch of fine earth to the surface each year, while Darwin estimated that the earthworm brings seven to eighteen tons of material per acre to the surface each year.

#### SUMMARY

On the whole, the tendency of the work of the atmosphere and of the work which is controlled by it, is to lower the surface of the land, and to loosen materials of the surface so that they may be readily moved to lower levels by other agencies. The most important phase of the degradational work of the atmosphere is *weathering*, or the preparation of material for removal by other and more powerful agents of degradation. As we shall see, however, the atmosphere is not the only agent concerned in weathering (see p. 110).

#### REFERENCES

1. CORNISH, *On the Formation of Sand Dunes*: Geog. Jour., Vol. IX, 1897, pp. 278-309.
2. UDDEN, *Erosion, Transportation, and Sedimentation performed by the Atmosphere*: Jour. of Geol., Vol. II, pp. 318-331, and Pop. Sci. Mo., Sept., 1896.
3. CHAMBERLIN AND SALISBURY, *Geologic Processes*, Chapter II: Henry Holt & Co., 1903.
4. GEIKIE, *Earth Sculpture*, Chapter XII: Putnam.
5. HITCHCOCK, *Controlling Sand Dunes in the United States*: Nat. Geog. Mag., Vol. XV, pp. 43-47, 1904.
6. COBB, *Nat. Geog. Mag.*, 1906, pp. 310-317.
7. MERRILL, *Principles of Rock Weathering*: Jour. of Geol., Vol. VI, pp. 704-724 and 850-871;—also *Rocks, Rock Weathering, and Soils*: Macmillan.
8. COWLES, *The Plant Societies of Chicago and Vicinity*: Bull. 2, Geog. Soc. of Chicago. (Deals with relations of dunes and vegetation.)
9. SALISBURY AND ALDEN, *Geography of Chicago and its Environs*: Geog. Soc. of Chicago, 1899, pp. 60-63.
10. All standard text-books on Geology.
11. The following *Topographic Sheets of the U. S. Geol. Surv.*:
 

Long Beach, N. J.	North Platte, Neb.	Great Bend, Kan.
Sandy Hook, N. J.	Green Run, Md.-Va.	Kinsley, Kan.
Barnegat, N. J.	Fire Island, N. Y.	Hutchinson, Kan.
Atlantic City, N. J.	Springfield, Colo.	Lakin, Kan.
Asbury Park, N. J.	Dodge, Kan.	Pratt, Kan.
Browns Creek, Neb.	Larned, Kan.	
St. Paul, Neb.	Kingman, Kan.	
12. The following *Folios of the U. S. Geol. Surv.*:
 

Norfolk, Va.	Camp Clarke, Neb.	Scotts Bluff, Neb.
--------------	-------------------	--------------------

## TOPOGRAPHIC MAPS SHOWING EFFECTS OF WIND-WORK

I. Study the following topographic maps in preparation for the conference:<sup>1</sup>

- |                            |                    |
|----------------------------|--------------------|
| 1. Sandy Hook, N. J.—N. Y. | 5. Barnegat, N. J. |
| 2. Cape May, N. J.         | 6. Larned, Kan.    |
| 3. Toleston, Ind.          | 7. Pratt, Kan.     |
| 4. St. Paul, Neb.          | 8. Kinsley, Kan.   |

II. Geologic Folios<sup>2</sup> to be studied:

- |                       |                      |
|-----------------------|----------------------|
| 1. Norfolk, Va.—N. C. | 2. Camp Clarke, Neb. |
|-----------------------|----------------------|

III. Suggestions for the study of the above maps:

On these maps mounds, hills, and ridges of wind-blown sand, or dunes, are represented. In studying the dunes note:

1. The various shapes, sizes, and modes of aggregation of the dunes in the several regions.

2. The average height of the dunes above their surroundings in the different regions.

3. The distribution of the Kansas dunes with reference to the stream courses. Is any law of distribution suggested by the map? If so, how is it to be accounted for?

4. What are the immediate sources of the sand which forms the dunes in the different regions, so far as can be inferred from the maps?

5. Note that in several of the areas depressions are numerous among the dunes. May the wind be responsible for them?

6. Locate the dunes on the "Topographic Sheet" of the Camp Clarke folio. Then turn to the next map of the folio, the "Areal Geology Sheet." Here the dune areas are colored yellow (see legend). From the topographic map form a mental picture of "Jail Rock," "Smokestack Rock," and "Chimney Rock." Test your picture by reference to Figs. 18, 20, and 23 in the back of the folio. The wind is playing an important part in the reduction of these elevations. How?

<sup>1</sup> See foot-note, page 54.

<sup>2</sup> The folios, like the topographic maps, are published by the U. S. Geological Survey. Most of them can be purchased at 25 cents each.

## CHAPTER III

### THE WORK OF GROUND-WATER

#### GENERAL FACTS

WATER is one of the most active agents working on the land. Its activity is seen on every slope during heavy falls of rain and when snow is melting rapidly, and it is seen in every stream and in the waves of lakes and seas. Even the water in the soil and in the rocks beneath the soil is active, though its effects are less obvious than those of streams and waves.

The great activity of the water, like that of the air, is due primarily to its mobility; but its greater weight makes moving water much more effective than moving air when it comes in contact with the land.

**Source of land-water.** The waters of the land have fallen from the atmosphere, which always contains some moisture in the form of water vapor. This vapor is constantly passing up into the air from all moist surfaces by *evaporation*, a process which will be considered in another chapter; but the familiar fact that any moist surface soon dries in the sunshine, or in any warm dry place, may be taken to illustrate what is going on at all times, both from moist land surfaces and from water surfaces.

Under certain conditions some of the moisture in the air is condensed into drops and falls as rain; or if the temperature at which the water vapor condenses is below the freezing-point of water, the moisture freezes as it condenses, forming snowflakes (Fig. 76) instead of rain-drops. The average amount of rain and snow (snow-water) which falls on the land is something like 40 inches per year (10 to 12 inches of snow being counted as one of water). In other words, the *precipitation* (the rain and snow) which falls on the land each year is enough to make a layer of

water rather more than three feet, or about one meter, deep over the surface of the land, if it were equally distributed. Forty inches of water over the land would make about 35,000 cubic miles of water. Since the rivers discharge but about 6500 cubic miles of water into the sea yearly, it is clear that the larger part of the rainfall is not carried to the sea by rivers.

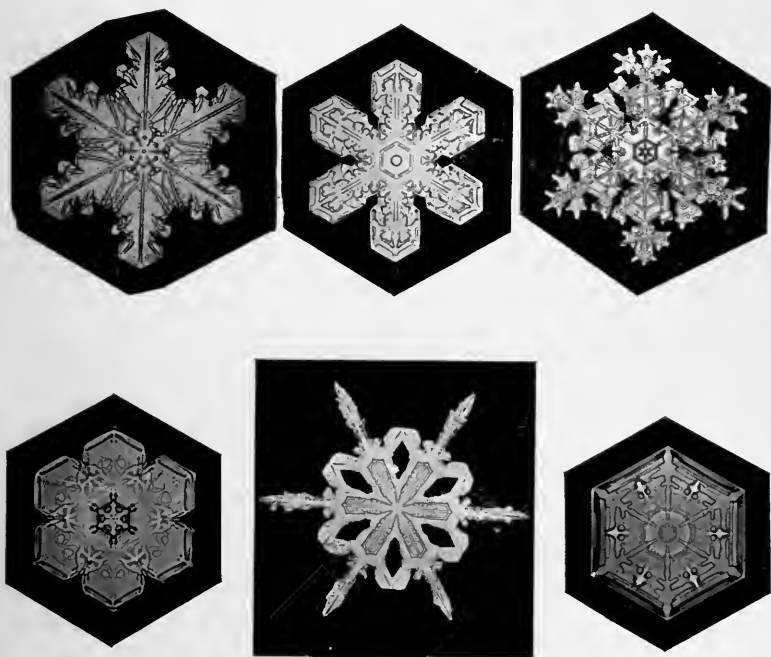

FIG. 76.—Photographs of snowflakes, showing something of their diversity of form. (Bentley.)

**The fate of rain-water.** The water which falls on the land disappears in various ways. A part of it sinks at once beneath the surface, a part forms pools or lakes upon the surface, a part runs off over the surface directly, and a part of it is evaporated. The proportion of the rainfall in any given place which follows each of these courses depends upon several conditions, among which are (1) the topography of the surface, (2) the rate of rainfall (or the rate at which snow melts), (3) the porosity of the soil or rock, (4) the amount of water which the soil already contains

when the rain falls or the snow melts, (5) the amount of vegetation on the surface, and (6) the dryness of the atmosphere.

Considering these points in order, we find (1) that the steeper the slope on which rain falls or snow melts, the more rapidly the water runs off, and the larger the proportion which follows this course; for when it flows off rapidly there is little time for it to sink in or evaporate.

(2) The more rapidly the rain falls, the less the proportion which sinks in. The sinking of the water is a slow process, especially if the soil is compact. In sinking, the water first fills the pores of the surface, and no more can enter until that already in has had time to sink out of the way. If, therefore, the rain falls rapidly, less sinks in and more runs off over the surface than if it falls slowly.

(3) Loose or open soil, such as sand or gravel, takes in the water more readily than clay or other compact material. A clayey soil, therefore, causes a larger part of the rainfall to run off over the surface, because it allows less to sink in in a given time. Not only this, but a porous soil will hold more water, because the *pore space*, that is the space between its constituent parts, is larger. A special case of compactness arises in connection with changes of temperature. When the ground is frozen, that is when the water in it is frozen, the soil is rendered solid and less porous, and surface water can penetrate it but slightly, even if the surface water remains unfrozen. When the soil beneath snow is frozen, the water produced by the melting of the snow does not readily enter it, and so a large part is allowed to run off over the surface.

(4) When the soil contains much water, less can enter, and more runs off over the surface.

(5) Vegetation serves to restrain the flow of surface water, and holds it longer on the surface. As a result there is more time for the water to sink in, and less runs off without sinking.

(6) If the air is very dry, a larger proportion of the rainfall evaporates directly, leaving less to run off or sink in. The effect of dryness on evaporation is conspicuous in arid regions, where the surface dries quickly after a shower, and where light snows often entirely disappear in a short time by evaporation, even when the temperature is constantly far below the freezing-point of water.

The water which sinks into the ground becomes *ground-water*, while that which flows off over the surface without sinking is the *immediate run-off*. Much of the ground-water ultimately reaches the surface again, and some of it joins the immediate run-off in the streams. All the water which the streams carry, whether it has been beneath the surface or not, is the *run-off*.

**The existence of ground-water.** The soil of most regions is damp at a depth of a few inches, or at any rate a few feet, even when it seems dry at the surface. In deep holes, like wells, water seeps or flows in from the sides, and collects in the bottom. In thickly populated farming communities there are wells on almost every farm, and all are supplied with water. Illinois has more than 250,000 farms, and it is probable that the number of wells in the state is double the number of farms. The total number of wells in the United States must be several millions, and the amount of water drawn out through them each day is very great; yet the wells do not ordinarily go dry. Mines, too, usually encounter water at no great depth from the surface.

**The source of ground-water.** Since rain-water and melted snow are constantly sinking beneath the surface, since rain and snow seem like an adequate source of supply for the ground-water, and since no other source<sup>1</sup> whence it can come is known, it is inferred that surface water is the source of ground-water. Other phenomena point to a close connection between the two. Thus in time of drought many shallow wells and some springs go dry. When the drought is broken by renewed rainfall, the wells again contain water, and the springs again flow. This seems to establish a direct connection between precipitation from the atmosphere and the supply of water beneath the surface.

While the proportion of rainfall which sinks beneath the surface is determined by the conditions already suggested, the amount of water beneath the surface, other things being equal, is great where the rainfall is great. The amount of ground-water in any region is, however, not entirely dependent on the rainfall of that region, for water falling in one place may flow underground to another. Thus rain-water which falls in the Rocky Mountains flows

<sup>1</sup> Water rarely sinks into the ground from lakes, rivers, etc., though it does so under some circumstances. Rivers and lakes are, however, fed by rain-water, either before or after it has been underground, so that ground-water derived from lakes and rivers comes from atmospheric precipitation.

underground through porous beds of rock out under the Great Plains, where it is brought to the surface through wells (Fig. 77).



FIG. 77.—Diagram showing how water falling in one place may flow underground to another and there be brought to the surface. The layer *a* is porous and water entering it in the mountains follows it to the plains.

**Descent of ground-water.** The manner in which water enters the soil is readily seen. It sinks in through all the pores and cracks. In the soil and subsoil pores are more common than cracks, but in the solid rock beneath, cracks are common, and while pores are not absent, they are often much smaller than the cracks. Since the cracks in rock run in various directions, the water descends not only vertically, but in oblique directions as well. Water descends as long as there are cracks and pores or openings of any sort not already filled with water; but the smaller these passageways become, the more difficult it is for the water to pass through them. If, for example, small pores, such as those which occur in compact soil or rock, be diminished in size one-half, the difficulty of the descent of water is much more than doubled.

Generally speaking, the rocks near the surface have more and larger pores than those at greater depths. It follows that as the pores get fewer and smaller with increasing depth, the difficulty with which water descends increases.

It cannot be stated definitely how far down cracks and openings exist; but it seems probable that all openings become very small at a depth of a mile or two, and that none exist below a depth of five or six miles. At this depth the rock is under the pressure of a column of rock five miles high, and the weight of such a column is so great that, in any ordinary sort of rock, cracks and pores would be closed, if once formed. Since different sorts of rock have unequal strength, pores and cracks might exist in different sorts of rock at somewhat different depths, but probably in no rock at a depth of more than about six miles.

For these reasons it is not probable that the water descends more than five or six miles, and the amount of water below the



depth of even one or two miles is probably far less than the amount above that level.

**The ground-water surface.** Though the amount of water beneath the surface is very great, as common phenomena show, the porous rock and soil are rarely altogether full of water. This is shown by the fact that it is necessary in many regions to dig wells to a depth of several scores or even hundreds of feet before an adequate supply of water is obtained. The surface soil is rarely full of water except immediately after a heavy rain, or when snow is melting.

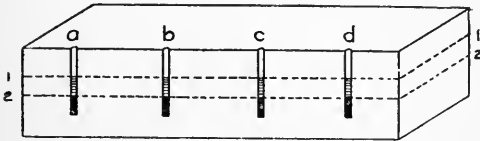

FIG. 78.—Represents a series of wells sunk in a flat tract of land.

If a series of wells be dug in a flat region, where the soil and rocks are essentially uniform, they would need to be dug to about the same depth in order to secure a constant supply of water. This is illustrated by Fig. 78. If the well at *a* is dug to a given depth, a well at *b* will need to be dug to about the same depth in order to secure an equal supply of water. Other wells at *c* and *d* will also need to be of approximately the same depth. Under these circumstances, the water in the several wells will stand at about the same level. This means that the rocks and subsoil of

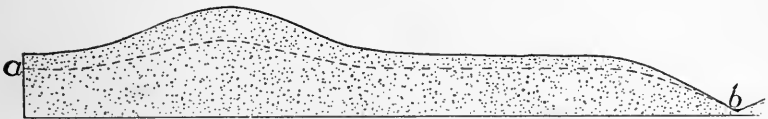

FIG. 79.—Diagram illustrating the position of the ground-water surface (the dotted line) in a region of undulating topography.

the region, below the level of the water in the several wells, are full of water. The underground surface below which the rocks etc., are full of water in any given region is the *water surface* (or *water table*) for that region. In one region the water surface may be 10 feet below the actual surface, and in another 100 feet. In dry regions it may be even deeper, but where the rainfall is

sufficient for agricultural purposes, the water surface is rarely more than a few score feet below the surface of the land.

Where the surface is uneven, the ground-water surface usually undulates with it, but to a less extent, as shown in Fig. 79.

**Amount of ground-water.** The amount of ground-water is not very definitely known, but the best estimates which have been made indicate that the water in the soil, rocks, etc., of the land would probably make a layer not more than 1000 feet deep,<sup>1</sup> if it were spread out over the surface of the land. The amount of water in the rocks beneath the ocean bed is probably less per square mile than beneath the land surface, because the rocks there are probably less porous. Even if the amount of ground-water beneath the sea were as great as that in the land, square mile for square mile, the total amount of ground-water would be but a fraction of that in the sea.

**The movement of ground-water.** Ground-water is in constant movement. This is shown in many ways. If all the water is pumped out of a well, it soon fills again to its former level. This shows that water flows in. The constant flow of the thousands of springs shows that ground-water is in movement, for only thus can the springs be supplied with water. The seepage of water into mines, quarries, etc., tells the same story.

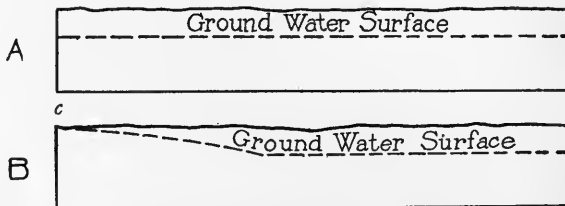

FIG. 80.—In the upper part of the figure (A) the water surface is level. If a heavy rain takes place in the area at the left of that represented by the figure the water surface at the left will be raised as indicated by the lower part (B) of the figure. Movement of the ground-water will follow.

The reasons why ground-water is in movement are readily understood. The rainfall is not equally distributed. If there be a heavy local shower in a flat region, where the water surface is level or nearly so, the soil and rock in the area where the rain falls are more or less completely filled with water. The result is

<sup>1</sup> Estimates have ranged from 3000 feet to 100 feet.

that the water surface for the region is temporarily raised, as shown at *c* in Fig. 80. Since water is mobile, this is a condition of instability, and the water from *c* will tend to flow off in all directions to places where the water surface is lower. The principle involved is precisely the same as that which would be in operation if a mound of water were placed on a level surface. It would promptly spread. In the subsoil, or rock beneath, the water tends to spread just as it would at the surface, but its movement is much slower because of the friction of the water with the rock, etc., through which it passes.

In a region of uniform rainfall, but of uneven surface, the water surface is not level. Other things being equal, it is somewhat higher beneath high land, and somewhat lower beneath low land (Fig. 79). Where this is the case the water surface would ultimately become level if there were no rain; but in moist regions rain is so frequent that the water surface under the hills rarely or never sinks down to the level of the water surface under the surrounding low land, before it is raised again by additional rains. As a result of inequalities of rainfall and of topography, ground-water is constantly moving out from areas where the water surface is higher to areas where it is lower.

While the flow of ground-water is determined primarily by the ground-water surface, and while it always tends to flow from higher to lower levels, it is, in some situations, forced upward. Thus, if water moving down through a porous layer of rock (*a*, Fig. 77) between beds (*b* and *c*) which do not allow it to penetrate them, finds an opening through the impervious layer (*b*), it may escape upward. It may even issue with great force, if the source of supply be much higher than the point of issue. Water also rises by capillary action, but not in such quantity as to give rise to springs or visible seepage.

In addition to the water which comes out from beneath the surface through wells and springs on the land, some of it flows underground to the sea or to lakes, and issues as springs beneath them. Some ground-water, too, seeps out in such small quantities as not to appear to flow. In this case it does not constitute a spring.

Ground-water moves about to some extent under the influence of forces other than gravity. Besides the movements resulting from capillarity, some of it is taken up by the roots of plants, and, passing up through the plants, escapes through their leaves

into the air. Still another portion of the water beneath the surface is evaporated directly, without the intervention of plants. Even in regions where the soil appears to be very dry evaporation is constantly going on. If, for example, the water surface is 500 feet down, the pores of the rock down to the water surface are full of air. From the water surface below, water evaporates into the air in the rock and soil, and this air may thus become more moist than the air above. Moisture is thus *diffused* upward, and, under some circumstances, it may rise by convection.

The rise of invisible moisture from the ground may be easily demonstrated in a very simple way. If a rubber blanket be spread on the ground on a summer night, or if a pan be inverted on the soil, the under side of the blanket or pan will often be dripping-wet in the morning, before the heat of the sun affects it. Had the cool blanket or the cool metal not been there to stop it, the moisture from below would have escaped into the air above, unnoticed. It is so escaping all day and all night, and every day and every night, over all land surfaces wherever the air in the soil and below it is more moist than that above. In this and other ways the supply of ground-water is being constantly drawn upon. Constant renewal through the descent of rain, or through underground flowage from some other region, is therefore necessary to maintain the supply.

It is probable that nearly all of the water which sinks beneath the surface sooner or later comes up again in some one of these various ways; but a small amount of it enters into combination with the solid mineral matter, as in iron-rust (p. 71). So long as water remains in this solid combination, it does not again escape to the surface.

The rate at which ground-water moves varies greatly, and is dependent chiefly on (1) the porosity of the rock or soil, and (2) the pressure of the water. The rate at which water seeps through soils from irrigating ditches has been determined at various points in the West. Except in very porous soils, it ranges from one to eight feet per day. In very porous soils it is sometimes as much as fifty feet per day. In the Potsdam sandstone, a wide-spread formation underlying southern Wisconsin and its surroundings to the south, and the source of many artesian wells, the rate of movement of ground-water has been estimated at half a mile a year. Rain-water which enters this formation 100 miles from Chicago

would therefore reach that city in about 200 years, if this rate is correct. The water which sinks to great depths and into the very small pores and cracks moves with extraordinary slowness, and some of it remains entrapped within the rock for very long periods of time.

### *Springs*

All water issuing from beneath the surface is *seepage*. Water issuing through a natural opening in such quantity as to make a distinct current is a *spring*. Springs occur in many sorts of situations, but they are not located by accident. They occur where there are natural passageways for the ground-water to escape to the surface. Such passageways arise in various ways. Two

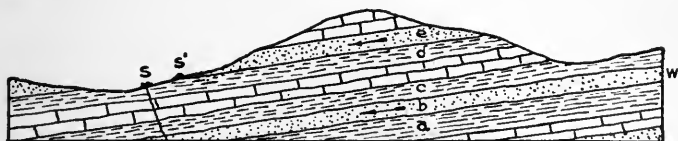

FIG. 81.—Diagram to illustrate two types of springs as explained in text.

cases are illustrated by Fig. 81. In one, the water descends through the porous bed *e* to the layer *d*, which is relatively impervious. The water flows along this layer until the layer comes to the surface (outcrops) and there the water flows out as a spring, *s'*. In the other, the water moves underground through the porous layer *b*, under pressure, until it reaches a crack which leads up to the surface. If the crack is open enough to afford a passageway, the water may follow it up to the surface, as at *s*. A spring may occur in such a situation only when the opening is lower than the water surface in the rock which furnishes the water. In the figure, the spring at *s* is lower than the water surface at *w*. This sort of a spring is similar to a flowing well in principle, but in the latter case the opening is made by man.

**Temperature.** The temperature of water as it issues from beneath the surface is very variable. Most springs seem cold in warm weather. There is indeed a popular impression that springs are cooler in summer than in winter, but this is not the case. The impression arises from the fact that the water is much cooler than the air in summer, and so seems cold, while in winter the water is much warmer than the air, and so seems less cold than in summer.

Springs which derive their water from deep sources vary little in temperature during the year, while those whose sources are shallow are colder in the winter than in summer. The reason is that the warmth of summer and the cold of winter are most extreme at the surface, and become less and less with increasing depth. Below the depth of 50 or 60 feet, in middle latitudes, the temperature does not vary sensibly with the seasons, so that springs which draw their water from greater depths vary little in temperature, while those which draw their supply from lesser depths vary more.

Exceptional springs are warm, and still more exceptional ones are hot. Where spring water is hot it is commonly because it has been in contact with hot rock. In general the water of warm and hot springs probably rises from considerable depths. In many cases the source of the heat is probably igneous rock (lava) which has not yet become cold. It may be lava which was forced upward toward but not to the surface, or it may be the deeper parts of lava which flowed out on the surface.

**Mineral and medicinal springs.** All ground-water dissolves more or less mineral matter from the rocks, and all springs therefore contain more or less mineral matter in solution; but a spring is not commonly called a *mineral spring* unless it contains (1) much mineral matter, or (2) mineral matter which is conspicuous either by reason of its color or its odor, or (3) mineral matter which is unusual in spring water.

Many mineral springs are thought—and sometimes justly—to have healing properties, and so are known as *medicinal springs*. Many of the famous watering-places and resorts for invalids are located at hot mineral springs. The Hot Springs of Arkansas, of South Dakota, and of Carlsbad (Bohemia) are examples. Many springs which are charged with gases are called mineral and medicinal, especially if they have an offensive odor. In the popular mind, a spring is more medicinal the worse it smells and tastes. Hot water is a better solvent than cold water, so that hot springs generally contain much mineral matter.

**Geysers.** In some parts of the world the water of hot springs is forced out violently from time to time. Such springs are called *geysers*. A geyser is therefore an *intermittently eruptive hot spring*. Geysers are best known in the Yellowstone National Park, but they are well developed also in Iceland. They exist in New Zealand, though some of the geysers of that island were destroyed

by volcanic eruptions in 1886. In the Yellowstone Park there are about 100 geysers, and more than 3000 hot springs which are not eruptive. Some of the geysers send up boiling water and steam to a height of 200 feet or more (Fig. 82), but this is quite above the average.

From some geysers the eruptions are frequent, and from others infrequent. From some they occur at regular intervals, and from others they take place irregularly. One of the geysers in the



FIG. 82.—Giant Geyser, Yellowstone National Park. (Wineman.)

Yellowstone Park is named "Old Faithful," because it discharges its waters at nearly regular intervals of about an hour. The eruptions are, however, a little less frequent and a little less regular than formerly. In general, geysers which have been known for long periods of time discharge their waters less and less frequently as time goes on.

The features which may be seen generally at a geyser are the following:

(1) An opening in the surface leading down to unknown depths. Though this is sometimes called the *geyser tube*, it is probably not

always in the form of a tube. (2) A shallow basin about the opening. This is sometimes, though not always, in the top of a mound. In some cases there is, instead of a basin, an irregular



FIG. 83.—Cone (crater) of Castle Geyser, Yellowstone National Park. (Detroit Photo. Co.)



FIG. 83a.—The cone of Lone Star Geyser, Yellowstone National Park. (U. S. Geol. Surv.)

perforated mound (Figs. 83 and 83a). Both basins and mounds are composed of mineral matter (commonly silica) which has been deposited by the water which has issued from the geyser. (3) At the time of discharge much steam, as well as liquid water, issues.



It seems certain that steam is the force which ejects the water. It is believed (1) that ground-water enters the geyser tube much as it enters a well; (2) that the walls of some part of the tube are of hot rock; (3) that the water in the tube is brought to the boiling temperature at some point in the tube below the top of the water; and (4) that when this takes place, the steam formed forces out all the water above. It forces it out because water, when changed to steam, expands about 1700 times.

This principle may be illustrated by experiment. If a short tube of water is heated, it boils without violent discharge, especially if the tube has a large diameter. But if the tube is filled with sand and the sand then filled with water and heated from below, the movement (convection) of the heated water in the tube is greatly restricted by the sand. The result is that steam may be formed abundantly below the surface, and a miniature eruption may follow.

Geysers occur only in regions of relatively recent volcanic activity, and the heat which is necessary for the geysers is probably supplied by lava which has not yet become cool. As it is heated, the geyser water is constantly cooling the hot rock, and in time it will cease to be hot enough to boil the water. Geyser action will then cease, unless new supplies of hot lava are forced up from below. In the Yellowstone Park some geysers have died out since the region became known, but little more than thirty years ago. New geysers, on the other hand, have been developed in the same region during this period.

The reason why the water in a geyser tube is shot out at intervals, while the water in an open kettle is not, is found in the difference in the shape of the vessels holding the water. When water is heated it expands. When water is heated in a kettle, that at the bottom rises readily, *by convection*, to the top, so that there is a nearly uniform temperature throughout. The geyser tube is much deeper than the kettle, and in places it is probable that it is small in diameter, certainly small in proportion to its length. The tube is also more or less crooked. Both its smallness and its crookedness interfere with the rise of the water heated below, and the result is that water below the surface is brought to the boiling temperature before that at the surface is. Hence steam is formed below the surface, rather than at the surface, and blows out the water above.

If a stone or a clod of earth, or almost any other solid object, be thrown into a geyser, its eruption may often be hastened a little, because such things interfere with the convection of the water in the tube. They help to hold the hot water down where it is being heated, and so help it to reach a boiling temperature at some point below the surface a little sooner than it would do otherwise. Soap, especially, is supposed to hasten a geyser's eruption. Its effect is probably somewhat less than is usually believed. Anything which makes the water more viscous hastens the eruption, because convection is less free in a thick fluid than in a thin one.

**Artesian and flowing wells.** When the water in a well rises so as to overflow, the well is said to *flow*. Flowing wells are not



FIG. 84.—Artesian well at Woonsocket, S. D. (U. S. Geol. Surv.)

unlike springs whose waters spout up as they issue. The chief difference between them is that the opening in one case is natural, while in the other it was made by man. Formerly *artesian wells* were regarded as the same as flowing wells. The name was derived from Artois, France, where there was a notable well of this sort. Nowadays the name artesian is often applied to deep wells, whether they flow or not.

Fig. 85 illustrates the general conditions necessary for flowing wells. They are the following: (1) A porous layer or bed of rock, *a*, which underlies an impervious layer, *b*, which prevents the water from escaping upward until it is penetrated by the well-hole. (2) The porous bed must come to the surface in a region which is somewhat higher than the site of the well. (3) The rainfall where

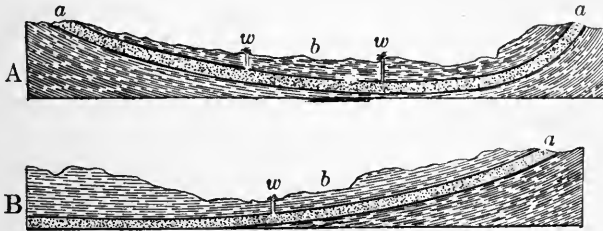

FIG. 85.—Diagrams illustrating the conditions favorable for artesian wells. In A the porous bed *a* is in the form of a basin; in B it merely dips.

the porous bed comes to the surface must be sufficient to keep it well filled with water. Under these conditions the water beneath *w*, in the stratum *a*, is under the pressure of the water in the same stratum at higher levels, and if a hole is made down to it, it will gush up (Fig. 84). It is not necessary, as a rule, to take much account of the layer below the water-bearing stratum *a*. If it is of porous rock, it is generally full of water, and so prevents the downward escape of that in *a*.

The water at the well will not rise as high as the water surface in *a*, for in flowing through the small openings (pores and small cracks) in the rock, there is loss of force by friction. An allowance of about a foot to the mile must usually be made; that is, if the source of supply is 100 miles away, the water surface at that point should be about 100 feet higher than the top of the well, in order that the water may flow out. If the water-bearing stratum, *a*, is very porous, the allowance which must be made for friction is less; if it is close-grained, the loss of force from friction is more.

Artesian wells vary much in depth. They may be but a few feet deep, or they may be thousands of feet. There is an artesian well in Berlin more than 4000 feet deep, one in St. Louis nearly 4000 feet deep, and one in Cincinnati nearly 2500 feet deep, while the deepest one in Chicago is some 2700 feet deep. There are numerous artesian wells in New Jersey less than 100 feet in depth.

The amount of water flowing from artesian wells is often great. At Belle Plain, Ia., the water rose 77 feet above the surface when a certain well was first drilled. A little later the water rose from another adjacent well with such force as to greatly enlarge the opening through which it rose, and with force enough to bring up stones two to three pounds in weight. At first the flow from the second well was estimated to be more than 5,000,000 gallons per day, though it soon became less. The flow from many wells is nearly constant.

Many villages and small cities get their water from artesian wells. Charleston, S. C., Galveston and Fort Worth, Texas, Camden, N. J., and Rockford, Ill., are among the cities supplied partly or wholly in this way. No great city, however, such as New York, Chicago, Philadelphia, etc., is supplied with water from such wells, and probably could not be.

In the semi-arid region of the Great Plains, and at various other places in the West, as, for example, in some parts of California, water from artesian (deep) wells is extensively used for irrigating the land.

#### THE WORK OF GROUND-WATER

##### *Chemical Work*

**Solution.** While rock seems to be the symbol of all that is stable, it is nevertheless dissolved, to some slight extent, by the ground-water which passes through it, as has been stated in connection with springs. Pure water does not dissolve mineral matter readily; but the water beneath the surface is not pure. In falling through the atmosphere it dissolved carbonic acid gas, oxygen, and other gases, and in sinking through the soil it took up the products of plant decay, so that when it became ground-water it contained numerous impurities. With these impurities in solution, ground-water dissolves most sorts of rock more readily than pure water would. Pure water, for example, has little effect on common limestone, but water with carbonic acid gas in solution dissolves this rock to some appreciable extent. The descending water often changes the rocks and minerals through which it passes, chemically, before it effects much solution; but this is not always the case. Since solution is often the result of these chemical changes, it is included under the chemical, rather than under the mechanical, changes produced by ground-water.

That water does dissolve some of the material of rock is shown by the character of the water which comes out of the ground. When the water of wells or springs is evaporated it usually leaves a little residue. This becomes noticeable in time in the inside coating of boilers and kettles in which water is heated. This coating is composed of mineral matter which was in solution in the water, and which was left behind when the water was heated and evaporated. Strictly speaking, all springs are mineral springs (see p. 90), and all wells are mineral wells, for all water taken out of the ground contains mineral matter.

The first work of ground-water, then, is solution, or the subtraction of material from the rocks. One result of solution is to

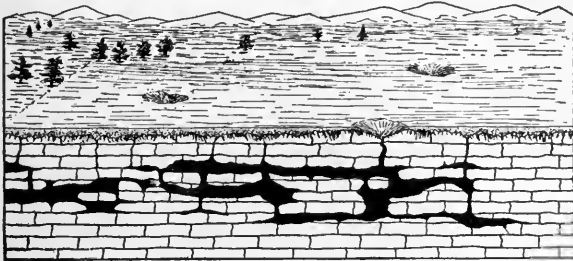

Fig. 86.—Diagram to illustrate the form and relations of caverns developed by solution. The black spaces represent caverns. Some limestone sinks are represented at the surface where the roofs of caves have fallen in.

make the rock porous. The extreme case of porosity developed in this way is found in caverns and channels beneath the surface. The great caves (Fig. 86), like those of southern Indiana (Wyandotte Cave and others) and Kentucky (Mammoth Cave and others), are the work of ground-water. Caves of this sort occur chiefly in limestone regions, for limestone is the most soluble of the common rocks. Even where caves and caverns are not developed, small pores and cavities are often numerous. The effect of solution is, therefore, to weaken the rock, and finally to cause it to crumble.

The roofs of underground caves sometimes fall in, leaving notable sinks at the surface. These are known as *limestone sinks* (Fig. 87). Such sinks are characteristic of regions in which there are caves. They are occasionally so numerous that the surface is too much pitted to be cultivated. This is the case, for example,

in some parts of Kentucky and Tennessee (Plate VI). If a part of the former cavern roof remains to span the depression, a *natural bridge* is formed.

In Karst, along the east side of the Adriatic Sea, there is a tract of land underlain by white limestone which is nearly free from soil. Its surface is etched and eroded into fantastic forms. Most of the rainfall of the region goes beneath the surface, and it is the solvent action of the water before and after it sinks which



FIG. 87.—A sink-hole of recent development near Meade, Kan.  
(Johnson, U. S. Geol. Surv.)

has developed the remarkably uneven topography of the region, so bizarre that it has attracted wide attention. Numerous short gullies, ravines, and valleys in the limestone terminate abruptly, discharging their waters into caves or subterranean tunnels. Sink-holes abound, and some of them are several hundred feet deep. The slopes to the depressions, and therefore the slopes of the elevations between them, are very steep, so that the surface is extremely rough. Topography similar to that of this region and developed in the same way is sometimes known as Karst topography.

The amount of mineral matter brought to the surface through wells, springs, etc., is very great. The springs of Leuk (Switzerland) bring to the surface more than 2000 tons of gypsum

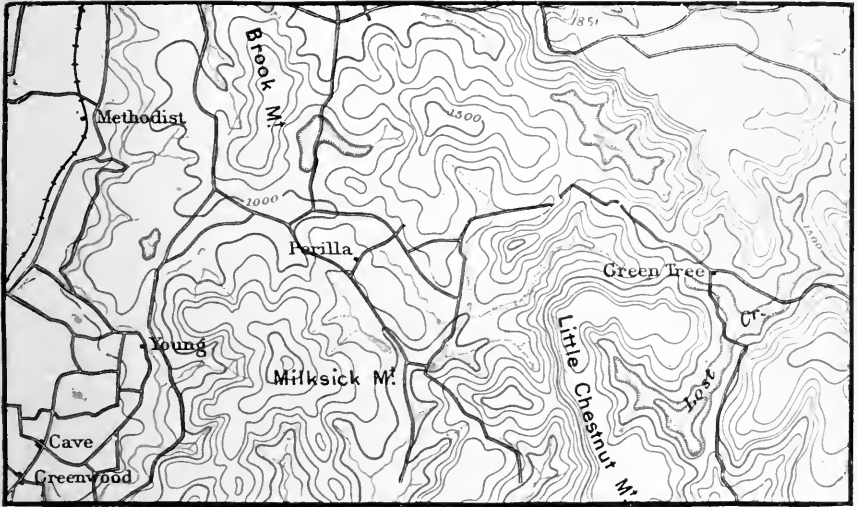

Limestone sinks due to solution by ground-water. The depression contours are hachured. Scale 2— miles per inch. (Pikeville, Tenn., Sheet, U. S. Geol. Surv.)





(a hydrated sulphate of calcium) in solution yearly. In the same time the springs of Bath (England) bring up enough mineral matter in solution so that, if it were taken out of the water and made into a monument, it would make a column 9 feet in diameter and 140 feet high.

Much of the water seeping out from beneath the surface finds its way to rivers, and the larger part of the mineral matter in solution in rivers has come from the ground-water, or seepage, which has joined them. Rivers are estimated to carry nearly five billion tons of mineral matter to the sea in solution each year; but even this large amount does not represent all the solvent work of ground-water, for much of the mineral matter which it dissolves is deposited without reaching either rivers or sea, for reasons which will soon appear.

The transfer of this large amount of mineral matter from the land to the sea each year in solution must mean the lowering of the land. It has been estimated that the land surface is lowered in this way about one foot in 13,000 years, on the average. The transfer of this mineral matter from the land to the sea does not mean an equivalent building up of the sea bottom, for some of the mineral matter remains in solution in the sea-water. Thus salt is one of the mineral substances carried by rivers to the sea; but the larger part of the salt which has been carried to the sea through the ages probably remains there in solution to this day.

On the other hand, much of the mineral matter which is carried to the sea, especially the calcium carbonate, is used by the animals and plants of the sea in the making of shells, tests, bones, etc., and these are finally left on the sea bottom.

**Deposition.** Besides dissolving mineral matter and carrying much of it away, ground-water brings about other changes in the rocks of the earth. If, in the chemical laboratory, solutions of various sorts are mixed in a test-tube, some of the materials in solution are likely to be precipitated. The same thing takes place in the rocks beneath the surface. If, for example, waters from different directions enter a crack in the rock, and if these waters bring different mineral matters in solution, the mingling of the waters may effect a chemical change by which some of the material comes out of solution, and is deposited in the crack.

It follows that while ground-water tends to make rocks porous when it dissolves mineral matter, it tends to make them compact

where it deposits the mineral matter which it holds in solution in pores and cracks. In some places the first of these processes is the more effective, and in others the second. In general, ground-water probably increases the porosity of rock near the surface (especially above the ground-water surface) and increases its compactness at greater depths. The effect of deposition is sometimes to cement the loose parts of rock together, making the whole



FIG. 88.—The Maryland Vein, Nevada City, Cal. The vein is gold-bearing quartz. (U. S. Geol. Surv.)

more firm. Thus sand may be cemented into sandstone, and gravel into conglomerate.

Cracks in the rock filled by mineral matter deposited from solution become *veins* (Fig. 88), and many rocks are full of veins (Fig. 89). Ores occur in some veins, and many mines are located in them. Much of the gold, silver, lead, zinc, etc., is found in such positions. The ores of these metals do not usually *fill* the cracks, but they are often associated with a much larger amount of mineral matter which is not valuable, but which must be worked over in order to get out the ores which are. Mineral matter in solution may be deposited in caves (Fig. 90). Many of the most attractive features of caves, such as stalactites, stalagmites, crystals on the walls, etc., were formed by deposition from solution.

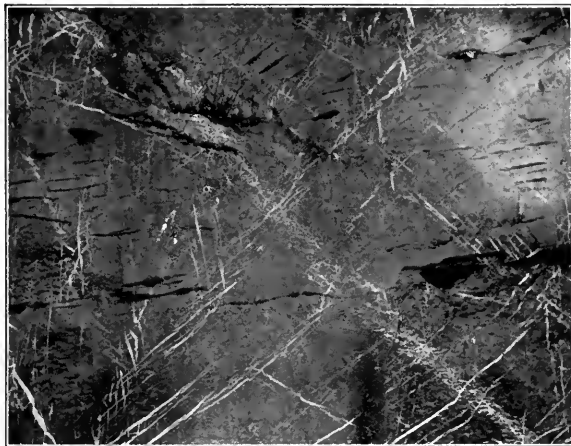

FIG. 89.—A piece of rock showing many veins.—the white streaks. The vein filling is calcite. Near Highgate Springs, Vt. (Walcott, U. S. Geol. Surv.)

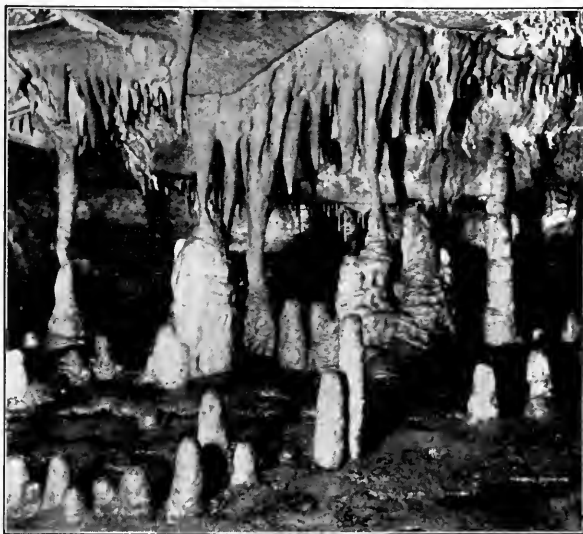

FIG. 90.—Deposits of calcite (travertine, stalactites, and stalagmites) in Wyandotte Cave, Ind. (Hains.)

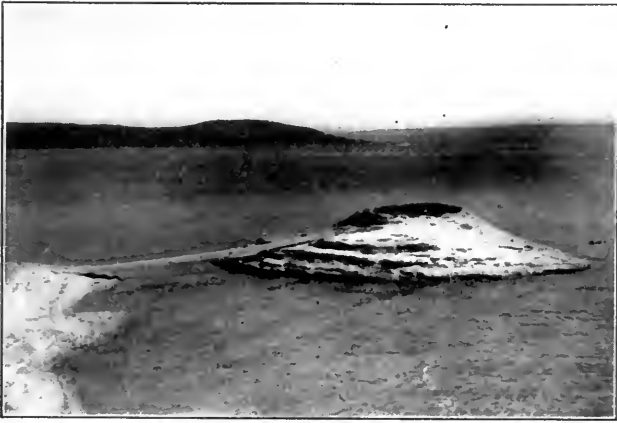

FIG 91.—Deposit from a hot spring in Yellowstone Lake. (Fairbanks.)



FIG. 92.—Hot Springs deposit; terrace about Mammoth Springs. Yellowstone National Park.

The deposition of mineral matter from solution is determined by several conditions. The more important are the following: (1) If water evaporates, the mineral matter dissolved in it is left behind. Surface gravels are sometimes cemented in this way. (2) If the water which contains mineral matter is relieved of pressure, as when it comes out to the surface, some of the mineral matter may be deposited. (3) If water contains much gas in solution, and if the gas escapes, as it is likely to when pressure is re-

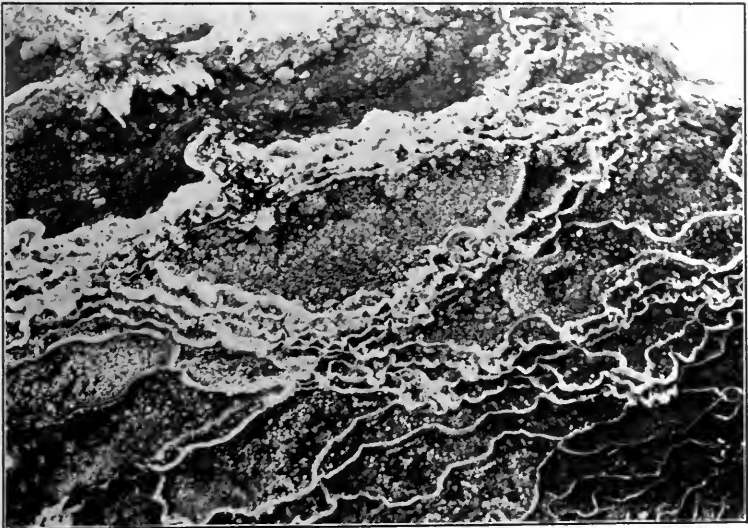

FIG. 93.—Deposits about a hot spring; summit of Angel Terrace. Yellowstone National Park. (U. S. Geol. Surv.)

lieved or when it is warmed, some of the mineral matter in solution is likely to be deposited. (4) Some warm spring water gives up its mineral matter on cooling. Some or all of these principles are involved in the deposition of mineral matter about most hot mineral springs (Fig. 91). (5) The mingling of solutions of different sorts, already referred to, is probably a common cause of deposition. (6) In some hot springs, as in the Yellowstone Park, minute plants grow in the hot waters which issue from the springs. These tiny organisms, by some process not well understood, extract mineral matter from the water and cause it to be deposited (Figs. 92 and 93).

These are among the simpler and more important conditions under which mineral matter is deposited from solution by groundwater, either while it is beneath the surface or after it issues.

Solution and deposition may be going on at the same time, and perhaps at the same place; that is, the water may be dissolving certain substances at the same time that it is depositing others. One sort of rock may thus be changed to another. A special phase



FIG. 94.—Petrified tree-trunks, Yellowstone National Park.  
(U S. Geol. Surv.)

of this process results in *petrifaction*. Thus the substance of a buried shell, or of coral, may be changed while its form is preserved. Another illustration is afforded by petrified wood (Fig. 94), the substance of the wood having been replaced by mineral matter. Such changes probably take place slowly, the mineral matter which was in solution replacing the woody matter as it decays, molecule by molecule.

**Other changes.** Besides the subtraction of mineral matter from the rocks by solution, and the addition of material to the rocks of some places by deposition of mineral matter dissolved elsewhere, the water works still other changes in the rocks. It sometimes enters into combination with certain minerals, changing their character. This process (*hydration*) has already been referred to in connection with the work of the air (see p. 72). The moisture beneath the surface affects minerals in much the same way as moisture in the air or at the surface. All changes of this sort which result in the alteration of the composition of the rock, or of its constituent minerals, are chemical changes.

The general result of chemical changes effected by ground-water, like the result of the chemical changes effected by the air, is to disrupt the rock. Changes of this sort are probably most important near the surface, especially at and above the ground-water surface.

**Summary.** From the preceding paragraphs it will be seen that ground-water effects various changes in the rocks. The rocks carrying water may, indeed, be looked upon as a sort of huge chemical laboratory in which solutions are made and carried from one place to another, working changes as they go. The result is a slow but constant alteration in the character of the rock. Impressed by the greatness of these changes in the long course of time, an eminent geologist has said that, "given time enough, and nothing in the world is more changeable than the rocks."

#### *Mechanical Work*

**Abrasion.** The mechanical work of ground-water is of relatively little importance. The water is rarely concentrated into considerable streams, but where it is so concentrated the underground streams tend to enlarge their channels by erosion, somewhat as surface streams do. The ground-water which flows in distinct channels transports and deposits the limited amount of sediment which it acquires.

**Slumping, sliding, etc.** Indirectly, ground-water participates in changes of another sort. When the soil and earthy material on a steep slope become charged with water, their weight is greatly increased. At the same time the water makes them more mobile. Under these circumstances the material sometimes slides down slopes. Such movements are known as *slumping* or *sliding*. If

the movement is on a large scale, it is called a *landslide*. Slumping is very common on slopes composed of unconsolidated material, such as clay or accumulations of loose rock (Figs. 95 and 96). Landslides give rise to a distinctive sort of topography.

Many destructive landslides have been recorded, but a few facts concerning a recent one may serve to illustrate the phenomena of all. On the 29th of April, 1903, there was a slide on Turtle Mountain, Province of Alberta, Dominion of Canada. Here a huge mass of material, nearly half a mile square and probably



FIG. 95.—South face of Landslip Mountain, Colo. The protruding mass on the right has slumped down. (U. S. Geol. Surv.)

400 to 500 feet deep, suddenly broke loose from the steep east face of the mountain, and slid down into the valley below. It covered the valley, which was half a mile wide, and even rose a few hundred feet on the other side. When it came to rest it covered an area of a little more than one square mile. The length of the slide was about two and a half miles, and it is estimated that the time which it took was not more than 100 seconds. The heavy rainfall of the preceding year had filled the rock with moisture, and earthquake tremors, shortly before the slide, are believed to have also hastened the catastrophe. Extensive tunnels, etc., ex-





FIG. 96.—A slope affected by slumping, creeping, etc., Cascade Mountains, Ore. (U. S. Geol. Surv.)



FIG. 97.—The upper part of a mountain valley. The loose material in the valley has slidden, crept, and rolled down, making what has been called a *talus glacier*. Near Telluride, Colo. (Hole.)

cavated in mining at the base of the mountain may also have played a part by making the under-structure less stable. Many lives were lost and many buildings destroyed.

Instead of sliding down with rapid motion, the surface earth sometimes moves down with extreme slowness. This sort of movement is *creep*. It is often too slow to be seen, but it results



FIG. 98.—Material settling off the face of a cliff under the influence of gravity. The freezing of water in the cracks may be a factor in the separation of the cliff face. (U. S. Geol. Surv.)

in the accumulation of mantle rock, especially earthy matter, at the bases of slopes. In one case (Rhymney Valley, Wales) the rate of creep, where it affected a railway, has been determined to be 6 to 10 feet in fifty years. Movement of the same sort is now constantly disturbing a railway-track a few miles from Golden, Colorado.

The downward movement of loose surface material on slopes is very general. It often causes the trees to incline a little down

slope (Fig. 100). This is probably due in part to the fact that the upper part of the mantle rock in which they are rooted creeps down faster than the lower part.



FIG. 99.—This figure shows the same phenomenon as the last, but the cliff in this case is of solid rock (limestone). The open cracks are largely the result of solution and weathering. East Tensleep Creek, Bighorn Mountains, Wyo. (Hole.)



FIG. 100.—Trees tipping down slope. North of Chicago. (Coxe.)

In all cases of slumping, sliding, and creeping the force producing the movement is gravity. Water only helps to furnish the

conditions for the effective action of gravity, by making the movement easier.

Closely connected with slumping is another phase of gravity work which may be mentioned here, though ground-water has little to do with it. From the faces of cliffs, blocks and masses of rock often settle away (Figs. 98 and 99). The freezing of ground-water in the cracks may help to pry off the rock on the face of the cliff, and solution may help to widen the cracks. The growth of roots in the cracks acts much like freezing water, helping to pry off the loosened masses from the face of the cliff. In such cases the existence of cracks or joints helps ice, roots, solution, etc., to become effective.

#### WEATHERING

Some of the processes of weathering have already been mentioned, but it may be added, by way of summary, that the chemical changes (oxidation, carbonation, etc.) effected in the rock by the atmosphere, the mechanical changes effected by variations of temperature under the influence of the atmosphere, and the chemical and mechanical changes effected by ground-water, all conspire to so alter the surface of exposed rock as to cause it to waste away. We have already seen (p. 74) that the surfaces of the boulders of the fields are sometimes scaling off or crumbling, and they are often discolored, even when they seem firm. The upper layers of stone in a quarry are frequently broken or quite different in color from the lower ones. Inscriptions on old tombstones are often indistinct, and they have sometimes disappeared completely from stones which are but a few score years old. From the walls of stone buildings, from monuments, and from other stone structures, flakes of stone are sometimes seen to be scaling off.

In all these cases some change has taken place in the rock whereby its outer part is wasted away. All processes which produce this result are *weathering*.

The importance of rock weathering is great. Much soil is but weathered rock, and without the weathering of rock much of the land would be bare of soil and so of vegetation. As we have seen, the weathering of the rock greatly facilitates the work of the wind, not always to the advantage of man, by preparing fine material which may be blown away. As we shall see in the next chapter, weathering also prepares material for ready removal by running

water. Weathering, conjointly with wind and water erosion, is responsible for many striking bits of scenery (Figs. 153 and 154).

**Conditions affecting weathering.** There are great differences in the durability of rocks. A coarse-grained rock weathers faster than a fine-grained one of the same composition. Rock traversed by fissures and cracks changes more rapidly than firm, impervious rock. Some rocks, as limestone, are composed of relatively soluble material, and some, as sandstone, of material which is comparatively insoluble. The former weather more readily than the latter, so far as solution is a factor of the weathering. A cold climate favors the wedge-work of ice, but hinders the growth of vegetation and chemical changes. *Rock decay* goes on more rapidly in warm, moist regions than in cold or dry ones; but *rock breaking* or splintering, due to changes of temperature, is more effective in dry regions, where daily changes of temperature are great. In deserts the wear of the rock by wind-blown sand is important. In general, the weathering of *bare* rocks probably takes place more rapidly in warm, moist regions than in cold or temperate ones; yet in warm, moist regions the rock is usually covered and protected against some phases of weathering by a goodly layer of soil and subsoil.

The topographic position of the rocks also has an important bearing on the rate at which they decay. On steep slopes, the waste is commonly washed away as rapidly as formed, and the bare rock is constantly exposed, whereas on plains the solid rock is often deeply buried by mantle rock, and so protected from some phases of weathering.

The thickness of the surface layer of weathered rock varies greatly. It rarely exceeds 100 feet and is generally much less. In many places the depth of soil and mantle rock represents the excess of rock decay over the transportation of the decayed material.

Since over the greater part of the land area there is a covering of mantle rock, it follows that, in the aggregate, rock weathering exceeds transportation. Since much material is carried away in solution or otherwise, as rock weathers, a few feet of rock waste may represent the destruction of many feet of rock.

MAPS ILLUSTRATING TOPOGRAPHIC EFFECTS OF  
GROUND-WATER

Study the following maps showing limestone sinks, "sinking creeks" etc. in preparation for conference.<sup>1</sup>

- |                            |                       |
|----------------------------|-----------------------|
| 1. Greenville, Tenn.—N. C. | 3. Bristol, Va.—Tenn. |
| 2. Standingstone, Tenn.    | 4. Pikeville, Tenn.   |

*Greenville Sheet.*

Note the numerous limestone sinks in the central portion of the area, and the "sinking creeks" associated with them. Sketch the probable history of a "sinking creek."

*Standingstone Sheet.*

Note the many limestone sinks, particularly in the southwestern half of the map. The rocks are here essentially horizontal and the sinks are therefore without definite arrangement. This is in striking contrast to the condition shown on the Bristol sheet.

*Bristol Sheet.*

The many depressions are sink-holes in limestone rocks. Note the very large depressions near Adelpia, in the northwestern part of the map. Notice that the sink-holes occur in belts, extending northeast and southwest. This is because the tilted limestone beds of the region outcrop (come to the surface) along these lines (see Bristol Folio).

*Pikeville Sheet.*

Note the limestone sinks, especially in the northwestern part of the map.

*Question.* What was probably the topography of each region at the time the sinks developed?

REFERENCES

1. CHAMBERLIN AND SALISBURY, *Geologic Processes*, Chapter IV. Henry Holt & Co., 1903; and all standard text-books on Geology.
2. SHALER, Chapter on *Caverns*, in *Aspects of the Earth*: Chas. Scribner's Sons, 1889.
3. GEIKIE, *Earth Sculpture*, Chapter XIII: Putnam.
4. HOVEY, *Celebrated American Caverns*: Rob't Clarke Co.
5. CHAMBERLIN, *Artesian Wells: Geology of Wisconsin*. Vol. I, 1881, pp. 689-697; and 5th Ann. Rept. U. S. Geol. Surv., pp. 131-173.
6. KING, *Principles and Conditions of the Movements of Ground-water*: 19th Ann. Rept. U. S. Geol. Surv., Pt. II, pp. 59-293.
7. SLICHTER, *The Motions of Underground Water*: Water Supply and Irrigation Paper No. 67, U. S. Geol. Surv.

<sup>1</sup> See foot-note, p. 54.

8. Numerous Water Supply and Irrigation Papers, U. S. Geol. Surv.
9. WEED, *Formations of Hot Springs Deposits*: 9th Ann. Rept. U. S. Geol. Surv., pp. 663-676, and Amer. Jour. of Sci., Vol. XXXVII, 1889, pp. 51-59.
10. CHITTENDEN, *Yellowstone National Park*: Rob't Clarke Co.
11. DAVIS (B. M.), *The Vegetation of the Hot Springs of Yellowstone Park*: Science, Vol. VI, 1897, pp. 145-167

## CHAPTER IV

### THE WORK OF RUNNING WATER

STREAMS are among the most wide-spread natural features of the land. Only in desert regions, such as the Sahara, or in areas which, like Greenland, are mainly covered with snow and ice, are there extensive tracts without them. A few streams, like the Mississippi and the Amazon rivers, are very large, but most of them are of small size. Thousands of small creeks and brooks, some of them having their source in the Rocky Mountains, some in the Appalachian Mountains, and some on the plains and plateaus between these mountain systems, feed the Mississippi. And so it is everywhere. Every large stream receives water from many small ones.

The rivers of the Mississippi basin guided the early explorers, traders, and immigrants, and later became of great commercial and therefore of political importance. Many of the greater streams of other lands have played similar rôles in history.

The flow of some streams is so gentle that they do not appear to work great changes in their valleys; but some of them wear away their banks so rapidly that the changes they produce may be seen from year to year, or, when the stream is in flood, from day to day, or even from hour to hour. The force of streams at such times is often disastrous (Figs. 101 and 102). Occasionally they sweep away bridges and dams, and sometimes even buildings. The strong beams and rods of the bridges, and the steel rails of railways are bent almost as if they were twigs by the force of the occasional torrent which follows an exceptional rain, such as a cloud-burst (Fig. 103).

In the aggregate, the streams are estimated to send about 6500 cubic miles of water to the sea each year. The average height of the land above the sea is nearly half a mile. These 6500



cubic miles of water, therefore, descend, on the average, nearly half a mile before they reach the sea. The energy of the water in falling

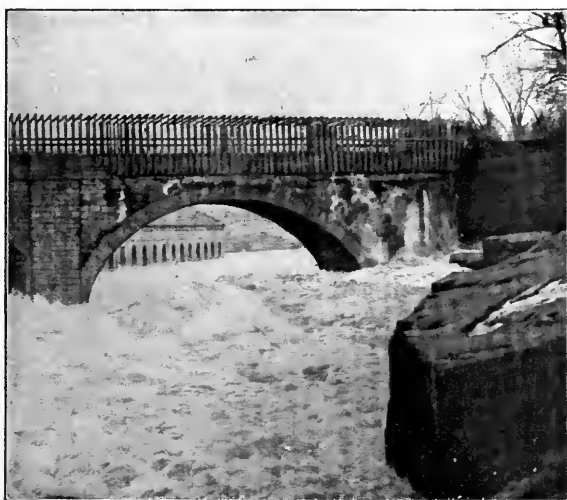

FIG. 101.—The Passaic River in flood. Little Falls, N. J. 1902.



FIG. 102.—A raging river. Flood of the Mississippi River, breaking through its levees.

this distance is very great. This will be readily understood if we think of this amount of water falling vertically from a height of a

little less than half a mile. The water in the streams has the same amount of energy that it would have if it fell vertically. This energy is largely expended in wearing away the materials of the sides and bottoms of the valleys. Its force is therefore great, and its effects on the surface of the land pronounced.

Rivers flow in mountains, in plateaus, and in plains, and wherever they flow they modify the surface in their own peculiar way.



FIG. 103.—Scene in the freight-yards of Kansas City after the flood of 1903. (U. S. Weather Bureau.)

The topographic features produced by running water in mountains, plateaus, and plains have much in common, and when we study these features for one of these types of regions, we really study them, in principle, for all.

**Sources of stream water.** Most streams derive a large part of their water from the immediate run-off and from ground-water, and many of them receive contributions from ponds, lakes, snow-fields, and glaciers. The Mississippi, for example, receives water in all these ways. The immediate run-off, the ground-water, and even the water of the lakes and glaciers, all have their sources in the rain and snow, so that rivers depend on atmospheric precipitation for their supply of water.

The direct connection between rainfall and rivers may be inferred from various familiar phenomena. (1) Streams are more numerous in regions where the rainfall is abundant (Fig. 104) than in those where it is scarce (Fig. 105). (2) Multitudes of small streams spring into being with each heavy fall of rain and with each period of rapidly melting snow. (3) Streams are notably swollen

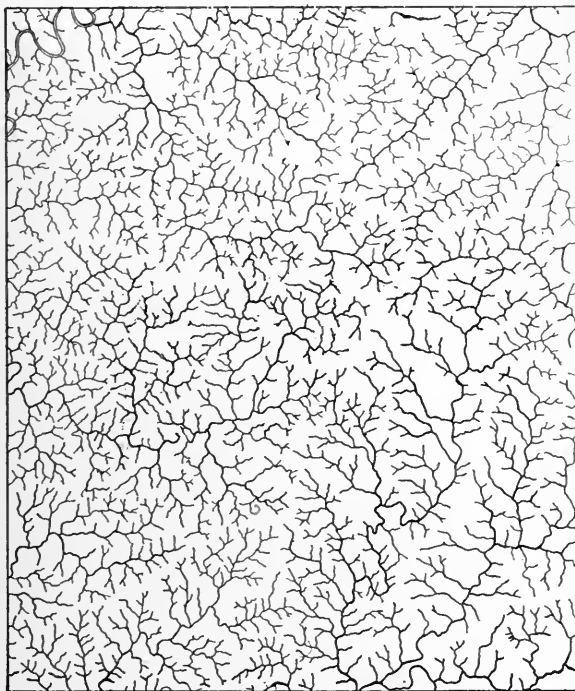

FIG. 104.—Map showing the many streams of a humid region. Central Kentucky. The area is about 225 square miles.

after rains, and most after heavy rains. (4) Many small streams which flow during wet weather dry up in times of drought, while others shrink.

The water of most streams which continue to flow during droughts is derived largely from springs and lakes, or from the melting of snow and ice about the sources of the streams.

Where water flows on the land, it is because the surface has a slope. If the slope of a surface were perfectly even, the immediate

run-off at any given time would flow in a sheet. There are slopes so smooth that their water runs off in this way; but on most slopes, even those which appear to be regular, there are some unevennesses so that, although the run-off may start as a sheet, it is soon concentrated into rills and streamlets which follow the depressions. The smallest streamlets unite to form larger ones,



FIG. 105.—Map showing the few streams of an arid region. Northern Arizona. The area is as great as that shown in Fig. 104.

and the little rills, after many unions with one another, reach valleys which have *permanent streams*. These may be small (creeks or brooks) or large (rivers). Streams which flow but part of the time, as after a rain-storm, during wet weather, or during but a part of the year, are *intermittent streams*.

Every permanent stream and many temporary ones flow in depressions called *valleys* (Fig. 106). Valleys are therefore about as numerous as streams. The very small depressions in which water runs only after smart showers are not always called valleys.

If they are very small they are called *gullies* (Fig. 107); or if somewhat larger, *ravines*. Gullies and ravines are but small valleys. Just as the tiny streamlets unite with one another to form creeks

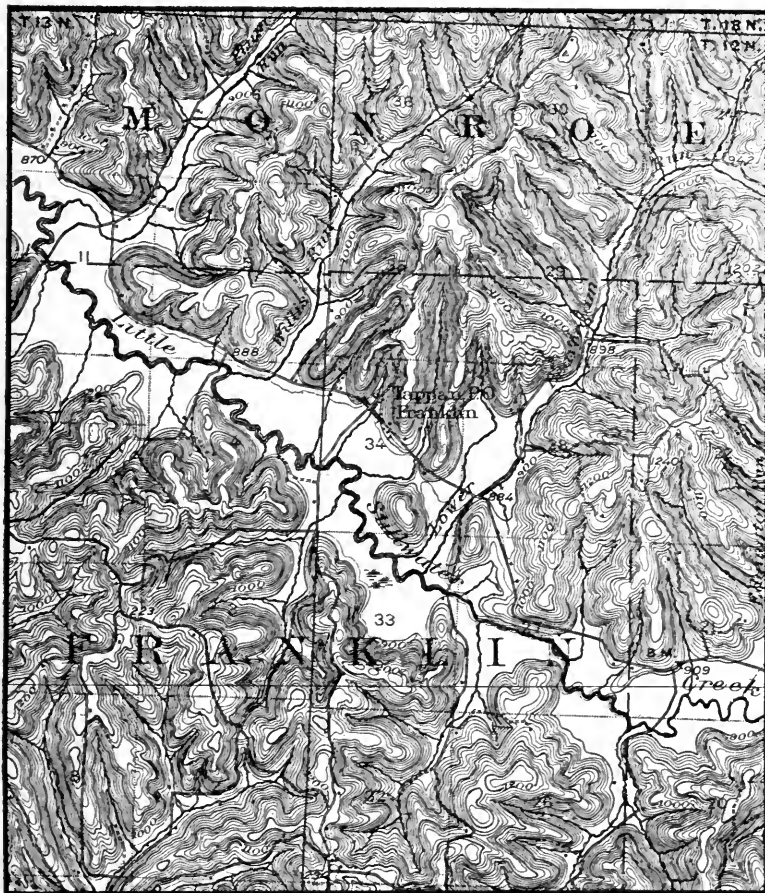

FIG. 106.—Map showing normal drainage relations. Each stream flows in a depression. The largest stream has the largest valley. Streams of smaller size have smaller valleys, while the valleys of the smallest streams are very small. A few miles southwest of Scio, O. (U. S. Geol. Surv.)

and these to form rivers, so the gullies in which the smallest temporary streams flow generally unite to form wider and deeper gullies (Fig. 108). These, in turn, join one another to make ravines,

which are but larger depressions of the same sort. Ravines lead to valleys, just as gullies lead to ravines. Valleys, like streams, usually end at the ocean or a lake; but in some cases, especially in arid regions, they end on dry land.

There is, as a rule, some relation between the size of a valley and the stream which follows it, though this relation is not one



FIG. 107.—A gully developed by a single shower. (Blackwelder.)

which can be stated in mathematical terms. The large stream and the large valley go together so often, however, that the combination cannot be accidental, and leads to the inquiry whether the streams make the valleys in which they flow, or whether the streams flow where they do because the valleys were prepared for them in advance. These are questions to which we shall seek an answer in the following pages.

### THE EROSIVE WORK OF STREAMS

Streams are always carrying mud, sand, etc., down their valleys. This is especially well seen when rivers are in flood, for at such times they are usually muddy. Besides the mud which is suspended in the water, streams roll sand, gravel, etc., along their bottoms. The movement both of the mud in the water and of

pebbles and stones at the bottom of the water may be seen in any little stream that flows along the roadside after a storm, and the great Mississippi carries its load in the same way. Even when streams are not in flood, they carry sediment, though its amount is then less. Some of them carry so little that their waters are relatively clear, while others, like the Missouri, are always muddy.

Since most river-water finally reaches the sea, much of the



FIG. 108.—Slope with numerous gullies, the smaller ones joining the larger ones. Scott's Bluff, Neb. (U. S. Geol. Surv.)

sediment which they carry finally reaches the ocean and is deposited there, chiefly near the shores.

The amount of material which certain streams carry from the land to the sea has been estimated. The estimate for a given river is made by calculating the volume of water discharged by the river each year and then determining the average amount of sediment in each unit—for example, each gallon, or each cubic foot, of water. In this way it has been estimated that the Mississippi River carries to the Gulf more than 340,500,000 tons of sediment each year, or nearly a million tons a day. It would take more than 750 daily trains of 50 cars each, each car carrying

25 tons, to carry an equal amount of sand and mud to the Gulf. All the rivers of the earth are perhaps carrying to the sea forty times as much as the Mississippi.

We have seen that ground-water dissolves rock matter, and that springs bring some of this dissolved matter to the streams. Streams, therefore, carry certain substances such as salt, carbonate of lime, etc., in solution. These dissolved substances are generally invisible, and, unlike mud and other sediment, remain in the water even after it has become quiet. The presence of these dissolved substances is sometimes made known by the taste; but this is rarely the case in river waters. On evaporating the water, however, as by boiling, the dissolved substances are left behind, as on the inside of tea-kettles, boilers, etc.

The amount of matter carried to the sea in solution each year by all the rivers of the earth has been estimated at nearly 5,000,000,000 tons. This is about one-third as much as the sediment carried by the rivers.

These general facts show that the rivers are constantly shifting solid matter from the land to the sea. This is, indeed, their great work. Even the water which falls on the land, but does not flow directly to the sea, helps to make the rock decay (p. 105), and so prepares it for removal by running water. It may therefore be said that *every drop of water which falls on the land has for its mission the getting of the land into the sea.*

**Load and loading.** The sediment moved by a stream, whether in suspension or at the bottom, is its *load*. A stream is *loaded* when it has all the sediment it can carry; it is but partially loaded when it is carrying less than it might.

How does a stream get its load?

As the rain-water begins to flow down the slopes of the land, it picks up and carries with it particles of soil, subsoil, etc.; that is, particles of weathered rock. The result is that the water which runs down slopes after a rain generally carries sediment to the stream which it enters. This is especially true if the immediate run-off flows over cultivated or abandoned fields. The water which flows down freshly plowed slopes, for example, is usually very muddy, while that which runs over slopes well covered with vegetation, such as grass-land or forest, carries away little soil, because the roots of the vegetation hold it. Gullies often develop in plowed fields which lie on slopes, when adjacent fields which are



not cultivated do not suffer in the same way. The loosening of soil on hill and mountain slopes often leads to its complete removal, and in some parts of France, in the southern part of our own country, and elsewhere, slopes which were once productive have become barren by the washing away of the soil.

The amount of sediment carried by the immediate run-off from the slopes is greatest, other things being equal, where the water is concentrated into streamlets, and least where it runs off in sheets. It is under the former condition that little gullies are made (Fig. 107). The gullies are themselves proof that erosion is greater along their courses than on either side, for it was the greater erosion along their courses which made them.



FIG. 109.—A “boiling” or eddying stream. Woods Canyon, Alaska.  
(Spencer, U. S. Geol. Surv.)

Much of the sediment of streams is brought to them by the immediate run-off which flows down the slopes of their valleys. But the stream in the valley carries away not only the sediment which is brought to it by gravity and by wind, by sheet-wash and temporary streamlets from the slopes above, but under favorable conditions it gathers load for itself from its bed and from its banks. This is true, for example, wherever the bed of a vigorous

stream is composed of clay or sand, for particles of these materials are easily loosened and hurried along in the current.

The stream does not pick up sediment from its bed merely by the force of the forward movement of the water. We are not to think of a stream as a single straightforward current. When water runs through an open ditch or gutter, some of it may be seen to move from the sides to the center, and some from the center to the sides, while eddies are of common occurrence. These subordinate motions are especially distinct where the current is swift. A swift river, too, "boils" and eddies (Fig. 109), often in a striking manner. In the swift Columbia, for example, eddies are often so strong that it is difficult to row through them. In an eddying current, objects are often "sucked under" and brought up again. There are similar movements, though often less readily seen, in slower streams.

All these phenomena show that there are numerous subordinate currents in the main current of a river, and that they move in various directions. Many of them are caused by the irregularities

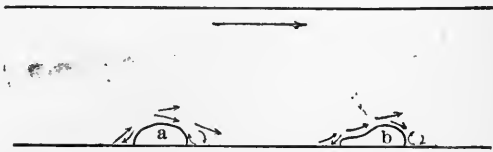

FIG. 110.—Diagram to illustrate the effect of irregularities, *a* and *b*, in a stream's bed, on the current striking them.

of the stream's bed (Fig. 110), from which they diverge in various directions. The subordinate upward currents in the main current often carry sediment up from the bottom of the stream; that is, they bring it into suspension. When these subordinate currents strike the sides or bottom of a stream's channel, they are often effective in tearing or wearing off bits of loose matter. As we shall soon see, these subordinate currents not only help to get fine sediment into suspension, but they help to keep it there.

There are two reasons why a stream which is clear or nearly so at the usual stage of water, becomes muddy when it is swollen. One is that in time of flood there is more immediate run-off entering the stream, and this usually brings abundant sediment: the other is that the stream when flooded flows much more swiftly than

at other times, and so has power to rub off and pick up much more sediment for itself.

It might seem from these statements that swift streams should always be muddy and slow ones always clear, but this is not the case. Many a swift stream, especially in the mountains, is remarkably clear, while some sluggish ones are always muddy. The reason is not far to seek. Even a swift stream is clear (1) if immediate run-off (slope-wash) and tributaries bring it no sediment, and (2) if the materials of its own bed are so coarse that it cannot pick them up. The clearness of many swift mountain streams is due to the fact that there is no mud or sand or fine material of any sort in their beds or banks, while the muddiness of many sluggish streams in plains, such as the Lower Missouri and the Platte, is due to the fact that their bottoms and banks are of such fine material that even their slow currents can get and carry it.



FIG. 111.—Tools with which a river works. These cobbles and small boulders were brought down by the stream in flood, and left where they now appear. Other similar materials now in transit cause the riffles in the current. Chelan River, Wash., just above its junction with the Columbia. (Willis, U. S. Geol. Surv.)

Again, the stream by friction with its bed tends to drag the loose sediment at its bottom along with it, somewhat as a weight of any sort pulled over a surface of mud drags some of the mud beneath along with it. Every stream, therefore, which is not already loaded wears its bed, if it is of soft material such as mud, by (1) friction of the main current, (2) impact of the sub-

ordinate currents, and (3) by urging or dragging along the fine material of its bed.

But some river valleys are in solid rock, even in rock which is very hard (Fig. 26). How are such valleys made?

In the first place, rock exposed to the water, as in a stream's channel, or to the atmosphere, decays. As it decays it crumbles, and the crumbled part is readily swept away. Again, the sand and gravel rolled along by a stream (Fig. 111) wear its bed, even

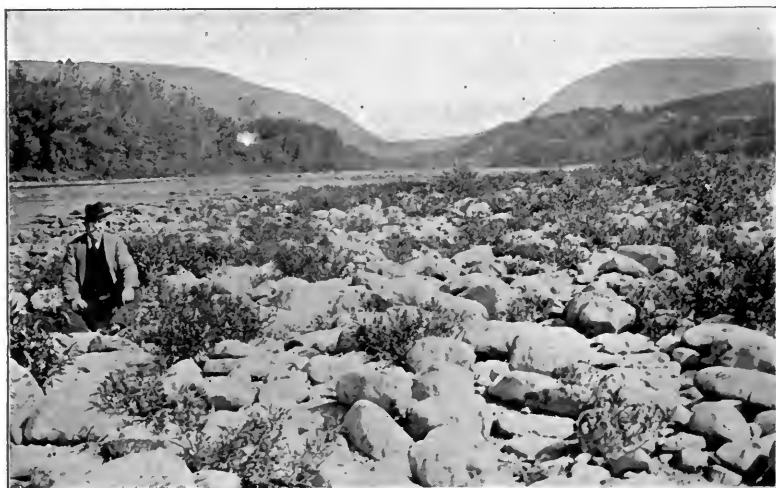

FIG. 111A.—Tools with which a river works. Boulders left by the Delaware River on its flood plain in times of flood, near the Water Gap. (N. J. Geol. Surv.)

if it is of hard rock. Even the fine sediment which a stream carries helps to wear its channel. The sediment which a stream carries, therefore, becomes the tool, or, better, a collection of tools, with which the running water works, and with these tools even hard rock is worn away.

Clear water flowing over a bed of firm, hard rock effects little or no mechanical wear. This is well shown in the case of relatively clear streams like the Niagara. Tiny plants, like those which make moist stone walls green, may often be seen growing on the limestone of its bed where the water is shallow enough to allow the bed to be seen. This is the case even at the brink of the falls, where the current is very swift, and all the force of the

mighty torrent is unable to sweep these tiny plants from their moorings. If the stream had a moderate load of sand or mud there can be no doubt that these plants would be swept away with great despatch. The sediment carried by a stream is therefore a factor which influences its rate of erosion, especially where the bed is of solid rock.



FIG. 112.—A stream channel clogged with boulders too big for the stream to move, except in times of flood.

**Carrying.** It has already been stated that streams move their load (sediment) (1) by rolling it along their bottoms, and (2) by carrying it in suspension above the bottoms. Coarse materials, such as pebbles, are generally rolled, while fine materials, such as particles of mud, are often suspended.

The material rolled on the bottom is moved directly by the force of the water. Each pebble which is moved is pushed or rolled along by the water which strikes against it. The principle is the same as that involved in the movement of pebbles on a beach, except that the stream always carries them down the valley, instead of rolling them back and forth.

Mud is composed chiefly of fine particles of rock, which are nearly three times as heavy as water. In spite of this, they remain in suspension, often for long periods of time. The mud is kept in suspension much as dust is kept in suspension in the air. Since

its particles are heavier than the water, they tend to sink all the time. They do in fact sink; but as they sink under the influence of gravity they may be caught by minor upward currents and carried upward in spite of gravity. *It is chiefly by means of these minor upward currents in the main current that sediment is kept in suspension.* Because of the manner in which fine sediment is carried in suspension, it helps to deepen and widen the valley of the carrying stream. As the minor upward currents of a stream carry sediment upward through the water, so minor downward currents drive it against the bottom, and minor sideward currents against the sides of the channel. In these ways even the fine sediment helps the stream to enlarge its valley.

The particles of sediment suspended in a stream are dropped and picked up again repeatedly. A particle may make a long journey, but the long journey may be made up of many short ones. Particles of mud carried from Dakota to the Gulf of Mexico ordinarily make many stops in every state along the route, and the time consumed in their journey is generally many times as long as that consumed by the water which started them.

**Amount of load.** The amount of sediment a stream carries depends on (1) its velocity, (2) its volume, and (3) the amount and kind of sediment available. A swift, large stream can carry more than a slow, small one.

The effect of velocity on the carrying power of streams may be seen in most creeks and rivers whose width varies notably. At the narrow places, the swift water is likely to carry away all fine material, permitting only coarse pebbles and stones to remain upon the bottom, while in the broader places the bottom may be covered with mud. By artificially narrowing (by jetties) the Mississippi near its debouchure (1875), James B. Eads not only prevented further deposition of sediment there, but forced the river to clear out its channel. This change permitted the larger ocean vessels to reach New Orleans, and insured the commercial prosperity of that city.

That fine sediment is picked up and carried more readily than coarse is illustrated by the familiar fact that a stone a pound in weight thrown into any common stream would sink to the bottom promptly, while if a pound of fine dust were thrown into the same stream, its particles would be carried forward some distance before sinking to the bottom.

A stream can carry a much greater weight of fine sediment than of coarse, both because each pound of fine material carried taxes the stream's energy less than a pound of coarse, and because a larger part of a stream's energy can be used in carrying the former than in carrying the latter.

**Erosion defined.** The wearing away of the land surface is *erosion*. In general, erosion consists of three more or less distinct processes. These are (1) *weathering*, (2) *corrasion*, or the picking up of the rock material loosened by weathering or by any other process, and (3) *transportation*. The solution of rock material by water is often included under corrasion. It would perhaps be well to call it *corrosion* instead. When the running water is no longer able to carry away sediment, it ceases to degrade its bed.

**Deposition a necessary consequence of erosion.** The sediment carried by rivers is deposited whenever they are unable to carry it farther. The cause of deposition is most commonly loss of velocity. Some of the sediment is left in the valleys, especially in their lower courses; and some of it is carried to the sea, or to the lake or other basin to which the river flows. Deposits of sediment in valleys build up or aggrade their bottoms. Thus the Mississippi is spreading sediment over the bottom of its valley for hundreds of miles north of the Gulf of Mexico, and many other large streams, like the Nile, the Hoang-Ho, and the Ganges, are doing the same thing. The total amount of aggradation accomplished by running water on land is, however, far less than the amount of degradation. The deposition of sediment by streams will be more fully considered in its appropriate place.

#### *Changes Made by Rivers in their Valleys*

A valley has three dimensions, depth, width, and length, and each dimension is subject to change.

**The deepening of valleys.** Eroding streams make their valleys deeper and wider. Where streams are depositing, that is, where they leave more than they take away, they are making their valleys shallower. In general, swift streams deepen their valleys, while slow ones often make their valleys shallower. Many valleys are being deepened in their upper courses where the streams are swifter, and made shallow in their lower courses where the streams are more sluggish.

Swift streams are swift because they flow in channels which have relatively steep slopes; but as such streams deepen their valleys, the slopes or *gradients* of the valley bottoms become less, and the streams flow more slowly. *In time every swift stream will cut its channel so low that its current will become sluggish.*

There is no fixed relation between the depth of a valley on the one hand and erosion or deposition in its bottom on the other. Some deep valleys, like the canyon of the Colorado (Fig. 27), are becoming deeper by erosion, while others which are shallow are



FIG. 113.—A shallow valley becoming shallower by deposition. North Platte River near the Nebraska-Wyoming line. (U. S. Geol. Surv.)

becoming shallower by deposition (Fig. 113). Some deep valleys, on the other hand, are being aggraded, and some shallow ones are being degraded.

The depth which a valley may attain depends primarily on the height of the land in which it is cut. The higher the land, the deeper the valley may become. Such valleys as the canyons of the Colorado (Fig. 27) and the Yellowstone (Fig. 152) are never found in plains (compare Figs. 140 and 169). *Valleys of great depth are characteristic of plateaus and mountains.* With land of a given height, the depth which a valley may attain depends on its distance from the sea by the route which the water follows. Thus, if a stream flows by a direct course from a plateau 2000 feet above



the sea and 200 miles from it, it has an average fall of 10 feet per mile; but if it runs off a plateau of equal height 2000 miles from the sea by the course which the water follows, the stream has an average fall of but one foot per mile. If the volume of the stream is the same in the two cases, the valley in the plateau nearer the sea will become much deeper than the other. In other words, the depth which a valley may attain depends primarily on the fall (or gradient) of the water which flows through it. Valleys near the borders of continents are therefore likely to be deeper than those in lands of the same elevation in the interiors of continents.

**Depth-limit.** At its lower end, a stream usually cuts its channel down to, or even a little below, the level of the lake, sea, or other river into which it flows. *The body of water into which a river flows therefore determines the depth-limit of its valley;* but the valley reaches this limit only at its lower end. The upper end of a river valley is always above sea-level.

The lowest level to which a stream can bring its valley bottom by mechanical wear is called *base-level*. It is to be noted, however, that a stream's *channel* may be below sea-level at and near its lower end. Thus the channel of the Mississippi is below sea-level for some distance above the mouth of the stream and locally as much as 100 feet below. The broad valley plain of the Mississippi, on the other hand, is just above sea-level in the same region.

Many conditions affect the rate at which a stream erodes, and everything which affects the rate of erosion affects the length of time which it will take a stream to bring the bottom of its valley to base-level. Other things being equal, a large stream will bring its valley to base-level sooner than a small one, and any stream will bring its channel to base-level in weak rock sooner than in resistant rock.



FIG. 114.—Diagram of a valley, the top of which is ten times the width of the stream.

**The widening of valleys.** If the growth of a valley were due merely to the down-cutting of the stream, the valley would be no

wider than the stream which flows through it (Fig. 114, see also Figs. 27 and 27*a*). Since most valleys are very much wider than their streams, other factors besides down-cutting must be involved in their development.

Most valleys are much wider at their tops than at their bottoms, and all valleys are being made wider all the time. The widening is brought about in many ways. Some of them are the following:

(1) Sometimes a stream flows against one side of its channel with such force as to under-cut the slope above (Pl. VII and

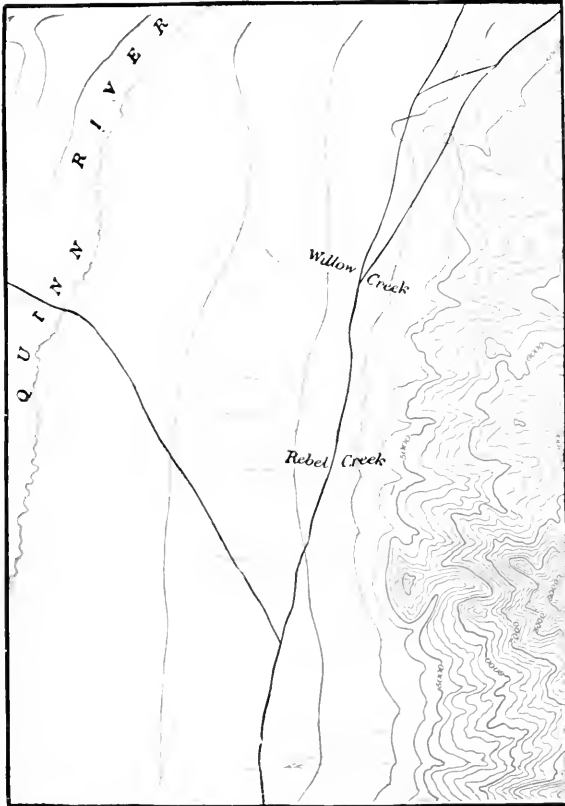

FIG. 115.—River under-cutting its bank and widening its valley by planation where the material is unconsolidated sand, gravel, etc.

Figs. 115 and 116). The material under-cut is likely to fall or slide down, and this makes the valley wider than before. Slow streams widen their valleys more rapidly than swift ones, partly because they are more easily turned against their banks by any sort of obstacle in the channel.

(2) Again, some of the rain falling on the slopes of a valley runs down to the bottom and is likely to carry mud, sand, and coarser materials with it. This also widens the valley by slowly wearing back its slopes.

(3) The loose earthy matter which lies on the slopes of a valley is slowly creeping downward. The movement is brought about in various ways. (a) If the material is clay, it contracts when dry,



Streams disappearing in the sand, gravel, etc., at the base of mountains in an arid region. Scale 4—miles per inch. (Paradise, Nev., Sheet, U. S. Geol. Surv.)

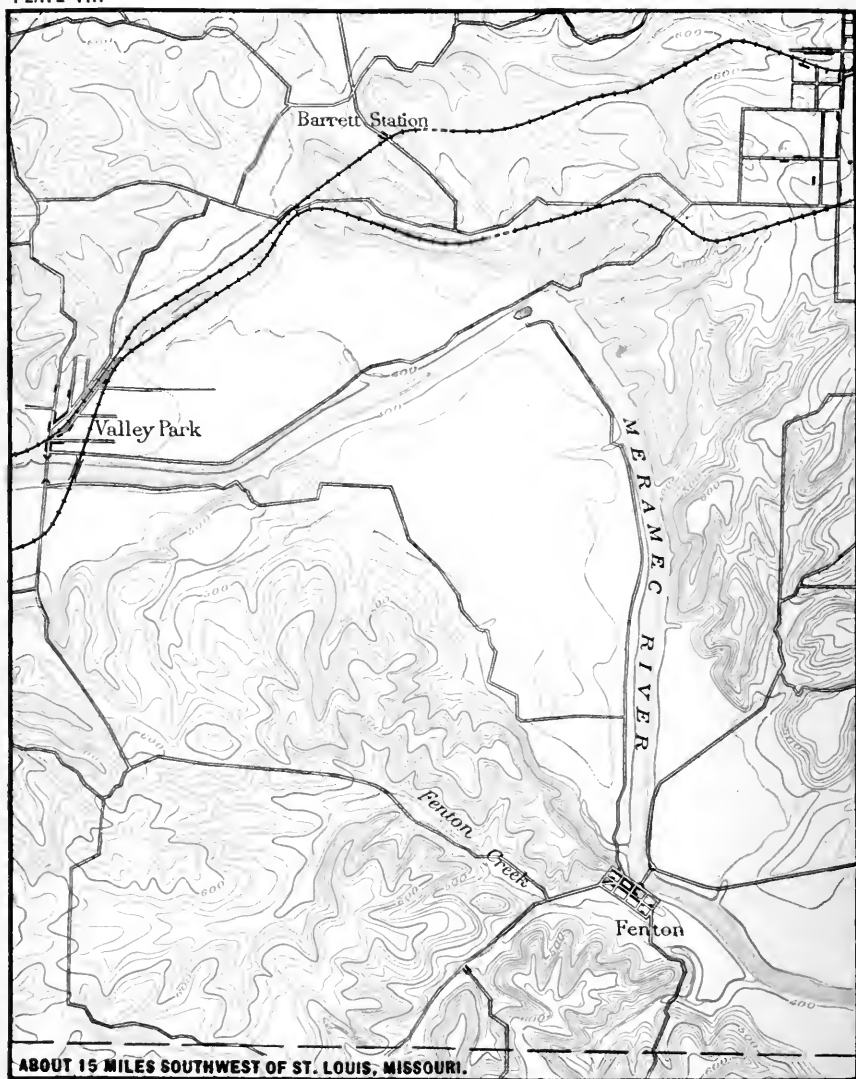

A stream widening its valley by lateral planation. Scale 1— miles per inch.  
(U. S. Geol. Surv.)

and as it contracts, it cracks. The gaping of the crack is due chiefly to the downward movement of the clay on the down-slope side (*A*, Fig. 117). Cracking of the same sort (Fig. 118) may be seen where a pool or pond has dried up, though creep is not involved. When the cracked clay on a slope becomes wet again, as by rain, the clay swells and the cracks are closed; but the swelling takes place in such a way that the cracks are closed chiefly by the moving down of the clay on the upper side of the crack (*C*, Fig. 117), not by the moving up of the clay on the lower side.



FIG. 116.—The Green River, Wyo., cutting against its bank and widening its valley by planation where the material is indurated. (Fairbanks.)

This is because gravity helps to pull the clay down, while upward movement, if it took place, would have to take place against gravity. (*b*) Again, clayey material tends to become a viscous fluid when wet, and in so far as it takes on fluidity, it tends to creep or flow down-slope (p. 108). Friction, the roots of plants, etc., on the other hand, tend to restrain its descent. All downward movement of this sort tends to widen the valley, for much or all the material descending in this way is carried off by the stream when it reaches the bottom of the valley.

(4) When the loose material of the steep valley slope is thoroughly filled with water, as after a long rain or when snow is

melting, it may slide or *slump* from higher to lower levels (Fig. 119). Slumping is common on steep valley slopes composed of unconsolidated material like clay.

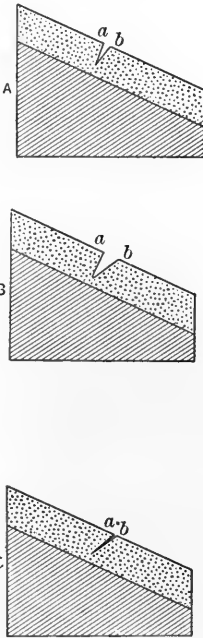

FIG. 117.—Diagram to illustrate the effects of drying and wetting on a clay slope. In A the clay is drying and cracking open. In B the process has gone further, and it is *b* which has moved down, while *a* remains where it was in A. C represents the same after it has been wet again and the crack closed, chiefly by the moving down of *a* rather than the moving up of *b*.

Slumping widens the valley at the point whence it starts. Material descending the slopes in this as in other ways is sooner or later carried away by the rivers.

(5) Every animal which walks over the slope of a valley is likely to loosen more or less material if the slope is steep, and if this material is moved at all, it is likely to be moved downward. Burrowing animals of all sorts loosen the surface material and prepare it to be worked down the slope readily. All these processes help to widen the valley.

(6) Trees which grow on the sides of valleys are sometimes overturned. Whenever they fall, they disturb more or less earthy matter, and some of it is likely to roll down if the slopes are steep. If they are not, the material loosened may be carried down by slope-wash or by other means.

(7) Fine material on the slopes of valleys may be blown away.

Various other processes are also in operation, helping to loosen rock or soil on the slopes, and all processes which loosen the material in this position prepare it for descent, and the descent or removal of matter from the slopes of a valley always increases its width. *All valleys, therefore, are being widened all the time.* In most processes of widening, the stream itself is an important factor, for it carries away much of the material which descends the slopes. Along the bases of the slopes of many valleys there is much debris (*talus*) waiting to be carried away (Fig. 121).

**Width-limit.** As a result of all the processes which wear back their slopes, adjacent valleys may be widened until the divide

between them is worn away (Figs. 122 and 122*a*). More commonly, however, the divide between valleys becomes low without disappearing altogether (Fig. 123).



FIG. 118.—Sun-cracks in the flood plain of the Missouri. (Chamberlin.)

**Valley flats.** As already implied, streams, after they have cut their channels down to low gradients, develop flats, or *flood*



FIG. 119.—Slumping in the side of a valley, two miles southeast of Trout Lake, near Telluride, Colo. (Hole.)

*plains*, in the bottoms of their valleys. These flats are always below the level of the surface in which the valley lies. Thus the Missis-

sippi River at Dubuque has a flat between one and two miles wide, about 300 feet below its surroundings, and about 600 feet above sea-level. Near St. Louis the flat is 10 miles wide, about 150



FIG. 120.—Slumping on the slope of Monte Cristo Creek, Alaska. (U. S. Geol. Surv.)



FIG. 121.—Talus at base of valley slope, ready to be carried off by the stream. Little Canyon—looking south into Snake River. (U. S. Geol. Surv.)

feet below its surroundings, and about 400 feet above sea-level. At Memphis it is about 35 miles wide and but 220 feet above sea-level. At Vicksburg it has a similar width and a height of but



90 feet. Though increasing width of flat down-stream is characteristic of valleys in general, it must not be understood that the

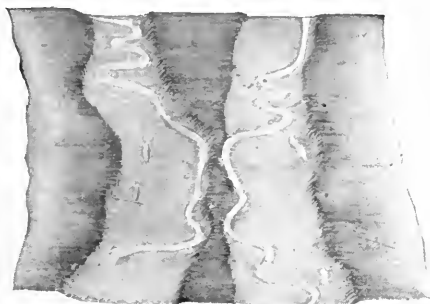

FIG. 122.—Diagram showing streams in adjacent valleys, under-cutting the divide between them. They may, in time, destroy the divide by lateral planation.

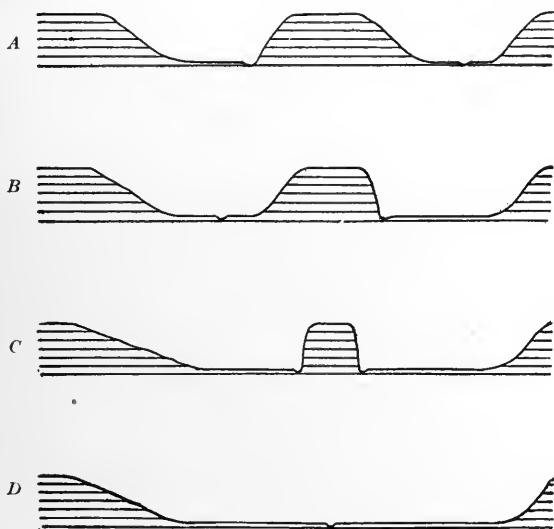

FIG. 122a.—Diagram to show how the divide between streams may be done away with by lateral planation. In *A* the stream at the left is represented as under-cutting the divide between the two valleys. Later, by shifting of its channel, the stream in the other valley might under-cut the other slope of the divide, as shown in *B*. In *C* both streams are represented as under-cutting the divide between them, and in *D* the divide has been done away with.

increase of width is uniform. Narrower portions (often where the rock is more resistant) often alternate with wider ones (often where the rock is less resistant).

Combining these facts with a generalization previously made, we may say (1) that rivers tend constantly to get the material of the land into the sea; (2) that in working to this end they develop

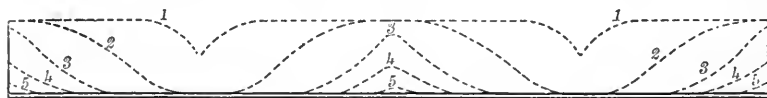

FIG. 123.—Diagram to illustrate the leveling of the surface by valley erosion. The ground profile represented at the top shows two young valleys, 1 and 1, in an otherwise flat surface. In time these valleys will develop the cross-sections represented by 2, 2, and later those represented by 3, 3, 4, 4, etc. The divide between them may finally reach 5, when the surface is nearly flat.

flats below the general level of the surface in which the valleys lie; and (3) that these flats are, in general, wider and lower near the sea, and narrower and higher far from it. Plates VIII to X and Figs. 124 and 125 show valley flats in various sorts of regions.



FIG. 124.—A valley flat in an early stage of development. Monte Cristo Creek, Alaska. (U. S. Geol. Surv.)

Most valley flats are developed chiefly by the side-cutting of the streams (Pl. VIII) after they have become sluggish. The streams which flow through flats generally meander, that is, they have very winding courses (Pls. IX, X, and XI).

The valley flat is a *sort of base-level*, though the first flat developed by a stream is not necessarily the lowest level to which it may

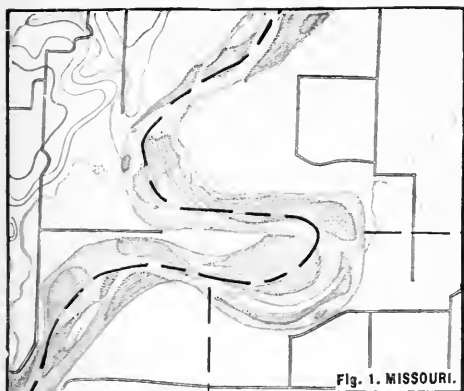

Fig. 1. MISSOURI.

FIG. 1.—A meandering stream. The Missouri River. Scale 2— miles per inch. (Marshall, Mo., Sheet, U. S. Geol. Surv.)

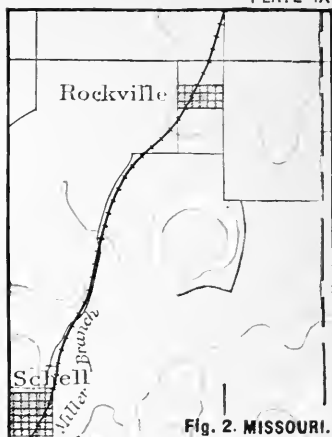

Fig. 2. MISSOURI.

FIG. 2.—A further stage in the development of a meander. The Schell River, Missouri. Scale 2— miles per inch. (Butler, Mo., Sheet, U. S. Geol. Surv.)

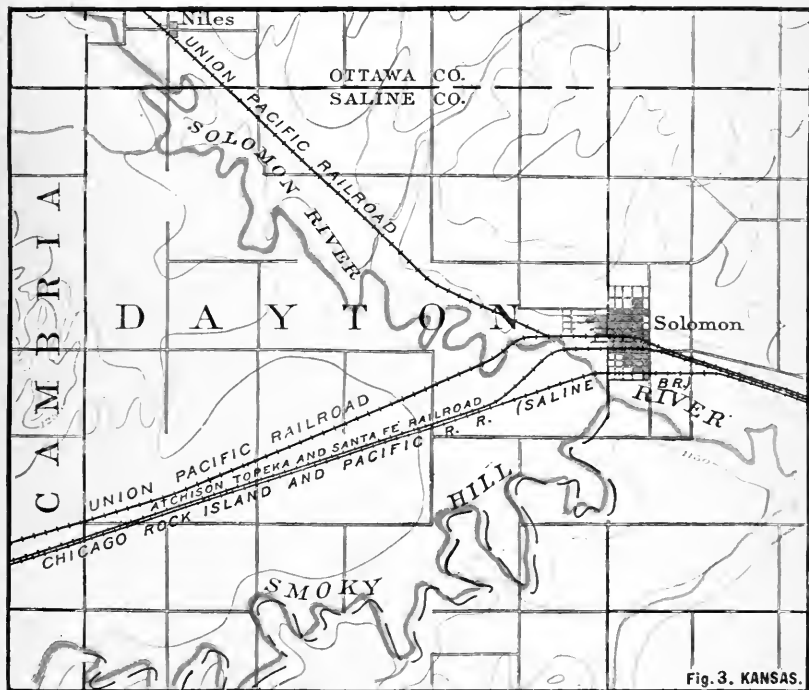
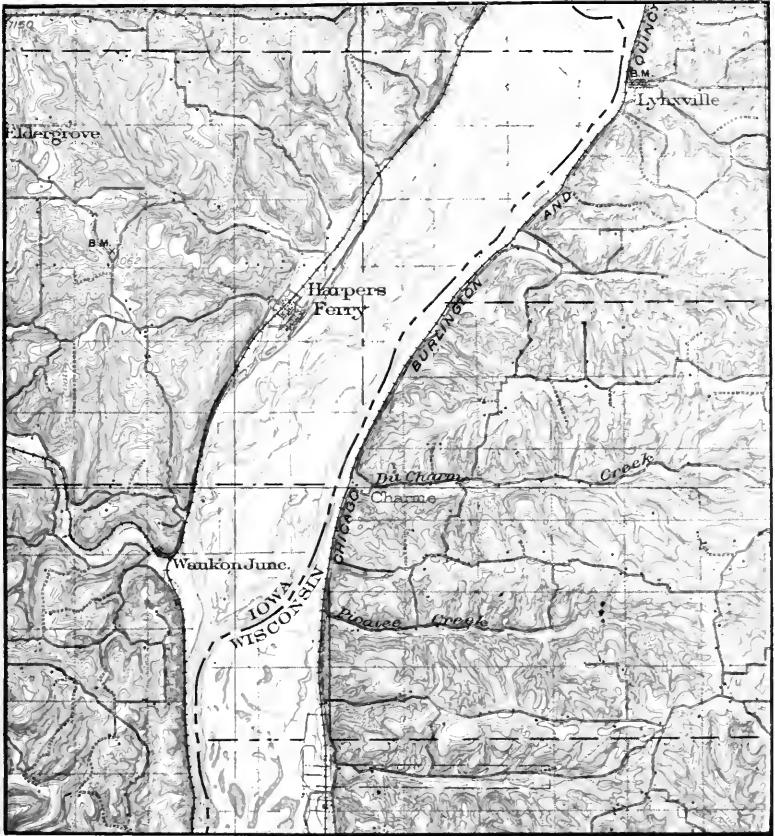

Fig. 3. KANSAS.

FIG. 3.—A plain in old age. Scale 2— miles per inch. (Abilene, Kan., Sheet, U. S. Geol. Surv.)





A well-developed river flat. Valley of the Mississippi, near Prairie du Chien, Wis. Scale 2— miles per inch. (Waukon, Ia. — Wis. Sheet, U. S. Geol. Surv.)

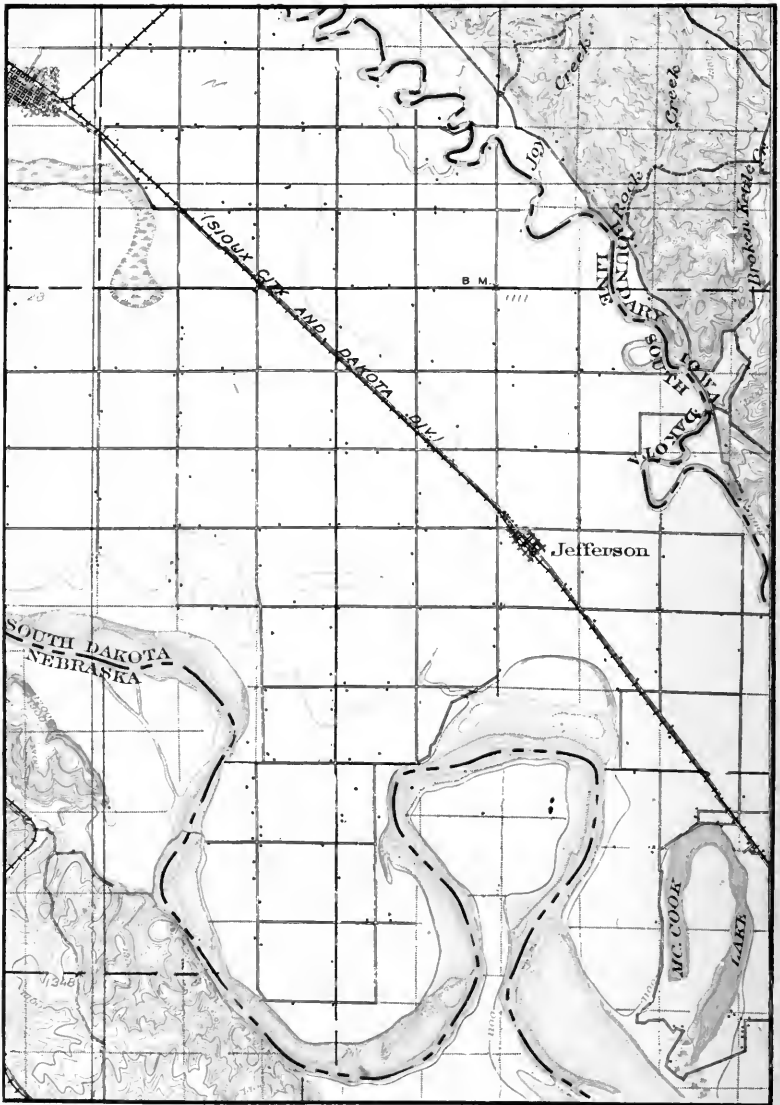

Stream flats. The Missouri and Big Sioux rivers. Scale 2— miles per inch.  
(Elk Point, S. Dak.—Ia.—Neb. Sheet, U. S. Geol. Surv.)

bring its valley bottom. *It is the lowest level to which the stream can bring its valley under the conditions which exist when the flat is developed.* It is therefore a temporary base-level, and serves as



FIG. 125.—A wide valley flat. Milk River near Pendant d'Oreille, Canada. (U. S. Geol. Surv.)



FIG. 126.—Trout Creek, Yellowstone Park. (U. S. Geol. Surv.)

the limit below which tributary streams may not cut. Later, under changed conditions, the stream may sink its channel well below its first flat, and when this is done by a main stream, all its tributaries may do the same.

**The lengthening of valleys.** Valleys are lengthened, too, in various ways. Illustration of one way in which they are made longer is furnished by the gullies developed on hillsides during heavy rains. The gully made during one rain-storm is often

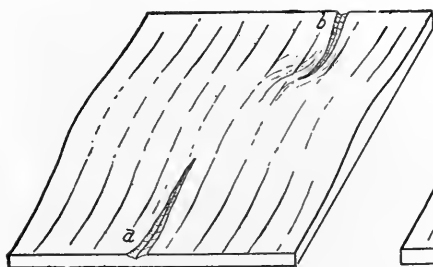

FIG. 127.

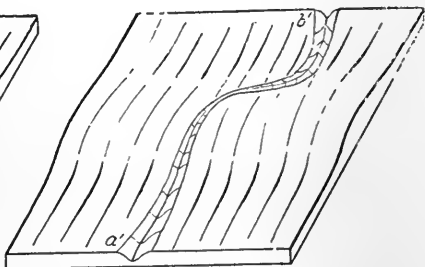

FIG. 128.

FIG. 127.—Two young valleys heading toward each other.

FIG. 128.—Valleys of Fig. 127 developed headward until their respective heads have met and the divide has been lowered a little at the point of meeting.

lengthened at its upper end (headward) during the next, by the water which flows in at its head. The process of lengthening may sometimes be seen even during the progress of a single storm. The heads of valleys often have the characteristics of ravines or gullies. Valleys are, indeed, in some cases no more than growing ravines which are working their heads inland, after the manner of hillside gullies.

By this process the head of a valley may advance until a *permanent divide* is established. Thus in Fig. 127 the heads of the valleys, *a* and *b*, may be worn back farther into the upland; but when the heads of the valleys reach the points shown in Fig.

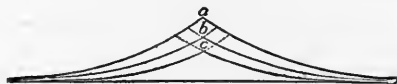

FIG. 129.—Diagram to illustrate the lowering of a divide without shifting it. The crest of the divide is at *a*, *b*, and *c* successively. If the erosion was unequal on the two sides, the divide would be shifted.

128, neither can advance farther, *if the rates of erosion are the same on both sides of the divide*. The divide is then permanent, for though continued rainfall may lower it, it cannot shift its position (Fig. 129).



It is not to be understood that all valleys are being lengthened at their heads in this way. Thus the head of the St. Lawrence River is at the foot of Lake Ontario, and will remain there as long as the lake shore remains where it now is.

In its growth in length, the head of one valley may reach another valley, when the two become one. This is illustrated by Fig. 130. Streams are sometimes lengthened at their lower ends. This is the case where the sediment which they deposit at their debouchures (lower ends) builds the land out into the sea. The streams then find their way across the new-made land. Across such lands the streams have channels, but never valleys of much depth. There are various other ways in which valleys become longer, but they will not be considered at this point.

**Summary.** All valleys are being made deeper in at least some part of their courses all the time; all valleys are being made wider all the time; and some valleys are growing longer. All streams sooner or later develop flats in their valleys, and these flats may increase in width till the divides between them are worn away. Where the divides between streams are not worn away by the lateral planation of the streams, they may become so low as to be inconspicuous. In either case the area affected becomes nearly flat, at a level as low as running water can cut it. The land is then base-leveled.

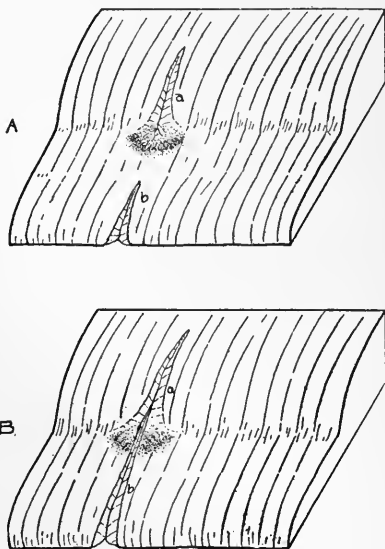

FIG. 130.—Diagram to illustrate one mode of valley lengthening. In A there are two small valleys, *a* and *b*, and the former ends at the base of the steep slope. In B the valley *b* is represented as having been lengthened so as to join *a*, and the two have become one.

### *The History of a River System*

Since valleys grow deeper, wider, and longer year by year, they must formerly have been smaller than now. If, in imagination,

we trace them backward in their history, we may think of a time when the large valleys of the present day were small, when the small valleys were only ravines, when the ravines were only gullies, and when the present gullies did not exist. Or, going still further back, we may imagine a time when even the large valleys had a beginning.

A principal method of valley birth and growth is illustrated by the development of a gully. The rain-water which falls on the



FIG. 131.—Gullies developing on easily eroded soil. Clear Lake, Cal. Every shower will cause them to grow headward. (Fairbanks.)

surface tends to gather in such depressions as exist, and to flow through them down the slopes. The water concentrated in the depressions flows faster than that not so concentrated, and wears the surface there more than elsewhere, and so starts a gully. The gully started during one shower is made deeper, wider, and longer by the next. Year by year, as the result of repeated showers and repeated meltings of snows, the gully may grow to be a ravine, and still later, by the same processes, it may become a valley. A hillside gully is essentially like a river valley except in size, and many valleys are but gullies grown big.

Not all gullies, however, become valleys, and not all valleys

start as gullies. On a steep slope numerous gullies may start (Figs. 107, 131, 132, and 133); but as they grow, some are so widened as to take in others (Fig. 134), and the number is reduced.

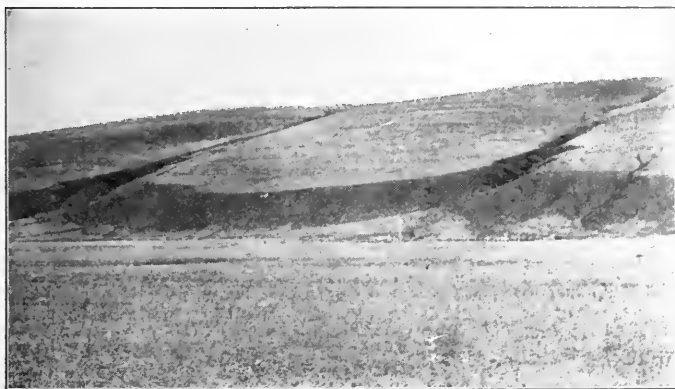

FIG. 132.—Gullies on slope above a valley flat. (Montana.)

Relatively few gullies become even ravines, fewer still become small valleys, and very few ever attain great size. As valleys



FIG. 133.—Surface much furrowed by the development of erosion gullies. Montana. (George.)

develop from gullies, the heads of some work back faster than others, with the result that many valleys are arrested in their development early, and so are dwarfed (Fig. 135). For example, *g*,

Fig. 135A, will grow in length little more, because the water which falls on the land above its head flows off by some



FIG. 134.—Diagram illustrating how one gully takes another as a result of lateral erosion.

other route to the sea. Later stages in the development of these valleys are illustrated by Fig. 135. B and C. The contest among gullies and valleys, resulting in the survival of a few and the exceptional

development of a very small number, may be called a *struggle for existence*.

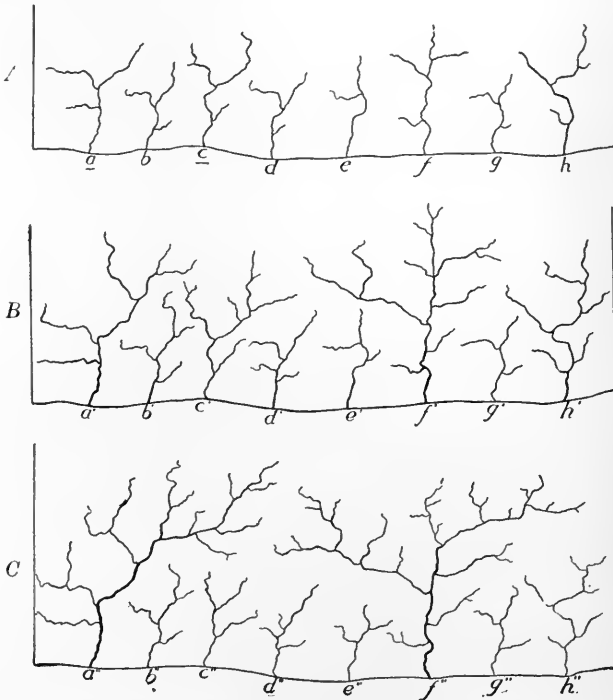

FIG. 135.—Diagrams illustrating successive stages in the struggle for existence and dominion among streams.

**The courses of valleys.** The headward growth of a gully is due chiefly to the erosion of the water which flows into its upper end. If the material about the upper end of a gully is of uniform hardness, the head of the gully works back in the direction from

which the greatest volume of water enters. Unevenness of the surface about the head of the gully may concentrate the inflowing water now at this point and now at that, as the head of the gully advances. Consequently the head of the gully is rarely worn back in a straight line. It turns to the right ( $b'$ , Fig. 136) where more

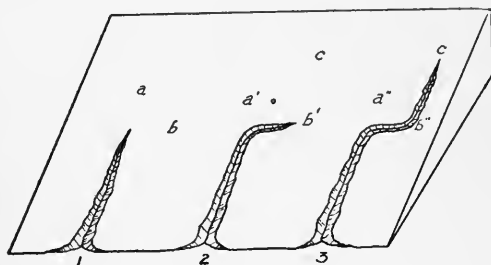

FIG. 136.—Diagram to illustrate the direction of lengthening of a valley. At 1 the valley is straight. If at this stage more water comes in from the direction  $b$  than from the direction  $a$ , the wear is greater toward  $b$  than toward  $a$ , and the head turns as shown in 2. If at this stage more water comes in from the direction  $c$  than from any other direction, the head turns in this direction, as shown in 3.

water comes in from that side, and to the left,  $b''$ , where there is more inflow and wear on that side.

If the material about the head of the gully is less hard at one point than at another, the head of the gully will work back on the material which is most easily worn, even though the amount of water flowing in from that direction is no greater than elsewhere. Inequalities of slope or material, therefore, cause the gully's head to turn now to one side and now to the other, and where the gully's head goes, there the valley which develops from it follows, if the gully reaches valley-hood. The crookedness of many valleys is thus explained.

**The permanent stream.** Water commonly flows in a gully only when it rains and when the snow is melting, and for a short time afterward; but many valleys were developed from gullies, and sooner or later most valleys have permanent streams. Where does the water for the permanent stream come from?

The answer to this question may be readily inferred. When a valley has been deepened so that its bottom is well below the ground-water surface, the ground-water seeps or flows out into the valley, and once in the valley in sufficient quantity, it becomes

a stream (Fig. 137). The valley whose cross-section is shown by 1, Fig. 137, would not have a stream; the valley whose cross-section is represented by 2 would have a stream in wet weather, when the ground-water level is at *a*; while the valley 3 would have a permanent stream because it is well below the ground-water level, *b*, of dry times. In regions where the ground-water surface is deep,

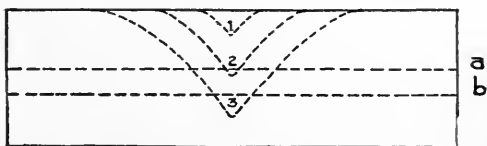

Fig. 137.—Diagram showing ground-water surface: *a* the ground-water surface at ordinary times, and *b* in times of drought. When a valley has been cut below *a* there will be a stream in wet weather, but it will go dry in time of drought. When the valley is down to 3 below the ground-water surface of dry weather the stream will be permanent.

the valley must be deep to get a stream. In regions where the ground-water surface is near the land surface, even shallow valleys may have permanent streams.

Streams which are fed by lakes and streams which have their sources in snow- and ice-fields which persist from year to year, are not immediately dependent on ground-water, though they often receive it.

**Not all valleys are grown-up gullies.** Not all valleys were formed by the growth of gullies. A great area in the northern part of North America, for example, was once covered by a great sheet of snow and ice. When it finally melted, large parts of the surface were left without well-defined valleys, but with numerous lakes. The rainfall of the region was enough to make many of these lakes overflow. When a lake overflows, the outgoing water follows the lowest line accessible to it, so long as there is a line of descent. In this case, the running water will start to cut a valley all the way from the lake which furnishes the water, to the end of the stream, at the same time. No part of such a valley is much older than another. Valleys developed in this way may have permanent streams at the outset, since they are not dependent on ground-water. The course of a valley developed in this way was not determined by the direction in which the head of the valley grew, but by the direction which the water took at the outset, that is, by the course of the lowest descending slope.

**Growth of tributaries.** Most valleys are joined by many smaller tributary valleys. The reason may be easily understood by the study of a gully.

If the slopes of a gully were worn back everywhere at the same rate, tributaries would not develop; but the sides are rarely or

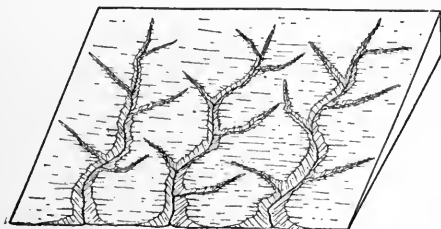

FIG. 138.—Diagram showing tributaries in an early stage of development.

never worn back equally. Either the material is softer at some places than at others, or the water flowing down the slopes is concentrated along some lines more than along others. In either case the erosion of the side slopes is greater at some points than at others, and where the erosion on the slope of a main gully is greater than at adjacent points, a tributary gully is started (Fig. 138). Tributary gullies are therefore developed in the same way, and for the same reason, as the larger ones from which they grow. The tributary gully grows in length, width, and depth as its main

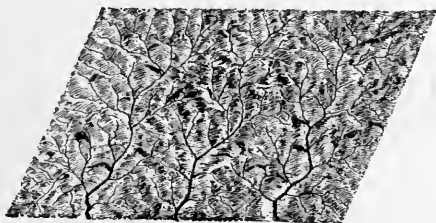

FIG. 139.—Diagrammatic representation of a surface much dissected by the development of numerous tributaries.

did, and in time it may become a valley and acquire a permanent stream. Tributaries to the tributaries are developed in turn, until a network of watercourses affects the surface. Figs. 139, 140, and 141 show a surface in this condition. A valley developed by outflow from a lake develops tributaries in the same way as one

developed from a gully. Such a valley might also get tributaries by the inflow of water from other lakes.

A valley and its tributaries constitute a *valley system*. A stream and its tributaries constitute a *drainage system*, and the area drained by a river system through a valley system is a



FIG. 140.—Photograph of the model of an area in northwestern Connecticut, showing a surface much dissected by erosion. (Model by Howell.)

*drainage basin*. From the conditions under which a valley system develops, the outline of a drainage basin often comes to be rudely pear-shaped (Fig. 142).

**Stages in the history of a valley.** We have seen that valleys normally grow as they advance in years. When a valley is *young*, it is narrow, and its slopes are steep. If the land is high, it has a high gradient (unless far from the sea) and soon becomes deep.



Its cross-section is then somewhat V-shaped (Fig. 143), and its tributaries are short. The *mature valley* is wider (Fig. 144), its slopes are often gentler, and its tributaries are longer and older.

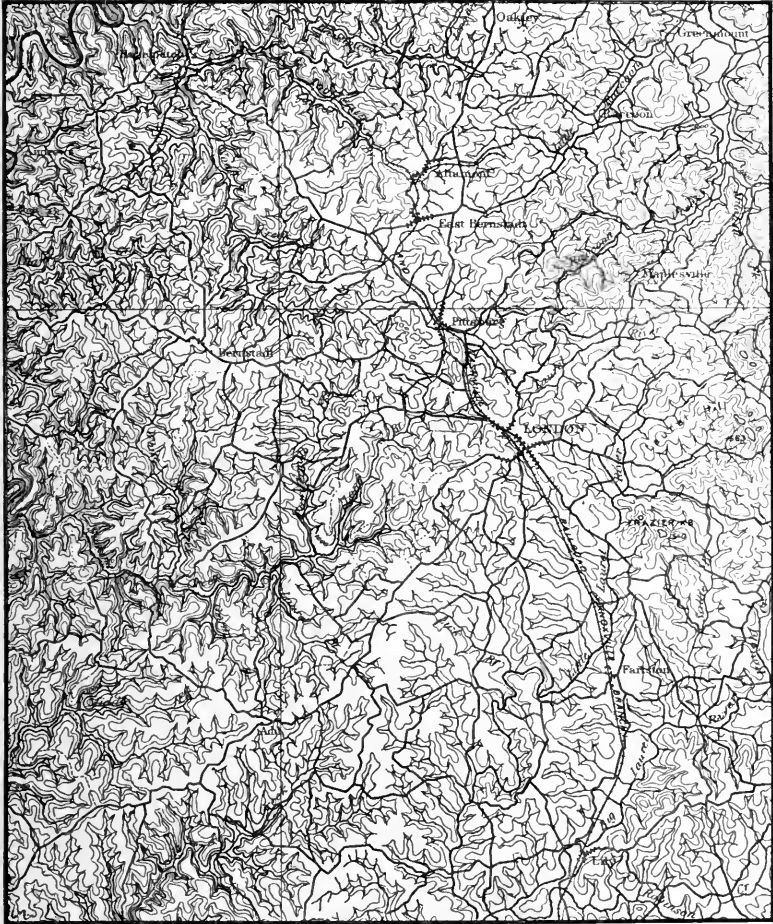

FIG 141.—Contour map of the area shown in Fig. 104, representing the same type of surface shown in Figs. 139 and 140.

An *old valley* is wide, has a broad flat or flood plain and a low gradient.

A stream also, as well as its valley, passes from youth to ma-

turity, and from maturity to old age. In its youth it is likely to be swift and impetuous, unless it flows through low land. In maturity it is much steadier in its flow, and when it reaches old age it meanders through its wide plain. Even an old stream, however, may take on the vigor of youth when it is flooded.

The terms *youth*, *maturity*, and *old age* are also applied to river systems. Every river system, aided by weathering, has



FIG. 142.—Map of the principal streams of southern New Jersey, and outlines of their basins, shown in dotted lines.

entered upon the task of carrying to the sea all the land of its basin which is above base-level. So long as the river system has the larger part of its task before it, it is *young* (Fig. 1, Pl. XII). In youth the land is often ill drained and may have many ponds and lakes (Pl. III). When the main valleys have become wide and deep, and the areas of upland have been well cut up (dissected)



Fig. 1. ILLINOIS.

FIG. 1.—Youthful valleys. Shore of Lake Michigan just north of Chicago. Scale 1— mile per inch. (Highwood Sheet, U. S. Geol. Surv.)

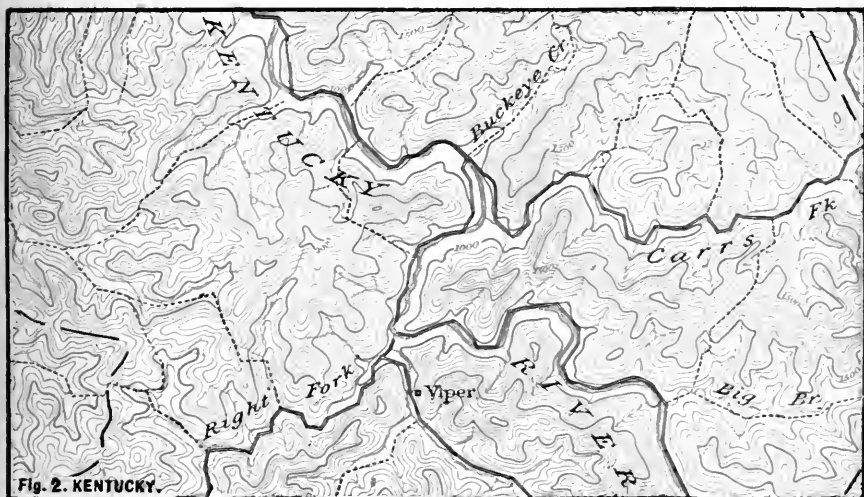
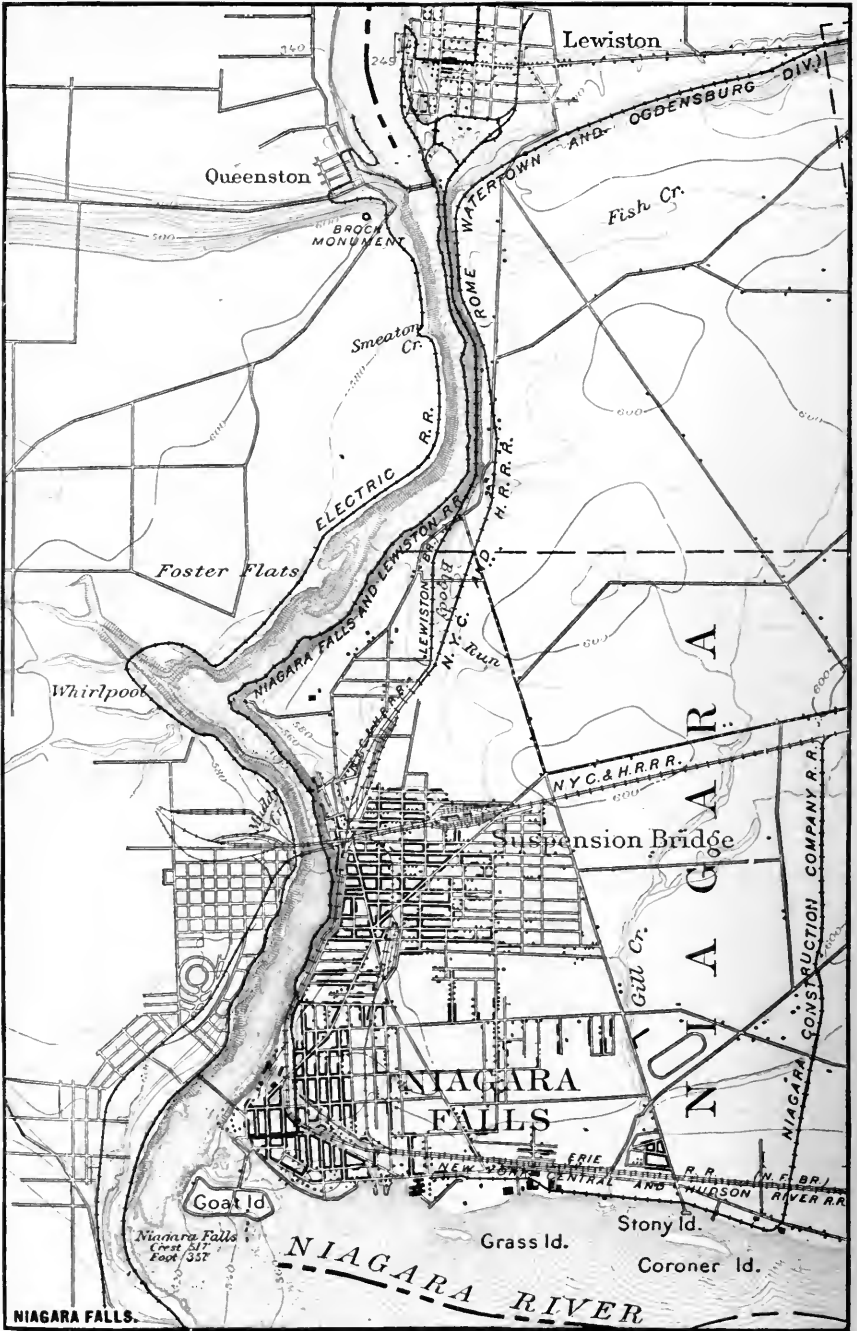

Fig. 2. KENTUCKY.

FIG. 2.—A region in a mature stage of erosion. Scale 2— miles per inch. (Kentucky, U. S. Geol. Surv.)



The Niagara Gorge. Scale 1— mile per inch. (Niagara Falls Sheet, U. S. Geol. Surv.)



FIG. 143.—A young V-shaped valley, the Stehekin River, Wash.  
(U. S. Geol. Surv.)



FIG. 144.—A valley much older than that shown in Fig. 143, Gray Copper Gulch, southwestern Colorado. (U. S. Geol. Surv.)

by valleys, the river system is said to have reached *maturity* (Pl. XII, Fig. 2). The land is then well drained. When the task of base-leveling its drainage basin is nearing completion, the river system has reached *old age*, Fig. 3 (Pl. IX). The master stream of a drainage system attains the characteristics of maturity and age sooner than its tributaries, and in its lower course sooner than in its upper.

The topography of a drainage basin is youthful when its river system is youthful, mature when its river system is mature, and old when its drainage is old. In an area of *youthful topography* much of the surface has not yet been much affected by erosion (Fig. 1, Pl. XII); in an area of *mature topography* the surface has been largely reduced to slopes by erosion (Fig. 2, Pl. XII); while an area of *old topography* is one which has been brought down to general flatness by erosion (Fig. 3, Pl. IX). Some parts of a drainage basin, especially those parts near the master stream, may take on the characteristics of age, while other parts farther from the trunk stream may not be advanced beyond maturity or even youth.

#### MAP EXERCISE

##### *Topographic Maps Showing Erosion Topography in Various Stages of Development*

I. Study the following maps in preparation for the conference:

- |                          |                           |
|--------------------------|---------------------------|
| 1. Emporia, Kan.         | 7. Fredonia, Kan.         |
| 2. Kanawha, W. Va.       | 8. Mt. Guyot, Tenn.—N. C. |
| 3. Prince Frederick, Md. | 9. Casselton, N. D.       |
| 4. Ridgeway, N. Y.       | 10. Princeton, Ind.—Ill.  |
| 5. Canyon, Wyo.          | 11. Bright Angel, Ariz.   |
| 6. Yosemite, Cal.        |                           |

II. Suggestions for the study of each map:

- Does the map represent a plain, plateau, or mountain region? If more than one of these great types appears, note location of each.
- What is the age of the topography, in terms of erosion, and how is it shown? (If different parts of an area are in different stages, note the fact.)

3. What inferences may be made from the map as to the climate of the region represented? The evidence on which the inference is based?

*Note.* Does the evidence (1) merely suggest the inference, or (2) make the inference probable, or (3) make the inference altogether trustworthy?

4. Are there topographic features which cannot be accounted for by the erosion of running water? If so, where?

**Cycle of erosion.** The time necessary for the development of a base-level throughout a drainage basin is a *cycle of erosion*. This period of time is very long. While land is high and the streams swift, erosion is rapid; but the nearer the land approaches base-level, the slower the processes of erosion. The last part of the process of base-leveling is therefore the slowest of all.

**Peneplains.** It is doubtful whether any extensive land area was ever worn down to a perfect base-level; but great areas have been worn down almost to that level. In such cases low hills or



FIG. 145.—A peneplain near Camp Douglas, Wis. (Atwood.)

ridges remain between the valleys, and hard bodies of rock may rise abruptly above the general level of the plain of degradation. A region in this condition is called a *peneplain* (an *almost-plain*, Fig. 145). It has a surface which has been brought nearly, but not quite, to base-level. If conspicuous elevations of slight extent remain above it, they are *monadnocks*. The name was derived from Mount Monadnock (N. H.), because that mountain was formed in this way.

*Rate of Land Degradation*

Since all lands are being cut down by running water, it is a matter of interest to know how fast they are being brought low. It is also of interest to know whether the lands are to be destroyed altogether, and if so, how long they are to last.

It has been estimated recently by the United States Geological Survey that the Mississippi River carries to the sea yearly about 340,500,000 tons of sediment in suspension, and about 136,400,000 tons in solution. Of these amounts, the Ohio and the Missouri contribute more than half, and the Missouri more than twice as much as the Ohio. The Colorado River is estimated to remove 387 tons, on the average, from each square mile of its basin. The same Survey estimates that the total amount of sediment carried from the United States to the sea in a year is about 513,000,000 tons, and the amount in solution about 270,000,000 tons. On the basis of these figures, it is estimated that the land is being degraded at the average rate of about 1 foot in 9,120 years. It is clear that some parts of the country are being cut down much faster than this, and other parts much more slowly.

If this rate were to be continued without interruption, and if nothing occurred to counteract it, the North American continent would be reduced to sea-level in about 18,000,000 years, for its average height is about 2000 feet. But as already pointed out, however, the present rate of down-cutting cannot continue, for as the land becomes lower the rate of erosion must diminish, since the water must then move more slowly. As a matter of fact, mechanical erosion by running water would cease when the surface was brought to base-level, though solution would still go on.

Other changes, to be discussed later, are likely to occur to prevent the land from being worn down to base-level. The continent is therefore likely to endure not only much longer than 18,000,000 years, but probably indefinitely. Nevertheless, these figures serve a useful purpose in indicating the rate of change which the land is undergoing as the result of the fall of rain and snow upon it.

**Conditions affecting the rate of erosion.** Some of the conditions affecting the rate of erosion by running water have been stated or implied in the preceding pages. By way of summary they may be brought together at this point.

The rate at which running water wears down the surface over



which it flows depends largely on (1) the volume of the water, (2) its velocity, (3) the character of the material over which it flows, and (4) the amount and character of the load it carries.

(1) The volume of water flowing over the land outside of streams depends chiefly on the rainfall. The volume of a stream depends chiefly on (a) the area which it drains, and (b) the amount of precipitation within its basin. The larger the area and the greater the amount of the precipitation the larger the stream.

(2) The velocity of running water depends on (a) its *gradient* or slope, (b) its volume, especially its depth, (c) its load, and (d) the shape and configuration of its channel. The higher the gradient, the greater the volume, the less the load, and the smoother and narrower its channel, the faster the flow.

The effect of slope on velocity needs no explanation. That increase of volume increases the rate of flow is shown by the familiar fact that a stream in flood runs faster than at other times. The erosive force of a flooded stream has already been referred to (Figs. 101 and 102). The carrying of sediment, in whatever form, is a tax on the stream's energy, and the more the load the greater the tax. The energy used in carrying is taken from the energy which would otherwise be available for flowing. A smooth channel offers less friction than a rough one, and so favors high velocity. But, apart from smoothness, the channel which favors

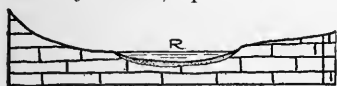

FIG. 146.—A broad, shallow river channel.



FIG. 147.—A deeper and narrower channel than that shown in Fig. 146, with the same gradient. A stream in a channel such as is represented in Fig. 147 will flow faster than one in such a channel as that shown in Fig. 146.

great velocity is that which offers *least area of contact with the water*. Thus a broad shallow channel (Fig. 146) has a greater surface of contact with the water than a deeper, narrower channel (Fig. 147). The water in the former has more friction with its bed, and friction retards the current. Nearly all streams which flow now in a narrow channel and now in a wide one, have greater velocity where their channels are narrowed.

(3) The character of the surface of its basin, and especially the character of the material in its channel, also influences the rate of a stream's erosion. If the surface of the land on which the rain



FIG. 148.—Oneonta Gorge, Canyon of the Columbia, Ore. (Fairbanks.)



FIG. 149.—Grand Canyon of the Colorado. (Peabody.)

falls is bare solid rock, the immediate run-off brings little sediment to the stream, and if the bed of the stream is bare solid rock, the stream wears it less than if it is of mud or sand.

(4) To work most effectively, the stream must carry load (tools) enough to enable it to cut rapidly, but not so much as to make it flow so slowly that it cannot use its tools effectively.

### *Exceptional Features Developed by Erosion*

**Canyons and gorges.** When valleys are so narrow and deep as to be striking, they are called gorges or canyons. In general canyons are larger than gorges, though there is no sharp distinction between them. The sides of small gorges and young canyons are sometimes nearly vertical (Fig. 148), but the sides of the large canyons are rarely so (Fig. 149). The distinction between a canyon and a valley which is not a canyon is not a very sharp one, and, in regions where canyons abound, the term is often applied to all valleys.

The Colorado canyon (Figs. 27, 27a, and 149) is the greatest canyon known. Its maximum depth is about a mile, but where it has this depth, it is often 8 to 10 miles wide from rim to rim, though very narrow at the bottom. With a depth of one mile and a width of 8 miles, the slope, if uniform, would have an angle of less than  $15^\circ$ . The cross-section of such a valley is shown in Fig.

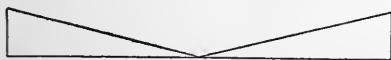

FIG. 150.—Diagram showing the proportions of a valley the width of which is eight times the depth. These are approximately the proportions of the Colorado Canyon.

150. But the slopes of the canyon are not uniform, as shown by Fig. 151. The irregularities of slope are caused by inequalities in the hardness of the rock of the canyon walls.

The Yellowstone River also has a notable canyon 1000 feet or so deep (Fig. 152 and Fig. 1 of Pl. IV). Its width is less in proportion to its depth than that of the canyon of the Colorado.

Narrow valleys mean that the processes of valley deepening have outrun the processes of valley widening. This in turn means that the stream which made the gorge or the canyon was swift, or that the processes of valley widening (p. 131) were slow, or both.

Valleys are deepened rapidly when their gradients are high and the streams strong. They are widened slowly when the climate is arid so that there is little slope-wash, when the stream is so swift that it does not meander, and when the material of the sides is such that it will stand with steep slopes. Solid rock, for example, will stand with steeper slopes than loose sand. We conclude that (1) great altitude, (2) arid climate, (3) strong streams, and (4) a rock structure which will stand in steep slopes, favor the development of valleys of the canyon type. In other words, youthful valleys in plateaus and mountains are likely to be canyons,

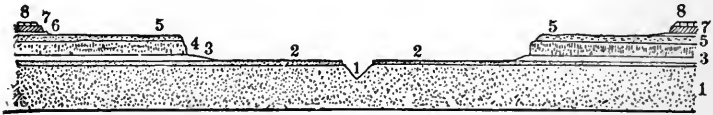

FIG. 151.—Cross-section of the Colorado Canyon.  
(After Gilbert and Brigham.)

if climate and rock structure favor. The plateaus of the western part of the United States furnish these conditions, and canyons are there common. This is true not only of main streams but of their tributaries as well.

A strong stream in an arid region is possible when the valley is supplied with abundant water from a humid region above. The Colorado River is an example.

Since gorges often occur in humid regions, it is clear that *all* the conditions favoring the development of canyons need not be present in order to develop gorges. Thus the Niagara River has a gorge or canyon below the falls (Pl. XIII). Here the down-cutting is so rapid that the processes of valley widening have not kept pace with it, in spite of the fact that the region is humid.

The deeper canyons of the west constitute well-nigh impassable barriers to travel athwart their courses, while their rivers rarely serve the needs of commerce or irrigation. Considerations of defence doubtless led the cliff-dwellers to make their homes in the almost inaccessible canyon walls.

Canyons must ultimately develop into valleys of another type, for the stream of the canyon will ultimately cut to base-level. The valley will then cease to become deeper, but

the processes of valley widening will still go on, and the narrow valley will become wider and wider until it ceases to be a canyon.



FIG. 152.—The canyon of the Yellowstone below the falls.  
Yellowstone National Park.

**Bad lands.** To a type of topography developed in early maturity in certain high regions where the rock is but slightly, though unequally, resistant, a special name, *bad land*, is sometimes given. Some idea of bad-land topography is gained from

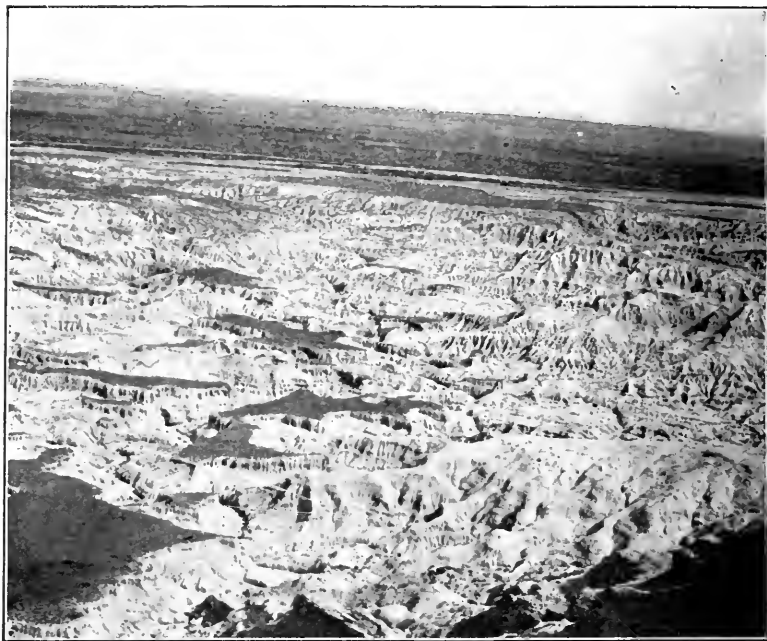

FIG. 153.—Bad-land topography north of Scott's Bluff, Neb.  
(U. S. Geol. Surv.)

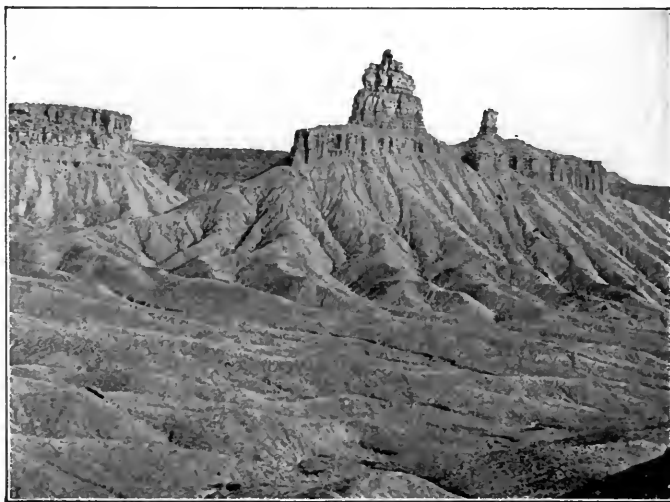

FIG. 154.—Bad-land topography southwest foot of Mesa Verde, Colo.  
(U. S. Geol. Surv.)

Figs. 153 and 154. Bad-land topography is found in various localities in the West, conspicuously in western Nebraska, in Wyoming and the western parts of the Dakotas. The formations here are often beds of sandstone or shale, alternating with unindurated beds of clay. Climatic factors are also concerned in the development of bad-land topography. A semi-arid climate, where the precipitation is much concentrated, seems to be most favorable for its development.

**Natural bridges.** If a stream flowing over jointed rock has falls, the conditions are sometimes afforded for the development of

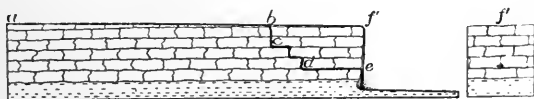

FIG. 155.—Diagram to illustrate the initial stage in the development of a natural bridge. Longitudinal section at the left, cross-section at the right.

an exceptional and striking scenic feature. If above a waterfall there were an open joint in the bed of the stream (as at *b*, Fig. 155), some portion of the water would descend through it. After reaching a lower level it might find or make a passage through the rock to the river below the falls. If even a little water

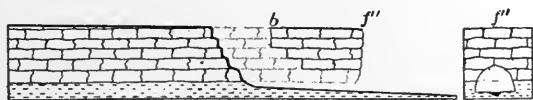

FIG. 156.—A stage later than that shown in Fig. 155.

takes such a course, the flow will enlarge its channel, making a passageway from the joint through which the water descends to the valley below the fall (*bcde*, Fig. 155). This passageway may become large enough to accommodate all the water of the river. In this case, the entire fall would be transferred from the position which it previously occupied (*f*) to the position of the enlarged joint (*b*). The fall would then recede. The underground channel between the old falls and the new would be bridged by rock (*bf''* and *f''*, Fig. 156), making a *natural bridge*. A bridge of this sort is now in process of development in Two Medicine



FIG. 157.—A partially developed natural bridge in Two Medicine River, Mont. (Whitney.)



FIG. 158.—The Natural Bridge of Virginia. (U. S. Geol. Surv.)



River in northwestern Montana (Fig. 157). Once in existence, a natural bridge will slowly weather away. The natural bridge near Lexington, Va. (Fig. 158), almost 200 feet above the stream which flows beneath it, is believed to have been developed in this way. It is not to be understood, however, that all natural bridges have had this history (see p. 98).

*Effects of Inequalities of Hardness of Rock*

**Rapids and falls.** The bed of a stream is often steeper at some point than at others (Fig. 159), and there the stream flows more rapidly. In such a case as that illustrated by Fig. 159 the quickened flow constitutes a *rapid*. If the water in a stream's



FIG. 159.—Chandler Rapids in river of the same name in Alaska.  
(U. S. Geol. Surv.)

bed drops over a cliff, it makes a *waterfall* (Figs. 160, 161, and 162). Between a waterfall and a rapid there are all gradations (Fig. 163). Steep rapids are often called falls, and both are sometimes called cascades.

Falls and rapids occur in many places and under many conditions, but they are most common where the material of the valley



FIG. 160.—Niagara Falls. (U. S. Geol. Surv.)



FIG. 161.—The lower falls of the Yellowstone.



FIG. 162.—Twin Falls, Snake River. (U. S. Geol. Surv.)



FIG. 163.—Rustic Falls. A succession of slight falls in the Yellowstone Park. (U. S. Geol. Surv.)

bottom is of unequal hardness. They are commonly located where the river passes from more resistant rock to that which is less resistant.

The falls and the rapids of many rivers add greatly to their beauty, and sometimes enhance their value to mankind by affording abundant water-power. Niagara Falls affords about 4,000,000 horse-power, so much of which has been or seems likely to be granted to manufacturing companies, that a movement has been begun to "save the falls." The Falls of St. Anthony did much to make Minneapolis the greatest flour manufacturing city of the world. Some of the great manufacturing cities of New England also grew up about low falls and rapids. Advantageous as falls are as a source of power, they are enemies of navigation. The falls (really rapids) of the Ohio necessitated the breaking of bulk at that point, and so determined the location and early growth of Louisville. A canal designed to evade the obstacle was completed in 1830.

Falls and rapids are undergoing constant change, although the change is usually very slow. The falls of the Niagara are receding up-stream, because the falling water undermines the hard layer of rock over which it is precipitated (Fig. 164). As a fall recedes, it generally becomes lower. In such cases it is clear

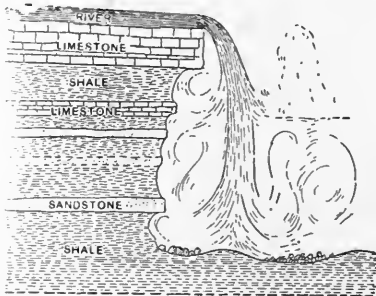

FIG. 164.—Diagram illustrating the conditions at Niagara. (Gilbert.)

that the fall will disappear if it recedes far enough. If the hard rock over which the water drops be in the position shown in Fig. 165, the fall will not recede, though it will become lower and will disappear when the stream cuts down to base-level where the fall is. Rapids and falls are therefore temporary features of streams. Like canyons, they are marks of youth, for they

show that the stream is well above base-level. In time, all existing rapids and waterfalls will disappear, for they can no longer exist after rivers have reached base-level, the goal of every stream.

From a waterfall we may reason backward in time as well as forward. If existing falls are to disappear, was there a time before they existed?

Suppose the material along the line followed by vigorous drainage to be of unequal hardness. The less resistant part will be

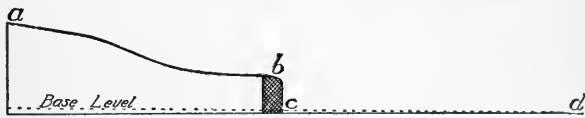

FIG. 165.—Diagram illustrating a condition where a fall will not recede.

worn more rapidly than the more resistant part farther up the stream, with the result shown in Fig. 166. The continued wear

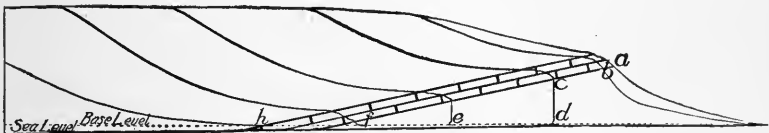

FIG. 166.—Diagram illustrating the development of a fall where the hard layer dips up-stream.

of the water in such a case will cause the rapids at *a* to become more rapid, and the process of steepening the bed of the descending water will go on until the rapids become a fall. In this case, *the rapids and falls depend on inequalities of hardness discovered by the stream in the excavation of its valley.* This is perhaps the commonest way in which falls and rapids originate. Falls originating in this way are developed gradually. Such falls may be called subsequent falls, since they do not depend on the original shape of the surface.

In other cases the surface run-off, in following its course to the sea, may reach a cliff and plunge over it. In this case, the steep descent of surface existed before the stream found it, and the falls began when the river came. Since such falls result from the irregularities of surface over which the river began to flow, they may be called *consequent* falls. A good example of such a fall is that of the Niagara, formed when the outflow from Lake Erie reached and fell over a cliff on its way to Lake Ontario. Since the fall began it has receded some seven miles.

Falls are formed in still other ways. A landslide or a lava-flow may form a dam, over which the water falls or flows in rapids. In such cases, especially the former, the dams, and therefore the rapids and falls, are often temporary.

At the bottoms of falls *pot-holes* (Fig. 167) are sometimes developed. The start is made as a result of slight inequalities in the

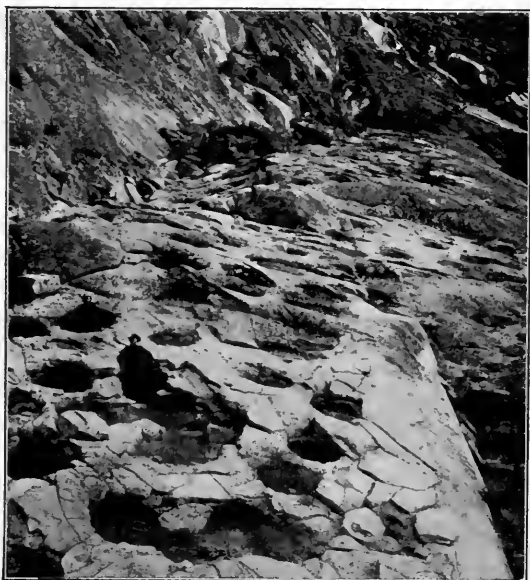

FIG. 167.—Pot-holes in granite. Upper Tuolumne River, Cal.

surface of the rock. The holes reach their conspicuous size as the result of wear by stones kept in motion in them by the eddies of the falling water.



FIG. 168.—Diagram showing a narrow place in a valley where the stream crosses a hard layer of rock.

**Narrows.** When a stream cuts through a bed of hard rock, it not only develops rapids and falls, but the hard rock affects the valley in other ways. The resistant rock weathers less rapidly

than the weak rock, and hence the valley is narrower where the rock is resistant than where it is weak. Such a constriction of the valley is a *narrows* (Fig. 168) or a *water-gap*. The Delaware Water Gap through the Kittatinny Mountain is a well-known



FIG. 169.—The Lower Narrows of the Baraboo River, Wisconsin.  
(Atwood.)

example. The narrows of the Baraboo River in Wisconsin (Fig. 169) is another good example. Unlike falls, narrows are not most conspicuous in the youth of the stream, but at a later time, after the valley has been much widened in the weak rock adjacent to

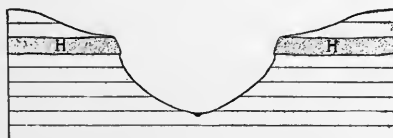

FIG. 170.—Rock terraces, due to resistant layers of rock.

that which is resistant. Falls are common in horizontal or nearly horizontal beds, but narrows are commonly developed in stratified rock only where the beds are tilted.

Narrows sometimes serve as gateways through mountains, and so control lines of travel and transportation. The narrows of Wills Creek in Wills Mountain, Maryland, may serve as an example. From Fort Cumberland (site of Cumberland), built by the Ohio Company to guard the important passageway, Nemaocolin's Path and Washington's and Braddock's roads ran west through it,

and the Cumberland National Road and an important railway now pass through it.



FIG. 171.—A monadnock: a mass of igneous rock isolated by erosion and remaining because of its superior hardness. Matteo Tepee, Wyo. (Detroit Photo. Co.)

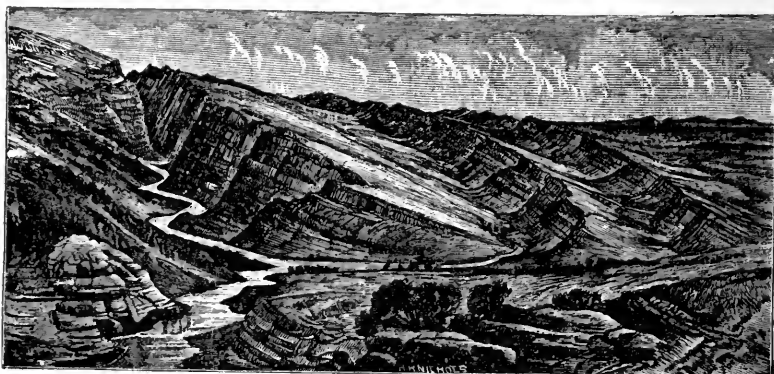

FIG. 172.—Hogbacks, due to the erosion of tilted beds of unequal resistance. The harder layers stand up as ridges and constitute the "hogbacks." (Powell.)

**Rock terraces.** Again, if the hard layer through which a stream cuts is horizontal, the resistant rock weathers less rapidly



than the weaker rock above and below, giving rise to rock terraces, as shown in Fig. 170.

**Monadnocks, rock ridges, etc.** Elsewhere than in valleys,

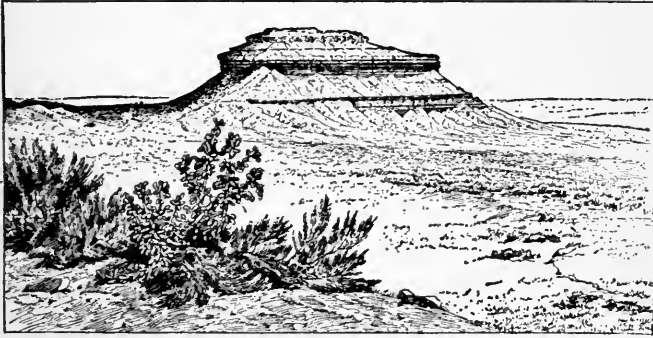

FIG. 173.—A butte. A characteristic feature of the arid plateau region of the West. The butte is really a monadnock. (U. S. Geol. Surv.)

too, rock of more than average resistance makes itself felt in the topography, for rain-wash, wind, and most phases of weathering



FIG. 174.—The Enchanted Mesa. A striking butte in New Mexico. The name mesa is not commonly applied to elevations of such small summit area. (R. T. Chamberlin.)

affect resistant rock less than weak rock. The result is that hard rock often remains as hills, or even as mountains (monadnocks,

p. 153), after the weaker rock about it has been reduced nearly to base-level. Fig. 171 is an example. An elongate narrow ridge,

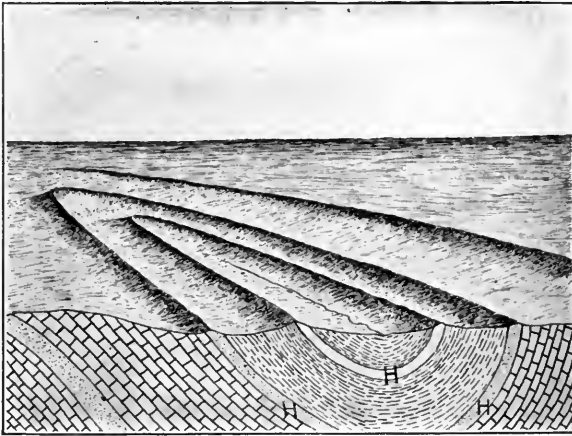

FIG. 175.—A canoe-shaped valley bordered by a ridge formed by the outcrop of a hard layer. (Willis.)

due to the isolation of a tilted layer of resistant rock, is sometimes called a “hogback” (Fig. 172).

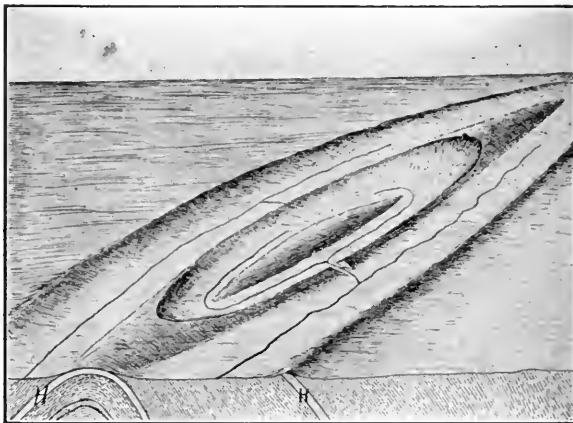

FIG. 176.—Diagram to illustrate the effects of erosion on a fold or anticline, both ends of which dip down (or plunge). (Willis.)

In the West similar elevations are often called *buttes* (Figs. 171 and 174). A hard stratum of rock, such as a lava-bed, overlying

less resistant formations, such as clay or soft shale, often gives rise to buttes. If such an elevation has a considerable expanse of surface at its top, it is a *mesa* (Fig. 28), though this term is also applied to wide terraces, especially if high.

The elevations due to the isolation of outcrops of hard rock by the removal of their less resistant surroundings often take on peculiar forms, dependent on the structure of the rock. Elongate ridges are common where the strata are folded. Where the tops of the original folds were not horizontal, erosion gives the ridges which result from the isolating of the outcrops of hard rock peculiar forms, as shown in Figs. 175 and 176. Such forms are not uncommon in the Appalachian Mountains.

#### *Accidents to Streams*

**Drowning.** Streams are subject to many accidents. If the land through which they flow sinks so as to decrease their gradients,

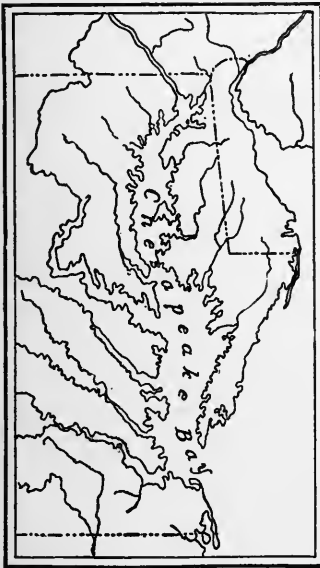

FIG. 177.

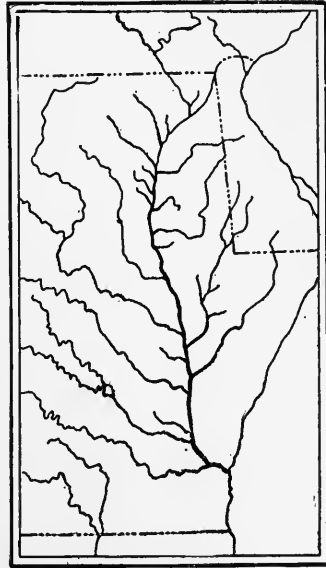

FIG. 178.

FIG. 177.—Chesapeake Bay and its surroundings. The bay is a drowned river valley, and the lower ends of its tributary valleys are also drowned.  
 FIG. 178.—The drainage of the region about Chesapeake Bay as it would have been but for drowning.

they flow less rapidly, or may even cease to flow. If the lower end of a valley sinks below sea-level, sea-water enters and forms

an *estuary*. In such cases the lower end of the river and its valley are *drowned*. If along a coast the streams end in bays, the inference is that the coast has sunk, and that the rivers and valleys have been drowned. The Atlantic coast between New York and the Carolinas is a good example (Fig. 177). Delaware Bay, Chesapeake Bay, and numerous other smaller bays mark the sites of drowned rivers. Without the drowning, the drainage of this region would be somewhat as shown in Fig. 178. By comparison of these figures, it is apparent that drowning has the effect of isolating the parts of a river system.

**Rejuvenation.** If the basin of an old stream is raised, so that the gradient of the stream is increased, its velocity is increased, and it again takes on the characters of youth. Such a stream is said to be *rejuvenated* (Fig. 179). The rejuvenation of a stream means the beginning of a new cycle of erosion, even though the preceding one was incomplete.

If the old stream was meandering in its valley, as old streams often do, the quickened stream cuts its meanders deeper. The meanders are thus *entrenched*. Where a stream has entrenched meanders, there is a strong presumption that it has been rejuvenated. Entrenched meanders are shown by many streams. Plate XIV shows the entrenched meanders of the Conodoguinet River in Pennsylvania. Young valleys in the bottoms of old ones, and entrenched meanders, are among the more common marks of a second cycle of erosion.



FIG. 179.—Diagram to illustrate an ideal case of rejuvenation as the result of uplift. The black area at the bottom represents the sea.

**Ponding.** If a portion of the stream's bed is warped upward, the gradient above the point of up-warp is lessened, the flow is checked, and the stream widened. Streams above such an obstruction are *ponded*, that is, the waters accumulate in a pond or lake. If the up-warp is great enough, it may completely dam the stream. Streams are also sometimes ponded by lava-flows, by landslides, etc., and by dams made by man. The mill-ponds along

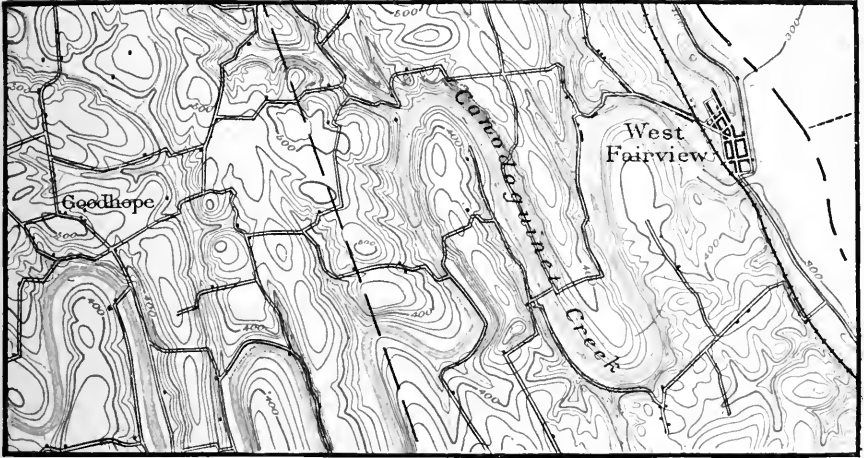

Entrenched meanders. Scale 1— mile per inch. (Harrisburg, Pa., Sheet, U. S. Geol. Surv.)



numerous creeks are illustrations of streams ponded in the last of these ways. If the ponded waters flow out over the dam, they will ultimately cut it down. If the dam is sufficiently high, the water



FIG. 180.—A rejuvenated stream, the Wisconsin River. The stream is large and swift, and flows through a young, narrow gorge, cut in the plain shown in Fig. 145.

may be forced out of its valley altogether and find a new course.

**Piracy.** One stream may steal another. One way in which this is done is suggested by Figs. 181 and 182. The head of a

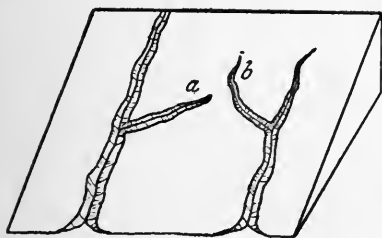

FIG. 181.

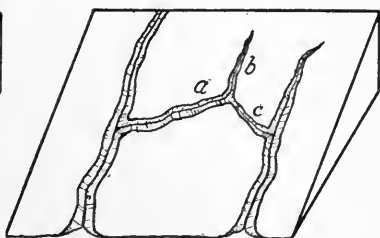

FIG. 182.

Diagrams to illustrate a phase of piracy. By the headward growth of *a*, Fig. 181, it reaches *b*, and carries off its upper waters. *a*, Fig. 182, is a pirate; *b*, Fig. 182, has been *diverted*, and *c* has been *beheaded*.

valley as at *a*, Fig. 181, may work back until it reaches the channel of another stream, such as *b*. It then carries off the water coming down to *b* (Fig. 182). The stealing of one stream by another is *stream piracy*. The stream which steals is a *pirate*. The stream

stolen is *diverted*, and the stream which has lost its upper waters is *beheaded*. When a stream is diverted from a narrows or water-gap, the latter becomes a *wind-gap*. Such gaps are common in most mountain regions.

The numerous wind-gaps of the Blue Ridge Mountains figured prominently in the westward movement and in the strategy of the Virginia campaigns of the Civil War. Farther south, the Cumberland Gap afforded the early emigrant the most available route across the mountains, and during the last quarter of the eighteenth century probably more than 300,000 people passed through it to settle in Kentucky and Tennessee.

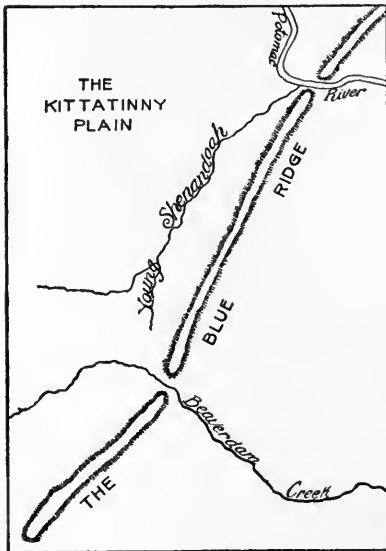

FIG. 183.



FIG. 184.

The capture of the head of Beaverdam Creek by the Shenandoah River. Virginia-West Virginia. (After Willis.)

Piracy has been much more common among rivers than is generally known. In the Appalachian region, for example, where the conditions for piracy have been favorable, there are few large streams which have not either increased their waters by piracy, or suffered loss by the piracy of others. Figs. 183 and 184 afford one illustration. Piracy is favored by inequalities of hardness, for the streams which do not cross hard rock deepen their channels more readily than those which do.



*Consequent and Antecedent Streams*

When streams develop on a land surface in harmony with its slope, they are said to be *consequent* (Fig. 185), that is, consequent on the slope of the surface in which they developed. After streams

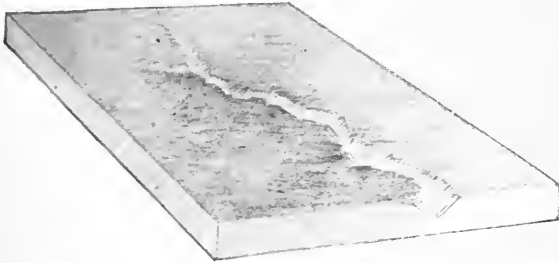

FIG. 185.—A consequent stream whose course is in harmony with that of the slope of the area it drains.

have established their courses, the land surface which they drain may be warped or deformed, but the deformation may go on so slowly that the streams are able to hold their courses established before it began (Fig. 186). The streams then have courses which they would not have taken had the deformation taken place before they were established. Such streams, with courses antedating the present general slope of the surface and out of harmony

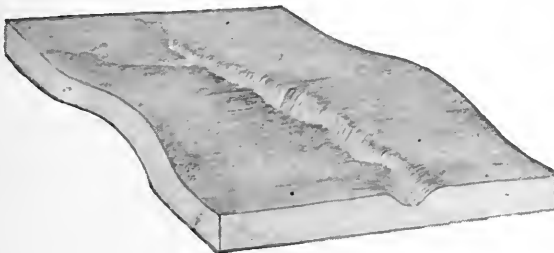

FIG. 186.—An antecedent stream. The stream and its valley are conceived to have developed as consequent stream and valley. An up-warp athwart the valley then took place, but so slowly that the stream cut down its bed as fast as the up-warp raised it, so that the stream held its old course, not now in harmony with the slope of the area drained.

with it, are *antecedent* streams. They may at the outset have been consequent, but they ceased to be consequent when the deformation took place.

## MAP EXERCISE

*Maps Showing the Topographic Effects of (1) Inequalities of Hardness, (2) Piracy, (3) Cycles of Erosion, etc.*

I. Study the following maps in preparation for the conference:

- |                             |                                  |
|-----------------------------|----------------------------------|
| 1. Niagara, N. Y.           | 7. Harpers Ferry, Va.—W. Va.—Md. |
| 2. London, Ky.              | 8. Monterey, Va.—W. Va.          |
| 3. Charleston, W. Va.       | 9. Kaaterskill, N. Y.            |
| 4. Tusculumbia, Mo.         | 10. Pawpaw, Md.—Pa.              |
| 5. Lancaster, Wis.—Ia.—Ill. | 11. Relay, Md.                   |
| 6. Independence, Kan.       | 12. Fredericksburg, Va.—Md.      |

II. Apply each of the following questions to each of the above maps:

1. The age of the topography in terms of erosion? Reasons? Are different parts of the area represented in different stages of topographic development?
2. Is more than one cycle of erosion shown? If so, the evidence?
3. Is there any indication of inequalities of hardness in the underlying rock? If so, what?
4. Is there anything in the topography to indicate the position of the strata beneath the region? If so, what?
5. What inferences can be made from the map as to (1) the climate, (2) the density of the population, and (3) the occupations of the people?

*Note.* In making inferences from the topographic map, the measure of certainty or uncertainty should be carefully recognized. Some inferences may be certain, some almost certain, some probable, some possible but not very probable, etc. The student should note to which of these classes each inference belongs.

III. Questions on individual maps:

*Monterey and Charleston Sheets.*

Compare and contrast (1) the topography and (2) the drainage of the two areas represented by these sheets.

*Lancaster Sheet.*

1. Account for the depression which extends between Sageville and Dubuque, in the southern part of the map.
2. What is the probable explanation of Sinsinawa and Sherrill mounds, in the southern part of the region?

*Kaaterskill Sheet.*

1. Find a case of piracy shown on the map.
2. Is there any chance for future piracy in this region?

3. The possible explanations of the steep slope in the eastern part of the area? The probable explanation?

*Pawpaw Sheet.*

1. How are the great meanders of the Potomac to be accounted for, in view of the fact that the valley is narrow?

*Harpers Ferry Sheet.*

1. What is the origin of Snickers Gap in the Blue Ridge?

*London Sheet.*

1. Account for the large depressions near Lincoln, in the southwest, and elsewhere.

*Relay Sheet.*

1. What indication is there of change of level in this region?

*Fredericksburg Sheet.*

1. Account for the peculiar character of the lower portions of Aquia Creek, Potomac Creek, Rappahannock River, etc.

#### DEPOSITION BY RUNNING WATER

We have seen that rivers carry mud, sand, gravel, etc., from land to sea, and that their goal is the degradation of the land nearly to the level of the sea. We have also seen that rivers do not always carry the sediment derived from the land directly to the sea. It is often dropped for a time on the land, perhaps to be picked up and carried on again when the conditions for its transportation are more favorable. We have now to inquire into (1) the causes which make running water drop some of its load, temporarily, at least; (2) the places where the material is abandoned; (3) the topographic features developed by the deposition of sediment; (4) the effect of deposition on the stream depositing it; and (5) the advantages and disadvantages of stream deposition to mankind.

#### *Causes of Deposition*

When running water drops its load, or any part of it, it is generally because the current has lost something of its velocity. We have already seen (p. 155) that gradient and volume are the most important factors in determining the velocity of a small stream.

1. *Loss of velocity.* The commonest cause of loss of velocity is decrease of slope or gradient. Running water may lose velocity (1) suddenly, as when it passes from a steep slope, whether of hill

or mountain, to a gentle one, or to a body of standing water, or (2) slowly, as in descending a valley the gradient of which becomes gradually less. We therefore look to the places where these changes in velocity occur for the principal deposits of running water. Streams also become slower wherever their channels become wider, if volumes and gradient remain constant.

A less common cause of decrease of velocity in a stream is

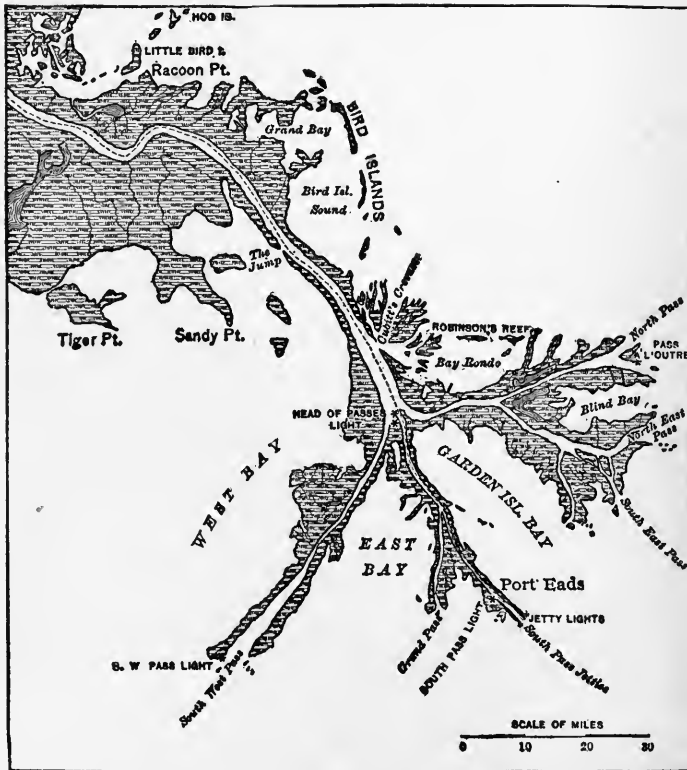

FIG. 187—The lower end of the Mississippi, showing its distributaries. (C. & G. Surv.)

decrease of volume. Streams generally increase in size with increasing distance from their sources, but to this general rule there are exceptions. (1) If a stream flows through a very dry region, it may receive few tributaries and few springs. Evaporation, on the other hand, is great, and some of the water may be absorbed by the thirsty soil and rock through which it flows. This is

especially the case if the ground-water surface (p. 85) of the region is below the level of the stream. In a dry region therefore a stream may diminish as it flows, and may even disappear altogether (Pls. VII and XV). (2) A stream sometimes breaks up into several streams (Fig. 187). The volume of each is less than that of the original stream. (3) Still again, many streams, especially in semi-arid regions, have much of their water withdrawn for purposes of irrigation. Many streams in the West are made smaller in this way. (4) Streams decrease in volume as their floods decline.

Increase of load makes running water flow more slowly; but a stream which is increasing its load by its own action is an eroding not a depositing stream. A stream may deposit coarse sediment and pick up fine in its stead, but in this case the amount of fine material which it picks up is usually greater than the amount of coarse which it leaves. Erosion is therefore greater than deposition, and a stream which erodes more than it deposits is not a depositing stream, as the term is commonly used.

2. *Excess of load from tributaries.* Tributary streams with high gradients may bring to their mains more sediment than the latter can carry away. This is an occasional cause of deposition in the channel of the main stream, especially where mountain torrents with high gradients join older streams which have reduced their channels to much lower gradients.

### *Location of Alluvial Deposits and their Topographic Forms*

The deposits made by running water are found principally in those situations where the flow of the water is checked or stopped.

1. **At the bases of steep slopes.** Every shower washes fine sediment down the slopes of the hills, and much of it is left at their bases. Fences in such situations are often buried, little by little, by the mud thus lodged. Temporary streams, bred of showers, sometimes flow down steep slopes, and are suddenly checked at their bases. Such streams gather much debris in their headlong courses down the slopes, but abandon it where their velocity is suddenly checked. Thus, at the lower end of every new-made gully on the hillside there is a mass of debris which was washed out of the gully itself (Figs. 107 and 188). Material in such

positions accumulate in the form of a partial cone, known as an *alluvial cone*. Alluvial cones have much in common with cones of talus; but in the former, gravity brings the material down by the help of water, while in the latter gravity brings the material down without the aid of water, or with but little help from it. Between talus cones and alluvial cones there are however all gradations.

Conspicuous alluvial cones are rather more common in semi-arid regions than elsewhere, if steep slopes are present; for in such regions the rainfall is fitful, and the occasional heavy showers, which give rise to temporary and powerful torrents, favor the de-



FIG. 188.—An alluvial cone. (U. S. Geol. Surv.)

velopment of cones of great size. Talus cones often have great development in the same regions. At the bases of the mountain ranges in the Great Basin the talus and alluvial cones from the mountains are sometimes 2000 or 3000 feet high.

An *alluvial fan* is the same as an alluvial cone, except that it has a lower angle of slope. The term *fan* is indeed more appropriate than *cone* for most alluvial accumulations at the bases of slopes. The lower angle of the fan may be due to the less abrupt change of slope where it is developed, to the larger quantity of water concerned in its deposition, to the smaller amount of detritus, or to its greater fineness. Less change of slope, more water, and less and finer material, all favor the wider distribution of the sediment, and so the development of fans rather than cones. Nearly all young rivers descending

from mountains build fans where they leave the mountains. Thus, the rivers descending from the Sierras to the great valley of California build great fans at the base of the mountain range. Most of the rivers descending from the Rockies to the plains to the east do the same thing. The fans of streams descending from the mountains are often many miles across. The fan of the Merced River in California, for example, has a radius of about 40 miles.

The fans made by neighboring streams often grow laterally until they merge. The union of several such fans makes a *compound alluvial fan*, or a *piedmont alluvial plain* (Pl. XV). Such plains exist at the bases of most considerable mountain ranges. The depth of alluvial material in such situations is often scores and sometimes hundreds of feet.

Alluvial cones and fans react on the course of the water which makes them. The loose debris of the cones and fans is capable of absorbing much water, and the water of even a considerable stream may sink into its fan (Pl. XV). Before it disappears, the stream is often divided into several smaller ones. This is because the sediment deposited by the stream in its channel makes the channel too small to hold all the water. Some of it therefore runs over (out of the channel) and makes a new channel for itself. The deposits which clog the channel may be the result of (1) diminished slope, and so diminished activity, or (2) diminished volume, due to absorption of water. The distributaries thus formed, being small, are likely to be slower than the stream from which they sprang, and so more likely to choke themselves. They therefore give rise to other and smaller distributaries. Thus the water of the main stream is likely to be spread about over its cone or fan, and the stream sometimes disappears.

Aside from well-developed fans and cones there is much sediment at the bases of slopes which are not steep. In such positions, however, the alluvium is often without distinct topographic form. Such accumulations at the bases of slopes are almost as wide-spread as the bases of slopes themselves.

Alluvial fans and piedmont alluvial plains are often valuable for agricultural purposes. In some parts of California, for example, the alluvial lands are so valuable that holdings are generally small and highly improved. Even in semi-arid regions they are often extensively cultivated, the water being supplied (1) by wells,

through which the debris of the fan is made to yield up the water it has absorbed, or (2) by irrigation ditches, which connect with



FIG. 189.—A branching stream. Junction of the Cooper and Yukon rivers, Alaska. Shows also bars, etc. (U. S. Geol. Surv.)

the stream farther up the valley, and lead the water out of its natural channel over the fan or plain (Fig. 200).

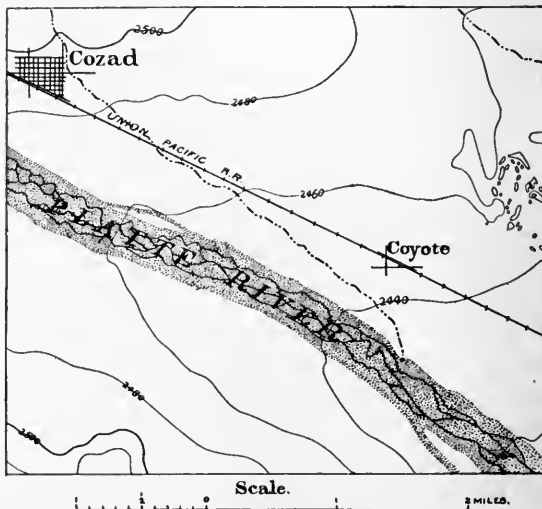
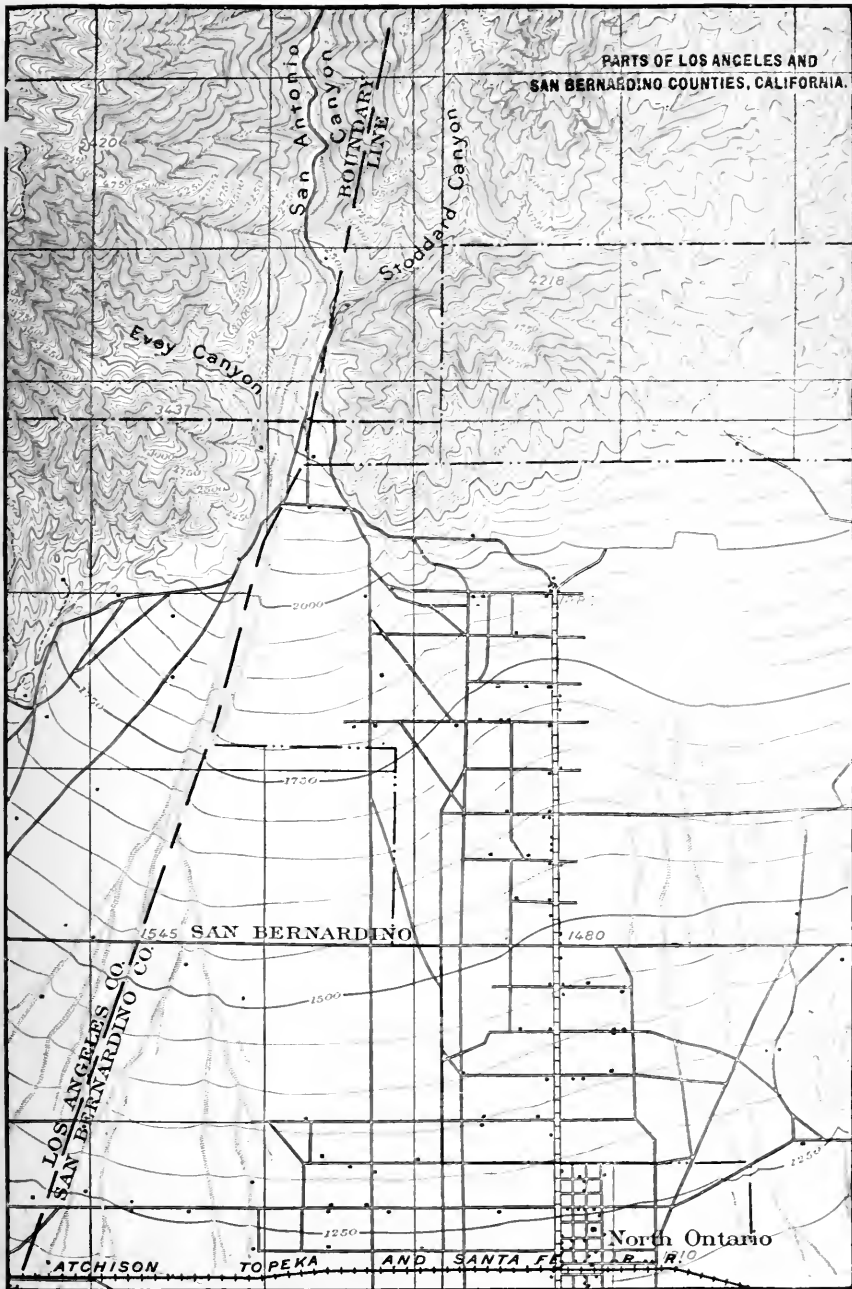

FIG. 190.—A braided river, Dawson Co., Neb. (U. S. Geol. Surv.)

2. In valley bottoms. A stream which makes deposits in its channel reduces the size of the channel. In time it may become





A piedmont alluvial plain or compound alluvial fan in Southern California. Scale 1—mille per inch. (Cucamonga Sheet, U. S. Geol. Surv.)

PLATE XVI

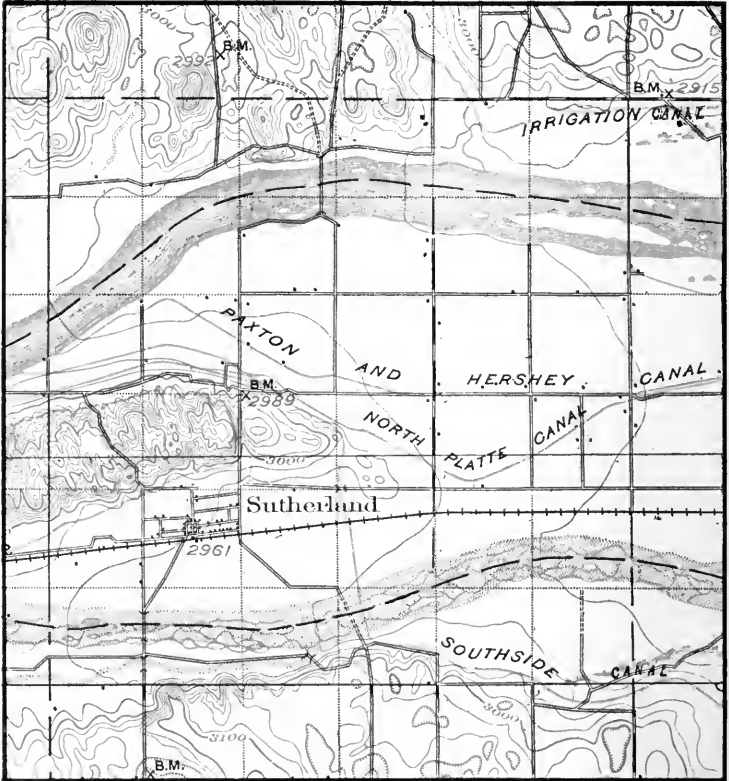

The alluvial plain of the Platte rivers in Nebraska. The South Platte is braided and the North Platte shows bars. The map also shows irrigating canals leading out from the river. Scale 2— miles per inch. (Paxton Sheet, U. S. Geol. Surv.)

too small to hold all the water. A part then breaks out, and follows a new course in the valley flat. This process may be repeated again and again (Figs. 189 and 190). The diverging stream may or may not return to the main. Those which do not return are called *distributary streams*. This term is sometimes applied also to all diverging streams, without reference to their return. The breaking up of a stream into parts may go so far, especially when the water is low, that there can hardly be said to be a main channel. The stream then becomes a network of minor streams, or a *braided stream*. The Platte River in Nebraska is an excellent example (Fig. 190). This condition exists only at low water.



FIG. 191.—Bars in river. The Yellowstone River, 34 miles south of Livingston, Mont.

At high water the entire flat through which the minor streams shown in Fig. 190 flow is covered by water, and becomes the bed of a single river (Pl. XVI).

Streams sometimes deposit sand-bars in their channels (Figs. 189 and 191), especially in low water, even when they do not become braided. These bars are obstacles to navigation, and are a constant source of embarrassment to river traffic in the low stages of many navigable streams. The bars deposited in low water are often swept away in times of flood, when the velocity of the

stream is greatly increased. Occasionally bars become more or less permanent islands. If they become covered with forests they are less easily eroded by the swift waters of floods, since the roots have a strong protective influence.

The profiles of most valleys are curves, the curvature becoming less and less steep as the lower end of the stream is approached (Fig. 192). It therefore happens that as a stream descends its

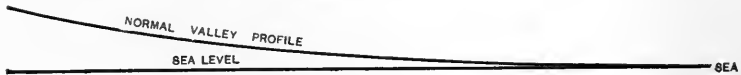

FIG. 192.—Profile of a normal valley.

valley it generally reaches a point where its reduced gradient so diminishes its velocity that it must abandon some of its load. In this way sediment is distributed for long distances along valley bottoms. It is left in the channels of the streams and spread over their flood plains, aggrading them and making them *alluvial plains*. Deposition in a valley which has no flat tends to develop one (Fig. 193).

Deposition on valley flats has but little effect on their topog-

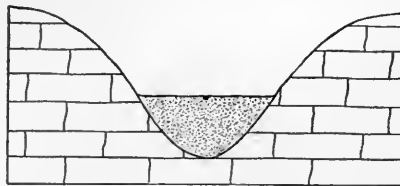

FIG. 193.—Flat developed by aggradation—diagrammatic.

raphy; but a few minor features deserve mention. Among them are *natural levees*. This term is applied to the low ridges on stream flats along the banks of the channel (Fig. 194). They are built



FIG. 194.—Levees of the Mississippi in cross-section, four miles north of Donaldsonville, La. Vertical scale  $\times 50$ . The horizontal line represents sea-level. The bottom of the channel is far below sea-level at this point.

in times of flood. At such times the current in the main channel is swift; but as the water escapes its channel and spreads over the adjacent flat, its velocity is checked promptly, because its depth

suddenly becomes less. It must therefore abandon much of its load then and there. Repeated deposition in this position gives rise to the levees. Natural levees are sometimes high enough and continuous enough to turn the courses of tributary streams. This is well illustrated by the Yazoo River of Mississippi, which flows some 200 miles in the flat of the Mississippi before being able to join it. Near Vicksburg the Mississippi swings over to the east side of the valley, and thus receives its tributary, which the levees have shut off. The early population of Louisiana

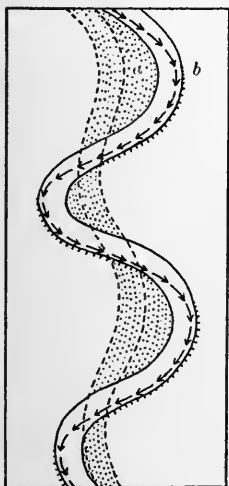

FIG. 195.

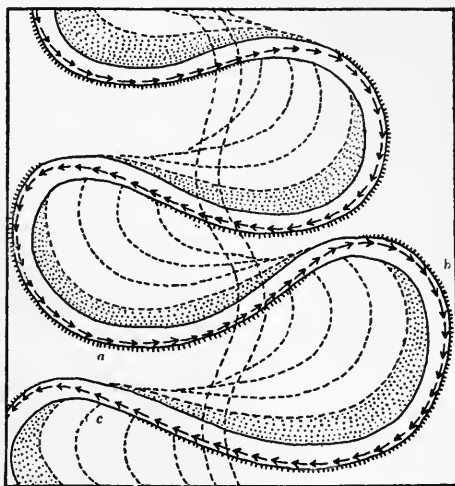

FIG. 196.

FIG. 195.—Diagram illustrating an early stage in the development of river meanders. The dotted area represents the area over which the stream has worked.

FIG. 196.—A later stage in the development of meanders.

and Mississippi was largely distributed in narrow belts along the levees of the Mississippi and its tributaries and distributaries. Here was the highest, driest land, of great fertility, fronting ready-made highways.

**Flood-plain meanders.** A stream with an alluvial plain is likely to meander widely (Pls. IX, X, and XI). In general terms this may be said to be the result of low velocity, which allows it to be turned aside easily. Were the course of such a stream made straight, it would soon become crooked again. The manner of change is illustrated by Figs. 195 and 196. If the banks be

less resistant at some points than at others, as is always the case, the stream will cut in at those points. If the configuration of the channel is such as to direct a current against a given point, *b* (Fig. 195), the result is the same, even without inequality of material. Once a curve in the bank is started, it is increased by the current which is directed into it. Furthermore, as the current issues from the curve, it impinges against the opposite bank and develops a

curve at that point. The water issuing from this curve develops another, and so on.

Once started, the curves or meanders tend to become more and more pronounced (Fig. 196). In the case represented by Fig. 1, Pl. IX, the narrow neck of land between curves is almost cut through. When this is accomplished, the stream will abandon its wide curve. A later stage in the process is shown in Fig. 2, Pl. IX (the Osage River near Schell, Mo.).

When the stream has cut off a meander, the abandoned part of the channel often remains unfilled with sediment. If it contains standing water, as it often does, it becomes the site of a lake (Fig. 197). Such lakes sometimes have the form of an ox-bow, and so are called *ox-bow lakes*

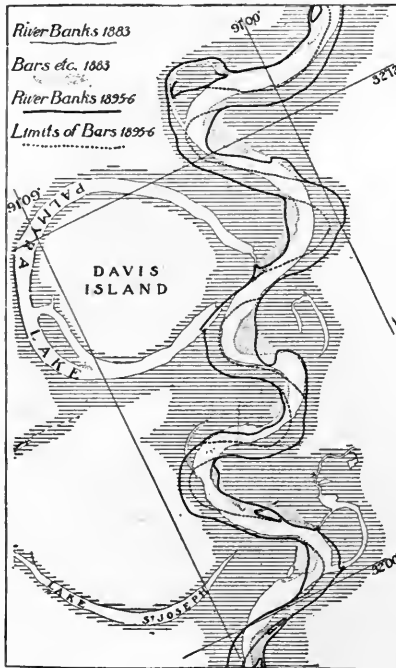

FIG. 197.—Meanders and cut-offs in the Mississippi Valley below Vicksburg. The figure shows the migration of the meanders down-stream and their tendency to increase in size.

(Pls. IX and X). They are also known as *bayous*.

In meandering, a stream sometimes reaches and undermines the valley bluff, thus widening its valley.

By the shifting of their courses, as the result of deposition and meandering, streams have affected human interests in many ways. Villages built on the banks of a stream because of the

river traffic which the situation favored have sometimes been abandoned by changes in the stream's course. Such villages usually decay when the stream has withdrawn its patronage. Some have been destroyed, while others have been preserved at great expense. Kaskaskia, the capital of Illinois until 1819, was situated on the flood plain of the Mississippi. In 1881 a change in the channel of the river converted the larger part of the village site into an island, the last vestige of which was washed away in 1899. Large sums have been expended by the National Government and by the Chicago and Alton Railway to keep the Missouri in its course



FIG. 198.—A cement-lined canal prepared for irrigation. Truckee-Carson project, Nev. The cement lining prevents free seepage. (U. S. Geol. Surv.)

at Glasgow, Mo. Again, streams are sometimes the boundaries between counties, and even states. In such cases the shifting of the stream would transfer territory from one state to another. To prevent this, complicated legal devices and complicated definitions of boundaries are sometimes resorted to. The case is still more serious where a river forms an international boundary. Thus the shifting of the Rio Grande makes that river an unsatisfactory boundary between the United States and Mexico.



FIG. 199.—An irrigating canal not cemented, before the water is turned in. Salt River Valley, Ariz. (U. S. Geol. Surv.)

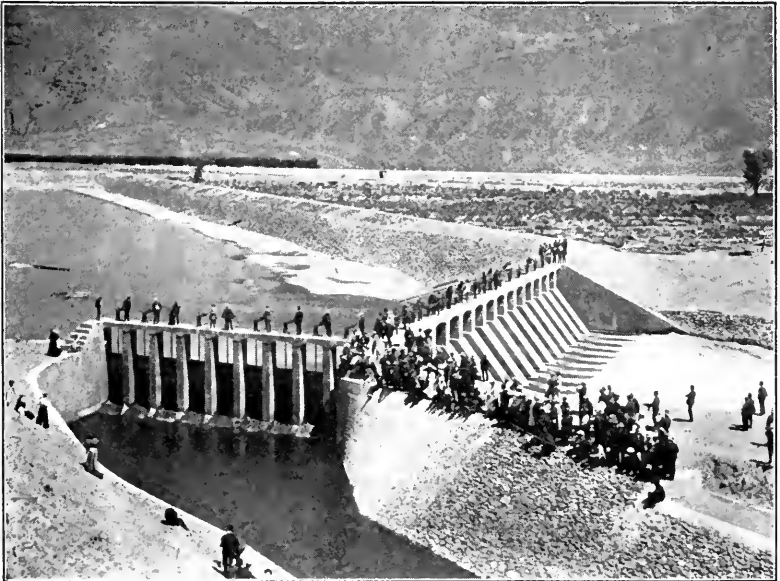

FIG. 200.—A diversion dam where the water of the stream is raised and turned into the canal. Truckee-Carson project, Nev. (U. S. Geol. Surv.)



**Fertility of alluvial plains.** Alluvial plains are often very fertile and are among the tracts most prized for agricultural purposes. This was as true in ancient times as now, for the valleys of the Nile, the Po, and of several of the rivers of southern Asia were the garden spots of ancient civilizations. The frequent deposits of silt and mud on such plains continually renew the soil and render it fertile. So strictly were the earlier civilizations confined to valley plains that the period antedating 800 B.C. has been called, with some propriety, the "fluvial period" of history. In America, valleys have been sought out for habitation from the



FIG. 201.—An irrigating canal filled with water. Salt River Valley, Ariz. (U. S. Geol. Surv.)

earliest times. In Virginia and Maryland early settlements were made in the valleys of the James and the Potomac; and in Pennsylvania, in the valleys of the Delaware, the Schuylkill, and the Susquehanna. In New York the principal settlements were long confined to the valleys of the Hudson and the Mohawk; and when the early settlements of Massachusetts began to spread beyond the coast, they occupied the Connecticut Valley.

Valley flats, as well as alluvial fans, are favorably situated for irrigation. Figs. 198 and 199 show irrigation canals or large ditches, Fig. 200 the beginning (head) of a canal, and Fig. 201 a canal filled



FIG. 202.—Fields prepared for irrigation by methods of squares. Las Cruces, N. M. (Photograph by Fairbanks.)

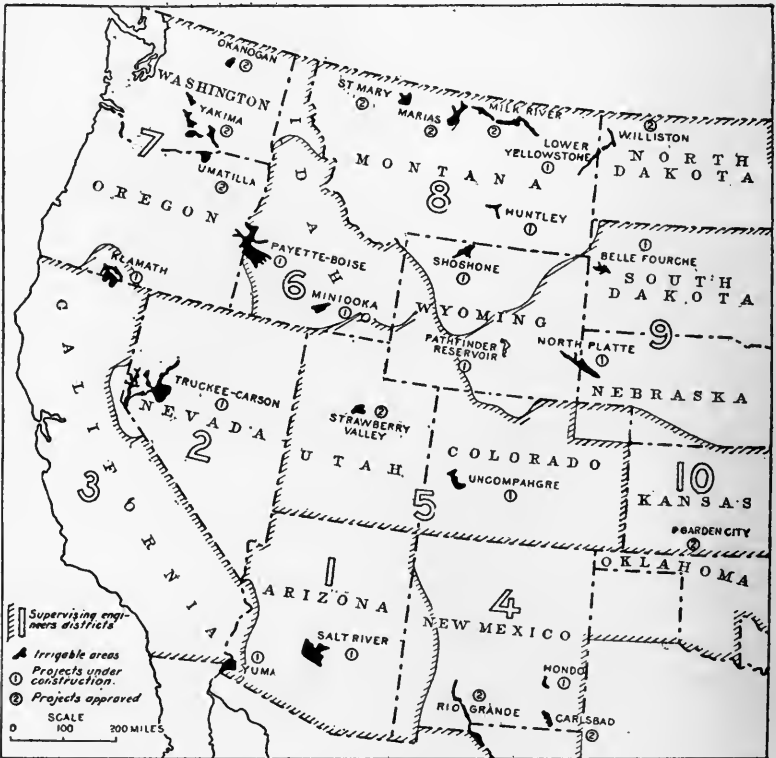

FIG. 203.—Map showing irrigation projects completed and under construction; spring, 1906. (Blanchard.)

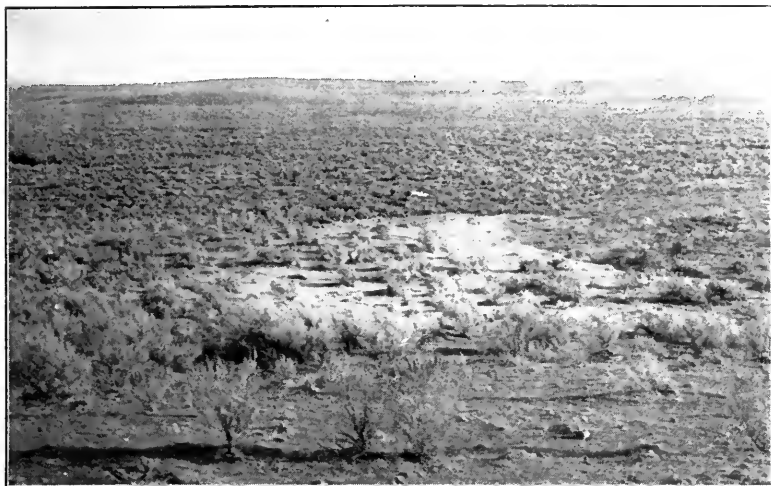

FIG. 204.—A type of the arid lands of the West before irrigation.  
(U. S. Geol. Surv.)



FIG. 205.—The same type of land shown in Fig. 204, after irrigation. Salt River Valley, Ariz. (U. S. Geol. Surv.)

with water. Fig. 202 shows a field prepared by ditching for irrigation. Water is drawn, as required, from the canals into the small ditches of the field. Great progress has already been made in the utilization of the arid lands in the western part of the United States. The lands thus utilized are largely in valleys and on plains adjacent to mountains. The general distribution of the irrigated and irrigable lands is shown in Fig. 203. The Government has undertaken the construction of many reservoirs in favorable sites in the mountains to hold the waters of the wet seasons, so that they may be drawn out and used on the lands below during the growing season. The sites selected for dams are usually narrow places in the valleys (Fig. 206).



FIG. 206.—Roosevelt dam site. Salt River project, Ariz.  
(U. S. Geol. Surv.)

**River floods.** Alluvial plains are, however, not without their drawbacks as agricultural regions, for the floods to which they are subject are often disastrous both to life and to property.

Terrible illustrations are afforded by the valleys of many great rivers. Thus in the spring of 1897 many thousand square miles of the flood plain of the Lower Mississippi were covered with water. It was estimated that 50,000 to 60,000 people suffered serious loss. In 1881 and 1882 the floods of the same stream and

of the Ohio are estimated to have caused a loss of \$15,000,000 and 138 lives. The losses occasioned by the floods of the Ohio alone were estimated at \$10,000,000 in 1884, and at \$40,000,000 in 1903. There was a disastrous flood in the valley of the Wabash and another in the valley of the Susquehanna in 1904, each causing the destruction of property to the extent of nearly \$10,000,000.

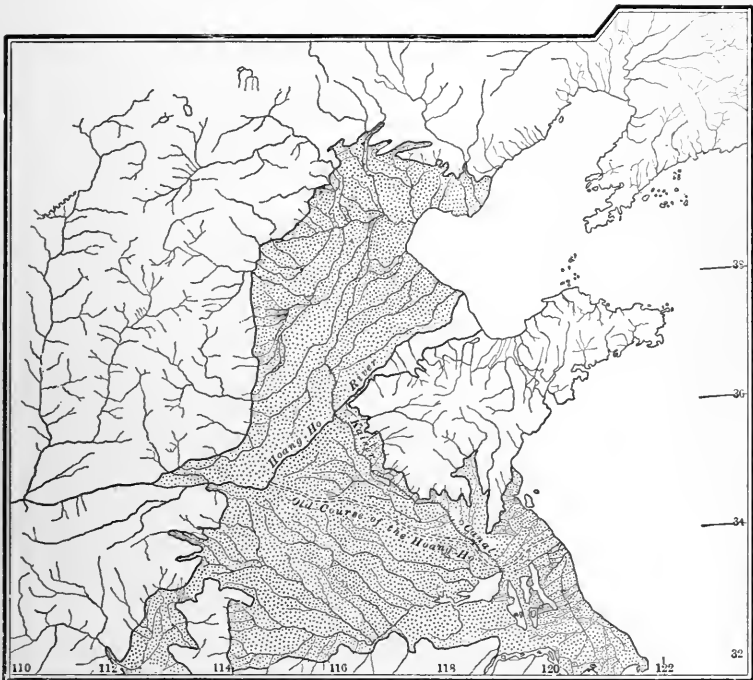

FIG. 207.—Diagram illustrating changes in the course of the Yellow River. The shaded area represents the area subject to flooding by the main stream and its tributaries. (Richthofen.)

Cities built on flood plains are also subject to great injury from floods. An exceptional flood of the Passaic River (N. J.) in 1902 is estimated to have destroyed millions of dollars' worth of property in the city of Paterson alone.

Disastrous floods occur from time to time in most great valleys. In 1885 a heavy rainfall of about 24 inches of water over an area of about 1000 square miles in the valley of the Ganges caused a disastrous flood. The volume of the river was greatly swollen, and

the water rushed down the valley with terrible velocity, undermining the banks, cutting new channels in the valley plain, sweeping



FIG. 208.—Delta of Lake St. Clair. (Lake Survey Chart.)

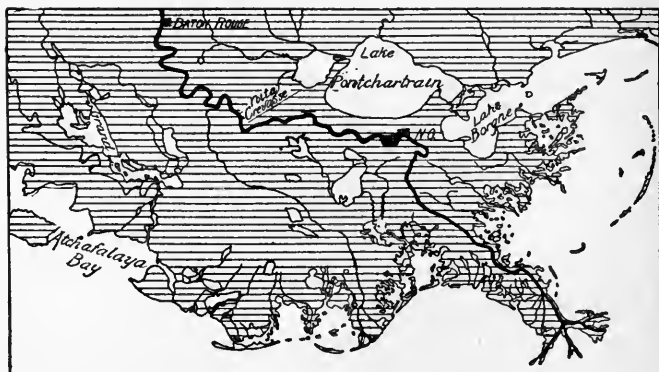

FIG. 209.—A general view of the lower part of the delta of the Mississippi.

away roads, ditches, bridges, aqueducts, retaining-walls, and even villages.

The most disastrous river floods recorded are those of the Hoang-ho or Yellow River of China. Previous to 1892, this river flowed into the Yellow Sea south of the Shan-tung promontory. In that year it shifted its course when in flood, and formed a new channel leading northwest into the Gulf of Pechili, 300 miles to the north (Fig. 207). Such changes in a stream's course are of much consequence to commerce.

The alluvial plains of some valleys are protected against flood by levees, or dykes. In such cases the natural levees are built higher by man, and the gaps in them are filled. They then protect the flat outside in ordinary floods; but extraordinary floods sometimes burst through the dykes, working great disaster. Some parts of the rich flood plain of the Mississippi which are used for agriculture are so subject to flood that all buildings connected with the farms are placed above the flat.

**3. At debouchures.** Where a swift stream flows into the sea or a lake, its current is promptly checked and soon destroyed alto-



FIG. 210.—Diagrammatic profile and section of an alluvial fan.

gether. Its load is accordingly dropped. If not washed away by waves, etc., the deposits of river-borne sediment in such places make *deltas* (Figs. 208 and 209).

The delta has some points in common with the alluvial fan. In both cases the principal deposit is concentrated at the point where the velocity is suddenly checked. In the case of the delta, however, the current is checked more completely, and the debris accumulates (at the outset) below the surface of the standing water. In form, the delta differs from the alluvial fan in that its edge has a steep slope (compare Figs. 210 and 211).

Once a delta is started below water, deposition takes place upon its surface, which may be built up to, and even above, the water-level. That part of the delta above the surface of the water in which it is built is like a flat alluvial fan.

Waves, currents, etc., may prevent the building of a delta, but otherwise all sediment-bearing streams make deltas at their debouchures. Deltas are sometimes built where one stream flows into



FIG. 211.—Diagrammatic profile and section of a delta.

another (Fig. 212). This is especially the case where a swift, debris-laden stream joins a slow one. Deltas built into rivers are usually of slight extent.

Much land has been made by delta-building. Thus the Colorado River has built a great delta many square miles (above water) in



FIG. 212.—Delta of the Chelan River built into the Columbia River, Wash. (Willis, U. S. Geol. Surv.)

area at the head of the Gulf of California (Fig. 213). The delta has been built quite across the gulf near its upper end, shutting off the head. In the arid climate of the region this shut-off head has become a nearly dry basin, the lowest part of which is about 300 feet below sea-level. The Skagit River, in Washington, has built out its delta so as to surround what were high islands in Puget Sound, thus joining them to the mainland. The deltas of the



Mississippi (Fig. 209), the Nile (Fig. 214), and the Hoang-ho rivers are among the large and well-known deltas. The united delta of the Ganges and Brahmaputra is also a great one, having an area (above water) of some 50,000 square miles. The Po has built a delta 14

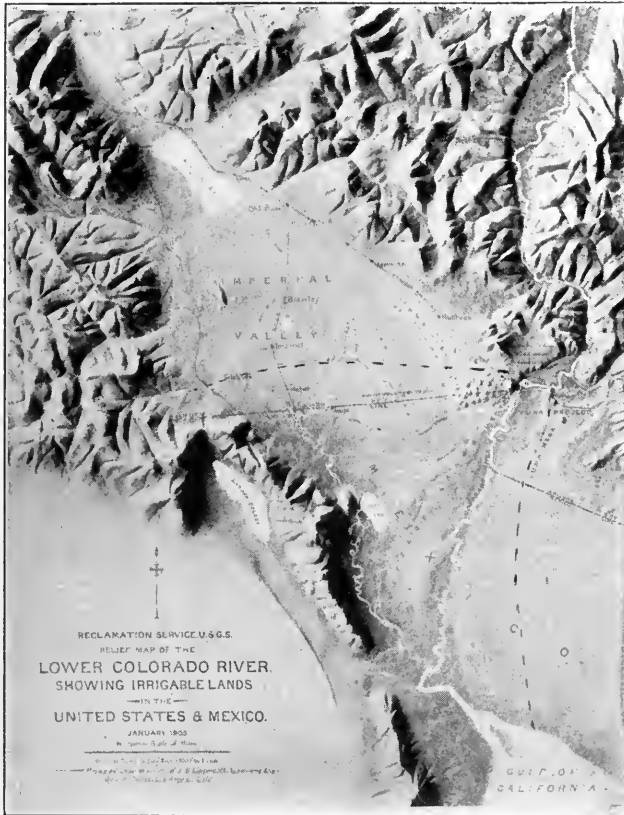

FIG. 213.—Relief map of an area about the head of the Gulf of California, showing the delta of the Colorado River, outlined in a general way by dotted lines. (U. S. Reclamation Service.)

miles beyond the former port of Adria, which gave its name to the Adriatic Sea. The Rhone River (France) has advanced its delta (Fig. 215) some 15 miles in as many centuries.

The borders of a delta are often difficult of determination. A delta is sometimes said to be limited up-stream by the point where the distributaries begin to be given off. This definition is

convenient, but arbitrary. It is less definite, but perhaps truer, to regard the up-stream border of the land reclaimed from the sea

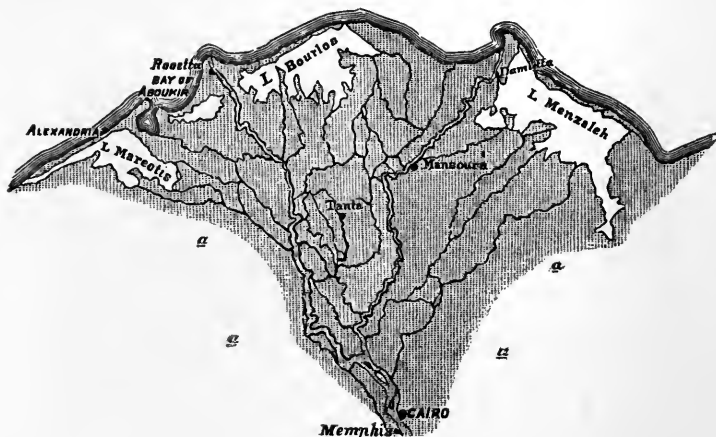

FIG. 214.—The delta of the Nile. (Prestwich.)

or lake by the river deposits, as the head of the delta. This definition would in many cases make the areas of deltas much greater than the other. On this basis, the head of the delta of the Mississippi, for example, would be near the mouth of the Ohio.



FIG. 215.—Delta of the Rhone River. (Prestwich.)

The effect of delta-building is to increase the area of the land; but it is to be noted that the processes which lead to delta-building

reduce the volume of the land-masses, even though they increase their area.

The outline of some deltas is determined by the surroundings in which they are built. When, for example, a delta is built into a bay, the form of the bay-head determines the shape of the delta. The normal form of a delta built on an open coast is somewhat semicircular, though there is often a fringe of *delta fingers* which together have some resemblance to the Greek letter  $\Delta$ , which gave these terminal deposits of streams their names.

The silting up of river mouths is sometimes disastrous to cities whose commerce is based on river trade. Thus the silting up



FIG. 216.—Delta of the Danube. (Prestwich.)

of the Tapti River was largely responsible for the decline of Surat, once the leading commercial centre of India. Between 1797 and 1847 its population declined from 800,000 to 80,000.

The surfaces of deltas are usually nearly plane, and the streams which cross them often give off distributaries, as the preceding figures show. These distributaries are subject to great and sudden changes of course, as well as to minor shiftings which are in progress all the time. These changes sometimes affect commerce in a vital way. Thus the site of Kásimbázár, in India, described as the "chief emporium of the Gangetic trade" early in the eighteenth century, is now a swamp as a result of a sudden change in the course of the Bhagirathi River (a distributary of the Ganges), on the banks of which it stood.

Many deltas are cultivated, and some of them, like that of the Hoang-ho, support dense populations. Delta lands are, however,



FIG. 217.—Terraces on the Fraser River at Lilloet, B. C.  
(Photograph by Calvin.)

subject to disastrous floods. It is estimated that the flood of the Hoang-ho River in September, 1887, drowned at least a million people who lived upon its delta, and caused the death of many

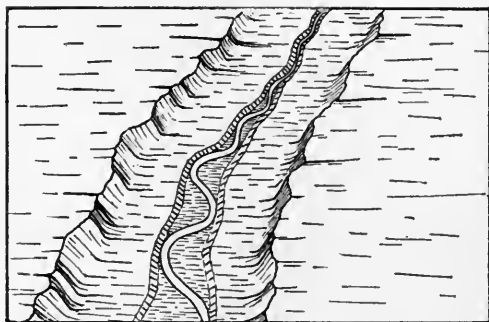

FIG. 218.—Diagram to illustrate the development of river terraces.

more by disease and famine afterward. Many villages were completely destroyed, and hundreds more were temporarily submerged.

**Ill-defined alluvium.** Alluvial deposits as a whole are widespread. A large part of the surface of the land is covered with a little alluvial material, though relatively small areas are deeply covered. Alluvial material is so disposed as to tend to even up slopes. Thus alluvial fans and cones tend to bring the steep slope above and the gentle slope below into harmony.

### *Alluvial Terraces*

When a river which has an alluvial flat is rejuvenated, the stream sinks its channel below the level of the flat (Fig. 179). The remnants of the old flood plain then constitute *alluvial terraces* (Figs. 217 and 218). Such terraces are also formed in other ways. Thus if a stream is temporarily supplied with an excess of load, it aggrades its valley (Fig. 193). If, later, the source of the excessive load is removed, the stream sets to work to remove that which was temporarily laid aside in its flood plain, even without rejuvenation. The more conspicuous alluvial terraces arise in some such ways. Many cities, such as Dubuque, Ia., Peoria, Ill., and Harrisburg, Pa., were begun on stream terraces, though they have now spread above them.

### MAP EXERCISES

*Topographic Maps and Coast Survey Charts Showing Stream Deposition, Terraces, etc.*

#### *List of Maps*

- |                        |   |
|------------------------|---|
| 1. Cucamonga, Cal.     | 6. Sacramento, Cal.                             |
| 2. Marshall, Mo.       | 7. Savanna, Ia.—Ill.                            |
| 3. Marseilles, Ill.    | 8. Mississippi River Chart No. 14. <sup>1</sup> |
| 4. Donaldsonville, La. | 9. Coast Survey Chart No. 19. <sup>2</sup>      |
| 5. Tacoma, Wash.       |   |

#### *Cucamonga Sheet.*

1. Of what kind of material are the uplands probably composed?
2. Of what kind of material are the lowlands composed?

<sup>1</sup> The Mississippi River charts can be had of the Mississippi River Commission, St. Louis. Catalogs and prices furnished on application to the Commission.

<sup>2</sup> The Coast Survey charts are published by the U. S. Coast and Geodetic Survey, Washington, D. C. Catalogs and prices furnished on application to the Director of that Survey.

3. Why do the contour lines in general curve out from the upland along the drainage lines?
4. Why are the outward curves of the contours in some instances notched backward toward the mountains along the immediate drainage lines?
5. Why are the streams intermittent on the lowlands?
6. Explain the peculiar manner in which the streams of waste divide.
7. What possible water-supply is there for the dense population of the lowland?

*Marshall Sheet.*

1. How is the extent to which the Missouri River has shifted its course in recent times shown?
2. What are the evidences that deposition is now in progress?
3. What probably determined the immediate location of Miami, Dewitt, and Brunswick?

*Marseilles Sheet.*

1. Interpret the flats upon which the town of Seneca and the Black Ash Swamp are situated.

*Donaldsonville Sheet.*

1. Explain the general distribution of the higher land.
2. What is the explanation of the alluvial deposits northeast of Colomb Park?
3. Note the relation of the minor streams to the main stream.
4. Note the location of common roads, railroads, and settlements.

*Tacoma Sheet.*

1. What phase of river work is the Puyallup River now performing?
2. What was the probable origin of the low marshy ground at the head of Commencement Bay?
3. Possible reasons why Wapato and Hylebo creeks flow independently to Commencement Bay instead of into Puyallup River?

*Sacramento Sheet.*

1. What was the probable origin of the plain covering the western half of this area?

*Savanna Sheet.*

1. Explain the lakes and swamps in the lowland.
2. What is the probable meaning of the abrupt slope east of Dyson Lake?
3. Is there any discrepancy (in stage of development) between the valley of the Mississippi and its tributaries?
4. Note the distribution of the common roads in the northern part of the area, and suggest the explanation.

*Mississippi River Chart No. 14.*

(Read carefully the note printed in red.)

1. What was the origin of Lake Chicot?
2. What changes have taken place at Bachelor's Bend since 1883?
3. Can you find evidence on the map that the meanders of the Mississippi are working down the valley?

## REFERENCES

1. CHAMBERLIN AND SALISBURY, *Geologic Processes*, Chapter III: Henry Holt & Co., 1903, and other standard text-books on Geology.
2. RUSSELL, *Rivers of North America*: G. P. Putnam's Sons, 1898.
3. SHALER, *Aspects of the Earth*, Chapters III and IV: Chas. Scribner's Sons, 1889.
4. GILBERT, *Geology of the Henry Mountains*, Chapter on *Land Sculpture*: Government Publication, 1877; Chapter on *Niagara Falls*, in *Physiography of the United States*: Am. Bk. Co., 1896; and *Physical History of Niagara River*: Am. Geol., Vol. XXVII, pp. 375-377.
5. CAMPBELL, *Drainage Modifications and their Interpretation*: Jour. of Geol., Vol. IV, 1896, pp. 567-581 and 657-678.
6. WILLIS, *The Northern Appalachians*, in *Physiography of the United States*: Am. Bk. Co., 1896.
7. HAYES, *The Southern Appalachians*, in *Physiography of the United States*: Am. Bk. Co., 1896; and *Physiography of the Chattanooga District*: 19th Ann. Rept. U. S. Geol. Surv., Pt. II, pp. 1-58.
8. DAVIS, *The Seine, the Meuse, and the Moselle*: Nat. Geog. Mag., Vol. VII, pp. 181-202 and 228-238; *Rivers and Valleys of Pennsylvania*: Nat. Geog. Mag., Vol. I, especially pp. 203-219; *Stream Contest along the Blue Ridge*: Bull. Geol. Soc. of Philadelphia, Vol. III, pp. 213-244; *Geographic Cycle in an Arid Climate*: Jour. Geol., Vol. XIII, p. 381; and *Development of River Meanders*: Geol. Mag., Vol. X, 1903.
9. DALY, *Accordance of Summit Levels among Alpine Mountains*: Jour. Geol., Vol. XII, p. 105.
10. WALCOTT, *Natural Bridge of Virginia*: Nat. Geog. Mag., Vol. V, 1893, pp. 59-62.
11. CLELAND, *North American Natural Bridges*, in Pop. Sci. Mo., May, 1911, and Bull. Geol. Soc. Am., Vol. XXI, pp. 313-338.
12. MERRILL, *Principles of Rock Weathering*: Jour. of Geol., Vol. IV, 1896, pp. 704-724 and 850-872; also *Rocks, Rock Weathering, and Soils*, Parts III, IV, and V: The Macmillan Co.
13. DUTTON, *Tertiary History of the Grand Canyon District*, especially Chapter III: Mono. II, U. S. Geol. Surv., 1882.
14. JOHNSON (L. C.), *The Nita Crevasse*: Bull. Geol. Soc. of Am., Vol. II, pp. 20-25, 1891.
15. GANNET, *The Flood of April, 1897, in the Lower Mississippi*. Scot. Geog. Mag., Vol. XIII, 1897, p. 419.

16. JEFFERSON, *Limiting Width of Meander Belts*: Nat. Geog. Mag., Vol. XIII, pp. 373-384.
17. TOWER, *Development of Cut-off Meanders*: Bull. Am. Geog. Soc., Vol. XXXVI, pp. 589-599.
18. DAVIS, *River Terraces in New England*: Bull. Mus. Comp. Zool., Geol. Ser., Vol. V, pp. 282-346, 1902.
19. DODGE, *The Geographical Development of Alluvial River Terraces*: Proc. Boston Soc. Nat. Hist., Vol. XXVI, pp. 257-273.
20. All standard text-books on geology.



## CHAPTER V

### THE WORK OF SNOW AND ICE

WE have seen that the atmosphere, the ground-water, and the waters on the surface of the land bring about important changes in its configuration. We are now to study the work of water in its solid form.

**Ice beneath the surface.** The wedge-work of ice in the crevices of rock has already been mentioned (p. 73). When the great areas where water freezes during some part of the year are considered, it appears that the aggregate effect of the freezing of water in the pores and crevices must be great in long periods of time. The water which freezes in the soil also has some effect on the surface. This is shown by the disturbance of the walls of buildings if their foundations do not go below the depth of freezing, and by the working up of stones and boulders through the soil, etc. The frozen water in the soil makes it solid temporarily, and so retards or prevents surface erosion, thus having a protective effect. The moisture rising from the soil, either by evaporation or by capillary action, sometimes freezes as it reaches the surface. There may be continued additions, from below, to the frost (ice) thus formed, resulting in the upward growth of ice, as shown in Fig. 219.

Snow, the most familiar form of ice, is more wide-spread than any other. Besides snow, the more familiar forms of ice appear on lakes, rivers, and the seas of high latitudes, and on the lands of high mountains or of high latitudes.

**The ice of lakes.** To understand the formation of ice on ponds and lakes, we may follow the changes which take place as the cold of winter comes on.

Fresh water is densest at a temperature of about 39° F. (about 4° C.). The surface water of ponds and lakes in middle

latitudes is usually much warmer than  $39^{\circ}$  in summer. The waters below the surface are generally cooler, but for some distance at least, and often to the bottom, they are warmer than  $39^{\circ}$  F. As the surface water cools in autumn and winter, it becomes heavier than the warmer water beneath, and slowly sinks. This process goes on, or tends to, until all the water from top to bottom has a temperature of about  $39^{\circ}$ . With further cooling the uppermost water expands slightly, and so becomes lighter and remains



FIG. 219.—Ice-crystals forming in the upper part of the soil grow by the addition of moisture rising from below. The ice added below pushes up the ice already formed. Columns of ice two or three inches in height are formed in this way, often raising small stones. (Photo. by Roberts.)

at the surface. When cooled to  $32^{\circ}$  F. ( $0^{\circ}$  C.), it freezes. In freezing it expands about one-tenth of its volume.

Deep lakes in middle latitudes, such as the Great Lakes of the United States, do not freeze over even in the coldest winters, for the body of the water of such lakes is not cooled to  $39^{\circ}$  F., and so long as their deeper parts have a temperature above  $39^{\circ}$ , the surface water sinks as it is cooled, and so does not reach the freezing temperature. Such lakes, therefore, freeze over only about their borders, where the water is so shallow that its temperature from top to bottom is reduced to the temperature of greatest density. Theoretically, this colder water near shore should spread to the

greater depths farther from shore; and it actually does move in this direction whenever it is heavier than that of greater depths, but the movement is often too slow to prevent the freezing.



FIG. 220.—Ice crowding on shore. Lake Mendota, Wis. (Buckley, Wis. Geol. Surv.)



FIG. 221.—Shore of Wall Lake, Iowa. (Photo. by Calvin.)

Like most other solids, ice contracts as its temperature is reduced. If the temperature falls notably after the lake or pond is frozen over, the ice, in contracting, pulls away from the shore

or cracks open, sometimes with loud, pistol-like reports. Water rises between the ice and the shore, or into the opened cracks,



FIG. 222.—A low terrace of gravel and sand formed by ice. Shore of Oconomowoc Lake, Wis. (Fenneman, Wis. Geol. Surv.)

and freezes, and the ice-cover again fits the lake. When the cold "spell" is over, the temperature of the ice rises, and the ice ex-



FIG. 223.—The shove of ice on the shore of Lake Mendota, Wis. (Photo. by Buckley.)

pands. The expanding ice may be crowded up on the shores, especially if their slopes be very gentle (Fig. 220), or bowed up

away from the shores. In the former case, sand, gravel, and bowlders frozen into the bottom of the ice are pushed up with it. Many



FIG. 224.—Shove of shore ice where the shore is marshy. The ice of the marsh is pushed up into ridges. (Buckley, Wis. Geol. Surv.)

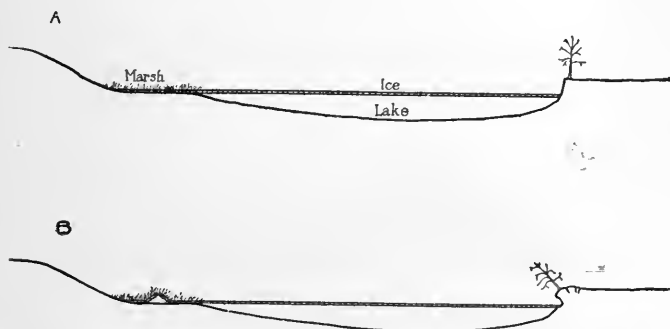

FIG. 225.—Diagram representing the effects of ice-shove on a marsh adjoining a lake, and on a high steep bank. It is to be remembered that the ground is frozen when the shove takes place, and therefore more resistant than when not frozen. The thrust must therefore be strong to produce the observed result.

“walled lakes” (Fig. 221), that is, lakes with accumulations of bowlders resembling walls about their shores, owe their peculiar

features to the shove of shore ice. Low terraces along shores, and low ridges are also made by the landward shove of the ice (Fig. 222). When the shore of the lake is steep and of loose earthy matter, the expanding ice sometimes crowds in under the soil, even overturning trees near the shore (Fig. 223).

The ice of a lake may be continuous laterally with the ice of the soil (Fig. 224), and in this case the shove of the ice, on expanding, may thrust up the frozen soil, making conspicuous ridges of it. Fig. 224 shows a ridge formed in this way on the shores of Lake Mendota near Madison, Wis., in the winter of 1898-9. The ridge here is chiefly of the ice of the marsh which bordered the lake at this point.

**Ice on the sea.** In high latitudes ice is formed along the sea-shore. Unlike fresh water, sea-water condenses till it freezes, at a temperature of  $26^{\circ}$  to  $28^{\circ}$  F. The variation in the temperature is due to the varying salinity of the water.

The ice crystals formed from sea-water are individually without salt; but a mass of ice formed from sea-water contains in-



FIG. 226.—Floe-ice on the shore of Greenland.

clusions of crystallized salt or of brine, excluded from the salt water as it froze. If large quantities of such ice be melted, the resulting water is more or less salty, though apart from these inclusions the ice is fresh. In polar regions the sea ice attains a depth of several feet, at least as much as eight or ten. Floating ice of much greater thickness is sometimes seen, but it is doubtful if these great thicknesses represent the ice formed by the freezing

of undisturbed sea-water. At any rate, the ice formed in winter is often broken up in the summer into floating pieces, *floe-ice* (Fig. 226), and the *floe-ice* is sometimes crowded together in *ice-packs*, the separate pieces being so jammed together that some of them are ended up and stand high above the water. If the *ice-pack* of one summer is still far enough north at the end of the warm season, it is frozen together, and its aggregate thickness, made up as it is of blocks of ice some of which are on edge, is far beyond that of normal sea ice.

**Ice-foot.** In high latitudes the snows along shore begin to accumulate in the autumn, before the sea-water freezes, and the water dashed up in storms freezes on and in the snow, converting it into ice. The first sea ice may be forced up on the land somewhat above normal sea-level by waves and tides, and it is thickened by the snow which lodges on it. In these ways the ice on the shore sometimes becomes very thick, with its upper edge many feet above sea-level. Such shore ice is known as an *ice-foot*. On the *ice-foot*, rock fragments broken off from cliffs above often gather in quantity. This protects the ice beneath from melting, and remnants of it may endure through the summer.

**Ice in rivers.** Rivers also freeze over in cold climates, and when the ice breaks up in the spring, stones and boulders to which it was frozen in the banks are sometimes floated miles down the river. Not only are boulders frozen into the ice floated away, but huge pieces are occasionally torn from points of rock which project into the river. At Montreal stone buildings 30 to 50 feet square, projecting so as to have river ice form about them, have been moved by the ice of the St. Lawrence.

When the river ice breaks up, masses of it may be carried down-stream, and may accumulate in vast fields or "jams" behind obstructions in the river. Where they are formed above bridges, the bridges are likely to be swept away. The jams also occasion disastrous floods above their sites, and when they break, the waters accumulated above may sweep down the valleys with destructive violence.

Northward-flowing rivers in the northern continents are especially subject to such floods. The snows of their upper basins often melt while the lower parts of the streams are still frozen over. The free discharge of the upper waters is thus prevented, and freshets result.

When frozen over, many rivers of northern latitudes serve as roadways.

**Ground-ice.** Ice sometimes forms on the bottoms of stony rivers where the current is swift. It ultimately freezes around the stones and boulders on the bed, and when enough of it freezes to them, they may be raised from the bottom and floated away. Ice sometimes forms in quantities on the bottom (or below the surface) of shallow seas, such as the Gulf of St. Lawrence and the Baltic Sea. Ice thus formed is called *ground-ice* or sometimes *anchor-ice*. Small vessels are said to be occasionally surrounded and entrapped by the sudden appearance of large quantities of this ice at the surface.

Ground-ice in rivers seems to be due (1) sometimes to the fact that the bed of the stream is frozen, and the water in contact with it freezes; and (2) sometimes to the fact that, though the temperature of the river as a whole is slightly below 32° F., the greater motion of the upper and swifter part keeps the water there from freezing, while the quieter water below congeals.

The cause of the development of ice on the bottom of shallow seas is not clear. The suggestions made above as to the cause of river-bottom ice do not seem applicable. It may be that fresh-water springs issuing into sea-water which is below 32° F., but above the freezing temperature of salt water, sometimes freeze before being thoroughly mixed with the salt water. The ice formed about anchors is probably sometimes the result of the low temperature of the anchor before it was lowered. Ice due to this cause would not, however, endure long.

**Snow.** When the moisture in the air condenses at a temperature of less than 32° F., it commonly takes the form of snowflakes (Fig. 76). Snowflakes are not frozen rain-drops; they are formed instead of rain-drops when the temperature at which the water vapor condenses in the air is below the freezing-point.

Snow falls in high latitudes during much of the year, and in middle latitudes during the winter season. Except on high mountains, little falls in low latitudes, and the little that does fall generally melts quickly. The period of snowfall and the duration of the period when snow lies on the surface increase both with increasing altitude and latitude, so that above the polar circles most of the precipitation falls as snow, and snow lies on most of the land surface all the time, even at low levels. The same is



true in very high altitudes, even in tropical latitudes. In such situations, indeed, the snowfall of the cold summer is often much greater than that of the winter.

While snow lies on the surface, it serves to protect it. It shields the vegetation beneath from excessive changes of temperature, and especially from the repeated thawings (by day) and freezings (by night) which are injurious to many plants, and it keeps the dust and sand beneath from being blown about by the wind. The conditions which preserve the snow also prevent the effective wear of the surface by running water, so long as the snow is on the ground.



FIG. 227.—Mt. Hood, a snow-capped mountain. (By permission of Lipman, Wolfe & Co.)

**Snow-fields.** Where snow endures from year to year over any considerable area, it constitutes a *snow-field*. Snow-fields are widely distributed. Stated in general terms, they occur in mountains in nearly all latitudes, but the altitude which is necessary in the equatorial region is great (15,000 to 18,000 feet), that in the temperate region less, and that in the polar regions slight. In the polar regions, indeed, snow-fields occur even down to sea-level. Stated in other terms, snow-fields occur in sufficiently high altitudes in any latitude, and at any altitude in sufficiently high latitudes.

Snow-fields are by no means rare in the United States. They occur in the high mountains of California, Colorado, and Utah (rare), and in the high mountains of all the states farther north (Fig. 227). The snow-fields of the more northerly states are more numerous and on the whole larger than those farther south. In the mountains north of the United States they are still more extensive, and in Alaska some of them attain considerable size (Fig. 228).

Small snow-fields also occur in the high mountains of Mexico and South America. They occur in the Alps, the Pyrenees, the Caucasus, and the Scandinavian mountains of Europe, and in the



FIG. 228.—Snow-fields in the Skolai Range of Alaska. Chisana glacier in the foreground. (U. S. Geol. Surv.)

Himalayas and the higher mountains of the regions farther north and northeast in Asia. They occur also in Africa, even very near the equator, though they are small and limited to very high mountains. Besides these and other small fields of snow and ice, there are two great fields in Greenland and Antarctica. The snow-and-ice field of Greenland contains much more snow and ice than all the mountain snow-fields mentioned above, and that of Antarctica contains probably several times as much as that of all other fields together.

It is not improbable that there are as much as a million cubic miles of snow and ice now on the land. If this amount of ice were all melted and returned to the sea, it would raise its level about 30 feet.

**The snow-line.** The line above which the snows of winter are not all melted is the *snow-line*. The snow-line may fluctuate

somewhat from year to year, but during any given period, historically speaking, it is relatively constant. Its average position for a period of years should perhaps be regarded as the snow-line for that period.

1. The position of the snow-line is influenced by *temperature*. This is shown by the general fact that it is higher in lower (warmer) latitudes and lower in higher (colder); but in various mountains, the Himalayas for example, the snow-line is much higher on the north side than on the south, although the temperature on the south side is higher than that on the north. It is therefore evident that *something besides temperature is involved in the position of the snow-line*.

2. An additional factor is the *amount of snowfall*. The southerly winds blowing over the Himalayas carry much more moisture than the northerly ones. The result is that the fall of snow on the southern slope is much heavier than that on the northern. The same is true in the mountains of Switzerland. The position of the snow-line is therefore influenced by the *amount of snowfall* as well as by the temperature. Six inches of snow on the colder north slope of mountains (northern hemisphere) may disappear in the fewer melting days of summer, while as many feet of snow on the warmer south slope may not disappear during the longer period of melting in that position.

3. Again, snow does not disappear entirely by melting. Some of it *evaporates*, and aridity favors evaporation. A snow-field in a dry region is therefore wasted more by evaporation than one in a humid region. Wind increases evaporation if the air is dry.

4. *Topographic relations* also affect the position of the snow-line in a given place, for some situations favor accumulation and afford protection against the sun.

(1) Temperature and (2) amount of snowfall are the principal factors which determine the position of the snow-line, and (3) humidity (or aridity) and (4) topographic relations are minor factors. Since these factors vary from place to place, no particular altitude in any particular latitude can be specified as the one necessary for the existence of perennial snow.

The following table shows the position of the snow-line at a few points:

Bolivian Andes, west side,	Near equator,	About 18,500 feet.
Bolivian Andes, east side,	Near equator,	About 16,000 feet.
Chilean Andes,	Lat. 33° S.,	About 12,800 feet.
Mexico,		About 14,800 feet.
Teneriffe,	Lat. 33° N.,	About 13,000 feet.
Himalayas, north side,	Lat. about 28° N.,	About 16,700 feet.
Himalayas, south side,	Lat. about 28° N.,	About 13,000 feet.
Caucasus Mountains,	Lat. 40° + N.,	About 8300 to 14,000 feet.
Pyrenees Mountains,	Lat. 40° + N.,	About 6500 feet.
Alps,	Lat. about 46½° N.,	About 9000 feet.
Norway,		About 5000 feet.
Lapland,	Lat. 70° N.,	About 3000 feet.
Alaska,		About 5500 feet.
Greenland,	Lat. 60°-70° N.,	About 2200 feet.

**Ice-fields.** Every considerable snow-field is also an ice-field, for where snow accumulates to great depths and lies long upon the surface, the greater part of it is converted into ice. The beginning of this change is seen in the snow which has lain for a few days at the surface. It loses its flaky character and becomes coarse-grained, so that it is harsh to the touch. The change is still more conspicuous in the last banks of snow in the spring. The snow of such banks is made up of coarse granules, often of considerable size. The change of the flakes into granules is a process which is due, in part, to the melting of the surface snow and the sinking and re-freezing of the water below the surface; but since the change appears to go on even where there is no melting, melting and re-freezing are probably only a part of the process of change.

While this transformation is going on, the snow becomes more compact. As it lies on the surface, its own weight tends to compress it. The sinking water which re-freezes below the surface tends to bind the granules to one another, and as a result of the compression, of the transformation of the flakes into granules, and of the binding together of the granules themselves by the freezing of water between them, the whole mass tends to become solid. Just how solid and how dense snow must become before it is to be called ice, cannot be stated; but every great snow-field is really an ice-field, scarcely more than frosted over with snow. The last snow-banks of spring are often essentially ice.

## GLACIERS.

If the body of ice developed from snow becomes great enough, it begins to spread or creep out from its place of accumulation. Ice thus moving is *glacier ice*. Not all snow-fields give origin to glaciers, but nearly all glaciers have their sources in snow-fields. The distribution of glaciers is therefore much the same as the distribution of snow-fields.

**Types of glaciers.** Glaciers assume various shapes, depending chiefly on the amount of ice and on the configuration of the surface on which it lies. If the originating snow-field lies on the slope of a mountain, the ice moves down the slope; and if a valley



FIG. 229.—Summit of the Nizina-Tanana glacier, Alaska.  
(Rohn, U. S. Geol. Surv.)

leads out from the area of the snow-field, the movement of the ice is chiefly concentrated in the valley. If the ice lies on a flat surface, it spreads in all directions from its centre.

Glaciers which occupy valleys are called *valley glaciers*. In common speech, “a glacier” is usually understood to be a valley glacier. All valley glaciers are sometimes called *alpine glaciers*, because they belong to the same general class as those of the Alps; but the valley glaciers of high latitudes differ in some ways, especially in their steeper sides and ends, from those of the Alps. For this reason, valley glaciers may be classed as *alpine* (Fig. 230) and *high-latitude* (Fig. 231) glaciers.

In high latitudes glacier ice sometimes lies on plains or plateaus. In such positions glaciers may be nearly circular in outline, and may



FIG. 230.—The Rhone glacier. (Photo. by Reid.)



FIG. 231.—The end of the Bryant glacier, a high-latitude glacier of North Greenland. (Photo. by Chamberlin.)

spread radially from their centres. Such glaciers are *ice-caps* or *ice-sheets*. Ice-caps may be large or small. The main ice-caps of Antarctica and Greenland (Figs. 252 and 259) are large, but



FIG. 232.—A small ice-cap in the northwestern part of Iceland. (After Thoradssen.)



FIG. 233.—A cliff glacier, coast of North Greenland. The height of the cliff is perhaps 2000 feet. The water in the foreground is the sea.

small ones of the same type are found on various promontories along the coast of Greenland, on Iceland (Fig. 232), and on some Arctic islands.

Glaciers sometimes occur at the bases of mountains, being formed by the union of the spreading ends of valley glaciers. Such glaciers are  *piedmont glaciers*  (Fig. 260). Again, many snow-fields nestled in the depressions of mountain cliffs give origin to small glaciers which never descend to a valley. Such ill-formed and poorly developed glaciers are  *cliff glaciers*  (Fig. 233). Cliff glaciers grade into valley glaciers (Figs. 234 and 235). Ice broken



FIG. 234.—Glaciers intermediate in type between a cliff glacier and a valley glacier. Cascade Mts., Wash. (Willis, U. S. Geol. Surv.)

off from ice-sheets, or from valley glaciers which reach a cliff, may accumulate below, freeze together again, and assume movement. Such a glacier is sometimes called a  *reconstructed glacier* .

Of these types, valley glaciers are most common and familiar, but ice-caps contain far more ice. The leading characteristics of glaciers may be studied in connection with the most familiar form.



*The Valley Glacier*

The general form of a valley glacier (Fig. 236) is determined by the shape of the valley in which it lies. If the valley is crooked, the glacier curves to match it, and if the bottom of the valley is uneven, the surface of the ice is more or less uneven, in keeping with it. The valley glacier has sometimes been called a "river of



FIG. 235.—Dana glacier, Mt. Dana, Cal. A glacier of the same type as that shown in Fig. 234.

ice," but the differences between a glacier and a river are so much greater than their likenesses that this definition is misleading.

**The surface.** The upper end of a valley glacier is in the snowfield, and is covered with snow all the time, while the lower end may be covered during the winter. Some glaciers carry so much stony and earthy debris on their surfaces as to conceal the ice in some places, especially near the lower end.

The centre of a valley glacier is usually higher than its sides, so that its upper surface is generally somewhat convex in cross-section. The profile of the surface of a glacier corresponds somewhat to the profile of the bottom of the valley in which it lies (Figs. 230 and 236), as already noted, but its slope is sometimes

notably increased near its lower end, because of the steep slope of the upper surface of the ice.

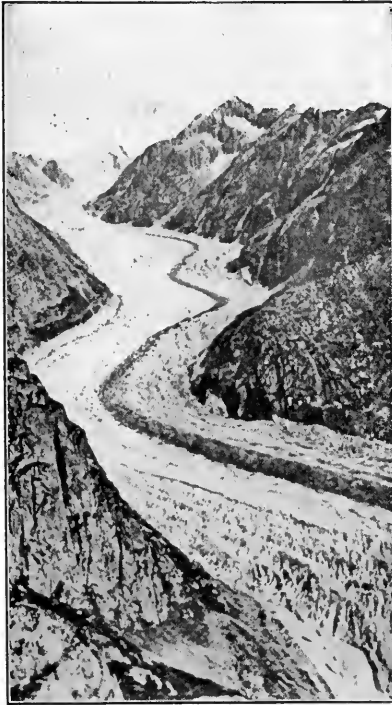

FIG. 236.—Aletsch glacier, Switzerland.

The surface of the glacier is often uneven. In many cases it is cracked, and the cracks or *crevasses* frequently gape. A principal cause of the crevasses is the movement of the brittle ice over an uneven bed (Fig. 238). When the slope of a glacier bed increases suddenly, an *ice cascade* is developed (Figs. 230 and 237); but an ice cascade has little in common with the rapids or falls of rivers. Crevasses formed by the passage of ice over a steep place in its bed are usually transverse to the glacier. Crevasses are sometimes parallel to the sides of the glacier and oblique to them, and such crevasses are due to other causes. The breaking of the ice as it moves is one of the

many features wherein a glacier differs from a river.

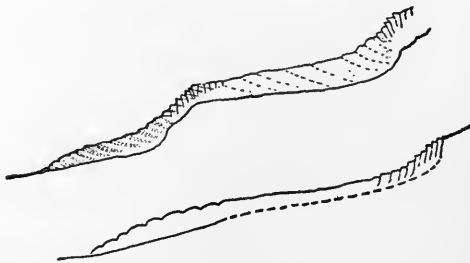

FIG. 237.—Diagrammatic and longitudinal sections of glaciers. (After Heim.)

As the ice moves forward, the crevasses sometimes tend to close, though they rarely heal in such a way as to leave the surface

of the ice smooth. So long as a crevasse is open, the sun's rays and the sun-warmed air enter it and melt the ice. The effect of the melting is to widen the crevasse, especially its upper part.



FIG. 238.—Crevassed glacier, the cracking due to change in grade of bed. North Greenland.

The result is that when the movement tends to close the crevasse, the opposing faces rarely fit together. This is illustrated by Figs.



FIG. 239.—Crevassing in the upper part of a glacier on Mt. Hood, Ore. (Meyers.)

240 and 241. The crevassing and the subsequent melting are therefore a cause of unevenness of surface.

Another cause of surface irregularity is the drainage from the surface. The valley glacier often extends far below the snow line, and is within the region of active melting during the summer season. Some of the surface water sinks beneath the surface,

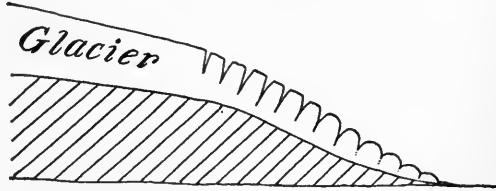

FIG. 240.—Diagram to illustrate one reason why ice crevasses fail to heal as explained in text.

but some of it runs in little streams on the ice until it reaches a crevasse or the edge of the glacier. These surface streams wear notable channels (valleys) in the ice (Fig. 242), which, though rarely deep, help to destroy the smoothness of the surface.

The stony and earthy debris which many valley glaciers carry on their surfaces also gives rise to irregularities. The large stones

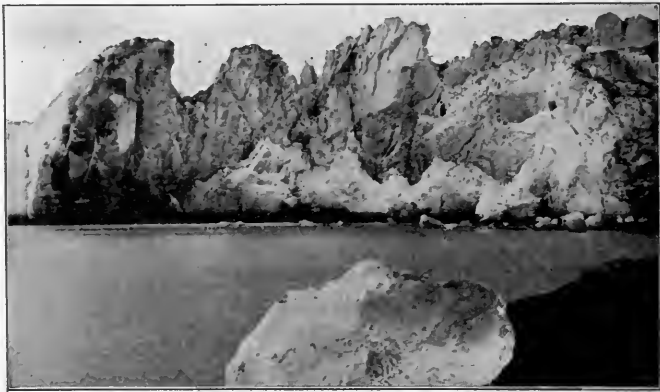

FIG. 241.—Seracs of glaciers. (Photo. by Reid.)

protect the ice beneath from melting, and therefore come to stand on pedestals of ice, as the unprotected ice about them is melted away. Considerable aggregations of debris of any sort have the same effect, by protecting the ice beneath from melting, thus giving rise to mounds or ridges of ice covered with debris

(Fig. 243). Small or thin stones on the surface of the ice affect its

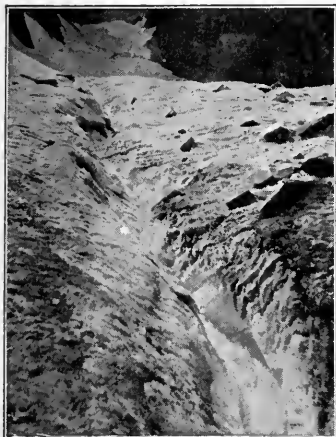

FIG. 242.—Valley of a superglacial stream in the Bighorn Mts. (Photo. by Blackwelder.)

topography in the opposite way. Rock absorbs heat better than the ice does, and thin pieces of rock are warmed through. They may then melt their way into the ice more rapidly than the sun melts down the surface about them, thus making depressions in the ice. Patches of dust blown on the ice have the same effect. The depressions to which they give rise are known as "dust-wells" (Fig. 245). Dust-wells are sometimes so close together that one must watch his steps in walking over the ice. Their depths depend upon their diameters and the angle of the sun's rays (Fig.

246). Their bottoms do not descend below the plane where the sun's rays strike the heat-absorbing sediment. Dust-wells are



FIG. 243.—Boulders on ice pinnacles. Forno glacier, Switzerland. (Photo. by Reid.)

usually full of water at the end of a warm (melting temperature)

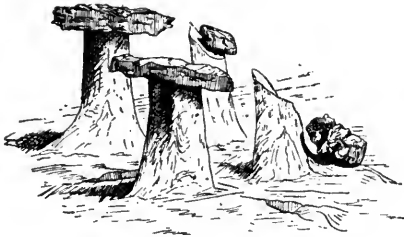

FIG. 243a.

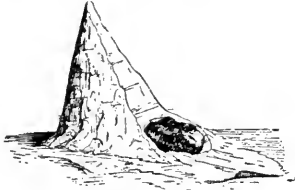

FIG. 243b.

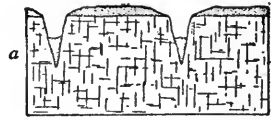

FIG. 244.

FIG. 243a.—Ice columns capped by slabs of rock, on Parker Creek glacier, California. (U. S. Geol. Surv.)

FIG. 243b.—An ice pyramid on Mt. Lyell glacier, California. The protecting stone has fallen from the column, which has since melted into the pyramidal form. (U. S. Geol. Surv.)

FIG. 244.—Diagram to show how debris on ice gives rise to prominences. (Gilbert.)

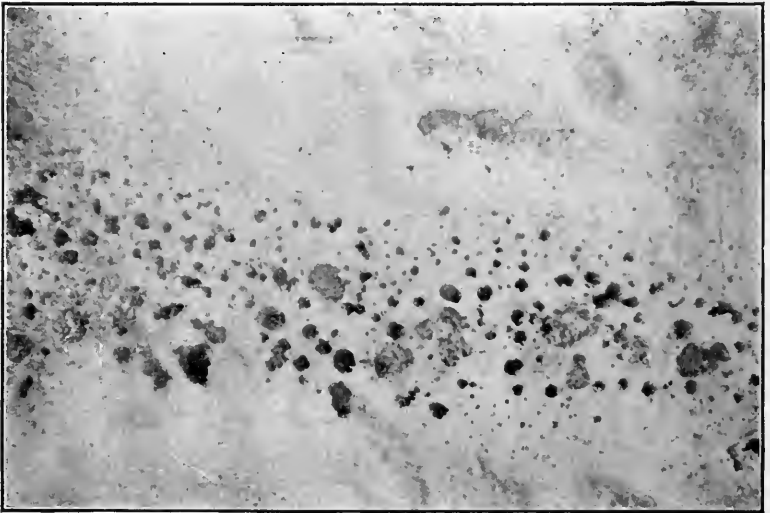

FIG. 245.—Dust-wells, North Greenland. (Photo. by Chamberlin.)

day, but the water usually drains out at night. This drainage shows that the glacier ice is, on the whole, very leaky. Depressions resembling dust-wells, and of the same origin, sometimes develop on the compact surface of snow which has lain for some time on the ground.

### *Movement*

**Waste and supply of ice.** The ice of a glacier is continually wasting. The waste is due partly to surface melting, especially in summer, partly to melting below the surface, for much of the

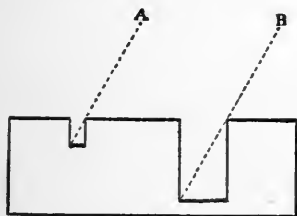

FIG. 246.

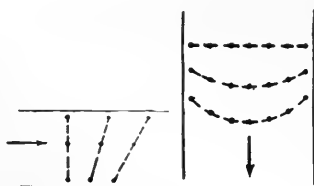

FIG. 247.

FIG. 246.—Diagram to illustrate the fact that wells of larger diameter may be deeper than those of smaller diameter. The slanting lines represent the direction of the sun's rays when the sun is highest.

FIG. 247.—Diagram illustrating certain features of glacier motion. The figure at the left represents a vertical section, and the top as moving faster than the bottom. The figure at the right represents a part of the surface, and the central part as moving faster than the sides.

subsurface ice of most glaciers is at the melting temperature much of the time, and partly to evaporation.

In spite of the rapid waste of glaciers, particularly at their lower ends and in summer, they often remain nearly constant in size for long periods of time. This shows that there must be a source of supply to replace the waste. This source is found in the snow-fields. From them the ice creeps down the valleys until it reaches an altitude so low and so warm that the waste (chiefly melting) at its end balances its forward motion.

The fact of movement was first established by noting (1) that the ends of glaciers were sometimes farther down the valleys than they had been at earlier times, and (2) that familiar objects at the ends of glaciers were overturned and pushed forward by the ice.

**Rate of movement.** Once the fact of movement was established, various means were devised for measuring its rate. Rows

of stakes were set across a glacier in a straight line, and their positions with reference to fixed points on the sides of the valley marked. After a time they were found to have moved down the valley. In most cases it appears that those in the central part of the glacier have moved faster than others, as shown by Fig. 247.

In this and in other similar ways the rate of movement of numerous glaciers has been determined. It ranges from an amount so small as to be measured with difficulty, to several feet per day. One very large glacier in north Greenland has been estimated to move 100 feet per day, but this is certainly far beyond the rate for any of the more accessible and better-known glaciers. Few of the better-known mountain-valley glaciers move more than a foot or two a day.

**Conditions affecting rate of movement.** The rate of glacier movement appears to depend chiefly on (1) the depth of the moving ice; (2) the slope of the surface over which it moves; (3) the slope of the upper surface of the ice; (4) the topography of the bed over which it passes; (5) the temperature; (6) the amount of water in the ice, including that which falls upon it or is carried to it by the drainage of its surroundings, as well as that produced by the melting of the glacier itself; and (7) the amount of load (debris) which the ice carries, especially in its bottom. Great thickness, a steep slope, smoothness of bed, a high (for ice) temperature, and much water favor rapid movement. Since some of these conditions, notably temperature and amount of water, vary with the season, the rate of movement for any given glacier is not constant throughout the year, and is generally greater in summer than in winter. Other conditions, especially the first of those mentioned above, vary through longer periods of time, and occasion periodic variations in the rate of movement.

#### MAP EXERCISE

##### *Topographic Maps Showing Glaciers*

Study the following maps showing existing glaciers, in preparation for conference:

1. Shasta, Cal.
2. Mt. Lyell, Cal.
3. Mt. Stuart, Wash.
4. Glacier Peak, Wash.
5. Cloud Peak, Wyo.



In each note (*a*) the altitude of the glaciers, (*b*) their size, and (*c*) their exposure (on east, west, north, or south slopes).

Is there any relation between the heights of (*a*) the lower, and (*b*) the upper ends of the glaciers, and the exposures?

Compare the heights of the lower ends of the glaciers in California, Washington, and Wyoming. Why the differences?

Note the peculiar shape of the upper ends of many of the valleys shown on the Cloud Peak Sheet, for example that of the South Fork of Clear Creek. Such valley heads are *cirques*, and cirques generally indicate the former existence of glaciers.

**Nature of glacier movement.** Glacier movement has been much discussed, but no general agreement concerning its nature



FIG. 248.—The spreading end of a glacier, North Greenland.

has been reached. From the fact that the ice moves down the valley, conforming to it somewhat as a river does to its valley, it has been thought that a glacier flows like a stiff liquid. This idea seemed at first to be supported by the fact that when a glacier moves out from its mountain valley to the plain beyond, it generally spreads (Fig. 248), somewhat as a stiff liquid might. It is to be noted, however, that the spreading or *deploying* end cracks open. In further support of this explanation of glacier motion, various experiments have been performed upon ice. They show that a bar of ice may be bent or moulded into almost any desired

form, if it be subjected to sufficient pressure, applied slowly enough through long periods of time.

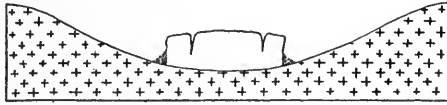

FIG. 249.—Diagram to show relations of a high-latitude glacier to its valley walls.

But in spite of the apparent mobility of ice, and in spite of the fact that in so many ways its motion seems to resemble that of a stiff liquid, it is very doubtful if its real motion is one of flowage, as that term is ordinarily understood. It has already been stated that the ice often cracks open when it passes over irregularities of bed, as well as under some other circumstances. Cracking open is not a characteristic of liquids. Many glaciers of high latitudes do not rest against the sides of the valleys in which they lie (Figs. 249 and 250). Such glaciers are often crevassed longitudinally, and the crevasses sometimes have great length. If the ice flows, therefore, it must be supposed to flow until it cracks open. It is not evident that a fluid, however viscous, would do this. These and many other considerations, which will not be detailed here, have led to the view that the resemblance between glacier motion and the motion of a stiff liquid is more seeming than real.



FIG. 250.—A part of the vertical side of a North Greenland glacier. The vertical or even overhanging faces are sometimes more than 100 feet high.

The fundamental element in glacier motion probably consists in the melting and re-freezing of its substance. The process is a very complex one, and cannot be fully analyzed here, but some of its elements may be stated.

When water from the surface sinks into the glacier and freezes

again it expands, and the ice where the freezing takes place is subject to great stress. The force of the stress which freezing water exerts is illustrated by the familiar fact that vessels of very considerable strength are broken when water freezes in them. The freezing of the water which has descended must have the effect of moving the ice, and the movement must be chiefly down the valley, for in this direction gravity helps, while in the opposite direction it hinders. Furthermore, the water before re-freezing moves, and always downward, not only toward the bottom of the ice, but often, at least, toward the lower end of the valley as well. The *flow of the water* is therefore a way of *transferring the ice* of the glacier down-valley.

There are causes of melting and re-freezing other than those which are dependent upon the direct influence of the sun or the heat of the interior of the earth. These are bound up with the movement of the ice itself, and, without attempting here to explain the principle involved, it may be stated that it is now believed that an important part of glacier motion is to be explained by the melting which results from the pressure involved in motion, and in the re-freezing of the water thus produced. It is believed therefore that though the aggregate motion of a glacier is in a way comparable to the motion of a viscous body, the actual motion is probably that of a solid, small parts of which frequently pass from a solid to a liquid condition for brief spaces of time.

Another element of glacier motion is sliding, for parts of a glacier sometimes slide or *shear* over other parts (Fig. 251). The motion of the lower portion of a glacier which carries much debris is greatly retarded by its load. The relatively clean ice above the bottom moves less slowly, and appears very often to be thrust forward or *sheared* over the debris-laden portion below. This phase of motion is probably much more common and of much more consequence than was formerly supposed. It is best seen in the glaciers of high latitudes, where the vertical edges and ends allow the structure of the ice to be well seen. Under some conditions a glacier may probably slide over its bed. Sliding is not, however, believed to be a principal element in glacier motion.

**Size.** There are in the Alps nearly 2000 glaciers. The longest of them is about 10 miles long. Less than 40 are as much as five miles long, and the great majority are less than one mile in length. Some of them are but a few hundred feet wide, and few of them

are so much as a mile wide. The thickness of ice is rarely known, except at the lower ends, but it is generally to be measured by hundreds of feet, rather than by denominations of a higher order.

Larger alpine glaciers occur in the Caucasus Mountains of Europe and in Alaska. Seward Glacier in Alaska is more than 50 miles long, and 3 miles wide at the narrowest part. The glaciers of the western mountains of the United States (south of Alaska) are mostly shorter than the longer glaciers of the Alps. Many

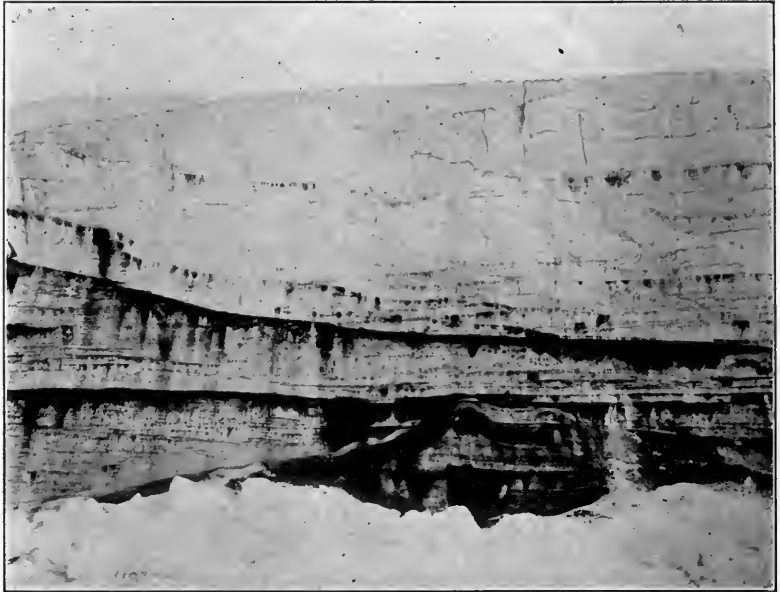

FIG. 251.—Shearing planes in ice, well defined.

of them are indeed cliff glaciers, or intermediate in type between valley glaciers and cliff glaciers (Figs. 234 and 235).

#### *Ice-caps*

Ice-caps lie on plains or plateaus instead of occupying mountain valleys. As already stated, they may be large or small. Large ones may cover valleys and hills alike. Very large ones are sometimes called *continental glaciers*. At the present time the ice-caps of Greenland and Antarctica are the only ones which attain great size.

The area of Greenland has been variously estimated at from 400,000 to 600,000 square miles, and all of it, except its borders, is covered with a vast field of snow and ice (Fig. 252). Near its margin, occasional mountain tops project above the snow, and here its surface carries some debris; but, except about its



FIG. 252.—Map showing the ice-cap of Greenland. Only the borders of the island are free of ice.

edge, nothing is visible, so far as known, through the entire island, save one vast plateau of snow-covered ice. The surface snow is frequently driven by the wind into rolling billows. The snow- and ice-covered plateau rises gradually toward the centre of the island, where it attains an elevation of 8000 or 9000 feet. The thickness of the ice is not known, but where thickest it is probably some thousands of feet.

The ice of this great field is creeping slowly outward. The rate of movement has not been determined and is probably not



FIG. 253.—Edge of the Greenland ice-sheet.

the same at all points; but it has been estimated not to exceed a foot a week. Near its margin the ice-cap is much crevassed;



FIG. 254.—A mountain projecting up through the ice, North Greenland.

but the interior is comparatively smooth and unbroken, so far as now known.

The ice-cap of Greenland is, in one sense, more of a desert



FIG. 255.—A *nunatak* projecting up through a Greenland glacier.



FIG. 256.—Three small glaciers descending to the sea, North Greenland.



FIG. 257.—Front of Miles glacier, Alaska, where it reaches Copper River.  
(U. S. Geol. Surv.)



FIG. 257a.—Glacier and Icebergs.



FIG. 258.—Iceberg, coast of Greenland.



than the Sahara, since it is inhabited, even less than that desert, by plants and animals. There are, it is true, tiny red plants upon it at various points about its border. Taken singly, they are too small to be readily noticed, but they sometimes occur in such multitudes as to give the snow a distinctly red color, known as "red snow." Occasional small animals, especially the larvas of

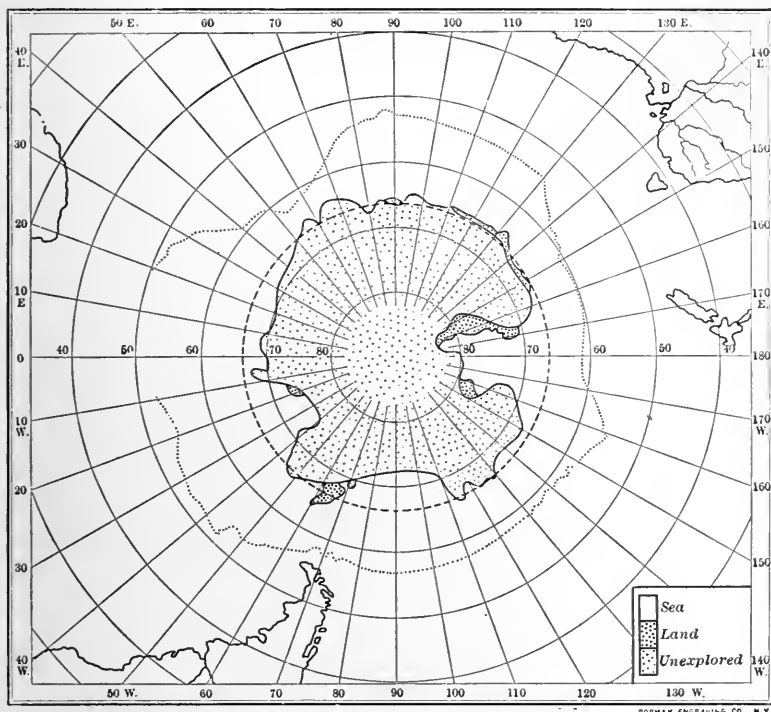

FIG. 259.—Map of Antarctica. The dotted line represents the approximate limit of abundant floating ice. (After Bartholomew.)

certain insects, are also found on the snow some little distance at least back from its margin.

Where the edge of the Greenland ice-cap lies back a few miles from the coast, the rock plateau outside it is affected by numerous valleys which lead down to the sea. Where the edge of the ice-cap reaches the heads of these valleys, ice moves down them in advance of the edge of the ice-cap, making valley glaciers. Many of the valley glaciers move down to the sea, where their ends are

broken off (Fig. 256) and floated away as icebergs. Many of these glaciers are far larger than any of the Swiss glaciers, and some are even larger than the great Seward Glacier of Alaska. While their number is very large, the total amount of ice in them is trivial compared with the amount in the one great ice-cap glacier from which they originate.

The Antarctic snow- and ice-cap is far more extensive than that of Greenland, but its area is not even approximately known (Fig. 259). It appears to be some millions of square miles in extent, but mountains project up through it, as determined by the Shackleton expedition. At many points the ice descends to sea, where huge blocks of it are broken off and floated away as icebergs. Whether this Antarctic ice-cap rests on a continuous land-mass which if free from ice would be called a continent, or whether it rests on numerous islands which but for the ice would be separated by shallow water, is not known.

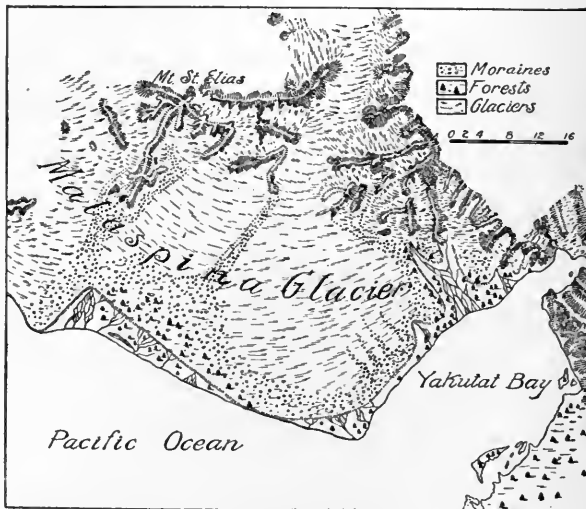

FIG. 260.—Malaspina glacier, a piedmont glacier in Alaska. (After Russell.)

### *Piedmont Glaciers.*

In Alaska a number of large alpine glaciers emerge from adjacent valleys of the St. Elias range upon a low plain, where their ends spread and unite to form a vast plateau of ice, 70 miles long

and 20 to 25 miles wide. This peculiar body of ice is the *Malaspina Glacier* (Fig. 260). Its area is considerably more than that of the state of Delaware. Its central portion is free from rock debris, but is interrupted by thousands of crevasses. On warm summer days hundreds of rivulets flow in channels of clear ice until they lose themselves in yawning crevasses. The deep roar of some stream in its tunnel far below the surface is frequently heard. Nearer the margin, where the ice is not so broken, there are many small ponds with high walls of ice. A belt along the margin five miles or less in width is covered by earthy matter and is



FIG. 261.—Forest on the southern border of Malaspina glacier.  
(Photo. by Russell.)

densely forested (Fig. 261). The undergrowth is here so thick that travelers have to cut their paths, and on the edge of the ice there are trees three feet in diameter. The forest extends four or five miles from the edge of the ice. The ice beneath the surface debris is probably 1000 feet thick. Another large but unexplored glacier of the same type lies a few miles west of the Malaspina. Others occur about north Greenland.

Piedmont glaciers are of slight importance, from a quantitative point of view, but they constitute an interesting type.

## THE WORK OF GLACIERS.

Glaciers do a twofold work. They wear or *erode* the surface over which they pass, and they carry away and ultimately *deposit* the material which they acquire by erosion, as well as all that falls or blows upon them.

**Erosion.** As the snow-field develops, it often lies upon a surface which is uneven and more or less covered with loose pieces of rock (Figs. 72 and 274). As the snow accumulates, all projecting



FIG. 262.—Surface of rock rounded and smoothed by ice. Bronx Park New York City. (U. S. Geol. Surv.)

stones are covered and enclosed by it, and, when the snow becomes ice and begins to move, these masses of rock are carried along in its bottom. The ice therefore has some load when it starts.

Where the snow and ice accumulate about projecting points of bed-rock, the ice tends to break them off when it moves. If they are too strong to be broken off bodily, their surfaces are worn by the passage of the ice carrying rock debris in its bottom. Again, as a glacier creeps out over surfaces covered with soil or other mantle rock, the ice freezes to the soil, etc.; that is, the ice above the ground becomes continuous with the ice in the soil. This union is brought about, in part at least, by the freezing of descending water. When this has been done, further movement causes more or less of the soil to be moved along.

The first effects of the glacier therefore are (1) to clean off the loose debris from the surface, and (2) to break or wear off

projecting points of the bed-rock over which it passes. The general effect of the movement of the ice may be compared to



FIG. 263.—Ice-worn rock, Bell's Island, Lake Huron. (Bell.)

the effect of a flexible rasp which fits itself, though sometimes with difficulty, to the irregularities of the surface over which it moves.



FIG. 264.—Diagram representing a hill unworn by ice, and the irregular contact of soil and rock.



FIG. 265.—Diagram showing the effect of glacial wear on a hill such as is shown in Fig. 264.

Clean ice, moving over smooth, solid rock, would erode little; but rock-shod ice wears the surface over which it moves, even where that surface is smooth, solid rock.

An ice-sheet glacier is generally much thicker than a valley glacier, and it generally moves over a surface which has less slope.



FIG. 266.—A mountain valley which has been strongly glaciated, Wasatch Mountains. (Photo. by Church.)

An ice-sheet of great thickness may move over considerable hills and valleys, without being notably turned from its course by



FIG. 267.—A mountain valley in the same range as the last, but not glaciated. (Photo. by Church.)

them. The hills and projecting points of rock overridden are worn down and smoothed off (compare Figs. 264 and 265), the wear being greatest on the side of the hill against which the ice moves. The

result is that glacial erosion sometimes so shapes the rock hills that their forms indicate the direction of movement.



FIG. 268.—A normally eroded mountain mass not affected by glaciation. (Davis.)



FIG. 269.—The same mountain mass shown in Fig. 268 affected by glaciers which still occupy its valleys. (Davis.)

Valleys through which glaciers pass are widened and deepened and their walls made smoother. Valley glaciers tend to trans-

form V-shaped valleys into U-shaped ones, a result often conspicuous in mountain regions (Figs. 266 and 271). Where a

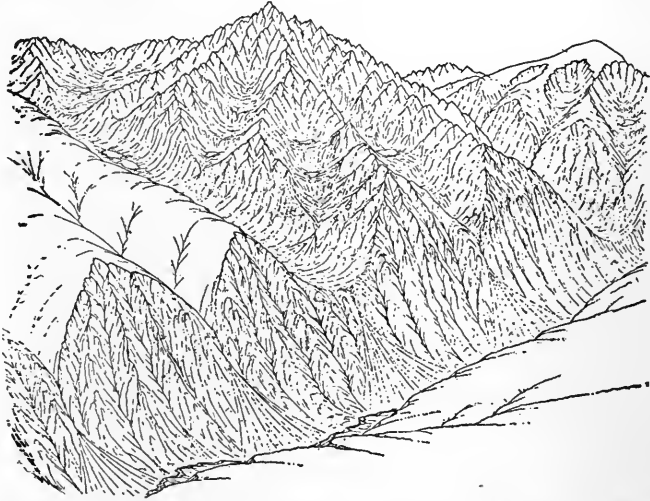

FIG. 270.—The same mountain mass shown in the two preceding figures after the ice has melted. (Davis.)

glacier deepens a mountain valley notably, it brings about a lack of adjustment between the valley which is deepened, and its tribu-



FIG. 271.—A hanging valley near Lake Kootenay. (Photo. by Atwood.)

taries which are not so deepened. The effect is illustrated by Figs. 270 and 271. The lower ends of the tributary valleys are well above the bottoms of their mains. Such valleys are called



*hanging valleys.* Hanging valleys abound in the mountains of the West, where glaciers were formerly much more extensive than

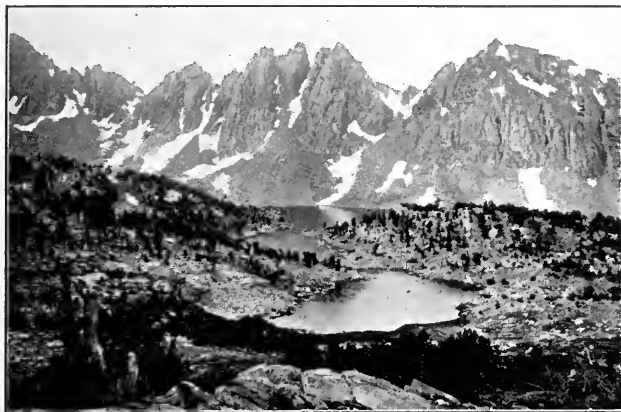

FIG. 272.—Figure showing contrast between glaciated rock surface below and non-glaciated crests above. Kearsarge Pinnacles, Bubbs Creek Canyon, Cal.



FIG. 273.—A glacial cirque with a small glacier in its head. Bighorn Mts. Wyo. (Photo. by Blackwelder.)

now. Valley glaciers descending to the sea sometimes deepen the the lower ends of their valleys so that they become narrow bays or

*fjords*, when the ice melts. Glacier erosion is not, however, the only factor in fjord-making (p. 173).



FIG. 274.—A glacial cirque north of Grizzly Peak, Colo. (Photo. by Hole.)

Fig. 237 shows that there is often a steep descent of a mountain glacier near its head. This steep slope, and especially its lower part, is the site of great erosion, which carries the head of the



FIG. 275.—Striated rock surface. Kingston, Des Moines Co., Ia.  
(U. S. Geol. Surv.)

valley back farther and farther into the mountain, and at the same time gives it steep slopes at sides and head (Fig. 273 and Pl. XVIII). The big, blunt, steep-sided heads of valleys developed by the erosion of valley glaciers are known as *cirques*. Cirques have remarkable development in the Uintas, the Bighorns, the



Fig. 1. WASHINGTON.

Glaciers on Glacier Peak, Washington. Scale 2 — miles per inch. (Glacier Peak Sheet, U. S. Geol. Surv.)

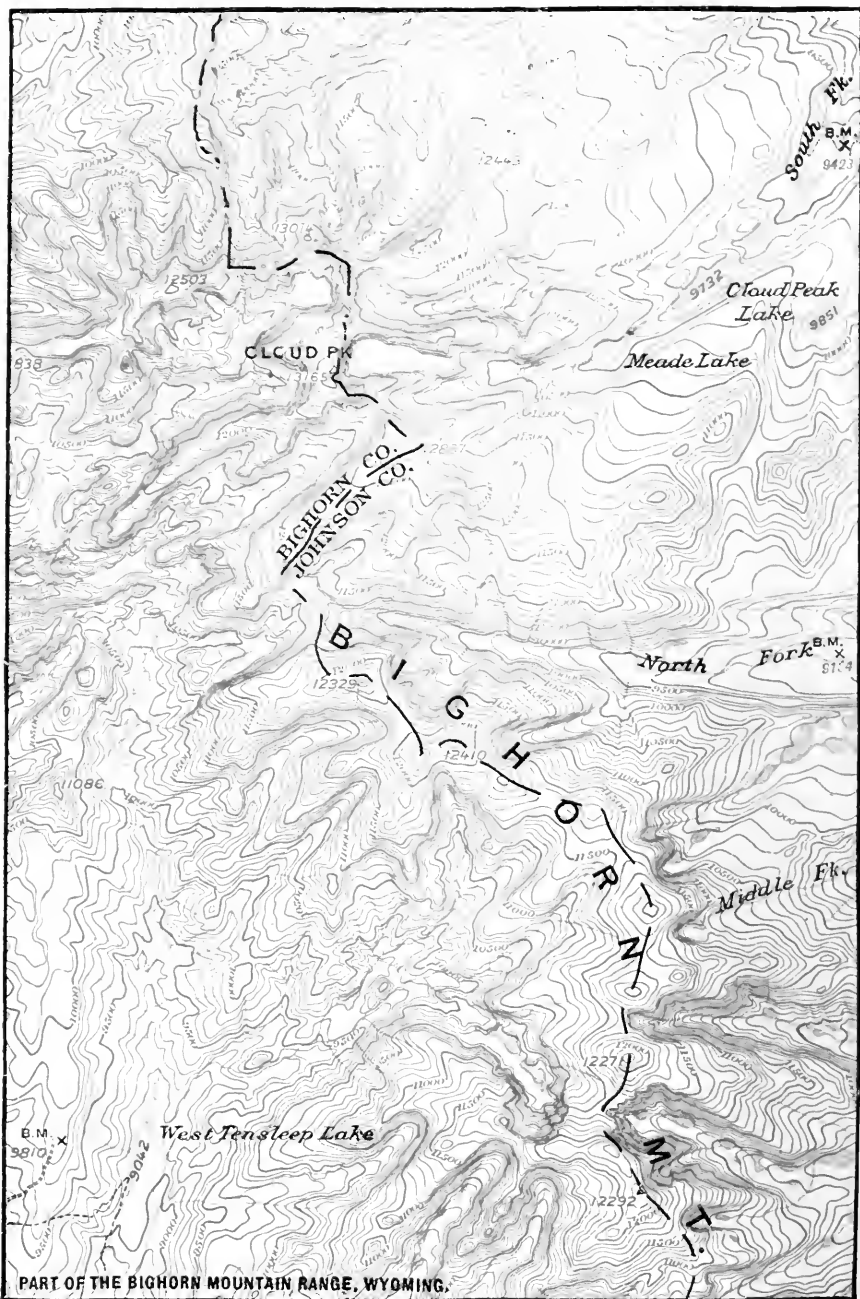

A portion of the Bighorn Mountains, showing glaciated valleys, the heads of which are in many cases cirques. Scale 2— miles per inch. (Cloud Peak, Wyo., Sheet, U. S. Geol. Surv.)

Sierras, and many other mountains of the West. There are often basins excavated in the solid rock in the cirques, and such basins are the sites of some of the numerous little lakes which add so much to the beauty of scenery in mountains which have been recently affected by ice.

The effect of ice-sheets on valleys is less obvious than that of

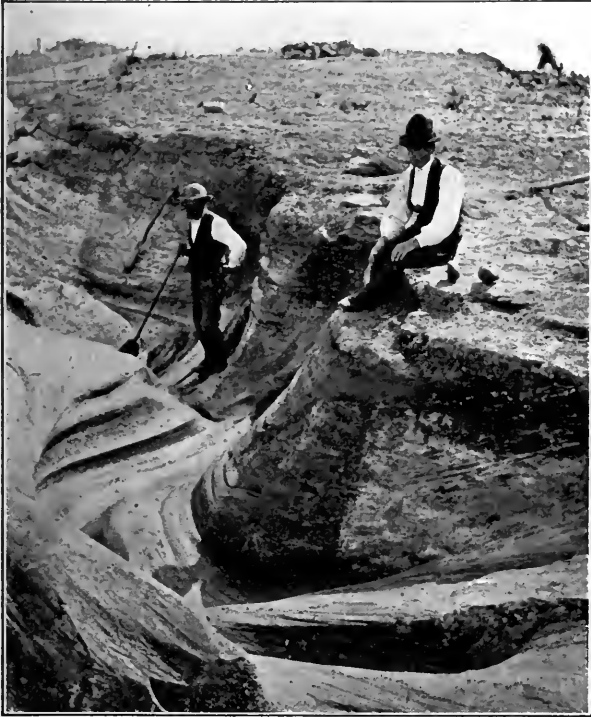

FIG. 276.—Rock grooved by glaciation. The gorge was probably formed by a stream under the ice, and then worn by the ice. Kelley's Island, Lake Erie. (U. S. Geol. Surv.)

valley glaciers, because in this case the ice affected divides as well as valleys. It is probable that the valleys through which the ice of a large ice-cap moves are deepened more than the neighboring hilltops are cut down. If so, glacier erosion increases the relief of the rock surface. At the same time, it probably reduces the roughness of the surface by reducing the steepness of slopes, and by obliterating many minor irregularities of hill and valley slopes.

If the ice of an ice-sheet crosses valleys, as the ice of great ice-caps often does, the valleys are not deepened notably, though their upper slopes may be much worn.

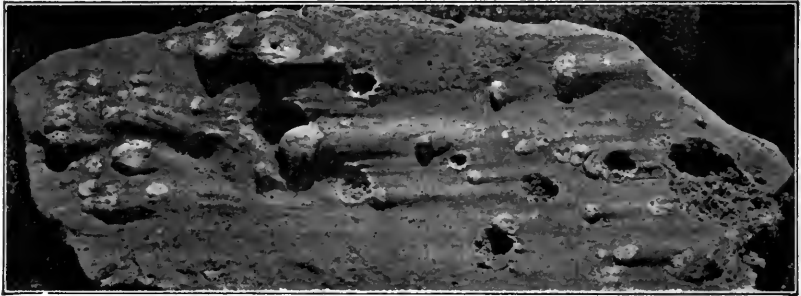

FIG. 277.—Small protuberances of rock showing the effect of ice wear. The movement was from left to right. Near Darlington, Ind. (U. S. Geol. Surv.)

As the ice wears the surface, it makes distinct scratches, called *striæ* (Fig. 275), on the bed-rock over which it passes. Grooves (Fig. 276) may be developed instead of *striæ* under favorable conditions. The *striæ* are made by the stones carried in the bottom of the ice. The grooves are developed where the bed-rock is softer,



FIG. 278.—Diagram showing, by the wear in the depressions, the direction of ice movement, left to right.

or where great bowlders are held firmly in the bottom of the ice, and urged along under great pressure. Fine clayey material in the bottom of the ice polishes the rock below. The polish, the *striæ*, and the grooves left on the surface of the rock after the ice has melted are among the most distinctive marks of the former existence of glaciers. In any limited area, these *striæ* are generally nearly parallel to one another and show the direction, or one of two directions, in which the ice moved. Between these two directions it is usually possible to decide by the help of the little irregularities of surface, as shown in Figs. 277 and 278.

The stones in the bottom part of the ice are rubbed against one another, as well as against the bed of the glacier, and are

scratched much as the bed-rock is (Figs. 279 and 280). Since the stones in the ice shift their positions from time to time as the ice moves, they are frequently striated on two or more sides.

As the materials carried by the ice rub against one another and against the bed over which they are carried, they become finer and finer. The finest products of the grinding constitute "rock flour," while coarser parts have the size of sand grains, pebbles, or even large stones. Thus it happens that the materials gathered and shaped by the ice are of all grades of coarseness, from huge masses many feet in diameter down to the finest earth

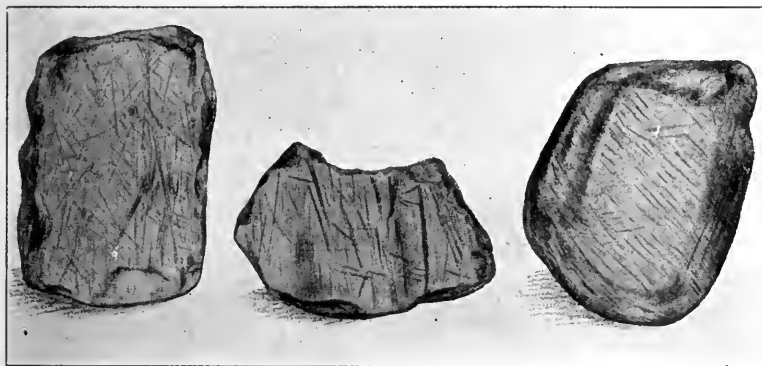

Fig. 279.—Stones striated by glacial wear.

(Fig. 281). The larger masses of rock are *boulders*; the smaller pieces are *cobble-stones*, *pebbles*, etc., while the finer materials are *sand* and ground-up rock (*rock flour*), popularly called *clay*.

**Materials gathered.** From its mode of erosion it will readily be seen that the bottom of a glacier may be charged with various sorts of material. There may be (1) boulders which the ice has picked up from the surface, or which it has broken off from projecting points of rock over which it has passed; (2) smaller pieces of rock picked up in the same way; (3) the fine products (*rock flour*) produced by the grinding of the debris in the ice on the rock-bed over which it passes, and similar products resulting from the rubbing of stones in the ice against one another; and (4) sand, clay, soil, vegetation, etc., derived from the surface overridden. Thus the materials which the ice carries are of all grades of coarseness and fineness, from large boulders to fine

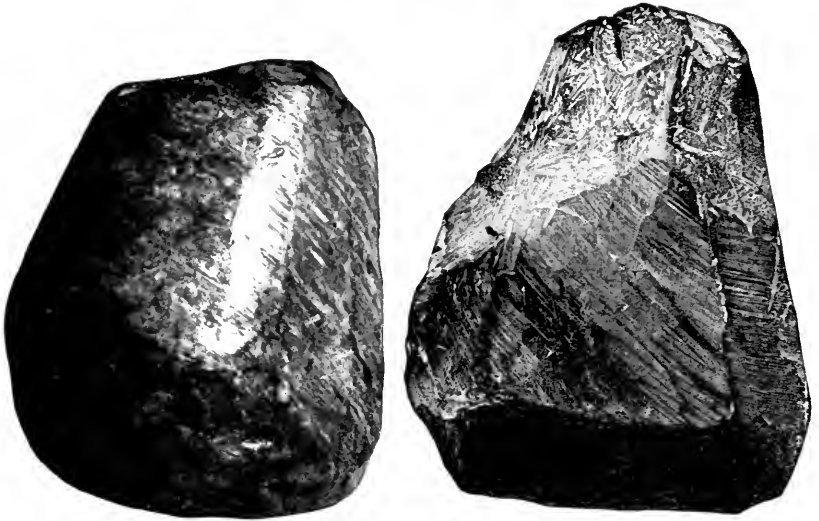

FIG. 280.—Stones in the drift striated and beveled by glacial wear.



FIG. 281.—Section of drift showing its heterogeneity.



clay. The coarser material may be angular or round at the outset, and its form may be changed and its surface striated as it is moved forward. Whether one sort of material or another predominates depends primarily on the nature of the surface overridden.

**Disposition of debris in transit.** The larger part of the material carried by a glacier is carried in its basal portion; but some is carried in the body of the ice, well above its bottom, and in the case of most glaciers, some is carried on the surface of the ice.

The position of the material in the base of the ice is readily understood from the manner in which the debris is gathered. The material above the base reaches its position in various ways.

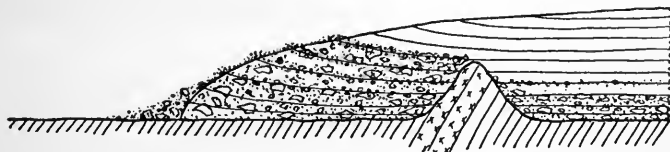

FIG. 282.—Diagram illustrating one way in which a glacier gets englacial material.

Sometimes the ice passes over a considerable elevation. In this case material may be torn from its top and carried along at a level corresponding somewhat to that from which it was derived. This is illustrated by Fig. 282. Under some circumstances, too, ice moves from the bottom of the glacier upward (Fig. 283), and carries debris with it, and in this way debris which was once at the bottom may later find itself in a higher position.

The material on the surface of a glacier reaches its position in various ways. Where the slopes above the glacier are steep, rock material may fall or slide down to the surface of the ice. Great masses of snow (*avalanches*) sometimes slide down upon a glacier from the steep slopes above, bringing quantities of debris, and dust is blown upon the ice.

The material falling or sliding down to a glacier from the cliffs above tends to accumulate near the margin of the ice, and as it lies on the surface of the glacier, constitutes *lateral moraines* (Fig. 284). If two glaciers unite, as is sometimes the case, the



FIG. 283.—End of a North Greenland glacier, showing the upturning of the layers of ice at the end. At one point a few stones are seen on the surface of the ice, where an upturned layer comes to the surface. This structure is common in North Greenland.

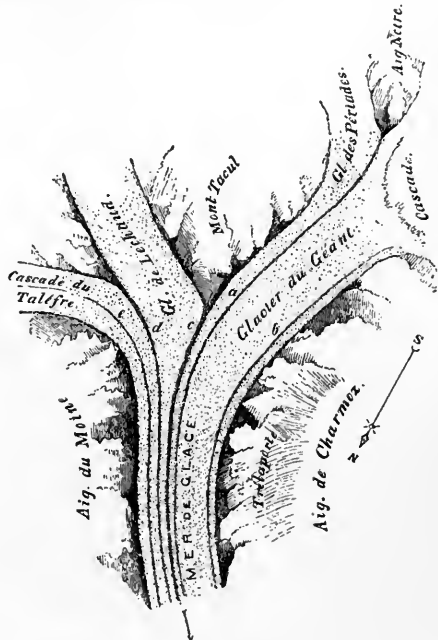

FIG. 284.—Figure showing the union of glaciers and the development of medial moraines by the union; also the position of lateral moraines. (After Tyndall.)

two lateral moraines of the adjacent sides may unite, forming a single *medial moraine* (Fig. 284).

Both medial and lateral moraines arise in other ways. If a glacier passes over an elevation which reaches well up into the ice, material torn from the elevation is at first carried along in the ice; but as the lower end of the glacier is approached, surface melting may bring the surface of the ice down to the level of the debris, when it appears at the surface as a medial moraine (Fig. 282). In other cases lateral and medial moraines arise by the upturning of the layers of ice, as shown in Fig. 285. Moraines arising in this way are common on the glaciers of North Greenland.

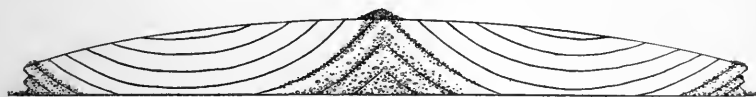

FIG. 285.—Diagram illustrating a way in which lateral and medial moraines are formed in many of the North Greenland glaciers. The horizontal line at the base represents sea-level.

#### *Deposition by Glaciers.*

While the ice is in motion it is depositing more or less debris beneath itself, against the hills and projecting bosses of rock. Again, the bottom of the ice may become heavily loaded in passing over a region which yields load readily, and a part of it may be deposited farther on, where changed conditions of movement have rendered the load excessive. Debris deposited at one time may be taken up at another. Thus beneath the moving ice there is more or less deposition in progress all the time, though much of it is not permanent. In this respect, deposition by glaciers is somewhat like the deposition of streams.

The position of the end of the glacier is determined by the relation between ice waste and forward movement. When the ice advances as much as it is melted back, its end or edge is constant in position. But it is to be remembered that even when the end of a glacier is constant in position, the ice itself is in continual movement. Under these circumstances, material is continually brought to the end or edge of the glacier and left there. The result is that if the end of a valley glacier or the edge of an ice-cap be constant or nearly constant in position for a long period of time, a thick body of drift is accumulated beneath its margin (Figs. 286 and 287).



FIG. 286.—Thick accumulation of drift under the end of a glacier. The end has probably been in about the same place for a long time. McCormick Bay, North Greenland.



FIG. 287.—An accumulation similar to that shown in Fig. 286, after the ice has melted away; near the last.

**The terminal moraine.** The belt of thick drift accumulated beneath the end of a valley glacier or beneath the edge of an ice-cap is a *terminal moraine*. The terminal moraine becomes massive only when the end of the glacier remains nearly constant in position for a long time. The same term is sometimes applied to the debris on the end of a valley glacier, or on the edge of an ice-sheet. The material of this *super-glacial terminal moraine* is added to the *sub-marginal terminal moraine* when the ice melts. In general, the sub-marginal accumulation is much greater than that which is let down from the top when the ice melts.

**The ground moraine.** When a glacier melts, all the debris which it carried is deposited. When the ice is gone, therefore, the whole surface which it covered is likely to be strewn with its debris. All the rock debris left by the ice is *drift*. The drift deposited by the ice but not aggregated into thick belts at its edge is *ground moraine*. The area of the ground moraine is much more extensive than the area of the terminal moraine.

Many spots once covered by the ice are left without drift when the ice melts, for the ice does not always carry debris at every point in its bottom. Areas of bare rock are therefore found, and sometimes commonly, in the area from which glacier ice has melted.

**Lateral moraines.** The term *lateral moraine* is applied not only to certain aggregations of drift on valley glaciers (Fig. 284), but also to certain aggregations of drift which are left by a valley glacier after melting. When a valley glacier is melted, the lateral moraines of its surface are left in the valleys which it occupied; but these lateral moraines are not commonly massive enough to be conspicuous after the ice is gone. On the other hand, the lateral moraines which remain when a valley glacier has disappeared are often large (Fig. 288). In many cases, indeed, they are the most conspicuous deposits left. They are often hundreds of feet high, and in some cases even more than a thousand.

The making of these huge lateral moraines is a somewhat complex process. They are made up in small part of the lateral moraines which were on the ice, and in much larger part of material accumulated *beneath the lateral margin of the glacier*. Their explanation seems to be found in the fact that a valley glacier moves not only down the valley, but also sidewise from the center toward either side. Spreading sidewise from the center, the ice is constantly

shifting debris from the axis of the valley to the edge of the ice on either side. The lateral moraine left after the ice is gone is therefore of the nature of a *terminal moraine beneath the lateral margin of the ice*.

Lateral moraines of valley glaciers are much more likely to remain after the ice is gone than the corresponding terminal moraines, for the latter are more likely to be washed away by the waters issuing from the ice or flowing down subsequently through the valley.

Ice-caps do not develop lateral moraines, because they have no lateral margins.



FIG. 288.—A lateral moraine left by a former glacier in the Bighorn Mountains of Wyoming. (Photo. by Blackwelder.)

**Distribution and Disposition of Drift.** Glaciers distribute their debris unevenly over the surface. The drift of terminal moraines is generally much thicker than that of the ground moraine near at hand, and the drift in the lateral moraines of valley glaciers is often very thick. The drift therefore modifies the topography in some notable measure.

In valleys, the terminal moraines often constitute dams, and so pond the waters of the streams above, and make lakes (Fig. 289), though not all the lakes of glaciated valleys are due to moraine-dams (p. 311).

The drift of ice-sheets is more likely to be abundant in valleys



FIG. 289.—Sketch of a part of the Sawatch Mountains of Colorado, showing the moraines of former glaciers. At the right—*hh*—are lakes (The Twin Lakes) held in by moraine dams. (See also Leadville, Colo., topographic n.-ap.) (After Holmes; Hayden Survey.)

and other low places than on hills and ridges. The drift of ice-sheets, therefore, usually diminishes rather than increases the relief of the surface (Fig. 290).

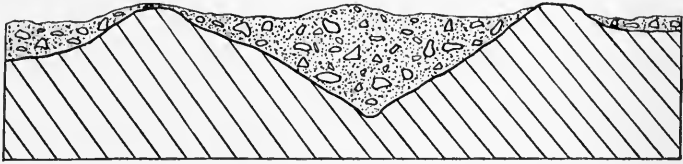

FIG. 290.—Diagram to illustrate how drift may decrease the relief of the surface.

Glacier drift is often irregularly disposed, so that its own surface is somewhat rough, even where it diminishes surface relief. Its surface is marked in many places by hillocks, mounds, etc., of drift, and by basin-like depressions (Figs. 291 and 292). In some



FIG. 291.—Sketch of drift (terminal moraine) topography near Hackettstown, N. J. (N. J. Geol. Surv.)

of the basins water stands, making lakes, ponds, or marshes. The surface of drift is therefore very unlike the surface developed by the erosion of running water, for in the latter the depressions have outlets, and the hills and ridges stand in a very definite relation to the valleys (compare Figs. 106, 139, and 292).

**Résumé.** The more distinct marks which a valley glacier leaves behind it are the following: (1) A U-shaped valley, often with its tributary valleys *hanging* (Fig. 271), and with its head in the form of a cirque (Fig. 273); (2) the upper end of the valley which



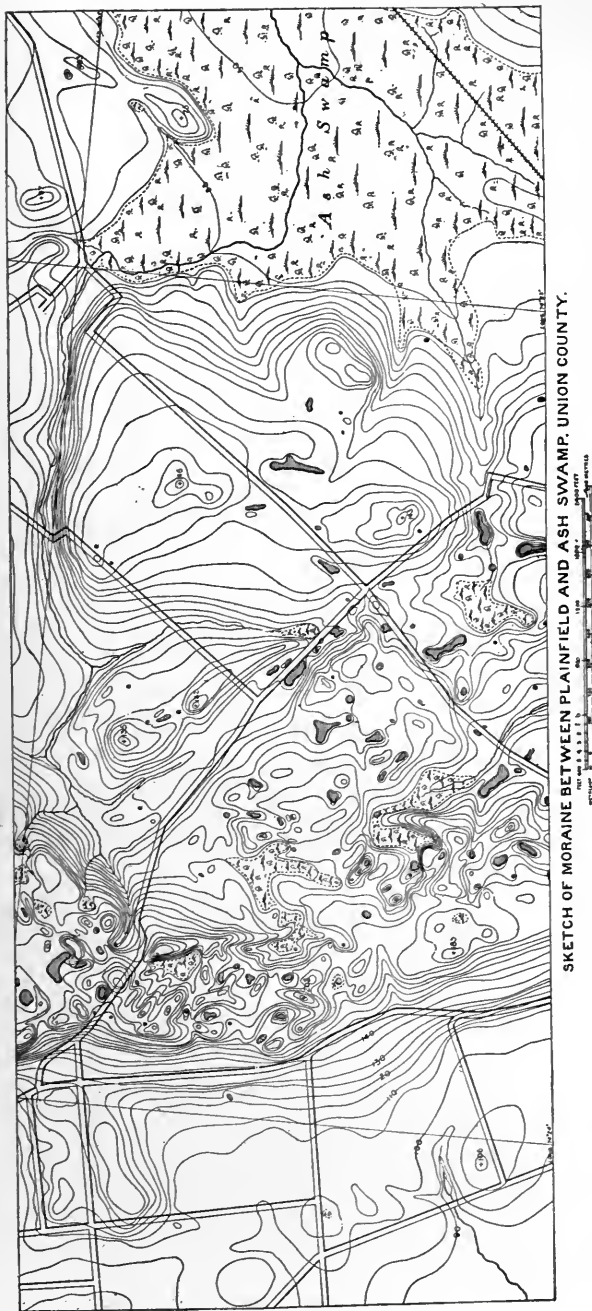

FIG. 292.—A map of a small area of drift in New Jersey. The central belt of rough topography is *terminal moraine*. The area at the right, about half the map, is *ground moraine*. The area at the extreme left is drift, gravel, and sand, washed out beyond the edge of the ice by streams, making an *outwash plain*. (p. 266.)

it occupied well cleaned out (Fig. 293), the loose rock-debris having been carried down the valley; (3) the rock of the valley smoothed and striated (Fig. 294); (4) rock basins in the bottom of the valley, especially near its head; (5) a body of drift composed of coarse and fine material, often without trace of stratification or orderly arrangement; (6) the stones of the drift are often worn, but not rounded as streams or waves round them, and



FIG. 293.—Portion of the upper part of a valley cleaned out by ice. The figure shows also the contrast between glaciated topography below and the non-glaciated above. Needle Mountains, Colo. (U. S. Geol. Surv.)

they often have planed and striated faces; (7) the drift is disposed as no other transporting agent disposes the material which it leaves (Fig. 295). The singular lateral-moraine ridges of valley glaciers, and the terminal moraines which often partially or wholly obstruct valleys, giving rise to lakes, ponds, and marshes, are among the distinctive deposits of valley glaciers. (8) Another distinctive though less common mark of glacier deposits is the huge boulders in delicately balanced positions (*perched boulders*) (Fig. 296).

Ice-sheets likewise leave (1) bodies of drift very much like that



FIG. 294.—Striæ, grooves, etc., in a canyon tributary to the Big Cottonwood Canyon. Wasatch Mts., Utah. (Photo. by Church.)



FIG. 295.—The moraines about the lower end of a glaciated mountain valley. Bloody Canyon, Cal. (U. S. Geol. Surv.)



FIG. 296.—A perched boulder, size  $12 \times 8 \times 8$  feet. East of Englewood, N. J. (N. J. Geol. Surv.)

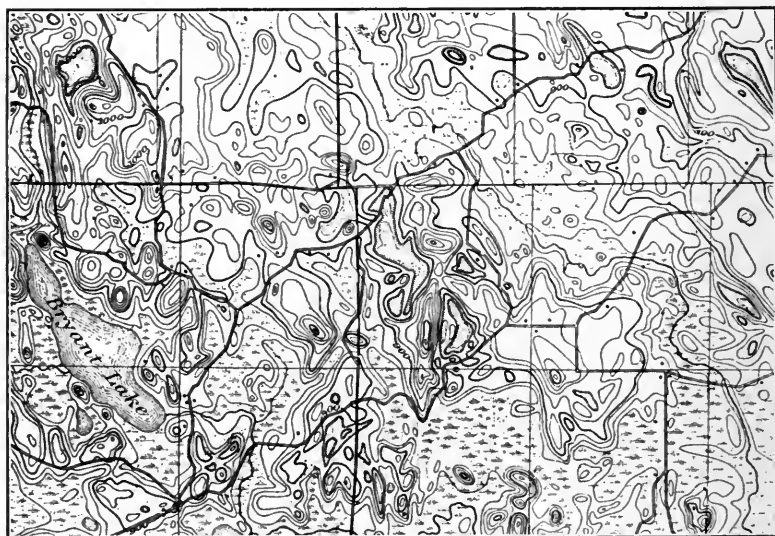

FIG. 297.—Topography of drift shown in contours; an area near Minneapolis, Minn. Scale about one inch to the mile. (U. S. Geol. Surv.)

of mountain glaciers, though often less coarse. This drift is in the form of terminal moraines (Figs. 291 and 297) and ground moraines (Fig. 298), the surfaces of which are marked by (2) numerous lakes, ponds, and marshes, which fill the kettle-like or saucer-like depressions in the surface of the drift. (3) Ice-sheets also smooth, striate, and groove the surface of the rock over which they move.

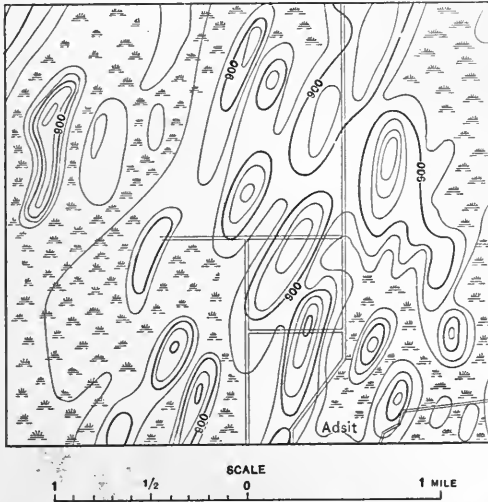

FIG. 298.—One phase of ground moraine topography. Elongated hills of drift of the type shown here are called *drumlins*. Southeastern Wisconsin. (U. S. Geol. Surv.)

### *Fluvio-glacial Deposits.*

Even while glaciers are growing, their ice is melting to some extent, and when they disappear, it is primarily by melting. Drainage is vigorous at the edge of an ice-sheet, and below the ends of valley glaciers much of the time, and in the summer, when the ice is melting rapidly, the streams which carry off the water are greatly swollen. Water-work, therefore, accompanies ice-work in all cases, and since there is on the whole about as much water as ice, and since the water has the last chance at the material left by the ice, it follows that some of the drift, as deposited by the glacier, is more or less modified by water subsequently. The streams which flow from glaciers carry away much debris derived from the ice. At the outset, this consists of both coarse

and fine material, but the gravel and small boulders are soon dropped and only the finer material is carried far. Many such streams carry so much silt in suspension that the water is turbid. If the silt is whitish, as it often is, the streams are said to be "milky."



FIG. 299.—Diagram to illustrate the profile of a valley train, and its relations to the terminal moraine in which it heads.

By the deposition of the gravel, sand, and silt, the valleys below glaciers are often aggraded to some extent by the fluvio-glacial debris. Deposits of this sort are stratified, and so are in contrast with the deposits made by the ice. Furthermore, the surface of the stream deposits is generally plane, and therefore in contrast with the topography of the drift deposited by the ice.



FIG. 300.—The outwash plain and the terminal moraine near Baraboo, Wis. (Photo. by Atwood.)

The material deposited by the stream in the valley below a glacier is a *valley train*. It is simply an alluvial plain developed under special circumstances. Valley trains are best developed just outside terminal moraines (Fig. 299).

In the case of an ice-cap, the water which issues from the ice often fails to find a valley. Each issuing stream thus tends to develop an alluvial fan. By growth, these fans may merge, making an alluvial plain. Such a plain, composed of material washed out from the ice is an *outwash plain* (Fig. 300), which is

often wider than long. It is of coarse material next the ice and of finer material farther away. Outwash plains, like valley trains, are best developed just outside the terminal moraines of ice-sheets, and their materials are stratified.

A glacier may obstruct surface drainage. If in its forward movement the ice obstructs the lower end of a valley, the water above accumulates and constitutes a lake. Drainage from the melting ice often builds deltas in lakes, just as other streams build deltas in the bodies of standing water into which they flow.



FIG. 301.— An esker in Finland.

In addition to the drainage outside the ice, there is running water in the ice and under it. The streams beneath the ice (subglacial streams) sometimes deposit gravel in their channels. These channels may be so built up that when the ice melts, the old bed of the stream appears as a low but narrow ridge, called an *esker*, composed chiefly of gravel and sand (Fig. 301). The sub-ice channels sometimes have the effect of tubes through which the water is forced with considerable velocity. As it issues from beneath the ice, its velocity is checked, and it sometimes makes extensive deposits of gravel and sand at the margin of the ice. These deposits are stratified, but the stratification is often irregular.

They are often left against the edge of the ice, and when the edge melts, the deposits appear as mounds and ridges, called *kames* (Fig. 302).

In warm weather, there are many small streams on the surfaces of glaciers (Fig. 242), especially if the surface of the ice is not much crevassed; but these surface streams rarely make deposits of consequence. On ice-caps there is little debris on the ice

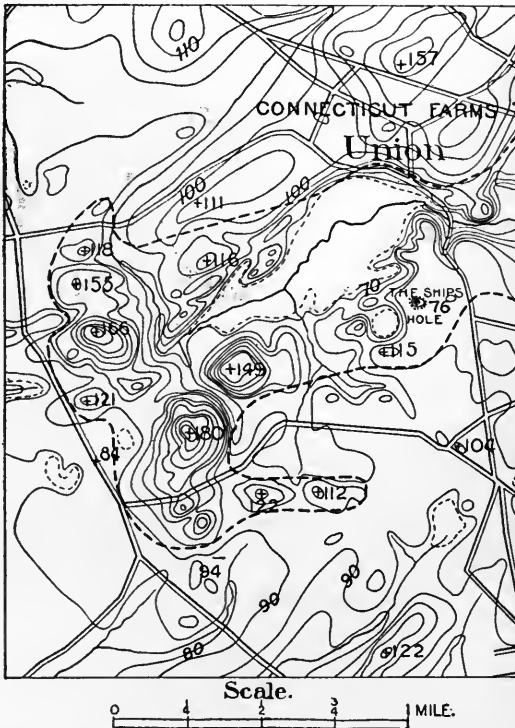

FIG. 302.—A group of kames near Connecticut Farms, N. J. (N. J. Geol. Surv.)

except at its immediate edge, so that the surface streams have access to little debris, and they are commonly clear.

As the ice melts away, the waters produced by the melting flow over the surface of the drift which the ice had already deposited, and modify its surface to some extent by eroding in some places and depositing in others.



As a result of all these phases of water-work, much of the drift is stratified. The stratified drift is sometimes above the unstratified, sometimes below it, and sometimes interbedded with it. In some cases, too, it lies beyond the limit which the ice reached.

### *Icebergs.*

Where glaciers move down into the sea, their ends may be broken off and floated away as *icebergs*. The breaking-off is brought about in various ways. As the ice pushes out into deepening water, it may reach a point where the depth of water is so great that its buoyant effect breaks off the ice, which is lighter than water. The ice is often already partly broken by crevasses before it reaches the sea.

Bergs derived from Greenland are found as far south as Newfoundland in considerable numbers. Occasionally they reach still lower latitudes, but by the time they have moved so far from their source, they have usually become small by melting. The bergs from Greenland are rarely 200 feet out of water, and most of them are not more than 100 feet, even near their sources. They are sometimes a mile or more across. In the South Polar regions bergs are still larger in area, though higher ones are perhaps not common. A berg 200 feet out of water, disregarding projecting points, may be 1000 to 1500 feet thick. Though river or lake ice is about nine-tenths as heavy as water, glacier ice is less heavy, unless loaded down with rock debris. This is because the snow-ice does not become so compact as the ice formed on rivers and lakes.

As the icebergs sail away, they carry more or less of the debris which was in the bottom of the glacier. In the water, melting takes place, and the debris which was held by the melted parts falls to the bottom. If, as is often the case, the iceberg capsizes as it sets sail, the bottom debris of the glacier may appear on the sides or top of the iceberg, if it does not at once slide off and sink. This debris absorbs more of the sun's heat than the ice does, and is soon melted out of the ice; or more strictly, the ice is melted away from around it. If it was on the side, it drops out into the sea.

Icebergs frequently turn, or cant, because of (1) the cutting of the waves, (2) the splitting off of pieces of ice, (3) unequal

melting, etc., all of which tend to shift their centers of gravity and so disturb their equilibrium.

Observations on northern icebergs indicate that they do not carry much debris far. The average berg is probably free of debris before it has floated 100 miles. The common notion that the banks of Newfoundland were made largely by berg deposits probably has no foundation in fact.

Where icebergs ground in large numbers, as on the shores of Labrador and Newfoundland, they may erode the bottom to some slight extent.

Icebergs in the North Atlantic occasionally reach the tract of transatlantic commerce. Since they are sometimes surrounded by fog, they may be a menace to shipping and travel.

#### ANCIENT GLACIERS AND ICE-SHEETS.

There have been times in the earth's history when glaciers were much more extensive than now. The latest of these periods is known as *the glacial period*. During this period the glaciers of the western mountains were very much larger than now, and glaciers were numerous in many mountains where there are none now. Small ones existed even in the mountains of New Mexico, Arizona, and Nevada. The amount of ice in the glaciers of Utah or Colorado at that time was far in excess of all that now exists in the United States south of Alaska. The glaciers in the western mountains north of the United States also were correspondingly larger than now, while east of the mountains an area some 4,000,000 square miles in extent (Fig. 303), lying partly in Canada and partly in the United States, was covered with an ice-sheet or *continental glacier*.

The ice-sheet of North America seems to have originated in two principal centers, one on either side of Hudson Bay. The beginning of each was doubtless a great snow-field. The snow- and ice-fields grew by the fall of snow, and later by the spread of the ice to which the snow gave rise. The two ice-sheets finally became one by growth (Fig. 303). It is to be noted that the great continental glacier did not originate in mountains, but on high plains. In addition to the large valley glaciers of the western mountains, bodies of ice of the ice-sheet type were developed in favorable situations in these mountains, though their continuity

was much interrupted by the crests and peaks. The valley glaciers often merged on the plains below, where piedmont glaciers of great size were developed.

At the time of its greatest extent, the ice-sheet of North America



FIG. 303.—Sketch-map showing the area in North America covered by ice at the maximum stage of glaciation. (Chamberlin.)

extended south so as to cover all of New England, the northern parts of New Jersey and Pennsylvania, and much of Ohio and Indiana. Its edge crossed the Ohio River where Cincinnati now stands, and advanced a few miles into Kentucky. Farther west it reached almost to the southern end of Illinois. Its edge crossed the Mississippi near St. Louis, and followed, in a general way,

the course of the Missouri River to Montana. Most of the continent north of this line was covered with snow and ice, but there was an area of eight or ten thousand square miles, mainly in southwestern Wisconsin, which the ice did not cover. Because of the absence of drift in this region, it is known as the *Driftless Area*.

The conditions for extensive glaciation existed in Europe at about the same time. The glaciers of the Alps, for example, were many times as large as those of the present time. To the south they extended quite through the mountain valleys and spread themselves out on the plains of northern Italy. On other sides also the glaciers were correspondingly larger than now. This great extension of the glaciers is known from the moraines, and from the striated rock, etc., which the ice left where it melted. Similar conditions existed in the other mountains of Europe where glaciers now exist, and in some where glaciers are not now present.

In northern Europe, as in the northern part of North America, there was an extensive ice-sheet, but its area was only about half that of the ice-sheet of North America. The center from which the ice-sheet radiated was the high mountains of Scandinavia, with perhaps subordinate centers in the highlands of Scotland, and in the Urals. At the time of its greatest extension, this ice-sheet covered all but the southernmost part of Great Britain, all of northern Germany, and much of Russia (Fig. 304).

Great ice-sheets are not known to have developed in other continents, but their mountain glaciers were greatly enlarged.

In both Europe and North America the history of the continental glaciers was most complex. In each continent there were several successive ice-sheets, separated from one another by considerable intervals of time. The sequence of events in North America was somewhat as follows: After the development of the first great ice-sheet, it shrank to small proportions, or disappeared altogether, probably because of a change of climate. The dwindling of the first ice-sheet was followed by a relatively warm period, during which plants and animals took possession of the region abandoned by the ice. Another continental ice-sheet then developed, overspreading the region from which the first had withdrawn, and extending still farther south. As it advanced, the second ice-sheet occasionally buried the soil which had formed on the top of the drift deposited by the ice of the first epoch. Such

soils, sometimes with the remains of plants which can be identified, lying between a sheet of drift below and another above, are one of the means by which it is known that there was more than one continental glacier. By this and other means, a third, fourth, and fifth ice-sheet, each somewhat smaller than its predecessor, developed and disappeared. In other words, there were at least five epochs when ice-sheets were extensive, separated by epochs

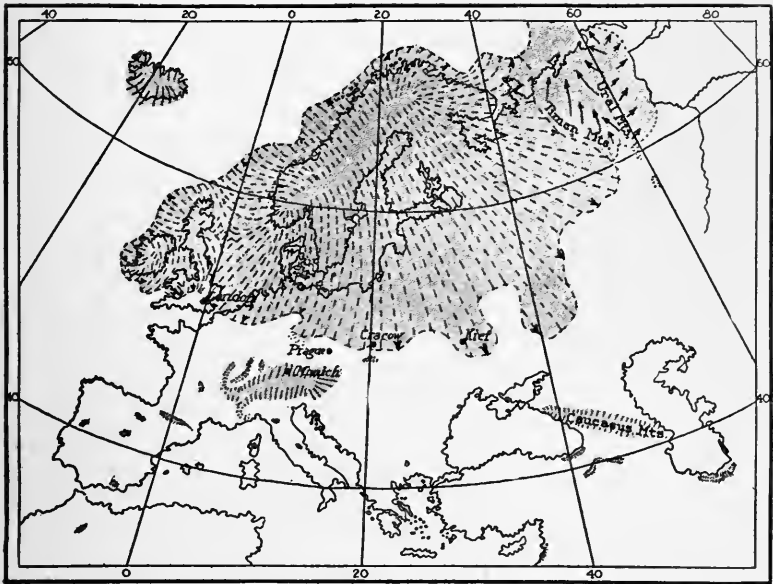

FIG. 304.—Sketch-map showing the area of Europe covered by the continental glacier at the time of its maximum development. (After Jas. Geikie.)

when the ice was greatly diminished, or when it disappeared altogether. The ice-sheets of Europe had a similar history.

#### *Cause of the Glacial Epochs.*

The cause of the development of the great ice-sheets was doubtless climatic, the chief factor being a reduction of temperature. The cause of this cold climate is not certainly known. Various hypotheses have been proposed to explain it, but to most of them there seem to be fatal objections. This subject will not be discussed here, but it may be stated that the only hypothesis which

seems not to be discredited is that which refers the change of climate to a change in the constitution of the atmosphere. It appears that an increase in the amount of carbonic-acid gas and water vapor would result in an amelioration of climate, while a decrease in these elements would result in a reduction of temperature. This hypothesis cannot be elaborated here, but it may be stated that plausible reasons have been suggested for fluctuations in the amounts of these substances in the atmosphere, and also for the relatively heavy precipitation (which is as necessary as low temperature for glaciation) in the regions where the ice-sheets developed.

#### CHANGES PRODUCED BY THE CONTINENTAL GLACIERS.

The ice-sheets of North America modified the surface which they covered to some notable extent. A brief résumé of the changes they produced will serve to review and emphasize the work of ice-sheets. The changes wrought by the ice-sheet fall into two classes: (1) those brought about by the erosion of the ice, and (2) those brought about by the deposition of the drift.

It is important to remember that the continental glacier of North America developed on the surface of a rather high plain, the topography of which had been shaped in large measure by rain and river erosion. This is inferred from the topography of the area not covered by the ice.

#### *Changes Produced by Erosion.*

1. *On elevations.* The ice was thick enough to pass over the hills and low mountains, such as those of New England and northern New York, within the area shown in Fig. 303. As it overspread these and lesser elevations, it wore off their tops. It reduced all points which stood up above the general surface, and so tended to make the surface less rough. The general effect on elevations is shown by Figs. 264 and 265.

2. *In valleys.* The ice also deepened the valleys through which it moved. In many cases it deepened them as much as it lowered the hills, or even more. In the latter case, the relief of the surface was increased; but even where this was true, the roughness of the surface was often diminished, for roughness depends on the fre-

quency with which elevations and depressions, such as hills and valleys, succeed one another, and on the steepness of their slopes, quite as much as on the amount of relief (Fig. 305). Where the edge of an ice-sheet was differentiated into valley glaciers which moved down to the sea, the ice sometimes gouged out the valleys far below sea-level, giving rise to narrow bays, or fiords, after the ice melted.

3. *Rock basins.* Another effect of ice erosion was to gouge out hollows where the underlying rock was relatively weak. The result was the formation of basins in the surface of the rock. Such rock basins are probably less common in the area of the continental ice-sheet than in mountain valleys affected by glaciers.

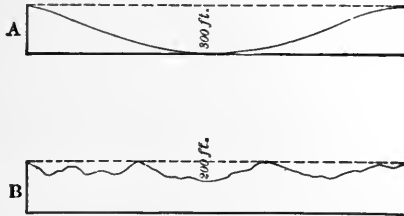

FIG. 305.—Diagram to show that roughness of surface and amount of relief are not necessarily the same. A represents greater relief, but B might be regarded as a rougher surface.

The ice also polished, striated, and grooved the surface of the rock over which it moved, though these effects are not important topographically.

#### *Changes Produced by Deposition.*

Sooner or later the ice deposited all of the material which it eroded from the surface over which it passed. Had the drift been equally thick everywhere, its effect would have been to raise the surface without altering its topography; but it is distributed with great inequality, and this inequality modified the topography.

1. *General distribution of the drift.* The tendency of the moving ice was always to transfer its drift from the point where it was picked up toward the margin of the ice. In general, therefore, the drift left by the continental glaciers is thicker toward their former margins, and thinner toward their centers. It is very thick, for example, in a belt extending from western New York through Ohio, Indiana, Illinois, Wisconsin, Minnesota, and Iowa,

to Dakota and Montana. In considerable tracts north of the boundary of the United States, on the other hand, toward the center of the ice-fields, little drift was left.



FIG. 306.—Terminal moraine topography near Oconomowoc, Wis.  
(Wis. Geol. Surv.)

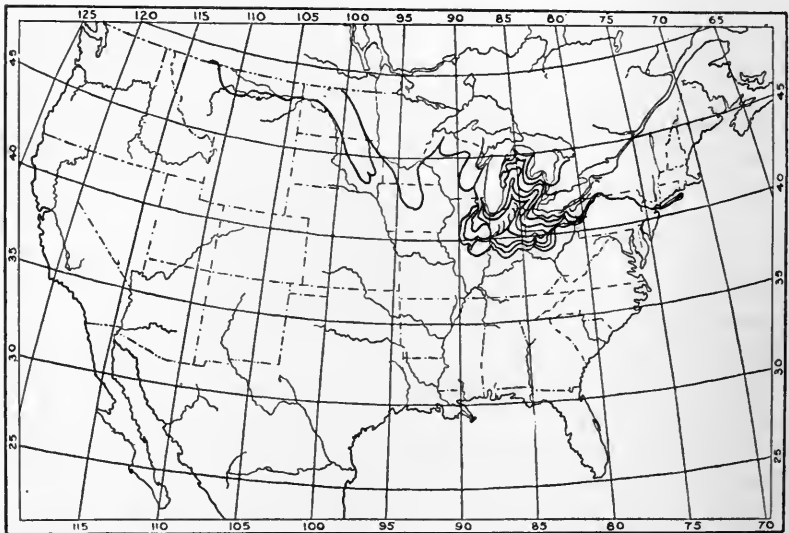

FIG. 307.—Map showing the position of some of the principal terminal moraines of the United States.

*Terminal moraines.* The last ice-sheet, especially, developed stout terminal moraines. The position of some of them is shown



in Fig. 307. It will be seen that they lie well north of the southernmost margin of the drift, because the ice-sheet which made them did not advance so far to the south as some of its predecessors had done.

As the edge of the ice was melted back, it sometimes halted for a time far back from the position of its maximum advance. Beneath



FIG. 308.—Bowlders on the terminal moraine of the Okanagan glacier, Wash. (U. S. Geol. Surv.)

the edge in such positions, terminal moraines were made. Such terminal moraines are sometimes called *recessional moraines*. They are terminal to the ice at the time they were made, but not terminal to the drift sheet as a whole. This explains why one ice-sheet came to develop several terminal moraines.

The terminal moraine of an ice-sheet is not always, and per-



FIG. 309.—A single bowlder in the area shown in Fig. 308. (Willis, U. S. Geol. Surv.)

haps not usually, a conspicuous ridge, though it is often conspicuous in a region of slight relief. Its topography is much more distinctive than its size. Its surface is often marked by hillocks, mounds, ridges, etc., associated with depressions of similar shapes (Figs. 291, 292 and 306). While this sort of topography is so widespread as to be characteristic, it is not pronounced in all terminal moraines. The depressions often contain ponds, lakes, or marshes.

Boulders frequently abound on a surface of terminal moraines (Fig. 308).

**The ground moraine.** The area of the *ground moraine* is much more extensive than that of the terminal moraines, and its topography is, in general, less rough. The hills and hollows are

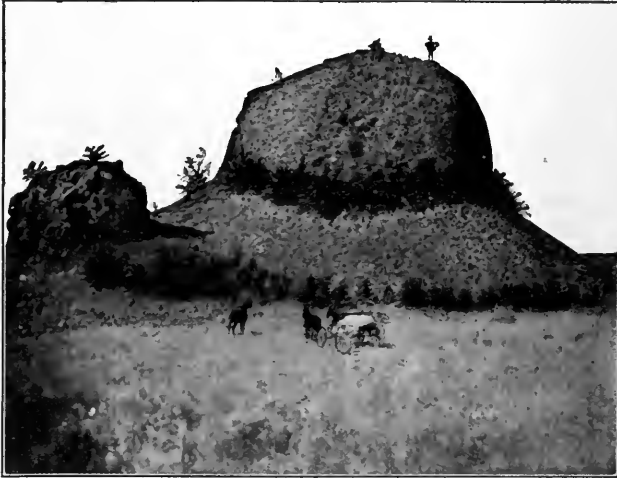

FIG. 310.—“Pilot Rock.” A glacial boulder near Coulé City, Wash. (Garrey.)

less steep-sided, and the curves of the surface broader (Fig. 311, and Pl. XIX). Portions of the ground moraine are sometimes in the form of elongate or oval-hills, called *drumlins*. Drumlins occur in many places, some of the best known being in Wisconsin and New York (Figs. 298 and 312–314). At the battle of Bunker Hill, the Americans occupied and fortified a drumlin.

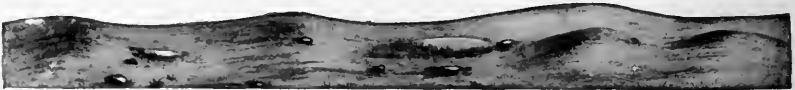
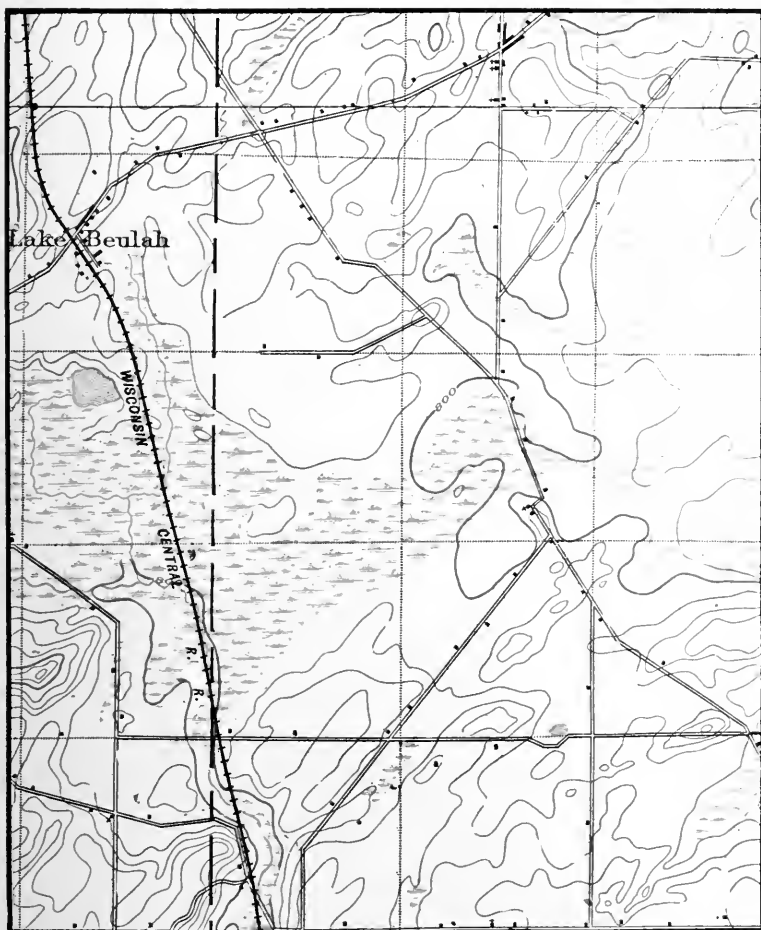

FIG. 311.—Ground moraine topography. (Atwood.)

**Effect of drift on topography.** The drift is sometimes so disposed as to increase the relief of the surface (Fig. 315), but oftener so as to decrease it (Fig. 290), because more drift, on the whole, was left in the low places than on the high ones. On the other hand, the drift was sometimes left in such a way as to



Characteristic drift topography. Scale 1—mile per inch. (Eagle, Wis. Sheet, U. S. Geol. Surv.)





FIG. 312.—Drumlins in contour, near Clyde, N. Y. (U. S. Geol. Surv.)



FIG. 313.—A Wisconsin drumlin seen from the side. Two miles north of Sullivan. (Alden, U. S. Geol. Surv.)

make the surface rougher than the surface of the rock below, even where the relief was decreased.

**Effect of drift deposits on drainage.** The drift left by the ice sometimes filled valleys at some points, but not at others. Drift fillings in valleys make dams, above which water is likely

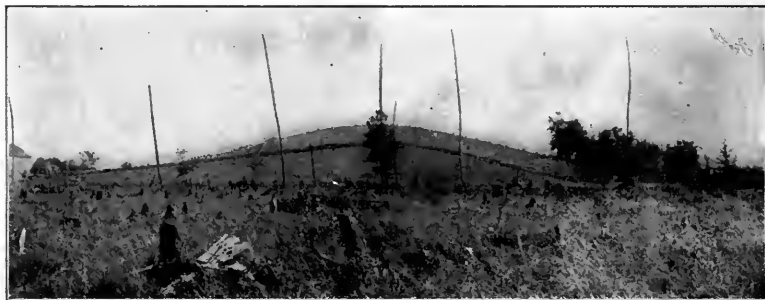

FIG. 314.—The same drumlin shown in Fig. 313 seen from the end.  
(U. S. Geol. Surv.)

to accumulate, making lakes. If a valley was filled in two places, as sometimes happened, the unfilled place between became a basin fit for a lake. The number of lakes developed in this way is very large. The finger lakes, of New York and Devil's Lake, Wisconsin (Fig. 316), are good examples.

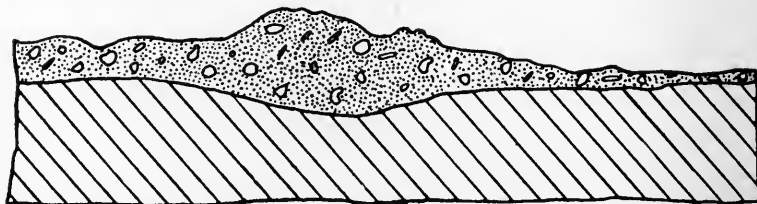

FIG. 315.—Diagram to show how drift may be so disposed as to increase the relief of the surface.

Rock basins have already been referred to; but it often happened that basins the bottoms of which are in rock were made deeper by the deposition of drift about their rims. The Great Lakes probably occupy rock basins, but their margins were built up by drift, making them deeper.

The ice-sheets gave rise to lakes and ponds in other ways also.

Many of them occupy depressions in the surface of the drift. Such lakes are especially numerous in terminal moraines, but they are not rare in the ground moraine, and are by no means unknown in the stratified drift. Glaciation affords the explanation of the numerous lakes of North America, nearly all of which are in the area which was covered by the ice-sheet or by mountain

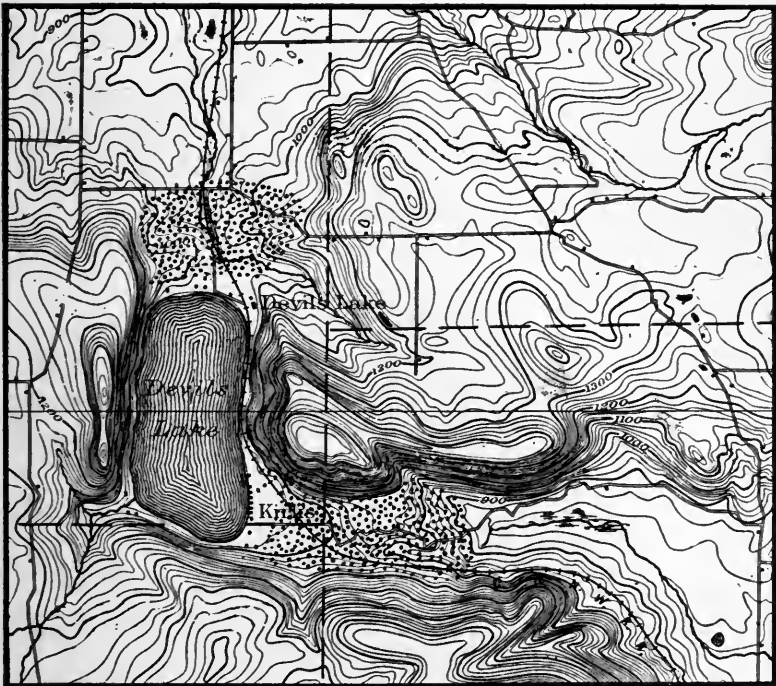

FIG. 316.—Sketch showing a lake in a former river valley, held in by drift dams. The dotted areas are terminal moraines.

glaciers. They are most numerous in the area covered by the ice of the last glacial epoch (Fig. 303), as in North Dakota, Minnesota, Wisconsin, Michigan, New York, and New England. Except in special situations, where they are of wholly different types, lakes do not occur south of the drift.

Some lakes developed by the ice had but a temporary existence. Some of them came into existence along the margin of

the ice-sheets, the ice itself often forming one border of the lake. Such lakes disappeared when the ice melted.

One of the largest of the marginal lakes (Lake Agassiz) lay in the valley of the Red River of the North (Fig. 317). When this lake was largest, its length was about 700 miles, and its maximum width about 250 miles. Its area was about 110,000 square miles,

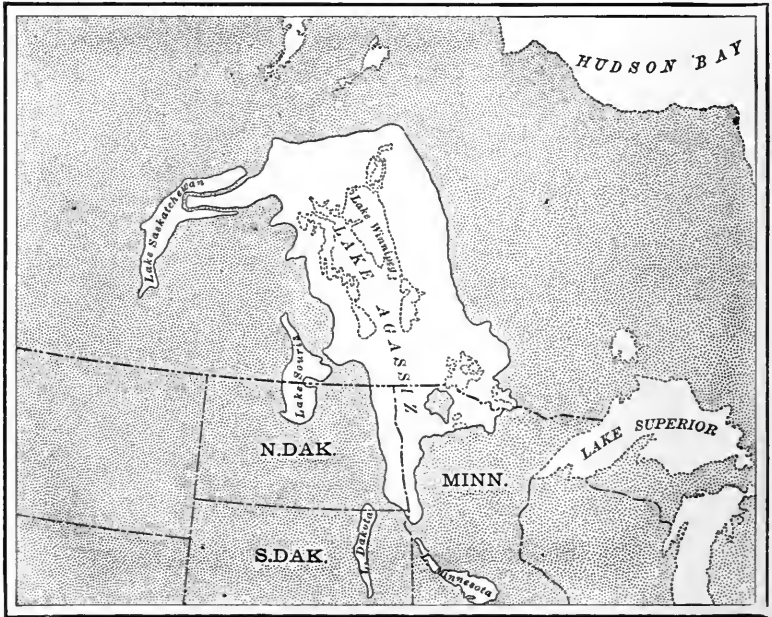

FIG. 317.—Map of the extinct Lake Agassiz, and a few other glacial lakes. Lake Winnipeg occupies a part of the old basin of Lake Agassiz. (Upham, U. S. Geol. Surv.)

or nearly one-fifth more than the combined area of all the Great Lakes, but the water was not very deep. It came into existence when the ice at the north obstructed drainage in that direction. The water rose in the basin until it overflowed to the south. When the ice at the north melted, a new and lower outlet was opened in that direction, and the lake was drained. Lake Winnipeg and several smaller lakes may be looked upon as remnants of this great lake, for they occupy the deepest depressions in the old basin.

The borders of the former lake are marked by old beaches, and locally by deltas. The silt-covered bottom of the lake is one of the most important wheat-producing areas in the United States.





FIG. 318.—The beginning of the Great Lakes. The ice still occupied the larger parts of the present lake basins. (After Taylor and Leverett, U. S. Geol. Surv.)

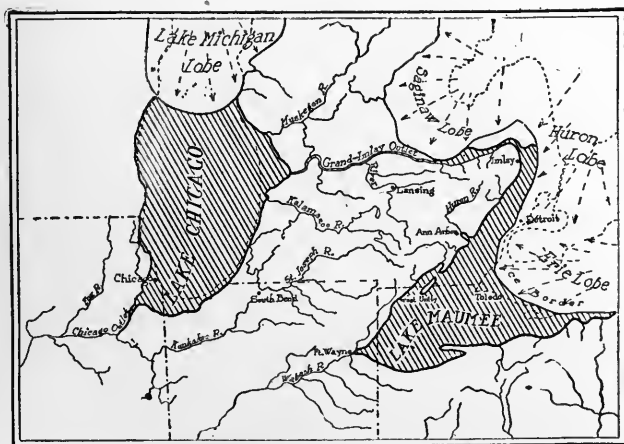

FIG. 319.—A later stage in the development of Lakes Chicago and Maumee. The ice has retreated, and the outlet of Lake Maumee has been shifted. (After Leverett and Taylor, U. S. Geol. Surv.)

The Great Lakes of the present day were greatly expanded while the ice blocked their present outlets. A part of their history,



FIG. 320.—The Great Lakes at the Algonquin-Iroquois stage. (After Taylor.)



FIG. 321.—A still later stage of the Great Lakes. The sea is thought to have covered the area shaded by lines at the east. (After Taylor.)

dating from the time of the last ice occupancy, is suggested by Figs. 318 to 321. The basins of these lakes did not exist, so far

as known, before the glacial period, but considerable rivers may have flowed along the lines of their axes. From these river valleys, lake basins appear to have been developed as a result of (1) the deepening of portions of the valleys by ice erosion, (2) the building up of the rims of the basins by the deposition of drift, and (3) perhaps the down-warping of the sites of the basins.

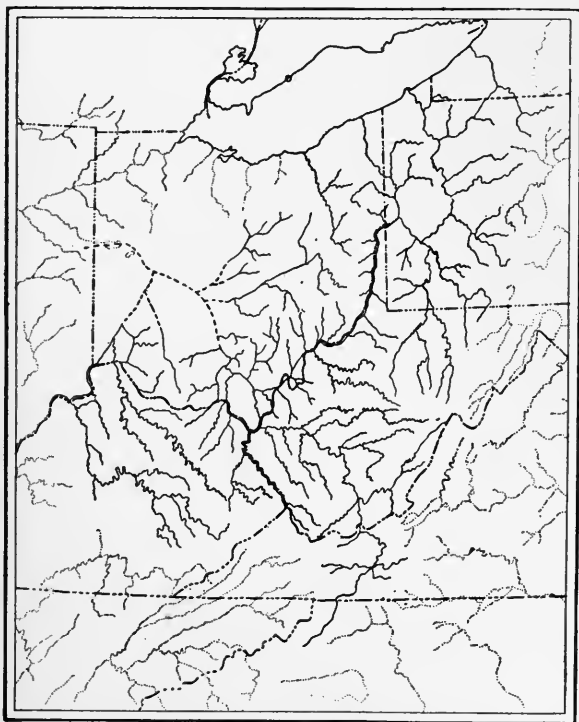

FIG. 322.—Sketch-map showing the drainage of the upper Ohio basin as it is believed to have been before the glaciation of the region. (Tight, U. S. Geol. Surv.)

The irregular disposition of drift also deranged the rivers. After the ice melted, the surface drainage followed the lowest lines open to it, but these lines did not always correspond with the former valleys, for some of them had been filled, and most of them were blocked up in some places. After the ice melted, therefore, the surface waters followed former valleys in some cases, and in others flowed across areas where there had been no valleys. In choosing their new courses, the streams sometimes fell over

cliffs or ran down steep slopes. Thus arose falls and rapids which, on the whole, are rather common in the streams of the glaciated area. Figs. 322 and 323 indicate something of the changes effected by the deposition of the drift in the basin of the upper Ohio.

We have already seen that rapids and falls are marks of young streams. Most lakes also are marks of youth. Rivers are, on the whole, hostile to lakes, for outflowing waters cut down their outlets, and inflowing waters bring in sediment which, when deposited in the basins, tends to fill them up. Many small lakes have already

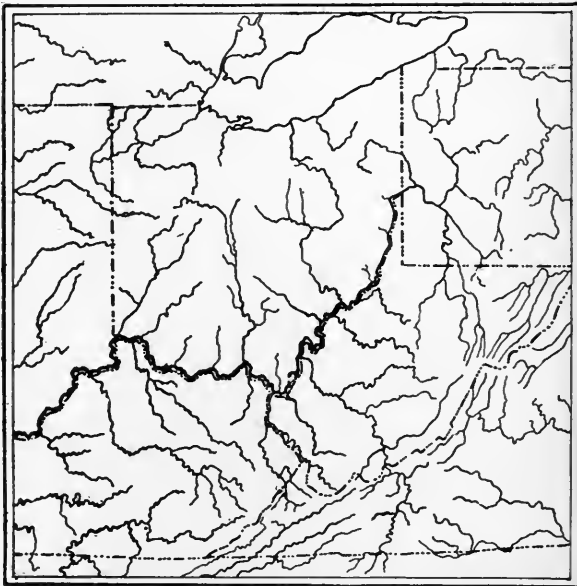

FIG. 323.—Present drainage of the area shown in Fig. 322.

become extinct in these ways, and many others have been made sensibly smaller. The fact that so many falls, rapids, lakes, etc., still exist within the glaciated area shows that the time since the melting of the last ice-sheet has not been long enough for these features to be destroyed.

Marshes also abound within the glaciated area. In some cases they represent the beds of former lakes and ponds, while in others they are simply basins too shallow to hold bodies of water sufficiently deep to prevent the growth of plants.

Lakes, ponds, marshes, falls, rapids, etc., are much more abundant in the area covered by the last ice-sheet than in the area of drift outside of the last ice-sheet. This is largely because the southernmost part of the drift, as now exposed, is older, and has been subject to rain and river erosion long enough for surface drainage to destroy most of the lakes. The oldest drift of the glacial period is believed to be many times (probably as many as twenty-five) as old as the youngest.

**Stratified drift.** Valley trains, outwash plains (p. 266), deltas (p. 198), etc., were developed by the continental glaciers, but only those of the last ice-sheet are well preserved. Some of the valley trains are long, and in some the deposits are deep. Thus the Rock River in southern Wisconsin filled its valley with gravel and sand to a depth of 300 to 400 feet just below the terminal moraine of the last glacial epoch, while the ice-water flowed through it. The Columbia River, swollen by the waters from the melting ice, filled its valley, locally, to the depth of 700 feet with material washed out from the ice.

Since the ice melted, most of the valley trains have been partially carried away, and the remnants of the old plains of aggradation are now terraces (Fig. 217).

Outwash plains (p. 266) also are extensive. Thus much of the southern part of Long Island is an extensive outwash plain, spreading southward from the terminal moraine which makes the backbone of the island. Just southeast of Brooklyn the outwash plain, in preference to the hills of the adjacent moraine, has been occupied by several suburbs.

Kames and eskers (p. 267) also diversify the surface of the drift at numerous points, the former being far more numerous than the latter (Figs. 301 and 302).

**Effects of glaciation on human affairs.** The effects of glaciation have had much influence on the industrial history of the region which the ice covered.

The increase of mantle rock in the United States, as a result of glaciation, is of significance. This increase is of value in regions where slopes were considerable, for where such slopes are found in driftless regions, the soil is often very thin or absent, and the area of arable land is thereby restricted. Abundant soil is much more likely to be found on similar slopes in the glaciated area. Furthermore, since the general effect of glaciation was to reduce

slopes, it tended to reduce the areas where the slopes were too steep to be cultivated.

Again, the quality of the soil was improved in many places by glaciation, but this is not true everywhere. It is worth noting that most of the wheat and hay grown in the United States east of the Rocky Mountains, are within the area which was glaciated. This is probably not altogether because of the drift, but partly because of the climate.

The reduction of roughness and the smoothing of slopes effected by glaciation made the construction of roads easier, and so, on the whole, has facilitated transportation. Locally, however, the surface was made rougher, with disadvantageous results.

The falls, rapids, and lakes which resulted from glaciation have increased the water-power, and the lakes, ponds, and marshes which serve as reservoirs have tended to equalize the flow of the streams throughout the year. The flow of streams from lakes is much steadier than the flow of streams which have no permanent reservoirs to draw upon. The drift is much thicker, on the whole, than the mantle rock of other regions. This greater thickness of loose material on the surface tends to hold back the rain-water after it falls, the porous drift itself serving as a sort of reservoir which yields up the water slowly.

The economic significance of lakes is noted elsewhere (p. 316).

The drift materials are somewhat extensively utilized. Thus much of the drift clay (rock-flour) is used for the manufacture of brick, tile, etc., and the gravel is used for road-making, and in the manufacture of various sorts of cements.

Such are some of the beneficent results of glaciation. There are also some considerations on the other side.

In some places the quality of the soil has been injured, for in many areas the drift is stony, and great labor is necessary to put it in workable condition. In some places, too, it is too sandy or gravelly to make good soil, and in other places its surface is too rough to allow of successful tilling. In still other situations, as in much of New England, the ice left a thin stony mantle of drift covering a rough hilly surface. This, combined with a somewhat unfavorable climate, made agriculture unprofitable in much of this region, and so favored the early development of the fisheries, and, together with abundant water-power, has made New England a manufacturing rather than an agricultural region.

In spite of these adverse considerations, it seems probable, on the whole, that the glaciated area of the United States was considerably benefited by the work of the ice.

### MAP EXERCISE.

#### *Maps for the Study of the Topographic Effects of Glaciation.*

I. The maps to be studied in preparation for conference:

- |                                 |                         |
|---------------------------------|-------------------------|
| 1. Lancaster, Wis.—Ia.          | 8. Passaic, N. J.       |
| 2. Eagle, Wis.                  | 9. Palmyra, N. Y.       |
| 3. Whitewater, Wis.             | 10. Canada Lake, N. Y.  |
| 4. Muskego, Wis.                | 11. Paradox Lake, N. Y. |
| 5. Geneva, Wis.                 | 12. Leadville, Colo.    |
| 6. St. Croix Dalles, Wis.—Minn. | 13. Hayden Peak, Utah.  |
| 7. Brooklyn, N. Y.              |                         |

II. Questions to be answered in writing:

1. Contrast the Lancaster Sheet (which represents a part of the "Driftless Area") with the Eagle Sheet (a glaciated area), and indicate the essential ways in which the two areas differ topographically.

2. Locate (a) terminal moraine belts and (b) outwash plains on at least two maps.

3. Interpret the peculiar topography shown on the Palmyra, N. Y., Sheet. How were the numerous hills formed, what are they called, and why do they all trend in the same direction?

4. Select three maps showing regions whose present topography is controlled largely by the drift; three where the topography is controlled chiefly by the underlying rock.

5. Under what conditions does drift control present topography? Under what conditions does the underlying rock control topography within the glaciated area?

6. The probable origin of the lakes on

(a) The Paradox Lake Sheet.

(b) The Eagle and Geneva sheets.

(c) The Leadville, Colo., Sheet, especially Twin Lakes.

7. What altitude appears to have been necessary to develop glaciers in the area of the Leadville and Hayden Peak sheets?

### REFERENCES.

#### A. EXISTING GLACIERS.

1. CHAMBERLIN AND SALISBURY, *Geologic Processes*, Vol. I, Chapter V: Henry Holt & Co., 1903; and other standard text-books on Geology.

2. RUSSELL, *Glaciers of North America*: Ginn & Co., 1897.

3. RUSSELL, *Glaciers of Mount Rainier*: 18th Ann. Rept. U. S. Geol. Surv., Pt. II, 1896-1897, pp. 349-415.

4. *Alaskan Glaciers*. REID, 16th Ann. Rept. U. S. Geol. Surv., Pt. I, 1894-1895, pp. 421-459, and Nat. Geog. Mag., Vol. IV, 1891, pp. 19-55. RUSSELL, Nat. Geog. Mag., Vol. III, 1891, pp. 176-188; Jour. of Geol., Vol. I, pp. 219-245; and 13th Ann. Rept. U. S. Geol. Surv., Pt. II, 1891-1892, pp. 7-91. GILBERT, *Glaciers, Harriman Alaskan Expedition*: Doubleday, Page & Co.

5. *Glaciers of Greenland*. CHAMBERLIN, Jour. of Geol., Vol. II, 1894, pp. 649-666 and 768-788; Vol. III, 1895, pp. 61-69, 198-218, 469-480, 565-582, 668-681, and 833-843; and Vol. IV, 1896, pp. 582-592. SALISBURY, Jour. of Geol., Vol. IV, 1896, pp. 769-810.

6. SHALER AND DAVIS, *Glaciers*: James R. Osgood & Co., 1881.

7. *Variations of Glaciers*. REID, Jour. of Geol., Vol. III, 1895, pp. 278-288; Vol. V, 1897, pp. 378-383; Vol. VI, 1898, pp. 473-476; Vol. VII, 1899, pp. 217-225; Vol. IX, 1901, pp. 250-254; Vol. X, 1902, pp. 313-328; Vol. XI, 1903, pp. 285-288; Vol. XII, 1904, pp. 252-263; and Vol. XIII, 1905, pp. 313-318. GILBERT, Bull. Sierra Club, Vol. V, pp. 20-25.

8. TYNDALL, *The Glaciers of the Alps*: Murray, 1860.

#### B. GLACIER MOTION.

9. CHAMBERLIN AND SALISBURY, *Geologic Processes*, Vol. I, pp. 308-323: Henry Holt & Co., 1903.

10. REID, *Mechanics of Glacier Motion*: Jour. of Geol., Vol. IV, p. 912.

11. AITKIN, Am. Jour. Sci., Vol. V, 1873, p. 305; Vol. XXXIV, 1887, p. 149; and Nature, Vol. XXXIX, 1888, p. 203.

12. RUSSELL, *The Influence of Debris on the Flow of Glaciers*: Jour. of Geol., Vol. III, p. 823.

#### C. RESULTS OF GLACIATION.

13. CHAMBERLIN AND SALISBURY, *Earth History*, Vol. III, pp. 327-446: Henry Holt & Co., 1906.

14. SALISBURY, *The Drift*: Jour. of Geol., Vol. II, pp. 708-724 and 837-851, and Vol. III, pp. 70-97.

15. CHAMBERLIN, *Genetic Classification of the Drift*: Jour. of Geol., Vol. II, pp. 517-538.

16. CHAMBERLIN, *A Preliminary Paper on the Terminal Moraines of the Second Glacial Epoch*: 3d Ann. Rept. U. S. Geol. Surv., 1881-1882, pp. 295-401.

17. J. GEIKIE, *The Great Ice Age*, 3d Ed.: D. Appleton & Co., 1895, and *Earth Sculpture*, Chapters X and XI: Putnams.

18. A. GEIKIE, *Scenery of Scotland*, chapters on *Glacial Action*: Macmillan Co., 1887.

19. *Folios of the U. S. Geol. Surv.*, especially those of the high mountains of the West.

20. LEVERETT, *Illinois Glacial Lobe*: Mono. XXXVIII, U. S. Geol. Surv.; *Glacial Formations, etc., of the Erie and Ohio Basins*: Mono. XLI, U. S. Geol. Surv. STONE, *Glacial Gravels of Maine*: Mono. XXXIV, U. S. Geol. Surv.



21. SALISBURY, *Glacial Geology of New Jersey*: N. J. Geol. Surv., Vol. V, 1902.

22. CHAMBERLIN, *Rock Scorings of the Great Ice Age*: 7th Ann. Rept. U. S. Geol. Surv., pp. 155-248, 1885-1886.

#### D. EXPLORATION IN POLAR REGIONS.

23. PEARY, *Northward over the Great Ice*: Fred. A. Stokes Co., 1898.

24. NANSEN, *First Crossing of Greenland*: Longmans, Green & Co., 1890; and *Farthest North*: Harper & Bros., 1897.

25. Most other books on the Arctic and Antarctic regions give some account of the ice.

#### E. GLACIAL LAKES.

26. TAYLOR, *Short History of the Great Lakes*, in *Studies in Indiana Geography*: Inland Publishing Co., Terre Haute, Ind., 1897. See also 20 above.

27. CHAMBERLIN AND SALISBURY, *Earth History*, Vol. III, pp. 394-403: Henry Holt & Co., 1906.

28. UPHAM, *Glacial Lake Agassiz*: Mono. XXV, U. S. Geol. Surv.

29. SALISBURY AND KÜMMEL, *Lake Passaic, an Extinct Glacial Lake*: Geol. Surv. of N. J.; Ann. Rept. of the State Geologist for 1893.

30. FAIRCHILD, *Glacial Genesee Lakes*: Bull. Geol. Soc. Am., Vol. VII, pp. 423-452.

## CHAPTER VI

### LAKES AND SHORES

#### GENERAL FACTS

**Definition.** In general, a lake is an inland body of standing water larger than a pool or a pond; but the term is sometimes applied to the widened parts of rivers (Fig. 324), and sometimes

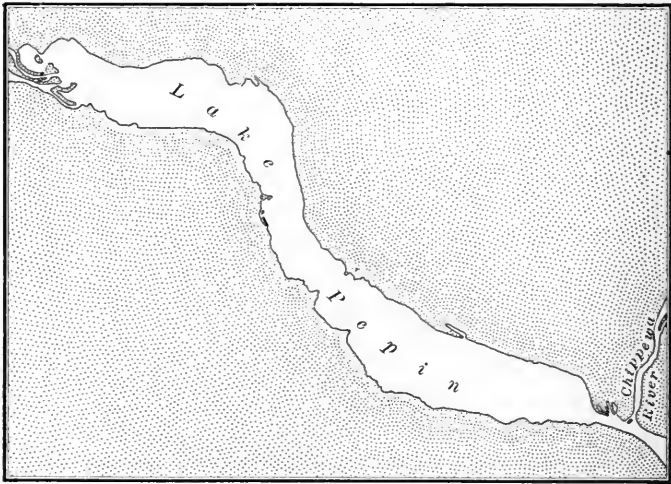

FIG. 324.—Lake Pepin, a widened part of the Mississippi River between Wisconsin and Minnesota. Maximum width about  $2\frac{1}{2}$  miles. The widening of the river is apparently due to the detritus brought down by the Chippewa River and deposited in the Mississippi. (Miss. Riv. Com.)

to bodies of water which lie along coasts, even when they are at sea-level, and sometimes when they are in direct connection with the sea (Pl. XX).

The distinction between lakes and similar bodies of water

which are not lakes is rather arbitrary. The amount of widening which a river must undergo before it is called a lake is as arbitrary as the size which the body of standing water must attain before this name may be applied to it. In the interior of the United States, a *pond* is usually understood to mean a body of water smaller or shallower than a lake; but this usage is not universal, for some beautiful lakes (for example, Green Pond in New Jersey) are called ponds. Ponds and lakes differ from inland seas, bays, and lagoons (1) in being more completely (in most cases altogether) shut off from the ocean, and (2) in being for the most part at a level above—very rarely below—that of the sea; but between bays and lagoons which are nearly enclosed, and coastal lakes, there are all possible gradations.

Most lakes are fresh, but a few, like Great Salt Lake and the Dead Sea, are much more salt than the sea itself.

#### *Distribution of Lakes*

1. *In latitude.* Lakes occur in most latitudes, but they are more abundant in high latitudes than in low. They do not abound, however, in all high latitudes. Northern Asia, for example, has relatively few. This distribution of lakes is connected with former glaciation, a connection which has already been pointed out.

2. *In mountains.* Lakes are abundant in some mountain regions but not in all. They are numerous in the western mountains of the United States, especially at the North, but they are essentially absent from the Appalachian Mountains south of northern Pennsylvania. They are, in general, more abundant in high mountains than in low ones, and if they occur in low mountains at all, it is likely to be in high latitudes only. In other words, lakes are common in mountains which have been recently glaciated.

3. *Along rivers.* Another situation where lakes occur, though less commonly, is along rivers; but they do not occur along all rivers. Outside of high latitudes and high mountains (glaciated regions), lakes are common only along streams which have low gradients and wide flats. There are numerous lakes, for example, on the alluvial plain of the Mississippi (Fig. 197), and on the flats of some of its tributaries, such as the Missouri and the Red

River of Louisiana (Fig. 325). In many of these cases the origin of the lakes is clearly connected with the changing of the river channel (Fig. 197).

4. *Along coasts.* Another situation where lakes are of rather common occurrence is along coasts (Pl. XX and Fig. 326), though many coasts are without them. Coastal lakes stand in no apparent relation to latitude and are always at low altitudes.

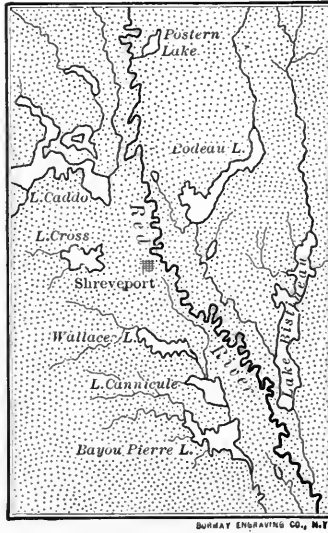

FIG. 325.—Lakes along the Red River of Louisiana. The lakes are at the lower ends of the tributary streams.

The level of the water in them is often nearly or quite the same as that of the sea.

5. *On coastal plains.* Low lands in proximity to the sea, though back from the coast, are sometimes affected by lakes, especially if the climate is moist. This is illustrated by Florida (Fig. 2, Pl. XX), where the number and abundance of lakes is comparable to that of equal areas in the northern part of the United States.

6. *Glaciated plains and plateaus.* Plains and plateaus which have been recently glaciated are likely to abound in lakes, as indicated in the preceding chapter.

7. *On plateaus.* Lakes sometimes occur on plateaus even where there has been no glaciation. The most considerable

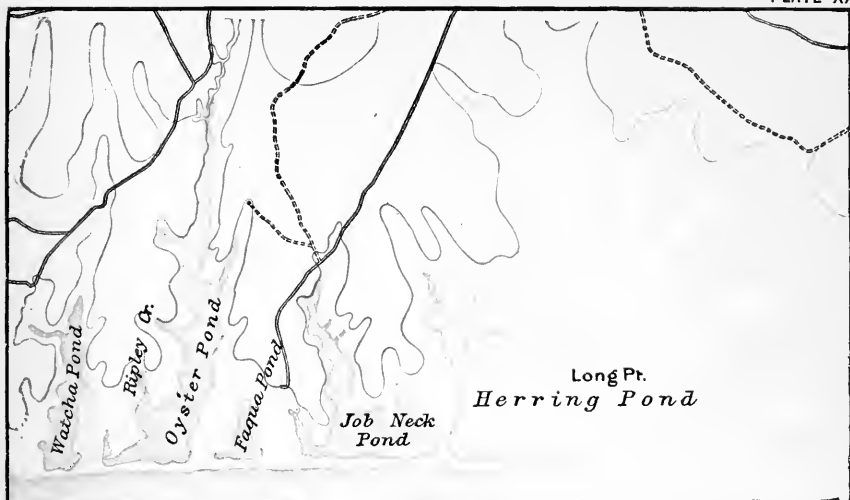

FIG. 1.—Coastal lakes formed by the blocking of the ends of drowned valleys. Scale 1—mile per inch. (Marthas Vineyard, Mass., Sheet, U. S. Geol. Surv.)

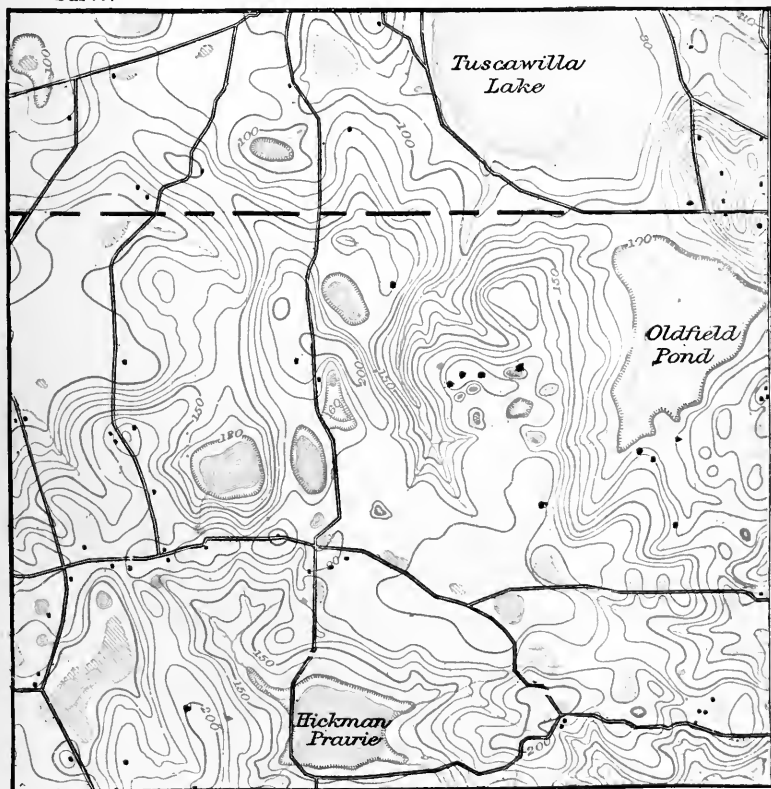
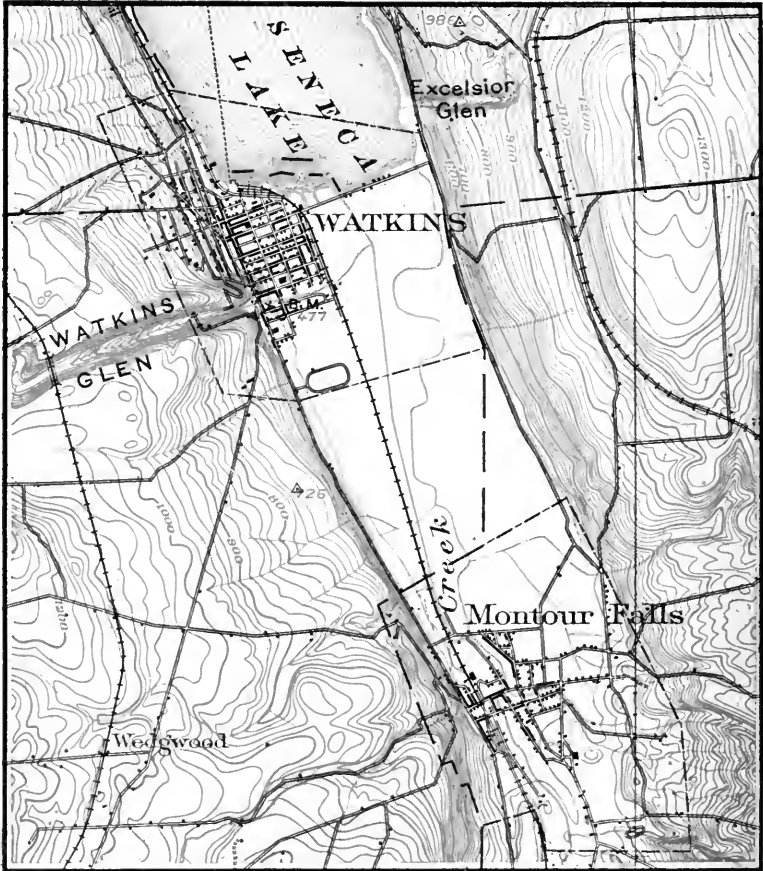

FIG. 2.—A group of lakes on the coastal plain of Florida. Scale 1—mile per inch. (Williston Sheet, U. S. Geol. Surv.)

PLATE XXI



The upper end of Seneca Lake, New York. The flat between Montour Falls and Watkins is a delta which has been built out into the lake by the inflowing creek. Scale 1— mile per inch. (Watkin's Sheet, U. S. Geol. Surv.)

examples are the great lakes of central and southern Africa; but there are not a few lakes, mostly shallow, on the Great Plains (plateaus) of the United States, even where the rainfall is not great.

8. *Other situations.* Lakes occur in a few other situations, as in the tops of some volcanic mountains, and on plains which have not been glaciated and which are far from the coast.

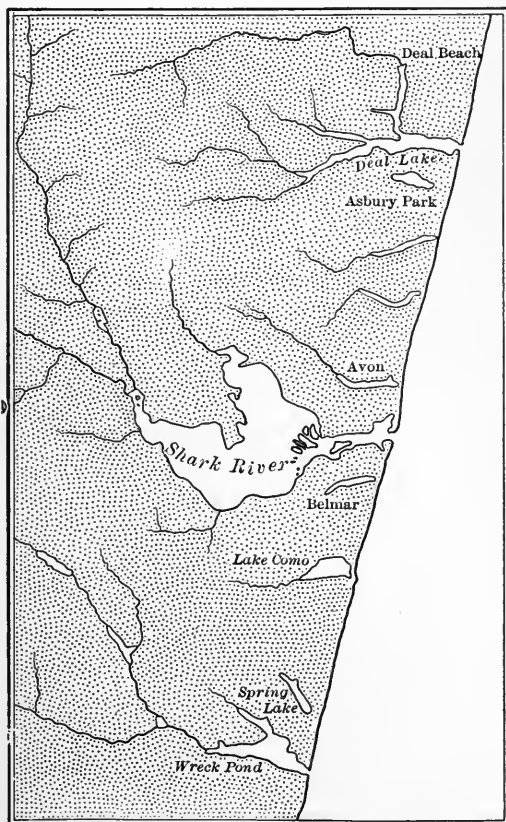

FIG. 326.—Lakes on the coast of New Jersey.

*Area, Topographic Position, Depth, etc.*

**Area and topographic position.** Lake Superior, Lake Huron, Lake Michigan, Lake Erie, and Lake Ontario are examples of great lakes. These lakes, indeed, constitute the greatest chain of lakes in the world, and have an aggregate area of nearly 95,000

square miles. Five of the great lakes of the Dominion of Canada have a combined area of more than 32,000 square miles. All these large lakes lie at relatively low altitudes.

Lakes have a great range in altitude as well as in size. The Yellowstone Lake is the highest lake of much size in the United States. It is 7738 feet above sea-level, and its area 140 square miles. Lake Titicaca, the largest lake (except Lake Maracaibo) in South America, is both higher (12,500 feet) and larger (3200 square miles). The surfaces of a few great lakes are below sea-level. This is true of the Caspian Sea (-85 feet), the Dead Sea (-1268 feet), and the Sea of Tiberias (-682 feet).

**Depth.** Most lakes are rather shallow. The number in which the water is less than 50 feet deep probably far exceeds the number in which the depth is greater; but some lakes are exceedingly deep. It need hardly be said that the popular notion that many lakes are bottomless, is without foundation. Many of the lakes which are locally believed to be without bottom are, indeed, shallow.

Lake Superior has a maximum depth of about 1000 feet, and Lakes Michigan, Huron, and Ontario all have depths exceeding 700 feet. Lake Erie, on the other hand, is much shallower, its maximum depth being only about 200 feet.

A few lakes have much greater depths. The deepest, so far as known, is Lake Baikal, in Siberia, which is stated to have a maximum depth of about 4700 feet, or about one-seventh the depth of the deepest part of the ocean. The Caspian Sea, really a lake, is next deepest, and has a maximum depth of about 3200 feet. Other lakes of great depth are Crater Lake, Oregon, about 2000 feet; Lake Tahoe, California, 1645 feet; Lake Chelan, Washington, about 1500 feet; and lakes Maggiore, Como, and de Garda, in northern Italy, and the Dead Sea, all of which have depths of more than 1000 feet.

The bottoms of most lakes are well above sea-level; but in exceptional cases their bottoms are far below. The lowest point in the bottom of the Caspian Sea is a little more than 3000 feet below sea-level, and the lowest point in the basin of Lake Baikal is nearly as far down. The lowest point in the bottom of Lake Ontario is about 500 feet below sea-level, in Superior about 400 feet, and in Lake Chelan more than 400 feet. Except in lakes along the coast, the bottoms of the small lakes are rarely so low as sea-



level; but the bottoms of the three north-Italian lakes mentioned are all several hundred feet below the ocean.

Various facts concerning the lakes which exceed 10,000 square miles in area, and concerning a few others, are given in the following table, though few lakes have such remarkable dimensions:

Name.	Approximate area in square miles.	Approximate altitude of surface. <sup>1</sup>	Approximate maximum depth in feet.
Caspian.....	170,000	—85	3,200
Superior.....	31,200	602	1,008
Victoria Nyanza.....	26,000	3,800	240
Aral.....	25,050	160	1,200
Michigan.....	22,500	581	870
Huron.....	22,320	581	700
Nyassa.....	14,200 <sup>2</sup>	1,500	2,300
Baikal.....	13,000	1,700	4,700 <sup>3</sup>
Tanganyika.....	12,000	2,700	2,100
Great Bear.....	11,200	390	270
Erie.....	9,960	573	200
Winnipeg.....	9,400	710	70
Balkash.....	8,600	900	80
Ontario.....	7,240	247	738
Chad.....	6,000 <sup>4</sup> to 40,000	900	8 to 20
Titicaca.....	3,200	12,500	700
Dead Sea.....	360	—1,268	1,300 <sup>5</sup>
Garda.....	189	215	1,135
Chelan.....	85	1,079	1,500
Como.....	60	650	1,340
Crater.....	25	6,239	2,000

Great as is the depth of the water in some of the lakes, the shape of their basins is often very different from that which might be imagined from the mere statement of the depths. Fig. 327 represents the cross-sections of the basins of some of the Great Lakes, drawn to scale. The basins of many smaller lakes (Fig. 328) are much more striking in cross-section.

**Volume.** No accurate estimate of the volume of water in lakes has ever been made, but their combined volume is insignificant when compared with the sea. If the water of all lakes were added to the ocean, it would probably not raise its surface two feet.

<sup>1</sup> The negative sign means below sea-level.

<sup>2</sup> Sometimes given as low as 10,200.

<sup>3</sup> Depth of 5,618 feet recently reported.

<sup>4</sup> Range between wet and dry seasons.

<sup>5</sup> Sometimes given as low as 1,171 feet.

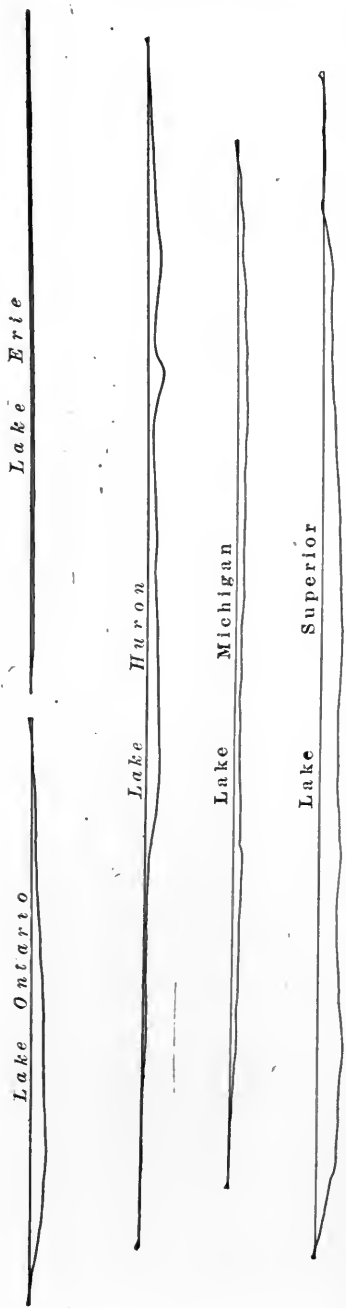

Fig. 327.—Cross-sections of the Great Lakes where their waters are deepest. Vertical scale exaggerated about twenty times.

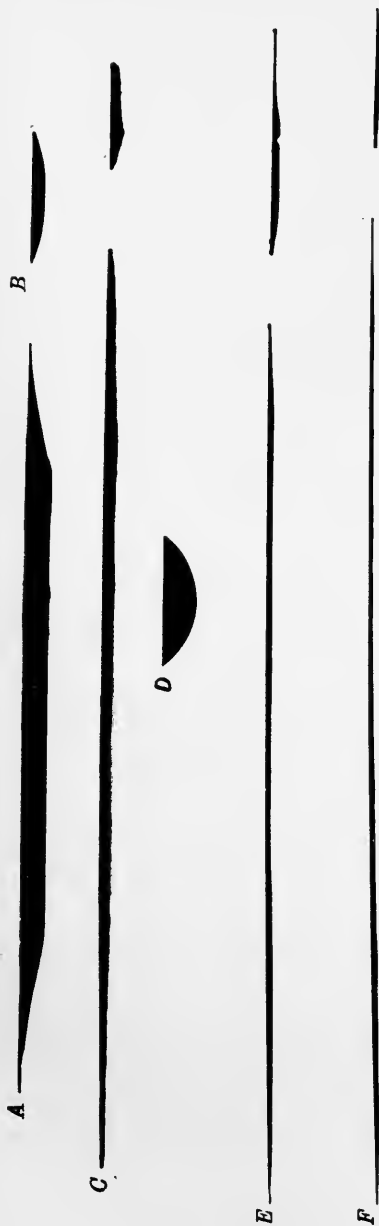

FIG. 328.—Sections of a series of small lakes. *A*, section across Lake Geneva, Switzerland, at the deepest point. Maximum depth about 1000 feet. *B*, section across Seneca Lake, N. Y. Maximum depth 618 feet. *C*, longitudinal and cross-sections of Lake Katrine, Scotland. Maximum depth about 500 feet. *D*, section across Lake Chelan, Wash. Maximum depth 1419 feet. *E*, longitudinal and cross-sections of Green Lake, Wis. Maximum depth 237 feet. *F*, longitudinal and cross-sections of Lake Geneva, Wis. Maximum depth 142 feet. Horizontal and vertical scales the same. One mile equals about two-thirds of an inch.

**Movements of lake water.** The waters of all lakes are affected by waves, and the waters of many lakes by movements of other sorts. In some lakes there is a more or less well-defined system of currents (Fig. 329) or drifts. A sudden change of atmospheric pressure on one part of a large lake causes changes of level everywhere. If the pressure is increased in one place, the surface of the water there is lowered and the surface elsewhere correspondingly raised. If the change is one which lessens the pressure locally, the water surface beneath the lessened



FIG. 329.—Diagram showing the currents in the Great Lakes. (U. S. Weather Bureau.)

pressure rises, while it falls elsewhere. Once these changes are set up, there is some pulsation of the water-level before equilibrium is again established. These movements are called *seiches*. Seiches have been much studied in the Swiss lakes. In very large lakes tides may be observed, though they are not usually detected except by instruments devised to record them. Slumping about the shores of a lake, earthquakes, etc., also cause movements of its waters.

**Changes of level.** The levels of lakes without surface outlets change notably from time to time, according to the amount of

precipitation on their surroundings. Many small lakes rise several feet in wet weather, and fall correspondingly in drought.

### *Conditions Necessary for the Existence of Lakes*

The conditions necessary for the existence of lakes are (1) *depressions without outlets*, and (2) *a sufficient supply of water*.

Depressions without outlets must not be understood to mean that lakes have no outlets. It means that, below the level of the lake-outlet, there is, in each case, a depression which has no outlet. It is this depression without an outlet which holds the water which makes the lake. When the water reaches the top of this depression it overflows.

A sufficient supply of water means enough so that water constantly<sup>1</sup> remains in the depression. If the bottom of a basin be of porous material, such as gravel, more water may be necessary, in order that water may stand in the depression, than if the bottom be of compact material like clay. If, however, the ground-water surface in the surroundings of the basin is above the level of the bottom of the basin (Fig. 330), the water will not escape from the



FIG. 330.—If the water table about a lake is above the lake level, there will be no leakage from the lake, even if its basin be of porous material.

basin, even if the latter be of porous material. The humidity of the atmosphere also affects the amount of water necessary for a lake. In moist regions, most considerable depressions without outlets contain lakes, while those of arid regions are often lakeless.

**The sources of lake water.** The sources of lake water are rain, melting snow and ice, springs and rivers, and immediate run-off. Since springs and rivers are dependent upon rain and snow, the source of lake water may be said to be atmospheric precipitation.

<sup>1</sup> There are temporary lakes, in the basins of which water is not always present.

*Changes now taking Place in Lakes*

Various changes are now in progress in all lakes, and a study of these changes throws light on the past and the future of lakes.

**The filling of their basins.** Lake basins are being filled constantly. In many cases, the filling will in time obliterate the basin, and the lake will then disappear. The filling takes place in various ways.

1. In the first place, all streams and other surface waters which flow into lakes bring sediment, and essentially all this sediment is left in their basins. This is shown by the fact that the streams which flow from lakes are usually clear, even when those which enter bear much sediment.

In some lakes deltas are being built, and a delta reduces the area of the lake in which it is built. In rare cases, deltas have been built across the middle parts of narrow lakes, separating the one lake into two, as at Interlaken, Switzerland. Deltas have been built at the ends of some of the Finger Lakes of New York, as shown in Pl. XXI, shortening them sensibly. Some of the important cities about these lakes are on deltas. Ithaca is an example. Sheet-floods and all rain-wash which enters a lake, even though not organized into streams, bring detritus to the basin and help to fill it.

2. Lake basins are also being filled by the work of the waves. The waves of lakes are cutting into their shores at some points most of the time, and most of the material thus worn from the land is deposited in the lake basin. The lake may extend its area by wave-cutting, but most of the material worn away from the shore is deposited in the lake basin.

Rivers and waves are the principal agents which are filling lake basins and diminishing the volume of their waters, but they are not the only ones.

3. Numerous shell-bearing animals live in lakes. The material for their shells is extracted from the water, and the shells are left on the bottom when the animals die, thus helping to fill the basins.

4. Plants grow in lakes, especially in their shallow borders, and the organic matter helps to fill the basins when the plants die. Some lake plants secrete lime carbonate and others silica,

and these materials help to fill the basin the same as the shells of animals.

5. Winds blow dust and sand from the land into lakes, and thus help to fill their basins.

In all these ways the lake basins are being gradually filled.

**The lowering of their outlets.** Most lake basins are being affected in another way. The water flowing out of a lake cuts down the level of the outlet, and, as this is lowered, the depth of the basin below the outlet is diminished. The limit to which the out-flowing water may cut the outlet of the lake is base-level.

**Fate of lakes.** A lake may be destroyed by the lowering of its outlet, if its bottom is sufficiently high; but where the bottom is below sea-level, river erosion could never cut the outlet down to it. In such cases, filling and cutting may accomplish what cutting alone could not. As a result of these processes, all existing lakes must ultimately become extinct. In their destruction, rivers are probably the most important agents. Their relation to lakes is such as to have led to the epigram: "Rivers are the mortal enemies of lakes." This has especial reference to lakes which are not on valley flats.

Lakes are occasionally destroyed by drying up. This sometimes results from a change of climate, but it may also result from a diversion of inflowing waters.

### *The Origin of Lake Basins*

Lake basins originate in many different ways. Most of them are the result of gradational processes, but some of them are due to vulcanism and some to diastrophism, and, while these latter topics have not yet been studied, we may anticipate their consideration sufficiently to note the ways in which they produce depressions without outlets in the surface of the land.

*Diastrophism.* This term includes all crustal movements, whether up or down. Movements of the earth's crust give rise to basins in various ways. There are often basin-like depressions beneath the shallow water over the continental shelves. If such areas were converted into land, either by their own rise or by the withdrawal of the sea from them, the basins would appear on the surface of the new land. Newly emerged portions of the sea bottom are therefore regions where lake basins sometimes occur.

Some of the lake basins of Florida and of the plains of Siberia perhaps arose in this way. At the outset, lakes in such basins would be salt, but they might become fresh (p. 314).

A lake basin may arise by crustal warping within land areas. Thus, if a portion of a flat area were warped downward, while its surroundings were not, there would be a basin, and, under proper climatic conditions, it might become the site of a lake.

Lake basins may originate by the warping of a river valley, where the warping leaves one part of the valley higher than a part farther up-stream. The up-warp constitutes a dam, and the waters above are *ponded* (p. 174) and a lake produced. This origin has been assigned to the basin of Lake Geneva in Switzerland. Lakes produced in this way are likely to be but short-lived, for in most cases the outflowing water would soon cut down the obstruction.

A portion of a valley may sink through faulting, thus giving rise to a basin. Such an origin has been ascribed to the basin of the Dead Sea and to certain lakes in Oregon (Figs. 39 and 331).



FIG. 331.—Section showing the structure of the rock about Abert and Warner Lake, Oregon. (U. S. Geol. Surv.)

According to one interpretation, Lakes Stefanie, Rudolf, Albert, Tanganyika, Leopold, and Nyassa, in Africa, all lie in a great *rift* (or sunken) *valley*.

Lakes have probably originated at various times in the past when mountains have been made by the folding of rock strata. Wherever two parallel folds are developed in the surface of the lithosphere, a trough is formed between them. Such troughs have probably sometimes been deeper in the middle than at either end, and lakes have probably resulted. Lakes made in this way would be short-lived, as a rule, since they are situated favorably for receiving abundant drainage, and the outflowing water would soon reduce the outlets so as to drain them. It is sometimes difficult to distinguish between basins produced by faulting and those produced by warping, especially if the solid rock is covered by a heavy mantle of drift or soil. Thus lake basins are known to have originated during earthquakes, sometimes it may be by warping, but perhaps more commonly by faulting. In 1811 and



1812 a considerable area in the Lower Mississippi Valley sank during a time of earthquakes. One of the areas most depressed became the site of Reelfoot Lake, which lies in the flat of the Mississippi, partly in Tennessee and partly in Kentucky.

*Vulcanism.* In the tops of some extinct volcanic mountains there are basins known as *craters*, some of which are occupied by lakes. Such lakes occur near Rome (Lake Nemi), Naples (Lake Averno), and in France. Ponds or small lakes are known in craters in many other places, even in such dry regions as Nevada and northern Arizona. Streams of lava sometimes obstruct river valleys, giving rise to lakes. Snag Lake, in California, and Tiberias Lake, in the valley of the Jordan, are illustrations. Others occur in France and in other regions of recent volcanoes. Crater Lake in Oregon (Figs. 333 and 334), a lake five or six miles in diameter and 2000 feet deep (p. 297), occupies a basin or *caldera* made by the sinking of the top of a volcanic mountain. While it lies in a depression in the top of an extinct volcano, its basin is really due to diastrophism rather than vulcanism. This lake is of such extraordinary interest that the area about it has been set off as a National Park. The general conception of its history is represented by the hypothetical Figs. 335 and 336, the former representing the volcanic mountain as it is supposed to have been before the top sank in, and the latter the present basin, free from water. The island in Figs. 333 and 334 is a small volcanic cone developed since the sinking of the top. Basins which become the sites of lakes occasionally develop on the surfaces of lava-flows, perhaps as the result of the changes of surface incident to cooling.

*Gradation.* Various agents of gradation produce lake basins, and some of them produce them in several different ways.

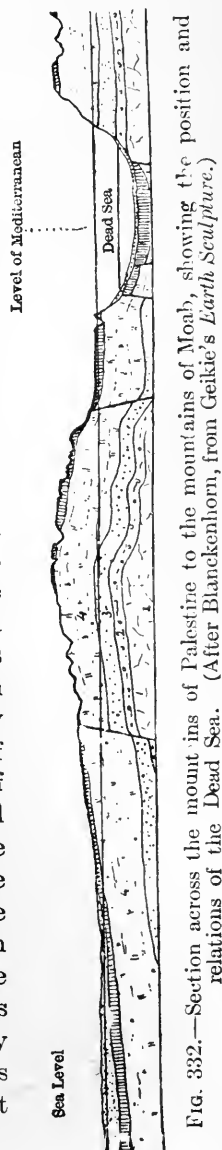

Fig. 332.—Section across the mountains of Moab, showing the position and relations of the Dead Sea. (After Blanckenhorn, from Geikie's *Earth Sculpture*.)

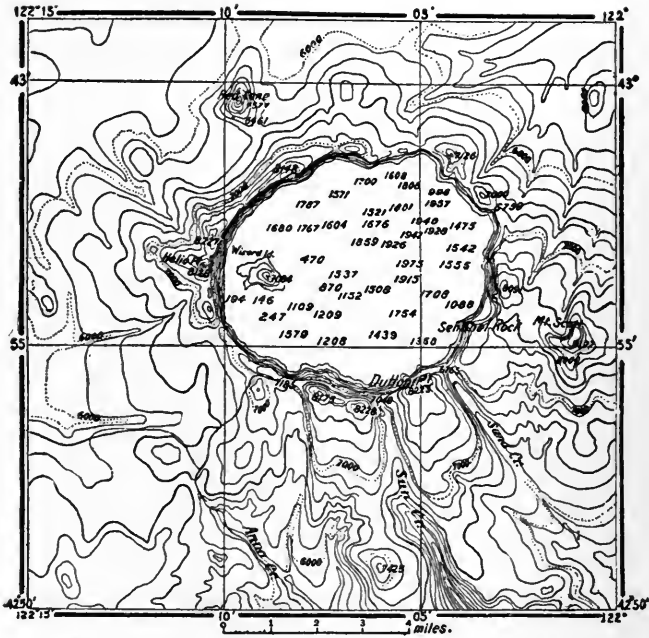

FIG. 333.—Map of Crater Lake, Ore. Contour interval 200 feet. Soundings in feet. Lake surface 6239 feet above the sea-level. (U. S. Geol. Surv.)



FIG. 334.—Western border of Crater Lake from Victor Rock to Llao Rock. (U. S. Geol. Surv.)



FIG. 335.—Mount Mazama (the name given to the former mountain where Crater Lake now is), as it is conceived to have been before the collapse which gave rise to the lake basin. (U. S. Geol. Surv.)

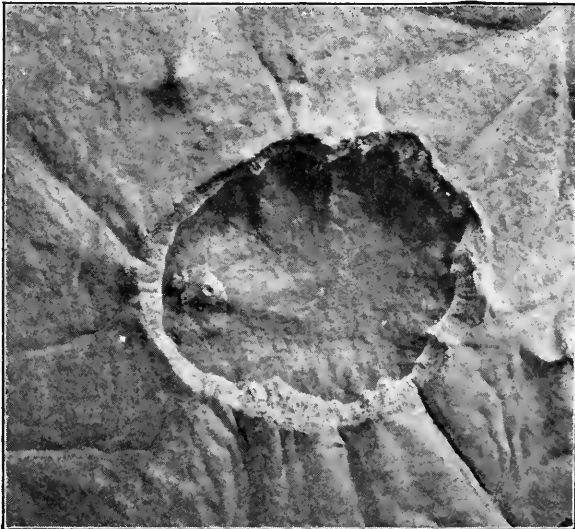

FIG. 336.—The rim of Crater Lake. (U. S. Geol. Surv.)

**1. River lakes.** Reference has already been made (p. 293) to lakes on the flood plains of streams, formed by the meandering and later the cutting off of the streams; but rivers give rise to lakes in other ways. If a tributary brings to its main more sediment than the latter can carry away, the excess is deposited as an obstruction, and ponds the water above (Fig. 324). If a main stream aggrades its channel, it tends to obstruct the inflow of its tributaries, giving rise to lakes along them. This has been the commonly accepted explanation of the lakes along the Red River of Louisiana (Fig. 325); but it now appears that the obstructions to the tributaries are due to organic accumulations, rather than to sediment in the ordinary sense of the term.<sup>1</sup>

It is well known that "rafts" sometimes form in streams. The "rafts" are jams formed of timber which falls into the river as the result of the caving in of the forested banks, due to lateral planation of the meandering stream. The trees thus floated down the stream lodge against the banks at favoring points, and once this lodgment is started, the jam continues to grow. The branches of the trees greatly aid in the growth of the raft by helping to catch and hold the floating trees.

The Red River is known to have been the site of a great raft. It commenced to form somewhere below Alexandria (Fig. 336a), and its head had reached the vicinity of Alexandria by the latter part of the sixteenth century. The raft was really a series of more or less disconnected jams, each completely filling the river. The effect of the early jams was to pond the water of the river above, and to force it out of its old channel through low places in its banks. The whole river was thus diverted to a new course below Alexandria (Fig. 336b). Driftwood accumulated about the new outlet, forming another jam, and in this way the raft gradually grew until it extended itself up the river about 160 miles. Between 1820 and 1872, its average rate of growth was about four-fifths of a mile per year, but in two instances accumulations of over five miles are recorded during freshets. As the raft grew up-stream, it obstructed tributaries, and developed lakes along them.

There is no good record of the lakes along the lower part of the raft-ridden section. At the time of the early settlement, its

<sup>1</sup> Veatch, A. C., Professional Paper 46, U. S. Geol. Surv., 1906.

lower end was near Natchitoches, and the location of this city was largely determined by the fact that the foot of the raft was the head of ordinary navigation. Record of the lakes along the upper portion of the raft is much fuller. The group of lakes near Shreveport was formed near the end of the eighteenth century. Before 1873, when the raft was finally removed, it had advanced almost to the Arkansas line, forming Poston Lake, the most northerly of the series (Fig. 336a).

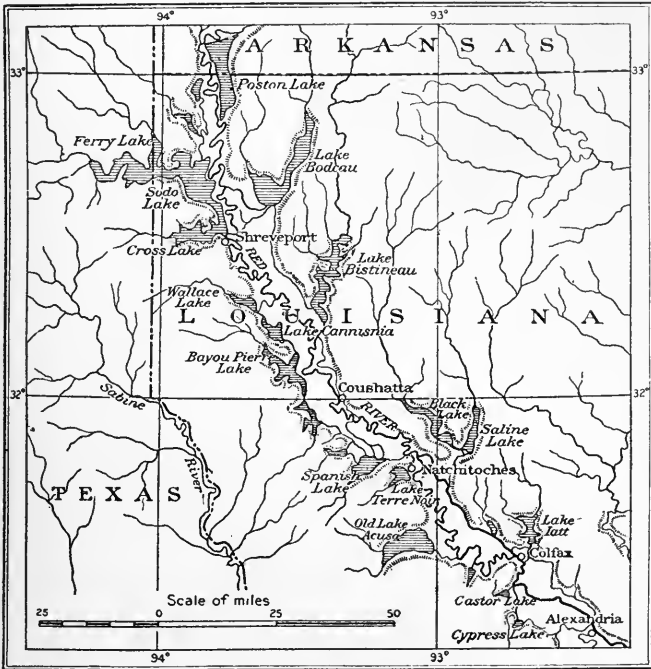

FIG. 336a.—The lakes of Red River Valley, La., at their fullest recorded development. (Veatch, U. S. Geol. Surv.)

Since the removal of the raft, the river has lowered its channel 15 feet at a point 15 miles above Shreveport, and 3 feet at Shreveport. As a result of the deepening of the channel, tributaries have lowered their valleys in the attempt to adjust themselves to their main stream, and the lakes are being drained. In many places land which was formerly covered by lake water is now under cultivation. When the topographic adjustment of the tributaries has

been completed, other areas still submerged will also be available for cultivation.

Rivers are partly or wholly responsible for a class of lakes which may be called *delta lakes*. Lake Pontchartrain in Louisiana is an example (Fig. 209). Here detritus brought down by the river

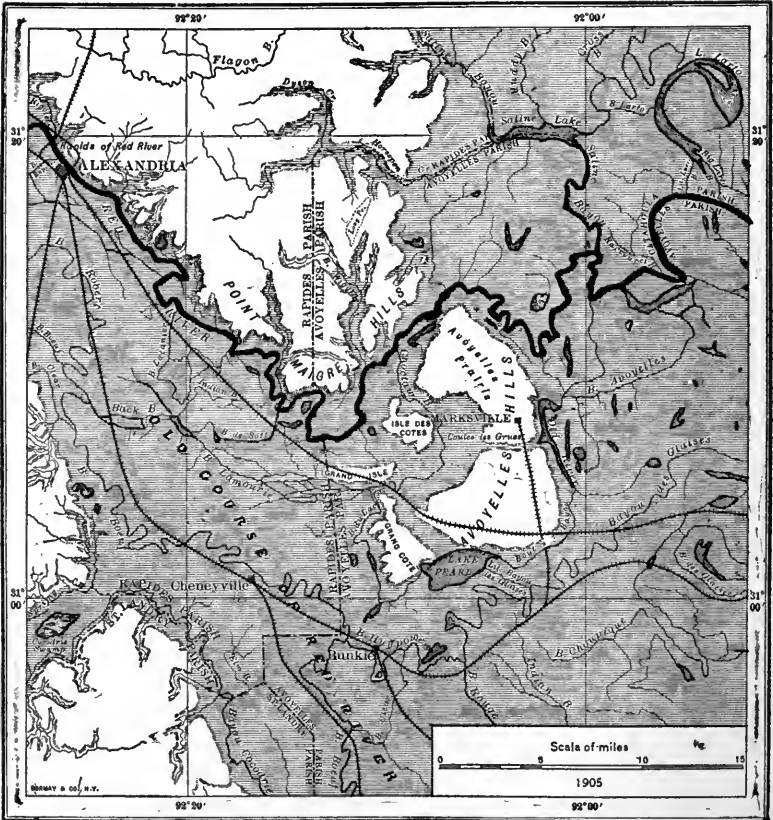

FIG. 336b.—Map showing the diversion of the Red River below Alexandria. The shaded areas are subject to overflow. (Veatch, U. S. Geol. Surv.)

was deposited around an area of shallow water, converting the latter into a basin. Marshes and ponds and lakes are sometimes made by the building of alluvial cones or fans across a valley. Lake Tulare in California owes its basin to an alluvial fan made by a stream (King River) descending from the Sierras.

2. **Waves and shore currents.** Waves and shore currents give rise to lakes by shutting in the drowned ends of valleys or other bays. Illustrations are numerous along many coasts (Pl. XX and Fig. 337).

3. **Glacial lakes.** The relation between the distribution of lakes and the distribution of ice in former times is so close that it cannot be looked upon as accidental, and the study of lakes has shown that many of their basins are due to glaciation. Glaciers give rise

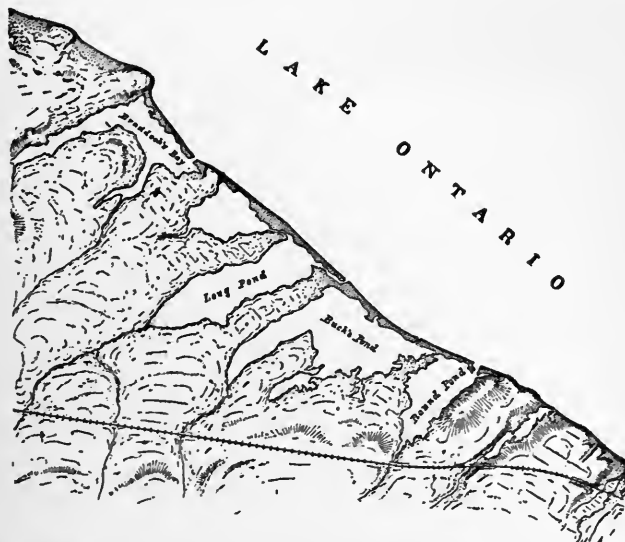

FIG. 337.—Maps showing lakes (ponds) along the shore of Lake Ontario, shut off from the main lake by sand-bars. (U. S. Geol. Surv.)

to lake basins in many ways, some of which have already been mentioned.

a. The mountain glacier descending over a steep slope often digs out a basin at the base of that slope (Fig. 338). Hundreds of lake basins in the valleys of the western mountains of the United States, and many in similar positions in other parts of the world, were formed in this way. Such lakes are usually small. They occupy rock basins, and often lie in cirques (p. 247, and Pl. XVIII).

b. Where glaciers pass over rocks of unequal hardness, they sometimes erode the weaker more than the stronger, thus gouging out hollows. Lake basins formed in this way are common in

mountain valleys, and are not unknown within the area covered by the ice-sheets.

Lake basins of the above types are due to *glacial erosion*.

c. A glacier descending a mountain valley may obstruct the lower end of a tributary valley, giving rise to a lake above. Such a basin has been called an *ice-barrier basin*. The Marjelen See in Switzerland is an example of such a lake. Many former lakes due to ice barriers, for example Lake Agassiz, have become extinct.

d. By far the larger number of lake basins due to glaciation arose through the disposition of the debris which the ice carried



FIG. 338.—Shadow Lake, in a rock basin of glacial origin, near the head of San Joaquin Valley, Sierra Nevada Mountains, Cal. (Fairbanks.)

and left on the surface when it melted. Of such basins there are many varieties: (1) The terminal moraines of mountain glaciers often cross and obstruct valleys, giving rise to basins and so to lakes (Fig. 289). (2) In many other cases, drift is so deposited with relation to a rock slope as to leave a depression between the main body of drift and the rock. Basins of this sort are enclosed partly by solid rock and partly by drift. Illustrations are furnished by many of the lakes of the United States and Europe. (3) Drift may fill a valley at two points, leaving the intermediate portion unfilled. The intermediate part becomes a basin and, under proper conditions of water-supply, a lake. (4) Other lake basins owe their origin to the unequal disposition of the drift itself. Probably the larger number of lake basins in the northern part of North America and northern Europe are merely depressions in the surface



of the drift. Lakes whose basins are of this type are not among the larger or the deeper lakes.

In some of the states within the glaciated area of North America, ponds and lakes are numbered by the thousand. The area of the lakes in Minnesota alone has been estimated at more than 5000 square miles.

Many glacial lakes owe their origin to a combination of the above conditions and relations. Here belong the Great Lakes. As already indicated, these basins are probably due (1) partly to glacial excavation, which gouged them out to considerable depths; (2) partly to the piling up of the debris thus eroded about the rims of the basins; and perhaps (3) partly to the downward warping of the surface beneath the water.

**Lakes due to slumping.** Valleys are sometimes obstructed by landslides, thus giving rise to basins which become the sites of lakes. Such a lake, five miles long and more than seven hundred feet deep, was formed on the Upper Ganges in 1892. Two years later, the dam which held back the water broke, and the resulting flood wrought great destruction in the valley below.

**Solution, weathering, wind, etc.** Basins suitable for ponds and lakes sometimes originate by solution of the underlying rock. Limestone sinks (p. 97) may become the sites of ponds and perhaps of lakes, but considerable basins of this origin are not known. Basins are sometimes formed by solution of the surface rock. Some of the lake basins of Florida probably arose in this way.

The surface of rock weathers (p. 110) unequally. If the weathering of one area is greater than that of its surroundings, the weathered material may be blown away, leaving a depression suitable for holding water. Wind-driven sand sometimes scours out small depressions which hold pools of water, though basins of such size as to become the sites of lakes are not known to have originated in this way. Eolian sand is sometimes piled up about low places, enclosing them, thus giving rise to marshes, ponds, and even lakes.

**Glacial lakes an index of topographic age.** Since rivers are antagonistic to lakes, and since rivers are always active, it follows that a region of abundant lakes is a region in its topographic youth, unless the lakes are in valley flats. Lakes at high altitudes are of relatively recent origin.

## SALT LAKES

While most lakes are fresh, a few, such as Great Salt Lake, the Caspian, Aral, and Dead seas, are salt. Salt lakes are found chiefly in arid climates.

Fresh lakes may become salt, and salt lakes may become fresh. These changes are usually the result of changes of climate. If aridity increases so that evaporation from a fresh lake exceeds the intake (precipitation and inflow), a fresh lake may become salt. If evaporation from a salt lake becomes less than the intake of fresh water, the lake will be freshened, and, under proper conditions, may become altogether fresh. The best-known illustration of these changes is furnished by Great Salt Lake and the earlier lake which preceded it in the same region.

1. The first lake which occupied this basin appears to have been fresh. A climatic change seems then to have taken place, a relatively humid climate giving place to an arid one. When this change had been accomplished, evaporation from the surface of the lake exceeded the intake of fresh water, and the level of the lake was lowered. As the water evaporated, the mineral matter which it held in solution was left behind. Salt was one of these substances, and as more and more water evaporated, the salinity of that which remained increased, and the lake became salt.

2. Another change of climate, this time in the direction of increased humidity, ensued. The intake of fresh water then exceeded evaporation from the lake, and the saltiness of the water was diminished by dilution. At the same time, the level of the lake rose until it overflowed, finding an outlet by way of Snake River to the Columbia. The continued inflow of fresh water and the continued outflow of the diluted salt water resulted in the progressive freshening of the lake, and it finally became fresh. The expanded lake of former times in this basin is known as *Lake Bonneville* (Fig. 339), which, at its maximum, covered an area of about 17,000 square miles. Its surface was about 1000 feet higher than that of Great Salt Lake.

Another change of climate, this time in the direction of aridity, reduced Lake Bonneville. Its surface sank below its outlet, and, as this happened, its waters gradually became saline. Evapora-



by lakes and inland seas which are now extinct, are the chief sources of salt.

Accessible salt deposits and "salt-licks" determined, or helped to determine, the location of numerous early trans-Allegheny settlements, as in the Blue Grass region of Kentucky.

### *The Climatic Effects of Lakes*

The great number of lakes in the northern parts of the United States and Europe have some influence upon the climate of the regions in which they occur. They increase its humidity to some slight extent at least, and, since water is heated less readily than the land and gives up its heat less readily, the lakes have the effect of tempering the climate. Until they freeze over, they tend to keep the temperature of their surroundings a little higher than it would otherwise be in the autumn and early winter, and to reduce the temperature of spring. The temperature effects of lakes are felt chiefly on the sides toward which the prevailing winds blow.

### *Economic Advantages and Disadvantages*

The question as to whether lakes are beneficial or harmful to mankind may be looked at from various points of view.

1. The Great Lakes serve as highways and make cheap transportation possible. In this way they serve a good purpose, as shown by their extensive commerce.
2. Many cities, like Chicago, draw their water-supply from lakes. A city located as Chicago is could not readily get an adequate supply from any other source, except at far greater cost.
3. Lakes furnish a certain amount of food material, especially fish.
4. By tempering the climate, they modify, to some slight extent at least, agricultural pursuits. Thus the prevailing westerly winds temper the climate of the east shore of Lake Michigan in such a way as to make it favorable for fruit-growing, while the west side of the lake, affected by winds not tempered by the lake, is not favorable for this industry. In these and other ways the lakes seem to serve mankind.

On the other hand, it is to be remembered that such a body of water as Lake Michigan occupies some 22,450 square miles of surface, much of which would, presumably, have been good farming land, if the lake basin had not been made. The value of such an

area of good farming land might offset, or more than offset, the economic advantages of the lake.

Small lakes are of little consequence as highways, and the modifications of climate which they effect are slight. The same may be said of marshes. There can be no doubt that if all the area occupied by lakes were cultivated land instead, the returns would be much greater than those which now accrue from any uses to which the lakes are put. But lakes have a value not to be estimated in dollars and cents. They beautify the landscape and afford the means for rest and recreation which could not well be spared. The actual value of such considerations is not easy of definite estimate.

The advantages which a primitive people may derive from a location upon the shores or islands of a lake are suggested by the fact that the earliest European civilization arose about the lakes of Switzerland, while the lakes of Mexico and Peru were the seat of the ancient civilizations of those countries.

#### THE TOPOGRAPHIC FEATURES OF SHORES

In connection with the discussion concerning changes now taking place in lakes, reference was made to certain topographic features of lake shores, because their development has a bearing on the history of lake basins, and so on the life of the lakes themselves; but the topic is of such importance that it merits more than incidental mention.

The topographic features developed by lakes along their shores are similar to those developed by the sea along its coasts, except that the latter are on a larger scale. A discussion of the development of the topographic features of lake shores is therefore applicable, in most of its details, to the shores of the sea.

Gradation is affecting the shores of oceans and lakes everywhere; diastrophism is affecting them in many places, though not universally, at least not to such an extent as to be sensible from year to year, while the effects of vulcanism on shores are very limited and of little consequence in this connection.

#### *Gradational Changes now taking Place along Shores*

Waves, currents, rivers, winds, glaciers, ice formed along the shore, and various other agencies are working on the shores of

seas and lakes, and each has some effect on the coast-line. Of these, the waves and the movements of the water to which the waves give rise, are the most important.

1. *Waves, Undertow, Shore Currents.* The top of a wave is its *crest*, and the depression between two adjacent crests is the *trough*. The vertical distance between the crest and the bottom of the trough is the *height* of the wave, and the horizontal distance between two adjacent crests is the *length*. The time which it takes one crest or one trough to travel the length of the wave is the *period* of the wave. In the open sea, storm waves often have a height of 20 to 30 feet, and in rare cases even 50 feet. On the shore their heights may be much greater, as we shall see. The length of great waves may be as much as 1500 feet, and the velocity as much as 60 miles per hour. Such lengths and velocities are, however, far beyond the average.

In the open sea wave motion does not involve the forward movement of the water. Each particle of water describes a curve, and theoretically comes to rest at the point whence it started, though the *wave form* moves on. Some conception of the motion involved may be gained from a waving field of grain or grass, where each moving stem is fixed to the ground, though wave after wave crosses the field; or from a long piece of rope one end of which is fixed, while the other end is shaken up and down. Successive waves travel from the shaken end to the other end.

Fig. 340 gives some idea of the nature of the movement of the water in the waves of the open sea.



FIG. 340.—Diagram to illustrate the movement of water in waves. The small circles represent the movement of water particles.

If the water in a wave moved forward at the velocity at which the wave form travels, the sea would hardly be navigable.

When the wind is very strong, the top of a wave may be blown forward, that is, the wave "breaks," and so has a motion independent of the true wave motion. Even when the waves do not break, the surface water is slipped along to some extent by the moving air.

High waves in the ocean are often called "seas," and when a sailor says that there is a "high sea," he means that there are high

waves. The destructiveness of waves in the open sea depends quite as much on their length as on their height. With a given height, the longer the wave, the less its destruction.

Waves generated by a storm often run far beyond the place where they were started. They diminish in height, but keep their velocity and their length if the water is deep and the waves are unobstructed by islands, etc. Waves which have outrun the storm which started them constitute the *swell* or the *ground-swell*. In the case of great hurricanes, destructive waves are sometimes felt a thousand miles from the storm. This was the case on the coast of New Jersey in 1889, when the storm was to the south. As a result of storms in different places, the open sea is never altogether quiet.

As a wave advances from the open sea into shallow water, it undergoes notable changes. Where the water is so shallow that wave motion is sensible down to its bottom, the wave "drags" bottom. The velocity and the length of the wave are then diminished, and its height increased. The top then pitches forward as *surf*.

In strong winds and in shallow water, therefore, there is a distinct forward movement of some of the water of a wave. Waves in which there is pronounced forward movement are sometimes called *waves of translation*.

The water thrown against the shore in the *wave* runs back again, and this from-shore motion is the *undertow*. The undertow tends to run down the steepest slope, but it is often directed obliquely by incoming waves. Its movement is checked, too, by every incoming crest.

Where waves strike a shore obliquely, the water moves more or less along shore, and the sum of these movements along shore gives rise to a *shore* or *littoral current*.

The waves, the undertow, and the shore currents all affect the shore. The waves erode the shore-line in some places, and all of these movements erode the bottom in some places. All the sediment acquired by erosion is deposited sooner or later. Whether the movements of water along shores erode or deposit, they affect the outline of the coast, and often its vertical configuration.

The amount of motion in waves diminishes rapidly downward, and is insensible below a few hundred feet. Submarine structures, such as piers, etc., are rarely disturbed below 30 feet.

**The erosive work of waves.** The force of the wave as it is hurled against the shore is often great. The surf is sometimes thrown up to heights of more than 100 feet with force enough to destroy lighthouses and even cliffs of rock. Windows of the Dunnet Head lighthouse on the coast of Scotland are said to have been broken at heights of 300 feet above sea-level during severe gales. In some cases the bursting of doors and windows during such storms appears to be due to the explosive action of the air within the buildings, as the surf dashed against them falls back. It has been estimated that, in exceptional storms, the strength of waves on the exposed coast of Britain has been as much as three tons per square foot, and that the average force of winter waves is about one ton per square foot. Such waves would move masses of rock tons in weight. It is clear, therefore, that the force of waves is adequate for powerful erosion.

If a coast-line were regular, but composed of rock of unequal hardness, it would not be likely to remain regular, so far as wave erosion is concerned, for the waves would wear the weaker rock more and the stronger rock less. The result would be the development of reëntrants on the weaker rock, while the stronger rock would remain as projections of land into the sea (Fig. 341). Under these circumstances the irregularities of the coast would go on increasing, so far as wave erosion is concerned, until the reëntrants had become so deep that the diminished force of the waves in them would wear the weaker rock at those points no faster than the stronger waves wear the harder rock of the projecting points between. When this stage is reached, the shape of the coast-line is stable, so far as wave erosion is concerned. Since coast-lines are made of stronger and weaker rock structures, irregularities of this sort are constantly in process of development. They become greater along seacoasts than along lake shores, because the waves of seas are stronger than those of lakes.

Where a coast is very irregular, especially where there are projections of land into the sea, the waves attack projecting points of

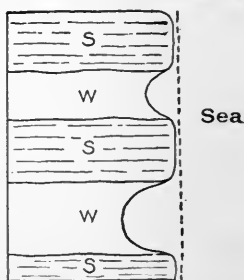

FIG. 341.—Diagram to illustrate the effect of wave erosion on rocks of unequal hardness. Starting with a straight line, indicated by the dotted line, the erosion of the waves would develop some such outline as shown: W, weak rock, and S, resistant rock.



land more forcibly than they attack the reëntnants, such as the heads of bays. The projecting points are thus worn back more than the heads of the bays. Where a coast is very irregular, therefore, wave erosion tends to reduce its irregularities, unless the projecting points are of rock which is much more resistant than that of other parts of the coast.

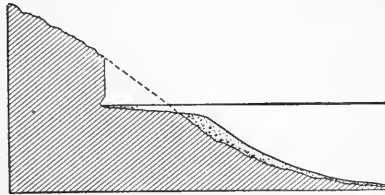

FIG. 342.—Diagram illustrating high sea cliff. It shows also a submerged terrace, due partly to wave-cutting and partly to building.

We conclude, therefore, that wave erosion tends to develop small irregularities of coast-line, but not great ones. Their extent is dependent upon (1) the "fetch" of the waves, that is, the distance they have been traveling, (2) the strength of the winds, (3) the depth of the water, (4) the exposure of the coast attacked, (5) the kind and abundance of the tools (such as gravel, boulders, etc.) with which the waves work, and (6) the resistance of the rock against which the waves beat, the resistance being determined partly by hardness and partly by structure.

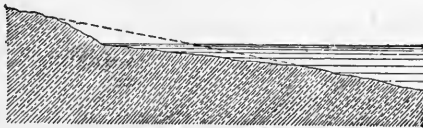

FIG. 343.—Diagram showing a low sea cliff.

Without tools to work with, waves would be relatively ineffective against hard rock which had no bedding or jointing planes. Thus on the Outer Hebrides, barnacles are said to be as abundant after a storm as before, where gravel and stones of suitable size for the waves to move are absent. Rock affected by cleavage planes, whether bedding or jointing, may be effectively worn by waves, irrespective of the debris which they move.



FIG. 344.—A high sea cliff, La Jolla, Cal.



FIG. 345.—A high cliff with a beach, shore of Lake Michigan.  
(U. S. Geol. Surv.)

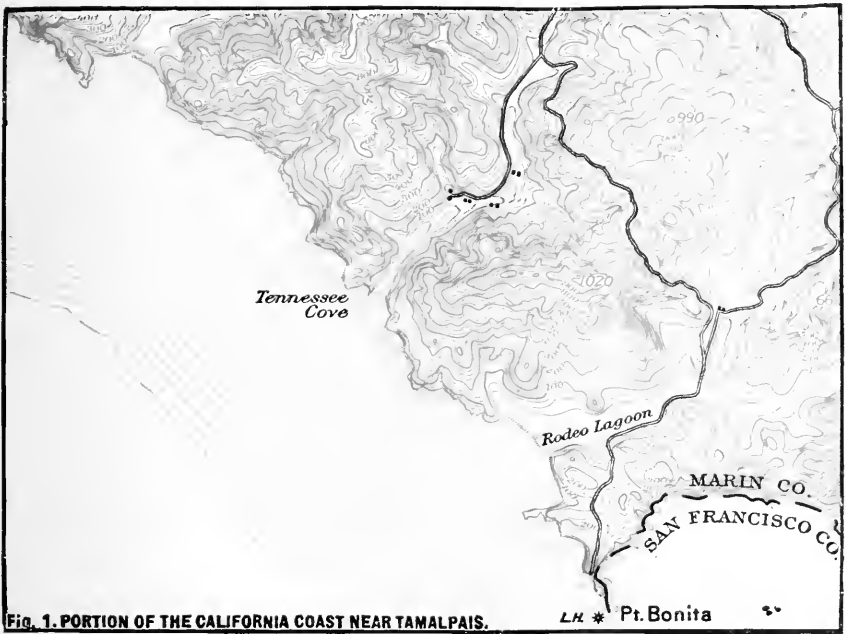

**Fig. 1. PORTION OF THE CALIFORNIA COAST NEAR TAMALPAIS.**

FIG. 1.—A coast line developed chiefly by wave erosion. Scale 1—mile per inch. (Tamalpais, Cal., Sheet, U. S. Geol. Surv.)



**Fig. 2.—An island tied to the mainland by a "beach."** Scale 1—mile per inch. (Boston Bay, Mass, Sheet, U. S. Geol. Surv.)



Irregularities developed by wave erosion are extremely numerous. Here belong very many, if not most, of the small projections of high land into the sea. Their outlines are often somewhat angular (Fig. 1, Pl. XXII). Here, too, belong the islands of some coasts, especially those of solid rock, many of which have been isolated from



FIG. 346.—Steep cliff developed by waves; Allen Point, Grand Island, Lake Champlain. (Perry.)

the mainland by wave erosion. Such islands are likely to be destroyed in time by the same processes which gave them being.

The cutting of the waves affects the vertical as well as the horizontal configuration of the shores. Where the sea is advancing upon the land, steep slopes, called *sea cliffs* (Figs. 342-346), are developed. Sea cliffs may be high or low, according to the elevation of the land into which the waves cut. Cliffs are of frequent occurrence along seacoasts; and where they are absent.

the waves are not cutting, and the sea is not advancing on the land, or at least not as a result of its own cutting. Slumping often accompanies wave erosion.

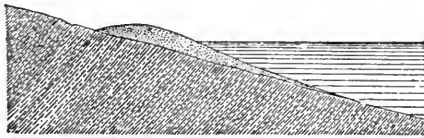

FIG. 347.—Cross-section of a beach. (Gilbert.)

The sea cliff is often bordered by a *wave-cut terrace* a little below the surface of the water (Fig. 342). The area of this terrace often represents, in a rough way, the area which the sea has gained from the land by wave-cutting.



FIG. 348.—A lake beach (barrier). Griffins Bay, Lake Ontario.

**Deposition by waves, shore currents, etc.** Shore waters are aggradational as well as degradational. The material cut from the land by waves, or brought down by rivers, is shifted about by the undertow and the shore currents, but it must ultimately come

to rest. While this material is being moved about by the shore waters, it constitutes *shore drift*, whether brought in by rivers or worn from the coast by waves. If shore drift is left at the shore-line, it makes a *beach* (Figs. 348 and 349), which is sometimes defined as the area of sand, gravel, etc., between high and low tides.

Deposits of gravel and sand continuous with those of the beach are often made at greater depths, the material being carried out by



FIG. 349.—A barrier beach, shutting in a marshy tract behind it, Lasells Island, Penobscot Bay, Me. (Bastin, U. S. Geol. Surv.)

the undertow and by the shore currents which diverge from the coast-line. It is sometimes carried out and deposited at the outer edge of the wave-cut terrace (Fig. 342), and it is sometimes disposed as a terrace along shore (Fig. 350) where there is no wave-cut terrace.

Waves often build *reefs* or barriers a little out from the shore-line. They are developed near the line of breakers, where the in-



FIG. 350.—A wave-built terrace. (Gilbert, U. S. Geol. Surv.)

coming wave is no longer able to carry forward the bulk of the debris which it is moving in toward the shore. The undertow often contributes material to the reef. There are sometimes several such reefs parallel to the coast and to one another. Bars, reefs, etc., often hinder the movements of ocean vessels, as when they close the entrances of harbors. A spit which does not obstruct the entrance to a harbor, on the other hand, is sometimes an advantage, since it breaks the force of the incoming waves in

storms, and so helps to form a harbor. In general, reefs discourage navigation.

After the reef is developed, waves may build its crest above the surface of the water, converting it into land (Fig. 351).



FIG. 351.—Section of a barrier. (Gilbert, U. S. Geol. Surv.)

Such seems to have been the origin of many of the low, narrow belts of sandy land parallel to coasts, with marshes and lagoons behind them. This type of irregularity is illustrated by the coast

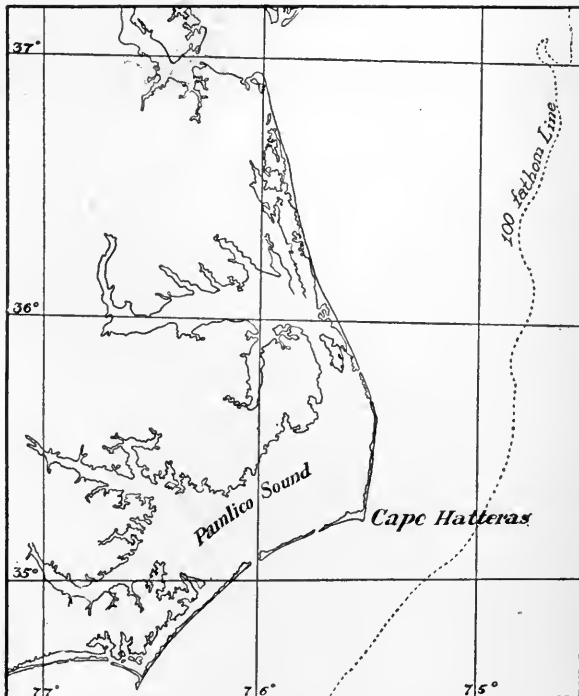

FIG. 352.—Map showing the early stages in the simplification of a shoreline, and showing that at this stage the irregularities are increased.

of the United States at various points between New York and Texas (Fig. 352).

Currents along the shore (*littoral currents*) shift sediment in



the direction of their motion; but where such a current reaches a bay, it does not commonly follow the outline of the bay. It tends rather to cross its debouchure in the direction in which it was previously moving. Under such circumstances it tends to build an embankment of gravel and sand across the bay. Such embankments are *spits*. Currents do not build spits above the water, but waves may accomplish this result by washing material from their slopes up to their tops (Figs. 351-357). They may thus become land, after which dunes often develop on them. When



FIG. 353.—Map of the head of Lake Superior. (U. S. Geol. Surv.)

spits cross bays they become *bars* (Figs. 353 and 354). Spits and bars are often hooked (Fig. 355), as the result of the shifting of the currents while they are in process of building.

Spits and hooks often form harbors, and so have determined the location of numerous settlements and towns. A great hook makes Provincetown harbor, where the Pilgrims first landed, while the harbor whose shores they finally chose for their settlement is formed by a large spit. A hook-formed harbor upon an otherwise regular coast determined the location of Erie, Pennsylvania.

If the shore drift is deposited against the mainland, it may make a flat extending out from the land into the water. A coast-

line developed by deposition is in contrast with one developed by erosion, for the former has no sea cliff.

Land areas developed from reefs and spits often greatly increase the irregularity of the coast-line temporarily (Fig. 352),



FIG. 354.—Bar joining Empire and Sleeping Bear bluffs, Lake Michigan. (Gilbert, U. S. Geol. Surv.)

but they really represent an initial stage in the development of regularity, for after the reefs have become land, the lagoons behind them are likely to be filled with sediment, organic matter, etc., and converted into land (Fig. 356). The sediment which con-



FIG. 355.—A recurved spit, Dutch Point, Grand Traverse Bay, Lake Michigan. (U. S. Geol. Surv.)

tributes to this end is washed down from the land or blown in. When the lagoon is filled, the shore-line is much more regular than before, but the first effect of the making of the reef-land is to make the coast more irregular.

The disposition of shore deposition to simplify coast-lines is also shown in another way. Deposits are sometimes made between islands near the shore of the mainland, and the mainland itself (Pl. XXII and Fig. 357). Thus Nahant Island, on the coast of Massachusetts, and the Rock of Gibraltar, on the coast of Spain,

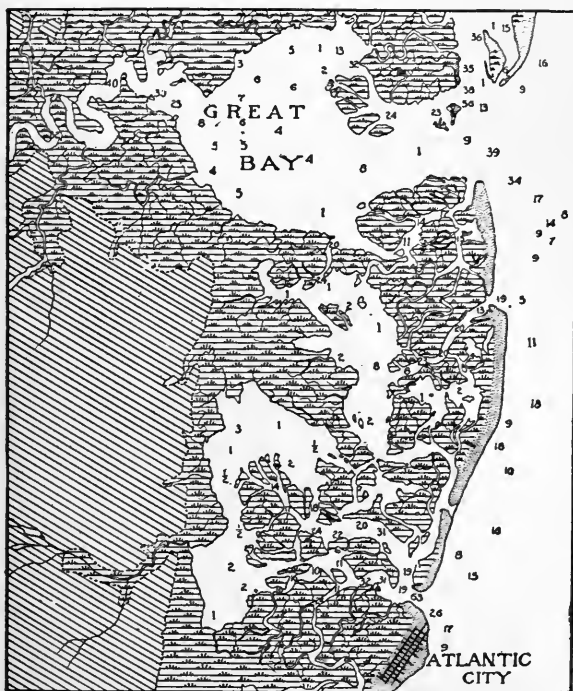

FIG. 356.—Sketch-map of a part of the New Jersey coast. The dotted belt at the east is the barrier modified by the wind. The area marked by diagonal lines is the mainland; the intervening tract is marsh-land. The numbers show the depth of water in feet. Scale:  $\frac{1}{4}$  inch = 1 mile.

have been “tied” to the mainland by the deposits of waves and shore currents. While this tying process gives rise to a notable irregularity of the mainland, it simplifies the outline of the land areas in the sense that it unites islands to mainland.

2. *Rivers.* Rivers erode and deposit at or near coasts. The erosion of streams has little effect upon the coast-line, for a river does not cut below sea-level more than the depth of its own water.

Working alone, therefore, rivers do not develop bays or other similar bodies of water projecting into the land.

The deposition of sediment brought down to coasts by streams is of more consequence in modifying the outline of the land. This is especially the case where deltas are built into lakes or seas. At the lower end of the Mississippi, for example, a great delta has been built out into the Gulf (Fig. 209). The great irregularity which the delta itself constitutes has smaller irregularities about its borders. Deltas in lakes often show the same general features on a smaller scale. The forms of deltas have been noted (p. 200). Delta-land is always low, unless affected by diastrophism, or by lowering of the surface of the water in which it was built.



FIG. 357.—Sheep Island, Penobscot Bay, Me., a land-tied island.  
(Bastin, U. S. Geol. Surv.)

3. *Winds.* The chief effect of wind along the shores is to blow about the dry sand. The sand is often piled up into considerable dunes, as we have seen, but the shifting of the sand by the wind does not commonly change the outline of the land area to any great extent. The wind often piles up sand on low bars and on low coasts, building them up much higher than they were before, even though it does not change the position of the coastline. Plate V shows a coast where the land has been built up notably by wind-driven sand. At Nag Head, N. C., the land is said to have gained on the sea 350 feet in ten years as a result of wind deposits.

4. *Glaciers.* Glaciers descend to the level of the sea in some places, as in Greenland and Alaska. Where this is the case, they usually move down to the sea through valleys. If the ice is thick, the glaciers gouge out the valleys, sometimes to great depths below the level of the sea.

When glaciers which have gouged out such valleys melt, the lower ends of the valleys are filled with sea-water, making narrow bays, or *fjords*.

This is the explanation, or a part of the explanation, of many

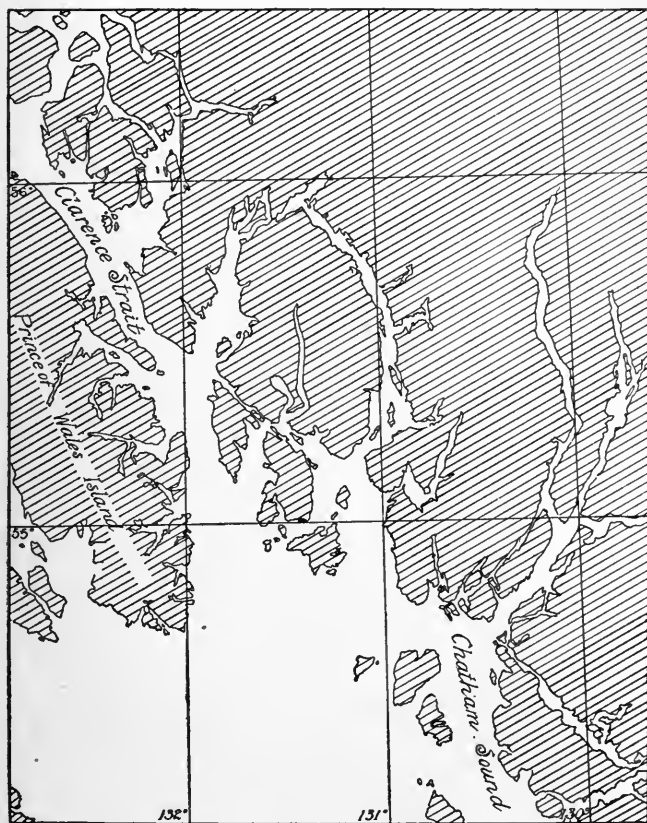

FIG. 358.—Alaska fjords. (C. and G. Surv.)

of the fjords of Norway, Alaska (Fig. 358), Greenland, and Chile, and some other coasts.

Glaciers which descend to the sea deposit their drift where they end, but the drift, being of loose material, is usually soon washed away by the waves, and rarely gives rise to enduring irregularities of coast-line. Drift-made land in lakes would be less readily swept away, because the waves are weaker.



FIG. 359.—Fiords and other irregularities on the west coast of South America.

5. *Shore ice* is another agency which is working on the coast-lines, but does not greatly modify their outlines.

#### EXTINCT LAKES

Many former lakes have become extinct. Extinct lakes are recognized by various features. If a lake basin became extinct by having its basin filled, the former area of the lake is marked by a flat (Fig. 360) covered with deposits such as are formed in lakes.



FIG. 360.—A part of the flat of Lake Agassiz, Moorhead, Minn. (Goode.)

These deposits may be of gravel or sand along the shores, but the materials deposited far from shore are fine. Such a flat is a *lacustrine plain*. A lacustrine plain is a minor type of plain, and may lie in mountains, on plateaus, or on plains of a larger type.

If a lake became extinct by the lowering of its outlet or by evaporation, the old bed of the lake would be less flat, might even depart much from flatness.

The former borders of an extinct lake are often marked by various shore features, such as deltas, terraces, beaches, etc.; while above the terraces, in places at least, old shore cliffs are often found, especially if the lake was large. Conspicuous shore features mark the former borders of Lake Bonneville. Some of them are shown in Fig. 361. The lower slope, marked by terraces developed about the shores of the lake in relatively recent times, is in striking contrast with the upper slope, the topography of which was developed by running water. The topography of the terraces is young; that of the slopes above, much more advanced. This relation between a slope of older topography above and a surface of younger topography below, has been called a *topographic unconformity*. In this case, the lower ends of the ravines and

valleys were filled and obliterated by the deposits along the shore of the lake, the water of which stood at various levels at various times.

Shore features, less conspicuous than those about Lake Bonneville, but none the less distinctive, mark the borders of the extinct

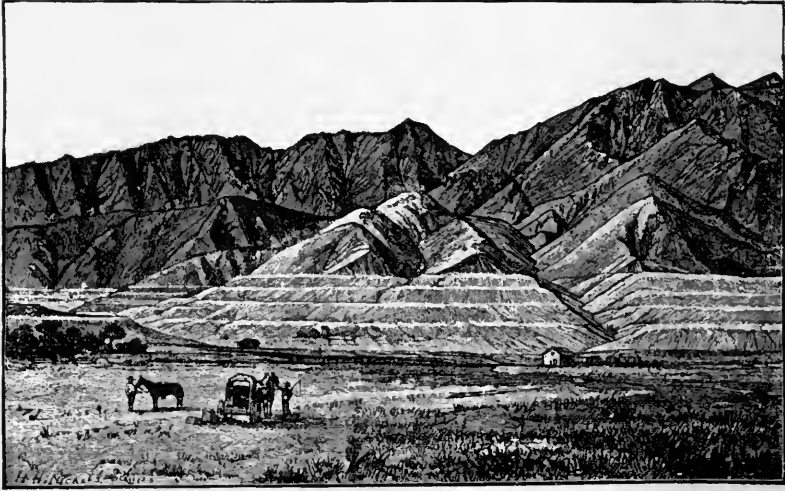

FIG. 361.—Shore of former Lake Bonneville, Wellsville, Utah.  
(U. S. Geol. Surv.)

Lake Agassiz and many other extinct lakes. They also appear about many existing lakes well above their present shores, thus showing their previous higher levels.

All shore features developed by lakes are likely to be destroyed in time by the agents of degradation. The aridity of the Great Basin has favored the preservation of the shore features of Lake Bonneville and Lake Lahontan.



## MAP EXERCISES

*Maps Showing Lakes and Shores.*

I. Study the following maps, group by group, as indicated by the letters, in preparation for conference:

- |  |   |
|--|---|
| A. Browns Creek, Neb.<br>Great Bend, Kan.  | G. White Bear, Minn.<br>Minneapolis, Minn.  |
| B. St. Louis, Mo.—Ill.<br>Lancaster, Wis.—Ia.—Ill.<br>Bodreau, La.<br>Bayou de Large, La.  | H. Falmouth, Mass.<br>Marthas Vineyard, Mass.<br>Nantucket, Mass.<br>Gay Head, Mass.<br>Provincetown, Mass.   |
| C. Ft. McKinney, Wyo.<br>Greeley, Colo.<br>Granada, Colo.  | I. Standingstone, Tenn.<br>Arredondo, Fla.  |
| D. Mt. Lyell, Cal.<br>Cloud Peak, Wyo.<br>Chief Mountain, Mont.  | J. Crater Lake Special, Ore.  |
| E. Paradox Lake, N. Y.<br>Berne, N. Y.<br>Webster, Mass.   | K. Boston Bay, Mass.<br>(Also maps of group H.)<br>Asbury Park, N. J.<br>Sandy Hook, N. J.<br>Atlantic City, N. J.<br>Southern California, Sheet 2.<br>Tamalpais, Cal.<br>San Mateo, Cal.<br>Erie, Pa.<br>Fairview, Pa.<br>Sodus Bay, N. Y.<br>Boothbay, Me.<br>Coast Survey Chart 103. |
| F. Pingree, N. D.<br>Skaneateles, N. Y.<br>Penn Yan, N. Y.<br>Hammondsport, N. Y.<br>Chelan, Wash.<br>Methow, Wash.<br>Stehekin, Wash. |   |

*Note.*—Before taking up other details in the case of any map, note its position in the country, its general topography, and the causes which have developed its topography. Where maps are adjacent, it is well to study them together; e.g., the New York maps under F, the Washington maps under F, some of the Massachusetts maps under H and K, and two of the New Jersey maps under K.

II. 1. Each lake shown on the maps presents a series of problems, among which are the following:

- a. What is the origin (certain, probable, possible) of the basin?
  - b. What is the source of the water-supply?
  - c. Does the map indicate (certainly, probably, possibly) any changes now in progress about the lake?
  - d. Is the lake likely to be destroyed soon? If so, what are likely to be the chief factors in its destruction?
  - e. What inferences may be made from the map as to the depth of individual lakes? What measure of certainty or uncertainty attaches to the inference?
- 2.\* Classify the lakes of each map under the headings indicated on pp. 303-311.
  - 3.\* Find as many types as possible of glacial lakes (see p. 311), specifying examples.
  4. In connection with each map, note whether there are areas (certain, probable, possible) which were once lake bottoms; i.e., have lakes become extinct in the area represented?
  - 5.\* Are the waters in the ponds along the shore of Marthas Vineyard probably fresh or salt? Give reasons.
  6. In studying the ponds of the Standingstone Sheet, note carefully the contour lines and the drainage about them.
- III. The maps of group K are designed especially to illustrate shore phenomena, most of them along the seashore. Interpret in the light of pp. 320-329.
1. Indicate what parts of the coasts are being (or have recently been) modified by (a) wave erosion and (b) shore deposition. Give reasons for your conclusions.
  - 2.\* In general, how may (a) shore deposition and (b) wave erosion be inferred from topographic maps of coasts?
  3. From any good map or model of the United States, indicate where (a) erosion, and (b) deposition prevails.
  - 4.\* What are the possible explanations, so far as the map shows, of the marshes on the bay coast of the San Mateo region?
  5. Are coastal features similar to those shown on the maps of group K shown on the shores of lakes of preceding groups?
  6. Make a careful study of Coast Survey Chart 103, noting all the processes which may have played a part in the development of the coast-line.
  - 7.\* Is there evidence on the Sodus Bay Sheet of change of relative level of land and lake? Give reasons.
  8. Interpret the steep slope just south of the N. Y., C. & St. L. R. R.
  9. What is the probable meaning of the low ridge extending east from Fairview?

## REFERENCES

1. RUSSELL, *Lakes of North America*: Ginn & Co.
2. TAYLOR, *Short History of the Great Lakes*, in *Studies in Indiana Geography*.
3. CHAMBERLIN AND SALISBURY, *Geology, Earth History*, Vol. III, pp. 394-403. See also index of same volume and of Volume I.
4. GILBERT, *Topographic Features of Lake Shores*, in 5th Ann. Rept. U. S. Geol. Surv., and Mono. I, U. S. Geol. Surv.
5. DILLER, *Crater Lake, etc.*: Prof. Paper No. 3, U. S. Geol. Surv.; Nat. Geog. Mag., Vol. VIII, pp. 33-48, and Am. Jour. Sci., Vol. III, 1897, pp. 165-172.
6. RUSSELL, *Geography of the Laurentian Basin*: Bull. Am. Geog. Soc., Vol. XXX, pp. 226-254, and Jour. of Geol., Vol. I, pp. 394-408.
7. TARR, For New York lakes, see *Physical Geography of New York: The Great Lakes*: Bull. Am. Geog. Soc., Vol. XXXI, pp. 101-117, 217-235, and 315-343; and *Lake Cayuga, a Rock Basin*: Bull. Geol. Soc. Am., Vol. V, pp. 339-356.
8. UPHAM, *Glacial Lakes in Canada*: Bull. Geol. Soc. Am., Vol. II, pp. 243-274.
9. HARRINGTON, *Area and Drainage Basin of Lake Superior*: Nat. Geog. Mag., Vol. VIII, pp. 111-120.
10. BRIGHAM, *Lakes: a Study for Teachers*: Jour. of Sch. Geog., Vol. I, pp. 65-72.
11. FENNEMAN, *Lakes of Southeastern Wisconsin*: Bull. 8, Wis. Geol. and Nat. Hist. Surv.
12. KEMP, *Physiography of Lake George*: Annals N. Y. Acad. of Sci., Vol. XIV, pp. 141-142, and Science, Vol. XIV, p. 774.
13. MURDOCH, *Fall of Water Level in Great Salt Lake*: Nat. Geog. Mag., Vol. XIV, 1903, pp. 75-77.
14. MILL, *Bathymetric Survey of the English Lakes*: Geog. Jour., Vol. VI, pp. 46-73 and 135-166.
15. MURRAY, *Bathymetric Survey of the Fresh-water Lochs of Scotland*: Scot. Geog. Mag., Vol. XVII, p. 169; Vol. XIX, pp. 449 and 561; and Vol. XX, pp. 1, 169, 235, 449, 589, and 628.

## EXTINCT LAKES, SHORE FEATURES, ETC.

16. RUSSELL, *Present and Extinct Lakes of Nevada*, in *Physiography of the United States*: Am. Bk. Co.
17. SHALER, *Sea-coast Swamps of the Eastern United States*: 6th Ann. Rept. U. S. Geol. Surv.; also *Sea and Land*: Scribner's.
18. GILBERT, *Lake Bonneville*: Mono. I, U. S. Geol. Surv.
19. RUSSELL, *Lake Lahontan*: Mono. XI, U. S. Geol. Surv.; and *Monoc Lake*: 8th Ann. Rept. U. S. Geol. Surv.
20. GEIKIE, J., *Earth Sculpture*, Chapter XV: Putnam.
21. GEIKIE, SIR A., *Scenery of Scotland*, Chapter III: Macmillan.

## CHAPTER VII

### VULCANISM

A **VOLCANO** is a vent in the earth's crust out of which hot rock issues. The hot rock may be liquid (called *lava*) and may flow out; or it may be solid, when it is thrown out violently in pieces. If the vent is in the form of a long crack or *fissure*, it is not commonly called a volcano.

The rock material which comes out of a volcano is generally built up into mounds or cones (Fig. 362). They may be mere



FIG. 362.—Fujiyama, a volcanic cone in Japan.

mounds or high hills, or even high mountains. The cones are often called volcanoes, though they are really the results of volcanic

activity. The volcano from which lava flows makes a cone with low slopes (Fig. 363). The volcano from which solid matter is

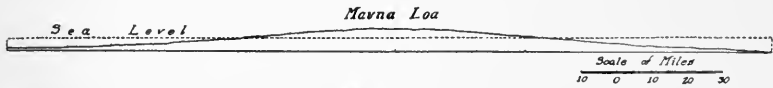

FIG. 363.—Profile of the cone of Mauna Loa. Vertical scale same as horizontal. (U. S. Geol. Surv.)

thrown makes a cone with steeper slopes (Fig. 364). Many volcanoes send out both liquid rock (lava) and solid rock. In this case both may be issuing at about the same time, or lava may flow out at one time and solid rock be thrown out at another. Along with the hot rock, quantities of gases and vapors, some of them poisonous, are discharged. So long as a volcano is active



FIG. 364.—Typical cinder cone, Clayton Valley, Cal. (U. S. Geol. Surv.)

there is likely to be a hollow, called *the crater* (Figs. 365 and 366), in the summit of its cone. From the crater an opening leads down to the source of the lava, at an unknown depth. Craters vary greatly in size. Some of them are a mile or more across, and some but a small fraction of a mile. The sizes and shapes of the openings leading down to the sources of the lava cannot be seen while the volcano is active, but they doubtless vary much in size and shape, and perhaps in length.

Volcanoes exhibit two great types of eruption. These are (1) *the quiet type* and (2) *the explosive type*. In the former the liquid lava rises up into the crater, and either (a) flows over its rim or (b) breaks through the cone and flows down its sides. In

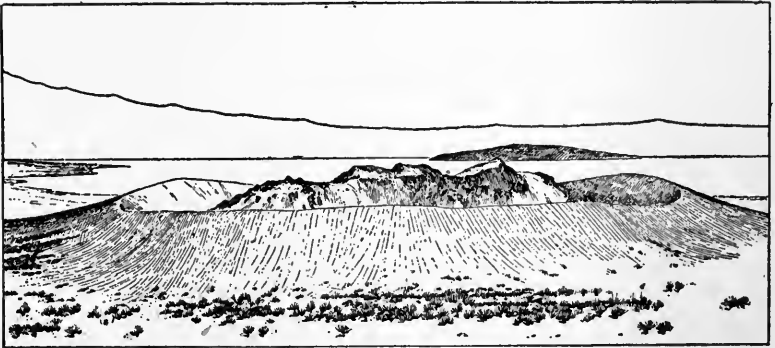

FIG. 365.—Panum crater, Cal.; Lake Mono and Paona Island in the distance. (U. S. Geol. Surv.)

the latter the material is blown out by explosions from within. In this case the material may be either liquid or solid when it is thrown out, but the liquid lava cools rapidly in the air and becomes solid quickly. Small masses of liquid lava blown out of a volcanic vent are often solid when they fall, after even a few seconds of flight through the air.

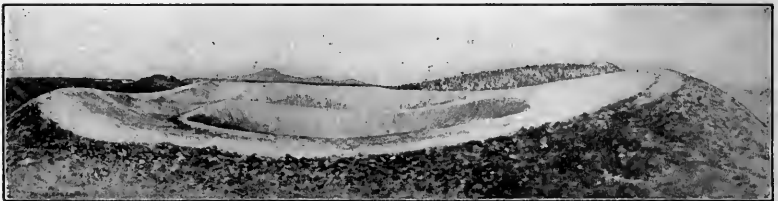

FIG. 366.—Sketch of the crater of the cinder cone near Lassen Peak, Cal., showing the peculiar feature of two rings. The funnel is 240 feet deep. (U. S. Geol. Surv.)

Some volcanoes discharge quietly at one time and explosively at another, and in some there is some measure of explosive violence at all times, accompanied by some quiet discharge of lava.

From the following accounts of a few active volcanoes, many of the features of volcanic action will be gathered.

*Examples of Active Volcanoes*

**Stromboli.** The cone of this volcano is an island 4 or 5 miles in diameter, in the Mediterranean Sea, north of Sicily. The cone is built up from the bottom of the sea, and is about a mile high, though but little more than half of it projects above the water. About 1000 feet below its top there is an opening in the side of the mountain, from which steam issues constantly. At a distance, the condensed water vapor looks like smoke.

It is sometimes possible to climb up to the opening or crater and look in. The floor of the crater is then seen to be of black rock composed of hardened lava. There are cracks in the floor, and from some of them steam puffs out somewhat as from an engine. In other cracks liquid lava may be seen to be boiling. Bubbles form in it and burst, much as bubbles form and burst in a pot of boiling mush. When they burst, fragments of the lava of which the bubbles are composed are hurled hundreds of feet into the air, and fall on the slopes of the cone, increasing its size.

At night the glowing lava in the cracks of the crater floor lights up the clouds which hover over the mountain. For this reason Stromboli is known as "the lighthouse of the Mediterranean."

The eruptions of Stromboli are occasionally so violent that the roar of the escaping steam may be heard for miles, while the ejected material is hurled so high and so far that it is scattered not only over the entire mountain, but into the surrounding sea. Stromboli is an example of a volcano which is at the present time constantly active.

Stromboli is one of many volcanoes which have existed in this part of the Mediterranean Sea. Some of the others, such as Etna, are still active, while others are dormant or extinct.

**Vesuvius.** Vesuvius is probably the best-known volcano. Its cone is a mountain about 4000 feet high, on the shore of the Bay of Naples, about 10 miles from the city of the same name. The present cone of the volcano (Fig. 367) rises within the half-destroyed rim of an older and much larger crater.

Previous to 79 A.D. Vesuvius was, so far as then known, only a conical mountain in whose summit was a deep crater three miles in diameter. The slopes and even the bottom of the crater were covered with vegetation. In that year a most destructive ex-

plosion occurred, and blew away half the rim of the old crater. Much of the rock blown out was broken into such small pieces as to constitute *dust* (often called *volcanic ash*), and as it fell on the surrounding country, it buried and destroyed not only plants, but even cities. Pompeii, a city of some 20,000 inhabitants, was thus buried, locally to a depth of 25 to 30 feet, and about 2000 of its people were killed. During this eruption there were no streams



FIG. 367.—Cinder cone forming the summit of Mt. Vesuvius.

of lava. Heavy rains accompanied or followed the eruption. Falling on the volcanic dust, the rains gave rise to devastating streams of hot mud. Herculaneum was overwhelmed by such a stream, perhaps 60 feet deep at a maximum. The present cone of Vesuvius has been built up inside the remnant of the rim of the older cone since this eruption.

Since the outburst of 79 A.D., Vesuvius has had other violent eruptions, separated by periods when it was quiet or when its activity was mild. The eruption of 1631 was especially violent, destroying 18,000 lives. The emission of steam and volcanic dust was followed by outflows of lava, some of which reached the sea. Other eruptions of importance occurred in 1737, 1794, 1822,



and 1872. For several months before the principal eruption of 1872 there had been mild eruptions, during which steam and fine fragments of rock matter were ejected from the crater, and flows of lava issued from cracks on the mountain-side. The activity gradually increased in violence until April, when the eruption culminated. Two huge fissures and several smaller ones opened on the flanks of the cone, and from them great streams of lava flowed into the neighboring valleys, overwhelming two villages. At the same time, two large openings were made at the summit, from which enormous quantities of steam, dust, and bomb-like masses of molten rock were hurled 4000 feet or more into the air, with a noise which could be heard for many miles. At night the cloud overhanging the mountain was brightly illuminated by the glowing lava in the crater. Earthquakes were felt throughout the entire region. The discharges continued with great violence for four days. After the eruption was over, two craters 750 feet deep, with nearly vertical sides, were found at the summit. An enormous amount of loose material had accumulated on the sides of the mountain, and the lava which issued from the fissures lower down covered a large area.

When Vesuvius is but mildly active it is possible to climb to the rim of its crater and look in. It is necessary to climb up on the windward side, because of the noxious vapors which are blown to leeward. Even on the windward side it is necessary to be mindful of the course which is followed, for stifling and poisonous gases are pouring out of numerous little vents. Fortunately the poisonous gases have such a disagreeable odor that they are readily detected.

The phenomena which may be seen and felt on the mountain differ from time to time, but the conditions of a particular day (in June, 1887) may be taken as fairly characteristic. Soon after the ascent on that day began, rumbling noises were heard, accompanied by slight tremors or quakings. As the summit was approached, the noises grew louder, and the shaking of the mountain more distinct, until, by the time the top was reached, both noises and tremblings were nearly continuous.

From the rim of the crater it could be seen that there were three places where the floor of the crater was not crusted over. In these openings, the lava boiled and bubbled like thick liquid in huge caldrons. About three times a minute there were explosions within these openings, which shook the whole top of the

mountain. At the same instant, hundreds of fragments of the glowing lava were shot up into the air. After rising several hundred feet, these fragments fell; but they were so scattered as they fell, and they came down from such great heights, that it was not difficult to avoid them. They were often glowing-hot as they started upward, but they quickly cooled enough to stop glowing, and when they reached the surface of the cone they were

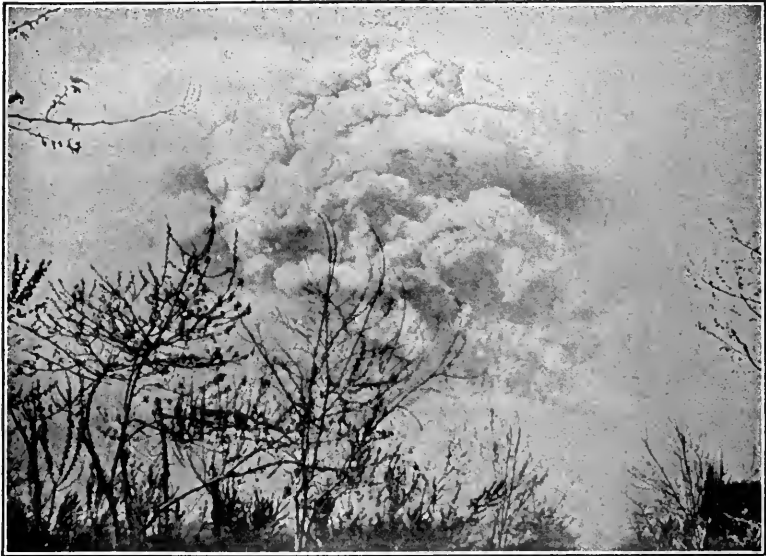

FIG. 368.—The Cauliflower cloud above Vesuvius, April 7, 1906.  
(Jaggar, Nat. Geog. Mag.)

dark, slag-like pieces of rock, though not always thoroughly solid. Some of the material ejected was in very small fragments, and some of it in pieces weighing scores and hundreds of pounds. Steam and many ill-smelling vapors were also constantly issuing from the crater. The water vapor which issued was soon condensed into clouds as it rose and cooled, so that clouds hung over the mountain.

From the rim of the crater it was clear that the explosions which blew out the lava were also the cause of the noises and the quaking. At night the glowing lava of the uncrusted openings in the bottom of the crater lighted up the clouds above, most brightly during explosions, when hotter lava from greater depths was exposed.

Vesuvius was again disastrously active in the spring of 1906, when quantities of dust and flows of lava were sent forth, causing much destruction of property and some loss of life.

Professor Jaggar has described the conditions late in April as follows: "The lava-fields of 1872 and 1898 were found buried under 5 or 6 inches of sand and dust, which formed a heavy mantle, but not sufficient to wholly disguise the slaggy contortions beneath. The whole cone of Vesuvius became cleared of clouds in the course of the afternoon, and it was seen to be covered with straight sand-



FIG. 369.—The new cone of Vesuvius, shrouded in snow-white ashes.  
(Jaggar, *Nat. Geog. Mag.*)

slides of whitish-gray color, which occasionally slipped downward as on the steeper slopes of a dune. Pure white steam boiled up slowly from the crater. In one instance it burst out radially over the edge of the crater, showing a ring on the border, a dome of cumulus above and within, and a second still higher outer ring made of an older rain-cloud which had been punctured and pushed up bodily. The effect was like a hat on the mountain's crown. At night the cone was clear and entirely without luminosity."

As seen from the top, the crater was so full of steam, etc., that little could be seen; but occasionally "we could make out an inward slope of 35 or more degrees, covered with hot sand and broken rock fragments, terminated about 120 feet (vertically) below by jutting ledges which appeared to be precipitous. Beyond was

steam and sulphurous heat and obscurity. The ledges fumed in places. No noise could be heard above the howling of the wind. The curvature of the crater edge was irregular with embayments, and it showed much irregularity in height. We could not see the opposite side of the caldron, but from the curvature it was estimated that the crater could not be less than from one-fourth to one-half mile in diameter—unusually large for Vesuvius."

The history of the recent eruption is summed up by the same author as follows: "In May, 1905, lava flowed from a split



FIG. 370.—Vesuvius in 1906. (Hobbs.)

in the northwest side of the cone and continued in active motion throughout the year. It ceased flowing at the time when the present eruption opened a new vent on the south side of the cone. On April 4, 1906, a splendid black 'cauliflower' cloud rose from the crater. On April 4, 5, 6, and 7 lava mouths opened along the southern rift above mentioned, first 500 feet below the summit, then 1300 feet lower, and finally 600 feet lower still, all in the same radial line. The lowest mouth was more than half-way down the mountain, and from this orifice came the destructive streams. It should be borne in mind that these flows are not floods of lava which cover the whole slope of the mountain, but relatively narrow, snake-like trickles, none the less deadly when they push their way through a closely built town. The molten rock crusted over and cracked, making a tumble of porous boulders at its front.

“At 8 P.M., April 7, a column of dust-laden steam shot up four miles from the crater vertically. The cloud snapped with incessant lightnings. New lava mouths opened, and the flows moved forward, crushing and burning and swallowing parts of Boscotrecase, the stream forking so as to spare some portions of the town. Meantime torrents of ashes fell on Ottajano, on the opposite side of the volcano, and many roofs collapsed and lives were lost. At the observatory Dr. Matteuci and his colleagues were obliged to re-



FIG. 371.—The ruins of Ottajano. The roofs have fallen in under the load of ashes.

treat, as the observatory was rocking violently and heavy stones were falling. . . .

“Boscotrecase was ruined wholly by lava; Ottajano by falling gravel. Boscotrecase is traversed in two places by the clinkery lava stream, and in some cases houses were literally cut in two. The stream of lava had forked about a spur of the mountain, leaving the higher land with its vineyards untouched. The lower land with its town was invaded. There is so little timber in the Italian masonry construction that the uninvasion part of the town was not burned at all. At Ottajano the roofs fell in under the weight of sand and gravel. The roofs were largely flat or slightly sloping tiled

affairs. The ash and lapilli reached a depth of three feet on level surfaces. The roofs carried the walls with them in many cases, but there was no significant earthquake. There was no fire, destructive lightning, nor strong wind. The persons who perished were all found in the houses, where the sole cause of death was entombment in the ruins."

Like Stromboli, Vesuvius is situated in a region where there have been other volcanoes, some of which have been active within historic times.

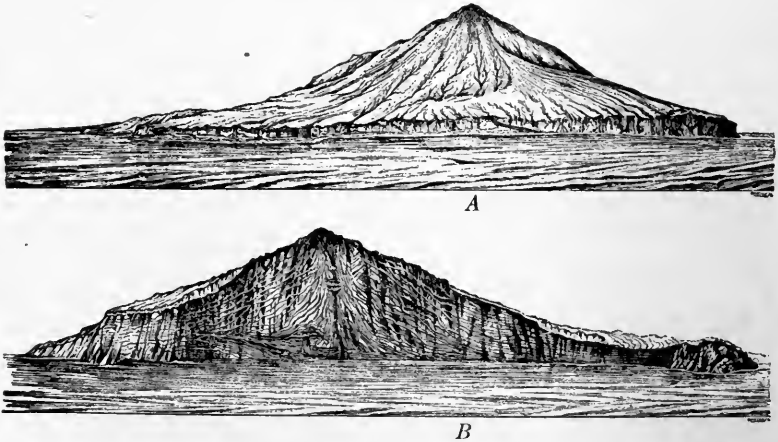

FIG. 372.—Krakatoa after the eruption. *A*, as seen from the southwest, and *B*, from the north. (Rept. of the Roy. Soc.)

**Krakatoa.** One of the most violent and destructive volcanic explosions of which there is historical record was that of 1883, in Krakatoa, a volcanic island in the Strait of Sunda, between Sumatra and Java.

Previous to the great eruption, the island had been shaken by earthquakes and minor explosions for some years. On the morning of the 27th of August there was a series of terrible explosions, the sound of which was heard in southern Australia, 2200 miles away. About two-thirds of the island was blown away (Fig. 372), and the sea is now 1000 feet deep where the centre of the mountain formerly stood. Enormous sea-waves were formed, which traveled half-way around the earth. On the shores of the neighboring islands the water rose 50 feet, causing great destruction. More than 36,000 persons perished, mostly by drowning, and 295 villages were wholly or partially destroyed. The sky over the island and

the bordering coasts became black as night from the clouds of dust. It was estimated that steam and dust were shot up into the air 17 to 23 miles. The explosion produced great air-waves which traveled three and more times around the earth. Its passage was recorded by barometers in all parts of the world. The dust ejected during this explosion has been noted already (p. 57).

Over a circle 10 to 12 miles from the centre of Krakatoa, the sea bottom outside the crater was built up 10 to 12 feet. Along a line to the west, the depth of the water was increased.

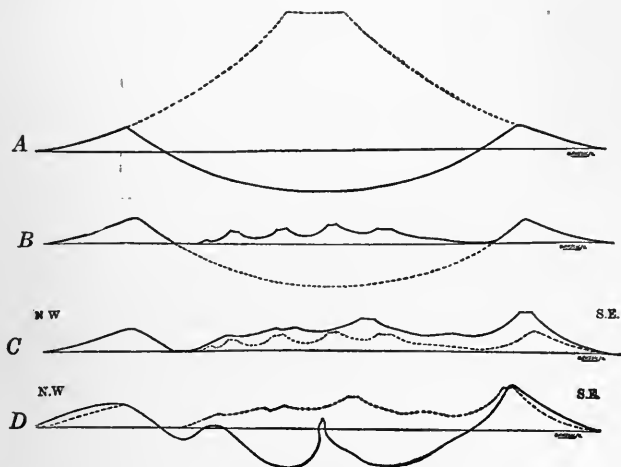

FIG. 373.—A. Probable outline of the great crater ring of the Krakatoa volcano after the ancient paroxysmal outbursts. The dotted line indicates the mass which was blown away.

B. Probable outline of the Krakatoa volcano after the great crater indicated by the dotted line had been filled up by growth of numerous small cones within.

C. Form of Krakatoa in historical time, after the formation of the great lateral cone of Rakata and the growth of other cones within the great crater.

D. Outline of the crater of Krakatoa as it is now. The dotted lines indicate the parts blown away by the outburst of 1883 and the change in form of the flanks by the fall of ejected matter. (Rept. of the Roy. Soc.)

The cause of this awful explosion was probably the same as that of the milder eruptions of Stromboli, that is, the sudden escape or explosion of superheated steam.

Something of the conjectured history of this volcano is shown by Fig. 373, which is suggestive of the changes undergone by volcanic cones. The explanation beneath the figure gives its interpretation.

There are many other volcanoes, living and dead, in the vicinity of Krakatoa.

**Mont Pelée and Soufrière.** The volcano of Mont Pelée is situated on the island of Martinique (Fig. 376), one of the Lesser

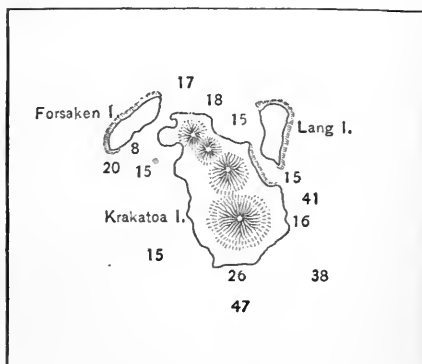

FIG. 374.—Krakatoa Island and surroundings before the eruption of 1883. The numbers indicate the depth of the water in fathoms.

Antilles, at the eastern border of the Caribbean Sea. Its cone descends by steep slopes to the sea on all sides but the south, where it is bordered by a plain on which, prior to the eruption of 1902,

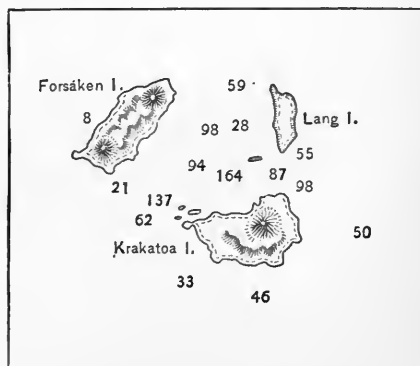

FIG. 375.—Krakatoa Island and surroundings after the eruption of 1883. The numbers indicate the depths of the water in fathoms.

stood the city of St. Pierre, with a population of about 26,000. The crater of Pelée was half a mile in diameter, and its floor 2000 feet below the highest part of the crater rim. This rim was interrupted at the southwest by a deep gash, through which a stream





FIG. 376.—Sketch-map of Martinique. (Nat. Geog. Mag.)

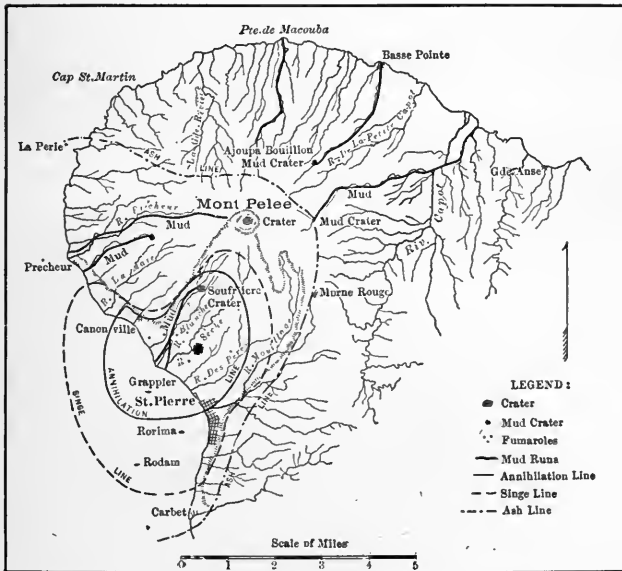

FIG. 377.—Map of that part of Martinique devastated by the volcanic outburst of 1902. (Hill. Nat. Geog. Mag.)

flowed. In the crater there was formerly a lake, but it is said to have been dry for about half a century.

Previous to the eruption of 1902, Pelée had had two periods of moderate activity within historic times, namely, in 1762 and in 1851. Neither was destructive to life. From 1851 to 1902 the volcano slumbered. In the later part of April of the latter year activity was renewed by (1) the discharge of steam, vapors, and ashes, some of which were thrown 1300 feet above the top of the mountain, and (2) by the opening of three vents in the basin of the old crater. By April 25 sulphurous vapors had become so



FIG. 378.—Mt. Pelée. (Am. Mus. Nat. Hist.)

abundant that horses dropped dead in the streets of St. Pierre, and a little later the traffic of the streets was obstructed by the volcanic dust or "ashes." On May 5 the mud which had accumulated in the basin of the crater broke out and flowed down the valley, overwhelming a factory and destroying a number of lives. During these early stages of activity there were numerous earthquakes, and all cables from Martinique were broken. Detonations like the report of artillery were heard even 300 miles away.

On May 8 the activity of the volcano reached its climax. On that day a heavy black cloud swept down through the gash in the crater rim over the plain to the southwest, and two minutes later struck the city of St. Pierre, five miles distant. The city was at once demolished. Buildings were thrown down, statues hurled from their pedestals, and trees torn up. Explosions were heard in

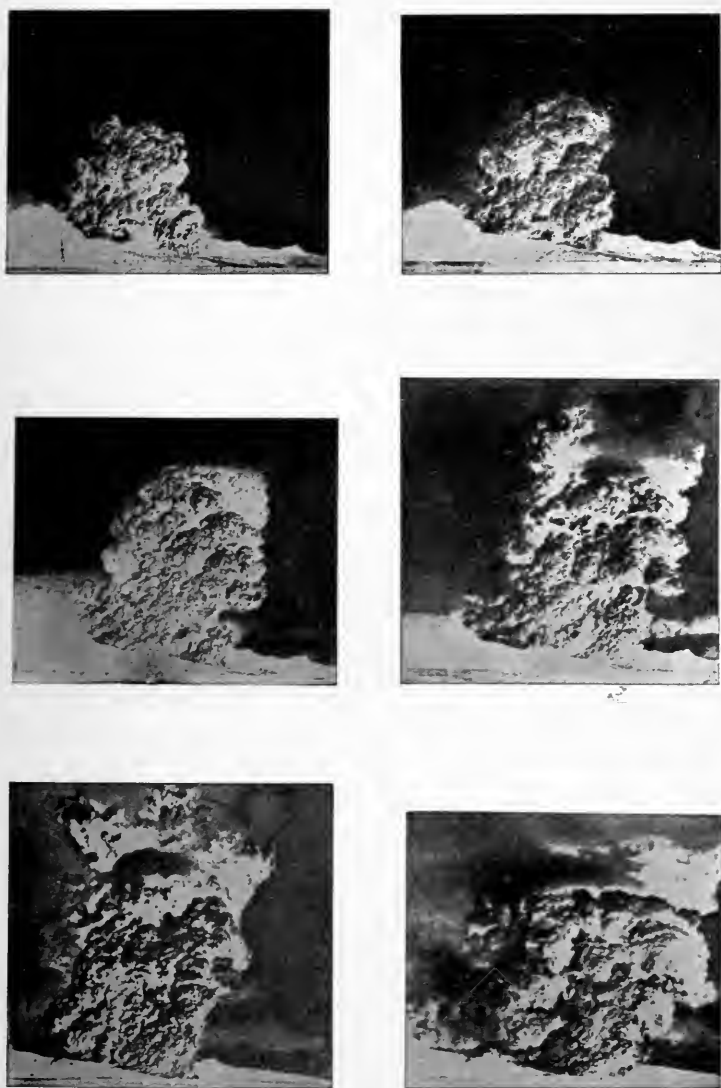

FIG. 379.—Successive stages of the dust-cloud of the eruption of Mt. Pelée, December 16, 1902. (La Croix.)

St. Pierre as the cloud reached it, and the city burst into flames, fired either by the heat of the gases or the red-hot particles of rock which the gases carried. A few moments later a deluge of rain, mud, and stones fell, continuing the destruction. With very few exceptions, the entire population, increased to some 30,000 by refugees from the surrounding country, was wiped out of existence.

Study of the region after the eruption showed that the cloud was probably composed of steam, sulphurous vapors, and dust.



FIG. 380.—Outside of southern rim of crater of Pelée. The serrate edge is due to landslides. (Hovey, *Am. Mus. Nat. Hist.*)

It is estimated to have had a temperature of 1400° to 1500° F. (800° C.). The gases were heavier than air, and so swept along the ground instead of rising. They may also have been kept down by the clouds of steam and ashes thrown out just before the outburst of the destructive gases. Combustible gases seem not to have been abundant, for the vegetation and thatched roofs in the path of the blast were not burned, but only dried and withered. The bodies of the victims were scorched, burned, or scalded. Except in the axis of the blast, the clothing of the bodies was unburned, though the flesh beneath was burned and scalded. The chief causes of death seem to have been suffocation by the noxious vapors and gases and the great heat. Minor causes were blows from stones thrown from the volcano, burns from hot stones, dust, and steam, cremation in burning buildings, etc.



FIG. 381.—Great rocks thrown out by the eruption of August 30, 1902.  
(Hovey, Am. Mus. Nat. Hist.)



FIG. 382.—St. Pierre after the eruption of Mt. Pelée, which is seen in the distance. (Hovey, Am. Mus. Nat. Hist.)

Other eruptions occurred on May 20, 26, June 6, July 9, and August 30. The first of these was similar in character and violence to that of May 8, and destroyed such portions of the town as had been spared by the first eruption. The blast of August 30 took a path somewhat different from that of the earlier ones, and devastated a number of villages in the vicinity of St. Pierre, adding about 2000 to the list of human victims. Clouds of steam and ashes were thrown to heights of 6 and 7 miles.



FIG. 383.—Spine of Mt. Pelée. The spine rose about 1210 feet above the crater rim. (Hovey, *Am. Mus. Nat. Hist.*)

The great crater of Mont Pelée is now occupied by a cone of fragmental material and some lava. This cone now overtops the crater rim, and terminates in a spire which rises hundreds of feet above the shallow crater which occupies the apex of the cone, and out of which it was thrust. Unlike the cone, the spire consists of solid rock. It is believed to be the lava which filled the vent, and which was pushed up by the expansive forces beneath. The spire is reported to be rapidly crumbling.

An interesting case of sympathetic action was shown by a volcano (Soufrière) on the island of St. Vincent (Fig. 385), about 90

miles south of Martinique. After two days of premonitory symptoms the first eruption of the Soufrière occurred on May 7. The

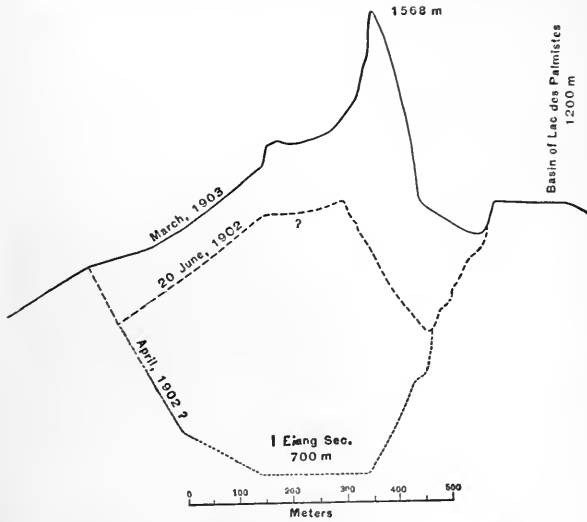

FIG. 384.—Cross-section through the northern part of Mt. Pelée, showing the growth of the spine. (Hovey, Am. Mus. Nat. Hist.)



FIG. 385.—Sketch-map of the Island of St. Vincent, showing the zones of devastation. On the black area the devastation of life was nearly complete; in the checked area, slight. (Russell, Nat. Geog. Mag.)

eruption was similar to that of Mont Pelée, but as there was no considerable city in the path of the steam-cloud, the loss of life was

much smaller, about 1350. The discharges from the vent were not confined and directed by a valley so definitely as those of Mont



FIG. 386.—The Soufrière, St. Vincent. (Hovey, Am. Mus. Nat. Hist.)

Pelée; hence they spread over a larger area, with less violence. A later eruption, on May 18, preceded, by a short period, an



FIG. 387.—Ash-filled gorge of the Rabaka, St. Vincent.  
(Hovey, Am. Mus. Nat. Hist.)

outburst of Mont Pelée, and another, on September 3, followed a great eruption of the sister volcano.

From both centres of activity the dust driven out was carried long distances. On St. Vincent it formed beds 50 and 60 feet thick



in some places. There were no lava-flows in connection with any of these eruptions.



FIG. 388.—An eruption of steam from the ashes of the Walliban Valley (Hovey, Am. Mus. Nat. Hist.)



FIG. 389.—Ridge of Bunker Hill on the Richmond estate, St. Vincent. Shows the devastation of trees and the accumulation of dust on the crest of the ridge. (Hovey, Am. Mus. Nat. Hist.)

Earthquake tremors felt in China on May 8 are supposed to have been connected with the violent eruption of that date. This is



FIG. 390.—The Soufrière in eruption. Ruins of Walliban sugar-factory in the foreground. (Photograph by Wilson.)



FIG. 391.—A river of mud pouring from La Soufrière; the steam is rising from hundreds of points in the hot stream. (Russell.)

the only case, with the exception of Krakatoa, in which tremors are known to have been transmitted through the centre of the earth to the opposite side. Earthquake shocks were felt in Venezuela on August 30.

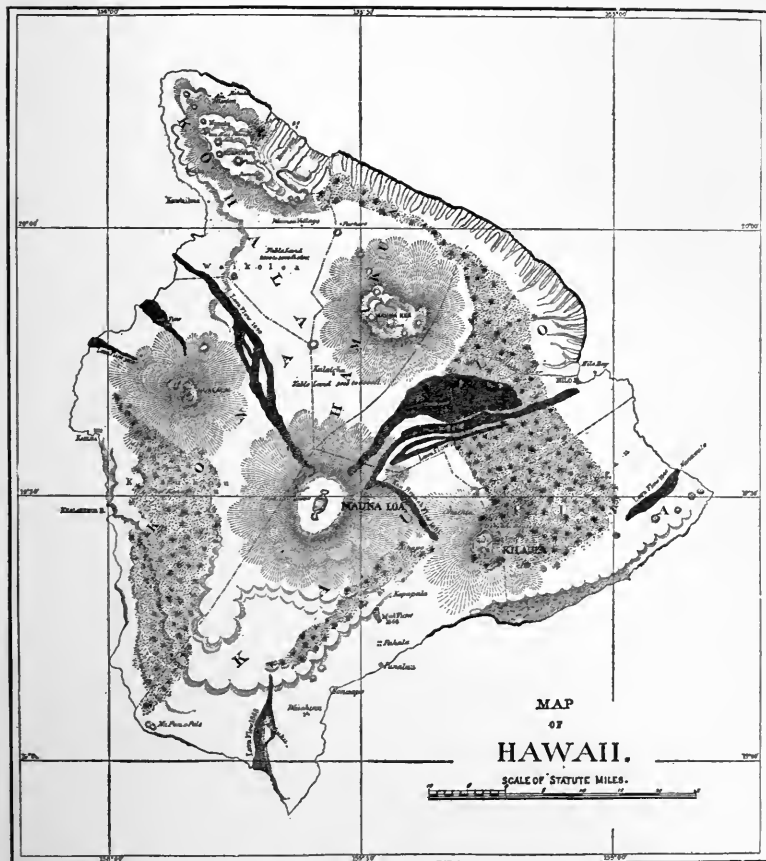

FIG. 392.—Map of Hawaii. (U. S. Geol. Surv.)

**Hawaiian volcanoes.** The eruptions of the volcanoes thus far described are more or less violent; but in the Hawaiian Islands there are volcanoes whose eruptions are relatively quiet. Mauna Loa is the largest of the four volcanic cones whose united mass forms the island of Hawaii, which is 80 miles across. Mauna Loa rises 14,000 feet above the sea. So far as known, almost the

whole island is made up of volcanic materials. The highest point of the island is about 14,000 feet above the sea, but the island has been built up from the sea bottom by the lava poured out from the craters, and since the water about the island is about 16,000 feet deep, the volcanic pile, the top of which is the island, is really about 30,000 feet high. This is about the height of the highest mountain above sea-level.

The crater of Mauna Loa (Fig. 392) is 3 miles long, 2 miles wide, and about 1000 feet deep—a very large crater. When the volcano is not active, it is possible to descend into the crater and to walk

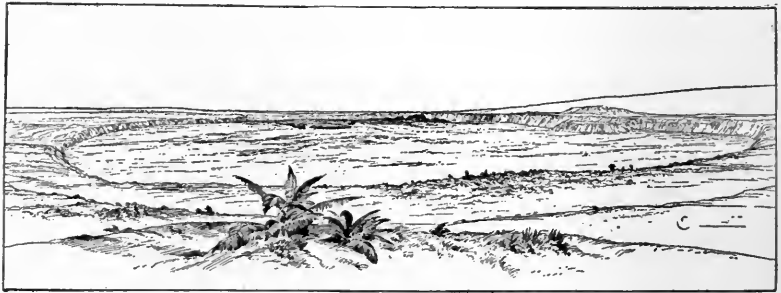

FIG. 393.—View of crater of Kilauea. (U. S. Geol. Surv.)

about on its hard but hot floor. Cracks and other openings are, however, generally present, and give evidence of the hot liquid rock beneath.

Before an eruption the floor of the crater rises, and lakes of lava appear in the enlarged openings in it. At intervals, fountains of lava may rise from the lakes, sometimes to heights of several hundred feet. Finally the eruption occurs; but the lava does not usually flow over the rim of the crater. It generally comes out through fissures which open on the side of the mountain, sometimes far from the top. Through them the liquid lava spouts, sometimes for hundreds of feet, into the air, and then flows down the sides of the mountain in streams. Such streams are sometimes half a mile in width, and flow for 50 miles. The lava streams are somewhat like mountain glaciers in form. Their rate of advance is, however, much faster than that of glaciers, though much slower than that of rivers. The lava flows faster at first, and more slowly as it becomes cooler. Residents in the cities below go out at intervals when the volcanoes are discharging, to see how the streams



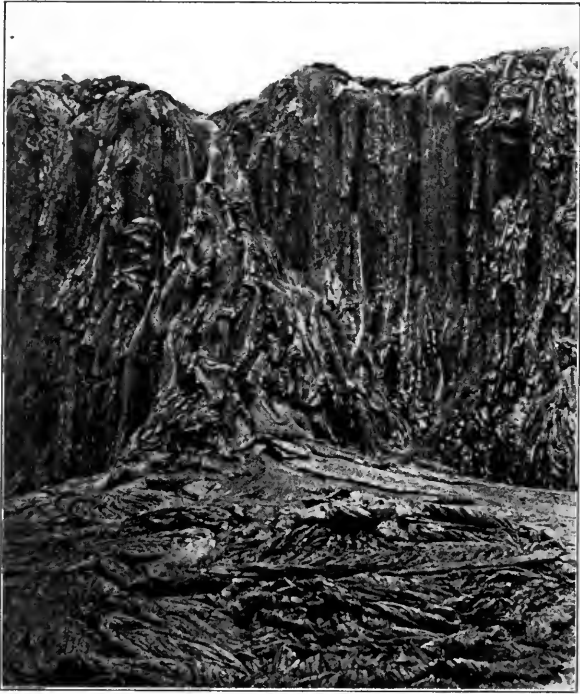

FIG. 395.—Lava falling over cliffs, Kilauea. (H. M. S. Challenger Rept.)



FIG. 396.—Relatively smooth lava surface near the Jordan craters, Malheur Co., Ore. (U. S. Geol. Surv.)

is discharged, and there are no showers of dust or cinders, no loud rumbling or explosive reports, and earthquakes are rare. The



FIG. 397.—Ropy surface of lava, Mauna Loa, flow of 1881. (Calvin.)



FIG. 398.—Clinkery lava, Cinder Buttes, Idaho. (U. S. Geol. Surv.)

eruption may continue for months at a time with so little disturbance that only persons in the vicinity are aware of it.

Hawaii is one of a chain of volcanic islands, 400 miles long. Mauna Loa, therefore, like the other volcanoes studied, is one of a considerable number in its region.

**Common phenomena of an eruption.** From the preceding descriptions the essential features of eruptions may be gleaned. In the explosive type of eruption, rumblings and earthquake shocks



FIG. 399.—The volcano of Colima, Mex., in an active condition, March 24, 1903. (Arreola.)

due to explosions within the throat of the volcano often occur for weeks or months previous to a violent outbreak. As the explosions become violent, ashes, cinders, and bombs are shot forth and fall upon the sides of the cone, while the summit of the mountain is shaken. The clouds of condensed steam and dust rising from the crater darken the sky, and torrents of rain, falling upon the fine dust, form rivers of hot mud. Liquid lava may or may not accompany the discharge of dust, cinders, etc. In the quiet type of eruption, the lava rises in the crater and occasionally overflows its rim; but more commonly a crack is opened in the side of the



cone by an earthquake shock, or by the pressure of the molten rock within, and the lava issues below the top.

There is little or no burning in a volcano, for there is little or nothing to burn. There is therefore no smoke. What appears as smoke is mostly condensed water vapor (cloud), often blackened by the dust.

### *The Products of Volcanoes*

The materials which come out of volcanoes are partly solid, partly liquid, and partly gaseous. The dust, the cinders, and the larger pieces of rock are solid, the flowing lava is liquid, while the number of vapors and gases which issue is large.

**Lava.** All the liquid rock which issues from a volcano is *lava*. The term is also applied to the rock formed when the liquid lava becomes solid on cooling.

Lava never flows so freely as water, and it is sometimes very stiff or viscous. The distance to which it flows depends on its amount, on the slope of the surface over which it flows, and on its liquidity. The greater the amount of lava, the steeper the slope on which it flows, and the more fluid it is, the farther it will flow.

As lava flows its upper surface cools and hardens. The surface of a lava stream may thus become solid, while the interior is still fluid. The fluid part may then break out at the side or end of the hardened shell and flow away, leaving the hollow crust. On further cooling the shell contracts and cracks, and sometimes caves in. Sometimes the hardened surface is broken by the movement of the fluid lava below, and the solid fragments, displaced and upturned by the moving liquid, give the surface a jagged appearance (Fig. 398). In 1872 the Modoc Indians of southeastern Oregon, from their nearly inaccessible retreat among the lava-beds, waged a warfare which was for some time successful against the United States troops.

Lava takes on various forms as it becomes solid. If it hardens under little pressure, as at the surface, the gases and vapors which it contains expand, and it is converted into a sort of rock froth. If the lava solidifies quickly, without becoming frothy, it makes *volcanic glass* or *obsidian*. If the lava cools slowly under pressure, the substances of which it is composed crystallize into the form of various minerals. The kinds and proportions of the minerals depend upon the composition of the lava.

**Cinders, ashes, etc.** The fragmental materials which are blown out of a volcano are often nothing more than portions of lava which solidified before ejection, or during their flight in the air. They may be large or small. Masses of rock tons in weight are sometimes thrown out, and from such masses there are pieces of all sizes down to minute dust particles.

The dust is often transported great distances from the volcano. Being relatively light, it is thrown far into the air and, caught by the winds, its particles are shifted incredible distances, as already noted. While, therefore, the fluid lava and the larger fragmental materials ejected from the volcano stay near the vent, the fine materials are scattered broadcast.

**Gases and vapors.** The gases and vapors which issue from volcanoes are of many kinds. Among the commoner ones are those of water ( $H_2O$ ), carbon dioxide ( $CO_2$ ), chlorine (Cl), hydrochloric acid (HCl), sulphur dioxide ( $SO_2$ ), and hydrogen sulphide ( $H_2S$ ); but with these more important ones there are many others. Some of the gases are poisonous, and, as in the case of Pelée, their temperature is sometimes so high as to be destructive to life.

#### *Number, Distribution, etc.*

**Number.** The number of volcanoes is not easily determined. Various reasons make such determination difficult. In the first place, it is often impossible to say whether a quiet volcano is dormant or extinct. If the former, it should be counted; if the latter, it should not. Again, the vent of a volcano often changes. Instead of discharging lava through a single crater, it may discharge through several subordinate vents, more or less closely associated with the main one. There may be differences of opinion as to whether these several vents should be regarded as separate volcanoes. For this and other reasons, the number of active volcanoes is not capable of definite statement. According to the more common estimates there are between 300 and 400. Something like two-thirds of them are on islands, and the remainder on the continents. There may be many in the sea which are not known, for volcanoes in the *deep* sea might not be readily detected.

**Distribution.** The general distribution of active volcanoes is shown in Fig. 400. Many of them are arranged in belts, and within the belts they are sometimes in lines. The most marked

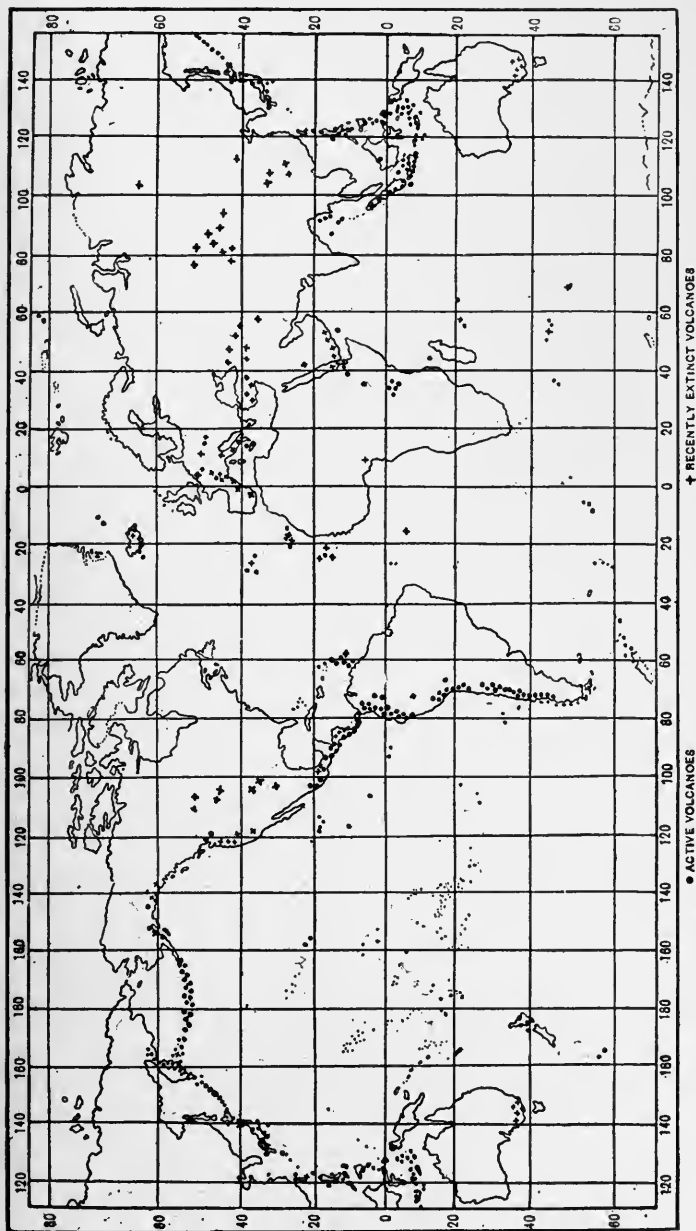

● ACTIVE VOLCANOES  
 ✕ RECENTLY EXTINGUISHED VOLCANOES  
 FIG. 400.—Map showing the distribution of volcanoes. (After Russell.)

belt nearly encircles the Pacific Ocean, as with a girdle of steaming vents. This belt may be said to begin with the volcanic islands south of South America, and includes the numerous vents in the Andes and in the mountains of Central America and Mexico. The belt widens in the western part of the United States, where the volcanoes are extinct, but narrows again in Alaska and the Aleutian Islands. On the west side of the Pacific, the volcanoes form a well-marked belt with many active vents through Kamchatka, Corea, Japan, the Philippine Islands, New Guinea, New Hebrides, and New Zealand. A branch belt includes the volcanoes in the islands of Java and Sumatra. The volcanoes of the West Indies are sometimes considered as an eastern branch of the same belt. Volcanoes are also numerous in the Mediterranean Sea, and there are not a few which cannot be regarded as parts of any well-defined belt.

Most volcanoes are in the sea or near it. Not a few of them are in mountain regions, but it is by no means true that all mountain regions have them. Not a few are on ridges or swells on the sea bottom, or on ridges or swells which rise above the sea. Such, for example, are the West Indian volcanoes. While the volcanoes which are on the continents are on the whole near the shores, they are not all near shores, nor do they occur along the borders of all continents. There is an active volcano in Africa 700 miles from the sea, and there are fresh cones of extinct volcanoes 500 to 800 miles from the sea in Arizona, Colorado, and Thibet. It cannot be said, therefore, that nearness to the sea or mountain ridges are conditions necessary for volcanoes.

Many of the active volcanoes lie near the line where the continental plateau descends to the oceanic basins. Perhaps this is the most significant feature of their distribution.

Volcanoes are, on the whole, not notably more abundant in one latitude than in another. At any rate, they have a wide range in latitude.

The data which are now in hand seem to point to the general conclusion that volcanoes on land are commonly associated with lands which have been recently warped. It is conceived that these movements of the surface have some effect upon the pressures and temperatures of the deeper zones beneath them, and that these variations of pressure and temperature are among the con-

ditions necessary for the extrusion of lava from beneath the surface.

**Historical.** Volcanoes have existed throughout the history of the earth, so far as this history is now known, even back to the earliest ages; but volcanic processes do not seem to have been equally active at all times. There seem to have been periods of great volcanic activity, alternating with much longer periods of much less activity. There is no knowledge, however, that vulcanism ever ceased altogether at any time.

While vulcanism seems to have been continuous, but more or less periodic in its violence, the sites of volcanic activity have shifted from time to time, and the areas where they now exist are not the areas where they existed in former times.

What is now known of vulcanism seems to indicate that, generally speaking, a volcano has a beginning, runs a given course, and dies. The vulcanism of a given region appears to have a similar course.

It appears also that the phase of vulcanism sometimes changes in a given region. In some volcanic regions fissure eruptions came early in the course of the volcanic history. As activity declined, fissure eruptions gave place to volcanoes, and the volcanoes became less and less active, and finally extinct.

Even after vulcanism proper ceases, associated phenomena are continued. Thus in the Yellowstone National Park there are numerous geysers, hot springs, and other vents out of which hot vapors issue. Such phenomena probably represent the last phases of volcanic activity in the region.

#### IGNEOUS PHENOMENA NOT STRICTLY VOLCANIC

**Fissure eruptions.** Lava sometimes rises to the surface through great fissures instead of through the relatively small vents of volcanoes. From such fissures floods of lava spread over the surrounding country sometimes for hundreds of miles. Such lava floods once occurred in Oregon, Washington, and Idaho, where, by successive flows, the pre-existing hills and valleys were buried, and a vast plateau 200,000 square miles or more in extent was built up (Fig. 401). Locally, the nearly level surface of the lava plateau meets the mountains along its border, somewhat as the sea meets the land, while islands of older rock rise above it.

In this lava plateau the Snake River (Fig. 26) has excavated a great canyon 4000 feet deep in some places, and 15 miles wide. The walls of the canyon show the structure of the plateau. They show, among other things, the edges of the successive lava-flows, sometimes separated by beds of sediment, with soils in which the roots and trunks of trees are still preserved. These beds of sedi-

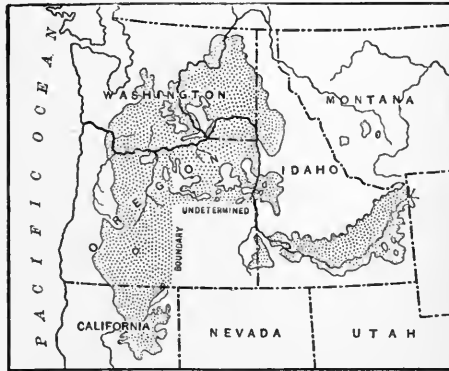

FIG. 401.—Lava-flows of the northwestern part of the U. S.

ment, and these soils, show that long periods of time elapsed between successive lava-flows. At one point in the walls of the canyon, a peak of older rock rising 2500 feet above the river is buried by 1500 feet of lava. A rugged mountain region was here

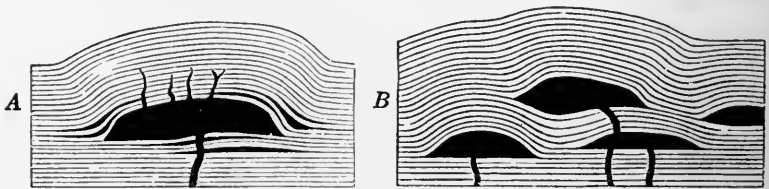

FIG. 402.—A. Ideal cross-section of a laccolith with accompanying sheet and dikes. B. Ideal cross-section of a group of laccoliths. (Gilbert, U. S. Geol. Surv.)

transformed into a plateau by the lava floods. A part of the plateau has since been deeply dissected by streams, parts still remain nearly plane, parts have been broken into blocks which have been tilted into mountain ridges, while still other parts have been arched up into great dome mountains. The Blue Mountains

of Oregon are the most conspicuous example of doming. Badger Mountain of Washington is an elongate dome or anticline.

An older lava plateau of still greater size occurs in India. Owing to its greater age, its nearness to the sea, and the humid climate, it is more dissected than the Oregon plateau. This lava has in some areas weathered so as to form a soil of great fertility, to which the Deccan owes its fame as a cotton-growing country. Prominent hills of lava along the dissected edges of the flows have frequently served as natural forts of great strength in the wars of the country. Other dissected lava plateaus are found on the north coast of Ireland and the west coast of Scotland. Some of the islands off the coast of Scotland are remnants of an old lava plateau.

Fissure eruptions have occurred in Iceland within historic times. In 1783 such flows took place from a fissure 20 miles or so in length. The lava spread out in sheets on both sides of the fissure, advancing in the valleys farther than on the uplands between them. In this respect the lava-flows resemble the movement of glacier ice.

While fissure eruptions of lava sometimes build up plateaus or raise the level of the plains on which they spread, they do not commonly give rise to mountains; but mountains are sometimes developed from them, as they are dissected by stream erosion.

**Intrusions of lava.** Lava is sometimes intruded from below into the crust of the lithosphere, without rising to the surface.

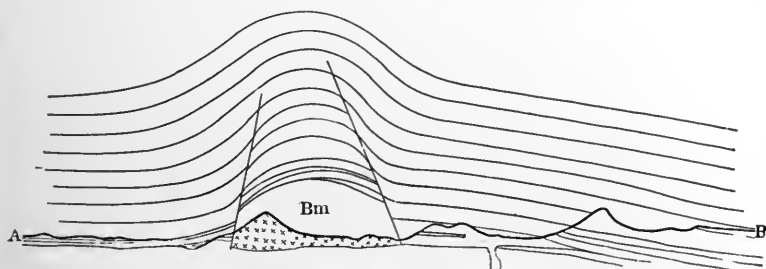

FIG. 403.—Diagram of a bysmalith.

In such cases the surface strata may be arched up over the intrusion, making domes which sometimes reach the size of mountains. Such mountains (Figs. 402, 404), of which the Henry Mountains of Utah are examples, are called *laccoliths*. If the roof of the intrusion is faulted up instead of being arched up, the



FIG. 404.—Relief-map of the Henry Mountains. (Gilbert, U. S. Geol. Surv.)



intrusion is called a *bysmalith* (Fig. 403). Intrusions of very great size are *batholiths*. Lava is sometimes intruded between beds

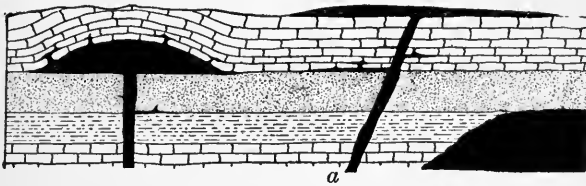

FIG. 405.—Diagrammatic representation of the relations of igneous rock to stratified rock. The igneous rocks represented in black have been forced up from beneath.

of stratified rock in sheets or *sills* (Fig. 405). Lava is also sometimes forced into cracks of the rock, solidifying there as *dikes* (a, Fig. 405).

#### *Causes of Vulcanism*

The causes of vulcanism are somewhat outside the province of physiography, but it may be stated that the lava of volcanoes does not appear to come from a liquid interior, and the lavas from adjacent vents do not appear to come from a common reservoir of liquid rock. This is suggested by the fact that adjacent vents frequently discharge different sorts of lava, and that the lava in adjacent craters often stands at very different heights at the same time.

The great pressure which exists in the interior of the earth because of the weight of the overlying parts, insures a high temperature to the interior. The heat thus developed is continually working its way, in one way or another, to the outer portions of the earth. It passes out by conduction everywhere, and locally, where conditions favor, small amounts of rock may become liquid. This liquid rock then works its way to the surface or toward it. According to this view, the extrusion of lava is to be looked upon as one phase of the passage of interior heat to the surface.

In the explanation of volcanoes, two things are to be accounted for: (1) the liquid lava and the heat necessary for its production, and (2) the force which brings it to the surface.

Lava is to be regarded as a solution of mineral matter in mineral matter, rather than as melted rock. The solution, however, takes place only at high temperatures. Various views have been

entertained as to the source of the heat necessary to cause minerals to dissolve in one another. These views may be grouped into two classes: (1) those according to which the heat is *primary*, that is, that the interior of the earth has been hot always, or that it has been hot since the earth attained its present size; and (2) those according to which the heat which liquefies the rock is *secondary*, and developed in rock (relatively near the surface) which was once cool. Some of the hypotheses of volcanic action based on these views may be considered briefly.

1. It was formerly thought that the whole interior of the earth might be liquid, and that the volcanic vents were connected with this liquid interior. This view was based on certain familiar facts. Deep mines and borings of all sorts show that the temperature increases with increasing depth. The rate of increase varies widely from  $1^{\circ}$  for 17 feet to  $1^{\circ}$  for more than 100 feet. The average rate of increase is commonly stated as about  $1^{\circ}$  for every 50 to 60 feet; but if the estimate be based on the records of those deep mines and other borings which seem to afford the most reliable data, the rate is more nearly  $1^{\circ}$  for 100 feet, down to the greatest depths yet penetrated. It is to be remembered, however, that the deepest excavations are but little more than a mile in depth, and that most excavations on which the generalizations are based are much shallower. If the heat increases at the average rate of  $1^{\circ}$  per 100 feet, a temperature of  $3000^{\circ}$  would be reached at a depth of about 60 miles. Such a temperature would be enough to liquefy rocks *at the surface*, but we are not to conclude that rocks are liquid at this depth even if the temperature is  $3000^{\circ}$ . At this depth, the pressure due to the overlying rock is enormous. Rock expands when it is liquefied, and the pressure at this depth may be enough to prevent expansion, and so to prevent general liquefaction. There are many reasons for believing that, though the temperature of the interior of the earth is very high, the rock is still solid. The fundamental element of the hypothesis, that all volcanoes start from a common liquid center, is therefore believed to be wrong.

2. It has been suggested that there is, at some depth beneath the surface, a liquid layer below the solid crust and above a great solid centre. This hypothesis does not seem to be well supported, and does not seem to meet the objections to the hypothesis first mentioned.

3. Another view has been that while the earth is virtually solid, it is solid *in spite* of its internal temperature, and that if the pressure were lessened at some point beneath the surface, the hot rock would expand and become liquid. The pressure, it is conceived, would be lessened where the outer part of the earth is folded up, as in some mountains. This hypothesis has found much favor, but it does not seem to account for some of the fundamental facts connected with volcanoes, such as their distribution.

The hypotheses that the heat involved in volcanic action is secondary, seek to explain the heat (1) by means of the crushing of rock such as sometimes takes place when beds of rock are folded, or (2) by chemical action between the elements of the rocks, or between these elements and water which descends from the surface. These hypotheses have little acceptance at the present time.

No one of the preceding hypotheses, nor all combined, seem to adequately explain vulcanism, and no hypothesis which seems altogether satisfactory has been put into definite form. It seems possible (1) that the local formation of liquid lava is a process which is constantly but slowly going on in the deep interior, perhaps where the rock material is more readily soluble than the average; and (2) that the liquid rock is continually finding its way to the surface, faster and in greater quantities at some times than at others. The regions where the crust is least stable, that is, where there is movement, are the regions most likely to afford the lava a place of escape, for it is in such places that it is weakest.

The principal forces involved in the extrusion of lavas are apparently two, (1) gravity and (2) the expansive and explosive force of the vapors and gases contained in the lavas, especially water vapor.

Lava beneath the surface would, if lighter than the solid rock above, tend to find its way to the surface, or, more strictly, the heavier rock above would tend to sink down, squeezing out the lighter liquid rock beneath. This has probably been an important factor—perhaps the most important factor—in the eruption of some volcanoes and in some fissure eruptions. If at the same time the region concerned is affected by lateral pressure, this pressure might help to squeeze out the liquid lava. Pressure from above or from the sides seems to be the principal factor involved in the extrusion of lavas in quiet eruptions. Gases and

vapors in the lava tend to expand it, especially as pressure is relieved, and so tend to diminish its specific gravity.

In the case of violent eruptions the gases and vapors, especially water vapor, appear to play a principal part. Even in these cases, however, it is probable that gravity is the principal factor in getting the lava up near to the surface, and that the vapors and gases come into effective function only as the surface of the lithosphere is approached.

The source of the vapors which issue from volcanoes is a matter about which there is much difference of opinion. Among the vapors which escape from volcanoes there are those which might have been derived from sea-water. From this fact it was inferred that sea-water had access to the sources of the lava. It is now thought, however, that water probably does not descend more than five or six miles beneath the surface of the lithosphere, for below some such depth, pores and cracks, without which water cannot descend, do not exist. It seems certain that the sources of the lava are much deeper, and it therefore seems improbable that descending water, either from the sea or from the land, reaches the sources of vulcanism.

It seems probable that lava from depths far below all ground-water is forced up to within a short distance of the surface before coming into contact with water. In its passage through the outer part of the crust, which contains water, the lava doubtless converts water into steam; and the steam thus produced is possibly an important factor in the rise of the lava through the outermost portion of the earth's crust. But there is the best of reason for believing that lava brings up vapors and gases, and among them water vapor, from much greater depths. Such gases and vapors must, it would seem, have been long within the earth. It is probable, indeed, that some of them are now reaching the surface of the earth for the first time. If this be true, they are to be looked upon as original constituents of the earth.

#### *Topographic Effects of Volcanic Action*

Many volcanoes build up great cones, some of them mountain-high, as already indicated. The first stages of growth have sometimes been observed.

**Volcanic cones.** In 1538 a small volcano appeared on the

north shore of the Bay of Naples, and built up a cone 440 feet high and half a mile in diameter at its base in a few days. Its crater was more than 400 feet deep. The development of the volcano was preceded by earthquakes, which were felt in the same regions for two years before the volcano was formed.

In 1770 the volcano Izalco in Central America broke out in the midst of a plain which was then a cattle-ranch. Since that time it has built up a symmetrical cone about 3000 feet high, with steep slopes. In the earlier part of its history, lava-flows, attended with streams of cinders, etc., were of frequent occurrence. For many years no lava has flowed out, though the volcano has remained active, discharging explosively. Earthquakes and rumblings preceded the original eruption.

In January, 1880, a volcano broke out in Lake Ilopango, San Salvador, Central America. The eruption continued more than a month, heating the waters of the lake, killing the fish, and forming a cone-shaped island rising 160 feet above the lake, which was 600 feet deep. A violent earthquake occurred in this region a few months before the birth of the volcano. After the earthquake the water of the lake sank 35 feet.

Early in the last century a volcanic island (Graham Island) arose in the Mediterranean, between Sicily and Africa, where the water had been 800 feet deep. In 1831 a ship near the place felt earthquake shocks. In July a sea-captain reported that he saw a column of water 60 feet high and 800 yards in diameter rising from the sea, and soon afterward a column of steam which rose 1800 feet. A few days later there was a small island 12 feet high where the disturbance had been, and in its centre there was a crater, from which eruptions were seen to be taking place. By the end of the month the island was 50 to 90 feet high and  $\frac{3}{4}$  of a mile in circumference. On August 4 it was 200 feet high and 3 miles in circumference. Activity soon ceased, and early in 1832 the island had been destroyed by the waves. This volcano was short-lived, as was the island which it built.

Volcanoes have recently built up islands off the coast of Alaska. In 1795 such an island appeared about 40 miles west of Unalaska. In 1872 this island was 850 feet above the sea, but had no crater. In 1883 another island appeared close by, and was later joined to the first. In 1884 it was 500 to 800 feet high.

Great mountains, as well as small ones, are often formed by



FIG. 406.—Mt. Shasta, a typical volcanic cone furrowed by erosion, but retaining its general form. (U. S. Geol. Surv.)



FIG. 407.—A part of the "crater" of Coon Butte, Ariz. The "butte" is only the rim built up about the "crater" by the material blown out. (R. T. Chamberlin.)

volcanoes. Thus Mt. Rainier in Washington (Fig. 408), Mt. Hood in Oregon (Fig. 227), Mt. Shasta in California (Fig. 406), and the San Francisco Mountain in Arizona (Fig. 411), as well as numerous other high and well-known mountain peaks, were built up by volcanoes. The volcanoes themselves have been dead for long. Rainier, Hood, and Shasta are all so high that, in spite of their origin, snow-fields and even glaciers are found on them.

Many small islands, and some large ones, such as Iceland, are due chiefly or wholly to the building up of volcanic cones which have their foundations on the ocean bottom. The Aleutian Islands, the Kurile Islands, and many of the islands of Australasia were formed in the same way. Among the latter are the famous Spice Islands (Moluccas) so important in connection with the early history of America.

By the making of cones, volcanoes become an important factor in shaping the surface of the lithosphere. The number of volcanic cones which have assumed mountain size on land is large, and the number in the sea still larger; but in spite of their great number, their aggregate area is relatively slight. The total area of mountainous lands developed by volcanoes is but a fraction of the area of mountain land developed in other ways.

Intrusions of lava may give rise to mounds, mountains, or even plateau-like swells (*laccoliths*, *bysmaliths*, *batholiths*), as already indicated.

In Arizona (near Canyon Diablo) there is a crater-like depression with a distinct rim about it, composed of the material which was blown out of the depression. The rim is high enough to be seen from a great distance, and is known as *Coon Butte* (Fig. 407). There is no lava about the butte, and it cannot therefore be called a volcano. Apparently a great explosion beneath the surface blew out a large quantity of rock from the crater-like depression, forming the high rim. The formation of this depression may perhaps be looked upon as a preparatory step for a volcano. If so, the process was arrested before a volcano was developed.<sup>1</sup>

<sup>1</sup> The hypothesis was advanced long since by Gilbert that this so-called butte, with its accompanying depression, was due to the fall of a large meteorite. Mr. Gilbert abandoned this hypothesis, after somewhat full investigation, but it has been revived recently, in modified form, by Fairchild (Bull. G. S. A., Vol. XVIII, p. 493.)

**Destruction of volcanic cones.** 1. A volcanic cone may be partially destroyed by a violent explosion, as in the cases of Krakatoa and Vesuvius, already cited. Enormous depressions, called *calderas*, several miles in diameter and hundreds of feet deep, may be developed in this way from previous cones and craters.

A volcanic cone may be undermined by the withdrawal of the liquid lava in the core of the mountain, if it escapes at a lower level. The entire summit of the mountain may then sink and be engulfed, thus forming a caldera. Crater Lake, Oregon (p. 305), occupies a caldera in the stump of a great volcanic cone (Figs. 333-336). There are several large calderas in the Azores, and the floors of some of them are the sites of villages.

2. Volcanic cones are also destroyed by the less violent processes of weathering and erosion. The destruction of Graham Island by the waves has already been cited. Wind and rain attack volcanic cones as soon as they are formed, but their results are not conspicuous until the volcano is extinct and the cone stops growing. Cones composed largely of cinders, etc., are worn away with comparative ease, while those of lava resist longer. Glaciers frequently aid in their degradation. Among the many extinct volcanic peaks in the western part of the United States, it is possible to find illustrations of various stages in the process of destruction. Only those of relatively recent origin still show their unmodified or but slightly modified forms. All volcanic cones except those of recent origin have lost their craters and the symmetry of slope which they probably once possessed.

**Examples of fresh cones.** In Arizona, California (Fig. 364), Idaho, Oregon, and elsewhere in the United States, there are volcanic cones so recently formed that they have suffered little destruction. Their conical forms have been little disfigured by erosion, and their surface materials appear to have been but little changed by weathering. Cones of similar freshness are found in other lands, as in the Auvergne (France).

**Examples of worn cones.** *Mt. Shasta* (Fig. 406), in northern California, is a volcanic cone which rises 2 miles above its base, 17 miles in diameter, to a height of 14,350 feet above the sea. It is partly of lava and partly of fragmental material. Its upper slopes are steep and furrowed with ravines. About 2000 feet below the summit on the west side is a fresher and therefore younger cone, known as Shastina, with a crater in its top. Re-



mains of more than 20 smaller cones also occur on the lower flanks. Near the base are several lava-fields which, from the roughness of their surfaces and the absence of soil, are known to have been formed since the glaciers occupied the summit. The fact that the Sacramento River has cut a narrow gorge 100 feet deep across one of them proves, however, that the last eruption was many years ago. Mt. Shasta is a good example of a volcano which has suffered some erosion, but about which evidence of recent eruptions has not been destroyed.

The great changes which Shasta has undergone are made clear by the fact that the once hot mountain is now the home of several glaciers, which, moving over its slopes, are helping to waste it away.

*Mt. Rainier* (Fig. 408) is another splendid mountain developed by a former volcano. Various features of the mountain show



FIG. 408.—Mt. Rainier, Wash.

that a second period of activity followed a long period of quiescence in the history of this snow-capped mountain. Hot vapors still issue from some small vents in the mountain, though the discharge of rock material ceased long ago. The mountain is snow-covered and the home of several glaciers.

*Mt. Hood* (Fig. 227), one of the peaks of the Cascade Range, has been eroded more than Rainier. Only a part of the wall of its summit crater remains, and its sides are deeply furrowed by ravines, which are separated by sharp, jagged ridges, and precipices hundreds of feet in height. Nevertheless, sulphurous fumes are still escaping from openings in the rocks, even on the snow-clad summit.

*The Marysville Buttes.* This circular cluster of hills (Figs. 409 and 410), 10 miles in diameter, rises 1700 to 2000 feet above the level of the Sacramento River in California. The buttes are composed of lava with an outer layer of fragmental material (or tuff). The volcanic cone, which probably once rivaled Vesuvius,

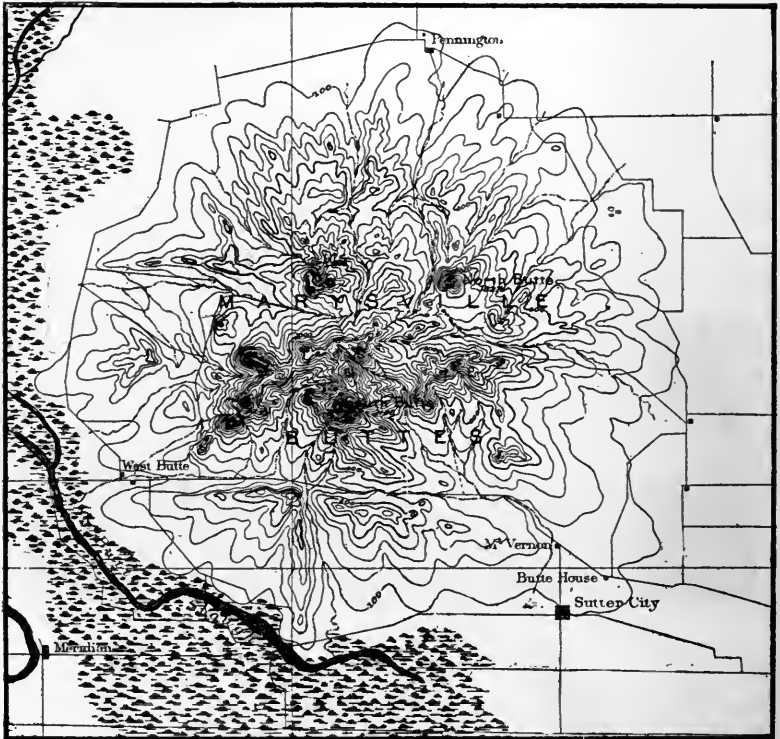

FIG. 409—Marysville buttes in contour. (U. S. Geol. Surv.)

has been dissected into a group of hills with jagged and fantastic outlines. So deeply have the roots of the mountain been laid bare that the broken and distorted layers of sedimentary rock through which the lava was erupted are exposed.

The *San Francisco Mountain* (Fig. 411) is another example of a volcanic mountain partially destroyed by erosion. The form of the old cone can be but imperfectly known. Numerous minor volcanoes existed about the main one after the latter be-

came extinct. It is said that the number of fresh volcanic cones in this vicinity is more than 300. Many of them are so young that they show little sign of erosion.

*Indirect Topographic Effects of Vulcanism*

**Volcanic necks.** When a volcano becomes extinct, the throat, or passage from the interior, may be filled with hardened lava. This may be of much more resistant rock than the rest of the cone. The cone may in time be worn away, but the *plug*, transformed

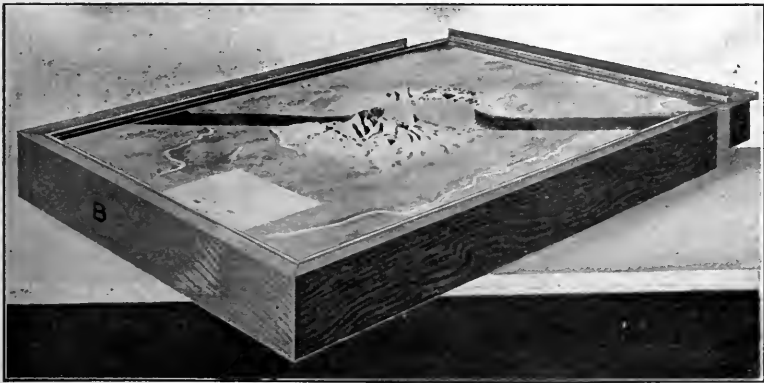
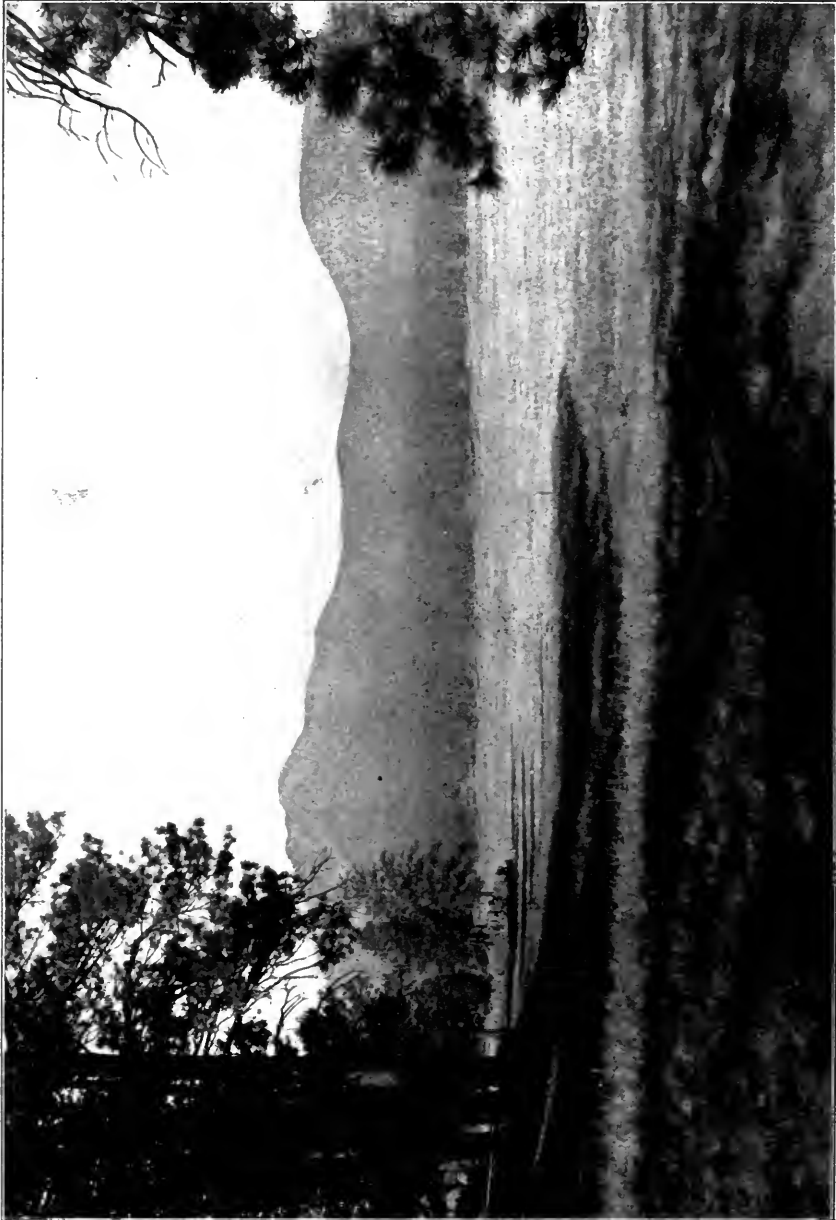

FIG. 410.—Marysville volcanic cone. (Photograph of model by Newsome.)

into a hill, may still mark the site of the former volcano. These volcanic *necks* or plugs are sometimes conspicuous. East of the Mt. Taylor plateau, in central Mexico, a number of them rise by precipitous slopes 800 to 1500 feet above their surroundings. Massive intrusions of lava have the same effect (Fig. 171).

Intrusions of lava may give rise to topographic features of importance after erosion has affected the regions where they occur, for the hardened lava or igneous rock is often harder than its surroundings. Dikes often give rise to ridges (Fig. 412). Sills also, if they have been tilted notably from a horizontal position, give rise to ridges which may be so high as to be called mountains. The Palisade Ridge of the Hudson (Fig. 413) and most of the mountains of the Connecticut River Valley are illustrations. A sheet of lava poured out on the surface and subsequently buried



by sediment may have the same effect on topography as a sill. The Watchung Mountains of New Jersey are the projecting edges



FIG. 412.—A dike isolated by erosion, Spanish Peaks region, Colo. (U. S. Geol. Surv.)



FIG. 413.—The Palisade Ridge.

of extrusive sheets of lava, once buried beneath sedimentary rocks, then tilted, and later isolated by erosion. Sills and extrusive

sheets of lava may also give rise to buttes, mesas, rock terraces, etc.—indeed, to all the topographic forms which result from the erosion of rock of unequal hardness (p. 163).

**Columnar structure.** Hardened lava sometimes assumes a columnar structure (Figs. 414 and 415). This is probably the result of the contraction incident to cooling. The surface of the homogeneous lava contracts about equally in all directions on cooling. The contractile force may be thought of as centering about equidistant points. About a given point the least number of cracks

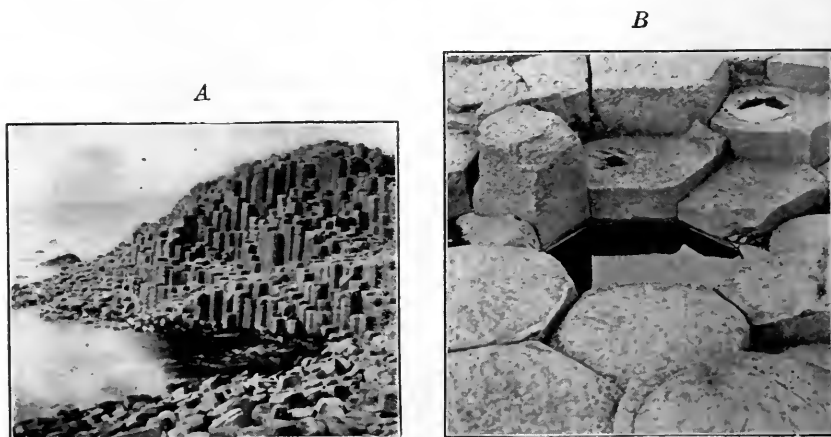

FIG. 414.—*A*. Columnar structure in basalt. Giants Causeway, Ireland.  
*B*. Columnar structure on a larger scale.

which will relieve the tension in all directions is three (*A*, Fig. 415). If these radiate symmetrically from the point, the angle between any two is  $120^\circ$ , the angle of the hexagonal prism. Similar radiating cracks from other centers complete the columns (*B*, Fig. 415). A five-sided column would arise from the failure of the cracks to develop about some one of the points (*C*, Fig. 415).

#### *Mud Volcanoes*

Mud volcanoes have some features in common with volcanoes and some in common with geysers, while in others they depart from both. Like volcanoes and geysers, they are eruptive, but, as the name implies, their discharge is mud, instead of lava or water. The general conditions which seem to be necessary for their existence are (1) sufficient heat beneath the surface, presumably at

a relatively slight depth, to produce steam, and (2) a surface layer of earthy material, which when moist becomes mud. The steam

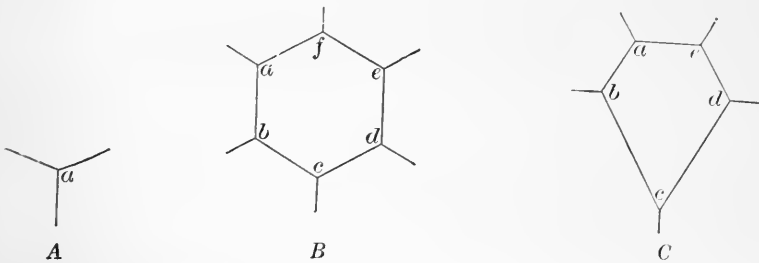

FIG. 415.—Diagrams to illustrate the formation of columns in basalt: *A*. The first stage is the development of a hexagonal column. *B*. The completion of a hexagonal column. *C*. A pentagonal column.

escaping through the mud forces some of it out, building up small cones which simulate volcanic cones in form, though not in constitution. They never reach great size.



FIG. 416.—Mud cones Yellowstone National Park. (Fairbanks.)

Like geysers, mud volcanoes occur in regions of present or relatively recent vulcanism, for the most part. They are some-

times violently explosive, and sometimes not. Some of them erupt at infrequent intervals, and some nearly continuously.

The "paint-pots" (Fig. 416) of the Yellowstone Park belong to the same category, though from them there is little discharge, and they do not build considerable cones.

When quantities of gas escape from beneath the surface through wind, eruptions somewhat like those of mud volcanoes may take place, even in the absence of heat.

#### MAP EXERCISE

I. Study the following maps showing volcanic mountains, in preparation for the conference:

1. Marysville, Cal.
2. Mt. Lyell, Cal.
3. Mt. Shasta, Cal.
4. San Francisco Mountain, Ariz.
5. Crater Lake, Ore.

*Note.*—If models of any of these mountains are available, study them in connection with the maps. Photographs of the mountains appear in some of the works of the reference list, and these may well be studied in connection with the maps.

For Crater Lake and its surroundings, see reference 10, and for Mt. Shasta, reference 7, at end of chapter.

- II. 1. Make a special study of the topography of the volcanic mountains to determine how far their present configuration is the result of the original cone-building, and how far the result of subsequent erosion.
2. Arc craters in original or modified form shown on any of the maps?

#### REFERENCES

1. Standard text-books on Geology.
2. RUSSELL, *Volcanoes of North America*: Macmillan.
3. JUDD, *Volcanoes*: Appleton.
4. BONNEY, *Volcanoes*: G. P. Putnam's Sons.
5. *Recent Eruptions in the West Indies*. HEILPRIN, *Mt. Pelée and the Tragedy of Martinique*, Lippincott; HILL, *Nat. Geog. Mag.*, Vol. XIII, pp. 223-267; RUSSELL, *Nat. Geog. Mag.*, Vol. XIII, pp. 267-285, 415-435; HOVEY, *Nat. Geog. Mag.*, Vol. XIII, pp. 444-459, *Am. Jour. Sci.*, Vol. XIV, 1902, pp. 319-358, and *Bull. Am. Mus. Nat. Hist.*, Vol. XVI, pp. 333-372.
6. Rept. of the Roy. Soc. on *The Eruption of Krakatoa*: Trübner & Co.
7. DILLER, *Mt. Shasta*, in *Physiography of the United States*: Am. Book Co.



8. DUTTON, *Hawaiian Volcanoes*: 4th Ann. Rept. U. S. Geol. Surv.;  
and *Mt. Taylor and the Zuñi Plateau*: 6th Ann. Rept. U. S. Geol. Surv.

9. GILBERT, *Geology of the Henry Mountains*: U. S. Geol. Surv.

10. DILLER and PATTON, *Geology and Petrography of Crater Lake Park*,  
Part I: Professional Paper 3, U. S. Geol. Surv.



FIG. 417.—Mt. Wrangell, Alaska. (U. S. Geol. Surv.)

## CHAPTER VIII

### CRUSTAL MOVEMENTS. DIASTROPHISM

#### SECULAR CHANGES

IN many places the coastal lands appear to have recently risen from the sea, while in others coastal tracts appear to have been recently submerged. The most obvious evidence of the apparent rise is found in the beaches and other shore features now well above sea-level, and the most obvious evidence of sinking is found in the drowned lower ends of rivers (p. 173). These relative changes of level of the land are best seen along the sea-shore, because the sea-level is the place from which land elevations are measured. Movements of the outer portions of the solid part of the earth are also in progress, or have recently taken place, far from coasts, but they are not so readily detected, and are therefore less well known. Some of them have been referred to incidentally in other connections (p. 174). The changes of level are in general so slow that no motion is seen from day to day, or even from year to year. All that is seen is the result of changes which have been going on slowly for centuries.

Movements of the earth's crust (outer parts of the lithosphere) were first *inferred* from various phenomena along the shores. They were subsequently *demonstrated* by careful measurements which have shown not only the fact of movement, but in some cases its rate.

It is to be especially noted that beaches or other shore marks above the present level of the sea do not necessarily mean that the land has risen. They might mean depression of the sea-level instead, but in either case they mean increased emergence of the land. Similarly, the lower ends of valleys would be drowned by the rise of the sea just as effectively as by the sinking of the land; but in either case there has been a depression of the land *relative*

*to sea-level.* In some situations and relations it may be possible to say whether it is the land or the sea surface which has changed its position; but in general it is best to think of the changes as relative.

*Evidences of (Relative) Elevation of Land*

1. **Human structures.** In certain regions which have been long inhabited, structures which were once at sea-level are now above it. Thus on the island of Crete, in the Mediterranean Sea, the remains of old docks are in some places as much as 27 feet above the water. This is the more extraordinary since other parts of the same island have sunk so as to submerge human structures, the ruins of which are still visible beneath the water.

2. **Rocks.** Several rocks in the Baltic Sea which within historic time were at sea-level, or so little below it as to be dangerous to navigators, are now well above the water. One is said to have risen about 60 feet in 50 years. From an inscription supposed to be about 500 years old in Lake Maelar (near the Baltic), the land at that point is inferred to have risen about 13 feet in the 50 years preceding 1730.

3. **Measurements.** Changes of level were recognized long ago in Scandinavia, and they excited so much interest that marks were made on the shores at different places and kept under observation for a period of years in order to determine the rate of change of level between land and water. These observations showed that the coast was gradually becoming higher relative to the Baltic.

In recent times it has been found that the larger part of the coast of Scandinavia is rising relative to sea-level, but that it is rising at unequal rates, and that the southern extremity is sinking. In some localities the rate of rise has been determined to be about  $2\frac{1}{2}$  feet per century.

4. **Organic remains; fossils.** Another line of evidence pointing to the rise of coasts is found in the shells, tests, etc., of marine animals found above sea-level. Thus barnacle shells are sometimes found above the surface of the water, attached to the rocks where they grew. There is no escape from the conclusion that the sea-level has sunk, or the land risen, to the extent of their height above sea-level. Beds of marine shells accumulated beneath the sea are also sometimes found above sea-level. Such shells are conclusive

of the relative rise of the land, *in case they are known to have been deposited by the sea-water*. The evidence from unattached shells must, however, be carefully scrutinized, since birds and other animals frequently carry marine shells inland and up to considerable heights.

Beds containing sea-shells which were certainly deposited beneath the sea are now found above the water at various points, as along the coast of Sweden, and at some points in North Greenland, where they occur up to heights of 100 to 200 feet. The shells here are so fresh that in some cases they are still covered with the epidermis. The sand in which they are imbedded is frozen during a large part or all of the year, and the low temperature undoubtedly keeps the organic matter from decay. Darwin long ago found shells, etc., along the west coast of South America up to elevations of 1300 feet above sea-level. On the coast of Peru a reef of corals of modern species is said to be found at an elevation of nearly 3000 feet. On the coast of the New Hebrides, coral reefs occur up to 2000 feet, and on the coast of Cuba up to heights of 1000 feet or more.

**5. Raised beaches, etc.** Raised beaches and terraces along the shore are also evidences of change of level. Such features are found along many parts of the northern coast of western Europe and eastern North America, about the West Indies, on the California coast, and in many other places. Along certain coasts, for example those of California and Scotland, towns are situated on these elevated terraces, and wagon-roads and railroads follow them for considerable distances.

One of the significant facts concerning the elevated beaches and other shore features is that they are no longer horizontal. The island of Crete, already cited, affords an illustration, and the coast of Scandinavia another.

**6. Sea cliffs.** Sea cliffs (Fig. 418) developed by wave-cutting are sometimes found above the elevated shore terraces.

**7. Sea caves.** Waves sometimes develop sea caves at water level. Caves developed in this way are now sometimes found at levels considerably above the sea. Such caves occur on the coast of Scotland up to levels of 100 feet.

All these phenomena are evidences that the land has risen *relative to the sea*, in many places, in recent times.

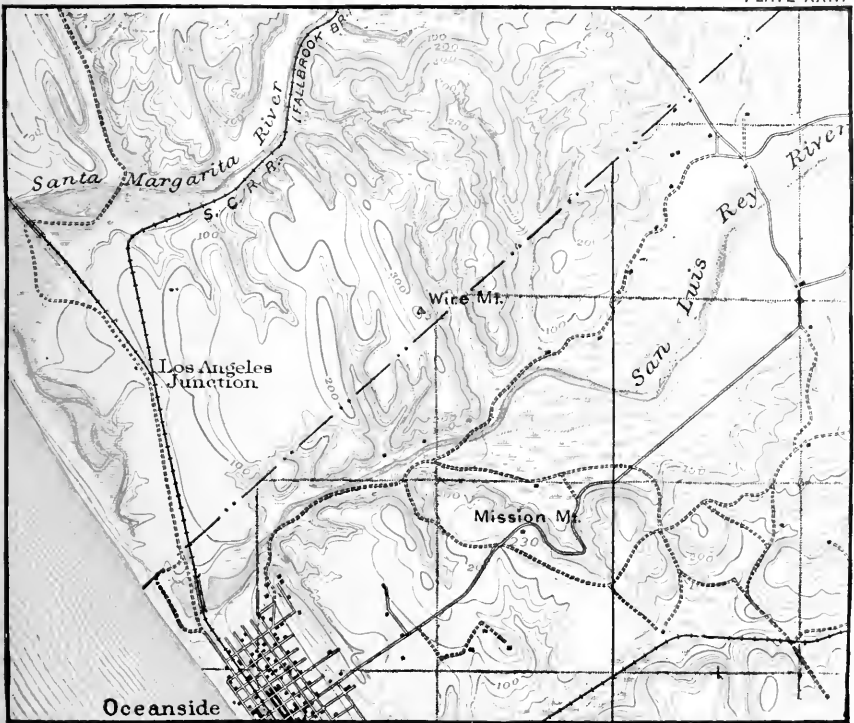

A section of the California coast, showing lands, near the coast, which have recently emerged. Scale 1 - mile per inch. (Oceanside, Cal., Sheet, U. S. Geol. Surv.)

PLATE XXIV

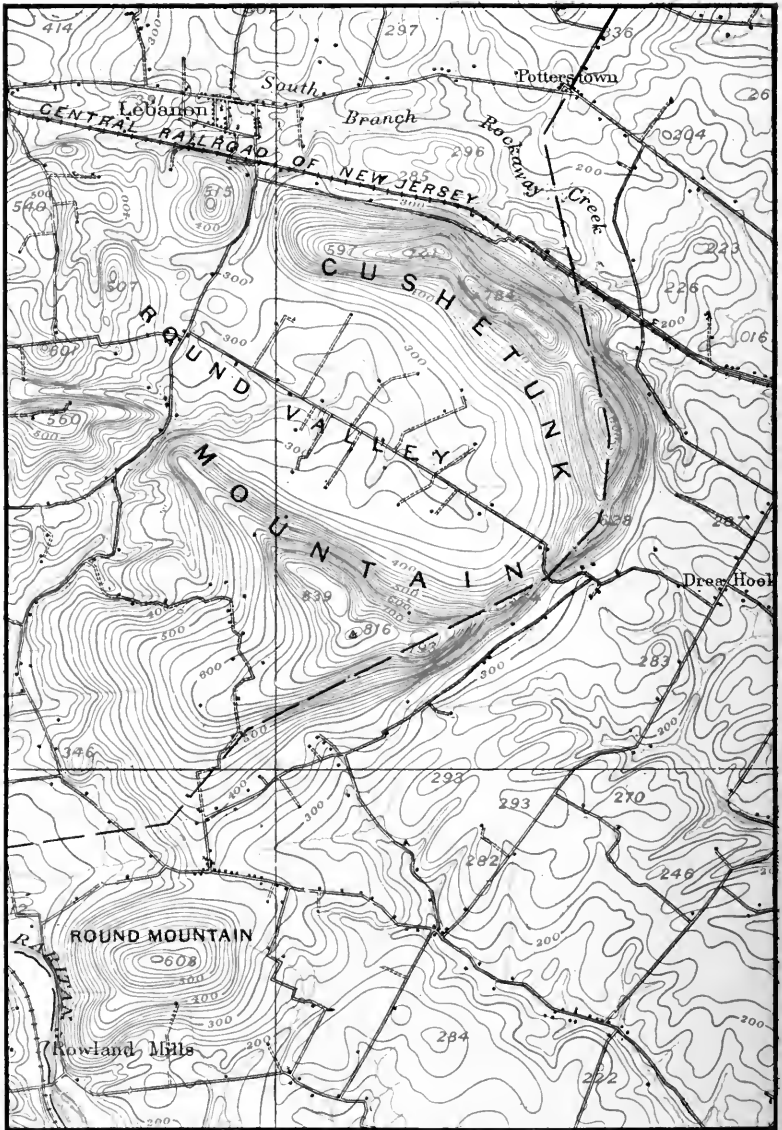

Cushtunk and Round Mountains, New Jersey; examples of isolated mountains left by the removal of less resistant surroundings. Scale 1—mile per inch. (High Bridge Sheet, U. S. Geol. Surv.)

*Evidences of Relative Depression*

Evidences of the sinking of land are, in the nature of the case, less readily seen, because they are for the most part beneath the water.

1. **Human structures.** It has already been noted that at the east end of the island of Crete ancient buildings are submerged.



FIG. 418.—Wave-cut terraces. West side of Ojai Valley, Cal. (Arnold.)

Certain portions of the coast of Greenland have likewise been sinking recently, for various human structures on low coasts have sunk, and still stand beneath the water. The southern end of



FIG. 419.—Wave-cut terraces. Bottle and glass. St. Vincent. (Hovey, Am. Mus. Nat. Hist.)

Scandinavia, as already noted, has been sinking recently, while the rest of the peninsula appears to have been rising. "At Malmö one of the present streets is over-flooded by the waters of the Baltic when the wind is high, and excavations made some years ago disclosed an ancient street at a depth of eight feet below the present one."

2. **Submerged forests.** Along some coasts there are evidences of submerged forests. This is the case, for example, at some points north of Liverpool, England (Fig. 420). Here, when the tide is



FIG. 420.—Stumps laid bare on the beach at low tide. Leasowe, Cheshire, Eng. (Ward.)

out, numerous stumps may be seen standing on the beach where the trees once grew. Since trees of the varieties represented by these stumps do not grow in salt water, there is no alternative but to conclude that the land where they grew, once dry, has since sunk



FIG. 421.—Masses of peat and tide marsh sod, broken up by storm waves and washed ashore near Sea Isle City, N. J. (Knapp, N. J. Geol. Surv.)

below the level of high water. On the coast of New Jersey stumps have been found seven feet below sea-level at low tide. Old marsh-lands are submerged beneath the sea along some shores. From them the strong waves of storms sometimes wrench large masses of peat and toss them up on the shore.



This was the case at Cape May in New Jersey in a violent storm but a few years ago (Fig. 421).

3. **Submerged valleys.** Some river valleys on land are continuous with valleys in the shallow sea bottom far out beyond the coast-line (Fig. 422). Such submerged valleys indicate that the surface in which they are cut was land when they were excavated, and that subsequent sinking has submerged them. The numerous bays along the eastern coast of the United States, especially between New York and the Carolinas, indicate recent sinking of the land,

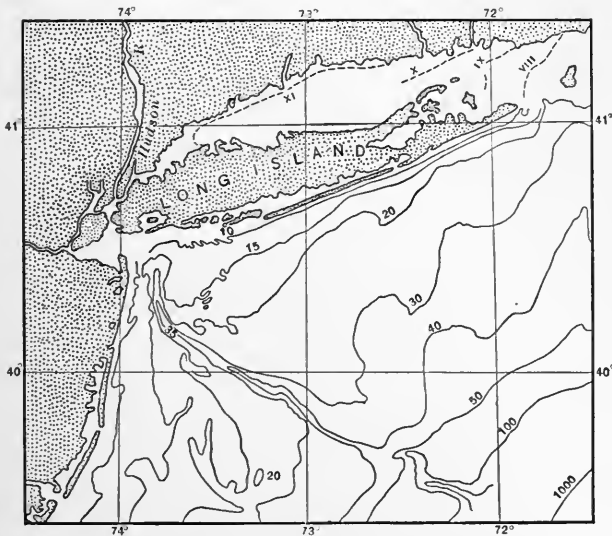

FIG. 422.—The submerged valley which is believed to be the continuation of the Hudson Valley. The position of the valley is indicated by the contours. Depths in fathoms. (Data from C. and G. Survey.)

enough to carry the lower ends of the former valleys below sea-level, thus converting them into bays. Submerged valleys of this sort occur in many parts of the earth, and show that submergence of coastal lands is now taking place, or has recently taken place, along many coasts.

4. **An Italian temple.** One of the most striking cases of change of level appears to involve both upward and downward movement. On the shore of Italy, near Naples, are the ruins of an old temple. From inscriptions it is known to have been above water as late as 235 A.D. In 1749 several columns of the temple were

found still standing. Their bases were buried to a depth of 12 feet in sediment deposited by the sea. For 9 feet above the sediment, the columns were filled with holes bored by marine animals. It is inferred, therefore, that between the years 235 and 1749, the land on which the temple stood sank until the water stood 21 feet above the bases of the columns, and then rose again so that its floor was above sea-level.

*Is it the Land or the Sea which Changes its Level?*

It is clear that if the outside of the lithosphere, commonly called the *crust of the earth*, is subject to warping, some parts rising and some sinking, the observed phenomena of coasts could be readily explained; and, in most discussions of the changes of relative level of land and sea, it is commonly assumed that the land, rather than the sea, is the element which changes. The validity of this assumption has, however, been questioned, and with reason. The alternatives are several, namely: (1) Is it the sea rather than the land which changes its level? Or (2) do both land and sea change their levels? In the latter case (*a*) does each rise and fall, or (*b*) does one rise *and* fall while the other rises *or* falls only? Certain general considerations will make it clear that some of these alternatives are not tenable.

Other conditions remaining constant, the sea-level would be depressed everywhere if depressed at one point, because all oceans are connected. In this case, all coasts would *appear to rise*. Similarly, if the sea-level rose at one point, it would seem that it should rise everywhere, in which case all coasts should appear to be sinking at the same time. Since some coasts seem to be rising while others seem to be sinking, it is clear that the changes of level of the sea surface, taken alone, do not explain the observed phenomena. It does not follow, however, that such changes may not be one of the elements involved in the explanation of the observed phenomena.

Without discussing all the other alternatives separately, the principles involved in the problem may be readily understood.

Let us suppose the sea-level to be lowered at all points, as it would be by the sinking of the bottom of any one of the ocean basins, and let us suppose further that the continents sink at the same time. Under this general conception various cases arise.

(1) If the lands are lowered as much as the sea-level, and lowered equally everywhere, the relation of coasts to sea-level would not be changed. (2) If the land were lowered more than the sea, and lowered equally everywhere, the old coast-lines would all be submerged. (3) If the land were lowered less than the sea, and lowered equally everywhere, all coasts would appear to have risen. (4) If different parts of the coasts sank unequally, those parts which sank less than the sea would appear to have risen, those which sank as much as the sea would not have changed their position relative to sea-level, and those which sank more than the sea would appear to have sunk.

All these relations are illustrated by Figs. 423 to 425. The sea-level, which in Fig. 423 is at  $AB$ , is represented in Fig. 424 as

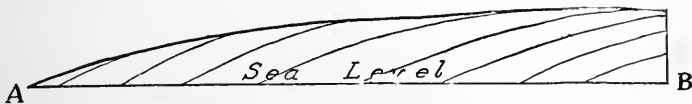

FIG. 423.—Diagram showing a coastal tract rising above sea-level.

having sunk from  $A'$  to  $B'$ . In Fig. 425 the sea-level of Fig. 423 is represented as having sunk, but the land of the old coast-line has sunk more than the sea from  $A''$  to  $C$ , as much as the sea at  $C$ , and



FIG. 424.—Diagram showing the same coast as Fig. 423, after the sea-level has been lowered uniformly. The land appears to have risen.

less than the sea from  $C$  to  $B''$ . From  $A''$  to  $C$  the coast seems to have sunk, from  $C$  to  $B''$  it seems to have risen.

It appears, therefore, that all apparent risings and sinkings along coasts might be explained by unequal sinking of land while the sea-level is being lowered; but it does not follow that this is necessarily the true explanation. Existing phenomena about coasts may be explained on the supposition that coastal lands rise locally and sink locally, as well as on the supposition that they sink only. They may be equally well explained on the supposition that the sea-level sometimes rises and sometimes sinks, at the same time that the coasts are being warped, in some places up and in some places down. On the whole, it seems probable that the

sea-level does change, sometimes rising and sometimes sinking, and that coastal lands are warped upward in some places and downward in others, and that observed phenomena involve all these movements.

Current theories of the origin and history of the earth all proceed on the assumption that the earth is a cooling and therefore a

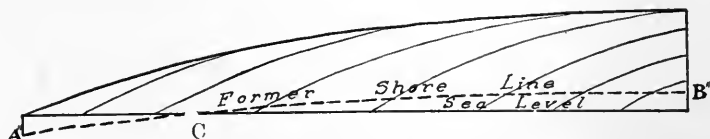

FIG. 425.—Diagram showing the same area as the preceding. The sea has sunk as much as in Fig. 424, but the land at the left has also sunk, and has sunk more than the sea-level has. At the left, therefore, the land seems to have sunk and at the right it seems to have risen, while at one point, C, it appears to have neither risen nor sunk.

contracting body. If this be true, it is clear that depressions rather than elevations of the surface must be the rule, and that such elevations of the surface of the lithosphere as take place are incidental to the general lowering of surface which results from contraction.

We may now inquire into the causes which make, or which may make, the surface of the sea rise and fall, and also into the causes which make, or may make, the surface of the lithosphere rise and fall locally.

#### *Why the Sea-level Changes*

**Sedimentation.** Rivers carry a large amount of sediment from the land to the sea each year (p. 154). This material, deposited on the sea bottom, tends to fill the ocean basins. The result must be rise of the sea-level. The detritus worn from the shores by waves, blown from the land by winds, and brought to the sea by glaciers, is likewise deposited beneath the water and produces the same result. The material extracted from the seawater by plants and animals, and deposited on its bottom when they die, likewise helps to raise the surface of the sea, for the space occupied by shells, etc., exceeds the reduction of volume suffered by the water when the material of the shells was extracted from it. Rise of the surface of the sea due to sedimentation would be universal.

The rise of the sea due to sedimentation is extremely slow, too slow to be obvious from year to year, or perhaps even in a lifetime. But if existing lands were base-leveled, the resulting rise of sea-level would be hundreds of feet, enough to submerge a very considerable part of the existing land, and a much larger part of the land as it would be after base-leveling. There is reason to believe that great areas have been nearly base-leveled in the past. Degradation of the land and aggradation of the sea bottom may, therefore, have been very important factors in the repeated submergence of great areas of land in past ages.

It is presumed that evaporation from the sea is balanced by rainfall and by the inflow of rivers. If this is the case, evaporation and precipitation do not affect its level. But if great quantities of water evaporated from the sea were to be retained on the land in the form of ice, as it was in the glacial period, the result would be a lowering of the sea-level. The melting of the ice, on the other hand, would cause the sea-level to rise. The ice of the glacial period was of such quantity that its withdrawal, on the one hand, and its return, on the other, would have influenced the surface of the sea sensibly.

**Submarine volcanic extrusions.** Extrusions of lava beneath the sea likewise cause its surface to rise, as would also laccolithic and other intrusions beneath its bottom.

**Diastrophism.** While sedimentation and vulcanism have surely caused changes in the level of the sea, it is not believed that they have been the only causes which have produced such changes; neither is it believed that, in the long course of time, they have been the causes of the most profound changes.

The progressive cooling of the earth has resulted in its progressive shrinking since the time when it attained its growth and its maximum heat. This shrinking must have resulted in the deformation of its outer part, for the same reason that the skin of an apple wrinkles when its juice evaporates. As the cooling and contraction are constant, it appears that slow warpings of the crust may also be constant; but it appears also that the rigidity of the earth may be such that its outer parts are able to withstand for a time the strain set up by contraction. As the strain accumulates, it ultimately overcomes the resistance, and the outer part of the earth yields. If the yielding results in the sinking of the ocean basin, the surface of the water is drawn down, and the sur-

rounding lands seem to rise, unless they sink as much as the surface of the sea does at the same time. The lowering of the sea surface, because of the sinking of the sea bottom, is probably the most fundamental single cause of the apparent rise of land.

The periodic emergences of the continents, alternating with periodic submergences in the course of geological history, are perhaps to be thus explained. Periodic submergences, on the other hand, might be explained by the sinking of the continental segments of the earth, or by such sinking combined with the processes already referred to which cause the rise of the sea.

### *Why the Land Changes Level*

The reasons assigned for changes of level of the lithosphere beneath the sea have equal force when applied to the land. It is probable that the continents sink more in the course of ages than they rise, but that they sink less than the ocean basins. A local rise of the surface may result from a more general sinking. A depression of ocean basins, for example, may crowd up the continental area between, and the same principle may be applicable to smaller areas. Again, in volcanic regions, the intrusion of lava may cause the surface to rise, as over a laccolith, and the bringing of the hot-rock material near to the surface heats the surface rocks and perhaps expands them enough to cause sensible rise of the surface.

We are to conclude, therefore, that the apparent rise of the land along coasts is probably due in part to the sinking of the sea, in part to the lesser sinking of the coastal lands, as compared with the sea, and in part to the actual rise of the land itself.

### *Changes of Level in the Interiors of Continents*

**General facts.** Changes of level are perhaps as common in the interiors of continents as along coasts, though less easily detected. There are raised beaches about many lakes, as about the Great Lakes and Great Salt Lake (Fig. 361). Raised beaches about lakes result from the lowering of the level of the lakes, either by the cutting down of their outlets or by evaporation. They do not, therefore, indicate a rise of the land. In both cases cited, however, the old shore-lines should remain horizontal. But about many lakes the old shore-lines are not level, as they must have

been when formed. Some parts of one of the old shore-lines about Lake Bonneville (p. 314) are 300 feet higher than other parts formed at the same time. An old shore-line about the east end of Lake Ontario is more than 400 feet above the lake, while the same shore-line traced westward passes beneath the water at the west end of the lake. Similar phenomena are found about the shores of all the Great Lakes, though the departure from horizontality is not everywhere so great. Such deformed shore-lines show that the surface about the lake basins has warped since the old shore-lines were formed.

The former shore-lines of many smaller lakes and of some extinct lakes are also well known, and they tell the same story. This is notably the case with the shore-lines of the extinct Lake Agassiz (p. 282).

Changes of level are still in progress. The accurate observations and measurements of recent years have shown that the area of the Great Lakes is being tilted upward, relatively, to the northeast, and downward, relatively, to the southwest. The rate has been shown to be less than six inches per hundred miles per century.

**Extent.** So wide-spread are the evidences of changes of level that it may be said that, within regions so situated as to furnish evidence, more of the earth's surface has been sinking or rising in recent times, than has been standing still.

This general statement seems to point to great instability of the earth's crust, but it should be supplemented by the statement that these changes go on, as a rule, with extreme slowness and, in general, probably without violence. The amount of movement is, perhaps, to be reckoned in small fractions of an inch per year, more commonly than in larger terms. At times and places, however, it is probable the movements have been more rapid, but even in these cases it is not to be supposed that the movements were always violent.

The instability of the earth's exterior is believed to indicate that it is not in perfect adjustment to the interior, and that the continued lack of adjustment is the result of the continued shrinking of the earth as a whole.

**Ancient changes of level.** Old shore-lines and all features connected with ocean shores are destroyed in time by erosion; but the evidence of movements which took place so long ago that no traces of shore-lines remain, is firm. Thus layers of rock which

were once deposited as sediment (sand, mud, etc.) beneath the sea are now found over great areas, far above sea-level. Most of the solid rock beneath the Mississippi basin, for example, was deposited as sediment beneath the sea. The land has emerged, perhaps because the sea-level has been drawn down by the sinking of the sea basin. In the Appalachian Mountains, rocks similarly formed are found up to altitudes of a few thousand feet. In the Rocky Mountains they occur as high as 10,000 feet or even more. In the Andes Mountains they are found in limited areas up to 16,000 feet or more, and in the Himalaya Mountains at still greater heights. In these extreme cases, at least, it seems probable that there has been an actual rise of the crust, that is, that the outside has been bent up, or thrust up locally, so as to be farther from the centre of the earth than when in its former position.

**Future changes of level.** Not only have changes of level between land and sea been taking place for untold ages, but they are likely to continue. The wear of the land and the transfer of sediment to the sea tends to raise the sea-level, as already noted (p. 400). This tends to increase the area of the sea and to correspondingly diminish the area of the land. In the past there seem to have been occasional sinkings of the ocean basins, increasing their capacity and drawing down the level of the sea, thus causing the continents, as a whole, to appear to rise, and such changes are likely to occur in the future, so far as can now be seen. On the average, the lowering of the sea-level, due to the subsidence of its basins, has probably been greater than the rise of the sea-level, due to sedimentation from the land. The result is that as the continents have been brought low by wind and water and ice, they have been renewed, periodically, by the sinking of the sea.

In this general sequence of events appears to lie the explanation of the fact that though rain and river and ice erosion tend to bring the land to base-level, and though wave erosion tends to reduce it even below sea-level, the land is not destroyed, and is not even completely reduced to base-level.

As the great ocean-basin segments of the earth settle down, it seems possible that the smaller continental segments between may sometimes be wedged up, and perhaps warped and deformed at the same time. In this process may lie the explanation of many



mountains, plateaus, and plains, the physiographic features of the second order.

### *Crustal Deformation*

The foregoing discussion of changes of level has implied a measure of deformation of the outside of the solid part of the earth.



FIG. 426.—Open anticlinal fold, near Hancock, Md. (U. S. Geol. Surv.)

This deformation sometimes takes the form (1) of gentle *warping*, sometimes (2) of *folding*, and sometimes shows itself (3) in *faulting*.

**Warping and folding.** The warping may be gentle, resulting in slight arching or tilting of the beds of rock, or it may be so great that the arches grade into folds (Figs. 426 and 427). Most rock strata of the land are at least gently deformed, and folding is common in many mountain regions, and in some plains which were once high, but which have been brought low by erosion.

Warping and folding give rise to great topographic features, but in most mountains of folded rock, the present topography is the result of erosion rather than of the original folding. The structure of the rock resulting from the folding has, in many cases, determined or greatly influenced the topography which has resulted from erosion.

**Faulting.** At many times and in many places portions of the earth's surface have sunk or risen along a plane of fracture, as shown by Figs. 429 and 430. Such movements are *faults*. Fig. 428 represents a *normal* or *gravity* fault, and Fig. 429 a *reversed* or *thrust* fault. The former implies tension when it was made, and the adjustment takes place under the control of gravity. The latter implies lateral thrust, and the adjustment takes place under the control of such pressure.

Faults of both types are common, but reversed faults are



FIG. 427.—Closed anticlinal fold, near Levis Station, Quebec.  
(U. S. Geol. Surv.)

common only in regions where the rock strata have been folded. Fig. 429 suggests the relation between such a fault and a fold. A fold which is not faulted sometimes passes into a reversed or thrust fault. Normal faults may also grade into folds, especially *monoclinical folds* (Fig. 430). Faulted blocks of the earth's crust are sometimes tilted. They may be of such size and so displaced as to give rise to mountains, basins, etc. (Figs. 331 and 433). Normal faulting has taken place on a great scale in the plateau region of the West, between the Rocky Mountains and the Sierras, and many of the more striking topographic features of that region,

including numerous mountain ranges and lines of cliffs (Fig. 433), are the result of such movements. Cliffs or mountain slopes due to faulting are called *fault-scarps*. The steep slopes at the borders of the continental segments are probably fault-scarps in some



FIG. 428.—Diagram of a normal fault.

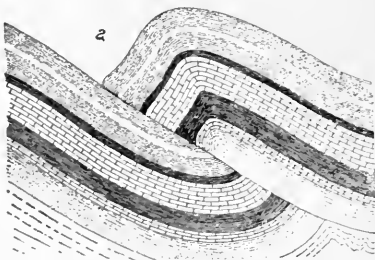

FIG. 429.—Diagram of a reversed or thrust fault. (U. S. Geol. Surv.)

cases (p. 13). Great faults are probably not developed by a single movement, but by repeated displacements along the same plane.

Though faults are common phenomena, only those of recent times now show themselves in the topography of the surface.

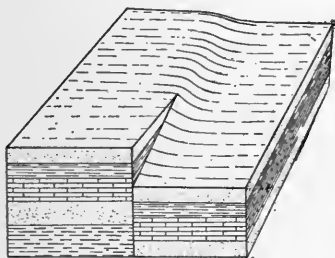

FIG. 430.—Fault passing into a monoclinal fold.

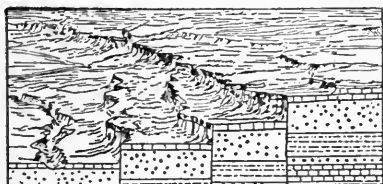

FIG. 431.—A branching fault. (Powell, U. S. Geol. Surv.)

Fault-scarps of earlier ages have been obliterated by erosion, though the faults still show themselves in the structure of the rock.

Faults have determined the positions of valleys in many cases, so that present topographic features are often closely associated with them, even though the fault-scarps have vanished.

*Earthquakes*

**Definition.** Earthquakes are tremors or quakings of the earth's surface, due to causes which cannot be referred to human agencies. The passing of a railway-train causes the surface near the track to vibrate, and this vibration is often enough to be felt in adjacent buildings. In this case, the cause is readily understood, and the shaking is not called an earthquake; but an equal

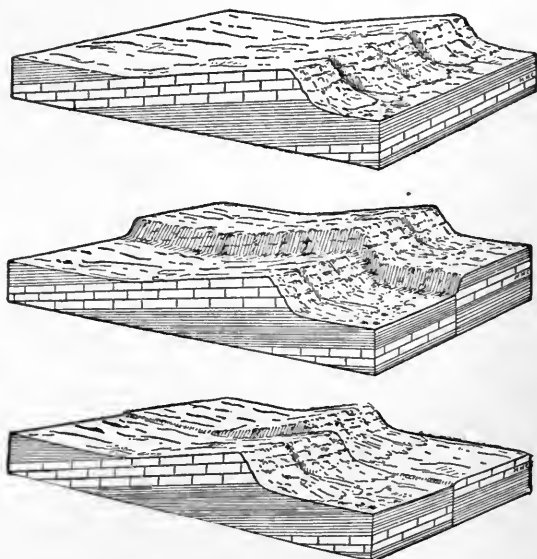

FIGS. 432-434.—Diagrams to illustrate the history of a fault-scarp. Fig. 432 shows an unfaulted block with a line of cliffs due to the superior hardness of one formation. Fig. 433 shows the same faulted, and with a pronounced fault-scarp. Fig. 434 shows the fault-scarp partly worn down. (Huntington and Goldthwait.)

amount of quaking, due to causes which were not known, would be called an earthquake, especially if felt over a considerable area.

**Strength and destructiveness.** Earthquakes vary much in strength. Some are so gentle that they can barely be felt; others are so violent that buildings are overthrown, crevasses opened in the surface of the land, and masses of rock loosened from cliffs and precipitated into the valleys below. Earthquakes sometimes disturb the waters of the seas, causing destructive sea waves.

Besides quakings which are sensible, there are many earth

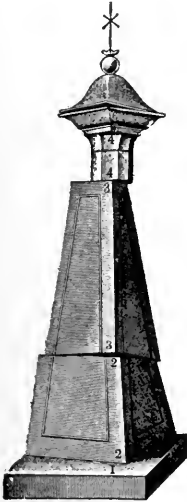

FIG. 435.—Monument disturbed by earthquake. (Falb.)



FIG. 436.—A chapel in Kasina injured in an earthquake of November 9, 1880. (Wähner.)

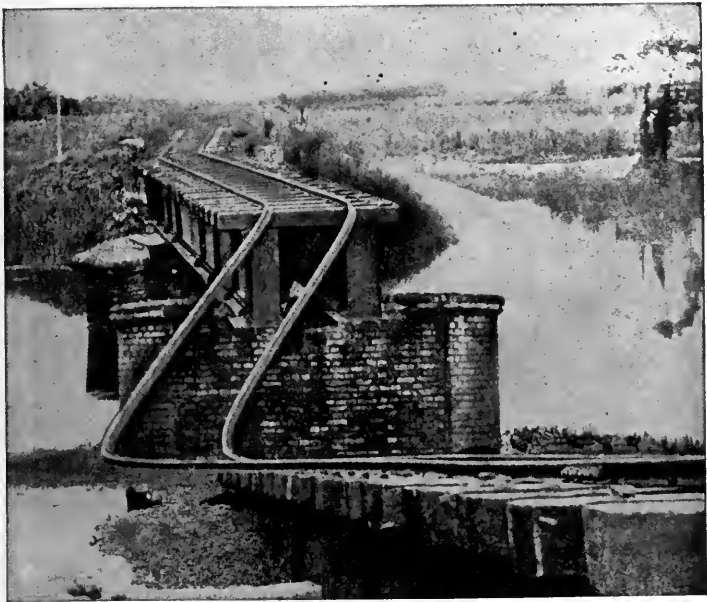

FIG. 437.—Horizontal and vertical displacement during an earthquake. Bengal-Assam earthquake of July 12, 1897. (From Dutton's Earthquakes, by permission of G. P. Putnam's Sons.)

tremors so slight as not to be felt. They are known only by means of delicate instruments set up for the purpose of recording all

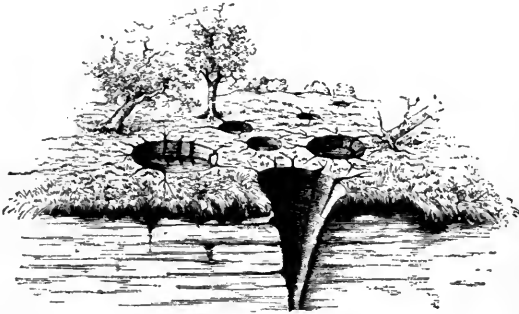

FIG. 438.—Craterlets observed after the Calabrian earthquake of 1783. (Sieberg.)

vibrations of the surface. The number of such tremors too slight to be generally noticed is much greater than the number of earthquakes strong enough to be felt.

Although violent earthquakes are sometimes very destructive



FIG. 439.—Great sea-wave on the coast of Ceylon. (Sieberg.)

to buildings and to life, the amount of movement of the surface is usually so slight as to be measured in millimetres (a millimetre is

about  $\frac{1}{2}$  of an inch) rather than in inches or feet. Bodies on the surface often move much more than the solid crust. The relation

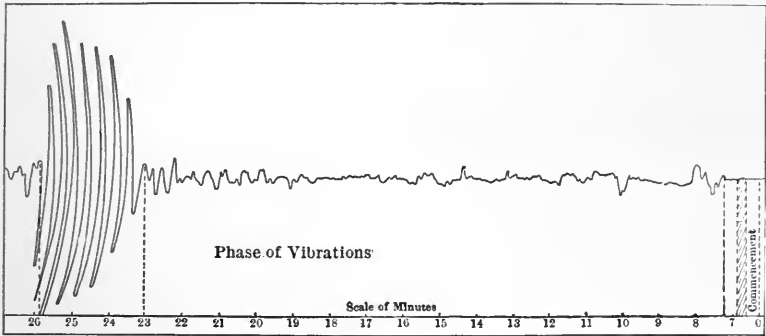

FIG. 440.—Seismograph of earthquake in Punjab, India, April 4, 1905, showing the actual amount of movement. (De Montessus de Ballore.)

is illustrated by the fact that a blow on the floor may cause a ball which rests upon it to bound up inches or even feet, though the floor itself moves but a small fraction of an inch.

While earthquakes are among the most disastrous and appal-



FIG. 441.—The bending of railway track in India, earthquake of 1897. (Oldham.)

ling of natural phenomena, so far as human affairs are concerned, those of historic times, at least, have left few important marks on

the surface of the earth. Their destructiveness to human life comes largely from the fall of buildings and from the "great sea waves" caused by the earthquakes. Destruction of life results from the advance of these waves upon a low coast which is densely populated. In the Lisbon earthquake of 1755 a wave 60 feet high swept upon the shore and destroyed some 60,000 human lives.



FIG. 442.—Fault in Japan, 1891. (Koto.)

Vessels in harbors have been swept in by waves and left high and dry above the water-level.

**Examples.** Some of the principal features of earthquakes may be brought out by the study of a few striking examples.

1. On October 28, 1891, an earthquake on the main island of Japan opened a fissure traceable for over 40 miles. The ground on one side of this fissure sank 2 to 20 feet (*a fault*) below that on the other. At the same time, the east wall of the fissure was pushed horizontally about 13 feet northward. In some places the cracking of the rock "showed itself at the surface as a cracked ridge, like the track of a mole just below the surface." Several tracts of land became lakes, one on the depressed side of the



fissure, the others in hollows formed by the shocks. Fig. 443 shows the distribution of earthquakes in Japan from 1883 to 1902.

2. On the evening of August 31, 1886, the city of Charleston, South Carolina, was disturbed by an earthquake which was felt over a large part of the United States. Strange noises and

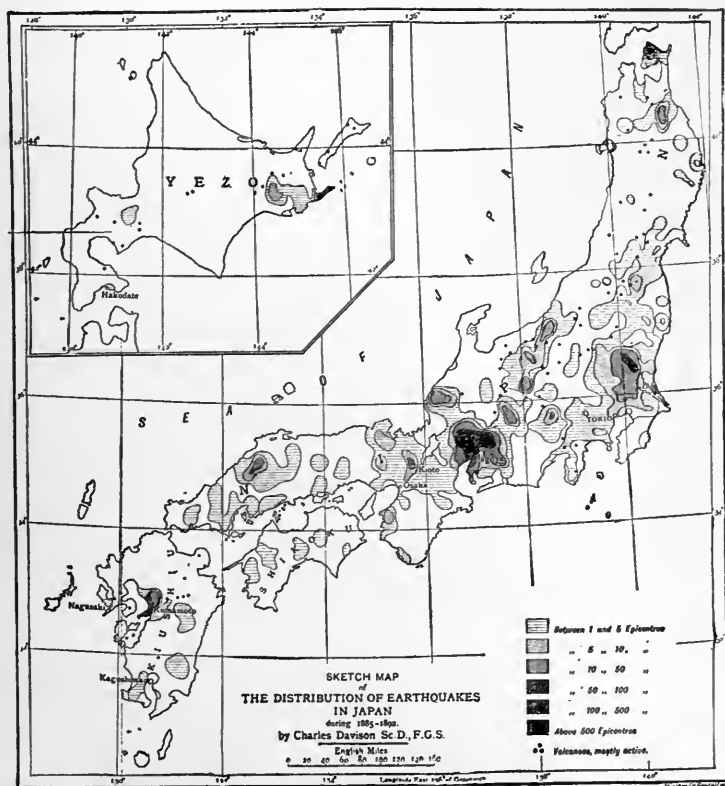

FIG. 443.—Distribution of earthquakes in Japan, 1885-1892. (Davison. From Dutton's Earthquakes, by permission of G. P. Putnam's Sons.)

slight tremblings of the earth had been noted for several days previous to the destructive quaking, but they excited no great alarm. About ten o'clock in the evening of the fateful day, a low rumbling sound was heard, which rapidly deepened into an awful roar. The slight trembling of the ground increased until it became destructively violent. The motion then subsided

slightly, but increased again in intensity and then died away. The violent disturbance lasted 70 seconds. A second shock, almost as severe as the first, occurred eight minutes later, and six or seven more or less severe ones were felt before morning, and slight tremors occurred at intervals until the following April. During the shocks, buildings swayed, chimneys were thrown down, walls

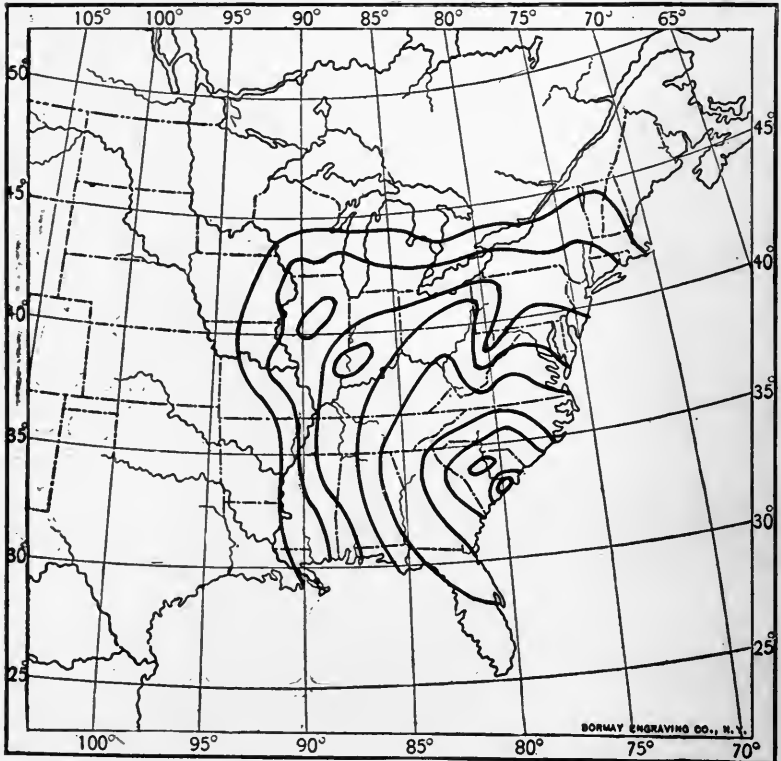

FIG. 444.—Isoseismal curves (that is, curves connecting points having the same amount of disturbance) of the Charleston earthquake. (Dutton, U. S. Geol. Surv.)

were cracked, houses moved from their foundations, railroad-tracks displaced sidewise and the rails bent, and trees disturbed in the ground. Numerous fissures were formed in the earth, and from some of them streams of water, mud, and sand were forced out. Hardly a large building in the entire city but was damaged, and 27 persons were killed, chiefly by falling masonry. The people

fled in terror from their homes, and for several days and nights a large part of the population camped in the public parks.

Outside the vicinity of Charleston the earthquake shock was less violent, but the quaking was felt over an area of between

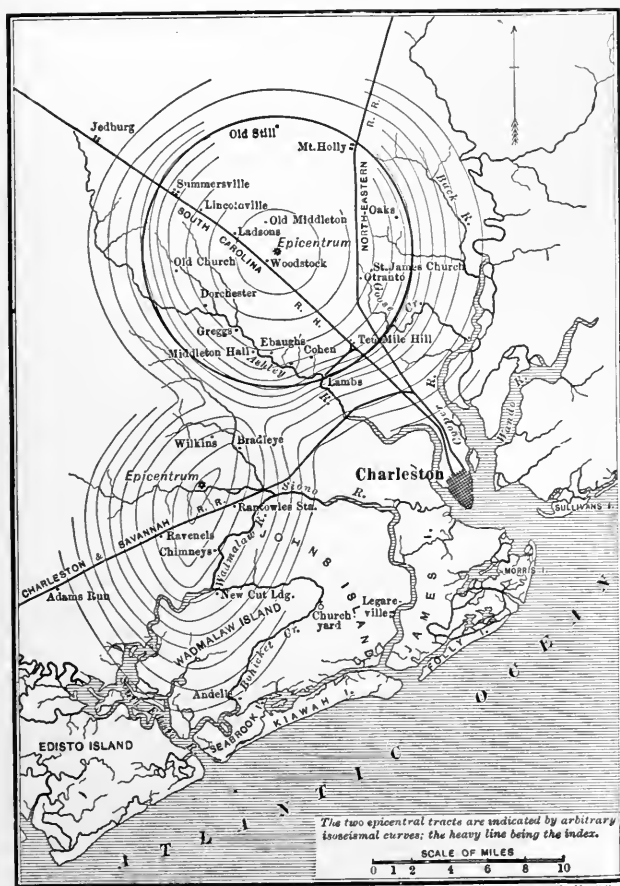

FIG. 445.—Epicentral tracts (*i.e.*, tracts over the centers of disturbance) of the Charleston earthquake, with isoseismal lines. (Dutton, U. S. Geol. Surv.)

2,000,000 and 3,000,000 square miles. It was felt earliest near Charleston, and later at increasing distances from the city (Fig. 444). There were two centers of disturbance (Fig. 445), and the earthquake wave spread at the rate of about 150 miles per minute.

There was no volcano near Charleston, and this earthquake appears to have been altogether independent of any volcanic eruption.

3. In 1822 and again in 1835 the coast of Chile was shaken by earthquakes for 1200 miles. In both years the shocks continued for several months. When they were over, it was found that the coast-lands had been elevated 2 to 4 feet.<sup>1</sup> In 1835 a volcano



FIG. 446.—Wreck of the Charleston earthquake. (U. S. Geol. Surv.)

broke out beneath the sea (San Fernandez Island)-at the time of the earthquake shocks on the coast, and many of the Andean volcanoes were active.

The same region was again shaken disastrously in August, 1906, causing great destruction of life and property in some of the principal cities of the country.

4. In 1819 a part of the delta of the Indus River experienced a series of shocks lasting four days. During the disturbance an area some 2000 square miles in extent subsided so as to be covered by the sea, while a neighboring belt, 50 miles long and 16 miles wide, rose about 10 feet.

5. The earthquake of Kangra, in the same country, April, 1905, affected an area of 1,625,000 square miles, and killed about 20,000 people. In this case, the vibrations spread from two centers, and

<sup>1</sup> This statement has been disputed, and the records which bear on the point seem to be less perfect than could be desired.

traveled at the rate of about two miles per second. The same region had been shaken in 1897.



FIG. 447.—A large craterlet formed during the Charleston earthquake. Hundreds of them were formed near Summerville, S. C. (U. S. Geol. Surv.)

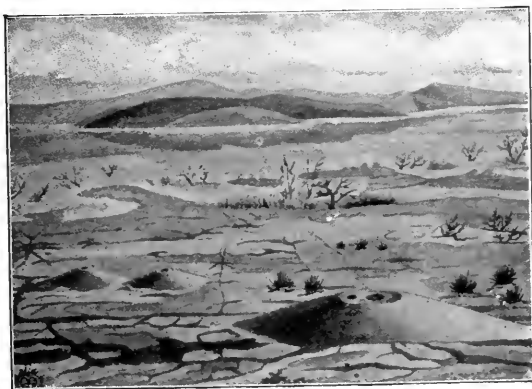

FIG. 448.—Sand-cones and craterlets observed after the Achäisichen earthquake of 1861. (Schmidt.)

6. A series of earthquake shocks, lasting from 1811 to 1813, affected the Mississippi Valley just below the mouth of the Ohio.

Many fissures were formed in the deposits of the flood plain of the Mississippi, and some of them remained open for years. Parts of the flood plain sank, and the sunken portions gave rise to marshes and lakes, some of which still remain. The trunks of the drowned trees are in some cases yet standing above the water of these lakes and marshes. The Orleans, the first steamboat built west of the

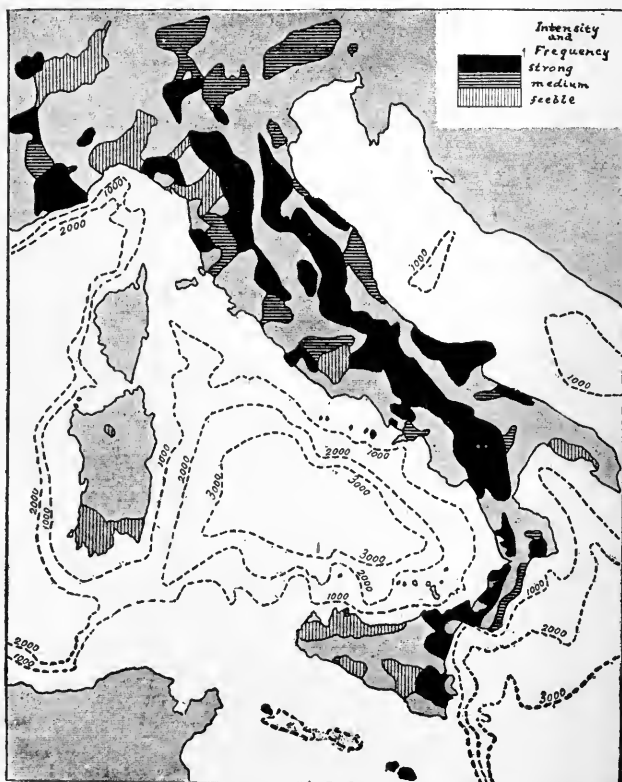

FIG. 449.—Map showing the intensity of earthquakes in Italy. (Baratta and Gerland.)

Appalachians, narrowly escaped destruction at New Madrid during this earthquake.

7. At about the same time, 1812, nearly 10,000 persons were killed in a violent earthquake which destroyed Caracas, Venezuela.

8. Earthquakes have been most destructive in southern Italy. Some 20,000 lives were lost here in 1688; 43,000 in 1693, and 32,000 in 1783; in all about 100,000 in a single century.

9. On April 18, 1906, there was a destructive earthquake on the coast of California, in and about San Francisco. Many buildings were injured by the earthquake and some practically destroyed, both in San Francisco and elsewhere. Fire broke out at various points in San Francisco after the shocks, and as the quaking had

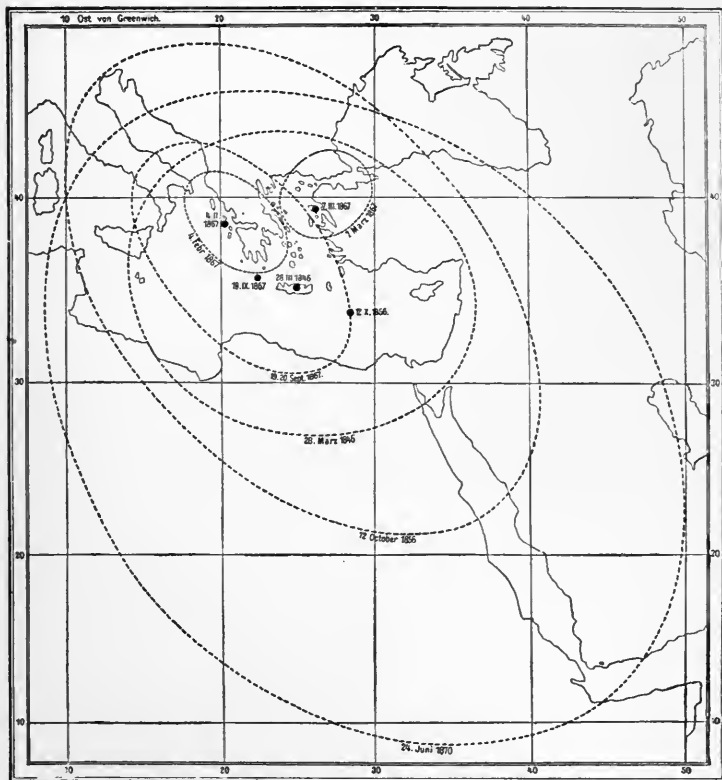

FIG. 450.—Chart of epicentra and outer limits of sensibility of the earthquakes of the eastern Mediterranean, from 1846 to 1870. (After J. Schmidt. From Dutton's Earthquakes, by permission of G. P. Putnam's Sons.)

cut off the city's supply of water, none was available for fighting the flames, and a large part of the city was burned. This earthquake, the most disastrous in North America in historic times, was caused by a horizontal fault of eight to twenty or more feet, which was promptly traced some 300 miles. Figs. 451 to 459 show some of the phenomena of this seismic disturbance.

**Earthquakes starting beneath the sea.** Earthquakes sometimes seem to start beneath the sea, and to spread thence to the land. The record of the accompanying changes beneath the sea is rarely distinct, but in a few cases some facts are known about them.

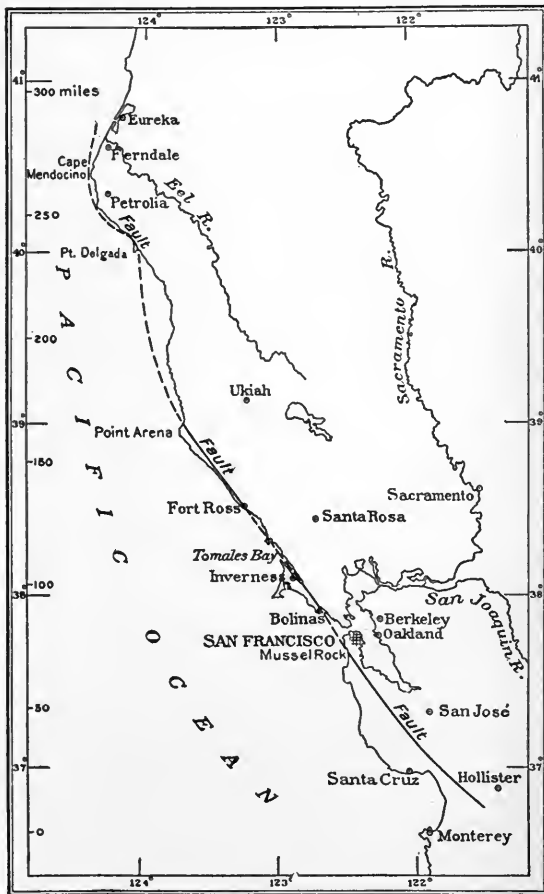

FIG. 451.—Map showing the position of the San Francisco earthquake fault. The line north of Point Arena is quite uncertain. (Gilbert.)

This is especially the case with reference to some of the earthquakes which have occurred about the coast of Greece, for, in a number of cases, cables have been broken, and soundings taken when they were repaired gave some indication of what had happened. In





FIG. 452 A.—An “earth flow,” or landslide, which occurred during the California earthquake, several miles west of the fault line east of Half Moon Bay. (Photo. by Dudley.)



FIG. 452 B.—Characteristic surface appearance of the fault line, south end of Tomales Bay, Cal. (Photo. by Newsom.)

one case, the soundings from the bow and the stern of the vessel which repaired the cable show differences of more than 1500 feet



FIG. 453.—Deformed railway, Seventh and Mission Streets, San Francisco. (Lindgren, U. S. Geol. Surv.)



FIG. 454.—A fissure on East Street, San Francisco, near the water front. "Made" ground. (Lindgren, U. S. Geol. Surv.)

in the depth of the water, *where the bottom had been nearly level when the cable was laid.*



FIG. 455.—The fault line two miles southeast of Portola, Cal. There was some vertical displacement at this point.



FIG. 456.—A broken (now mended) and offset fence. That in the foreground was formerly in line with the single length directly behind the man.

**The earthquake wave.** An earthquake usually spreads over the surface, somewhat as a water wave spreads from a center. Hence we have come to speak of the earthquake *wave*. The actual move-



FIG. 457.—A water-pipe buckled out of the ground by the earthquake. Alpine road, Portola Valley, Cal. (Photo. by Dudley.)



FIG. 458.—County Bridge, Pajaro River, Chittenden, Cal. (Photo. by Dudley.)

ment is a wave, but the wave is unlike that of water, though there are some points of similarity. The center of an earthquake wave may be a line, a belt, or a point, and in many cases it is not readily located.

Points distant from the center feel the earthquake shock later than those nearer to it. Lines drawn upon the surface connecting points where a given earthquake wave is felt at the same time are *coseismic* lines (Fig. 462). These lines are rarely circles, but they are usually closed curves, and are often irregular. Their irregularity appears to be due to the fact that the wave motion spreads faster in some directions than in others. This is another way of saying that the rocks in some parts of the earth's crust transmit the motion faster than others. If a circular metal plate were set



FIG. 459.—Tree uprooted by the earthquake. Searsville road, Cal.  
(Photo. by Dudley.)

vibrating at its center, the vibrations would spread from the center in all directions at about the same rate, and would reach the border of the plate at about the same time. But if the plate were made of sectors of different material, one sector being of steel, another of hard wood, and another of cork, the vibrations started at the center would pass outward through these sectors with different velocities, and would extend to different distances in a given time. The more porous and open the medium, the less the distance which the vibrations would travel before being completely deadened. The principle illustrated here has some application in earthquakes.



FIG. 460 A.—Track of electric railway, between South San Francisco and San Bruno Point. (Photo. by Moran.)



FIG. 460 B.—A street railway on loose ground. Union Street, near Pierce Street. (Photo. by Moran.)



A



B



C



D

FIG. 461.—Scenes on the Campus of the Leland Stanford University, after the earthquake of April, 1906.

A. The Agassiz statue. (Branner.)

B. The great arch. (Branner.)

C. The University Chapel. (Branner.)

D. The Library. (Branner.)

In general, the earthquake waves diminish in violence with increasing distance from the centers of disturbance (Fig. 463).

**Frequency.** Earthquakes are of very common occurrence, though fortunately those which are violent enough to be destruc-

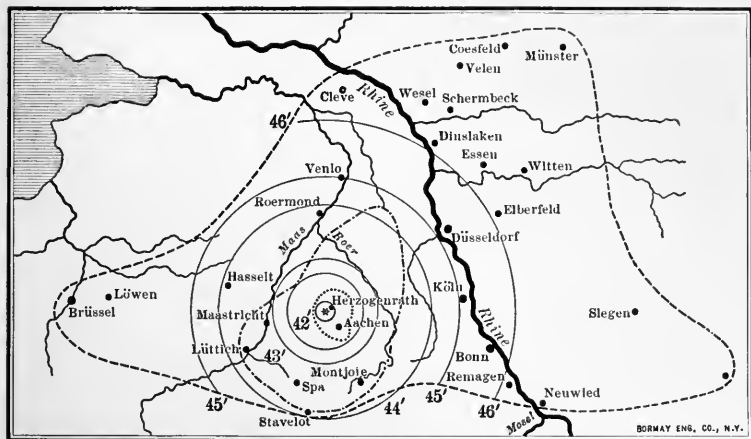

FIG. 462.—Coseismic lines for each minute, Herzogenrath (Germany), earthquake of October 22, 1873. (Lasaulx.)

tive are rare. From 1889 to 1899 an average of 36 per year were recorded in California alone, but most of them were so slight as to cause no destruction. In Japan, earthquakes have been recorded at the rate of several per day for many years, but this includes

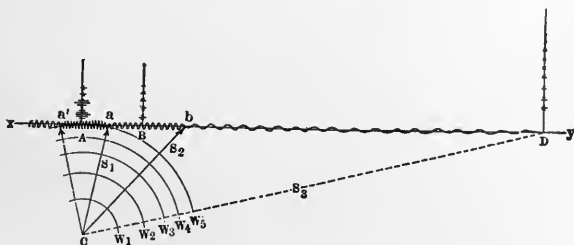

FIG. 463.—Diagram illustrating the dimensions and intensity of vibration with increasing distance from the epicentrum. (Belax.)

many very trivial quakings, and only a few of sufficient violence to be destructive.

The Isthmus of Panama and its surroundings have been under careful observation with reference to earthquakes for a few years,

because the frequency and violence of earthquakes had a bearing on the site which was to be selected for the canal which was to join the Atlantic and Pacific. In 40 months, between January, 1901, and April, 1904, 169 earthquakes were recorded at San José, near the eastern end of the proposed Nicaraguan route. Of



FIG. 464.—Map showing in black the principal earthquake regions of the Old World. (Montessus de Ballore.)

these, 43 were mere tremors, 91 slight shocks, and 35 strong shocks. During the same period, 6 tremors and 4 slight shocks were recorded at Panama.

The slight tremors would probably not have been known but for the observatories, many of which have been established in recent times, where all earth-tremors, however slight, are recorded by delicate instruments (seismographs) devised for this purpose.



In view of the records at the stations in various parts of the civilized world where such apparatus has been set up, it has been said that *some part of the earth's surface is probably shaking all the time.*

**Distribution.** Earthquakes are perhaps most common in volcanic regions, though not confined to them. It can hardly be



FIG. 465.—Map showing the principal earthquake regions of the New World. (Montessus de Ballore.)

said that all such earthquakes are caused by volcanoes, since many of them do not occur at the time of volcanic eruptions. It is perhaps better to regard earthquakes and volcanoes as the result of a common cause, rather than to regard one of them as the general cause of the other.

Many great earthquakes have occurred near the edges of the continental platforms. Mountain regions in general seem to be more

subject to earthquakes than plains, though earthquakes originating in mountain regions sometimes spread to plains. Earthquakes, on the other hand, do not always start in mountain regions. As in the case of the Charleston earthquake, they sometimes originate beneath plains.

**Causes of earthquakes.** Earthquakes are probably due to various causes. Small ones are perhaps sometimes due to the falling in of the roofs of underground caves. If the roof of Mammoth Cave, for example, were to fall in, the disturbance would cause an earthquake of small extent. Earthquakes accompany violent volcanic eruptions, and in these cases the explosions which cause the eruption are doubtless also the cause of the earthquakes. Great landslides and avalanches are the causes of some minor earthquakes, and it is probable that slumping on the slopes of deltas and on the outer faces of the continental shelves produces similar results.

Many great earthquakes appear to be connected with other forms of crustal movement. As already noted, fissures are sometimes opened in the surface of the land during an earthquake. This is best seen where there is little or no soil, and where the solid rock lies close to the surface. There is a great crack of this sort in Arizona (Fig. 467), and similar fissures have been formed in New Zealand, Japan, and elsewhere during earthquakes. It is not always clear whether the fissure should be looked on as the cause or the result of the earthquake. In some cases it is found that one side of such a fissure is higher than the other after the earthquake, indicating that the rock on one side was raised or that on the other sunk, or both—in other words, that the strata have been *faulted*. *Faulting* is probably the principal cause of earthquakes, for the slipping of one great body of rock past another would cause vibrations which would spread far from the center of disturbance.

There is sometimes horizontal as well as vertical displacement along the cracks, as already noted, and the horizontal thrust or fault is sometimes the principal one, as in the recent earthquake of California. Horizontal displacement shows itself in the distortion or breaking of lines which were straight or continuous before the faulting. Thus fences or rows of trees which were straight before an earthquake may be bent or broken and offset at the fissure. The force which causes this displacement is the real cause of the earthquake.

Again, great thicknesses of rock strata are sometimes found folded and crumpled. The process of mountain folding has never been seen, and it is probably much too slow to be seen from day to day or from year to year. But there can be no doubt that

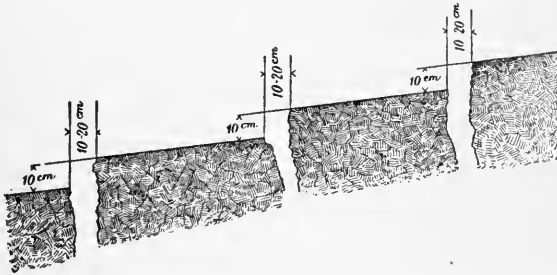

FIG. 466.—Faulting accompanying the Sinjan earthquake of 1898. (Faidiga.)

beds now folded so as to stand on edge were once horizontal or nearly so. No series of horizontal beds can be folded, as many beds have been, without more or less slipping of layer on layer. The amount of slipping at any one time may be slight, but it



FIG. 467.—Fissure produced by earthquake. Arizona.

must be real. This, too, is probably a cause of earthquakes, and of earth-tremors which are not sensible.

It is probable that most earthquakes are to be looked upon as but one expression of the wide-spread movements to which

the crust of the earth is subject, movements which are due primarily to the continued adjustment of the outside of the earth to a shrinking interior. In general, these movements are too slow to produce sensible vibrations; but locally and periodically they are sufficient to cause distinct quakings.

**Surface changes caused by earthquakes.** The changes in the surface of the land made by earthquakes are numerous if not important. In addition to the cracks and fissures, and the risings and sinkings of surface which have been noted, drainage is often disturbed. This is partly because of the cracks and fissures which are opened, and partly for other reasons. If an open fissure is developed athwart the course of a stream, the stream will plunge into it. Springs are often disturbed, old ones ceasing to flow and new ones appearing. This is probably because the earthquake movement has ruptured the rock beneath the surface, and so changed the course of the ground-water circulation. Temporary spouting springs are sometimes formed, water being forced up violently through them (p. 414). Earthquakes sometimes cause landslides, and if the material from a mountain-side slides down, it may dam the valley below so as to disturb its drainage (p. 313).

From fissures and from lesser vents noxious gases sometimes issue. In some cases, too, loose sand is thrust up into cracks from beneath during earthquakes.

Earthquake waves have a singularly destructive effect upon aquatic life. It has been recorded in many cases that the animals of rivers, bays, and even of the ocean are killed in extraordinary numbers during an earthquake.

#### MAP EXERCISES

Study the following maps in preparation for the conference:

A. Choptank, Md.

Tolchester, Md.

Boothbay, Me.

Coos Bay, Ore.

Oceanside, Cal.

Honey Lake, Cal.

Erie, Pa.

Fairview, Pa.

B. U. S. Coast and Geodetic Survey charts, 10, 124, 125, 188, 210, 5100, 5500.

## C. Mt. Trumbull, Ariz.

Echo Cliffs, Ariz.

Diamond Creek, Ariz.

Coast Survey Chart, 5100.

It is to be borne in mind that the relative change of water and land levels along the shores of lakes may be due to the lowering of the lake by the cutting down of its outlet, and not to diastrophism at all. The topographic features which give evidence of the lowering of a lake-level are, however, the same in kind as those which arise from the uplift of the shore-land or from the sinking of the sea-level.

D. Study the maps of group A for evidences of change of relative level of land and water. Answer in writing the questions marked \*. In the case of each map and chart,

1. Is submergence, emergence, or warping (part up and part down) of the land in recent times indicated by the map? Reasons.

2.\* Specify three well-defined cases of coast-land (or shore-land) emergence suggested by the topographic maps, with reasons therefor.

3.\* Specify three cases of coast-land (or shore-land) submergence suggested by the topographic maps, with reasons therefor.

4. What factors besides diastrophism have probably been operative in shaping the coast in the Boothbay region? In the Alaskan region? Distinguish, if possible, between the features due to diastrophism and those due to other causes.

5.\* Make an interpretation of the topography of the coastal part of the Oceanside Sheet, indicating the degree of confidence with which your conclusions are held.

E. Study the charts of group B for evidences of submergence and emergence of coastal lands. Evidences of submergence are to be found largely in the configuration of the submerged surface. Evidences of emergence are much the same as on the contour maps. Note the unit (feet, fathoms) in which soundings are given, in the case of each chart.

1. Note cases of well-defined apparent submergence of former lands, as indicated by the configuration of the bottom (see p. 397).

2. Note cases of well-defined apparent emergence shown on these charts (see p. 394).

3. What are the possible explanations of the larger features of the coast-line shown on Chart 5500?

F. In group C, the *Hurricane Ledge* of the Mt. Trumbull Sheet, the *Echo Cliffs* of the Sheet of the same name, the *Grand Wash Cliffs* of the Diamond Creek Sheet, and the steep cliff southwest of Honey Lake, on the Honey Lake Sheet, are fault-scarps now somewhat eroded. This could, however, not be certainly known from the topographic map.

The steep cliffs on the northeastern coast of San Clemente Island, Chart 5100, also represent an old fault-scarp.

## REFERENCES

1. Standard text-books on Geology, under *Changes of Level, Secular Changes of Level, Crustal Movements, Earthquakes*, etc.
2. MILNE, *Earthquakes*: Appleton, and *Movements of the Earth's Crust*: Geog. Jour., Vol. VII, 1896, pp. 229-250.
3. DUTTON, *Earthquakes*: Putnam.
4. HOBBS, *Earthquakes*: Appleton.
5. DUTTON, *The Charleston Earthquake*. 9th Ann. Rept. U. S. Geol. Surv.
6. GILBERT, *A Theory of Earthquakes of the Great Basin, with a Practical Application*: Am. Jour. Sci., Vol. XXVII, 1884, pp. 49-53.
7. GILBERT: Pop. Sci. Mo., Vol. LXIX, 1906, p. 97.
8. JORDAN: Pop. Sci. Mo., Vol. LXIX, 1906, p. 289.
9. SHALER: Chapter in *Aspects of the Earth* (Scribners).
10. MCGEE, *The Gulf of Mexico as a Measure of Isostasy*. Am. Jour. Sci., Vol. XLIV, 1892, pp. 177-192.
11. SHEPARD, *New Madrid Earthquake*: Jour. Geol., Vol. XIII, pp. 45-56.
12. LE CONTE, *Earth Crust Movements and their Causes*: Science, Vol. V, 1897, pp. 321-330.

Many of the references under Volcanoes (p. 390) also touch upon earthquakes.

## CHAPTER IX

### ORIGIN AND HISTORY OF PHYSIOGRAPHIC FEATURES

WE may now review the principal physiographic types in the light of the knowledge afforded by the preceding study of physiographic processes.

#### *Plains*

Plains, considered as one of the three great divisions of land surfaces, have arisen in various ways, as already noted. In many cases their materials show that they were once below sea-level. From this position they were (1) *bowed up*, (2) *faulted up*, (3) or *built up* so as to emerge from the water; or (4) the *sea-level* may have been *drawn down* so as to leave them dry. Plains have arisen also (5) by the *degradation of plateaus or mountains*. In many cases, two or more of these processes have operated jointly in the development of plains.

After plains have come into existence they are modified by gradation, generally by stream erosion and often by glacier erosion; by diastrophism, which may deform them; or by vulcanism, which may build them up by lava-flows or diversify them by the development of volcanic cones.

All existing plains of great extent have been modified in some or all these ways. Thus the Coastal Plain of the Eastern United States, developed by aggradation and diastrophism, has been much changed by erosion, and perhaps somewhat by warping, since its origin. The great Interior plain of the United States has been much modified by rain and river erosion, and at the North by glaciation. These processes have led to the development of many minor features, as already indicated. Valleys have been made by running water, and ridges and hills left in the process. Mounds, hills, and ridges, with associated kettle-like, saucer-like, trough-

like, and irregular depressions, have been made by the continental glaciers. Many of these depressions have become the sites of lakes,



FIG. 468.—A semi-arid plain, with sinks and one water-hole, in the western part of the United States. (U. S. Geol. Surv.)

ponds, and marshes. Lands thus modified are sometimes called *glacial plains*. In the bottoms of the larger valleys, *river plains*



FIG. 469.—Arid plain, western United States. A mesa or plateau at the right. (U. S. Geol. Surv.)

have been developed, and about many lakes whose basins have been partly filled, or whose levels have been drawn down by the



lowering of their outlets, *lacustrine plains* have been developed. Similar flats occupy the sites of many former lakes which have become extinct.

In addition to the changes produced by gradation, the Interior Plain has probably been somewhat changed by unobtrusive expressions of diastrophism.

Various plains in the West have been modified by the ejection of volcanic matter, as well as by gradation and diastrophism, and most plains have been affected to some extent by the wind.

### Plateaus

Plateaus may originate through the operation of some of the processes which give rise to plains (Chap. 1). *Sufficient* up-warping or up-wedging of the sort which gives rise to plains would give rise to plateaus. So also would sufficient up-building, especially perhaps by lava-flows. It may be doubted whether the sea-level was ever lowered enough at one time to convert coastal plains into plateaus, and plateaus are not made by the degradation of higher lands.

After they come into existence, plateaus are modified by all the processes which modify plains. All existing plateaus have felt the effect of some of these processes, and most of them of several.

### MOUNTAINS

Some study has already been made of mountains as topographic features, but some points concerning them could not well be considered until the processes of vulcanism

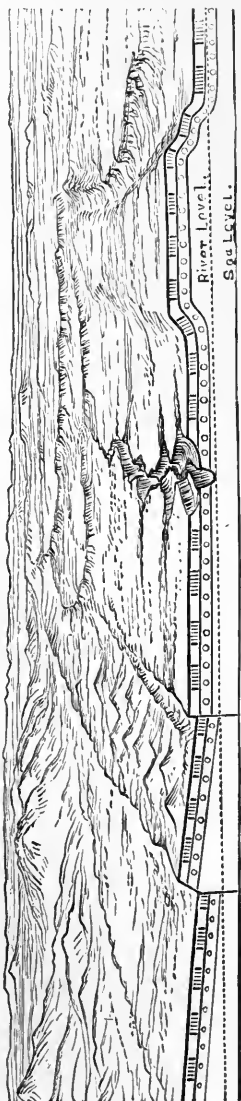

FIG. 470.—Bird's-eye view of Colorado Plateau. (Powell.)

and diastrophism had been outlined. We have now to see what various forms mountains assume, how they are grouped, what their structure is, and what purposes they serve in the economy of nature.

Mountains have been defined as masses of land high enough to be very conspicuous in their surroundings, but without a great expanse of surface at the top. It is to be understood, however, that between large-topped mountains and small plateaus there are all gradations.

Those who have never seen mountains, but who have seen hills and ridges, may perhaps best get their conceptions of mountains

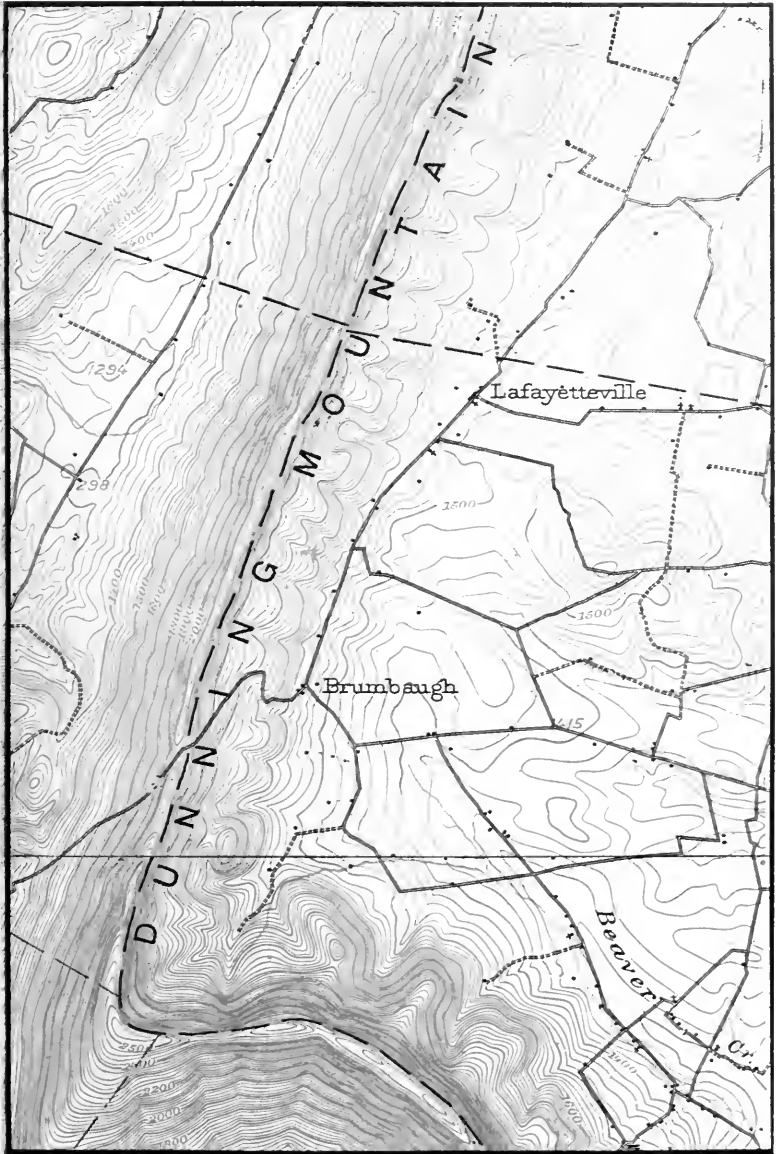

FIG. 471.—Dome-shaped mountain in the Uinta Mountains. (Church.)

by thinking of them as hills and ridges which, in their surroundings, appear to be very high. They may be but a few hundred feet above their environs, or they may be many thousand feet, and, as in the cases of hills and low ridges, their slopes may be steep or gentle.

A *single mountain* may be but a big hill (Fig. 471 and Pl. XXIV). But, as already stated, there are all gradations between a big hill and a little mountain, and whether an isolated elevation is called a hill or a mountain depends on its surroundings, or on the judgment of those who named it. A single mountain may stand in the same relation to a mountain region that a single hill does to a hilly region.

A mountain may be a high ridge rather than a high hill (Pl. XXV). A *mountain ridge* is often called a *mountain range*. A



Dunning Mountain, Pennsylvania; a good example of a mountain ridge due to the superior hardness (resistance) of a tilted layer of rock, the outcrop of which was left as a ridge after the less resistant surroundings were worn away. Scale 1 - mile per inch. (Everett Sheet, U. S. Geol. Surv.)

PLATE XXVI

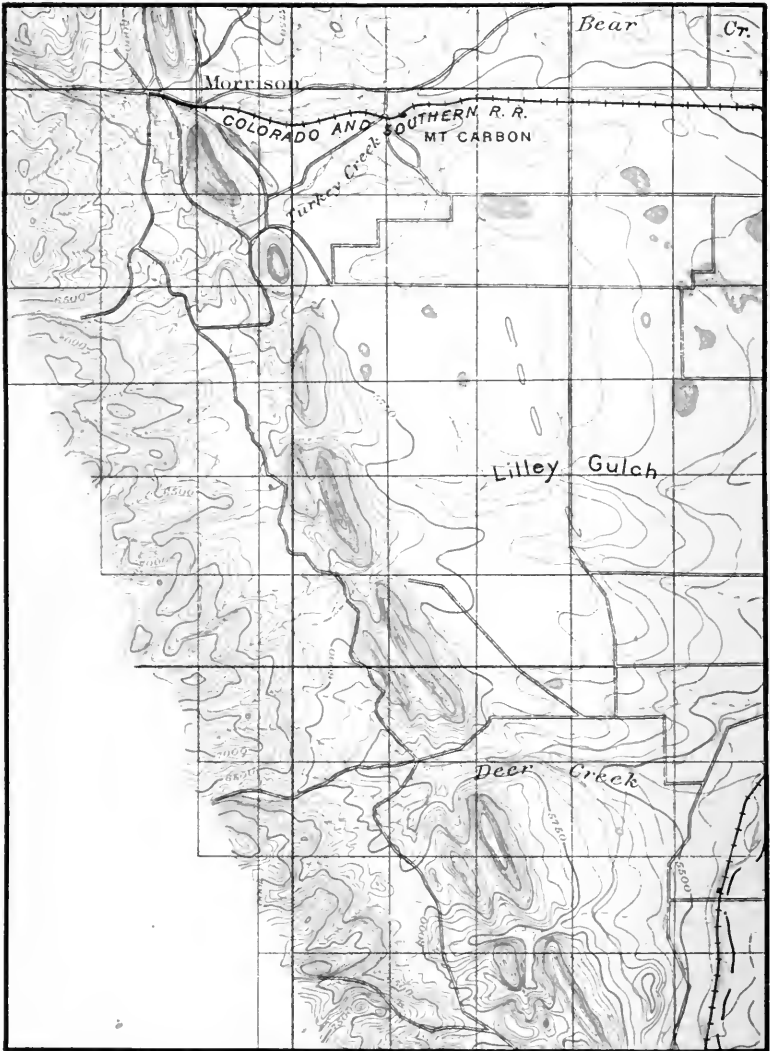

An area southwest of Denver, showing a mountain ridge dissected by erosion. The outcropping hard layer appears in the form of a series of short ridges, or "hog-backs." (Compare Pl. XXV.) Scale 2 - miles per inch. (Denver, Colo., Sheet, U. S. Geol. Surv.)

mountain range may have a nearly even crest (Pl. XXV), or its crest may be a series of high points partially separated from one another by depressions (Pl. XXVI). A mountain range or ridge may have

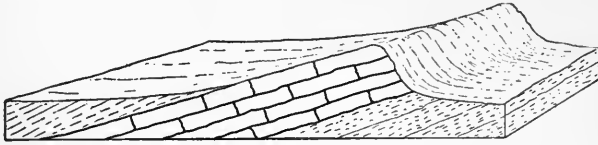

FIG. 472.—An asymmetrical mountain ridge.

its opposite slopes much alike, or they may be very unequal (Fig. 472).

A *mountain group* is made up of several or many mountain peaks, or of short mountain ridges. The Catskill Mountains (Fig. 473) and the Black Hills may serve as examples.

A *mountain chain* or *system* is an elongate mountain group, made up of many single mountains or of mountain ranges, or of both. The individual ridges commonly have a pronounced trend in a common direction. The Appalachian Mountain system is an example (Fig. 23, p. 29). A few mountain systems, like the Alps, are not conspicuously longer in one direction than in another. The more conspicuous elevations of a system have separate names, and are individually mountains.

**Distribution of mountains.** In some of the continents the more important mountains are toward the borders of the land rather than in the interiors. It is to be noted, however, that even in some of the continents where this is true, the mountains are not all near the coast. In the western part of North America, for example, some of the highest ranges are nearly 1000 miles from the Pacific, while portions of the eastern mountains are some 400 miles from the Atlantic. In the narrow part of the continent at the south, nearly all the land is mountainous.

In South America the high mountains (the Andes) are confined to a belt rarely exceeding 300 miles in width near the coast, while some of the lower mountains to the east are farther from the sea.

In Africa, the highest mountains are near the southeastern border of the continent. Mountains also occur on the northwest border and at some other points; but, on the whole, it can hardly

be said that mountainous borders are especially characteristic of this continent. In Australia, also, the more important mountains are near the coast, though most of the coasts are not mountainous.

The mountains of Europe and Asia, taken as a whole, can



FIG. 473.—Photograph of a model of the Catskill Mountains. (Howell.)

hardly be said to be near the oceans, though some of them have such positions.

**Heights.** Mountains range in height from large hills or ridges but a few hundred feet high, to elevations of nearly 30,000 feet. The highest mountains in the United States, outside of Alaska,

are found in the Sierra Nevada range of California, where the highest peak (Mt. Whitney) reaches an elevation of nearly 15,000 feet. The highest mountains of the Rockies are but little lower, many peaks exceeding 14,000 feet in elevation. In Colorado alone there are about 40 peaks reaching an elevation of between 14,000



FIG. 474.—A mountain valley. The narrow part of the canyon shown here is to be the site of a dam 310 feet high, for a reservoir for irrigation purposes. (U. S. Geol. Surv.)

and 14,500 feet. Mt. Rainier in Washington also reaches an elevation of a little more than 14,000 feet. The highest mountain in Alaska, Mt. McKinley, has an altitude of 20,300 feet.

The highest points in the Andes Mountains attain an elevation of about 23,000 feet, and many peaks rise above 20,000 feet.

The highest peaks of the highest mountains of Europe, the Alps,

attain an elevation of nearly 16,000 feet, and the highest peaks in the Caucasus are but little less. In the Himalayas, the loftiest mountains of Asia and of the earth, the highest peak, Mt. Everest, is nearly 30,000 feet above sea-level.

The mountains of Africa and Australia are, for the most part, much lower. A few volcanic peaks in the former attain an eleva-



FIG. 475.—King's River Valley, Cal. (U. S. Geol. Surv.)

tion of nearly 20,000 feet, while the greatest elevation of Australia falls short of 8000 feet.

**Oceanic mountains.** Mountains exist in the ocean basins as well as on the continental platforms. Many oceanic mountains are partly or wholly beneath the water, but the crests of some of them are not.

If the height of a mountain be reckoned in terms of elevation above its base, rather than in terms of elevation above sea-level, some of the volcanic cones of the ocean would rank among the highest mountains of the earth. Thus Mauna (Mount) Kea (Fig.



392), on the island of Hawaii, rises nearly 14,000 feet above the sea. Measured from the ocean floor, from which the island rises, its height is more than 30,000 feet. It is, in one sense, nearly or quite the highest mountain of the earth, though not the highest above sea-level. Parts of the Antillean mountain system (including the West Indies and the mountains of Central America, etc.) also rise from a depth of 16,000 to 18,000 feet below sea-level to a maximum height of more than 10,000 feet above. They are therefore among the greatest mountains of the earth, if their elevation be reckoned from their real base.

**Changes taking place in mountains.** Most of the processes of degradation already studied are in operation in mountain regions, but their relative importance is not the same as in lower lands. The differences are due partly to the steepness of the mountain slopes, and partly to the differences of climate incident to altitude.

Because of their steep slopes, erosion by mechanical processes is more rapid in mountains than on plains. Streams in mountains are, as a rule, rapid, at least in the early stages of an erosion cycle, and make deep valleys. Chiefly for this reason, mountains are the roughest portions of the earth's surface. Rapid erosion means that weathered rock is promptly removed. The accumulation of mantle rock is therefore less in mountains than where erosion is less rapid, and bare rock is, accordingly, more common.

The temperature decreases on the average about  $1^{\circ}$  Fahr. for every 300 feet of rise. If a mountain is 3000 feet higher than its surroundings, the temperature at the top is therefore some  $10^{\circ}$  colder than at the bottom. Because of their low temperature, high mountains have little vegetation. The absence of vegetation allows running water and wind to remove weathered rock readily. When a mountain is so cold as not to allow the growth of vegetation, the absence of the plants, together with the steepness of slopes characteristic of mountains, leaves the bare rock freely exposed to all the processes of weathering. Daily changes of rock temperature are great in high altitudes, especially on sunny days, and rock breaking, due to this cause, is most effective. The steep slopes allow the rock-masses broken off in this way to fall or to be carried down readily (Fig. 476), thus exposing fresh surfaces of rock to the same changes.

In general, there is more precipitation (rain and snow) in moun-

tains than on plains, and more of it falls as snow. The snow accumulates through a considerable part of the year, to be melted at a later time. When it melts, the water runs off and has much the effect of concentrated rainfall. If it accumulates in sufficient quantity, it will give rise to glaciers, which, except in very high latitudes, do not occur outside of mountain regions. On the



FIG. 476.—Quartzite Peak, Wasatch Mountains, with quantities of talus at its base. (Chamberlin.)

whole, therefore, erosion is more rapid in mountains than elsewhere.

The deposition of sediment, on the other hand, is relatively less in mountains than on plains, because of the steep slopes and the swift streams. Much of the debris which falls or is carried down steep slopes is however temporarily lodged at their bases (p. 182).

Winds are often strong in mountain regions, though they pro-

duce relatively little direct effect on the land, (1) because it is less commonly dry, and (2) because there is little material fine enough to be blown.

The winds in the mountains have a notable effect on the char-



FIG. 477.—A mountain tree. Near Granite, Colo. (Capps.)

acter of the trees (Fig. 477), especially where they are scattered, or near the upper limit of their growth (*the timber line*).

### *Origin of Mountains*

**Volcanic mountains.**—Mountains originate in very different ways. Figs. 362 and 364 show isolated mountains of volcanic origin. Single mountains having this structure are among the high mountains of the earth. Besides Shasta, Rainier, and others already mentioned (pp. 378–84), the Spanish Peaks of Colorado (13,620 feet) and Mt. Wrangell of Alaska (17,500 feet) belong to this class. So, also, do Orizaba (18,200 feet) and Popocatepetl (17,523 feet) of Mexico; Tajumulco (18,317 feet) and others of Central America; Aconcagua (22,860 feet), Chimborazo (21,498 feet), and numerous others in the Andes; Elbruz (18,470 feet), Demavend (18,000 feet), Great Ararat (nearly 17,000 feet), Fuji-yama (12,365 feet), and others in Asia; and Kilimanjaro (19,780 feet) and Kenia (18,000 feet) in Africa. The highest mountains of Africa and South America are volcanic.

The origin of many other mountains is also clearly suggested by their structure.

**Mountains produced by erosion.** One type of mountain structure is represented by Figs. 478 and 479. Mountains of this sort

may occur singly, but they are often in groups. They are clearly the result of erosion, their surroundings having been worn away.



FIG. 478.—Mountains of horizontal strata, Timpanogas Mountain, Utah. (Church.)

Mountains of this sort are developed from plateaus in the course of their degradation. The Catskill Mountains are an illustration. Other illustrations occur in the arid regions of the West, where the isolated masses of rock are often called buttes (Fig. 173).

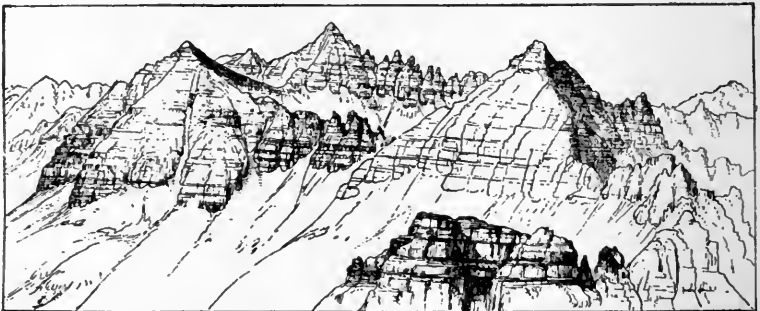

FIG. 479.—Mountains shaped by the erosion of horizontal beds of stratified rock. Castle Group, Colo. (Holmes, Hayden Surv.)

Other illustrations of mountains, the outlines of which were produced by erosion, are shown in Figs. 479 and 480.

**Intrusion and uplift.** Fig. 37 (p. 39) represents another common type of mountain structure. Mountains of this type may constitute single mountains or groups of mountains. They may be large or small. In most cases the bedded rocks which lie on the

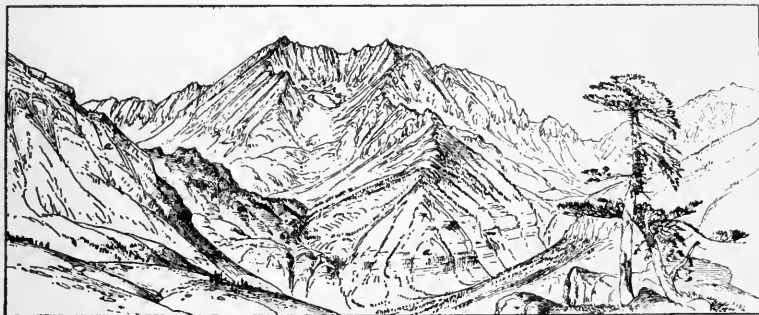

FIG. 480.—Mountains shaped by erosion, where the rock is massive. Elk Mountains, Colo. (Holmes, Hayden Surv.)

sides once extended over the crests, and have been cut away by erosion. The Black Hills and the Adirondacks are examples of large groups of mountains of this type. Numerous small ones occur about the Black Hills and at many other points in the West. The Henry Mountains of Utah (Figs. 402 and 404), made classical by the exhaustive study of Gilbert, are a well-known illustration of this general type.

Mountains of this type of structure may be linear, making a mountain range or system rather than a mountain group. The Sierra Nevada Mountains of California are an example.

**Mountains produced by folding.** Fig. 481 represents still another type of mountain structure illustrated by the Jura Mountains, while Figs. 482 and 483 represent variations of the type.



FIG. 481.—Section of the western Jura Mountains.

The Jura Mountains as they now are, are the result of the upswelling (without renewed folding) of a worn-down mountain system produced originally by folding. In other words, the folded structure of the former mountains has been lifted up bodily in recent times. The details of the present mountains are the result of erosion on this upwarped structure.

It is to be noted that the present topography of mountains whose component strata are folded was not always produced by folding. It was indeed rarely produced in this way. The

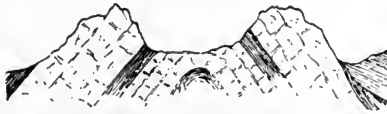

FIG. 482.—Section across the Shortenkopf, Bavarian Alps. (Frass.)

folding doubtless gave rise to ridges, sometimes to ridges of great height, as in the case of the Appalachians. The mountains thus produced were then brought low by

erosion. Later, the planed-down region of folded rocks was bowed up, relative to its surroundings, but bowed up as a unit, without further folding. The present mountain crests are the outcrops of the harder layers, isolated by erosion subsequent to this later



FIG. 483.—Appalachian structure. (Rogers.)

uplift (Figs. 484 and 485). It is now known that many other mountains of folded structure have had a similar history.

Most mountains produced by folding have been extensively

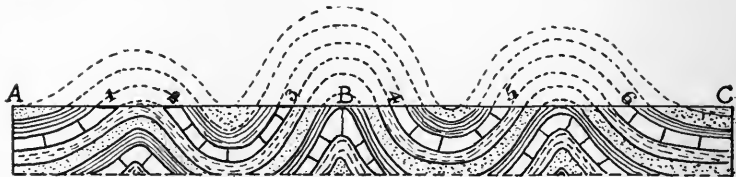

FIG. 484.—Diagram suggesting the type of structure possessed by the simple folding of strata. The diagram shows the folded surface worn down.

modified by erosion, as the accompanying figures suggest, but there are occasional exceptions, as shown by Fig. 486.

**Mountains produced by faulting.** Figs. 487 and 488 represent another type of mountain structure. Such mountains are sometimes called *block mountains*, because great blocks of the earth's crust, bordered by distinct planes of fracture, have been tilted so that one edge at least is well above its surroundings. In many such cases, it is probable that the surroundings have sunk rather than the mountains themselves that have been elevated. Many of

the mountains between the Rockies and the Sierras belong to this type, as elsewhere noted. This type of mountains is sometimes known as the *Basin Range* type.

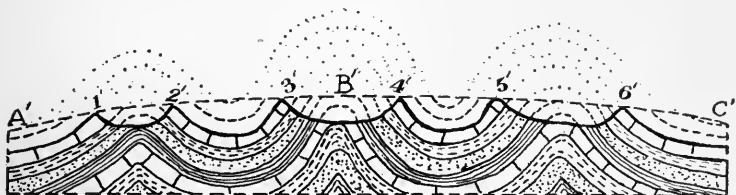

FIG. 485.—The same as Fig. 484, after an upwarp and subsequent erosion. No further folding is shown, and erosion has isolated the hard layers as mountain ridges. This represents, in a general way, the present condition of the Appalachians.

These illustrations show that mountains have various structures; they also suggest how mountains originated, though they do not in all cases indicate the causes which brought them into existence.

**Summary.** It will be seen from the foregoing that mountains are developed (1) by the degradation of their surroundings (Fig.



FIG. 486.—Open low mountain folds, not greatly modified by erosion. Cleman Mountain and Ummum Ridge, Washington. (U. S. Geol. Surv.)

471); (2) by the subsidence of their surroundings, either by down-warping or down-wedging (Fig. 487); (3) by elevation, either by up-warping (folding) (Fig. 486) or up-wedging; (4) by up-swelling, due to intrusions of igneous rock (Fig. 403); and (5) by up-building,



FIG. 487.—Ranges of the Great Basin. Length of section, 120 miles. (Gilbert.)

as in the case of volcanic cones. Mountains which originate by diastrophism or vulcanism are subject to erosion, and most existing mountains of volcanic or diastrophic origin have been so largely

modified by erosion, that the details of their present surfaces are the result of degradation.

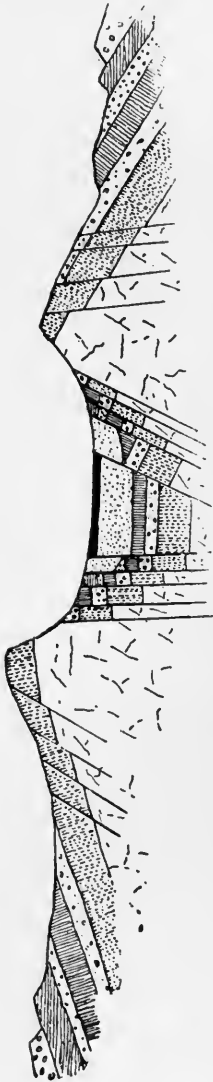

FIG. 488.—Section across the Vosges and Black Forest mountains. (Penck, by permission of G. P. Putnam's Sons.)

From Geikie's Earth Sculpture.



FIG. 489.—The divide between the headwaters of the Lake Fork of San Miguel River and Cascade Creek, southwestern Colorado. The lowest point in the divide, in the center of the photograph, is 12,700 to 12,800 feet above the sea. (Hole.)



FIG. 490.—Cascade Pass, Washington. The trees have an Alpine aspect. (U. S. Geol. Surv.)

### *Effects of Mountains on Mankind*

*Climctic effects.* Directly and indirectly, mountains play an important part in the affairs of men. In the first place, *they affect*



*climate* greatly. The winds blowing over them are cooled, and as they are cooled a part of their moisture often condenses and falls. Thus mountains, and especially the windward sides of mountains, are generally the sites of heavy rainfall, and therefore become the sources of important streams. On the other hand, plains and plateaus on the leeward side of mountains often have light rainfall, because the air, after passing over the mountains where it has left much of its moisture, is drying rather than rain-giving. This is the reason why the tracts east of the Sierra and Rocky mountains are arid or semi-arid (Fig. 492), and therefore sparsely settled. The state of Nevada, with an area of more than



FIG. 491.—A view in the Sierras from University Peak. Ko-ip Crest, Sierra Nevada Mountains.

100,000 square miles, had a smaller population in 1900 than the city of Peoria, Illinois.

Though the mountains make the country to leeward arid, they sometimes furnish water which may be utilized in irrigating these lands, for as the water which falls in the mountains flows out from them, it may be diverted from its natural courses and carried out by ditches to the fields.

The work of storing water in preparation for irrigation has been well started in the western part of the United States (p. 193), and still more extensive work in this direction is already planned. But a small part of the arid lands of the West will ever be irrigated, however, for the amount of water available is too small to supply more than a fraction of all the land which needs water.

The effect of mountains on the temperature, winds, cloudiness,

etc., of their surroundings is considerable, though perhaps less important than their effect on precipitation.

**Mountains are barriers to transportation.** It is true that railroads now cross mountain systems, but the cost of building and operating them after they are built is much greater than on the plains. A railroad map of the United States shows that there are few railroads in the eastern or western mountains, as compared with the number in the interior. Mountains are however much less effective barriers to mankind now than in earlier

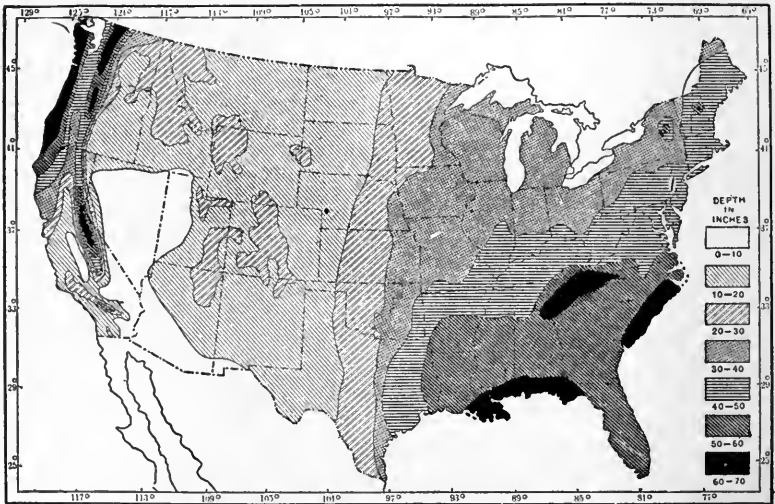
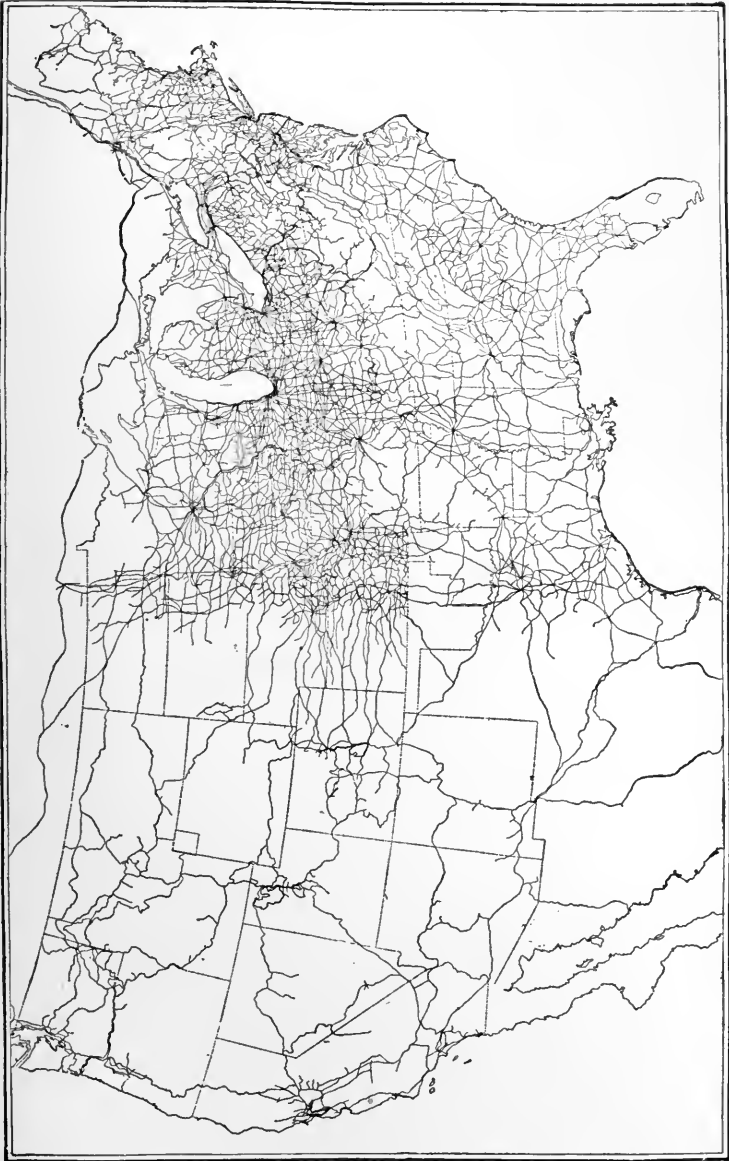

FIG. 492.—Rainfall of the United States. (U. S. Weather Bureau.)

times, before railway engineering had reached its present development.

**Mountains are effective barriers to animals and plants.** Most of the animals lower than man do not possess, and are unable to devise, means of crossing mountains, and to many of them high mountains are effective barriers. The climate of high altitudes is often such as to prevent the migration of plants from one side to the other, except by human help.

**Mountains often contain ores of various metals.** The fact that mining is the most distinctive industry of many mountains has been referred to elsewhere. It may be added here that most of the gold and silver and much of the copper of the United States come from the western mountains. From the same sources also



(Copyright, 1906, by William Beverley Harrison. Used by permission.)  
Fig. 493.—Railway map of the United States.

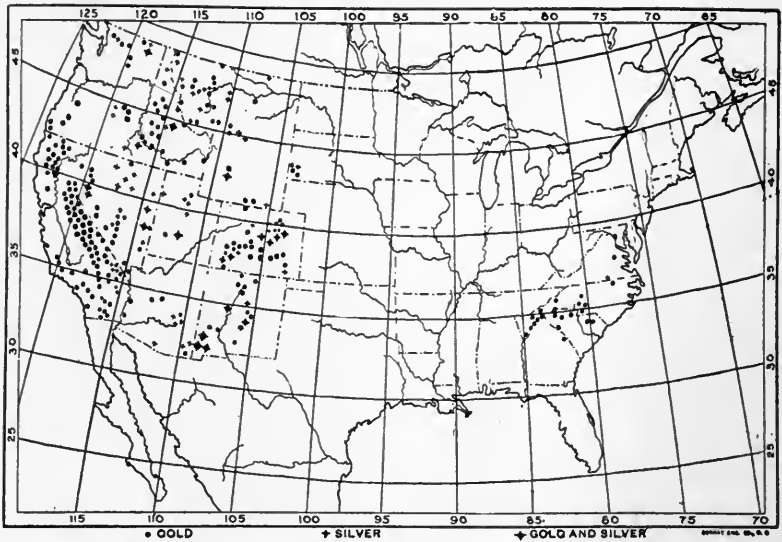

FIG. 494.—Map showing the areal distribution of gold and silver in the United States. The relative importance of the productions of different areas is not indicated. Circles = gold, crosses = silver, and the two combined = gold and silver. (After Ransome.)

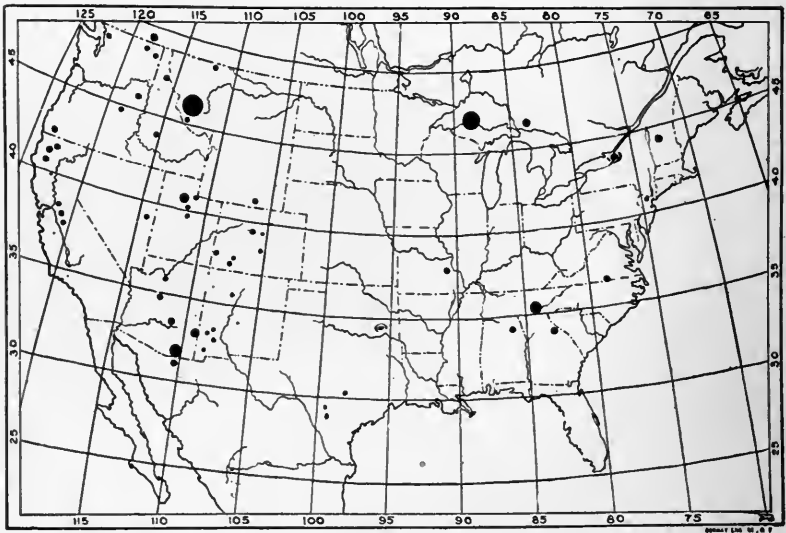

FIG. 494a.—Map showing the distribution of copper ores in the United States. The sizes of the dots indicate approximately the relative amounts produced. (U. S. Geol. Surv.)

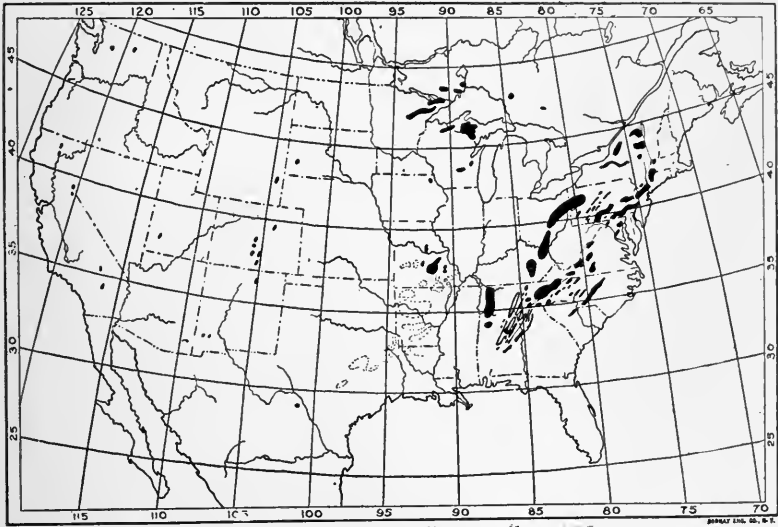

FIG. 495.—Map showing the distribution of iron ores in the United States. In 1904 Pennsylvania produced about 350,000 tons; Colorado, about 400,000 tons; Virginia and New Jersey, about 500,000 tons each; New York, about 789,000 tons; the southern Appalachian region, chiefly Alabama, about 4,459,000 tons; while the Lake Superior region produced 20,198,000 tons. The production of the Lake Superior region had increased by 1906 to more than 33,000,000 tons. (Based on an unpublished map prepared by W. O. Hotchkiss, with C. K. Leith.)

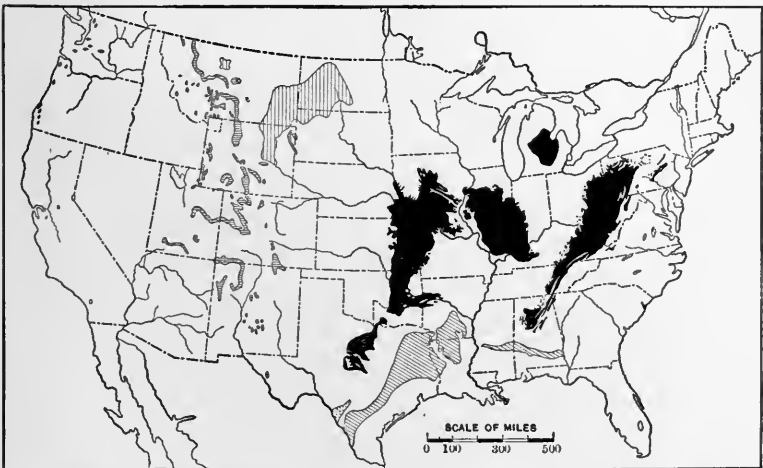

FIG. 496.—Map showing the distribution of coal in the United States. (U. S. Geol. Surv.)

comes much, but not all, of the lead and zinc. Iron and coal, on the other hand, the two most important products of mining, are not won chiefly from mountain regions, though some iron and much coal is mined both in the eastern and western mountains.

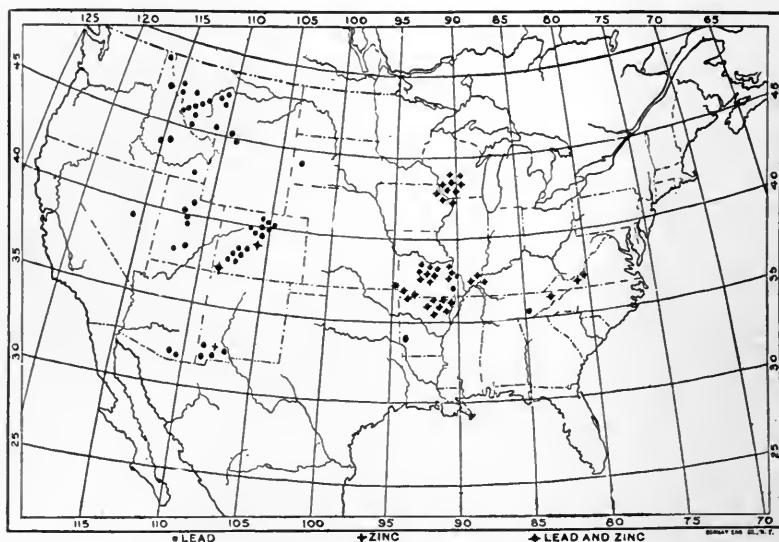

FIG. 497.—Map showing the distribution of lead and zinc ores in the United States. Circles=lead, crosses=zinc, and circles and crosses combined=lead and zinc. (After Ransome.)

**Agriculture in mountains.** Mountain valleys are often fertile, and many of them are under cultivation. Colorado, a mountainous state, produces more mineral wealth than any other state in the West; but the value of the products of the soil is greater than that of the products of its mines. A considerable portion of the cultivated land is in the mountains.

**Scenic effects.** Quite apart from economic considerations, mountains have a value not to be estimated in dollars and cents, in the scenery which they afford. The man who has not seen mountains, and who has not lived with them long enough to really make their acquaintance, has missed one of the good things of life. The Adirondacks, the Catskills, and the other mountains within a few hours' ride of such great cities as New York, Philadelphia, and

Boston, are of inestimable value. The mountains of the West are far grander. They are, unfortunately, frequented by fewer people, because much farther from great centers of population.

### *The Outlines of the Continents*

Any good map showing the outlines of the continents makes it clear that some coast-lines are regular while others are most irregular. The coasts of the northern part of North America and Eurasia are strikingly irregular, and in strong contrast with the outlines of South America, Africa, and Australia. The west coast of the southern part of South America is, however, very irregular.

Even the more regular coast-lines present contrasts, for some of them are nearly straight, while others are notably curved; and, where the continental outlines present large irregularities, certain portions of the coast, considered by themselves, are regular, and these may be straight or curved. Illustrations of such regularity are found on the west coast of India and the southeast coast of Arabia, though India and Arabia themselves constitute coastal irregularities of great size.

The irregular coasts present much greater variety. Broadly speaking, it may be said that there are two great types of irregularity, namely (1) projections of the water into the land, and (2) projections of the land into the water. The former are *bays, gulfs*, etc., and the latter are *peninsulas, capes*, etc.

Coastal irregularities may be further classified in various ways, and each classification brings out certain significant features. They may be classified on the basis of (1) size, (2) position with reference to the general trend of the coast, (3) relief, (4) origin, etc.

**Size.** The projections of water into the land, like the projections of land into the water, may be either large or small. The Gulf of Mexico, Hudson Bay, the Bay of Bengal, and the Baltic Sea are examples of large projections of water into the land, while Delaware, Chesapeake, Narragansett, and San Francisco bays, and Puget Sound are examples of smaller projections of water into the land. The little bays on the sides of Chesapeake Bay (Fig. 177) are examples of still smaller indentations of the same sort. On the coasts of Alaska (Fig. 498), Norway, Chile (Fig. 499), and some

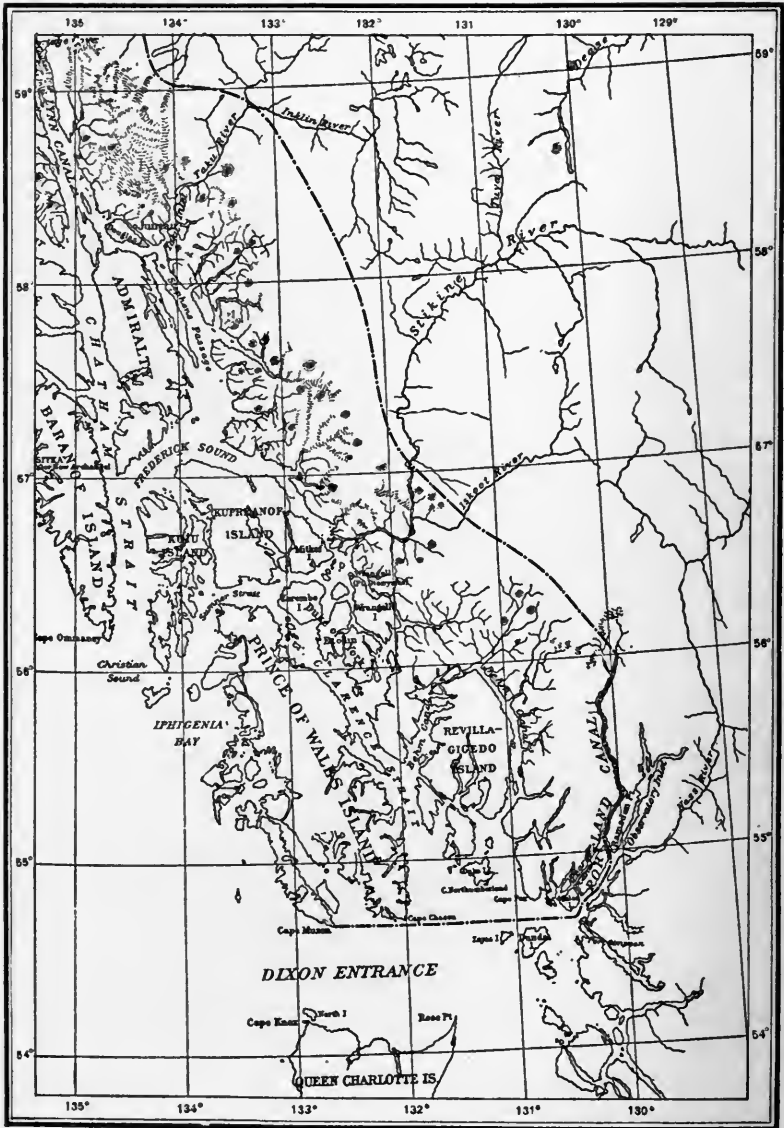

FIG. 498.—Map of part of the coast of southern Alaska, showing islands, which were once a part of the mainland, isolated by glacial and wave erosion, and by sinking.



other places, there are numerous narrow but deep bays or *fiords* (p. 248).

Examples of large projections of land into the sea are afforded by the north coast of Australia, the east coast of Africa, the south



FIG. 499.—Islands on the west coast of South America which were once a part of the continent. They have been isolated by erosion of glaciers and waves and by subsidence.

coast of Asia, and both the south and west coasts of Europe. North America, too, furnishes illustrations of this sort, especially in Alaska and Labrador, and, on a somewhat smaller scale, in

Florida, Yucatan, and Lower California. Small projections of land into the sea abound on most coasts. Cape Cod, Cape May, and Cape Mendocino are examples.

The projections of water into the land and of land into the water are often closely related. If two bodies of water not far from each other project into the land, they leave between them a projection of land into the water. An illustration is afforded by the Bay of Bengal and the Arabian Sea with India between. India may therefore be looked upon as a projection of land into the sea, or as an area of land left by the projection of two great arms of the sea into the land. Similarly, if two areas of land not far apart project into the sea, they enclose a body of water. The land east and west of the Gulf of Carpentaria on the north coast of Australia is an example.

**Position.** Arms of the sea may project into the land, or areas of land into the sea, so as to be somewhat nearly *at right angles to the trend of the coast*; or they may have positions *essentially parallel to the general trend of the coast*. Florida, India, Hudson Bay, and the Gulf of Mexico are examples of the former, and the Gulf and Peninsula of Lower California and many small irregularities along the Atlantic coast of the United States (Fig. 500) are examples of the latter. It will be seen that both large and small irregularities may occupy either position. They also occupy positions intermediate between these two.

**Relief.** Some coasts are high and some low, and the differences are so great that the lands present strong contrasts when seen from the sea. The irregularities of coast-lines as seen on maps affect both the coasts which are low and those which are high. Some of the great peninsulas which project out into the water, such as Scandinavia, the Iberian Peninsula, India, Lower California, and much of Alaska, are high, and others, such as Florida and Yucatan, are low. Small projections of land into the sea present the same contrasts. Some of them, as those on the coasts of Maine, Alaska, and Chile, are high, while others, such as those along the eastern coasts of the United States south of New York, are low.

The water in bays, gulfs, fiords, etc., is sometimes deep and sometimes shallow, and its depth is measurably independent of area. It is deep, for example, in the Gulf of Mexico, the Gulf of California, the Mediterranean Sea, the Arabian Sea, in many

fjords, etc., but shallow in the Baltic Sea, Hudson Bay, and the Gulf of Carpentaria.

**Distribution of various types of irregularities.** From the maps showing the outlines of the continents, it appears that great irregularities are distributed with less inequality than the small ones. While the northern continents have both large and small

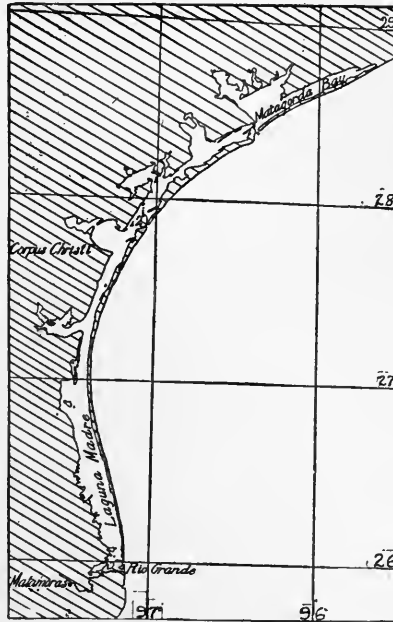

FIG. 500.—Portion of the coast of Texas, showing the tendency of shore deposition to simplify the coast line. The deposits (narrow necks of land parallel to the coast) shut in bays. (Coast and Geodetic Surv.)

irregularities in greater numbers than the southern continents, the contrast between the small irregularities of the northern and southern continents is greater than that between the large ones.

The great irregularities are not notably greater in the northern parts of the northern continents than in their southern parts. So far as this class of irregularities is concerned, the coast-lines of southern Asia and Europe are as irregular as those of other parts of these continents. The small irregularities of northern Europe, and especially of northwestern Europe, are, however, more conspicuous

than those of southern Europe. The same holds, in a general way, for North America. While this continent has great and small irregularities both at the north and south, small irregularities are more numerous in high latitudes than in low.

Again, the small irregularities in the southern part of North America are more commonly low, while those in the northern part often have greater vertical range. The former are often parallel to the trend of the coast, while the latter are more commonly at right angles to it.

The irregularities of coasts stand in some relation to the width of the continental shelf. Large irregularities of outline are, in general, more common where the continental shelf is wide than where it is narrow. High shores are, on the whole, more irregular in outline than low ones, though to this general rule there are many exceptions.

The islands along many of the coasts of continents are really to be looked upon as parts of the coastal irregularities, for, as we shall see later, many islands along coasts were once part of the mainland. Here belong many of the islands off the coast of Alaska (Fig. 498), Chile (Fig. 499), Scandinavia, etc.

All these numerous and varied irregularities call for explanation, and our studies of processes now in operation have furnished the data necessary for understanding why some coast-lines are regular and others irregular, why some coasts are high and others low, why the slopes of some coasts are steep and those of others gentle. They have also given us a basis for some conception of the origin of great and small projections of land into the sea, and of great and small projections of the sea into the land.

**Agents of gradation.** In preceding chapters we have seen the results produced by agents of gradation on the horizontal configuration of coasts. We have seen (p. 320) that waves tend to develop indentations of water where the rock is weak, leaving projections of land where the rock is resistant, and that irregularities thus developed are relatively small. The capes, etc., thus formed will be low or high, depending on the relief of the land from which they were developed. The reëntrants of water developed by wave erosion are always shallow.

We have also seen that deposition along shores develops irregularities, especially by the formation of strips of land roughly parallel to the trend of the coast, across the debouchures of bays, etc., and

that the irregularities thus developed are a step in the direction of final simplification of the shore-line (Fig. 500). The lands developed by shore deposition are always low, as left by the waves, and the lagoons shut in behind them are shallow.

We have also seen (p. 248) that glaciers descending to the sea may gouge out deep valleys, which become fiords when the ice melts. Glacial erosion may otherwise modify the coast-line, both by erosion and deposition. Glaciation, once much more extensive than now, affords the explanation, or at least a part of the explanation, of the many fiords of high latitudes. Subsidence may also be a factor in the development of fiords.

Rivers make coast-lines irregular by building deltas at their debouchures, but through their erosive work they do little to make coast-lines irregular horizontally. On the other hand, they make high coast-lands irregular vertically, by developing valleys in them.

Winds have little effect on the horizontal configuration of coasts, but by piling up dunes they affect the relief of coast-lands to some extent.

This brief review makes it clear that agents of gradation are competent to produce many irregularities of coast, especially those of small size.

**Diastrophism.** If the bottom of the ocean were somewhat depressed, increasing the capacity of the basin, the water would be drawn down about the borders of the continents and all the coast-lines would be shifted seaward. On such a coast as that of the eastern part of the United States, the border of the continent would become notably more regular than now, because the topography of the continental shelf, now submerged, is nearly plane. Some coasts which are comparatively regular owe their regularity to recent emergence.

If, on the other hand, the borders of continents were depressed, the coast-lines would in general become somewhat more irregular than now, for the depression of the land would allow the sea-water to extend up the valleys, developing bays where there are none now, and extending those which now exist (p. 174).

Some indented coasts, like that of the United States between New York and the Carolinas, owe their numerous bays to recent subsidence. Where the river valleys were normal to the coast, as is most commonly the case, roughly speaking, the bays are normal

to the coast. If the valleys drowned in the making of the bays were not normal to the coast, the bays would not be.

Again, the sufficient up-warp of a submerged tract along the coasts of continents would develop peninsulas. These peninsulas might be normal to the coast or roughly parallel to it, or at any angle between. A corresponding down-warp would develop a bay or gulf, and many large bays and gulfs have probably arisen in this way. The elevated or depressed area might be faulted instead of warped, with similar results so far as the horizontal configuration of the coast is concerned.

**Vulcanism.** Volcanoes affect coast-lines locally, but their influence is relatively slight as compared with that of gradation and diastrophism. Volcanoes make islands near coasts more commonly than they produce modifications of the coasts of mainlands. Igneous rocks are often more resistant than sedimentary rocks, and so affect the forms of coast lines developed by erosion.

### *Application*

By the application of the above principles to coast-lines, the chief features of many of them may be readily understood. Where there are numerous bays along the coast-line projecting into the land at right angles, roughly speaking, to its general trend, it may be inferred with some confidence either that the region has recently sunk, drowning the lower ends of the rivers, or that it has been glaciated recently, converting the lower ends of the valleys into fiords, or both. If the area concerned is in low latitude, the chances are in favor of the first interpretation; if in high latitude, and especially if the altitude be high, glaciation is a probable or partial cause of the indentations.

Chesapeake Bay and the numerous bays tributary to it, Delaware Bay and others of the same sort on the eastern coast of the United States, point clearly to recent submergence of the land. Farther north, the indentations of the coast of Maine find their explanation partly in subsidence perhaps, but largely in glacial erosion, for the ice of the continental glacier passed out to sea over this coast. The fiords of such coasts as that of Alaska, Chile, Scandinavia and Scotland are largely the result of glacial erosion, though subsidence may have deepened and extended the indentations of water.

Where there are long, narrow belts of low land, roughly parallel to the general trend of the coast, deposition by waves and shore currents is to be inferred. Illustrations are afforded by many parts of the coast between New York and Texas.

Where there are great irregularities of outline, such as the Gulf of Mexico, the Gulf of California, the Adriatic Sea, the Bay of Bengal, the Arabian Sea, the Iberian Peninsula, Italy, India, Kamchatka, the peninsulas of Lower California, Yucatan, Florida, etc., diastrophism has probably been the chief factor concerned.

The irregularities of coast produced by diastrophism are not all of great size. Puget Sound, though large, is much smaller than most of the irregularities mentioned, and is believed to have had its origin in a down-warp.

Where coasts are high, diastrophism or wave-cutting, or both, are suggested. Steep slopes, even where not high, give the same suggestions, while low coastal lands without cliffs are characteristic of areas of shore deposition.

It is to be borne in mind that coast-lines are not permanent, and that the coast-lines of to-day are not precisely the same as the coast-lines of yesterday, and those of to-morrow will not be precisely the same as those of to-day, for gradation and diastrophism are constantly changing them, and vulcanism occasionally.

**Historical bearing.** The character of the coast-lines has had an important influence upon the development of many countries. The irregular coasts of northwestern Europe and the northeastern part of the United States abound in harbors, and favor the development of ocean commerce. On the other hand, a smooth, regular coast has always rendered difficult, and sometimes completely discouraged, sea trade. The southeastern states, eastern Mexico, Africa, and India have all experienced, in varying degrees, the disadvantages of such a coast. The greatest motive in Russian expansion has been the possession of ice-free harbors.

Wherever a people has occupied an indented coast, with off-lying islands and an infertile hinterland, it has early turned to the sea for a living, and has developed daring seamen; and this regardless of race or inherent abilities. Examples are the Northmen, the Indians of southern Alaska, the blacks of northwestern Madagascar, and the Malays of the Tenasserim coast. On the other hand, a harborless coast has invariably prevented the development of the sea-going habit.

## ISLANDS

As already indicated, many islands are really shore features, being developed by the same agents and processes which develop the horizontal configuration of coasts.

Like other natural features, islands may be classified in various ways, and each classification brings out certain significant facts. Thus, on the basis of *size*, they are large and small; on the basis of *height*, they are high and low; on the basis of *position*, they are continental and oceanic; and on the basis of *fertility*, they are fertile and barren. Between the extremes of each of the above groups there are all gradations. Other comparable bases of grouping may be suggested. The most significant classification, from the physiographic point of view, is based on *origin*. Islands arise through the processes of *diastrophism*, *vulcanism*, and *gradation*, and, if the action of organisms be excluded from gradation, by *organic action*.

1. **By diastrophism.** The rise of any portion of sea bottom enough to cause it to emerge from the water, gives rise to an island, if the new land is not connected with a continent. Similarly, the subsidence of the sea might cause the emergence of elevated portions of sea bottom, giving rise to islands. Cuba and the other large islands of the West Indies belong to this general class.

The rise of the sea-level might transform the elevations of a coastal plain into islands, by submerging the surrounding land. The same result might be brought about by the sinking of coastal lands of strong relief. Great Britain was thus separated from the mainland. Had it remained connected with the continent, the course of European history would probably have been very different.

2. **By vulcanism.** Many submarine volcanoes have built up their cones so that their tops emerge. Far from coasts, islands of this sort are more common than any others. Volcanic islands are, however, not confined to the deep sea.

3. **By gradation.** (a) *By erosion.* Islands arise both by aggradational and degradational processes, and both aggradation and degradation are effected by different agents.

*Waves* often so erode a coast as to isolate small areas of resistant rock, converting them into islands (Fig. 501).



*Glaciers* descending from the land to the sea may, by erosion, isolate coastal promontories, converting them into islands. It is probable that some of the islands on glaciated coasts arose in this way.

Islands are sometimes formed in rivers by the erosion of the stream (Fig. 502). The jointing of the rock seems often to afford the conditions for the development of such islands. The erosive action of the James River transformed the Jamestown peninsula into an island toward the end of the 17th century, a thing the



FIG. 501.—Finn Rock and Cape Blanco, Oregon. (U. S. Geol. Surv.)

colonists had planned to do for purposes of defence. River islands are also sometimes developed through the meandering of the streams (Fig. 197).

(b) *By deposition.* Islands arise by the deposition of sediment along sea and lake shores and in rivers. Such islands are usually low and sandy, and always near other land. The processes which give rise to them have been indicated (p. 324). They are often affected by dunes. Glacier deposits also give rise to islands, as in Boston harbor. Islands which have cores of solid rock are often enlarged by various processes of deposition.

**4. By combinations of diastrophism, gradation, and vulcanism.** Many existing islands owe their origin and form to the combination of two or more of the above agents. River or glacier erosion often develops an uneven topography along shore, and a

slight subsidence of the coast, or a rise of the sea-level there, gives rise to islands, because the land has been properly prepared in advance. It is to such a combination of degradation and diastrophism that many of the islands of glaciated coasts, such as those of Maine, Alaska, Norway, etc., are due.

Other combinations, too, of the several agents operative on coasts may give rise to islands. Thus, an island which was primarily volcanic may be enlarged in area by the deposition of sedi-



FIG. 502.—Lone Rock. An island in the Wisconsin River, isolated as an island by the notable widening of a series of joints in the sandstone. (Meyers.)

ment about it, the sediment being brought down from the higher parts of the island. Iceland is an example.

Whatever their origin, most existing islands have been more or less notably modified by erosion.

Island coasts are subject to all the changes which affect the coasts of continents. Islands are subject to destruction by the waves, on the one hand, and they may cease to be islands by being attached to continents. Such connection may be brought about by diastrophism or gradation (Pl. XXII). Thus, a former island may be tied to the mainland by deposition. After being joined to the mainland the former island becomes a part of a striking irregularity of the coast.

**5. By organic processes.** There are in some parts of the world numerous islands composed of coral. The little animals (*polyps*)

which secrete the coral live (1) where the water is 120 feet or less in depth; (2) where the temperature never falls below about 68° F.; (3) where the water has the saltness of normal sea-water; (4) where the water is nearly free from sediment; and (5) where it is subject to some movement by the wind. In such situations they thrive, and sometimes make reefs and sometimes islands.

Polyps are not free-moving animals, except in the early part of their lives, before they begin coral-making. Through the larger



FIG. 503.—Diagram of a fringing reef.

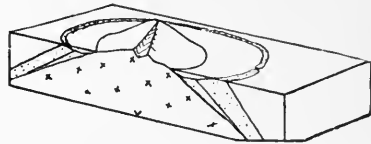

FIG. 504.—Diagram of a barrier reef.

part of their lives they are attached to the bottom. They flourish about many islands of volcanic origin and along some continental coasts, as along the east coast of Australia. They also flourish in some places far from islands or continents, if there is shallow water of the right temperature.

Figs. 503 and 504 show coral reefs. Those which are far enough from the land to leave a somewhat wide and deep lagoon



FIG. 505.—Diagram suggesting the development of a barrier reef and an atoll, successively, from a fringing reef by sinking. 1, Fringing reef, formed in shallow water; 2, barrier reef, developed from fringing reef after subsidence; 3, the atoll which succeeds the barrier reef.

inside are *barrier* reefs; those close to the land are *fringing* reefs. It seems probable that fringing reefs sometimes become barrier reefs by the sinking of the island or coast where they occur, as illustrated by Fig. 505. The sinking should not proceed faster than the polyps build up the reef. Barrier reefs, the bottoms of which are in deep water, were formerly thought to prove subsidence; but this conclusion is questioned. A reef in shallow water may come to have a long outer slope, with its bottom in water far below 120 feet, if coral be broken off from the upper part of the

reef and caused to descend the slope into deeper water. This process is illustrated by Fig. 506. It is probable that barrier reefs have been developed in both these ways. Coral reefs are usually

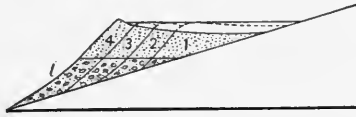

FIG. 506.—Diagram suggesting the origin of a barrier reef without subsidence. The reef starts in shallow water near shore. Material broken from it falls down, making a sort of talus slope, the lower part of the shaded portion, and the polyps build out on this slope, but always remain in shallow water (1, 2, 3, 4). The outer edge of the reef thus comes to be in deep water.

interrupted where fresh water descends from the land, so that a reef rarely surrounds an island, and is rarely continuous for great stretches along any coast.

It is manifest that the barrier reef about a small island may

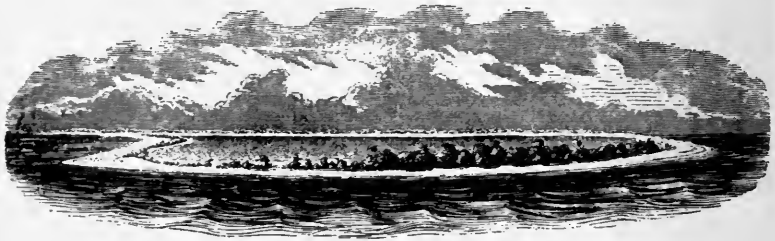

FIG. 507.—An atoll. (From Dana's Corals and Coral Islands, by permission of Dodd, Mead & Co.)

become an island or atoll by subsidence. This is illustrated by

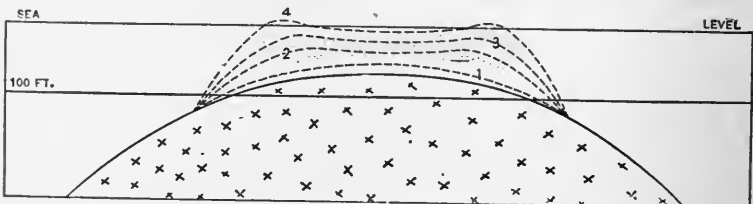

FIG. 508.—Coral island developed from a submerged volcano (or other rock).

Fig. 505. Coral islands might also arise by the development of reefs on volcanic cones which did not rise into islands (Fig. 508).

The polyps do not build the reef or the atoll above water; but when they have built up to water-level the waves may build it higher, as they convert sand reefs into land. Once land appears, the wind may make it higher by piling up coral sand. The growth

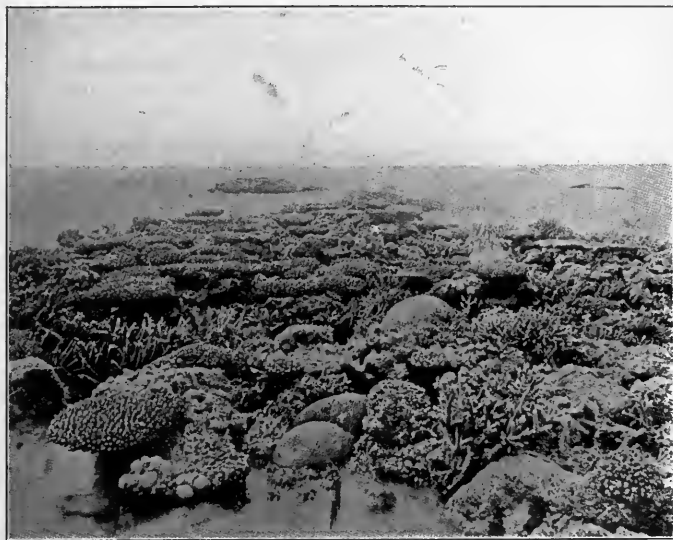

FIG. 509.—Coral growing.

of vegetation may help along the building, both by its own growth and by helping the lodgment of wind-blown sediment.

Coral islands and reefs would always remain low if it were not for diastrophism. There are indeed no very high coral islands, but there are coral reefs 2000 or 3000 feet above sea-level. Either the land where such reefs occur has risen greatly, or the sea-level has been depressed.

#### TOPOGRAPHIC MAP STUDIES.

The following maps illustrate types of plains, plateaus, and mountains. See also the list of maps on pp. 54 and 479.

The folios (see foot-note, p. 79) of the areas shown on the maps marked \* are published, and are always serviceable in the interpretation of the topography.

## A. PLAINS

## 1. Coastal

Deal Island, Md.	Asbury Park, N. J.
Dennisville, N. J.	Sandy Hook, N. J.
Cape May, N. J.	* Coos Bay, Ore.
Atlantic City, N. J.	* Norfolk, Va.
Great Egg Harbor, N. J.	

## 2. Interior

*a. Flat:*

Maxwell, Cal.	Chocowinity, N. C.
* Casselton, N. D. (Casselton-Fargo folio).	Bowling Green, O.

*b. Uneven and well-drained:*

Petersburg, Ind.	Sullivan, Mo.
* Ditney, Ind.	Lancaster, Wis.—Ia.—Ill.
Tuscumbia, Mo.	

*c. Uneven and ill-drained, glaciated:*

Crystal Falls, Mich.	Geneva, Wis.
White Bear, Minn.	Madison, Wis.
Oswego, N. Y. (special map).	Briggsville, Wis.

## B. PLATEAUS

Chino, Ariz.	* Canyon, Wyo. (Yellowstone National Park folio).
Burnsville, W. Va.	
* Charleston, W. Va.	

## C. MOUNTAINS

* Marysville, Cal.	Kaaterskill, N. Y.
San Mateo, Cal.	Mt. Marcy, N. Y.
Mt. Lyell, Cal.	Saluda, N. C.—S. C.
Shasta, Cal.	* Mt. Mitchell, N. C.—Tenn.
* Telluride, Colo.	Millersburg, Pa.
Leadville, Colo.	Lykens, Pa.
* Pikes Peak, Colo.	* Greenville, Tenn.—N. C.
Huerfano Park, Colo.	* Morristown, Tenn.
* Holyoke, Mass.—Conn.	* Maynardville, Tenn.
Greylock, Mass.—Vt.	Henry Mountains, Utah.
Saypo, Mont.	* Tintic, Utah.
Hamilton, Mont.—Ida.	Tooele Valley, Utah.
Sumpter, Ore.	* Ellensburg, Wash.
	Ishawoot, Wyo.

The types of plains are indicated in the above classification, and their distinctive features should be observed. The plateaus show various degrees of dissection.

The mountain maps should be studied with a view to distinguishing topographic types (pp. 435-437). An attempt should also be made to group them according to their origin (p. 445). The results of this latter classification should be tested by the *Structural Sheets* of the folios so far as possible.

### MAPS FOR REVIEW

#### I. List of Maps.

- |                           |                        |
|---------------------------|------------------------|
| 1. Fire Island, N. Y.     | 7. Glacier Peak, Wash. |
| 2. Marsh Pass, Ariz.      | 8. Frostburg, Md.      |
| 3. Princess Anne, Md.—Va. | 9. Stoughton, Wis.     |
| 4. Abilene, Tex.          | 10. Marseilles, Ill.   |
| 5. Hahnville, La.         | 11. Mt. Taylor, N. M.  |
| 6. Gay Head, Mass.        | 12. Savanna, Ia.—Ill.  |

These maps touch most of the topics studied in preceding pages.

#### II. Questions to be answered in writing. In the case of each map—

1. State whether the area is plain, plateau, or mountain, or if more than one of these great types appears, the location of each.

2. Name the several agencies which have shaped the surface, and indicate their relative importance.

3. State age of the topography in terms of erosion. If different parts of the area are in different stages, bring out this point.

4. How many cycles of erosion are shown? The evidence for the conclusion stated. Is it conclusive?

5. Is there any indication as to the position of the strata underlying the region?

6. What indications are there of inequalities of hardness of rock?

7. State what inferences may be made (certain, probable, possible) concerning the climate, and the evidence on which they are based.

8. Note any important features not brought out by the preceding questions.

### REFERENCES

1. Standard text-books on Geology.
2. Folios of the U. S. Geol. Surv., of areas in mountain regions.
3. WILLIS, *Mechanics of Appalachian Structure*: 13th Ann. Rept. U. S. Geol. Surv., Pt. II, pp. 217-283.
4. LE CONTE, *On the Structure and Origin of Mountains*, etc.: Am. Jour. Sci., Vol. XXXVIII, 1889, pp. 257-263; *Theories of the Origin of Mountain Ranges*: Jour. Geol., Vol. I, pp. 543-573.
5. DANA, *On the Origin of Mountains*: Am. Jour. Sci., Vol. V, 1873, pp. 347, 423, and 474, and Vol. VI, pp. 6, 104, 161, 304, and 381.

6. POWELL, *Types of Orographic Structure*: Am. Jour. Sci., Vol. XII, 1876, pp. 414-428.
7. TARR, *Mountains of New York*, in Physical Geography of New York State.
8. READE (T. MELLARD), *The Origin of Mountain Ranges*.
9. GULLIVER, *Shoreline Topography*: Am. Acad. Arts and Sci., Vol. XXXIV.
10. DARWIN, *The Structure and Distribution of Coral Islands*: Appleton.
11. DANA, *Corals and Coral Islands*: Dodd, Mead & Co.
12. AGASSIZ, Various Papers in Bull. Mus. Comp. Zool., Harvard.
13. HEILPRIN, *The Bermuda Islands*: Appleton.
14. Various Papers on coral islands in *Nature*, Vols. 22, 35, 37, 39, 40, 41, 42, 51, and 55.



## CHAPTER X

### TERRESTRIAL MAGNETISM

THE earth is a great magnet and, like the small magnet with which we are familiar, has two poles. One of these poles is called the *North Magnetic Pole* and the other the *South Magnetic Pole*. Generally speaking, one end of the magnetic or compass needle points toward one of these poles, and the other toward the other. If we were to follow the directions pointed by the compass needle, we would be led to the North Magnetic Pole in the one case, and to the South Magnetic Pole in the other. The lines connecting these poles are *magnetic meridians* (Fig. 510).

The North Magnetic Pole is in latitude a little above  $70^{\circ}$ , and in longitude about  $97^{\circ}$  W., as nearly as known. The South Magnetic Pole is in latitude about  $72^{\circ}$ , and in longitude about  $152^{\circ}$  E. These positions have been calculated from the directions in which the compass needles point in various positions in the vicinity of the magnetic poles. The South Magnetic Pole has never been reached, and Captain Amundsen reports that "the North Magnetic Pole has no immediate situation," which probably means that it is not a fixed point.

It will be seen from the foregoing that the magnetic poles are far from the geographic poles, and that they are not exactly opposite each other. It is believed, too, that they are not quite constant in position, though they are not known to wander widely. The North Magnetic Pole has been thought to have shifted its position some 50 or 60 miles in as many years, following 1830, though this determination does not appear to be conclusive.

Since the north end of the magnetic needle points to the North Magnetic Pole, it follows that the compass does not indicate true north and south in many places. At points northward from the North Magnetic Pole, the "north" end of the needle points in a southerly direction. At points to the south it points to

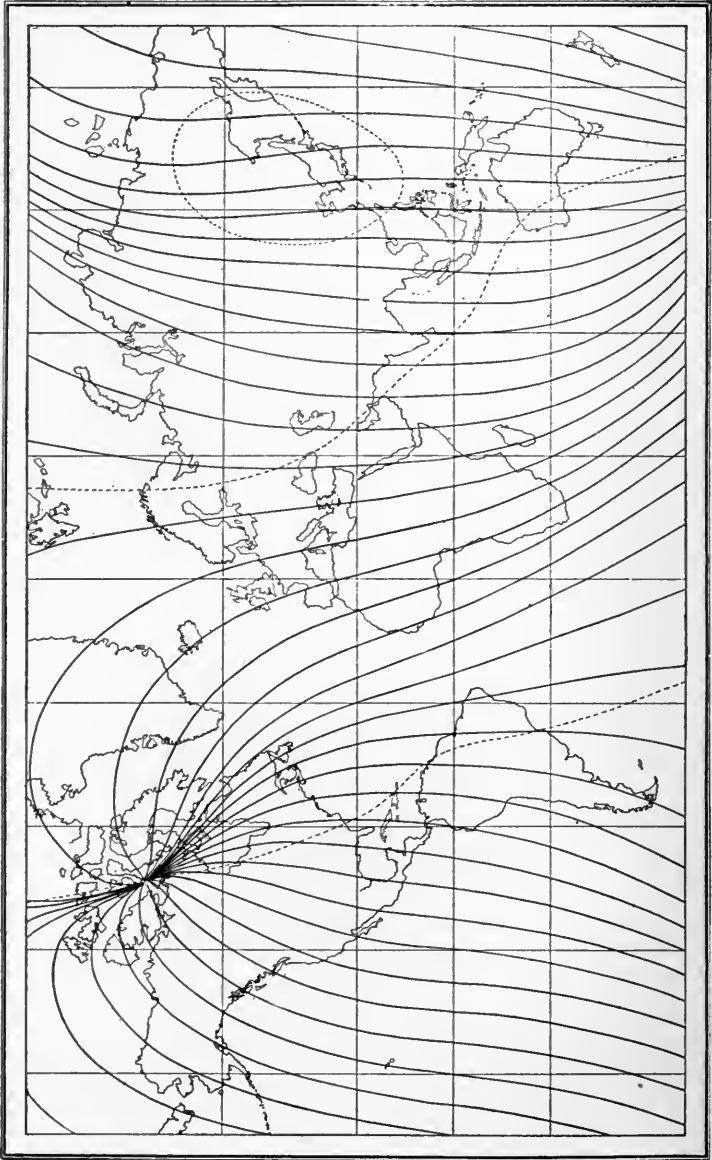

Fig. 510.—Magnetic meridians for 1885.

the northward, at points east, westward, and at points west, eastward. The departure of the needle from the true north and south is *magnetic declination*. Lines connecting places of equal declination are *isogonic lines*. A line connecting places of no declination is an *agonic line*.

Fig. 511 shows an agonic line in the United States passing from Lake Superior to South Carolina. Along this line the magnetic needle points due north and south. All places east of this line

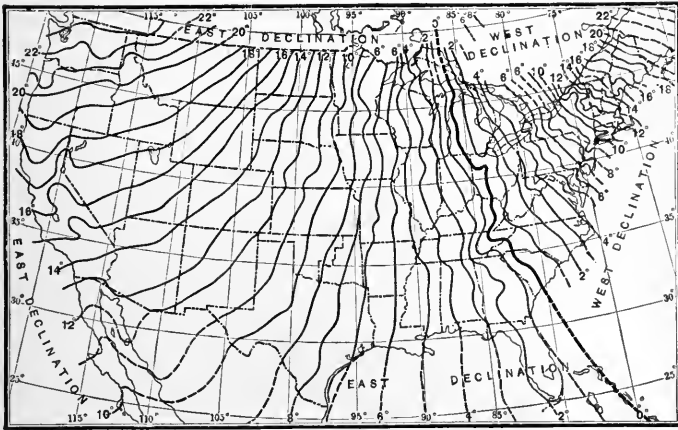

FIG. 511.—Isogonic lines for the United States, 1902. The heavy line is an agonic line, or line of no declination. (U. S. Coast and Geodetic Surv.)

have *west declination*, and all places west of this line have *east declination*. In general, declination increases with increasing distance from the agonic line. In Maine, for example, the declination is more than  $20^{\circ}$  W. at a maximum, and in Washington more than  $20^{\circ}$  E. (Fig. 511). At Chicago the declination is about  $3^{\circ}$  E.; at New York nearly  $10^{\circ}$  W.; at Denver about  $13^{\circ}$  E.; and at San Francisco about  $16^{\circ}$  E. It will be seen that it is important to know the magnetic declination of a region, if the compass is to be used there for determining directions.

The declinations shown in Figs. 511 and 512 are interfered with locally by certain rock formations, especially magnetic iron ore. In the vicinity of such ore, especially if it be in large bodies, the needle may depart widely from the declination indicated by these lines.

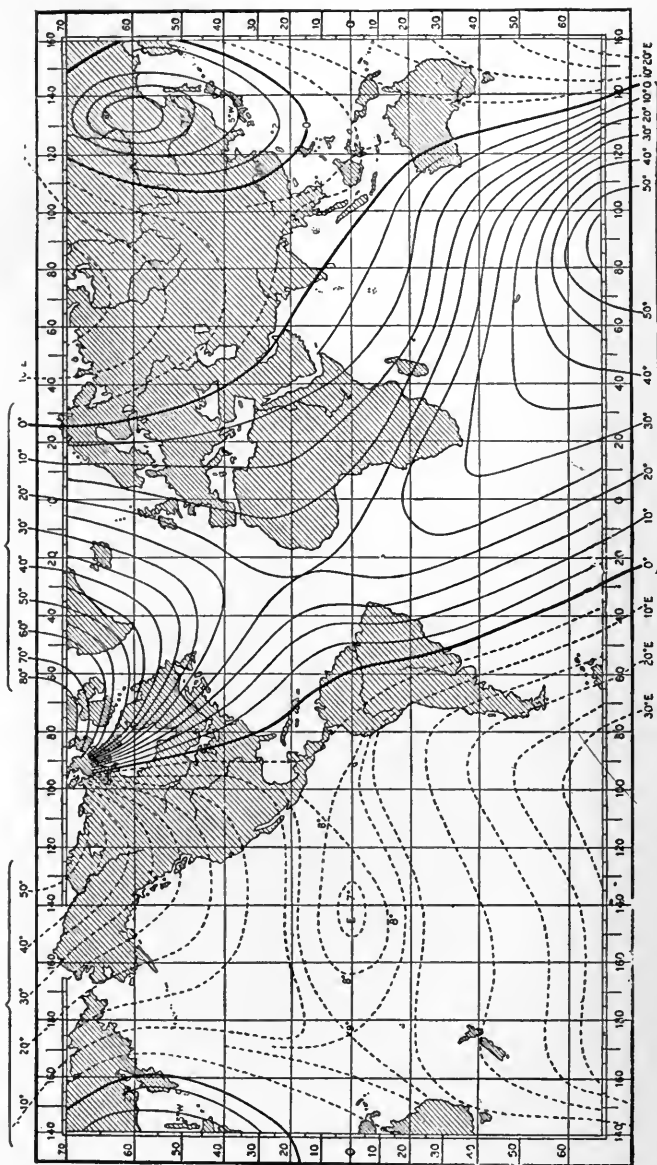

Fig. 512.—Lines of equal magnetic declination, 1905. (British Admiralty.)

Since the magnetic poles shift slowly, the declination at any place also shifts in harmony. It is not certain, however, that all variations in magnetic declination are due to the shifting of the magnetic pole. The declination at Chicago has shifted more than 2° since 1820.

**Dip.** The magnetic needle does not usually take a horizontal position. At the magnetic poles it should be vertical, and the north end would be down at the North Magnetic Pole. Its position would be reversed at the South Magnetic Pole. Half-way between the magnetic poles, that is, at the magnetic equator, the needle should be horizontal. A compass which is constructed so as to show the dip or *magnetic inclination* is a *dip compass*.

**Intensity.** Magnetic intensity varies greatly from place to place, and slightly from time to time in the same place.

The causes and the conditions of change of terrestrial magnetism are not well understood.

#### SUPPLEMENTARY LIST OF MAPS

##### I. *Topographic Maps, U. S. Geological Survey*

The following maps will afford opportunity for more extended map study. The use of as many of them as time permits will be profitable. These, together with those already mentioned in preceding pages, make a fairly adequate equipment so far as topographic maps are concerned. The maps mentioned in this volume should be supplemented by those of the home region, and the maps of the home region should be used in the field, as much as possible. In no other way will the maps be so well understood. For the areas marked \*, folios have been published (see foot-note, p. 79), and they are helpful in the study of topography. See especially the structure-section sheets.

#### CHAPTER I

Batesville, Ark.	Minneapolis, Minn.
Tamalpais, Cal.	Hamilton, Mont.-Ida.
Tipton, Ia.	Dennisville, N. J.
* Cottonwood Falls, Kan.	Everett, Pa.
Montross, Md.-Va.	* Gaines, Pa.-N. Y.
Frostburg, Md.-W. Va.-Pa.	

#### CHAPTER II

Lakin, Kan.	Browns Creek, Neb.
Oceanside, Md.-Del.	

#### CHAPTER III

* London, Ky.	* Kingston, Tenn.
---------------	-------------------

## CHAPTER IV

A. *River erosion, especially river valleys.*

Morrilton, Ark.	Oberlin, O.
Dunlap, Ill.	* Wartburg, Tenn.
New Harmony, Ind.-Ill.	Anson, Tex.
Medicine Lodge, Kan.	Abajo, Utah-Colo.
Tell City, Ky.-Ind.	* Monterey, Va.-W. Va.
Palmyra, Mo.	St. Croix Dalles, Wis.-Minn.
Oak Orchard, N. Y.	* Gallatin, Wyo. (Yellowstone National Park folio).
* Mt. Mitchell, N. C.-Tenn.	* Shoshone, Wyo. (Yellowstone National Park folio).
Parmelee, N. C.	
* Fargo, N. Dak. (Casselton-Fargo folio).	

B. *Topographic effects of unequal hardness after notable erosion.*

Denver, Colo.	High Bridge, N. J.
* Rome, Ga.-Ala.	Passaic, N. J.
* Holyoke, Mass.-Conn.	Hollidaysburg, Pa.
Saypo, Mont.	* Uvalde, Tex.

C. *Piracy and adjustment.*

* Stevenson, Ala.-Ga.-Tenn.	* Franklin, W. Va.-Va.
* Piedmont, Md.-W. Va.	* Lake, Wyo. (Yellowstone National Park folio).
* Chattanooga, Tenn.	
* Ringgold, Tenn.-Ga.	

D. *Alluviation.*

Morrilton, Ark.	* Three Forks, Mont.
Sierraville, Cal.	Lexington, Neb.
Hartford, Conn.	Paxton, Neb.
Camas Prairie, Ida.	Silver Peak, Nev.-Cal.
Mountain Home, Ida.	Cohoes, N. Y.
Waukon, Ia.-Wis.	Watkins, N. Y.
East Delta, La.	Williamston, N. C.
Hahnville, La.	Portland, Ore.-Wash.
Independence, Mo.	

See also River Charts (IV, below).

E. *Cycles of erosion.*

Echo Cliffs, Ariz.	Everett, Pa.
San Francisco Mt., Ariz.	Harrisburg, Pa.
Tusayan, Ariz.	Huntingdon, Pa.
Batesville, Ark.	Delaware Water Gap, Pa.-N. J.
Marshall, Ark.	Pala Pinto, Tex.
Mountain View, Ark.	Wausau, Wis.
* Ditney, Ind.	Winchester, W. Va.-Va.
Watrous, N. M.	

## CHAPTER V

* Colfax, Cal.	Deer Isle, Me.
Durant, Ia.	Chief Mountain, Mont.
Clinton, Ia.-Ill.	Hamburg, N. J.
Boothbay, Me.	Plainfield, N. J.-N. Y.

## CHAPTER V—Continued

Greenwood Lake, N. Y.—N. J.	Weedsport, N. Y.
Elmira, N. Y.—Pa.	Tower, N. Dak.
Little Falls, N. Y.	Pingree, N. Dak.
Hammondspport, N. Y.	Masontown, Pa. (Masontown- Uniontown folio).
Harlem, N. Y.—N. J.	Methow, Wash.
Niagara Falls, N. Y.	Chelan, Wash.
Tonawanda, N. Y.	Snoqualmie, Wash.
Skaneateles, N. Y.	Delavan, Wis.
Penn Yan, N. Y.	Briggsville, Wis.
Tully, N. Y.	Baraboo, Wis.
Rosendale, N. Y.	Denzer, Wis.
Rochester, N. Y.	The Dells, Wis.
Syracuse, N. Y.	

## CHAPTER VI

## Group K.

Cayucos, Cal.	Northport, N. Y.
Haywards, Cal.	Babylon, N. Y.
Hueneme, Cal.	Fire Island, N. Y.
San Francisco, Cal.	Hamlin, N. Y.
Oceanside, Cal.	Euclid, O.
Biddeford, Me.	* Port Orford, Ore.
Tolchester, Md.	Erie, Pa
Muskegat, Mass.	

## CHAPTER VII

San Francisco Mt., Ariz.	Crater Lake (special), Ore.
* Lassen Peak, Cal.	Terlingua (special) Tex
Mt. Lyell, Cal.	Abajo, Utah—Colo
Mt. Taylor, N. M.	Henry Mts., Utah.

II. *Coast and Geodetic Survey Charts*<sup>1</sup>

Charts bearing the numbers 8, 10, 19, 21, 103, 105, 109, 110, 120, 122, 123, 124-126, 131-136, 146, 156, 157, 161, 167-169, 177, 184, 204, 1000, 1001, 1002, 1007, 5100, 5106, 5143, 5200, 5500, 5581, 6300, 6450, 6460, 8100, 8300, 9302, S, and T.

III. *Lake Survey Charts*<sup>2</sup>

The general charts of Lakes Superior, Michigan, Huron, St. Clair, Erie, and Ontario. Charts of most parts of the shores of these lakes, on a much larger scale, are also published.

IV. *River Charts*

Charts 9, 13, 14, 18, 19, 20, and 27, and Index charts I, II, and III of the Mississippi River, issued by the Mississippi River Commission.<sup>3</sup> Students interested in any special portion of the Mississippi River will do well to get the charts for those regions. Similar charts are published for certain other large rivers, such as the Missouri, the Tennessee, etc.

<sup>1</sup> See foot-note, p. 203.

<sup>2</sup> Issued by the War Department, Washington, D. C.

<sup>3</sup> These maps may be purchased of the Mississippi River Commission, St. Louis, Mo.

## PART II

### CHAPTER XI

#### EARTH RELATIONS

**Form.** The form of the earth is very much like that of a sphere, but, since it is not exactly a sphere, it is generally said to be a spheroid. The form has been determined in various ways: (1) Ships have sailed quite around it. This proves that it is everywhere bounded by curved surfaces, though it does not prove that it is a sphere or even a spheroid, for, if it had the shape of an egg, it would be possible to sail around it. (2) It has been found that when vessels go to sea their lower parts disappear first. When a vessel has gone four miles, the lower five feet of its hull is out of sight to an observer on the shore, if his eye is five feet above the level of the sea. Similarly, when a vessel approaches land, its highest parts are seen first by observers on the land, while to observers on the vessel the high lands are seen first and the low ones later. From the vessel the spires and chimneys of houses appear before the roofs, and the roofs before the lower parts. These phenomena show only that the earth has a curved surface; but it is found that in whatever direction vessels sail, and from whatever port they start, objects on land disappear at about the same rate. This means that the curvature is *nearly the same in all directions*. A body whose curvature is *the same* in all directions is a sphere, and a body whose curvature is *nearly the same* in all directions is nearly a sphere. This is the condition of the earth. (3) Again, the earth sometimes gets directly between the sun and the moon. It then casts a shadow on the moon, and this shadow always appears to be circular, though its edges are not very clearly defined. (4) The direction of the plumb-line (the perpendicular to a horizontal surface on the earth) changes from point to point on the earth's surface, and it changes by an angle which is almost exactly proportional



to the distance between the points, wherever they are. If the change of direction were *exactly* proportional to the distance between two points, wherever taken, the earth would be a sphere (Fig. 513). Since it is only approximately true, the earth is only approximately spherical.

This point may be put in another way. The stars are very far from the earth. As one travels along the earth's surface, the

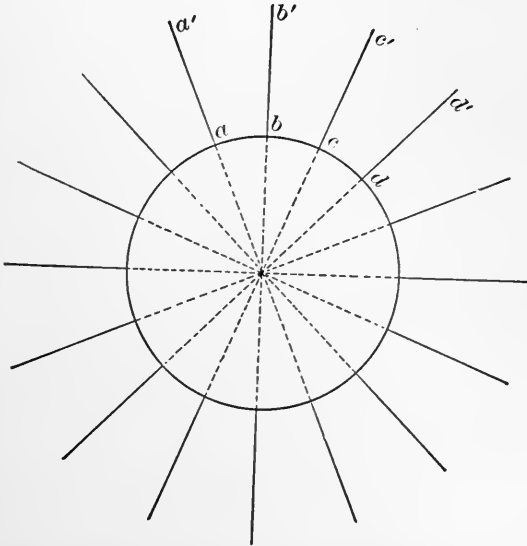

FIG. 513.—The circle represents the earth's circumference. The extensions of the radii represent the directions of the plumb-lines at various positions. The distance from  $a$  to  $b$  is the same as that from  $b$  to  $c$  and  $c$  to  $d$ , and the change in the direction of the plumb-line, that is, the angle between  $aa'$  and  $bb'$ , is essentially the same as that between  $bb'$  and  $cc'$ ,  $cc'$  and  $dd'$ , etc. This is true for all parts of the earth.

apparent directions of the stars change, and the angle of change is almost exactly proportional to the distance traveled, wherever the starting-point, and whatever the direction of travel.

The significance of this change in the position of the stars appears to have been correctly interpreted, in general terms at least, by certain Greek students (e.g., Thales of Miletus) as early as 640 B.C. The same idea appears to have been entertained at various subsequent times by individual students. Columbus recognized it in the statement: "I have always read that the

world, comprising the land and the water, is spherical, as testified by the investigations of Ptolemy and others, who have proved it by the eclipses of the moon and other observations made from east to west, as well as *by the elevation of the pole [pole star] from north to south.*"<sup>1</sup>

In these and other ways<sup>2</sup> it is known that the form of the earth does not depart greatly from that of a sphere.

**Size.** The circumference of the earth is nearly 25,000 miles, and its diameter nearly 8000 miles. Since the earth is not a perfect sphere, its various diameters and circumferences are not exactly equal. Its longest diameter is 7926.5 miles, and its shortest nearly 27 miles less (7899.7 miles). The shortest circumference is about 42 miles shorter than the longest.

The surface area of the earth is nearly 197,000,000 square miles, and its volume, exclusive of the atmosphere, about 260,000,000,000 cubic miles. The earth is between five and six times as heavy as an equal volume of water would be.

### *Motions*

The earth has two principal motions. These are (1) rotation, and (2) revolution around the sun. The earth rotates on its shortest diameter, which is called its *axis*. The ends of the axis of rotation are the *poles*; and the circumference midway between the poles is the *equator*. The equator is the longest circumference of the earth. The lines that pass from pole to pole on the earth's surface are *meridians*. All meridians converge at each pole. Meridians are parallel with one another at the equator, but nowhere else.

**Rotation.**—The rotation of the earth may be demonstrated by simple experiments. 1. If a body be dropped from a high tower, it does not fall so as to reach a point immediately beneath that from which it fell. Instead, it always falls a little to the east of the point from which it started. This is explained as follows: If the earth rotates, any point must move faster than any other point which is nearer its center, for the same reason that a point on the rim of a wheel moves faster than a point between the rim and the hub. If the earth be rotating, the top of a tower must

<sup>1</sup> Hakluyt Soc. Pub., *History of Columbus's Third Voyage*, Vol. II., p. 129.

<sup>2</sup> See Moulton's Introduction to Astronomy, pp. 114-124.

be moving forward faster than the bottom. In this case, the falling body, starting from the top of the tower, has a forward velocity greater than that possessed by the base of the tower. Under these circumstances, the falling body must gain on the base of the tower in the direction of rotation; that is, if the earth rotates to the east, the falling body would be farther to the east, relative to the tower, when it reached the ground than when it started. If the earth rotated to the west, the body would fall the other way. Since the body always falls to the east, and since nothing but the rotation of the earth to the east seems to explain this fact, it is taken to be a proof that the earth rotates

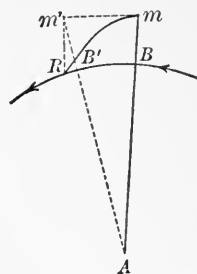
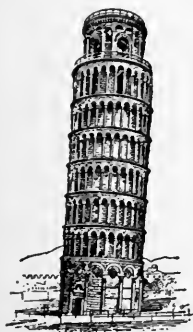

FIG. 514.—The leaning tower of Pisa, where some of Galileo's famous experiments on falling bodies were performed.

FIG. 515.—Figure to illustrate the effect of rotation on a falling body as explained in text.

in that direction. The actual deviation in our latitude is about one inch for 500 feet of fall.

Fig. 515 illustrates the principle involved in the falling body. Let  $AB$  = the earth's radius, and  $m$  a point on a tower (height greatly exaggerated) above the earth's surface. Suppose the mass  $m$  is dropped from the top. If the earth were not rotating, it would fall in the direction of the plumb-line, and would strike the surface at  $B$ . Suppose, however, the earth is rotating at such a rate that  $BA$  turns to  $B'A$  while  $m$  is falling to the surface. If it were not for the attraction of the earth,  $m$  would go in a straight line to  $m'$ . Gravitative attraction is at right angles to this line  $mm'$ , and, though it does not change the amount of motion of  $m$  in this direction, it impresses upon it a

new motion toward the earth. The result is that it describes the curved line  $mR$ , and strikes the earth at  $R$ , a little beyond the foot of the perpendicular  $m'B'$ .<sup>1</sup>

2. Another experiment, which shows the same thing, may be performed with a pendulum (known as *Foucault's pendulum*). If a pendulum attached to a ceiling is set swinging parallel to a given line on the earth's surface, as, for example, parallel to a line on the floor, it will be found a little later to be swinging in a plane which is not parallel to the original line. The pendulum changes its direction, with reference to the line along which it

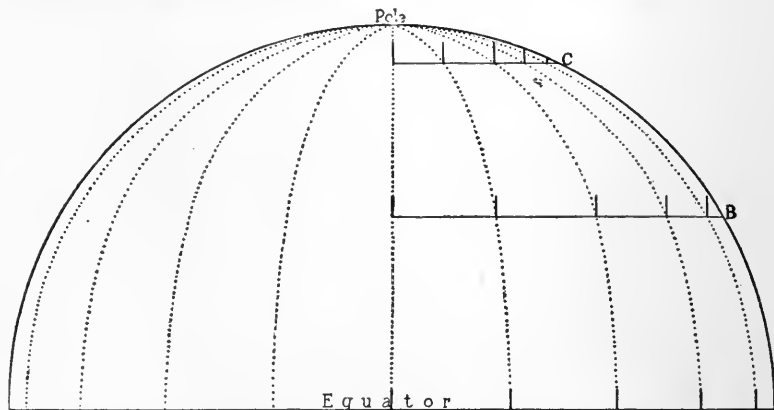

FIG. 516.—Diagram to illustrate the fact that the direction of the swing of the pendulum changes more rapidly in high latitudes than in low latitudes. A pendulum set swinging with the central meridian of the diagram, in different latitudes, will depart from the meridians, as shown at the right, in six hours. There is no departure at the equator, much in middle latitudes, and still more in high latitudes.

was started, more rapidly near the poles and less rapidly near the equator. If it could be set swinging along a meridian so that one end of the swing barely reached the pole, it would be found that the pendulum was swinging at right angles to that meridian after the earth had turned a quarter of the way around. This is illustrated by Fig. 516. If the pendulum were set swinging half-way between one of the poles and the equator, it would have departed from the plane in which it was started much less when the earth had turned a quarter of the way around. This is also

<sup>1</sup> Moulton's Introduction to Astronomy, pp. 148-149.

illustrated by Fig. 516. If the pendulum were set swinging at the equator so that half the swing was on either side of it, the swing would remain parallel with its original position (Fig. 516).

The departure of the pendulum, except at the equator, from the plane of the meridian in which it was set swinging is often said to mean that the meridian in the plane of which it first swung has changed its position, and in its new position it is not parallel to the position in which the pendulum started to swing. The pendulum itself continues to swing in its original plane, but this plane is no longer parallel to the meridian in its changed position. According to this statement, the pendulum *seems* to have changed its direction, because we determine direction by meridians, and the successive positions of a meridian on a spherical rotating body do not remain parallel with one another, except at the equator of the rotating body.

This change in the direction of the pendulum, which is universal except at the equator, is always in the same direction in the northern hemisphere, and always in the same direction in the southern hemisphere, and proves that the earth rotates. The change in the direction of the pendulum does not take place at the equator, so the explanation runs, because the meridians there are all parallel with one another and the successive positions of a given meridian therefore are all parallel. According to this statement of the case, the apparent change in the direction of swing of the pendulum takes place less rapidly midway between the equator and the poles than near the poles (Fig. 516), because the meridians are more nearly parallel with one another in the former position than in the latter.

If this were the full explanation of the matter, the swing of the pendulum should always be parallel to its original position at the end of 24 hours, whether the pendulum was near the equator or near the pole. This is not the case, and the above statement is therefore not an adequate explanation of the phenomenon. Though the dependence of the rate of variation of the direction of the pendulum's swing on latitude cannot be given here, it is well understood.

The form of the earth is consistent with its rotation, but can hardly be said to prove it. Any body which is not perfectly rigid (and no body is) would be somewhat flattened at its poles, and somewhat bulged at its equator, by rotating. This is the

condition of the earth, for the diameter between the poles is the shortest diameter, and the diameters in the plane of the equator are the longest. The amount of flattening which would result from rotation depends on (1) the rate of rotation, and (2) the rigidity of the body. The faster the rotation and the less rigid the body, the greater the polar flattening. There are other ways of proving that the earth rotates, but they need not be cited here.

The rate at which a point on the surface of the earth moves, as a result of rotation, varies greatly. Points on the equator move fastest, because they have farthest to go in the time of one complete rotation. At the equator, where the circumference is nearly 25,000 miles, a point moves nearly 25,000 miles a day, as a result of rotation. Half-way between the equator and either pole, a point moves about 17,600 miles per day, while at the poles the rate of motion resulting from rotation is zero.

**Effect of rotation.** The most obvious effect of rotation is the alternation of day and night, for one side of the earth and then the other is turned toward the sun during each rotation. But it is to be noted that the alternation of day and night does not of itself prove rotation. Day and night might be brought about equally well by the revolution of the sun around the earth each day. The period of rotation, 24 hours, determines the length of a day (day and night).

**Revolution.** The second principal motion of the earth is its revolution about the sun. No simple experiment can be cited to prove this motion; but the fact of revolution may be illustrated in various ways.

If the positions of individual stars be observed for long periods of time, they appear to describe small circuits each year. Some of the circuits are nearly circular and some are nearly straight lines. Some of them are larger and some smaller. This annual change in the apparent position of the stars is their *annual parallax*. Either the stars make this annual circuit, *and all of them in the same length of time*, or the earth makes a yearly circuit in space, which causes the apparent annual movement of the stars. The fact that these apparent circuits of the stars are all made in the same length of time makes it more probable that they are due to the motion of the earth, than that they are due to the individual motions of the stars themselves. The varying sizes of the apparent annual paths of the stars is accounted for by the fact that some of them

are nearer to the earth than others, and the nearer they are, the larger the annual circuits they appear to describe. The varying shapes of the annual paths would be accounted for by the directions of the stars, some being in a polar direction from the observer and some in an equatorial direction.

Various other physical and astronomical phenomena, which need not be cited here, also demonstrate that the earth makes an annual circuit around the sun.

The length of time which the earth requires to make its revolution about the sun determines the length of the year. It is a little more than 365 days.

The path of the earth around the sun is its *orbit*. The orbit of the earth is not a circle, but an ellipse (Fig. 517), and the sun is in one of the foci, more than 1,500,000 miles from the center of the ellipse. When the earth is nearest the sun, the distance between

FIG. 517.—The orbit of the earth is an ellipse, with the sun in one of the foci. Eccentricity of the orbit exaggerated 10 times; diameter of the sun exaggerated nearly 10 times; diameter of the earth exaggerated about 50 times.

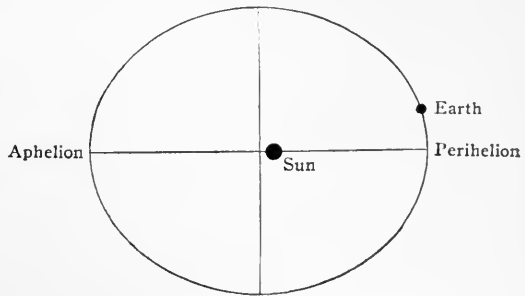

the earth and sun is more than 3,000,000 miles less than when they are farthest apart. It so happens that the earth is nearest (about 91,500,000 miles) the sun in the early winter (early in January) of the northern hemisphere, and farthest (about 94,500,000 miles) from it in early summer (early in July). The *perihelion* (nearest the sun) and *aphelion* (farthest from the sun) dates are subject to slow periodic change. The perihelion date in 4000 B.C. was September 21. It will be March 21 in 6590 A.D.

The motion of the earth through space during its revolution about the sun is at the rate of about 600,000,000 miles a year. This means that the earth travels about 1,600,000 miles daily, or about 66,666 miles hourly.

The earth's axis is inclined toward the plane of its orbit about  $23\frac{1}{2}^\circ$  (Fig. 518). This position of the axis, together with the

motions of the earth, have much to do with the distribution of the heat and light received from the sun, and so with the changes in the length of day (daylight) and night (darkness), and with the succession of the seasons. But, before attempting to see how

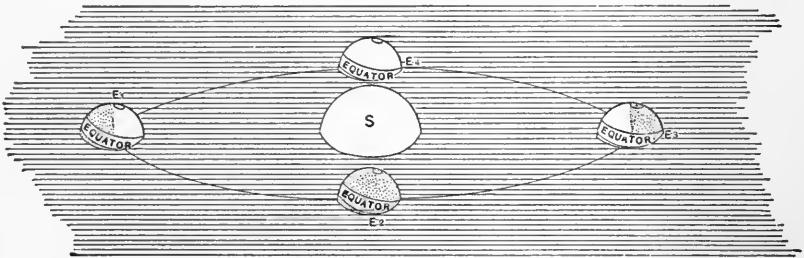

FIG. 518.—Diagram to show the effect of the inclination of the earth's axis upon the distribution of light, heat, etc., on the earth. The line-shading represents the plane of the earth's orbit. Half the earth is above this plane, but the plane does not cut the earth symmetrically with reference to the parallels. In the position  $E_1$  more than half the northern hemisphere is being heated and lighted. In position  $E_3$  less than half of the same hemisphere is heated and lighted. In positions  $E_2$  and  $E_4$  the half of the northern and of the southern hemispheres is being lighted and heated.

these changes are brought about, we must become familiar with certain terms which are to be used in the discussion of these changes.

### *Latitude, Longitude, and Time*

**Latitude.** The equator has been defined as the circle about the earth midway between the poles. Circles parallel to the equator are *parallels*. The number of parallels which might be drawn is infinite, though but a few are represented on maps. On maps of small scale parallels are drawn every  $5^\circ$  or  $10^\circ$ . On maps of large scale they are drawn for every  $1^\circ$  or  $2^\circ$ , or sometimes even for fractions of a degree. The length of parallels varies greatly, those near the equator being longer, and those near the poles shorter.

The planes of all parallels are perpendicular to the earth's axis, but no circle perpendicular to the axis, except the equator, is a great circle, for no other passes through the ends of a diameter of the earth. This is shown in Fig. 519, which represents the earth in two positions. In the left-hand part, the half of each parallel and meridian represented is shown. In the right-hand part, the relation of parallels to the North Pole is shown. The



distance between the equator and either pole is a *quadrant* (i.e., a quarter of a circle) and is divisible into 90 parts ( $90^\circ$ ) called *degrees*. The degrees are numbered from the equator to the poles. Each degree is divided into 60 parts ( $60'$ ) called *minutes*, and the minutes, like the degrees, are numbered from the equator toward the poles. Each minute is divided into 60 parts ( $60''$ ) called *seconds*, and the seconds are numbered in the same direction as the larger divisions. Distance north or south of the equator may therefore be indicated exactly by means of parallels. This distance is called *latitude*, the latitude of the equator being  $0^\circ$ .

In reality, *geographic latitude*, as distinct from *astronomic latitude* and *geodetic latitude*, is the angle between the plane of the equator, and the perpendicular to the standard spheroid at the place of observation. The angle is measured by the arc at the surface, and the length of the arc is commonly called the latitude.

If the latitude of a place is  $40^\circ 40' 40''$  N., its distance and its direction from the equator are accurately known; but, since the parallel of  $40^\circ 40' 40''$  runs quite around the earth, it is clear that the statement of the latitude of a place indicates only what parallel it is on, but not its position on that parallel.

**Longitude.** Position on a parallel is indicated by means of *meridians* (p. 484). The number of possible meridians is infinite, but, as in the case of parallels, only a few are commonly indicated on maps. One meridian, that passing through Greenwich, England, was long ago arbitrarily chosen as the meridian from which distances east and west are to be reckoned. This meridian is the meridian of zero degrees ( $0^\circ$ ). Distance east or west of this meridian is known as *longitude*. Places east of long.  $0^\circ$  are in *east longitude*, and those west of it are in *west longitude*. East and west longitude respectively are regarded as extending  $180^\circ$  from the meridian  $0^\circ$ ; that is, half-way around the earth. The degrees of longitude are divided into minutes and seconds, the same as the degrees of latitude.

The position of a place on the earth's surface may be absolutely fixed by means of meridians and parallels. If a place is in longitude  $30^\circ$  E., its distance east of the meridian  $0^\circ$  is known. If, at the same time, it is in latitude  $30^\circ$  N., it must be where the parallel of  $30^\circ$  N. crosses the meridian of  $30^\circ$  E. This gives its position on the earth's surface exactly.

Every meridian reaches each pole. It might seem therefore that each pole has all longitude. But longitude is distance east or west of the meridian  $0^\circ$ , and at the poles there is neither east nor west. At the north pole the only direction is south, and at the south pole the only direction is north. The poles therefore cannot be said to have longitude, since they are not east or west of the meridian of  $0^\circ$ .

**Longitude and time.** There is a definite relation between longitude and time. Since the earth turns through  $360^\circ$  in 24

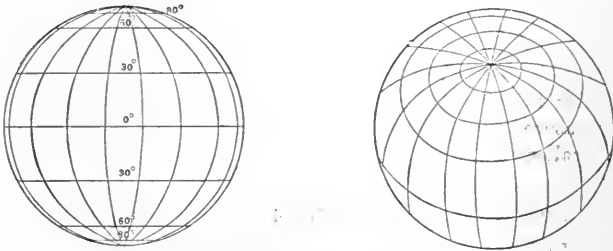

FIG. 519.—Parallels and meridians.

hours, it turns  $15^\circ$  in one hour, or  $15'$  of longitude in one minute of time. The sun therefore rises one hour earlier at a place in longitude  $0^\circ$  than at a place in the same latitude in longitude  $15^\circ$  W., and one hour later than at a place in the same latitude in longitude  $15^\circ$  E. Similarly, noon comes an hour earlier in longitude  $0^\circ$  than in longitude  $15^\circ$  W. and an hour later than in longitude  $15^\circ$  E. All places on a given meridian have noon and midnight at the same time, and such places are said to have the *same time*; but places on different meridians have different times. Thus, when places on the meridian of Chicago have noon, it is afternoon on meridians farther east, and before noon on meridians farther west. If the longitude of two places is known therefore, their difference of time may be readily calculated. Fig. 520 represents three cities on or near the parallel of  $40^\circ$ , and about  $15^\circ$  apart in longitude. On June 21 the sun would be  $73\frac{1}{2}^\circ$  above the horizon at noon in latitude  $40^\circ$ . Fig. 520 may be taken to represent noon at Philadelphia. At this hour the sun is not so high above the horizon at St. Louis, which is  $15^\circ$  farther west, and it is still lower at Denver, which is  $15^\circ$  farther west than St. Louis. After the earth has turned  $15^\circ$ , the sun will be  $73\frac{1}{2}^\circ$  above the horizon at St. Louis, while it will have become lower at Philadelphia and

higher at Denver. When the earth has turned  $15^\circ$  more (i.e., an hour later) the sun will be  $73\frac{1}{2}^\circ$  above the horizon at Denver. It will then be noon at Denver; an hour past noon at St. Louis, and two hours past noon at Philadelphia.

Though all places on a given meridian have noon and midnight at the same time, they do not always have sunrise and sunset at the same hour, for reasons which will appear later.

The variations of time with changes of longitude become apparent when long journeys are made either east or west. Thus a

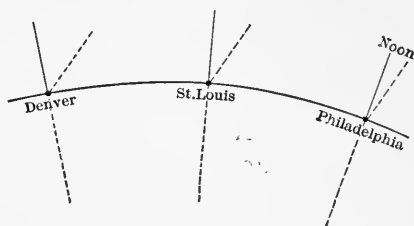

**FIG. 520.**—Diagram to illustrate the change in the altitude of the sun from hour to hour, in places in the same latitude. The diagram represents noon at Philadelphia at the time of the summer solstice. At this time the sun is there but a few degrees from the zenith, as represented by the dotted line. At St. Louis, in about the same latitude, but farther west, the sun is much farther from the zenith at the same hour; but when the noon hour arrives at St. Louis the sun will be as near the zenith there as it is at Philadelphia in the diagram. At Denver, which is still farther west than St. Louis, the sun is farther from the zenith than at St. Louis at the noon hour of Philadelphia. When it is noon at St. Louis the sun will be as far from the zenith at Denver as it is in the diagram at St. Louis. At this hour the sun will be about equally distant from the zenith at Denver and at Philadelphia, but at Philadelphia it will be west of south and at Denver east of south. When it is noon at Denver the sun will be as near the zenith there as it is in the diagram at Philadelphia, and the position of the sun in St. Louis will be as far from the zenith as it is in the diagram, but the sun will be west of south instead of east of south.

watch which has the correct local time in New York has not the correct local time when it is carried to Chicago. To avoid the difficulties of timekeeping growing out of travel, railroads have adopted a system of standard time. Under this system the country is divided into north-south belts, about  $15^\circ$  wide, and all places in each belt use the time which is correct for the central meridian of that belt. The railway time in adjacent belts differs by one hour. By this system, the clocks and watches do not show correct *local* time anywhere except on the central meridians of each belt. Fig. 521 shows the standard-time zones.

**Lengths of degrees.** The length of a degree of longitude, as measured on the surface of the earth, is the  $\frac{1}{360}$  part of a parallel. Since the parallels are very much shorter near the poles than near the equator, the length of a degree of longitude varies with the latitude. At the poles, where the length of the parallel becomes zero, the length of a degree of longitude also becomes zero. At the equator the length of a degree of longitude is 69.652 miles; in latitude  $30^\circ$ , 59.955 miles; and in latitude  $60^\circ$ , 34.914 miles.

Degrees of latitude are measured along meridians. They also vary in length. The length of a degree of latitude has been measured in several places. In India it is about  $68\frac{3}{4}$  miles, while in Sweden, the most northerly point where it has been measured, it is  $69\frac{1}{4}$  miles. At the poles, it is calculated that it must be about  $69\frac{4}{10}$  miles. In the United States, the average length is about 69 miles. The lengths of degrees of latitude and longitude in certain selected latitudes, are shown in the following table:

<i>Latitude.</i>		<i>Longitude.</i>
In latitude $0^\circ$ ,	$1^\circ = 68.704$ miles.	69.172 miles.
“ “ $30^\circ$ ,	$1^\circ = 68.881$ “	59.956 “
“ “ $45^\circ$ ,	$1^\circ = 69.054$ “	48.995 “
“ “ $60^\circ$ ,	$1^\circ = 69.230$ “	34.674 “
“ “ $90^\circ$ ,	$1^\circ = 69.407$ “	0.000 “

All measurements which have been made show that the length of a degree of latitude increases as the poles are approached. In other words, the nearer the pole the longer the degree of latitude, or, more strictly, the longer the arc which subtends a degree. This means that the earth is flattened at the poles.

That this is the meaning of the variation in the length of the degree is shown by Figs. 522 and 523. In the study of Fig. 522 it is to be remembered that a degree is  $\frac{1}{360}$  of the angular distance about a point, and, measured on a circumference, it is the  $\frac{1}{360}$  part of the circumference described about the point from which the angle is measured. Since the degree is longer in high latitudes than in low, it means that the arc on which it is measured is *the arc of a larger circle* than that on which the degree in low latitudes is measured. The  $\frac{1}{360}$  of a larger circumference is longer than the  $\frac{1}{360}$  part of a smaller circumference. Thus, the distance on the circumference between  $0^\circ$  and  $18^\circ$  is much less than that between

$72^\circ$  and  $90^\circ (=18^\circ)$ . In other words, the center of the circumference on which a high-latitude degree is measured, is not the same as the center from which a low-latitude degree is measured (Fig. 522).

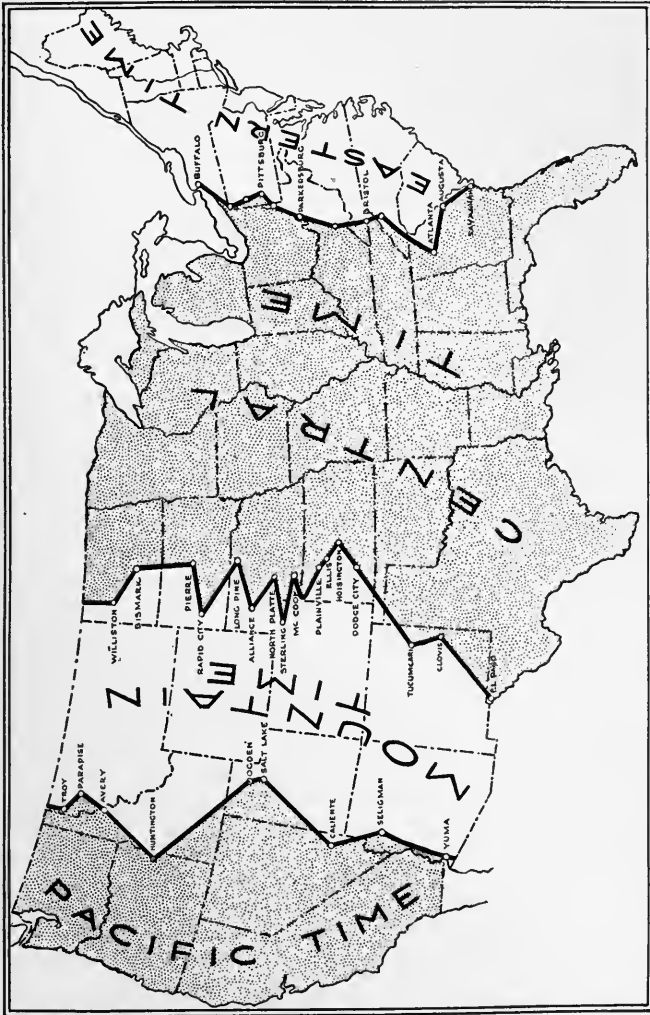

Fig. 521.—Map showing the standard-time zones now in use in the United States.

Fig. 523 shows the same thing in another way. The oblate curve *S* represents a meridional section of the earth, with the flattening greatly exaggerated. Circle *C* coincides with *S* at the equa-

tor *E*, while the circle *M* coincides with it at one pole, *P*. A degree of arc on the curve *S* near *P* is about as long as a degree on *M*,

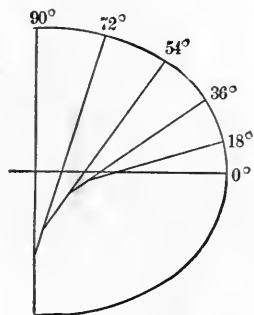

FIG. 522.

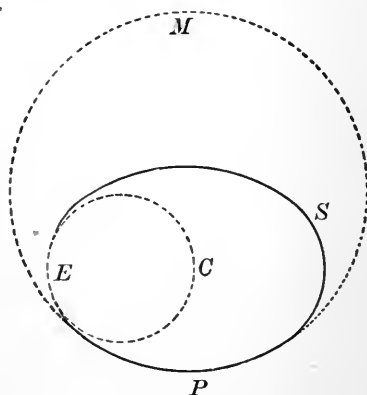

FIG. 523.

FIG. 522.—Figure to illustrate the fact that the longer degrees of latitude toward the poles means polar flattening. The curve is the half of a spheroid, more oblate than the earth is. The radiating lines are represented as  $18^\circ$  apart; that is, the distance from  $0^\circ$  to  $18^\circ$  is  $18/360$  of the circle of which this arc is a part. Similarly the distance from  $18^\circ$  to  $36^\circ$  is  $18/360$  of the circumference of which this curve is an arc, and so on. The curve between  $72^\circ$  and  $90^\circ$  is much longer than the curve between  $0^\circ$  and  $18^\circ$ .

FIG. 523.—The curve *S* represents a meridian section of the earth (the flattening being greatly exaggerated). The circle *C* coincides with *S* near the equator *E*, and the larger circle *M* coincides with it near the pole. A degree of arc on *S* near *P* is of about the same length as one on *M*, while one on *S* near *E* is of about the same length as one on *C*. Since the circle *M* is larger than the circle *C*, a degree on *S* near *P* is longer than one near *E*.

while a degree of arc on *S* near *E* is about as long as a degree on *C*. A degree of arc on *M* is clearly much longer than a degree on *C*.

The actual measurement of the length of a degree of latitude is a difficult matter, but the principle on which it is measured is easily understood. At any given point in the northern hemisphere the north star is a certain number of degrees above the horizon. When the observer, starting from a given point, has gone directly northward until the star appears one degree higher above the horizon at the corresponding hour, he has gone one degree (Fig. 524). In practice, the measurement is complicated, because the surface of the land is always somewhat uneven, and allowance must be made for every irregularity. A line measured along the uneven land surface would be too long. Again, the degree is to be measured at sea-level. The land is above sea-level, and therefore the measurement on the land surface must

be corrected, not only for all unevennesses, but for its elevation above sea-level.

**Inclination of axis and its effects.** The sun's rays illuminate one-half of the earth all the time. The border of the illuminated



FIG. 524.—Diagram to illustrate the way in which a degree of latitude is measured. When the observer has traveled so far along the surface that the position of the pole-star has changed  $1^\circ$ , the distance between the two stations, *A* and *B*, is a degree.

half is called the *circle of illumination* (Fig. 525). All places within the circle of illumination have day, while all places outside it have night. If the axis about which the earth rotates were perpendicular to the plane in which the earth revolves about the sun, the circle of illumination would always pass through the poles. Under these conditions the half of each parallel would be

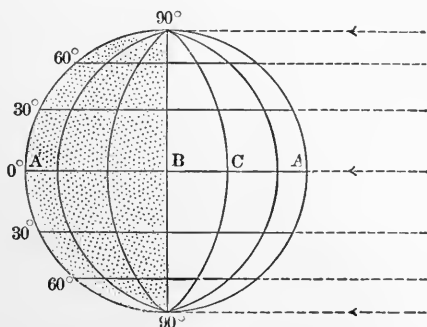

FIG. 525.—Diagram to illustrate the fact that half of the earth is illuminated by the sun at any one time. The line between the illuminated half and the half which is not illuminated, is the *circle of illumination*.

illuminated all the time. If the half of each parallel was constantly illuminated, the days and nights on each parallel would be equal, for it takes just as long for a place at *A* (Fig. 525) to move to *B* (half of a day) as for it to move from *B* to *A'* (half of a night).

If, then, the axis of the earth were perpendicular to the plane of its orbit, days and nights would always be equal everywhere.

Since days and nights are not equal at all seasons on most parts of the earth, it follows that the axis on which the earth rotates is not perpendicular to the plane of its orbit.

Again, if the earth rotated on an axis perpendicular to the plane of its orbit, the sun's rays would always fall on a given place at the same angle at the same hour of the day. Thus at *A*, Fig. 525, the sun's rays would fall vertically at noon; while at the same hour (noon at *A*) they would fall at a lesser angle at *C*; but the angles of the rays at *A*, *C*, and *B* would always be the same at the same hour of the day, in whatever part of its orbit the earth found itself. The same relations would hold for points on all parallels. Now, the sun's rays do not fall at the same angle at the same place at the same hour at all times of the year. In middle northern latitudes, for example, the sun is much higher above the horizon at noon in summer than in winter. This variation of the angle at which the sun's rays strike the earth at a given time and place, as well as the unequal lengths of days and nights in most places, is the result of the inclination of the axis on which the earth rotates as it revolves around the sun. The position of the axis is essentially constant throughout the year, and though its changes are more considerable in long periods of time they may be disregarded when short periods are concerned.

The effect of the inclination of the axis is illustrated by Fig. 526, which represents the earth in four positions in its orbit. In the position marked March 21, the half of each parallel is illuminated. At this time, therefore, days and nights are equal everywhere. In the position marked June 21, more than half of all the parallels of the northern hemisphere are illuminated, and there the days are more than 12 hours long and the nights correspondingly shorter. In the southern hemisphere the nights are longer than the days. In the third position, September 22, the days and nights are again equal everywhere, for the circle of illumination bisects every parallel. In the fourth position, December 22, more than half of each parallel in the southern hemisphere is within the circle of illumination, and there the days are longer than the nights, while in the northern hemisphere the nights are longer than the days. Twice during the year, therefore, on March 21 and September 22, the days and nights are equal everywhere. These times



are known as the *equinoxes*. The equinox in March is the *vernal* equinox, and that in September is the *autumnal* equinox.

When the earth is in the relation to the sun shown in the position marked June 21, Fig. 526, the days are longest in the northern hemisphere, and the rays of the sun fall perpendicularly on the surface of the earth farther north (in lat.  $23^{\circ} 27\frac{1}{2}'$ ) than at any other time. This is the *summer solstice*. The *winter solstice* occurs six months later, when the sun's rays strike the earth vertically  $23\frac{1}{2}^{\circ}$  (nearly) south of the equator, and when the days of the southern hemisphere are longest and those of the northern shortest. The

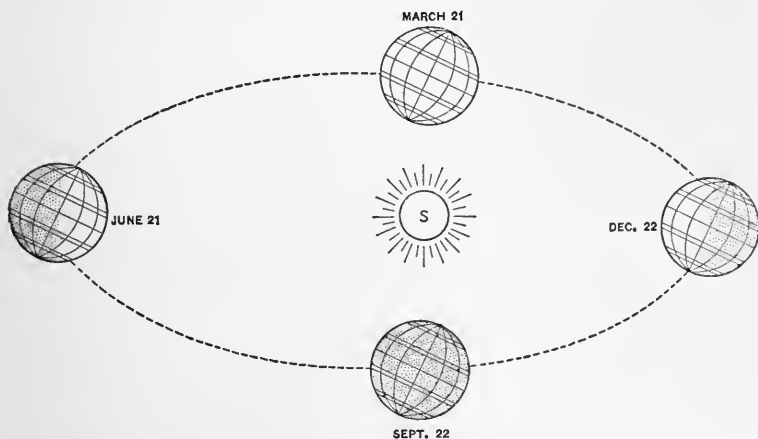

FIG. 526.—Diagram showing the position of the earth and of its illumination at the solstices and equinoxes.

distribution of light and the relative lengths of day and night in various latitudes are further shown for the solstitial dates by Figs. 527 and 528.

These figures also show that the *days and nights are always equal at the equator*, since the equator is always bisected by the circle of illumination (Figs. 527, 528, and 536). *Days and nights are not always equal in any other latitude*, unless at the poles, where there is one day of six months and one night of six months, each year.

**Apparent motion of the sun.** The effect of the inclination of the axis of the earth is to *make the sun appear to move north and south* once during each revolution of the earth about the sun. The effect on the earth is illustrated by Fig. 529. That is, the revolution of the earth about the sun, while it rotates on an axis in-

clined toward the plane of its orbit, makes the sun *appear* to move from a place where his rays are vertical  $23\frac{1}{2}^{\circ}$  (nearly) north of the equator (direction *S*, Fig. 529), to a place where they are vertical

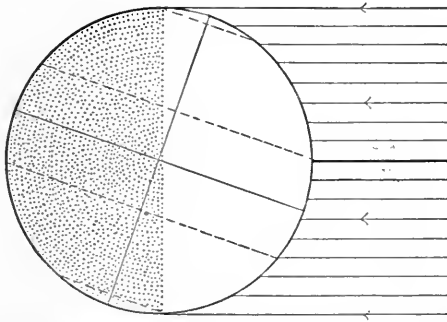

FIG. 527.—Diagram to illustrate the effect of inclination of the earth's axis on the length of day and night. In the figure, more than half of every parallel of the northern hemisphere is illuminated. The days are therefore more than twelve hours long, and the nights less, since the half of each parallel is the measure of  $180^{\circ}$  of longitude, and  $180^{\circ}$  of longitude corresponds to twelve hours of time. Similarly less than half of every parallel of the southern hemisphere is illuminated, and the nights are therefore more than twelve hours long.

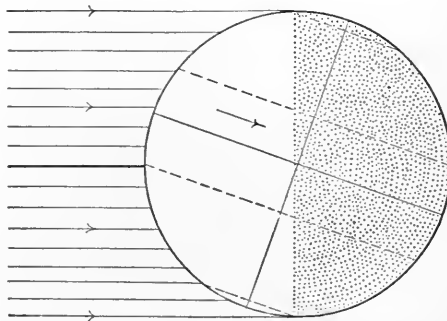

FIG. 528.—The relation of the earth to the sun's rays at a time six months later than that represented in Fig. 527. The conditions of day and night in the hemispheres are reversed.

$23\frac{1}{2}^{\circ}$  (nearly) south of the equator (direction *W*), and back again, in one year.<sup>1</sup> The result, so far as the earth is concerned, is as

<sup>1</sup> The inclination of the earth's axis is not quite constant. Its present inclination (1908) is  $23^{\circ} 27' 4.5''$ . Three thousand years ago its inclination was about  $23^{\circ}$ . The extreme variation possible is  $2^{\circ} 37'$ .

if the sun moved from *S*, which corresponds to the time of the summer solstice, to *A*, which corresponds to the time of the autumn equinox, to *W*, which corresponds to the time of the winter solstice, then back again to *Sp*, which corresponds to the spring equinox, and to *S*, while the earth is making one circuit about the sun.

When the sun is vertical in latitudes north of *Sp*, the days are longer than the nights in the northern hemisphere, and the sun's rays strike the surface in the northern hemisphere less obliquely than they do in the southern hemisphere. When the sun is in the position *Sp*, days and nights are equal everywhere, and when the

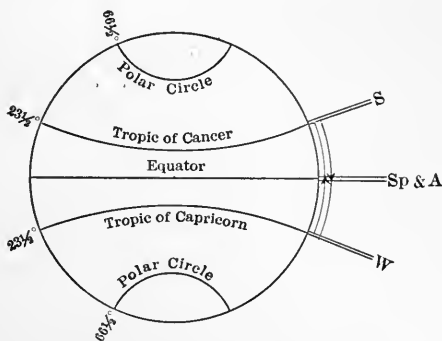

FIG. 529.—The inclination of the earth's axis, as it revolves about the sun, makes the sun appear to travel north and south. The sun is vertical at the equator on the 21st of March (*Sp.*), then appears to move northward until it is vertical  $23\frac{1}{2}^{\circ}$  north of the equator (*S*), then appears to move southward until it is vertical again at the equator (*A*), then south until it is vertical  $23\frac{1}{2}^{\circ}$  south of the equator (*W.*), and then north again until it is vertical at the equator. These changes are accomplished in the course of one year as a result of the revolution.

sun is vertical south of *Sp*, days are longer than nights in the southern hemisphere, and the sun's rays are more nearly vertical than in the northern hemisphere.

The northernmost parallel where the sun's rays are ever vertical is called the *tropic of Cancer*. The corresponding southernmost parallel is the *tropic of Capricorn*. The tropics are nearly  $23\frac{1}{2}^{\circ}$  ( $23^{\circ} 27'$ ) from the equator, because the axis of the earth is inclined by that amount toward the plane of its orbit. The sun is vertical at the tropic of Cancer at the time of the summer solstice, and at the tropic of Capricorn at the time of the winter solstice. The parallels just touched by the circle of illumination at the time of the

solstices are the *polar circles*. They are as far from the poles as the tropics are from the equator. They are, therefore, in latitude about  $66\frac{1}{2}^{\circ}$  ( $66^{\circ} 33'$ ). The one in north latitude is the *Arctic circle*, and the one in south latitude the *Antarctic circle*.

The effects of inclination of the earth's axis on the length of days and nights may well be emphasized by comparing the lengths of days and nights as they now exist, in our own region, with those which would exist if the axis of the earth were inclined  $45^{\circ}$  toward the plane of its orbit instead of  $23\frac{1}{2}^{\circ}$ . It is also instructive to study the conditions which would exist with reference to day and night (1) if the earth did not rotate during its revolution around the sun, and (2) if it rotated once in the period of its revolution. In the latter case, the results depend on the *direction* of rotation.

**Latitude and sun altitude.** The solution of certain problems in the determination of latitude and sun altitude will help to a clearer understanding of the changes in the relations of sun and earth due to the movements of the latter.

At the time of equinox, the sun is directly overhead at the equator at noon. One degree north of the equator, i.e., in latitude  $1^{\circ}$  N., the sun will appear  $1^{\circ}$  from the *zenith* (i.e., the point directly overhead) at noon, or  $89^{\circ}$  above the horizon. This is the same as saying that the *altitude of the sun* is  $89^{\circ}$ . Five degrees north of the equator (lat.  $5^{\circ}$  N.) the sun will appear  $5^{\circ}$  from the *zenith* at noon, and his altitude (above the horizon) is  $85^{\circ}$ .

If, therefore, the altitude of the sun at a given place at noon at the time of an equinox is known, the latitude may be determined. Thus if the altitude of the sun is  $30^{\circ}$  at the time of an equinox, the observer must be  $60^{\circ}$  from the place where it is vertical, that is, in latitude  $60^{\circ}$  N. or  $60^{\circ}$  S. Similarly if the latitude is known, the altitude of the sun at noon at the time of equinox may be determined. Thus in latitude  $40^{\circ}$  the sun must be  $50^{\circ}$  above the horizon at noon, for latitude  $40^{\circ}$  is  $40^{\circ}$  from the place where the sun is vertical.

Any other dates besides the equinoxes may be used if the latitude where the sun is vertical is known. Thus at the time of the summer solstice, when the sun is vertical in latitude  $23\frac{1}{2}^{\circ}$  N., it is  $23\frac{1}{2}^{\circ}$  from the zenith, or has a noon altitude of  $66\frac{1}{2}^{\circ}$ , at the equator. It has the same altitude in latitude  $47^{\circ}$  N., for this place, like the equator, is  $23\frac{1}{2}^{\circ}$  from the place where the sun is vertical.

Reversing the problem, we may determine the latitude of a

place if we know the noonday altitude of the sun there, and the latitude where the noonday sun is then in the zenith. Suppose, for example, the altitude of the sun is  $40^\circ$  at noon at the time of the June solstice, what is the latitude of the place? Since the altitude of the sun is  $40^\circ$ , the place must be  $50^\circ$  from the place where the sun is vertical, that is,  $50^\circ$  from latitude  $23\frac{1}{2}^\circ$  N. This is  $73\frac{1}{2}^\circ$  N. or  $26\frac{1}{2}^\circ$  S.

### Problems.

*Note.* In the solution of these problems the student will find it helpful, in many cases, to make diagrams representing the conditions of the problem.

1. What is the altitude of the sun at noon at the time of an equinox,

(1) In latitude  $50^\circ$  N.?

(2) In latitude  $50^\circ$  S.?

(3) In latitude  $75^\circ$ ?

2. What is the altitude of the sun at noon at the time of the summer solstice,

(1) In latitude  $30^\circ$  N.?

(2) In latitude  $30^\circ$  S.?

(3) In the latitude of New York?

(4) In the latitude of Vancouver?

(5) In latitude  $75^\circ$  N.?

(6) In latitude  $66\frac{1}{2}^\circ$  S.?

(7) At the north pole?

3. Formulate a rule for finding the altitude of the sun (*a*) at the time of an equinox, and (*b*) at the time of a solstice, the latitude of the place being given.

4. In what latitude or latitudes is the sun  $30^\circ$  above the horizon at noon at the time of an equinox?

5. In what latitude or latitudes is the sun  $75^\circ$  above the horizon at noon at the time of an equinox?

6. In what latitude or latitudes is the sun  $40^\circ$  above the horizon at noon at the time of the June solstice?

7. In what latitude or latitudes is the sun  $80^\circ$  above the horizon at noon at the time of the December solstice?

8. What is the latitude of the place or places where the sun is  $10^\circ$  above the horizon at noon at the time of the June solstice?

9. Formulate a rule for finding the latitude of a place from the noon altitude of the sun.

10. In what direction and at what altitude would the sun appear (*a*) at midnight, and (*b*) at noon, to an observer in latitude  $75^\circ$  N. at the time of the summer solstice? See 2 (5) above.

11. To an observer at the equator, in what direction would the sun appear to rise on June 21? What would be the noon altitude of the sun at the equator on the same day?

12. What would be the noon altitude of the sun at Chicago on June 21? On December 21?

13. In what latitude is the altitude of the sun the same, at noon, at the time of an equinox and on June 21?

### *The Solar System*

The solar system includes the sun and all the bodies which revolve about it. There are eight planets, of which the earth is one. Named in the order of their distance from the sun, commencing with the nearest, the planets are: Mercury, Venus, Earth, Mars, Jupiter, Saturn, Uranus, and Neptune. Most of the planets have satellites corresponding to our moon. The following table shows some of the more important facts about the planets:

	Diameters in Miles.	Volume Earth = 1.	Mass Sun = 1.	Density Water = 1.	Mean Distance from Sun in Million Miles.	Sidereal Period in Years.	Inclination of Orbit to Ecliptic.	Number of Satellites.
Mercury. ...	2,765	0.05	$\frac{1}{9,647,000}$	3.70	36.0	0.24	7° 0'	0
Venus . . . . .	7,826	0.89	$\frac{1}{405,000}$	4.89	67.2	0.62	3 24	0
Earth . . . . .	{ 7,926.5* 7,899.7†	1.00	$\frac{1}{332,000}$	5.53	92.9	1.00	0 0	1
Mars. . . . .	{ 4,352* 4,312†	0.14	$\frac{1}{3,020,000}$	3.95	141.5	1.88	1 51	2
Jupiter. . . . .	{ 90,190* 84,570†	1264.00	$\frac{1}{1,047}$	1.33	483.3	11.86	1 19	7
Saturn. . . . .	{ 76,470* 69,780†	759.00	$\frac{1}{3,502}$	0.72	886.0	29.46	2 30	10
Uranus. . . . .	34,900	63.40	$\frac{1}{22,760}$	1.22	1781.9	84.02	0 46	4
Neptune. . . . .	32,900	82.30	$\frac{1}{19,500}$	1.11	2791.6	164.78	1 47	1

\* Equatorial.

† Polar.

Besides the planets and their satellites, the solar system includes numerous (more than 400) *asteroids*, bodies much smaller than the planets, intermediate in position between Mars and Jupiter, and those *comets* which revolve about the sun. These bodies have little influence on the earth, and nothing further need be said of them in this place.

## REFERENCES

Text-books on Astronomy. Among the available recent ones are Moulton's (Macmillan) and Comstock's (Appleton). Todd's (Am. Book Co.) and Young's (Ginn & Co.) are less recent, but serviceable; also Johnson's *Mathematical Geography* (Am. Book Co.).

# PART III

## THE ATMOSPHERE

### CHAPTER XII

#### GENERAL CONCEPTION OF THE ATMOSPHERE

**Substantiality.** When the atmosphere is still, we are hardly conscious of its existence. We walk through it without realizing that we are forcing our way through a real substance. Compared with land or even with water, it seems most unsubstantial. But when the air is in motion, that is, when the wind blows, we are conscious that it is very real and substantial, for the force of the wind may be so great that it is difficult to stand or walk against it. Trees and buildings are occasionally blown down by it, and quantities of dust and sand are picked up and sometimes carried up to great heights. These familiar phenomena show that the air is a real substance, and that, when it moves rapidly, even strong objects give way before it.

A strong wind is not equally strong at every instant; it comes in gusts. When a strong gust of wind strikes a high building, the air is reflected from the wall, somewhat as a ball is when thrown against it. If a strong gust of wind is followed the next instant by a weak wind or a lull, the air rebounding from the wall may have great force in a direction opposed to that of the main wind. These reflected winds occasionally blow people down, for they blow in the direction opposite to that against which the body is braced. In cities where there are high buildings, the streets are sometimes protected from the direct winds; but the currents of air, whether direct or reflected, are often concentrated at the street level, where they sometimes have force enough to overturn cabs.

The substantiality of the air may be shown in still another way. If the air be pumped out of a cylinder whose top is covered by a thin piece of rubber, the rubber cover is pressed down into the



cylinder, and may even be broken. The force which presses it down is the weight of the air above. If the cylinder be of weak material, such as thin glass, while the cover is strong, the pressure of the air outside may burst the cylinder when the air inside is pumped out. The cylinder does not break when full of air, because the pressure on the inside balances that on the outside. If the cylinder be of tin instead of glass, the pressure of the air on the outside may bend in its walls when the air is pumped out. These experiments, as well as the phenomena of the wind, show that the air is something real and that it has weight.

The amount of pressure which the air exerts, that is, its weight, may be determined. At sea-level, it is found to be nearly 15 (14.7) pounds to the square inch.

**Relation to the rest of the earth.** The atmosphere is commonly called an envelope of the earth. More properly it is *an envelope of the rest of the earth*, for it is itself as much a part of the earth as the rocks are. It goes with the rest of the earth through space, and it is essential to the life of the earth and to most of the processes which are in operation on the earth's surface. It is the medium through which moisture is distributed, and it has much to do with the temperature of the earth, for without an atmosphere the earth would be very much colder than now. Without the air, therefore, the earth would be a very different body. Some conception of its functions may be gained by trying to conceive what the earth would be without it. This point may be recalled from time to time, as our study proceeds.

The atmosphere is in reality a little more than an envelope of the rest of the earth, for it penetrates the soil and rocks as far down as there are holes and cracks, and its constituents are dissolved in the waters of the sea, in all the waters on the land, and in all the waters beneath its surface.

**Density and altitude.** Many of the laws which govern the distribution of gaseous matter are known. From these laws it is known that the air, which is but a mixture of gases, must be most dense below and less dense above. This is the same as saying that there is more air in a cubic foot of space at sea-level than in a cubic foot of space at higher levels. To this general rule there are exceptions, locally and temporarily, but they need not be considered here. Similarly there is more air in a cubic foot of space 1000 feet above sea-level than in the same space 2000 feet above

sea-level, and so on. This means that the particles of which gases are composed are nearer together at low altitudes than at high altitudes. The reason is readily understood.

If a cubic foot of air were pressed from all sides, it could be squeezed into a smaller space, and the more the pressure, the smaller the space into which it could be compressed. Now at the bottom of the atmosphere the air is pressed down by all the air above. At the height of 1000 feet above the sea, the air is pressed down by all the air above that level, and so on. Hence the lowest air is under most pressure, and is therefore (with certain exceptions) densest.

It is largely because the air gets rarer with increase of altitude that mountain-climbing is difficult. As the climber gets higher and higher, it becomes more and more difficult to breathe. He may take in the same number of cubic inches of air each time he inhales, but each cubic inch contains less air the higher he goes. Finally the air gets so rare as to stop further ascent. It should be noted, however, that it is not simply the decreasing amount of air taken into the lungs which makes it difficult to ascend to great heights. The cold, the snow and ice, and often the very steep slopes of high altitudes, are all obstacles, and the body is not adjusted to the lessened pressures of the higher altitudes.

**Height.** How high above the sea and land does the air extend? No positive answer can be given to this question, though something is known about it.

1. The greatest altitude reached by any mountain-climber is between four and five miles. At this altitude there was air enough to make breathing possible to one exercising actively. A considerable quantity of air, therefore, exists at a height of more than four miles. Its upper limit must be considerably higher.

2. Men have ascended to heights of over six miles in balloons, and in one case (Coxwell and Glaisher, 1862) to a height of more than seven miles. In some cases the occupants of the balloons have become unconscious at an elevation of about 29,000 feet, but in one case (Dr. Berson, Berlin, 1894) this difficulty was overcome by carrying oxygen for breathing. Balloons without human occupants have risen eighteen miles. At the upper limit of their ascent, the air was still dense enough so that the amount displaced by the balloon was at least equal to the weight of the balloon.

3. From the phenomena of twilight, due to the refraction of the light as it passes through the atmosphere, it may be demonstrated that the air extends up to a height of forty-five miles.

4. On almost any clear night "shooting stars" may be seen. These shooting stars, or *meteors*, are small solid bodies which come into the earth's atmosphere from outside space. When they enter the atmosphere, they are very cold, for the temperature of space, outside the earth's atmosphere, is believed to be about  $-459^{\circ}$  F. As they approach the earth, they are traveling (falling) very fast, say 12 to 45 miles per second. In passing through the atmosphere, their movement is resisted by the air. The result is friction, and the friction with the air heats them. When they get hot enough to glow (red-hot), they may be seen. Now the height at which they begin to glow has been estimated in some cases, and is found to be, at a maximum, more than 100 miles above sea-level. This shows that the atmosphere is *much more than 100 miles high, for the meteors must have come through the rare, cold upper air a very considerable distance before becoming red-hot.*

5. The aurora or "northern lights" sometimes seen in high latitudes is believed to be an electric phenomenon in very rare air. The height of the aurora is sometimes more than 100 miles. The southern ends of the streamers have even been calculated to be as much as 400 miles high. This shows that the air is dense enough to show electric phenomena at that height. It is believed, however, that the density of the air 100 miles above sea-level is not much more than one billionth of its density at sea-level.

6. We know the weight of the atmosphere. We know also the rate at which a gas, or a mixture of gases, like the air gets lighter with increase of altitude. The law is that the density is proportional to the pressure. If we go up till half the air is below us, the air at that height should be half as dense as it was at the bottom. If we rise again until half of the upper half of the air is below us, the air at that level is half as dense as it was at the first station. On this principle it would appear that there should be no upper limit; the air should simply get rarer and rarer without having a definite upper surface.

Though the above law holds in all places where experiments can be carried on, there is some reason to believe that it may cease to hold when the air becomes very rare.

7. All gases have a tendency to fly away from the earth, but

are held by gravity. Gravity gets weaker and weaker with increasing distance from the earth's center, and, at a sufficiently great distance from the center, the earth would not be able to hold any of the gases of its atmosphere. That distance would be less for lighter gases, and greater for heavy ones. It is calculated that none of the gases of the atmosphere could be held by the earth at a distance greater than 620,000 miles from the center of the earth.

From the above considerations it appears to be certain that the air extends much more than 100 miles above the rest of the earth, but how much more is unknown. Whatever its height, one-half the atmosphere (by weight) lies below a plane about 3.6 miles above sea-level, three-fourths of it below a plane 6.8 miles above the same level, and seven-eighths of it below a plane 10.2 miles up. The highest mountain is about 6 miles high, so that nearly three-fourths of the atmosphere lies below the level of its top.

**Volume.** Since the height of the air is not known, its volume cannot be determined. If it extends up but 200 miles, its volume is about one-sixth that of the rest of the earth; if it extends up 500 miles, its volume is nearly one-half that of the rest of the earth.

**Mass.** Great as is the volume of the atmosphere, its mass (measured by its weight) is far less than that of the solid part of the earth, or even than that of the water. It has been estimated at about  $\frac{1}{270}$  that of the water, and about  $\frac{1}{12000000}$  that of the solid part of the earth. Its weight is about equal to that of a layer of water completely covering the earth to a depth of 33 feet. Sir John Herschel estimated the weight of the air resting on the other parts of the earth at  $11\frac{2}{3}$  trillion pounds.

**History.** It is probable that the atmosphere has undergone changes in mass and volume in the course of its history. It was formerly assumed that the atmosphere is being gradually diminished, and that it would in time disappear, as the moon's atmosphere was assumed to have disappeared. But this assumption does not appear to be well founded. It is more probable that the moon never had an atmosphere, than that it has lost one it once had. Furthermore, the atmosphere is now gaining various gases from volcanic and other vents (p. 368), and probably has always done so. It is probably acquiring gases from space also. Though contributions from this source are inconsiderable now, they may not always have been so. The atmosphere is losing as well as gaining. Some gases, especially light ones like hydrogen, prob-

ably escape the attractive control of the earth and pass off into space. Other constituents of the air, like oxygen (p. 72) and carbonic acid, are withdrawn from the air and locked up for long periods at least, if not permanently, in the rocks. The rates both of supply and loss fluctuate. When loss exceeds supply, the mass of the atmosphere must decrease; when supply exceeds loss, the mass must increase. So far as can be judged from present phenomena, slight fluctuations of mass must have taken place. As will be seen in the next chapter, the fluctuations in composition may have been more significant than the fluctuations of mass and volume.

## REFERENCES

The following references apply to Chapters XII to XIX. Numbers 1 to 5 are the most serviceable for the general student; Number 13 is helpful for the topic indicated by the title, and 14 is constantly valuable.

1. DAVIS, *Elementary Meteorology*: Ginn & Co.
2. WALDO, *Elementary Meteorology*: Am. Bk. Co.; *Modern Meteorology*: Scribners.
3. BARTHOLOMEW, *Physical Atlas; Meteorology*: Constable, London.
4. WARD, *Practical Exercises in Meteorology*: Ginn & Co. Also Bull. Am. Geog. Soc., Vol. XXXVII, 1905, p. 385, and Vol. XXXVIII, 1906, p. 401.
5. HANN, *Handbook of Climatology*: The Macmillan Co.
6. GREELY, *American Weather*: Dodd, Mead & Co.
7. FERREL, *Popular Treatise on the Winds*: Wiley & Sons.
8. RUSSELL, *Meteorology*: Macmillan.
9. *Illustrated Cloud Forms*: U. S. Hydrographic Office, Washington.
10. DAVIS, *The Temperature Zones*: Jour. Sch. Geog., Vol. I, pp. 139-143.
11. HAYDEN, *The Great Storm off the Atlantic Coast of the United States, March 11-14, 1888*: Nat. Geog. Mag., Vol. I, pp. 40-58.
12. GREELY, *Rainfall Types of the United States*: Nat. Geog. Mag., Vol. V, pp. 45-58.
13. MOORE, *Storms and Weather Forecasts*: Nat. Geog. Mag., Vol. VIII, pp. 65-82, and Vol. XVI, pp. 255-305.
14. *The Monthly Weather Review*: The Weather Bureau, Washington.

## CHAPTER XIII

### CONSTITUTION OF THE ATMOSPHERE

**Principal constituents.** The atmosphere is remarkably constant in composition, and is made up chiefly of two gases, namely, *nitrogen*, which makes up nearly 78 per cent. of dry air, and *oxygen*, which makes about 21 per cent.

**Minor constituents.** Beside these two principal constituents, the proportions of which do not vary much, there are several minor constituents, of which *argon*, about one per cent. of the whole, is most abundant. Argon was not separated from nitrogen until recent years. Another minor constituent of dry air, *carbon dioxide* or *carbonic-acid gas*, is of great importance. It makes up about  $\frac{3}{10000}$  by volume of the whole atmosphere, and its amount is nearly constant from year to year.

There is also a considerable amount of *water vapor*, that is, water in particles so small as to be invisible in the air. The total amount in the atmosphere at any one time varies within relatively narrow limits; but the amount varies greatly from place to place at the same time, and from time to time in the same place. Since this is the case, and since it is separated frequently from the atmosphere, in the form of rain, snow, etc., it is often regarded as something in the air, rather than as a part of the air. The weight of the total amount in the air at one time has been variously estimated at from  $\frac{1}{100}$  (1 per cent.) to  $\frac{1}{300}$  ( $\frac{1}{3}$  per cent.) that of dry air. The smaller figure is probably nearer the truth than the larger. The water-vapor pressure at the bottom of the atmosphere is not a measure of the amount of water vapor above. It was this assumption which gave the larger of the figures cited above. The water vapor may make as much as 3 per cent. of the air (by volume) in moist tropical regions.

**Impurities.** The air always contains some other gases which are commonly looked upon as impurities, though they are not necessarily injurious to life or to natural processes in general. Gases arise from combustion and decay of organic matter, from various chemical processes used in manufacturing, from volcanic and other vents in the earth's crusts, etc. Their aggregate amount is small, but locally, as about some vents, they are so abundant as to be injurious to life. This is the case in Death Valley in the Yellowstone Park, where animals straying into certain parts of the valley are often overcome and killed.

The air always contains numerous solid particles, which may, collectively, be called dust. Though the dust in the air serves important functions, it is to be looked upon as an impurity rather than as a constituent.

**Relations of constituents to one another.** The various gaseous constituents of the air are mixed with one another, and each of them retains its own characteristics. The oxygen behaves essentially as if no nitrogen were present, and the nitrogen as if no oxygen were present. That the several constituents of the air are merely mixed, and not chemically united, may be shown in various ways. One of them is as follows: When air is liquefied and allowed to stand, its constituents evaporate independently. Nitrogen and carbon dioxide evaporate faster than oxygen, so that as the liquid air stands, the proportion of oxygen increases. Again, heat is given off whenever a chemical compound is formed. When nitrogen and oxygen are mixed, no heat is developed.

### *The Functions of the Atmospheric Elements*

The various constituents of the air play various rôles in the economy of the earth.

*Nitrogen* is inactive. Though it is inhaled with the oxygen in breathing, it does not appear to be of direct use to animals. Both animals and plants need nitrogen, but they cannot use the nitrogen of the air directly. Before they can make use of it, it must be combined with something else, making what are known as *nitrogenous compounds*. From some of these compounds animals and plants derive the nitrogen they need. Plant decay sets some nitrogen free, but the aggregate effect of plant life and plant decay on the amount of nitrogen in the air is not known.

Since nitrogen makes up the larger part of the atmosphere, air-pressure and wind-strength are due chiefly to it.

*Oxygen* from the air is being consumed constantly by all animals. Air-breathing animals take it directly from the air, and water-breathing animals take it from the water in which it is dissolved. Oxygen is consumed by plants also, especially by green plants in the dark. Oxygen is consumed wherever combustion is going on, for combustion is primarily the union of oxygen with other substances, especially carbon. When the oxygen enters into combination, it loses its distinctive characteristics. Whenever organic matter decays, oxygen is also consumed, for the decay of such matter is but slow combustion. In spite of the constant and rapid consumption of atmospheric oxygen by animals and in all combustion, its amount does not appear to decrease. We must therefore infer that oxygen is supplied to the air about as fast as it is consumed. The sources of supply are several. Plants break up the  $\text{CO}_2$  into its elements, C and O, and set some of the oxygen free. This is perhaps the greatest source of supply of free oxygen. It is to be noted that oxygen received by the air in this way is not (or may not be) new to the air. Much of it at least is only returned to the air, after having been temporarily withdrawn. Oxygen also reaches the atmosphere from volcanic vents, by changes (deoxidation) which take place in certain kinds of rocks, and perhaps from other sources.

The *carbonic-acid gas* of the atmosphere, though a very minor constituent so far as quantity is concerned, is most important. We have already seen that it is being constantly produced by the burning of coal, wood, peat, gas, etc.; and by the decay of all organic matter. It is also added to the air by all animal respiration, and it is poured into the air from volcanic vents, often in great quantity. It is probable that "shooting stars" sometimes contain carbon, for the corresponding bodies (*meteorites*), which are so large that they are not reduced to dust in the atmosphere, but reach the earth as masses of rock or metal, sometimes contain carbon (sometimes in the form of diamonds). Any carbon which meteors contain must be burned to  $\text{CO}_2$  in the upper air. It is probable that there are still other minor sources of this gas.

Carbonic-acid gas is supplied to the atmosphere very rapidly from these various sources. For example, about 75 per cent. of common bituminous coal is carbon. When burned; a ton of such



coal would make about  $2\frac{3}{4}$  tons of carbonic-acid gas, all of which goes into the atmosphere. A ton of hard coal, which contains a higher proportion of carbon, would produce still more carbonic-acid gas. If we knew the number of tons of coal burned daily, we could calculate the amount of  $\text{CO}_2$  poured into the atmosphere daily as a result of its combustion. Nearly a billion<sup>1</sup> tons of coal are mined each year, and if each ton of coal makes  $2\frac{3}{4}$  tons of carbonic-acid gas, it will be seen that the atmosphere would be supplied with  $\text{CO}_2$  at the rate of more than  $2\frac{1}{2}$  billion tons a year from this source alone. This figure takes no account of other fuels, such as wood, peat, natural gas, oil, etc. Neither does it take account of the slow combustion (decay) of vegetable matter, nor of the  $\text{CO}_2$  produced by respiration. When these and all other sources of carbonic-acid gas are considered, it seems safe to say that carbonic-acid gas is being supplied to the atmosphere at the rate of several billions of tons per year; yet the amount of  $\text{CO}_2$  in the air does not increase enough to be noted from year to year, or even from generation to generation. It must therefore be taken out of the atmosphere about as rapidly as it enters.

The losses of carbonic-acid gas from the air come chiefly (1) through green plants, of which it is the chief food, and (2) through combination with mineral matter; for the  $\text{CO}_2$  of the air is constantly uniting with mineral matter in the solid part of the earth. It will be seen therefore that some of the  $\text{CO}_2$  is making a continuous round of change. It is taken out of the air by plants, and its constituents, or some of them, become a part of the woody tissue of the plant. In this process of transformation some of the oxygen is set free in the air. The carbon of the plant is then burned, either in a fire or by decay, and the carbonic-acid gas produced passes back into the air to be used by plants again. Much carbonic-acid gas goes through this round each year, for much vegetation grown during one warm season is burned or partially decayed before the next. It will be readily seen, too, that some of this gas might go through a cycle of change involving its return to the atmosphere more than once in a season.

The various sources of supply of  $\text{CO}_2$  are not always equal at the same place, and are not equal at different places. Thus, the

<sup>1</sup> See Mineral Resources of the United States, an annual publication of the U. S. Geol. Survey.

amount produced by combustion is much greater in winter than in summer, while the amount produced by the decay of plant and animal matter is much greater in summer than in winter. It is to be remembered, however, that the warm season in one hemisphere corresponds to the cold season in the other; but since there are fewer people in the southern hemisphere than in the northern, there is less burning of coal there, and since there is much less land in the southern hemisphere, there is less decay of land vegetation. Volcanoes are more active at some times than others, and probably give forth most  $\text{CO}_2$  when most active. The amount produced by animal respiration is probably nearly the same throughout the year.

The rate at which  $\text{CO}_2$  is taken from the air also varies. Since plants use it during the growing season only, the plants of middle and high latitudes draw on the supply in the atmosphere chiefly during the summer. Though summer alternates in the hemispheres, there is much more plant life on land in the northern hemisphere than in the southern, and, so far as land plants are concerned,  $\text{CO}_2$  must be consumed more rapidly in the northern summer than in the northern winter. Carbonic-acid gas also enters into combination with mineral matter more readily when it is warm than when it is cold, so that there must be some variation from season to season in the amount taken out in this way.

At first thought it would seem that carbonic-acid gas should greatly increase in one hemisphere during the winter season, and diminish in the same hemisphere during the summer; but this is not the case. The reason is twofold. In the first place, the winds distribute the carbonic-acid gas. In the second place, even without winds, the carbonic-acid gas tends to diffuse equally through the atmosphere. It is, for example, produced in great quantities in a large city in winter, for the thousands of tons of coal consumed daily in such a city produce enormous quantities of carbon dioxide. But instead of accumulating in great quantities over the city, it diffuses through the atmosphere, so that, even without winds, there would be no great excess over the region where it is produced. A slight excess in such situations is often noticed, for diffusion does not bring about equality of distribution instantaneously.

At present the supply and loss of carbon dioxide so nearly balance that no change in the amount of  $\text{CO}_2$  in the air is noted;

but it seems quite possible that in the course of long periods of time the supply may have exceeded the loss, or vice versa. While therefore the amount of  $\text{CO}_2$  remains nearly constant from year to year, there is no warrant for the inference that it has remained so from age to age.

Though a very minor constituent of the atmosphere, carbonic-acid gas has an important function other than in supplying food to plants. It has the power of retaining some of the heat radiated from the solid part of the earth into space. It therefore serves as a blanket to hold in the heat of the earth, and thin (tenuous) as the blanket now is, it is more effective, in this respect, than the denser blanket of oxygen and nitrogen. If it were thicker, it would be still more effective, making the earth warmer. So important is its function in this respect, that, if the amount of this gas were doubled, the temperature of the earth, and especially of high latitudes, would be notably increased. It has been estimated that if its amount were doubled or trebled, magnolias might grow again in Greenland, as they once did. On the other hand, it has been estimated that if the amount of carbonic-acid gas in the atmosphere were decreased one-half, the climate would be so much colder than now, that much of the land in the northern part of our continent would be covered by a sheet of snow and ice, somewhat as it was in the glacial period (p. 271). While these conclusions have been called into question, *so far as the amount of change of temperature* for a given increase or decrease of carbonic-acid gas is concerned, there seems to be no doubt that an increase of carbonic-acid gas in the atmosphere would ameliorate climate, while a decrease would make it more rigorous.

It has been noted that *the water vapor* in the atmosphere is a variable quantity. It is constantly entering the atmosphere, and it is constantly being condensed and precipitated in the form of rain, snow, dew, frost, etc., to be again evaporated, condensed, and precipitated. Like much of the  $\text{CO}_2$ , it is making continuous rounds. The amount which the atmosphere may contain at any time is dependent on temperature; but various other factors, especially the available local supply, help to determine the amount which is actually held. The importance of water vapor in the general economy of the earth will be referred to in later chapters, but it may be stated here that, like the carbonic-acid gas, it serves as a blanket to keep the earth warm. Furthermore, it is to be remembered

that the water vapor of the air, constantly renewed, is the source of all the rain and snow, the work of which has been described on preceding pages.

The *dust* in the atmosphere includes all solid particles held in it. We do not ordinarily see them, though clouds of dust are sometimes visible on windy days. The settling of dust from the air on all objects in doors or out is sufficient evidence of its universal presence (p. 55). It may be readily seen in indoor air if the room be darkened and the light allowed to enter only through a narrow crack or small hole. Even air which appears clear may in this way be seen to contain innumerable particles of solid matter. The amount of dust is sometimes very great, as over cities and in dry and windy regions. During the fogs of February, 1891, it was estimated that the amount of dust deposited on glass roofs in and near London was six tons per square mile. The variety of matter in the dust was also great, carbon (soot) being most abundant.

Some years since a method was devised for counting the dust particles in a given volume of air. The result showed that in the air of great cities there are hundreds of thousands of dust particles in each cubic centimetre (a centimetre is less than  $\frac{1}{100}$  of an inch) of air; and that even in the pure air of the country, far from towns and factories, there are hundreds of motes per cubic centimetre. It has been estimated that "every puff of smoke from a cigarette contains about 4000 million separate granules of dust."

The amount of dust in the air is greater over the land than over the sea, and in the lower atmosphere than in the upper.

The dust particles consist of *inorganic materials*, such as (1) tiny particles of mineral matter blown up from dry roads and fields, (2) particles of smoke from chimneys, (3) frequently of tiny bits of rock matter blown out of volcanoes, and (4) meteoric dust, or the dust which comes to the earth from outside space—such as the dust to which "shooting stars" are reduced in the atmosphere; and *organic particles*. Among the organic dust particles are bacteria of various sorts, and the spores of many plants. The dust that is thrown into the air when a dry puffball is broken may serve as an illustration of the spores of plants which are often abundant in the air. The fact that plant spores are nearly universal in the air is shown by the promptness with which a moist piece of bread or cake, or a moist piece of leather, gets mouldy, especially in a dark, warm place. The moulds are plants, and the spores from which they grow were

floating in the air, until they found a lodging-place suitable for their growth. In the blossoming season also, the winds get much pollen dust from flowers. The scattering of pollen by the wind serves an important purpose in the plant world.

Some diseases are spread by means of germs in the air, though fortunately most of the germs in the air are not injurious.

The number of bacteria found in a cubic metre of air at Montsouris (France) Observatory was 345, while in the same amount of air in the heart of Paris the number was 4790. These figures give some idea of the relative purity of country and city air.

The dust particles in the atmosphere play an important rôle in various other ways. They "scatter" the light of the sun, so as to illuminate the whole atmosphere. Without the dust in the air, all shady places would be in darkness. The sun would probably appear in dazzling brilliance, shining from a black sky in which the stars would be visible even in the daytime. The blue color of the sky, and the sunset and sunrise tints, are determined or affected by the dust in the atmosphere. Dust particles also serve as nuclei about which water vapor condenses. It was formerly held that they were necessary for the condensation of water vapor in the atmosphere, but this appears not to be the case.

## CHAPTER XIV

### TEMPERATURE OF THE AIR

THE temperature of the air varies from season to season, from day to day, and even from one part of a day to another. Because of the importance of temperature in all human affairs, it is convenient to have some method of measuring and recording it.

**The thermometer.** The temperature is measured by means of the *thermometer*. The principle of the thermometer is readily understood. It consists of a glass tube of uniform diameter, except for a bulb at one end. The bulb and the lower part of the tube are filled with some liquid, generally mercury. The mercury is then heated to its boiling temperature, so as to expel all air. When the tube is full of boiling mercury from which all air has been driven by the heat, it is sealed.

The mercury contracts on cooling, so that it but partly fills the tube. Above it is a vacuum. When the temperature rises, the mercury in the tube expands and rises. When the temperature falls, the mercury contracts and sinks. The amount of rise or fall of the mercury in the tube indicates the amount of the change of temperature.

That the temperature may be read directly from the thermometer, it is necessary to have a scale marked on the tube. Two scales are in common use—the *Fahrenheit* and the *Centigrade*. The scales are made as follows: The thermometer tube is placed in boiling water, or in steam just over boiling water, at sea-level (760 mm. pressure), and allowed to remain there until the tube and its contents acquire the temperature of the water. The point to which the mercury rises in the tube under these circumstances is then marked 212°, if the Fahrenheit scale is to be used. The tube of mercury is then put into moist pounded ice or snow, where it

remains until the level of the mercury in the tube becomes stationary, and the level at which the mercury then stands is marked  $32^{\circ}$ . The space between the  $212^{\circ}$  mark and the  $32^{\circ}$  mark is then divided into 180 equal parts, each being called a degree ( $1^{\circ}$  Fahr.) The marks on the tube may be made for each degree, for every two degrees, or for every five degrees, according to the delicacy which is required of the thermometer.

The space below the freezing temperature is divided similarly into degrees, each degree below  $32^{\circ}$  having the same length on the tube as each degree above. The  $0^{\circ}$  of this scale is  $32^{\circ}$  below the freezing-point. The scale is carried still lower on the tube, and the temperature below  $0^{\circ}$  is called "below zero." Thus  $20^{\circ}$  below zero means  $52^{\circ}$  below the freezing-point, and is written  $-20^{\circ}$  Fahr. or  $-20^{\circ}$  F.

The Centigrade scale is much simpler and better, though unfortunately not in common use in English-speaking countries. The height of the mercury at the freezing temperature under normal atmospheric pressure is marked  $0^{\circ}$ , and the boiling temperature  $100^{\circ}$ . The space between is divided into 100 parts, each of which is a degree ( $1^{\circ}$  C.). The degrees below zero have the same length on the scale as the degrees above. It will be seen that  $1^{\circ}$  C. is equal to  $1\frac{1}{5}^{\circ}$  Fahr. If this relation of degrees is remembered, degrees Fahrenheit may be readily changed to degrees Centigrade, or vice versa.

### *The Heating of the Atmosphere*

**Sources of heat.** The atmosphere receives heat from several sources, but that received from the sun so far exceeds that from all other sources that the others may almost be neglected.

That much heat is received from the sun is shown by the fact that the temperature generally rises when the sun rises and sinks when the sun goes down, and by the further fact that the temperature is generally warmer on a sunny day than on a cloudy one. It is true there are occasional exceptions to these general rules, for now and then a night is warmer than a day, and a cloudy day is sometimes warmer than a sunny one of the same season. But these exceptions do not interfere with the truth of the general statement.

The source of atmospheric heat which is second in importance is the interior of the earth; but the heat from this source is not

enough to affect the temperature of the atmosphere sensibly. This is indicated, in a general way, by the fact that in polar regions, during the long night, the temperature is very low, and all the heat received from the interior of the earth has no apparent effect on the snow and ice.

**Sun heating: insolation.** The temperature of space is supposed to be about  $-273^{\circ}$  C. ( $-459^{\circ}$  F.). The more genial temperature which we enjoy results chiefly from the heat received from the sun; yet the earth receives less than  $\frac{1}{2000000000}$  of the heat given off by that luminary. The amount received each year, if equally distributed, is enough to melt a layer of ice about 141 feet thick over the entire earth, or to evaporate a layer of water 18 feet deep.

Each hemisphere receives the same amount of heat from the sun each year (Fig. 518), but, because of the inclination of the earth's axis, the heat is very differently distributed in different latitudes. Other things being equal, the earth gets most heat per unit area where the sun shines the greatest number of hours per day. In summer, the days are longest in the highest latitudes. *So far as length of day is concerned*, therefore, the highest latitudes, namely the poles, should get more heat than any other part of the earth in summer.

Again, other things being equal, the earth (land or water surface) gets most heat per unit area where the sun's rays fall most

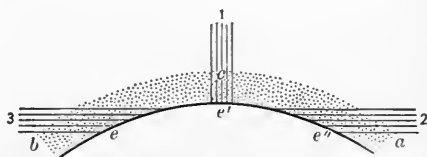

FIG. 530.—Diagram to illustrate the unequal heating power of the sun at different altitudes. When its rays are vertical they are concentrated on less space on the surface of the earth, and at the same time pass through less atmosphere, than when they strike the surface of the earth obliquely.

nearly vertically, both because they are there most concentrated, and because they there pass through a lesser thickness of the air, which absorbs some of their heat. This is shown by Fig. 530. A given bundle of rays, 1, falling vertically on the surface, is distributed over a given space, while an equal bundle of rays, 2 or 3, falling obliquely on the surface, is distributed over a much greater area, and therefore heats each part less. Again,



the oblique rays, 2 and 3, pass through a greater thickness of atmosphere, and more of their heat has been absorbed before they reach the surface of the solid part of the earth. The angle at which the sun's rays reach the earth varies from place to place. It also varies at the same place from time to time, because the earth's axis of rotation is inclined to the plane of its orbit as the earth revolves about the sun. This is illustrated by Fig. 529, which has already been explained.

**Primary distribution of heat.** Remembering that it is the rotation of the earth on an inclined axis while it revolves about the sun (Fig. 526) which makes the sun appear to move north and south during the year (Fig. 529), we may study the effects of this apparent motion of the sun on the distribution of heat received by insolation. From Fig. 528 we see that when the sun's rays are perpendicular to the surface of the earth  $23\frac{1}{2}^{\circ}$  south of the equator, they are most oblique at all points in the northern hemisphere, and least oblique at all points in the southern hemisphere. At this time, therefore, the southern hemisphere is receiving more heat than the northern, because of the direction of the sun's rays. At the same time, the days are longer in the southern hemisphere than in the northern, and this is a second reason why the southern hemisphere is receiving more heat than the northern at this time. After the time (winter solstice, December 22) when the sun's rays are vertical at  $23\frac{1}{2}^{\circ}$  S., they become perpendicular to the surface at points farther and farther north, and on March 21 they are vertical at the equator (Fig. 529). Days and nights are then equal everywhere, and the sun's rays are equally oblique in corresponding latitudes north or south of the equator. Any latitude in one hemisphere is then receiving the same amount of heat as the corresponding latitude in the other hemisphere.

After March 21, the sun appears to continue its journey northward until, on June 21, its rays are vertical at the tropic of Cancer,  $23\frac{1}{2}^{\circ}$  N. (Fig. 529), when the days of the northern hemisphere attain their greatest length, and the nights of the same hemisphere become shortest in all latitudes where there is alternation of day and night (Fig. 527). At the same time, the rays of the sun are less oblique in the northern hemisphere, as a whole, than at any other time. In the southern hemisphere the conditions are reversed. At this time, therefore, the northern hemisphere is being heated by the sun faster than at any other time of the year, while the

southern hemisphere is receiving less heat than at any other time.

From June 21 to December 22 the sun appears to move so that its rays become vertical farther and farther south, and the preceding sequence of events is reversed.

The latitudes where the sun's rays fall vertically range from the tropic of Cancer to the tropic of Capricorn. For the whole year, however, the sun's rays are, *on the average*, least oblique in the lowest latitudes. This is why the low latitudes are, on the whole, warmer than the high latitudes.

The actual amount of sun heat received in different latitudes is determined by the length of day (hours of sunshine) and the direction of the sun's rays; but it is to be noted that the latitudes which have the longest days never have the vertical rays of the sun. Calculations based on these two factors have been made, showing the proportion of heat received in different latitudes during the whole year and during different seasons. For the year, the equator receives more heat than any other part of the earth. If the average amount of heat received there each day be taken as 1, the amount of heat received in a year is 365.2. The proportionate amount received in various other latitudes is shown in the following table:

Latitude	0°	10°	20°	30°	40°	50°	60°	70°	80°	90°
Thermal days, or relative amount of heat yearly	365.2	360.2	345.2	321.0	288.5	249.7	207.8	173.0	156.6	151.6

From this table it is seen that latitude 40° receives about three-fourths as much heat as the equator, and latitude 70° a little less than one-half as much.

During the half of the year when the sun's rays are vertical north of the equator, most heat is received in latitude 25° N. During this half of the year the sun's rays are most nearly vertical, on the average, in latitude 11 $\frac{3}{4}$ ° (half-way between the equator and latitude 23 $\frac{1}{2}$ °); but the days are longer farther north. During the three months centering about June 21, the zone of greatest heat is in latitude 41° N. The sun's rays are here less nearly vertical than in latitudes about the tropic of Cancer, but the days are much

longer. Between May 31 and July 16<sup>1</sup> the north pole receives more heat than any other part of the earth, the continuous day offsetting the great obliquity of the sun's rays at this time. At the time of the summer solstice, the area immediately about the north pole receives 20% more heat than an equal area at the

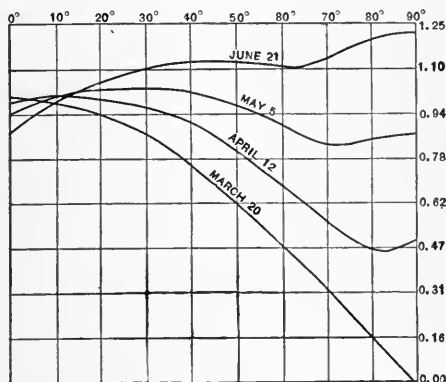

FIG. 531.—Diagram showing receipt of heat in different latitudes of the northern hemisphere for four dates between the vernal equinox and the summer solstice. The latitudes are indicated at the top of the figure, and the relative amounts of heat at the right. (After Wiener.)

equator ever receives, and 36% more than the equatorial region receives at that time. Fig. 531 shows the amount of heat received from the sun in various latitudes of the northern hemisphere from the time of the vernal equinox to the time of the summer solstice.

The temperature of one place is not necessarily higher than that of another, because it receives more heat. No amount of heat, for example, would make the temperature of Greenland warm *until after the snow and ice was melted*. All the heat received tending to raise the temperature above 32° F. would be expended in melting and evaporating the snow, without raising its temperature above 32° F. (0° C.). The region about the north pole does not get very warm, even when it receives more heat than the equator, because much of the heat is expended in melting ice and in warming up ice-cold water, which heats very slowly and runs away as soon as the heating is well begun.

What the sun does for the earth in the matter of heat is shown

<sup>1</sup> Hann gives these dates May 10 to August 3, a period of 56 days.

by the following table, which gives the estimated temperatures (Centigrade) which would exist on the earth in different latitudes if there were no atmosphere. The figures in the upper part of the table are for the warmest and coldest months.

Equator	10°	20°	30°	40°	50°	60°	70°	80°	Pole.
67	67	70	74	75	75	73	76	80	82
56	50	36	16	-10	-45	-103	-273	-273	-273
ANNUAL MEANS									
62	61	57	50	39	24	1	-43	-81	-105

### HEATING AND COOLING

There are three ways in which the air receives, loses, and transfers heat. These are *radiation*, *conduction*, and *convection*.

1. *Radiation*. When the sun shines, the surface which its rays strike is warmed by the absorption of heat radiated from the sun. An object in front of a fire is warmed by heat radiated from it. A body need not be glowing hot, like the sun, to radiate heat. A hot stove would continue to radiate heat if all the fire were taken out. The body which radiates heat is itself cooled. The hot stove from which the fire has been taken presently ceases to radiate heat. The land warmed by radiation from the sun during the day is cooled by the radiation of its heat during the night. The rate at which a given body loses heat by radiation depends upon the difference of temperature between it and its surroundings. Thus a hot stove will cool much more quickly in a cold room than in a warm one.

2. *Conduction*. If one end of a bar of iron, such as an iron poker, be put in the fire, the other end soon becomes hot. The heat passes along the iron rod from one end to the other. This means that the molecular motion, known as heat or *heat-energy*, set up in one end of the rod by the fire, is passed along from particle to particle to the other end. This method of transmitting heat is *conduction*. Any cold body in contact with a hot body is warmed by conduction. Thus, the bottom of the air is warmed

by contact with the land, that is, by conduction, wherever the temperature of the land is higher than that of the air.

3. *Convection.* When a kettle of water is placed on a hot stove, the water in the bottom is heated by conduction, that is, by contact with the hot kettle. The heating of water causes it to expand, and when the water in the bottom of the kettle expands, it becomes lighter than the water above it. The heavier water above then sinks and pushes the lighter water below up to the top. This sort of movement is *convection*. Other illustrations of convection are afforded by stoves, fireplaces, etc. A thin sheet of light paper may be momentarily sustained in the air over a hot stove, or even carried up by the rising air of the convection current. Again, as the air in a chimney is heated, it expands and becomes less dense than the air about it. The cooler, denser air about the base

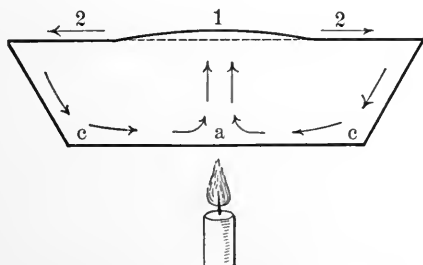

FIG. 532.—Diagram to illustrate convection in a vessel of water heated at one point at the bottom.

of the chimney or stove crowds in below the expanded air in the chimney, and crowds it up out of the chimney. Since the air coming into the chimney is continually being expanded, the up-draught continues as long as there is fire. Every draught from a chimney is therefore an example of convection.

It will be seen that in convection the molecules of the gas or liquid change their position relative to one another, while in conduction in a solid, they do not.

Convection is of so much importance in connection with the temperature of the air and of water that the process may be analyzed a little more fully. Suppose a vessel of water (Fig. 532) heated at the central point of its bottom. (1) The water heated at *a* expands, lifting the overlying column of water, producing a very low dome on the surface at 1. (2) Under the influence of gravity,

water flows off the dome. There are now unequal pressures at the bottom of the dish. It is greater at  $c$  than at  $a$ , because there are more molecules above  $c$  than above  $a$ . (3) Because of the excess of pressure at  $c$ , water moves from  $c$  to  $a$ , displacing (lifting) the warmer water at that point, and producing the upward movement indicated in the center of the figure. (4) The centerward movement from  $c$  causes the water above  $c$  to sink and to occupy the abandoned space, while the lifting of the water over  $a$ , by the inflow from  $c$ , renews the dome, and the lateral motion from center to side at the surface.

When the surface of the land is warmed by the heat radiated from the sun, it heats the air above, partly by conduction, but chiefly by radiation. Some parts of the surface are heated more than others. The heated air expands and rises. The beginning of the rise is due to expansion (Fig. 533). If the air in a given region were expanded as shown in Fig. 533, the air at the top of the expanded column would run over (spread), much as water would under similar conditions. *After this has taken place, the*

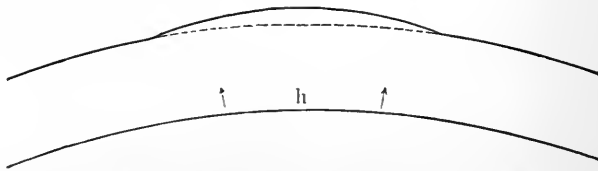

FIG. 533.—The initial rise of air, as a result of heating, is due to the expansion of the part heated.

amount of air at the base of the column  $h$  will be less than the amount at the same level outside the heated area, and air from outside the heated column will flow in to balance the deficiency. This inflow will push up the column of warmed and expanded air, and further overflow above will cause more inflow at the bottom. If the heated area continues to be heated, a permanent convection current will be established in the heated area (Fig. 534).

It is not necessary that the expanding air actually raise the upper surface of the air sensibly, as shown in Fig. 534, to establish a convection current. As it expands upward it compresses the air above the lower heated part (Fig. 535). Where this compression takes place, the air is denser than that *at the same level about it*, and flows sideways to balance the discrepancy. This is what

actually takes place in the air. It will be seen that convection gives rise to horizontal, as well as to vertical, air movements, and that the horizontal movements take place at various levels.

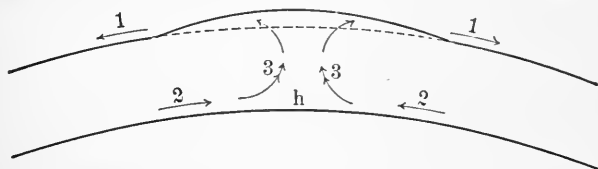

FIG. 534.—The permanent heating of the air over a given region gives rise to permanent convection currents.

**How the sun heats the atmosphere.** The atmosphere is heated by the sun in two principal ways: (1) It is warmed by heat radiated from the sun as the rays of the sun come through it, and (2) the land and water below the atmosphere are warmed by absorbing the heat radiated from the sun, and then radiate much

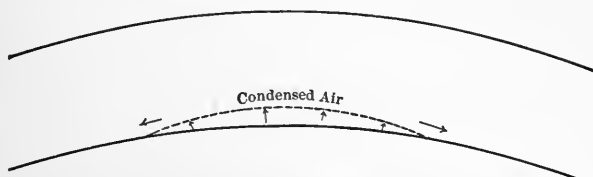

FIG. 535.—Flow of air from above a heated area would take place even if the surface of the air were not raised.

of the heat they have received. Much of the heat thus radiated is absorbed by the air, which is thus warmed.

The amount of heat absorbed by the air from the direct rays of the sun is different in different latitudes, and depends chiefly on the distance the rays travel in the atmosphere; that is, on the verticality of the sun's rays (Fig. 530). The amount for different altitudes of the sun is shown in the following table:<sup>1</sup>

Altitude of the sun	0°	5°	10°	20°	30°	50°	70°	90°
Thickness of the atmosphere in units.....	35.5	10.2	5.56	2.90	1.99	1.31	1.06	1.00
Proportion of solar radiation reaching the bottom of the atmosphere.....	0.00	0.05	0.20	0.43	0.56	0.69	0.74	0.75

<sup>1</sup> Copied from Waldo's Elementary Meteorology, p. 28.

The heat radiated into the air from land and water is more readily absorbed by the air than the luminous heat radiated by the sun, so that the atmosphere is heated more by radiation from below than by direct insolation. The lowest air is heated most by both earth radiation and insolation, because it is densest, and, being warmed, it gives rise to convection currents which warm the air above. Since convection currents involve horizontal as well as vertical movements, regions which are heated much give of their heat to regions which are heated less.

Whenever the land and water are warmer than the air which rests on them, they also warm it by conduction, and convection results. Warmer air also radiates heat to cooler air.

**The heating of land and water.** Land and water are heated unequally by the sun, the former being heated four or five times as fast as the latter by insolation. The reasons are several:

1. The absorption of a given amount of heat by a given amount of soil or rock raises the temperature of the soil or rock more (about four times as much) than that of the same amount of water; that is, the *specific heat* of water is higher than that of the land.

2. Water is a good reflector, while the land is not, and the latter therefore absorbs a larger proportion of the heat of the sun's rays.

3. The land cools more readily than water.

4. Convection currents or movements are established in water as soon as its surface is heated locally. This prevents excessive heating at any one point. The land, on the other hand, being solid, is without movements of convection.

5. There is more evaporation from a water surface than from a land surface, other conditions being the same, and evaporation cools the surface from which it takes place.

6. Soil and rock are essentially impenetrable to light and heat rays, while water is not. The heat of insolation is, therefore, distributed, at first hand, through a greater thickness of water than of land. Being confined essentially to the surface of the latter, the temperature of the surface is made higher.

7. Rock is a poor conductor of heat, but water is even poorer.

**Secondary distribution of heat.** From what has preceded, it is clear that after the heat is received by the earth from the sun, it is to some extent re-distributed. This re-distribution is accomplished in part in ways just noted. It is also effected by air move-



ments (other than convection currents) and water movements (especially ocean currents) both of which are of great importance in the secondary distribution of heat. It has been estimated that without them the average temperature of the equator would be about  $131^{\circ}$  F., instead of about  $80^{\circ}$  F. as now, and that of the poles about  $-108^{\circ}$  F., instead of  $0^{\circ}$  as now.

### THE SEASONS

We are now prepared to understand the seasons, and the reasons for their differences so far as temperature is concerned. In most latitudes the seasons are usually said to be four—spring, summer, autumn, and winter; but they are not sharply separated from one another, each grading into the one which follows.

The exact limits of the four seasons are arbitrarily defined. In the United States, March, April, and May are commonly called the spring months; June, July, and August, the summer months; September, October, and November, the autumn months; and December, January, and February the winter months. Sometimes, however, spring is defined as the time between the vernal equinox and the summer solstice. On this basis, summer is the time between the summer solstice and the autumnal equinox, autumn the time between the autumnal equinox and the winter solstice, and winter the time between the winter solstice and the vernal equinox. In the southern hemisphere spring comes in September, October, and November; summer in December, January, and February; and so on. The vernal equinox of the northern hemisphere is the autumnal equinox of the southern, and the summer solstice of the northern is the winter solstice of the southern.

The first of these subdivisions is based primarily on temperature. The summer is made up of the three warmest months, so far as intermediate (temperate) latitudes are concerned, and the winter of the three coldest. The second has an astronomical basis. The limits of the seasons are defined in still other ways in some countries even in middle latitudes, and in some cases the lengths of the seasons, according to popular use of the terms, are not equal.

In middle latitudes the distinction between the seasons is primarily one of temperature; but in some parts of the earth the distinction between the seasons is based partly, or even largely, on elements other than temperature. Thus, in some regions the

*wet* and *dry* seasons are more distinct than the *warm* and *cold* ones. This is true, for example, in some low latitudes where the temperature is always high. In the polar regions, on the other hand, while the temperature of the cold seasons is very much lower than that of the warm ones, there is also a striking difference in the matter of light. At the poles the warm season is the *light* season, and the cold season is the *dark* one.

**Differences between summer and winter.** \ Aside from the higher temperature of summer in our latitude (middle latitude of the northern hemisphere), there are certain other obvious differences between summer and winter. (1) In summer the days are more than 12 hours long, and the nights less. (2) The sun is much higher above the horizon at noon in summer than at the corresponding hour in winter. This is the same as saying that the sun's rays are less oblique, at any given hour of the day, in summer than in winter (Fig. 526). (3) A third difference between summer and winter in our latitude is the direction in which the sun rises and sets. In summer the sun rises to the north of east, and sets to the north of west. At the equinoxes it rises in the east and sets in the west. In the winter it rises to the south of east and sets to the south of west. (4) The amount of moisture in the air often varies with the season; but in some regions it is the warm season which is wet, while in others it is the cool season. (5) In some regions the winds change their direction and force with the change of seasons, as will be noted later. The first and second of these differences are the most important, so far as concerns the seasons of middle latitudes.

The differences between summer and winter, other than the differences of temperature, are dependent primarily upon the differences in temperature.

**Why we have summer when we do.** Since the earth receives most of its surface heat from the sun, it follows that the period of the year when the days are long and the nights short must be warmer than the period when the days are short and the nights long; for long days and short nights mean long periods of heating and short periods of cooling daily, while short days and long nights mean short periods of heating and long periods of cooling daily. Not only this, but the sun's rays are more nearly vertical when the days are long, as shown by Fig. 536, and so have greater heating power. It follows, therefore, that during the summer the

surface is not only heated more hours a day than during the winter, but the heat per hour is greater while the sun shines. These are the immediate reasons why summer is warmer than winter.

The reasons why the days are longer at one time of the year than another have already been given (p. 498).

**Change of seasons.** The change of seasons may be understood from a study of Figs. 526 and 536. We have already seen (1) that the sun's rays are vertical at the equator at the equinoxes, and that the days and nights are then equal everywhere; (2) that the northern hemisphere is being heated most by the sun at the time of the summer solstice, and least at the time of the winter solstice; (3) that the days are longer than the nights in the northern hemisphere (except where there is continuous day) from March 21 to September 22; (4) that the sun's rays are less oblique in either hemisphere during the half of the year when the days are longer than the nights; and (5) that the relative lengths of day and night, and the angle of the sun's rays, are reversed in each hemisphere every half-year.

Since the northern hemisphere is being heated most at the time of the summer solstice and least at the time of the winter solstice, it would seem, at first thought, that these dates, respectively, should be the middle points of the hot and cold seasons. This is not the case. It therefore follows that the temperature of any given latitude is not altogether dependent on the amount of heat it is receiving from the sun (p. 524). Again, since the value of insolation in corresponding latitudes in the two hemispheres is equal at the equinoxes, it would seem, at first thought, that corresponding latitudes in the two hemispheres should have the same temperature at these times; but this, again, is not the case. In our own latitude, for example, March 21 is much colder than September 22. There is some discrepancy, too, between the temperatures of the northern and southern hemispheres on corresponding dates in corresponding latitudes, because of the greater preponderance of water in the latter.

The reason why a place in our latitude is warmer at the time of the autumnal than at the time of the vernal equinox is because the warmth of the summer just passed has not all been lost. At this time, therefore, the northern hemisphere has a temperature higher than that which it would have if it depended solely on daily insolation. On the other hand, the temperature at the time

of the vernal equinox is lower than that which would seem appropriate from the insolation then taking place, because the cold of the winter just passed has not been altogether overcome. The cold of the spring is rather more enduring than the heat of the autumn, for it is in some sense "stored up" in the snow, the ice, and the frozen ground.

Similarly, our summer solstice is not the hottest part of the year in the northern hemisphere, or the coldest in the southern, for the summer's heat has not altogether overcome the effect of the preceding winter in the northern hemisphere, or the effect of the preceding summer in the southern hemisphere. The time of maximum heat therefore lags behind the season of maximum heating. Similarly, the time of maximum cold does not come till after the season of minimum heating. In middle latitudes the lag is about a month, but it is greater over the ocean than over the lands, because the latter are heated and cooled the more readily.

**Seasons in other latitudes.** Attention to the subdivisions of the year in latitudes other than our own will help to an understanding of the fundamental principles involved. At the equator, for example, the sun's rays are vertical twice each year, that is, at the time of the equinoxes. Twice a year, too, the sun's rays are vertical  $23\frac{1}{2}^{\circ}$  from the equator, once to the north and once to the south. The equator, therefore, has two seasons, occurring at the time of our spring and autumn, which are somewhat warmer than two other seasons occurring at the time of our summer and winter. The variations in temperature are much less than in our own latitude, for the length of day and night never varies, and the angle of the sun's rays varies but  $23\frac{1}{2}^{\circ}$ , while with us, in middle temperate latitudes, it varies  $47^{\circ}$ . At the equator, therefore, there is a fourfold division of the year, but the divisions do not correspond very closely with those of middle latitudes.

In high latitudes the conditions are still different. The succession of seasons in latitude  $75^{\circ}$  N. may be taken to illustrate the conditions in latitudes above the polar circles generally. When the sun's rays are vertical  $15^{\circ}$  south of the equator, the sun would appear on the horizon at noon in latitude  $75^{\circ}$  N. (Fig. 536), for this latitude is  $90^{\circ}$  from the place where the sun's rays are vertical. When they are vertical farther south than  $15^{\circ}$  S., points on the parallel of  $75^{\circ}$  N. will not see the sun. When the sun's rays are vertical in latitude  $15^{\circ}$  N., or in any latitude farther north, no point on the

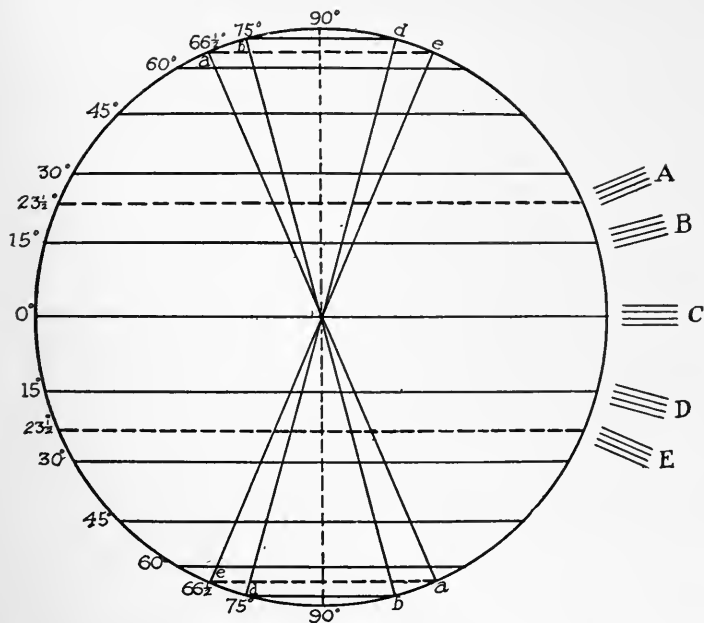

FIG. 536.—Diagram to illustrate seasons in latitude  $75^\circ$ . When the sun's rays are vertical at *C*, the circle of illumination is represented by the line  $90^\circ-90^\circ$ . The half of each parallel of  $75^\circ$  is then illuminated, and days and nights on that parallel are therefore equal. The same is true of all other latitudes. When the sun's rays are vertical at *B*, in latitude  $15^\circ$  N., the circle of illumination is represented by *b-b*, the whole of the parallel of  $75^\circ$  N. is illuminated, and daylight is continuous throughout the twenty-four hours. No part of the parallel of  $75^\circ$  S. is illuminated at this time, and on that parallel darkness is continuous. When the sun is vertical at *A*, in latitude  $23\frac{1}{2}^\circ$  N., the circle of illumination is represented by *a-a*. While the sun appears to move from position *B* to position *A* and back again to *B*, the parallel of  $75^\circ$  N. is continuously illuminated, while the parallel of  $75^\circ$  S. at the same time is continuously in darkness. When the sun appears to move from the position where its rays are vertical at *B* to the position where its rays are vertical at *D*, a part of each parallel of  $75^\circ$  is illuminated, and during this time, therefore, there is light and darkness in the course of the twenty-four hours. When the sun's rays are vertical between *B* and *C*, more than half of the parallel of  $75^\circ$  N. is illuminated, and less than half of the parallel of  $75^\circ$  S. When the sun is vertical at *C* the half of each parallel of  $75^\circ$  (and of all other parallels) is illuminated, and days and nights are equal. While the sun appears to be passing from *C* to *D* less than half of the parallel of  $75^\circ$  N. is illuminated, and more than half of the parallel of  $75^\circ$  S. During this time, therefore, nights are longer than days in latitude  $75^\circ$  N., and days are longer than nights in latitude  $75^\circ$  S. When the sun is in a position where its rays are vertical at *D*, the circle of illumination is *d-d*. At this time all of the parallel of  $75^\circ$  N. is in darkness, and all of the parallel of  $75^\circ$  S. is in light. This condition continues while the sun appears to move on from the position where its rays are vertical at *D* to the position where its rays are vertical at *E*, and back again.

parallel of  $75^{\circ}$  N. will be in darkness during any part of the twenty-four-hour day (Fig. 536). When the sun's rays are vertical in any latitude between  $15^{\circ}$  S. and  $15^{\circ}$  N., a part of the parallel of  $75^{\circ}$  N. will be illuminated, and all points on that parallel will have alternating light and darkness in the course of the twenty-four-hour day. (See also explanation below Fig. 536.)

Here, too, there is a natural fourfold division of the year: one (summer) when daylight is continuous, one (winter) when darkness is continuous, one (spring) when there is alternating day and night with the days lengthening, and one (autumn) when there is alternating day and night with the nights lengthening. In other words, summer, according to this subdivision of the year, is the time during which the sun appears to move from  $15^{\circ}$  N. to  $23\frac{1}{2}^{\circ}$  N. (*B* to *A*, Fig. 536) and back again to  $15^{\circ}$  N. Autumn is the time during which the sun appears to pass from a position where its rays are vertical  $15^{\circ}$  N. to a position where its rays are vertical  $15^{\circ}$  S. (*B* to *D*). Winter is the time during which the sun appears to pass from  $15^{\circ}$  S. to  $23\frac{1}{2}^{\circ}$  S. (*D* to *E*) and back again to  $15^{\circ}$  S., and spring the time when the sun is passing from  $15^{\circ}$  S. to  $15^{\circ}$  N. (*D* to *B*).

It will be noted that the lengths of the several seasons defined in this way are not the same. In latitude  $75^{\circ}$  the summer would be as long as the winter, and the spring as long as the autumn; but the spring and autumn would be nearly twice as long as the summer and winter, for during each of the former the sun moves through  $30^{\circ}$ , and during each of the latter but  $17^{\circ}$ . Not only this, but the lengths of the several seasons would vary with the latitude. In latitude  $85^{\circ}$  the summer and winter would be longer than in latitude  $75^{\circ}$ , and the springs and autumns correspondingly shorter.

There is a prevalent idea that in polar regions there is a day of six months and a night of six months each year; but it will be seen from the above, as well as from what has been stated before, that this notion is not correct. There is a six-months day and a six-months night at the poles only.

**Effect of varying distance of the sun.** Since the orbit of the earth is an ellipse, the distance of the earth from the sun varies in the course of a year. On this account, the amount of heat which the earth receives daily varies a little, being somewhat greater when the earth is nearer the sun, somewhat less when it is farther from it. But the variations in the amount of heat re-

ceived by the earth, because of its varying distance from the sun, are of relatively little importance in comparison with effects which result from the inclination of the axis. At the present time, the northern hemisphere has its summers when the earth is farthest from the sun (aphelion), and its winters when it is nearest (perihelion). The southern hemisphere, on the other hand, has its summers when the earth is nearest the sun and its winters when it is farthest from it. This condition of things is reversed every 10,500 years. At the present time, the southern hemisphere receives more heat from the sun in a day at the time of the winter solstice in the northern hemisphere, than the northern hemisphere does at the time of its summer solstice. The difference is considerable.

**Effect of altitude on temperature.** High altitudes are colder than low ones, and the average rate of decrease of temperature is about  $1^{\circ}$  F. for 330 feet ( $1^{\circ}$  C. for 594 feet) of rise, for altitudes where observations are common. It varies, however, from time to time and from place to place, being especially influenced by the temperature of the surface beneath it. The rate of decrease of temperature for the first 100 feet or so of rise at the bottom of the atmosphere is much more rapid where the land or water is warm.

The average decrease of temperature with increase of altitude is about 800 times as rapid as its decrease with increase of latitude. In other words, one mile of ascent in the air means about the same decrease of temperature as a poleward movement of 800 miles.

When air rises it expands, because there is less weight of air above it tending to compress it. As a gas expands it is cooled, and as it is compressed it is warmed. Dry air should be cooled about  $1^{\circ}$  F. for every 183 feet it rises ( $1^{\circ}$  C. for 329 feet). Moist air cools much less rapidly with expansion, for reasons which will appear later (p. 572). Conversely, air is warmed as it descends and becomes denser. The presence of moisture makes much less difference in the case of descending air, which is warmed at about the same rate as dry air is cooled during its ascent.

High altitudes are colder than low, primarily because the air is thinner; but, in the case of isolated elevations, also because of the more complete exposure.

Since the air is thinner, it (*a*) absorbs less heat from the direct rays of the sun, chiefly because there is less carbonic-acid gas, less

water vapor, and less dust; and (b) being thinner, it is less effective in retaining the heat radiated from the earth below.

In sunny days in summer the sunny sides of bare mountain surfaces, when free from snow, get very warm. If the air remained in contact with the warm rock surface for long periods of time, it would be notably warmed; but since it is, as a rule, moved on quickly, especially about isolated elevations of notable height, it is not greatly heated before it passes on, and the new air by which it is replaced is much colder than air which has been resting directly on the land.

On the other hand, there are likely to be many cloudy days in the mountains, and the clouds shelter the rocks from the sun. This tends to reduce the *average* temperature of the mountain, as compared with that of low land.

Again, where mountains are sufficiently high and not too steep to retain snow throughout the year, *their surfaces are never warmed*



FIG. 537.—Diagram to show that the sun's rays may fall less obliquely on a mountain slope than on the plain adjacent. Under these circumstances they have greater heating power, so far as the surface of the land is concerned, on the mountain than on the plain.

above a temperature of  $32^{\circ}$  F., the melting-point of snow (p. 525). The temperature has been observed in balloons up to elevations of about 30,000 feet, where it was found to be  $-54^{\circ}$  F. This is doubtless much colder than it would be at the top of a mountain 30,000 feet high, and very much colder than it would be on a plateau at that elevation. The temperature has been recorded by self-registering thermometers in balloons set up to altitudes of ten miles, where the temperature was  $-104^{\circ}$ .

It is to be noted that land surfaces at high altitudes may be heated quite as effectively by the sun as land surfaces at low altitudes. That this is the case is shown by familiar experiences in high mountain regions, where the surface of the rock may be very warm though the air is cool. A mountain surface such as that shown in Fig. 537 may receive the sun's rays much more



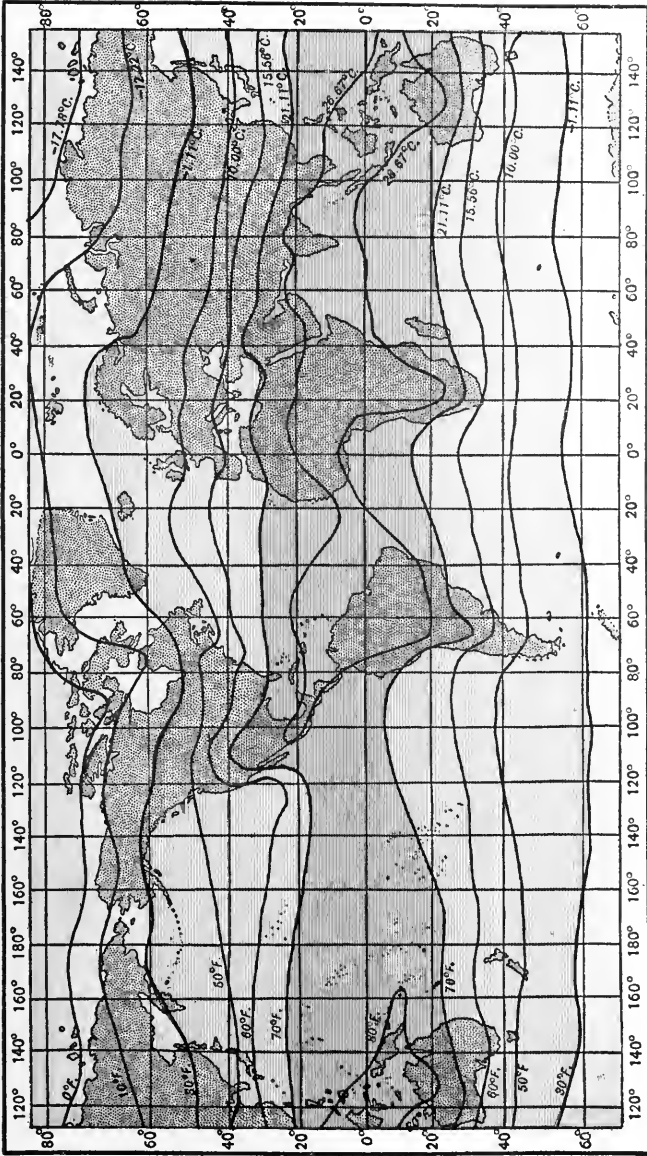

Fig. 538.—Average annual temperature. (After Buchan.)



perpendicularly than a flat surface. The rock is correspondingly heated while the sun shines; but as the sun goes down, the heated rock surface cools readily, and may, during the night, become much cooler than the surface of the lower land.

It is to be noted that only the equatorward sides (the southern sides in the northern hemisphere and the northern sides in the southern hemisphere) of mountains receive the sun's rays more perpendicularly than a flat surface. The poleward slopes of mountains (outside tropical latitudes and sometimes within them) receive the sun's rays much more obliquely than flat surfaces, and they receive them fewer hours per day. This serves to reduce *the average temperature of mountain regions*.

#### *Representation of Temperature on Maps*

It is desirable to have some method of representing not only the general distribution of temperature over the earth, but various other facts concerning temperature and its variations. Maps showing such phenomena are *thermal maps* or *charts*. The principle of thermal charts is simple.

**Isotherms.** A line may be drawn on the surface of the earth connecting points having the same temperature. Such a line is an *isotherm*. An isotherm connecting places having the same average temperature for the year is an *annual isotherm*. An isotherm connecting places which have the same summer or the same winter temperature is a *seasonal isotherm*. Similarly there may be monthly isotherms, daily isotherms, etc. A map showing the distribution of isotherms for a year, a season, a month, or a day, is an isothermal map or chart.

The line of highest temperature about the earth is the *thermal equator*. This line is not straight, and in general it lies a little north of the geographic equator.

**Isothermal charts.** Fig. 538 shows the annual isotherms. It shows an isotherm of  $80^{\circ}$  enclosing a considerable area in the tropical region extending from the Americas eastward to northern Australia. This isotherm shows that all points enclosed by it have an average temperature of more than  $80^{\circ}$ . There are two isotherms of  $70^{\circ}$ , one north of the equator and one south of it. All points between the isotherm of  $70^{\circ}$  and the isotherm of  $80^{\circ}$  have an average annual temperature of more than  $70^{\circ}$  and less than  $80^{\circ}$ . In the Pacific, all points between the two  $70^{\circ}$  isotherms

have a temperature of more than  $70^{\circ}$  and less than  $80^{\circ}$ . The map also shows two isotherms of  $50^{\circ}$ , one in the northern hemisphere and one in the southern. All points between the isotherms of  $50^{\circ}$  and  $70^{\circ}$  have an average temperature between these limits. The warmer portion of these zones in either hemisphere is the portion near the higher isotherm, that is, nearer the equator.

The chart expresses the general fact that the temperatures are higher in the equatorial regions and lower toward the poles, and this shows that there is a relationship between isotherms and latitude. The reason for this relationship has already been explained.

Fig. 539 shows the isotherms for the month of January. As compared with the preceding map, this shows that the zone of highest temperature, and all isotherms, have been shifted to the south. The fact that the sun is shining vertically some distance south of the equator at this season, seems to be a sufficient reason for the change. This conclusion may be tested by referring to the isothermal chart for July (Fig. 540), for if the conclusion be right, the thermal equator and all isotherms should there be found farther north than in Fig. 538 or Fig. 539. Fig. 540 shows this to be the case.

Fig. 539 shows that the thermal equator is mostly south of the geographic equator in January, and Fig. 540 shows that the thermal equator is wholly north of the geographic equator in July. In the former case it is in latitude  $20^{\circ}$  S. (nearly) in South Africa, and in the latter in latitude  $40^{\circ}$  N. (nearly) in southwestern Asia. In both charts it is farther from the equator on land than on sea. In Africa, the thermal equator is fully  $40^{\circ}$  farther north in July than in January, and in the Americas the shifting is still greater.

A comparison of Figs. 539 and 540 shows that the range of temperature between January and July is greater in high latitudes than in low. Thus in the southern part of Hudson Bay it is  $80^{\circ}$ ; at Montreal about  $50^{\circ}$ ; in Florida less than  $30^{\circ}$ ; and at the equator in South America, less than  $10^{\circ}$ . The same charts show that the range is greater in the interiors of continents than on coasts or over the sea in the same latitude.

The general distribution of atmospheric temperature in latitude is shown in Fig. 541.

**What determines the positions and courses of isotherms?**

1. A relationship between isotherms and parallels is suggested further by the fact that the isotherms have a general east-west direction.

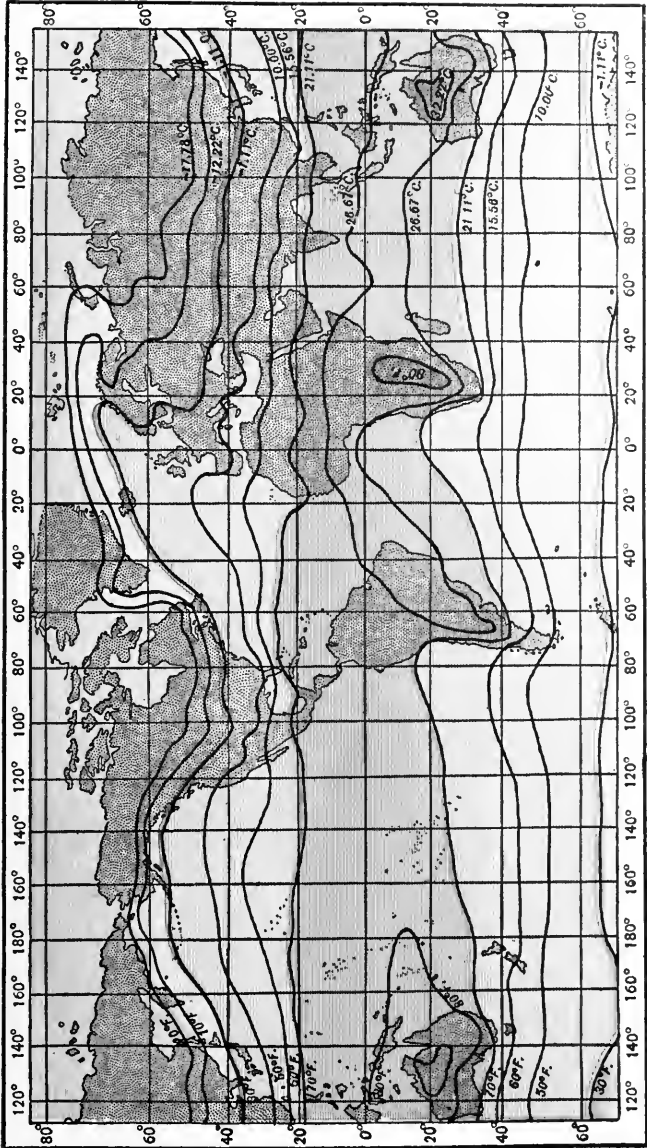

FIG. 539.—Isothermal chart for January. (After Buchan.)



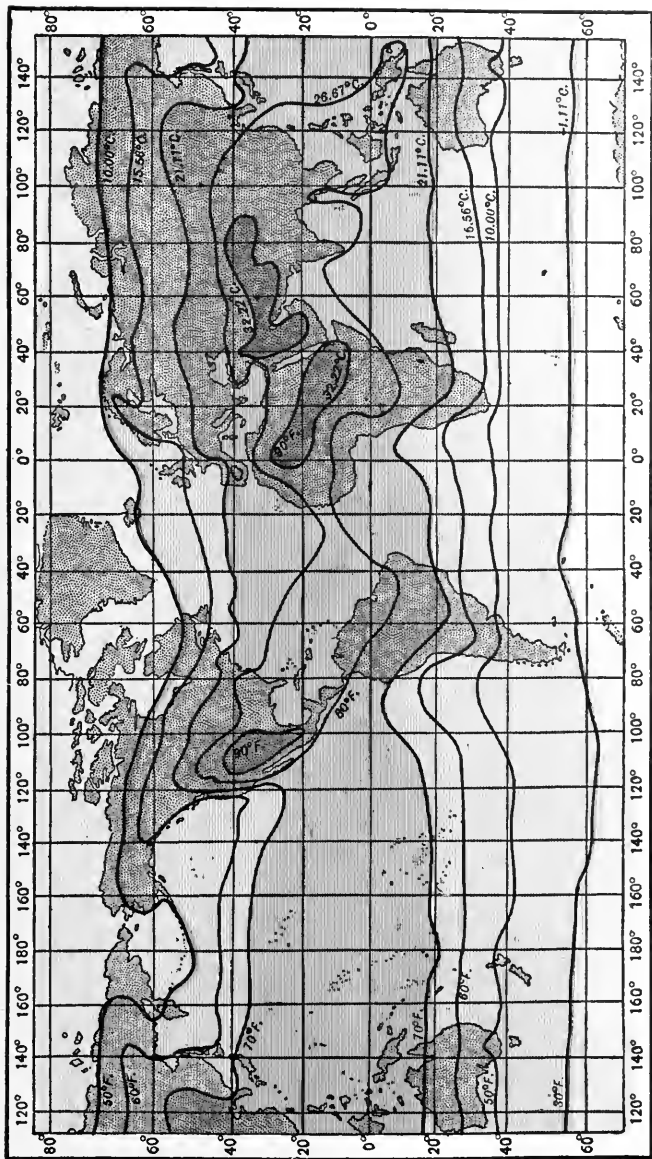

FIG. 540.—Isothermal chart for July. (After Buchan.)





Some of them are notably irregular, but none of them runs north and south, or anywhere nearly north and south, for any considerable distance. Some of them have a nearly straight east-west course, and, in all, the east-west direction is the general one. Since, however, the isotherms do not follow the parallels exactly, it is clear that latitude is not the only factor which determines their position.

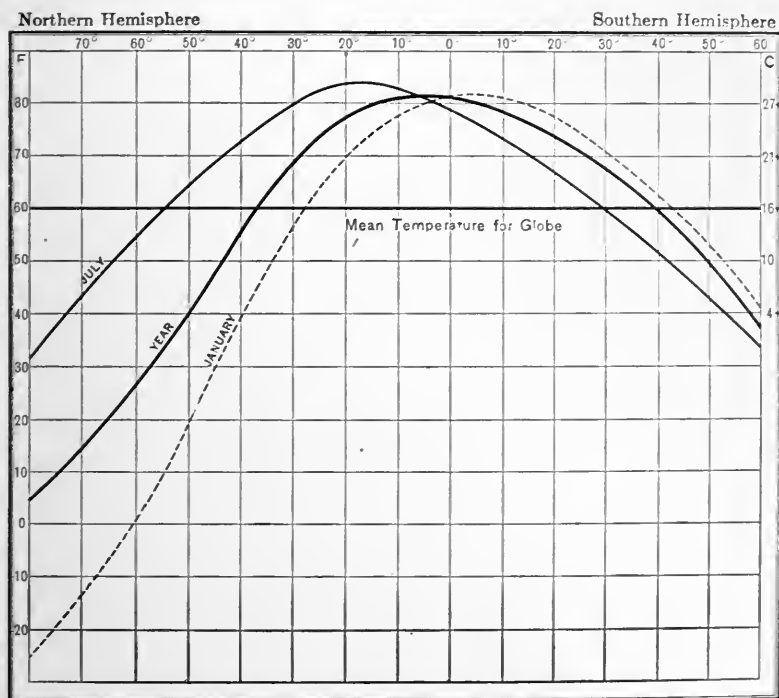

FIG. 541.—Figure showing distribution of atmospheric temperature in latitude for the year, for January, and for July; also the mean temperature of the year for the globe. The figures at the left are Fahrenheit, those at the right Centigrade. The numbers at the top represent degrees of latitude.

Some other cause or causes besides the length of day and the angle of the sun's rays must therefore influence temperature, and so the position of the isotherms.

2. From Figs. 538, 539, and 540 it is seen that the isotherms are straightest where there is least land, and most crooked where there is much land. This suggests that the *land and water* have something to do with their positions. Following this idea, it is to be

noted that, on the January chart, there is an area in South Africa, and another in north Australia, surrounded by the isotherm of  $90^{\circ}$ . Both of these areas are on land, and there is no corresponding area over the sea. It is to be noted also that the areas where the temperature is above  $80^{\circ}$  are wider on the land, and in the vicinity of land, than on the open sea; and furthermore, that in the widest ocean there is no area where the January temperature reaches an average of  $80^{\circ}$ . All these facts tend to confirm the conclusion that the sea and the land influence the position of the isotherms.

Following this idea still further, it is seen that the isotherms of this map (Fig. 539) frequently bend somewhat abruptly in passing from water to land, or *vice versa*. Thus the isotherm of  $40^{\circ}$  in the northern hemisphere turns abruptly to the south when it reaches North America, and again on the coast of Europe. In the southern hemisphere, the isotherms of  $80^{\circ}$  and  $70^{\circ}$  make abrupt turns at the west coast of Africa and on or near the west coast of South America. This tends to confirm the conclusion that the relation of land and water has something to do with the position of isotherms. It will be seen later that ocean currents have something to do with the peculiar courses of the isotherms here referred to.

So far as this chart (Fig. 539) is concerned, it will be seen that the isotherms south of the equator bend poleward on the land in passing from west to east, while those north of the equator bend equatorward.

The land and the sea are affected differently by the sun's rays (p. 530). The land is heated more readily than the sea in the summer, and therefore becomes warmer. The land also gives up its heat much more readily than the sea, and becomes cooler in winter. The fact that an isotherm, for example the January isotherm of  $40^{\circ}$  in the northern hemisphere, bends equatorward in crossing the northern continents, shows that the land is cooler than the water in the same latitude, for the isotherm, in crossing the continent, bends toward the equator to find the same temperature which it had on the water. In the southern hemisphere, on the other hand, where it is summer, the corresponding isotherm, on reaching the land, bends toward the pole in order to find a temperature like that of the sea.

All these phenomena clearly indicate that the position of the land and the sea has something to do with causing the isotherms to depart from the parallels.

If the preceding inferences are correct, the July isotherms should be in contrast with the January isotherms. The former should bend poleward on the continents in the northern hemisphere, and equatorward in the southern. In Fig. 540, which shows the July isotherms, it is seen that every isotherm crossing North America bends poleward on the land, while those crossing the southern continents bend equatorward. The reason is that this is the season when the lands of the northern hemisphere are warmer than the seas of the same latitude, and when the lands of the southern hemisphere are cooler than the seas about them.

It will be noted that the irregularities of the isotherms of the northern hemisphere in July are much greater than those of the southern hemisphere in January. This is probably because there is much more land in the northern hemisphere than in the southern, and the larger land areas have a greater effect on the isotherms than the smaller ones.

These facts seem to confirm the inference that land and water influence the position of the isotherms; but does the distribution of land and water account for all the irregularities of the isotherms?

If the unequal heating of land and sea were the only factor concerned in deflecting the isotherms from the parallels, the bends of the isotherms should be as pronounced on the east sides of the continents as on the west. This is not the case, as shown by Figs. 538 and 539. Again, the January isotherm of  $50^{\circ}$  near the west coast of North America bends chiefly on the land, not at the coast. On the eastern side of the continent the bend of the isotherm of  $30^{\circ}$  is chiefly on the sea, not at the coast. Other isotherms have similar courses. We infer, therefore, that though land and water have much to do with the irregularity of the isotherms, other factors also are involved.

3. The peculiarities just cited may be explained in part by the *winds*. The prevailing winds in the middle latitudes of North America are from the west, and the westerly winds tend to carry the temperature of the sea (warmer in winter) over onto the land on the western side of the continent, and the temperature of the land (cooler in winter) over onto the sea on its eastern side. This appears to afford a partial explanation of the bends of the isotherms of  $30^{\circ}$  and  $50^{\circ}$  in the northern hemisphere in January; but it does not afford an explanation of the remarkable northward

loop of the isotherm of  $30^{\circ}$  over the eastern side of the North Atlantic, nor of the lesser one over the corresponding part of the Pacific.

Other illustrations of the effects of winds are furnished by the west coast of the United States. Thus in July (Fig. 540) the land is warmer than the sea, and the cooler temperature of the latter is carried over to the former. The winds therefore make it clear why the bends in the isotherms here are on the land, rather than at the coast or on the sea.

On the whole, the influence of the winds on the position of the isotherms is less clear from these charts than the influence of land and sea. This is partly because the winds are inconstant, and their effects at one time tend to counteract their effects at another, and the maps show only averages.

4. The great bend in the isotherm of  $40^{\circ}$  in the North Atlantic in January is not explained by the relations of land and sea, or by winds. It is due to a warm current of ocean water flowing north-eastward, in the direction of the pronounced loop of the isotherm. The same isotherm is held off the eastern coast of North America by a cold current which flows southward along the east side of the continent. *Ocean currents* are, therefore, a fourth cause of the irregularities of isotherms.

The amount of heat carried northward by the ocean currents of the Atlantic and Pacific is very great. Croll<sup>1</sup> has estimated that conveyed from the tropics by the Gulf Stream to be equal to two-fifths of that received by the Arctic regions from the sun. It has been estimated that the temperature of England is raised  $10^{\circ}$  F., that of Norway  $16^{\circ}$ , and that of Spitzbergen  $19^{\circ}$  by the warm poleward movement of waters in the North Atlantic. These figures have been called into question and are very likely too high; but there can hardly be a reasonable doubt that the northward movement of relatively warm water helps to ameliorate the temperature of northwestern Europe, especially in winter. The tempering influence of the poleward drift<sup>2</sup> of warm water is indirect. The air over the water is warmed and made moist, and

<sup>1</sup> Climate and Time, p. 27.

<sup>2</sup> The term "Gulf Stream" is of doubtful propriety as applied to the poleward movement of water in the high latitudes of the North Atlantic. The "current" is very indefinite north of the latitude of Newfoundland.

it is this warmed and moistened air, carried over to the land, which raises the temperature of northwestern Europe.

It should be noted that the milder climate of northwestern Europe, as compared with northeastern North America, is not due wholly to the poleward drift of warm waters. Even if there were no Gulf Stream, the climate of northwestern Europe would be much more temperate than that of the corresponding latitudes of North America, because the ocean, whence the winds of winter blow to that part of Europe, is warmer than the land whence the winter winds blow to the corresponding latitudes on the west side of the Atlantic. Similarly the heat of summer is less extreme in northwestern Europe than in northeastern North America.

5. Other minor causes of irregularities in isotherms are found in *topographic relations*, in the *character of the surface*, the *amount of moisture*, etc. A basin region shut in by mountains gets hotter in summer than a region not so surrounded, partly because the air is warmed by heat reflected and radiated in from all sides, as well as by heat reflected and radiated from the bottom, and partly because the enclosing mountains prevent free circulation of the air. There is less evaporation from a dry surface than from a moist one, and since evaporation cools the surface notably, a dry surface will be warmer than a moist one, if other conditions are the same. The color of the soil, the presence or absence of vegetation, etc., also affect the absorption and radiation of heat.

Topographic relations have much to do with the high temperature ( $90^{\circ}$  and above) in the southwestern part of the United States in July. The dryness of the soil and of the air above it also tends to raise the temperature. Aridity also helps to make the temperature high in the high-temperature area ( $90^{\circ}$  and above) in northern Africa (July) and Australia (January).

**Altitude** has a pronounced effect on temperature, as already pointed out; but a study of Figs. 538 to 540 seems to show no relation between isothermal lines and surface relief. The reason is that on isothermal charts all isothermal lines are represented as at sea-level. This is done by making allowance for altitude at the average rate of  $1^{\circ}$  F. for about 330 feet. Thus, if the temperature of a place at an altitude of 3300 feet is  $60^{\circ}$ , it is put down on the chart as  $70^{\circ}$  ( $60^{\circ}+10^{\circ}$ ). If the place were 6600 feet above sea-level,  $20^{\circ}$  F. would be added to the temperature recorded by the thermometer. Isothermal charts, therefore, are intended to

show the temperature as it would be if the land were at sea-level.

Thermal charts may be made to show many other features. A chart may be made to show the departure of the temperature of each place, from the temperature normal to its latitude. Such departure is *abnormal temperature*. Lines connecting places having the same abnormal temperature are *is-abnormal* or *is-anomalous lines*. They may be made for the year, for any season, or for any month (Figs. 542 and 543). Charts may be made showing the lines of equal annual range of temperature (Fig. 544), and they may also be made to show the *average maximum* temperatures (Fig. 545) and the *average minimum* temperatures (Fig. 546). The former are obtained by averaging the highest temperatures of successive years, and the latter by averaging the lowest temperatures of successive years. The *absolute maximum* and *minimum* for any place would be the highest and lowest temperatures, respectively, ever recorded for that place. Fig. 547 shows the absolute maximum temperature to be more than  $120^{\circ}$  in the Sahara, and but little less in New South Wales and the southwestern part of the United States. The lowest temperature recorded is in northeastern Asia.

**Isothermal surfaces.** A surface might be drawn connecting all points having the same temperature. The annual isothermal surface of  $30^{\circ}$ , for example, would be at sea-level, where the isotherms of  $30^{\circ}$  appear in Fig. 538. One of these isotherms is north of the equator and one south of it. Equatorward from these lines, in either hemisphere, the isothermal surface would rise above sea-level. The temperature at sea-level in the northern part of South America is about  $80^{\circ}$ . Its temperature is therefore about  $50^{\circ}$  above that of the isothermal surface of  $30^{\circ}$ . That surface is here about 50 times 330 feet, or 16,500 feet, above sea-level. Where the isotherm of  $50^{\circ}$  (Fig. 538) crosses North America, the temperature at sea-level is  $20^{\circ}$  too high. To find the temperature of  $30^{\circ}$  in this latitude we must rise high enough into the air to get a reduction of  $20^{\circ}$ ; that is, 20 times 330 feet, or 6600 feet.

North of the isotherm of  $30^{\circ}$  in the northern hemisphere (Fig. 538) the temperature at sea-level is less than  $30^{\circ}$ . To find a temperature of  $30^{\circ}$  in this latitude, therefore, we must go beneath sea-level.

The rate of increase of temperature below sea-level is not the same as above it, and it is not the same for the land as for the sea. Beneath the land the rate of increase is about  $1^{\circ}$  F. for 60 to 75 feet. (The observed rates of increase beneath the surface vary



Fig. 542.—Chart showing the is-abnormal temperatures for January. The minus signs indicate temperatures below the average. (After Batchelder.)

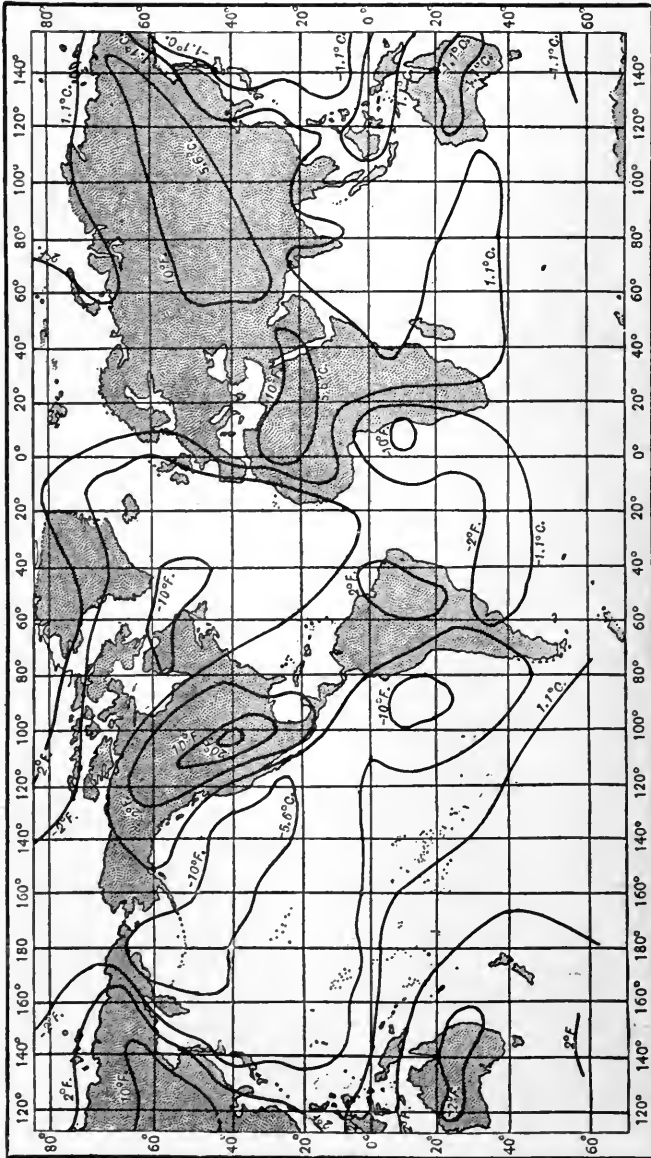

FIG. 543.—Chart showing the is-annual temperatures for July. The minus signs indicate temperatures below the average. (After Batchelder.)



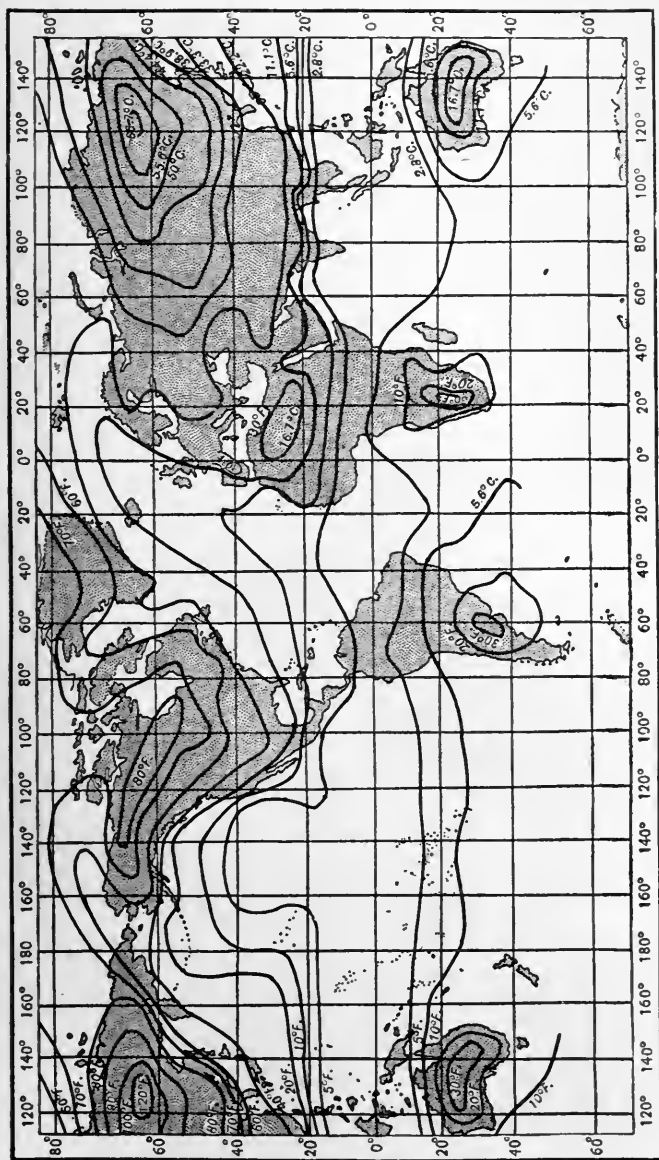

FIG. 544.—Chart showing annual mean range of temperature. (After Conolly.)

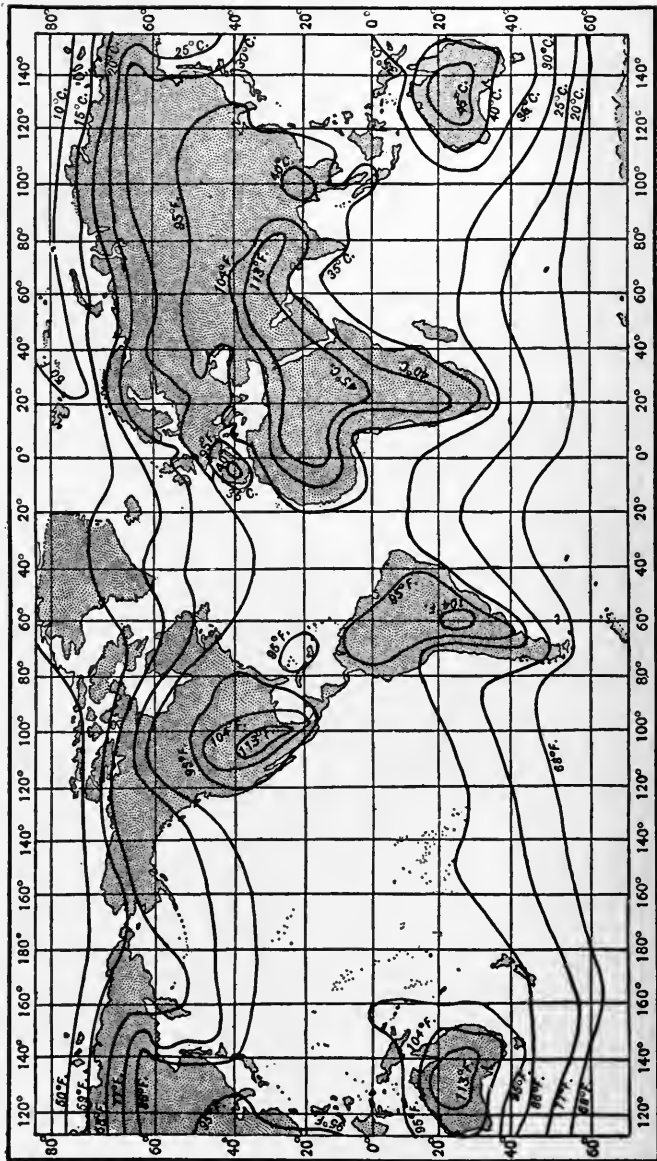

Fig. 545.—Chart showing average annual maximum temperatures. (After van Beber.)

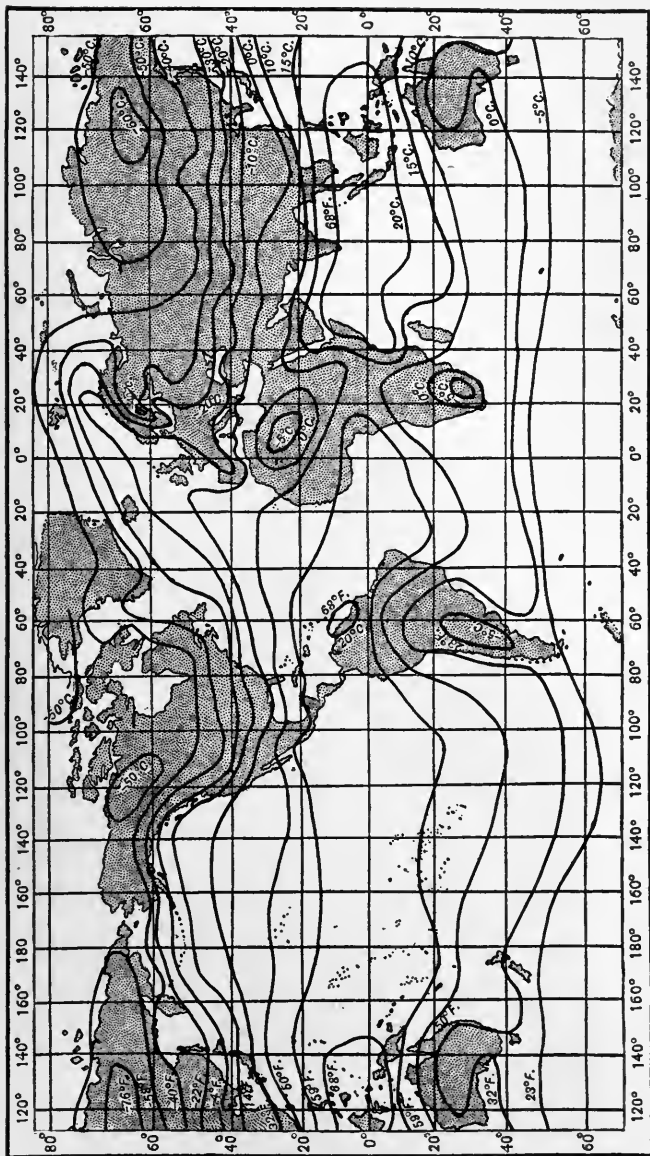

FIG. 546.—Chart showing average annual minimum temperatures. (After van Beber.)

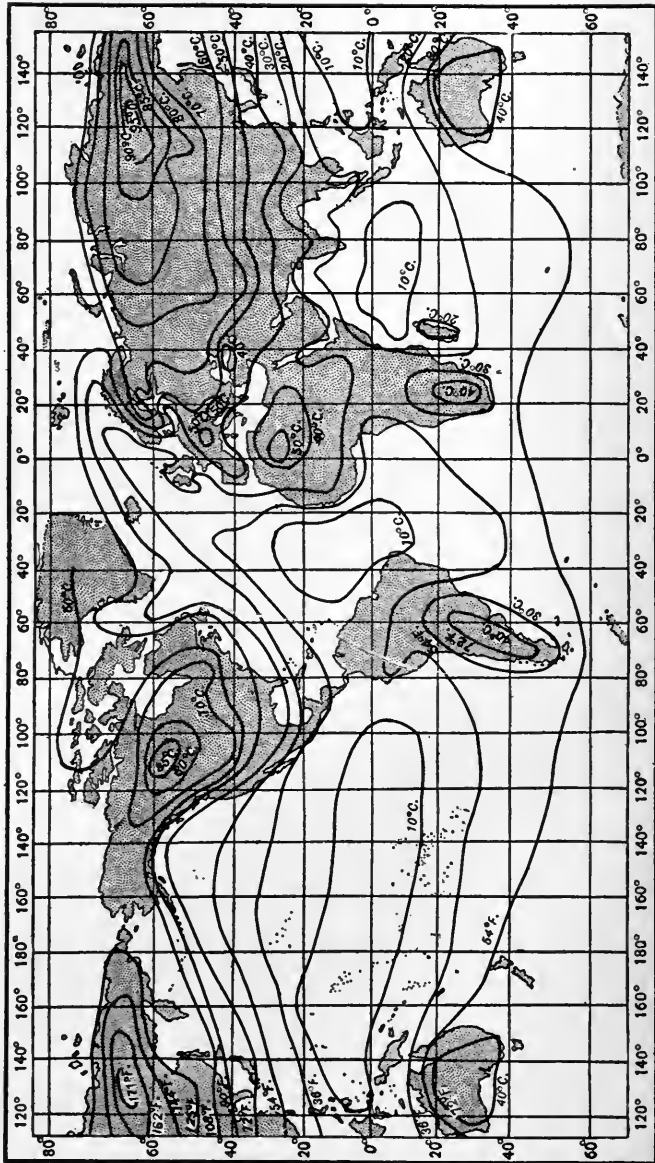

FIG. 547.—Extreme annual range of temperature. (After van Beber.)

from about  $1^{\circ}$  F. for 17 feet, to  $1^{\circ}$  for more than 100 feet.) To find the isothermal surface of  $30^{\circ}$  F. where the isotherm of  $20^{\circ}$  F. crosses the continent, we should have to go down far enough to gain  $10^{\circ}$  F. This would be 600 feet if the rate of increase is  $1^{\circ}$  for 60 feet, or 1000 feet if the rate be  $1^{\circ}$  for 100 feet.

The proper conception of isothermal surfaces will be of importance when we come to consider the circulation of the atmosphere.

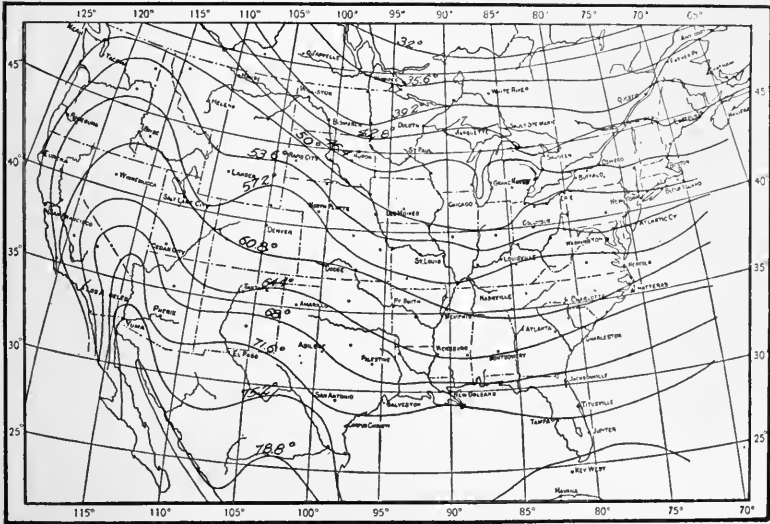

FIG. 548.—Isothermal chart of the United States for the year.  
(U. S. Weather Bureau.)

Fig. 554 shows sections of the isothermal surfaces, along the meridian of  $100^{\circ}$  in January and July. These sections are based on the data of Figs. 539 and 540.

It will be seen from the above that isothermal lines are the lines where the corresponding isothermal surfaces touch the level of the earth which corresponds to sea-level.

#### *Daily Range of Temperature*

It has been found by experience that the average daily temperature of a place may be found by averaging the temperatures of 7 A.M., 2 P.M., and 10 P.M. It is found that the daily range is less above the bottom of the atmosphere than at the bottom, since the lower air is heated much by contact with the land during sunny

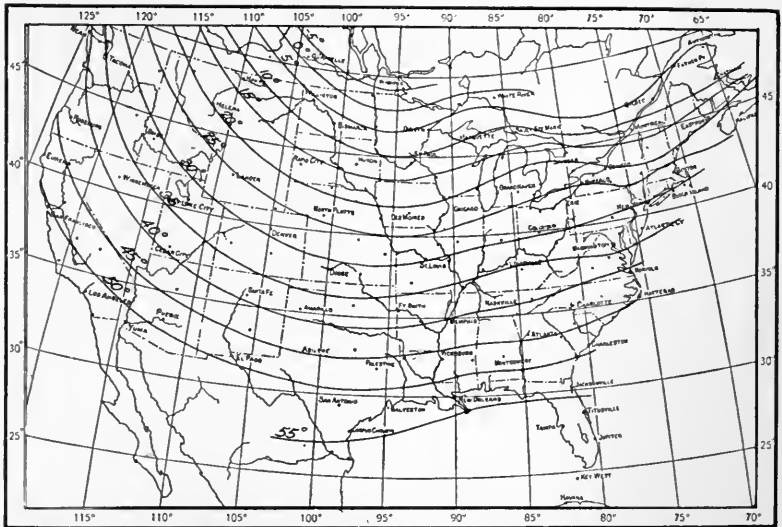

FIG. 549.—Isothermal chart of the United States for January.  
(U. S. Weather Bureau.)

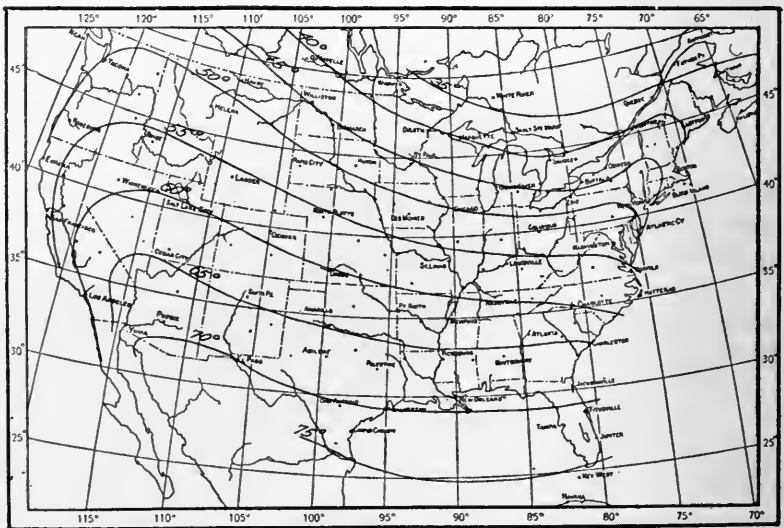

FIG. 550.—Isothermal chart of the United States for April.  
(U. S. Weather Bureau.)

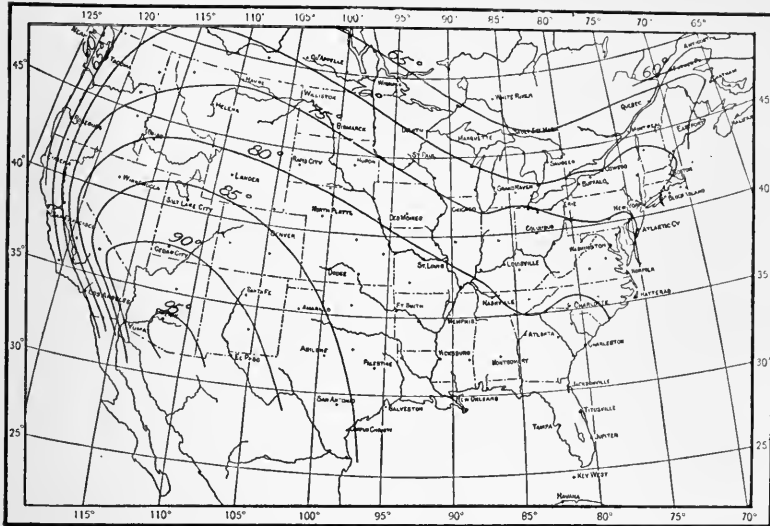

FIG. 551.—Isothermal chart of the United States for July.  
(U. S. Weather Bureau.)

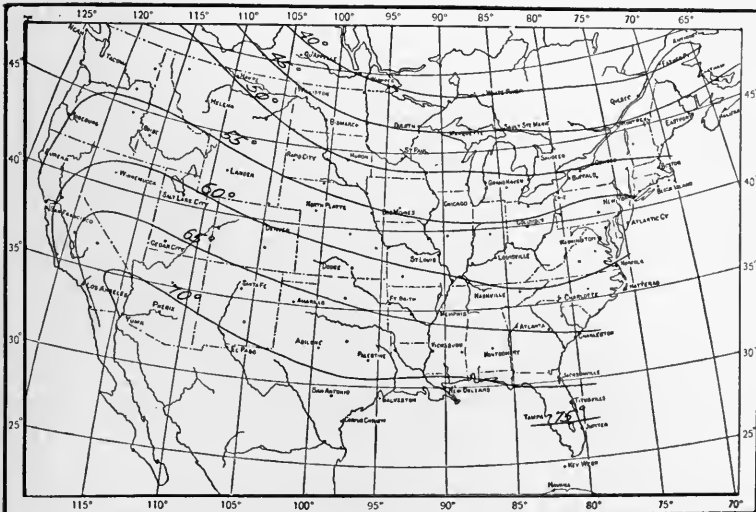

FIG. 552.—Isothermal chart of the United States for October.  
(U. S. Weather Bureau.)

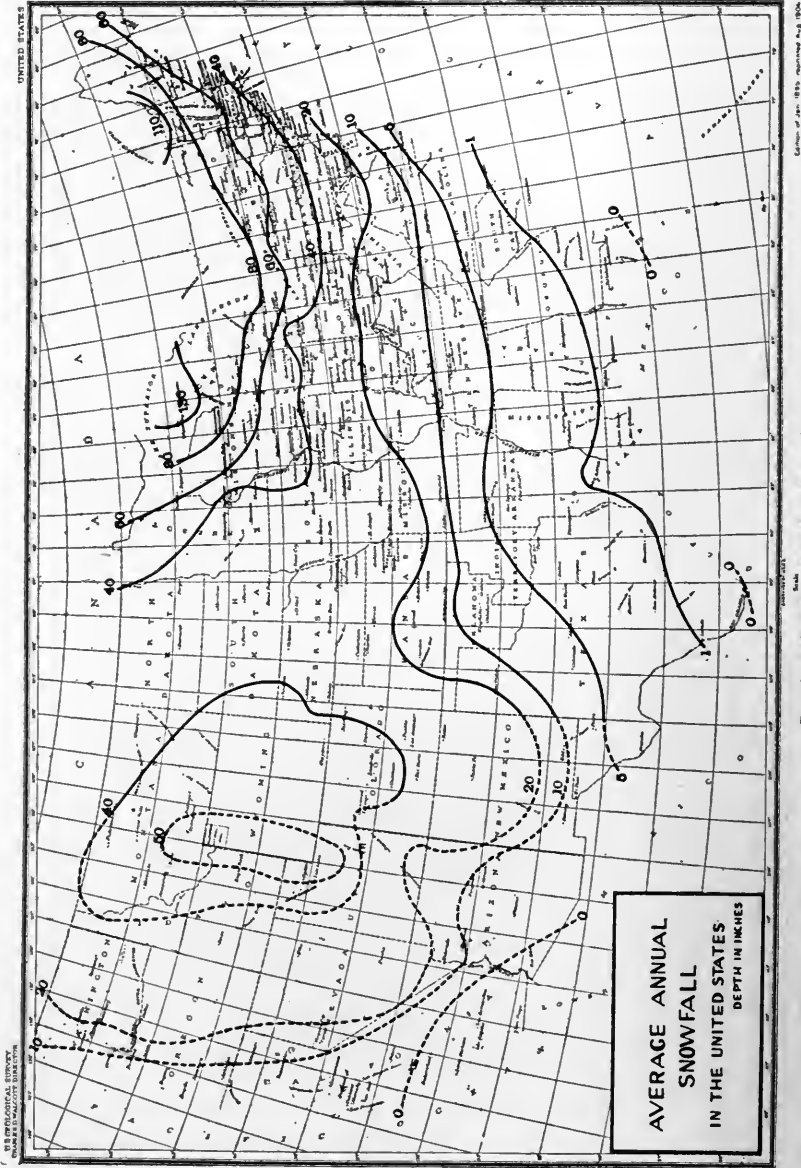

Fig. 553.—Average annual snowfall in the United States (Cox, U. S. Weather Bureau.)



days, and also because the denser air below is heated more than the rarer air above by direct insolation. It is also found that the daily range is greater when the air is dry than when it is moist, for in the former case less of the heat radiated from the land is absorbed by the air. The daily range is greater far from the sea than in proximity to it, for the sea gets neither so warm nor so cold as the land. Other things being equal, the daily range is greatest when days and nights are nearly equal.

The daily range of temperature is often as much as  $40^{\circ}$  or  $50^{\circ}$  F. in dry, interior regions, and in the Sahara it is sometimes  $70^{\circ}$ .

The temperature of the day is highest somewhat after noon, for somewhat the same reason that the greatest heat of summer follows the time of greatest heating. To understand this point it should

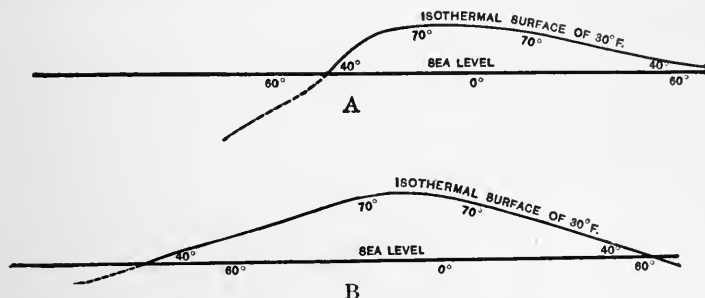

FIG. 554.—Curves of the isothermal surface of  $30^{\circ}$  F. A. Along the meridian of  $100^{\circ}$  W., corresponding to Fig. 539. B. Same, corresponding to Fig. 540. The numbers below the horizontal line indicate latitude.

be understood that the land surface and the air just above it are losing heat by radiation all the time, and receiving heat by insolation only when the sun shines.

Let us suppose the day to be twelve hours long. When the sun rises, the daily heating begins, and the rate of heating increases as the sun climbs above the horizon. The land and the air receive most heat when the sun is highest, that is at noon. After noon the heating becomes less and ends at sunset. Fig. 555, A, shows the curve of insolation.

When cooling by radiation exceeds heating, the temperature falls. This is the case, as a rule, at night, for radiation goes on after insolation ceases. The temperature becomes lowest about sunrise, when radiation without insolation has been going on longest

The land and the lower air continue to radiate heat after sunrise, but both are then heated, and heated as a rule faster than they are cooled by radiation, for the temperature rises. As the temperature rises, radiation increases (Fig. 555, B); but it does not commonly keep pace with insolation, for the temperature continues to rise till some time after noon. The fact that the temperature then begins

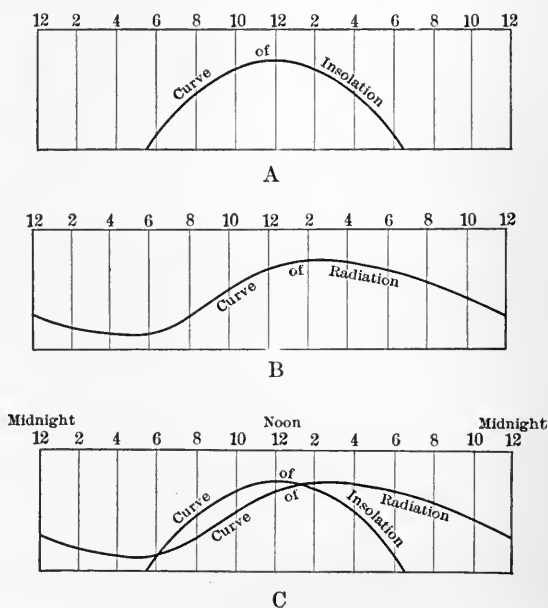

FIG. 555.

- A. Curve of insolation.                      B. Curve of radiation.  
 C. Curves of insolation and radiation combined. The maximum temperature of the day occurs at the higher crossing, the minimum temperature of the day just to the left of the lower crossing of these two lines.

to fall shows that radiation then exceeds insolation. Fig. 555, C shows the curve of insolation in its relation to the curve of radiation.

The average daily range of temperature by months for six places is shown in Fig. 556. San Diego, Phoenix, Shreveport, and Charleston are in about the same latitude (about  $33^{\circ}$ ). All are in the zone of westerly winds. San Diego, on the Pacific coast, has an average daily range of about  $14^{\circ}$  F. Phoenix, which is inland, much higher, and in a dry region, has an average daily range of about  $33^{\circ}$ . Shreveport, which is inland, but low, and in a region

of abundant moisture, has an average daily range of about  $17^{\circ}$ . Charleston, on the eastern coast, has a daily range of about  $14^{\circ}$ . Tampa and San Antonio are farther south, and both are affected somewhat by the trades. Tampa is on the coast, while San Antonio

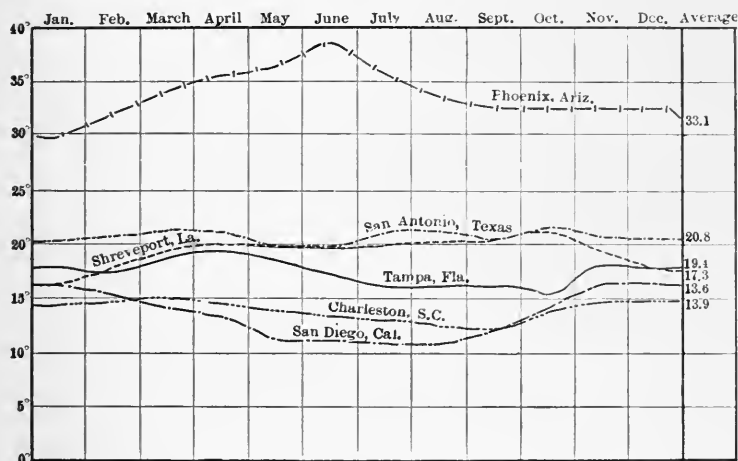

FIG. 556.—Curve showing the average daily range of temperature for certain type stations, for each month. The figures at the right show the average daily range for each station. The great range at Phoenix is the result of high altitude and aridity. (U. S. Weather Bureau.)

is inland. The former has an average daily range of about  $19^{\circ}$ , while the latter has a range of about  $21^{\circ}$ .

### *The Seasonal Range of Temperature*

The seasonal range of temperature is affected by various conditions, such as (1) latitude, (2) position with reference to land and sea, (3) prevailing winds, (4) presence of snow during the warmer season, and (5) humidity.

1. In general the seasonal range of temperature increases with the latitude (compare Figs. 539 and 540), because the range of insolation increases with the latitude. This range is greatest at the poles, where there is six months of insolation and six months free from it. The great range of seasonal temperature to which the poles would be entitled by their latitude is greatly modified by (2) and (4) of the preceding paragraph.

2. Islands have a lesser range of temperature than continental lands in the same latitude, and coasts have a lesser range than

interiors, because the range of sea temperature is less than the range of land temperature (Fig. 557). A striking and rather extreme illustration of the difference between the range of temperature on an island and inland is afforded by Thorshavn (Faroe Islands, Lat.  $62^{\circ}$  N.), where the annual range is  $7.9^{\circ}$  C., and Yakutsk, in the same latitude, where the range is  $61.6^{\circ}$  C.

3. A coast to which the prevailing winds blow from the ocean has a less range of temperature than a coast to which the prevailing winds blow from the land. Thus the range of temperature is less on the Pacific coast of the United States than on the Atlantic in the

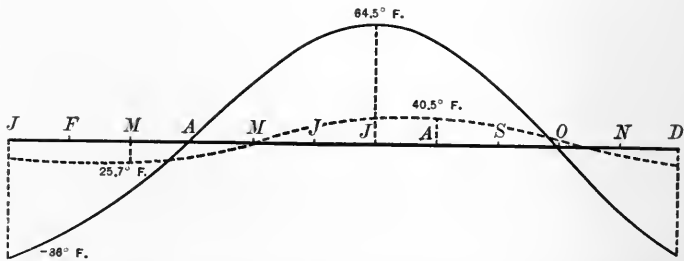

FIG. 557.—Diagram illustrating the difference between continental and oceanic temperatures, the former indicated by the full line and the latter by the dotted line. The letters stand for the months. The numbers are the degrees above and below the average annual temperature of the place. (After Hann.)

same latitude, the winds being chiefly from the west in both cases. Hann has shown that in Europe, between the latitudes of  $47^{\circ}$  and  $52^{\circ}$ , the temperature changes from west to east are as follows: With every  $10^{\circ}$  of longitude there is a decrease of  $3.1^{\circ}$  C. in winter, an increase of  $0.7^{\circ}$  C. in summer, and a decrease of  $1.3^{\circ}$  C. in the mean annual temperature.

4. The presence of snow during the warm season, as in high latitudes and high mountains, prevents a high temperature in summer, even though insolation be strong (p. 525).

The annual range of temperature is of much importance on various human affairs. It has some effect on vegetation, and so on all industries connected with the soil. The range of temperature, or more exactly the temperature of winter, has some effect on transportation, especially transportation by means of water. Navigation ceases, for example, on the Great Lakes, because ice forms about their borders in winter. The lower limit of temperature also

affects some phases of mining. Placer mining, for example, is suspended in winter in high latitudes and high altitudes, not only because the gravel and sand are frozen, but also because the water needed in the mining is frozen. Other effects of great seasonal range will be readily suggested.

### *Effect of Atmospheric Temperature on Atmospheric Movement*

When air is heated it expands and becomes lighter, volume for volume. If we think of the air over a given area as shut in from its surroundings on all sides, but not shut in above, it would expand upward when heated. The result would be that its surface would rise above that of its surroundings. If its surface became higher than that of its surroundings, the upper part of the air would spread (run over) sideways, much as water would under the same circumstances. If some of the air at the top of a heated column runs over, the pressure of the air at the bottom of the heated column is less than that at the bottom of the surrounding air, and, if the air of the surrounding area were not shut off, it would move in from the area of greater pressure (where the air is denser) to the area of less pressure (where the air is lighter). The result would be a horizontal movement at the bottom of the atmosphere (Fig. 534); that is, a *wind*. *Unequal heating of the air is, therefore, a cause of air movements*, and since the air is being unequally heated constantly, it follows that *unequal heating is a constant cause of atmospheric movement*. Some of the movements are horizontal and some vertical; some are in the lower part of the air and some in the upper.

The unequal heating of the air is the immediate cause of certain familiar winds and breezes.

1. *Land- and sea-breezes*. During a sunny summer day the land near a lake or sea becomes warmer than the water. The result is that the air over the land becomes sensibly warmer than that over the water on a hot day. The expanded lower air over the land crowds the air above it, and so increases the pressure *above the bottom of the air*. The result is that the pressure above the bottom of the air over the land is greater than that at the same level over the sea. There is, as a result, (1) a movement of air from the land to the water somewhat above the bottom of the air. This movement diminishes the pressure at the bottom of

the air *on land*, and increases the pressure at the bottom of the air *over the sea*. This gives rise to (2) a breeze from sea to land at the bottom of the atmosphere. This is the *sea (or lake) breeze*. At night, the air over the land cools and contracts below, and pressure above becomes less than at the same level over the sea. Above the bottom of the atmosphere, therefore, air flows in (3) from sea to land. This increases the pressure at the bottom of the atmosphere on land, and decreases that at the bottom over the sea. A breeze therefore sets seaward (4) from the land to the sea at the bottom of the atmosphere. This is the *land-breeze*.

The sea-breeze is best developed in middle and low latitudes during the hot part of the day in summer. When it has the same direction as the prevailing wind, it occasionally develops such strength that business is interrupted and people forced to seek shelter. This is sometimes the case at Valparaiso. Along certain coasts fishermen put to sea in the early morning with the land-breeze, and return at night with the sea-breeze. Land- and sea-breezes will be referred to again in connection with atmospheric circulation.

2. *Monsoons*. Some lands near the sea become so much heated in summer that the sea (from-sea) wind continues during the hot season, not merely through the hot part of the day, while the land (from-land) wind holds sway during the winter. This is the case, for example, in India. Such winds, which change their directions with the seasons, are *monsoon winds*.

The monsoon winds of the Indian Ocean exerted a great influence on the early trade of India. European sailing-vessels formerly timed their outward voyages so as to take advantage of the southwest monsoon, and their return voyages so as to take advantage of the northeast monsoon.

3. *Mountain and valley breezes*. At night the air of the mountain tops becomes cold, because of its prompt radiation of heat. It thus becomes denser than the air below, and descends, giving the *mountain* (that is, *from-mountain*) breeze. The downward flow (or blow) of the air is, however, not confined to mountain valleys, but affects the slopes of the mountains generally. In the morning, especially on sunny days, the air next the land becomes heated, and most at the lower levels. It therefore expands upward, and expands more over the lowland than over the mountains. The

result is that air moves toward the mountains at this time of day, and strikes them at such an angle as to be deflected upward. This is the *valley* (really *toward-mountain*) *breeze*. There is also an upward movement of the air from the mountain slope. This air tends to go straight up, but is crowded over against the mountain by the mountain-ward movement, and so strengthens the mountain breeze. At the top of the mountain, horizontal winds take away the air which tends to accumulate there as a result of the valley breeze.

Mountain and valley, and land and sea breezes, and monsoon winds, are not the only ones due to differences of atmospheric temperature, but they afford the simplest illustrations of air movements due to this cause.

**Vertical movements and temperature.** It has been stated already that when air rises it expands, and that as it expands it becomes cooler; and, conversely, that when air descends it becomes denser and warmer. These changes of temperature have an important bearing on the condensation and precipitation of atmospheric moisture, and will be considered in connection with that topic.

## CHAPTER XV

### THE MOISTURE OF THE AIR

THE atmosphere always contains some water vapor, even in the driest deserts. We can neither see nor smell water vapor, nor can we recognize it as such by feeling, though air with much water vapor has a different feeling from air with little.

The presence of moisture in the air, under ordinary conditions, is proved by various familiar phenomena. If a pitcher of ice water is allowed to stand in a warm room, drops of water often appear on the outside of it. This water could have come only from the air. Again, if a vessel of warm air be closed and its temperature lowered sufficiently, the inside of the vessel will become coated with droplets of water. The amount of reduction of temperature necessary to bring about this result is great or slight, according as the amount of water vapor in the air is small or large, or, more exactly, it depends upon the amount which is in the air compared with that which the space occupied by the air is capable of holding. Water vapor sometimes condenses into water in the air, and then becomes visible as clouds or fog.

Water vapor may be looked upon as an atmosphere by itself, for it is distributed very much as it would be if there were no other atmosphere. Water vapor is five-eighths as dense as dry air; that is, a cubic foot of water vapor would weigh five-eighths as much as a cubic foot of dry air under the same conditions of temperature and pressure. The water vapor of the air displaces some of the oxygen, nitrogen, etc., and so makes the air lighter.

**Function of atmospheric moisture.** The function of the moisture in the atmosphere is a most important one. Without it no life could exist. In addition to furnishing the rain, the snow, and all the water upon which land life depends, it serves a most important function in connection with temperature, as already in-



licated. It appears to be the most important constituent of the air in the absorption both of the heat radiated from the sun and of that radiated from the earth. It increases the average temperature at the bottom of the atmosphere and it reduces the extremes of heat and cold which would exist if the air were altogether dry.

**Sources of water vapor: evaporation.** It is a familiar fact that a moist surface exposed to the air soon becomes dry, and that water left standing in an open dish will presently disappear. Any fluid, such as ink, which contains much water, also dries up if left uncovered. These familiar experiences illustrate what is taking place all the time wherever moist surfaces are exposed to the air. They are constantly losing water to the atmosphere. We conclude therefore that *the water vapor of the air is being derived constantly from all exposed moist surfaces*. The conversion of liquid water into water vapor is *evaporation*. It consists of the passage of molecules from the surface of a liquid or a solid into the vaporous condition. The molecules of a liquid, for example, are in active movement. If they move with sufficient velocity when near the surface of the liquid, they may pass out of the range of the attraction of the other molecules of the liquid, in which case they become vapor.

Evaporation also takes place from land surfaces which *seem* dry, for even here the rock, subsoil, etc., beneath the surface is more or less moist, and moisture is continually passing from beneath up into the atmosphere. Evaporation also takes place from snow and ice, even though the temperature is far below that of melting. This is shown by the fact that snow and ice slowly disappear in a temperature below 32° F. A wet cloth, put into a very low temperature, say 0° F., freezes stiff; but if it remains in the same temperature, it presently becomes dry. The ice in it has evaporated.

All animal respiration also furnishes water to the atmosphere. This is readily shown in winter, when the water vapor of the breath condenses, and so becomes visible, in the cold atmosphere. The water breathed out is not seen in summer, or in a warm room, because it condenses at lower temperatures only. Plants also breathe out moisture, and the amount given off from thrifty growing vegetation is very great. Water vapor is also given off by active volcanoes (p. 368).

On the whole, water surfaces (oceans, lakes, rivers, etc.) yield more water vapor than equal areas of land surface. The oceans must be looked upon as the ultimate source of most of the water vapor. But for this great reservoir, the waters of the land would presently be exhausted. On the whole, the ocean receives water from rivers, springs, and rains about as fast as it loses it by evaporation, so that the amount of water in the ocean remains nearly constant from year to year.

On the average, 30 to 40 inches of rain-water are estimated to fall from the air each year on land; that is, enough to make a layer 30 to 40 inches deep if spread over all the land. The amount of water evaporated each year must be about the same as the amount which is precipitated. If the precipitation on the oceans is equal to that on the lands, square mile for square mile, and if all were taken from the oceans *and not returned*, the oceans would be dried up in less than 4000 years, or, according to the larger figure (40 inches), in less than 3000 years. If this amount of water were evaporated from the lakes of the earth, it would probably exhaust them in less than one year.

The energy necessary to evaporate this amount of water is very great. Assuming that the average amount of rainfall is 60 inches instead of 30, Strachey has estimated that the energy necessary to evaporate this amount of water and lift it 3000 feet (the average height from which rain falls) would be equal to 300,000 million horsepower constantly in operation.

**Rate of evaporation.** Fig. 558 shows the amount of evaporation in inches of water which there would be from a free water surface in various parts of the United States. The evaporation is seen to be highest in the warmer and drier parts of the country.

Several conditions affect the rate of evaporation. The principal ones are (1) the amount of water vapor in the atmosphere, (2) the temperature of the atmosphere, and (3) the strength of the wind.

(1) The greater the amount of water vapor in the atmosphere, the less readily does new vapor form and rise into it. The pressure of the water vapor above the surface from which evaporation is taking place seems to be the controlling factor. If it is sufficiently great there will be no evaporation, at least in the sense that there will be no increase of water vapor in the air. Such evaporation as takes place will be balanced by condensation on the evaporating surface.

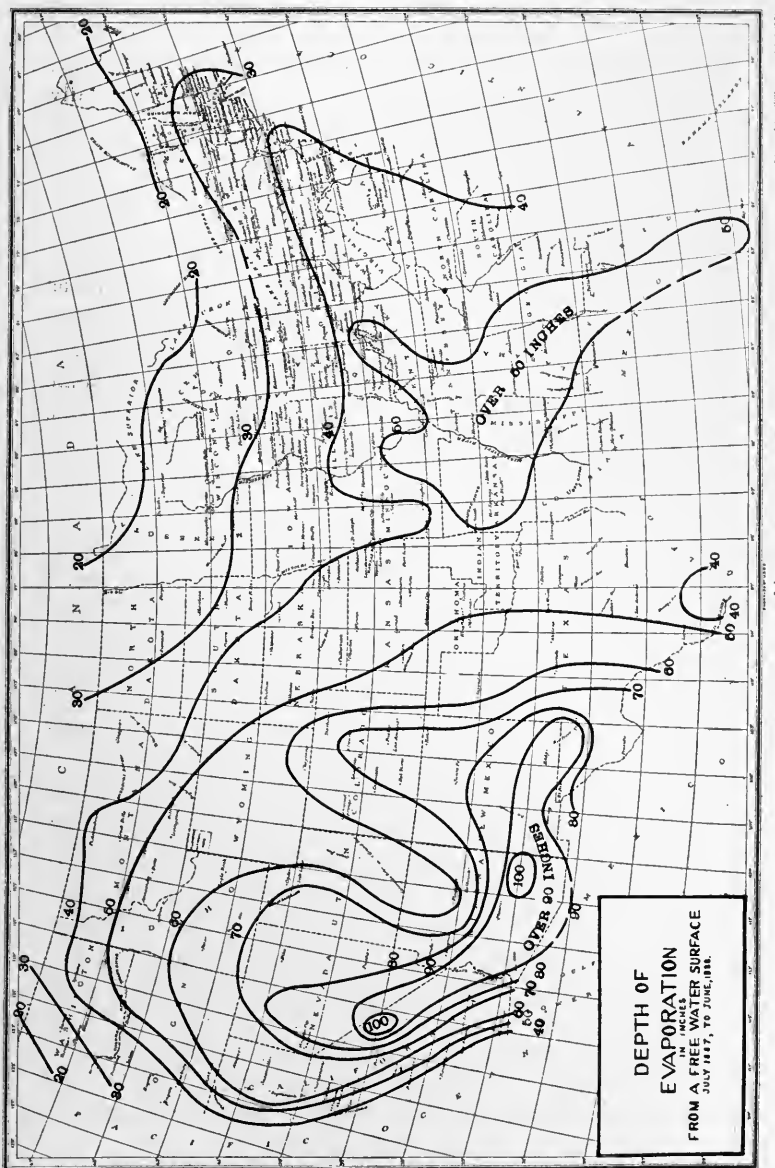

Edition of Jan. 1910, reprinted Aug. 1926.

**FIG. 558.**—Map showing the depth of evaporation, in inches, in the United States. The numbers on the lines show, in inches, the amount of water which would be evaporated each year if water were freely exposed. (Chart based on computations, not on actual measurements. (Russell, Monthly Weather Review, Dec., 1904.)

(2) Other things being equal, the warmer the water surface the faster the evaporation. This is illustrated by familiar experiences. Water on a hot stove evaporates sooner than water in a cool place, and water in the sun evaporates, in general, much more rapidly than in the shade.

(3) The stronger the wind the more rapid the evaporation. The reason appears to be as follows: When the air is still, the space just above a body of water or a moist surface becomes well charged with water vapor, and this tends to retard evaporation; but when the air is in movement, the water vapor is carried away about as fast as it is formed, so that new and often drier air continually comes in over the surface from which evaporation is taking place. If the water vapor formed were moved away as rapidly by some other means, evaporation would go on just as readily as when the wind blows.

(4) Evaporation is also influenced by pressure of the air, being diminished slightly by increase of pressure.

**The function of the atmosphere in evaporation.** The air influences evaporation by its movement, as just noted, and also because it affects the temperature above the land and water (p. 526); but evaporation is not dependent on the air. It would go on in a vacuum at a given temperature rather more rapidly than in air at the same temperature.

**Evaporation takes up heat.** Evaporation cools the surface from which it takes place. If the hand be moistened, it feels cool as it dries, and the faster the evaporation, as when the wind blows, the more distinct is the cooling. This is why moist clothing seems cooler in the wind than in still air, even when the temperature is the same. It takes about 1000 times as much heat to evaporate a given amount of water as it would take to raise its temperature 1° F. The evaporation from forested regions in moist tropical lands is so great that the temperature there is often much lower than would be expected from the insolation.

**Amount of water vapor in the air.** The amount of water vapor in the air varies greatly from place to place, and even in the same place from time to time. Various attempts have been made to estimate the amount in the air at one time, but the results are far apart. Its amount has been estimated as high as 1 per cent. of the weight of the atmosphere (p. 512). This would be equivalent to about 4 inches of water if it were precipitated. This is probably

much above the average amount, though very warm air may contain locally much more than 1 per cent. of water.

The following table (p. 570) presents an estimate of the amount of water vapor which the lower part of the atmosphere is capable of holding under different conditions of temperature. Since only about one twenty-fifth of the water vapor is above 30,000 feet, this table shows about twenty-four twenty-fifths of all the atmosphere may hold at these temperatures.

Some idea of its amount is gained in another way. One cubic foot of air at 0° F. is capable of containing one half grain of water vapor, at 60° F., 5 grains, and at 80° F., 11 grains. The weight of air in a room 40×40×15 feet, at a temperature of 60° F. and under ordinary pressure, is about 1800 pounds. The weight of water it is capable of containing is nearly 20 pounds. This would nearly fill a common water-pail.

**Distribution of water vapor.** So soon as the water vapor passes into the air it is distributed, partly by winds and partly by diffusion. Evaporation at one point, therefore, tends to moisten the air everywhere, though first and most in the region where the evaporation takes place.

The amount of water vapor in the air diminishes rapidly upward, largely because of the low temperature, as shown in the following table:

Altitude.	Water vapor.	Air density.
Feet.		
0	1.00	1.00
13,000+	0.24	0.61
30,000-	0.04	0.32

**Atmospheric moisture and atmospheric movements.** Since water vapor makes the air lighter, and since movements result when the air of one place becomes lighter than that of another, inequality in the amount of moisture in the air in different places is a cause of atmospheric movement.

**Saturation.** The amount of water vapor in the air at any place at any time depends on the temperature and on the available supply of water. The warmer the air the more the moisture which it can hold.

When there is all the water vapor in the air which is possible at a given temperature, the air is said to be *saturated*. It is cus-

tomary to speak of the *air* as being saturated; yet it is in reality not the air which is saturated, but the *space* which the air occupies. The amount of water vapor necessary to saturate a given space depends on the temperature of the space, and is essentially the same whether air is present or not. It is also sometimes said that the *water vapor* is saturated. In spite of its inaccuracy, the expression *saturation of air* is in such common use that it is likely to be retained.

**Humidity and Dew-point.** The amount of moisture which the air contains is its *absolute humidity*. The percentage of moisture which air contains at any temperature, in comparison with what it might contain at that temperature, is known as its *relative humidity* (Fig. 559). When air contains half the moisture which it might contain it is said to have a relative humidity of 50. When it is saturated with moisture, its humidity is 100. Air is commonly said to be "dry" when its relative humidity is low, and "moist" when its relative humidity is high. The average relative humidity of air over the land is probably about 60 per cent., and that over the ocean about 85 per cent., so that the amount of water actually in the atmosphere is less than that which might be calculated from the table. The part of our country which is productive, agriculturally, without irrigation, is chiefly where the relative humidity is more than 65.

Height of column of air above the ground.	Depth of water which would be in saturated air below the level indicated, for the following dew-points at sea-level.			
	80° F.	70° F.	60° F.	50° F.
Feet.	Inches.	Inches.	Inches.	Inches.
6,000	1.3	1.0	0.7	0.5
12,000	2.1	1.5	1.1	0.8
18,000	2.5	1.8	1.3	0.9
24,000	2.7	2.0	1.4	1.0
30,000	2.8	2.1	1.5	1.1

The relative humidity of the air in dry regions is much greater than is popularly supposed. It is rarely so low as half that of regions moist enough to be productive. Thus at Yuma, Ariz., the average relative humidity for the year is 42.9 per cent., with a mean monthly minimum of 34.7 per cent. The corresponding figures for Santa Fé are 44.8 and 28.7; for Pueblo, 46.2 and 37.6. In Death Valley, Cal., the average relative humidity for five months was 23.

Any reduction of temperature of saturated air causes some of its moisture to be condensed. The temperature at which air

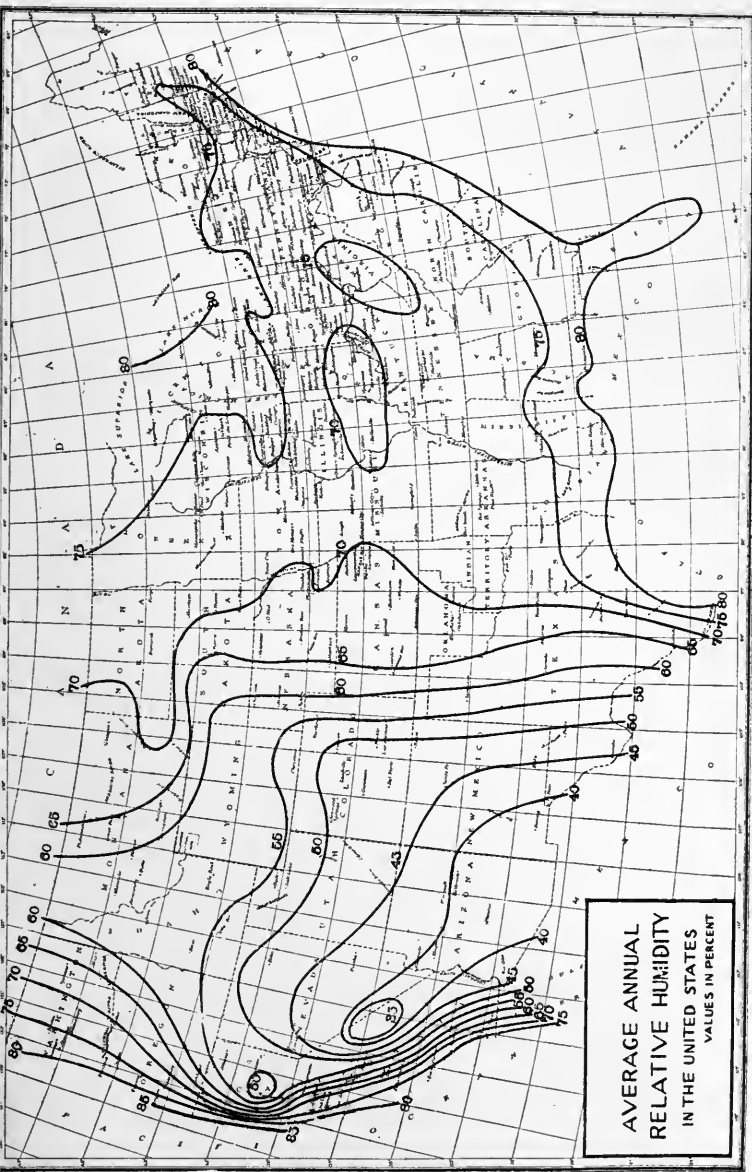

U.S. DEPARTMENT OF AGRICULTURE

Fig. 559.—Chart showing the average annual humidity of the atmosphere in the United States.  
 (Cox, U. S. Weather Bureau.)

begins to allow its water vapor to condense is the *dew-point*. Air which is saturated is therefore at the dew-point. It will be seen that the dew-point is not a fixed temperature, but is influenced by the amount of water vapor in the air. When this amount is large,

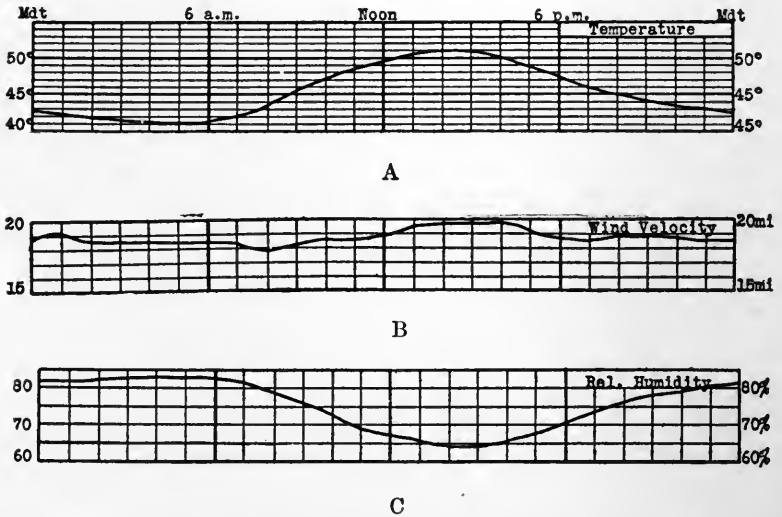

FIG. 560.—Graph showing the relations between temperature, wind velocity, and humidity, at Blue Hill Observatory, Massachusetts. (Cox, U. S. Weather Bureau.)

the temperature of the dew-point is relatively high; when the amount is small, the temperature of the dew-point is relatively low.

Air may be brought to the dew-point in various ways: (1) It may be carried (by wind) where the temperature is lower, as to a higher latitude or altitude; (2) it may be cooled by having cooler air brought to it, as by a cold wind; (3) it may be cooled by radiation, or (4) by expansion.

**Condensation.** When the temperature of condensation is above  $32^{\circ}$ , the vapor condenses into visible water, which usually takes the form of little droplets. If the temperature of condensation is less than  $32^{\circ}$ , the water crystallizes as it condenses, and takes the form of ice particles.

**Condensation and temperature.** When the water vapor of the air is condensed, an amount of heat equal to that absorbed in its evaporation is set free. This is why rising moist air is not cooled



so rapidly as rising dry air (p. 537). Dry air is cooled about  $1^{\circ}$  F. for every 183 feet of rise, but saturated air at  $68^{\circ}$  F. must rise nearly twice as much to be cooled  $1^{\circ}$  F. This slower rate of cooling is because of the heat set free by the condensation of moisture.

**Dew and frost.** It sometimes happens that the temperature of the surface of the land, or of the objects upon it, becomes lower than the temperature of the surrounding air. This is especially likely to be the case in the clear nights of late summer and autumn. If the temperature of the grass blades, for example, becomes lower than the dew-point of the surrounding air at night, moisture from the surrounding air will be condensed on them. Such moisture is *dew*. Dew does not fall, but condenses on the surface of solid objects. A good illustration of dew is often furnished by the moisture which gathers on the outside of a pitcher of ice-water on a summer's day. The temperature of the pitcher is below the dew-point of its surroundings, and moisture from the air therefore condenses on it. Dew forms on clear nights rather than cloudy ones, because the heat of the day is radiated more readily from the land and the bottom of the air when there are no clouds. Dew is formed on still nights more than on windy ones, because the wind tends to move away the air which is approaching its dew-point, supplying other air in its place, and the incoming air is often warmer than that moved on.

When the temperature of the dew-point is below  $32^{\circ}$  F., the moisture which condenses on solid objects condenses as frost instead of dew. Frost is not frozen dew, any more than snow is frozen rain. It stands in the same relation to dew that snow does to rain. In the autumn, frost is more likely to occur in valleys and on low flats than on adjacent hills, because the colder air settles to the lower levels.

Dew, and sometimes frost, may form on the under sides of objects. If a pan be placed bottom up on the ground, there will be dew on the inside of it in the morning as often as on the outside. There is often dew on the under side of a flat stone when there is none on its top. Even in a desert, a rubber blanket spread on the ground at night will often be wet on the under side in the morning. The explanation is as follows: The air in the ground has some moisture. During the day, when the sun shines, this air is warmed. At night, the air above cools much more quickly than the air in the ground. The cooler heavier air above then sinks into the ground, displacing and crowding up the warmer air below

with its water vapor. On reaching the cool pan or the cool rubber blanket, some of the moisture is condensed. If the air in the ground had more moisture than that above ground, water vapor would pass up from below, even if the air with which it is associated did not. In the daytime the rising moisture would not condense on the pan or blanket, because they would be warmer than the water vapor from below, if the sun were shining; but at night their temperature may be low enough to cause condensation.

**Clouds and fog.** The water droplets and the ice particles condensed from the water vapor of the air take the form of *clouds*



FIG. 561.—Fog streaming in from the Pacific Ocean. Coast of California.  
(U. S. Weather Bureau.)

if the condensation takes place without precipitation above the bottom of the atmosphere, and the form of *fog* (above 32° F.) or frost (below 32° F.) if in the lower part of the atmosphere. Fogs and air-frost are the same as clouds, except that the former are lower. Fog is, indeed, but a cloud resting on the surface of the land. If moisture condenses and the particles remain suspended in the air about the top of a mountain, there is, to the observer on the plain or in the valley below, a cloud about the mountain; but if the observer were to climb up into the cloud, it would then appear to be fog. Fogs are often formed when the warmer air over a lake in autumn blows over the colder land, or when the air over warmer

water from one part of the ocean (e.g., a warm ocean current) blows over colder water. They also often form in valleys at night, especially in autumn, when the night temperatures are much lower than



FIG. 562.—Morning fog over valleys. Mount Tamalpais, Cal.  
(U. S. Weather Bureau.)

those of the day. The cooler air settles in the valleys, which are therefore more likely to have fogs than the uplands are.

Fogs occasionally lead to shipwreck on sea, and interrupt business operations on land. A persistent and dense fog in London, December 10 to 17, 1905, was estimated to have cost the city

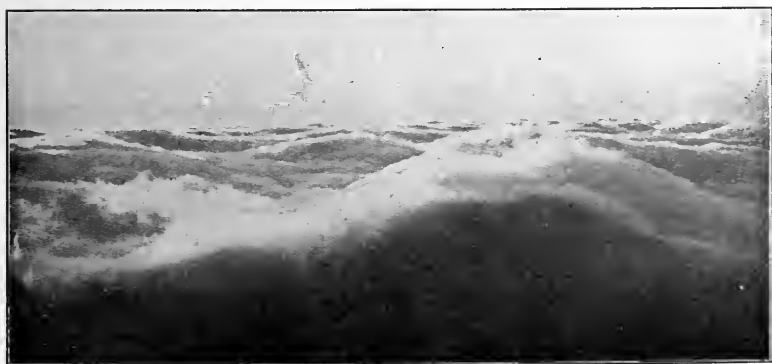

FIG. 563.—Fog waves. Coast of California. (U. S. Weather Bureau.)

\$1,750,000 per day in one way and another, largely through suspension of business. Such estimates are, however, to be taken with reserve, since much of the suspended business is transacted later.

A heavy fog facilitated Washington's retreat to New York after the battle of Long Island.

The droplets of water in clouds and fogs must be very small to remain suspended in the air. It has been estimated that they are



FIG. 564.—Fog rising and turning to cloud. Mount Tamalpais, Cal. (U. S. Weather Bureau.)

often about  $1/3000$  of an inch in diameter, but there is doubtless great variation.

Clouds also affect temperature by hindering radiation. In general, cloudiness lowers the summer temperatures of intermediate latitudes, raises their winter temperatures, and gives them a higher average temperature.

**Forms of clouds.** Clouds assume many forms. Among the more common are the *cumulus*, the *stratus*, the *nimbus*, and the *cirrus* clouds. Between these more distinct forms there are all gradations, giving rise to the names *cirro-cumulus*, *cirro-stratus*, *cumulo-stratus*, etc.

Cumulus clouds are thick clouds, the upper surfaces of which are more or less dome-shaped, with irregular and fleecy protuberances. Their bases are nearly horizontal. They appear to be formed by ascending convection currents, and their plane bases seem to mark the level at which condensation takes place as the air rises. They appear especially in clear, hot weather, and most commonly begin to form in mid or late forenoon, after insolation has estab-

lished convection currents. They grow as the heat of the day increases, and normally attain their greatest size at about the hour of maximum heat. As evening approaches, they commonly grow smaller. They are frequently dissipated before sundown, but



FIG. 565.

FIG. 565.—Cumulus (wool-pack) clouds. (Photo. from Cloud Chart, Hydrographic Office, Dept. of the Navy.)



FIG. 566.

FIG. 566.—Cumulus clouds of the fair-weather type. (U. S. Weather Bureau.)



FIG. 567.

FIG. 567.—Spring cumulus clouds of the rain type. (U. S. Weather Bureau.)



FIG. 568.

FIG. 568.—Cumulus clouds at Santa Fé, New Mexico. (U. S. Weather Bureau.)

sometimes pass into other forms of cloud (Figs. 565-573 and Fig. 576).

Stratus clouds are horizontal sheets of lifted fog. When the sheet is broken by wind or mountains, it is sometimes called fracto-stratus.

Nimbus or rain-clouds consist of thick layers of dark clouds without definite shape, and with ragged edges, from which continued rain or snow generally falls (Fig. 573).



FIG. 569.

FIG. 569.—Cumulus clouds; thunder-heads in process of active growth. (U. S. Weather Bureau.)



FIG. 570.

FIG. 570.—Tumbled cumulus clouds. (U. S. Weather Bureau.)



FIG. 571.

FIG. 571.—Cumulus clouds, broken and wind-torn. (U. S. Weather Bureau.)



FIG. 572.

FIG. 572.—Alto-cumulus clouds, wave form. (U. S. Weather Bureau.)

Cirrus clouds are detached, delicate, and fibrous. They are often described as having the form of feathers. They are generally white, and sometimes arranged in belts. They are usually high and thin, and often of particles of snow or ice (Figs. 574–576).

**Precipitation.** The condensation of the water vapor of the air leads to rain, snow, or hail, if the products of condensation fall. Whether precipitation really takes place after the formation of clouds depends on many conditions. To give rain or snow, the



FIG. 573.

FIG. 573.—Cumulo-nimbus clouds. (From Cloud Chart, Hydrographic Office, Dept. of the Navy.)



FIG. 574.

FIG. 574.—Cirrus clouds. (From Cloud Chart, Hydrographic Office, Dept. of the Navy.)



FIG. 575.

FIG. 575.—Cirro-stratus clouds. (U. S. Weather Bureau.)



FIG. 576.

FIG. 576.—Cirro-cumulus clouds; mackerel sky. (U. S. Weather Bureau.)

particles of water or snow in the cloud must be heavy enough to fall; and if they are to reach the bottom of the atmosphere, they must not pass through air which is dry enough and warm enough to evaporate them before they reach the bottom of the atmosphere.

Whether precipitation takes the form of rain or snow depends not only on the temperature of condensation, but also on the temperature of the air over the place where the precipitation takes place. Precipitation which starts as snow may become water before it reaches the bottom of the air. It often *snows* on a mountain when it *rains* in the valley below. Precipitation which starts as water rarely freezes as it descends, though some *hail* may be regarded as frozen rain.

Since condensation follows cooling, and since precipitation follows condensation, sufficient cooling (below dew-point) of the air may cause precipitation. It follows that there may be rain (or snow) (1) when air is blown up a cold mountain-side, (2) when it is blown poleward (or, in general, from a warmer to a cooler place) without rising, (3) when it rises by convection, both because (a) it is cooled by being brought to cooler air, and (b) because it expands; (4) when cooler air is brought to warmer air. Rains due to (1) are not rare in mountain regions, and rains due to (3) are common where convection currents are strong, as in the region of tropical calms, where precipitation occurs almost daily during the hottest part of the day.

The *distribution* of rainfall is dependent, in large measure, on the winds, and will be considered later.

**Rain-making.** Various attempts have been made to produce rain by means which may be called artificial. The methods employed have been various, but the results have been uniformly unsuccessful. The method most tried has been that of producing explosions of one sort or another in the air well above the land. If there were cloud particles in abundance in the air, such disturbances might perhaps have the effect of causing them to unite and so to become large enough to fall; but the amount of rainfall which can be thus produced, under the most favorable conditions, is probably too small to be of consequence. Other methods which have been tried or suggested seem equally futile.

**Summary.** The air is constantly taking up moisture from all moist surfaces. This moisture, in the form of invisible vapor, is diffused and blown everywhere. When it reaches a temperature which is low enough (the dew-point), the moisture is condensed. If it condenses in the upper air, it may fall as rain or snow, or it may remain suspended in the air in the form of a cloud and be evaporated again. If it condenses on the surface of solid objects



at the bottom of the atmosphere, it forms dew or frost. Water vapor is thus in constant circulation, and all land life depends upon it. Some of the water which is precipitated out of the atmosphere falls on the surface from which it was evaporated, but much of it falls in places far distant from those whence it was evaporated.

## CHAPTER XVI

### ATMOSPHERIC PRESSURE

THAT the air is substantial and has weight is shown by the familiar phenomena cited on page 506. Its downward pressure or weight has already been stated to be, on the average, nearly 15 pounds to the square inch at sea-level. Differences in atmospheric pressure are the primary cause of atmospheric movements, or winds, and winds are of so much significance, in one way and another, that it is convenient to have some standard method of measuring and recording atmospheric pressures.

The pressure of the atmosphere is measured by the *barometer*.

**The barometer.** The principle of the ordinary barometer is as follows: A tube more than 30 inches long, closed at one end, is filled with mercury, and the tube is then placed, open end down, in a dish of mercury (Fig. 577). The mercury in the tube will sink until its upper surface reaches a level about 30 inches above the level of the mercury in the dish, if the place of the experiment be near sea-level. The mercury remains at this level in the tube because the pressure of the air on the mercury in the dish is sufficient to balance the downward pressure, or weight, of the mercury in the tube. Since the pressure of the air at sea-level holds the mercury in the tube up about 30 inches or 760 millimetres, the pressure of the air at sea-level is said to be 30 inches or 760 millimetres. If the atmospheric pressure becomes less, the mercury in the tube falls, and if the atmospheric pressure becomes greater, the mercury in the tube rises.

At elevations above sea-level the pressure becomes less because more of the air is left below, and the higher the ascent, the less the pressure, as shown in the following table.

Altitude above sea-level in feet.	Barometric pressure in inches.
0.....	30
1,800.....	28
3,800.....	26
5,900.....	24
8,200.....	22
10,600.....	20
13,200.....	18
16,000.....	16

Altitude above sea-level may be measured by means of barometric pressure; but since mercurial barometers are not conveniently carried and are easily broken, another form of barometer, the *aneroid* barometer, has been devised for this purpose.

**Air pressures unequal.** The general facts set forth in previous chapters make it clear that the pressure of the atmosphere must vary from point to point, and from time to time at the same point. Some of the reasons are as follows:

1. The temperature of the surface on which the air rests is unequal, and increase of temperature makes the air lighter. Not only this, but the temperature in a given place varies from time to time. It follows that the pressure of the air at a given place varies from time to time.

2. A cubic foot of dry air at a temperature of 68° weighs 523.72 grains under a pressure of 30 inches. A cubic foot of saturated air under the same conditions weighs 4.26 grains less (p. 564). On the whole, the amount of moisture in the air is greater in warm regions than in cold ones, and greater over the sea and moist lands than over dry regions. Since the amount of moisture in the air at a given place varies from time to time, the pressure is being constantly disturbed.

If temperature and moisture were the only factors controlling air pressure, it should be least in low latitudes, where it is warmest and where there is abundant moisture. In other words, it should be least where the isotherms are highest,



FIG. 577.—Diagram to illustrate the principle of the barometer. The pressure of the air at A maintains the mercury at B in the tube when there is no air in the tube above B.

especially over moist regions, and greatest in cold regions, where the air is relatively dry. Since the distribution of atmospheric pressure does not correspond with these general rules, as we shall see, and since changes of pressure in a given region take place independently of changes in temperature and moisture in that region, it follows that factors other than temperature and moisture influence atmospheric pressure.

*Representation of Pressure on Maps and Charts*

**Isobars.** Lines may be drawn on the surface of the earth connecting points where the atmospheric pressures are equal. Such lines are *isobars*. A map showing lines of equal pressure is known as an *isobaric map* or *chart*. An isobaric chart for the year, that is, an annual isobaric chart, shows isobars connecting points having the same *average pressure* throughout the year. There may be isobaric charts for the several seasons and for the several months, and there may be charts for any shorter period. The daily weather maps are daily isobaric charts.

Fig. 578 represents an isobaric chart for the year. The figures on the lines indicate the average pressure for the year in inches. The isobars of 30 inches or more are full lines; those of less than 30 inches are dotted lines. A few suggestions will help in the interpretation of the map. In the southern hemisphere, the isobar of 30 inches encloses a belt extending almost around the world. It is interrupted only in the vicinity of Australia. Every point within the area enclosed by this isobar has an average atmospheric pressure of more than 30 inches. Every point within the isobar of 30.10 inches has an average annual pressure of more than 30.10 inches, while every point between the isobars of 30.00 and 30.10 has an average annual pressure of between 30.00 and 30.10 inches, etc. Between the two adjacent isobars of 29.90 in the equatorial part of the Atlantic, the pressure is less than 29.90, but not so low as 29.80. If the pressure sank to the latter figure, there would have been isobars of 29.80 inches.

It will be noted that the pressure within the areas enclosed by the isobars of 30.10 in the South Atlantic is *more than* 30.10, while the pressure between the adjacent 29.90 isobars of the mid-Atlantic is *less than* 29.90. In explanation of the difference, it is to be noted that as the 30.10 isobar is approached from without, the pressure is *increasing*; and that as the 29.90 isobars are approached from pole-

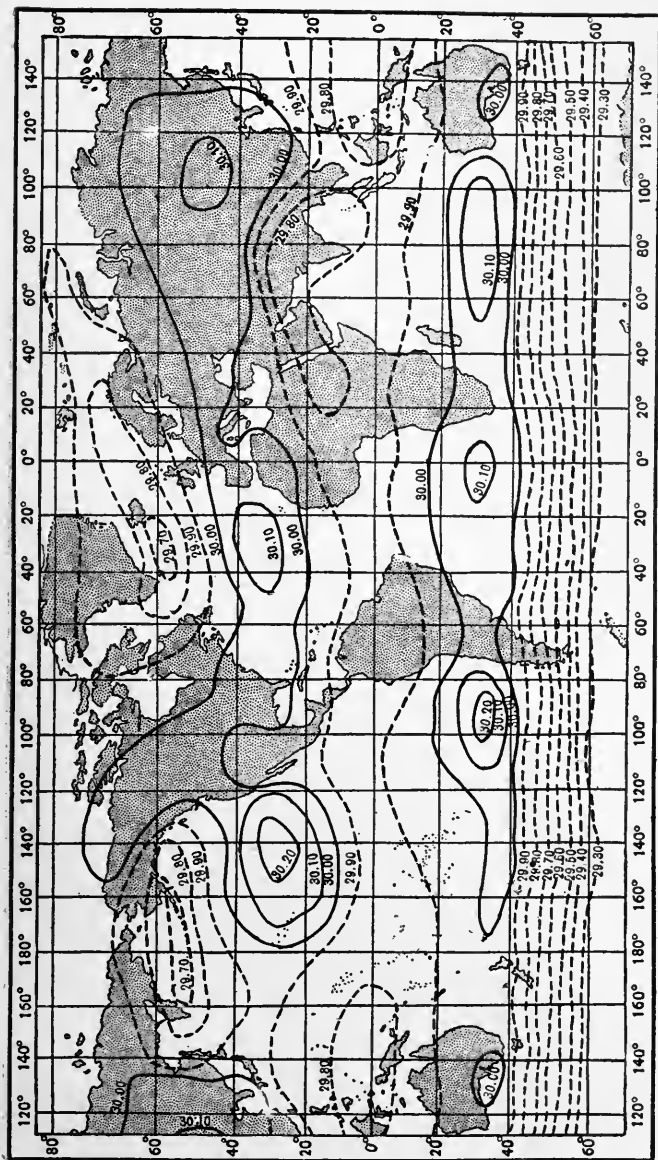

FIG. 578.—Chart of annual isobars. (After Buchan.)

ward, the pressure is *decreasing*. By the application of this principle the interpretation will be seen.

In the interpretation of isobaric charts another point should be understood. The pressure of the atmosphere diminishes with increasing elevation, as indicated in a general way by the table on page 583. It is shown in greater detail in the following table, which shows the height of a column of air, at different temperatures, corresponding to 0.1 of an inch of pressure:

HEIGHT OF AN AIR COLUMN CORRESPONDING TO 0.1 OF AN INCH BAROMETRIC PRESSURE, AT VARIOUS TEMPERATURES.

Air Pressure in Inches.	Average Temperature in Degrees Fahrenheit.						
	20°	30°	40°	50°	60°	70°	80°
	Feet.	Feet.	Feet.	Feet.	Feet.	Feet.	Feet.
22.....	116	119	122	124	127	130	132
23.....	111	114	116	119	124	124	126
24.....	106	109	111	114	116	121	121
25.....	102	105	107	109	112	114	116
26.....	98	101	103	105	107	110	112
27.....	94	97	99	101	103	106	108
28.....	91	93	95	98	100	102	104
29.....	88	90	92	94	96	98	100
30.....	85	87	89	91	93	95	97

If, for example, one ascends 95 feet from sea-level, where the temperature is 70° F. and the pressure 30 inches, the pressure of the atmosphere is reduced by 0.1 of an inch. At a level where the pressure is but 28 inches (1800 feet above sea-level; see p. 583), 102 feet of ascent would be necessary to reduce the pressure 0.1 of an inch.

It will be recalled that the temperatures shown on an isothermal chart are not those actually observed, but that allowance is made for altitude above sea-level. Similarly, the pressures shown on an isobaric chart are not those actually observed on the land. They are the pressures which would exist if there were no elevations above sea-level. Before being recorded on an isobaric chart, the observed atmospheric pressure of a place 95 feet above sea-level, when the temperature is 70° F., has 0.1 of an inch added to it if the observed pressure was 30 inches. If the temperature were lower, 0.1 of an inch would be added for a lesser height, since colder air is heavier. Thus at a temperature of 40° F., 89 feet of rise makes a difference of 0.1 of an inch in the pressure of the atmosphere.

**Isobaric surfaces.** An isothermal surface connects places having the same temperature. So an *isobaric surface* connects places having the same pressure, that is, the same amount of air above. If, for example, one place at sea-level has a pressure of 30 inches, and another a pressure of 29.80 inches, the isobaric surface of 30 inches would lie beneath sea-level where the pressure is but 29.80 at sea-level. If the temperature of the place be  $70^{\circ}$ , it would be necessary to descend about 190 feet below sea-level, at the place where the

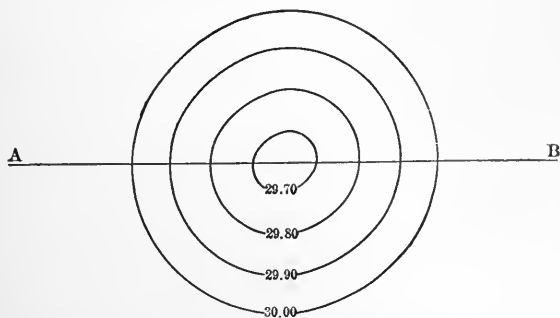

FIG. 579.—A series of isobaric lines showing diminishing pressure toward the center.

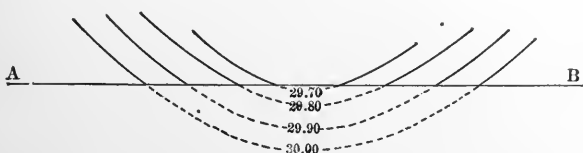

FIG. 580.—Section through the area represented in Fig. 579, showing the position of isobaric surfaces. As the pressure toward the center of the area shown in Fig. 579 diminishes, the isobaric surface bends downward. It will be seen that isobaric lines are the lines where isobaric surfaces cut sea-level.

pressure is 29.80 inches at the surface, to find the level where the pressure is 30 inches. If the observed pressure at another place at sea-level be 30.10 inches, the isobaric surface of 30 inches would rise above sea-level there. These relations are shown in Figs. 579 and 580. The former is a series of isobaric lines, with pressures varying from 30.00 to 29.70 inches; the latter is a vertical section through such an area, to show the isobaric surfaces. From these figures it is seen that the *isobaric lines* (Fig. 579) are the lines where the isobaric surfaces cut the plane of sea-level.

If a surface of water had the form shown in Fig. 580, the water from the higher parts would flow to the lower parts until the surface became level. The air, which is more fluid than water, behaves in a similar way, and moves down every isobaric surface which has slope. Such movements are winds. When the isobaric slope is great, or, in other words, when the *isobaric gradient* is high, the wind is strong; when the isobaric gradient is low, the wind is gentle; and when there is no isobaric gradient, that is, when the isobaric surface is level, there is no wind. The strong wind is strong for much the same reason that a swift river is swift; the gentle wind is gentle for much the same reason that a slow river is sluggish.

Isobaric charts have their highest value in showing the direction and the strength of winds, and winds are determined by isobaric surfaces. In order to know about the winds of a given place, we must compare the pressures of adjacent areas *at the same level*. For example, it is not the difference in pressure between the top of Pike's Peak and Denver, as measured at the two places by a barometer, which is of consequence in determining winds between these places, but it is the pressure at the top of Pike's Peak, as compared with the pressure at the same elevation over Denver, which is significant. In Fig. 581 it is the relation of the pressures at A and B, not that between A and D, which is significant. If the isobaric surface at A extends as a plane to B, there will be no wind between the two places, because the isobaric surface has no gradient.

To determine what the winds are to be, therefore, we must compare pressures at the same level. This is why all isobars are reduced to sea-level, on isobaric charts.

**The courses of isobars.** Returning now to Fig. 578, several points are readily seen. (1) The isobars in general have an east-



FIG. 581.—It is the atmospheric pressure *at the same level in adjacent areas* which determines movements of air.

west course, though many of them are irregular; (2) they are in general higher in low latitudes than in high latitudes; (3) they are highest in the latitudes just outside the tropics; (4) they are more



regular in the southern hemisphere than in the northern; and (5) they are, on the whole, more irregular on the land than on the sea.

**Isobars and parallels.** Though many of the isobars are very irregular, their general courses are east-west, and none of them have a north-south course for any considerable distance. In this respect they correspond in a general way with isotherms (Fig. 538). Furthermore, the extra-tropical belts of high pressure have an east-west course, and are therefore essentially parallel to the parallels.

We have now to inquire why the isobars follow, in a general way, the parallels.

It has already been seen that isotherms tend to follow parallels. Is it the latitude, or the distribution of temperature which is largely determined by latitude, which influences the pressure, and therefore determines the position of the isobars? Or is there some other cause which controls or influences their position?

Low latitudes have higher temperatures than high latitudes; and increase of temperature expands the air, and so makes it lighter. If, therefore, temperature controls the position of isobars, they should be lowest at the equator and highest at the poles. Fig. 578 shows not only that this is not the case, but that pressures are distributed in apparent defiance of temperature. The isobars are highest neither where it is coldest nor where it is warmest; they are highest neither in the lowest nor in the highest latitudes. It is clear, therefore, that *neither latitude nor temperature, nor both together, control the position of isobars.*

It does not follow, however, that these factors have no effect on atmospheric pressure; and if the principles thus far developed be correct, *atmospheric temperature must affect atmospheric pressure.* The only inference, therefore, which we are warranted in making at this stage is that *latitude and temperature are not the chief factors which determine the distribution of atmospheric pressure,* and therefore of isobars. It will be seen in the sequel, however, that temperature is really the fundamental factor, though its effect is, in part, indirect.

**Relation of isobars to land and water.** Let us see if further study of the isobaric charts will throw additional light on the distribution of atmospheric pressure.

The isobars are much more regular in the southern hemisphere, where there is much water, than in the northern hemisphere, where there is less water and more land. In this respect they have some relation to isotherms. (Compare Fig. 538.)

The map (Fig. 578) also shows that the high-pressure belt in either hemisphere centering about latitudes a little above  $30^{\circ}$  is somewhat regular in the southern hemisphere, where water is abundant, but very irregular in the northern hemisphere, where there is more land. It is suggested therefore that the distribution of land and water may influence the position of isobars. It will be remembered that this was one of the factors influencing the position of isotherms, because the land is warmer than the sea in the same latitude in summer, and cooler in winter, and anything which influences temperature should influence pressure also.

If temperature influences the position of the isobars, this influence should appear on seasonal or monthly isobaric charts.

**Isobars and Temperature.** The isobaric map for January (Fig. 582) shows that the high-pressure belt is much expanded in the northern hemisphere (winter), especially on the land (compare Fig. 578), and much contracted in the southern hemisphere (summer). Since the pressure is high (above 30 inches) over a greater area in the hemisphere which has winter, the map suggests that the low temperature of this hemisphere at this season may be a cause of the widened area of high pressure.

This inference may be tested further from this chart. The belt of high pressure in the northern hemisphere (Fig. 582) is much wider on land than on the sea. Since the land is cooler than the sea during January, the inference that high pressure goes with low temperature seems to be supported. In the southern hemisphere, January is a summer month, and the land is warmer than the sea. If increasing temperature causes low pressure, the pressure should there be lower on the land than in the sea. The map shows this to be the case. This chart therefore seems to show that high temperature tends to reduce the pressure, for (1) the width of the high-pressure belt is greater in the hemisphere which has winter; (2) the width of the high-pressure belt is greater on the cooler land than on the less cool sea in the hemisphere which has winter; and (3) the pressure over the land is less than that over the sea in the hemisphere where the land is warmer than the sea.

This inference may also be tested by the isobaric chart for July (Fig. 583). At that time of year, the high-pressure belt in the southern hemisphere (winter) should be expanded, especially on land, while that in the northern hemisphere should be contracted, especially on the land. Fig. 583 shows this to be the case. We

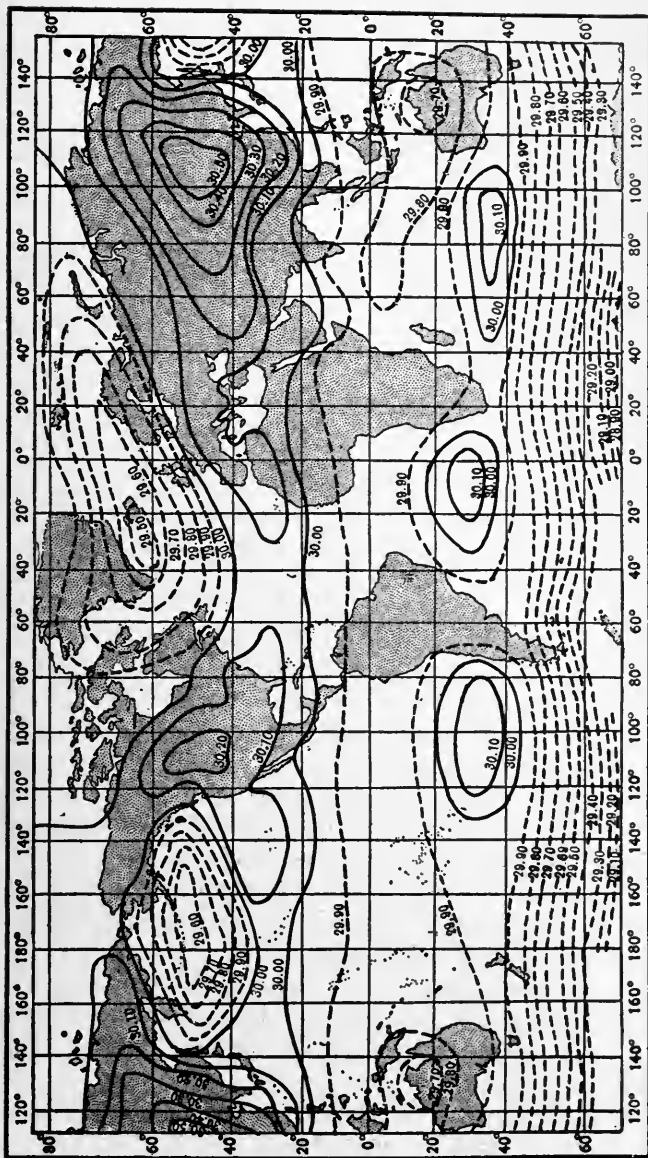

Fig. 582.—Chart of isobaric lines for January. (After Buchan.)

therefore return with increased confidence to the conclusion that high temperature reduces the pressure, while low temperature increases it. The charts furnish much more evidence in support of the same conclusions. Some of them are the following:

1. Figs. 582 and 583 show that the atmospheric pressure changes from season to season in the same place. Thus in January the pressure over the larger part of the United States exceeds 30 inches, while in July it falls short of 30 inches. Similarly the pressure in southern Africa exceeds 30 inches in July (winter), and falls short of it in January (summer). The pressure over much of Asia exceeds 30 inches in January, and falls short of it in July. Other illustrations of the same sort may be found on the maps. *In many cases, therefore, increased temperature goes with decreased pressure, as shown by Figs. 582 and 583.*

2. It will be seen from Figs. 582 and 583 that the difference between the pressure in January and July is greater in Asia than elsewhere, being, at the maximum, nearly an inch. In North America and southern Africa it is about 0.40 of an inch, while in Europe and South America it is still less. *The seasonal range of pressure is greater on large land areas than on small ones.* This is in keeping, it will be noticed, with seasonal changes of temperature (compare Figs. 539 and 540), and is another confirmation of the close relationship between isobars and isotherms.

3. Again, it is to be noted that the center of the high-pressure belt in the northern hemisphere in January is in latitude  $30^{\circ}$  or a little less, with great expansions of the belt to the northward on land. The centre of the high-pressure belt in the southern hemisphere at the same time is in latitude about  $35^{\circ}$ . In July, on the other hand, the centre of the high-pressure belt in the northern hemisphere is in latitude about  $35^{\circ}$ , and in the southern, in latitude about  $30^{\circ}$ . That is, *the centres of the high-pressure belts shift in harmony with the apparent motion of the sun.*

4. It is to be noted, also, that the seasonal variation of pressure on the sea is not, in general, so great as that on land. The seasonal change of temperature is also less on the sea (compare Figs. 539 and 540).

5. The high-pressure (more than 30 inches) belt in each hemisphere is not only greatly contracted in the summer (July in the northern hemisphere and January in the southern, Figs. 582 and 583), but it is interrupted in each hemisphere on land. This suggests

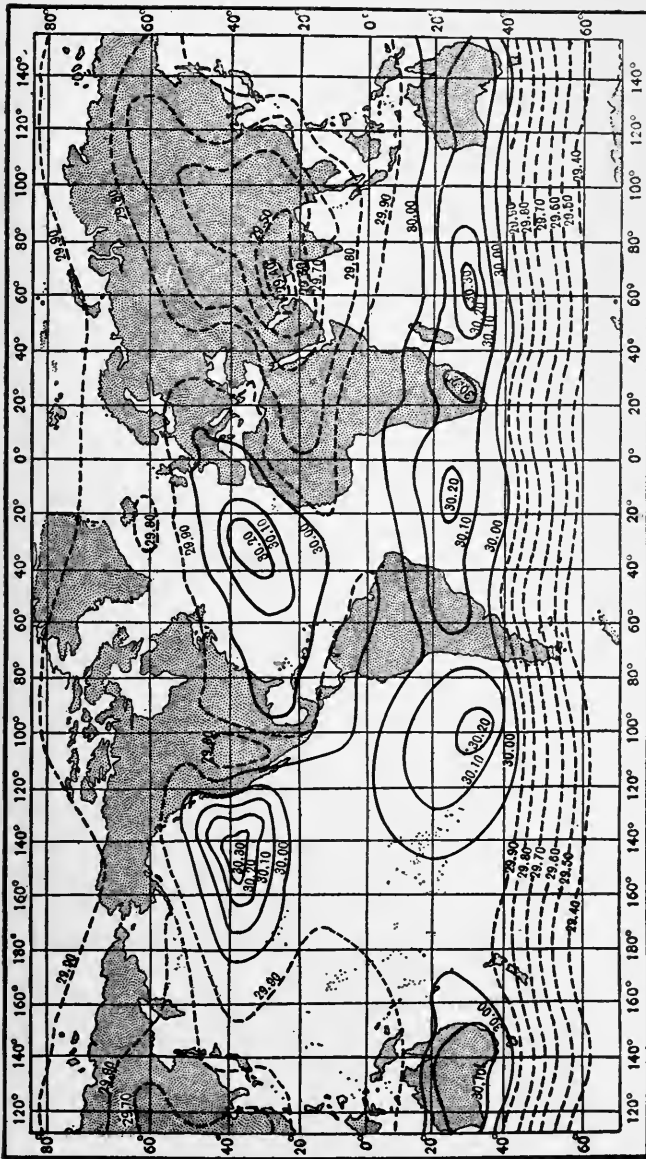

Fig. 583.—Chart of isobaric lines for July. (After Buchan.)

that the relations of sea and land influence pressure. Since sea and land influence temperature, their influence on pressure may be only a result of their influence on temperature.

A relationship between temperature and isobars is clear, but it is also clear that temperature does not afford a full explanation of the distribution of pressures as shown by the isobars. The explanation of the high pressures outside the tropics, and the low pressures in high latitudes, a feature which appears on all the charts, *is not found in temperature.*

**Isobars and humidity.** We have seen (p. 564) that water vapor makes the air lighter. Are the isobars lowest over the oceans in warm latitudes, where the air contains on the average most moisture? Figs. 578, 582, and 583 show that this is not the case. It is reasonable to conclude, therefore, that the amount of *moisture in the air is not the chief factor controlling the isobars*, though atmospheric moisture must influence atmospheric pressure.

Inequalities of temperature and moisture in the air are the only factors thus far studied which might affect the isobars; and since they do not explain the most striking feature in the distribution of atmospheric pressure, namely, the high pressures in low latitudes, we conclude that something besides temperature and moisture must be involved in their explanation.

**The high-pressure belts.** The explanation of the high pressure in low latitudes rather than in high, and the explanation of the highest pressures just outside the tropics, is not found on the isobaric charts. These larger features of pressure-distribution are probably to be explained by the general circulation of the atmosphere under the influence of rotation. Several factors bear upon this point.

1. In the equatorial zone, the air is heated and expanded. As it rises by expansion, it must flow to north and south. If the expansion affected the atmosphere all the way from bottom to top, there would be outflow from the top of the atmosphere in the equatorial zone in either direction, for the same reason that outflow would take place from the top of a mound or ridge of water if such existed. But the expansion of the air by heating is chiefly in the lower part of the air. As the lower air expands, it pushes up the air above it. The pressure of the air at the bottom, before outflow takes place above, is not diminished, but the pressure at a point above, say at the upper limit of the effective heating, is increased, because a larger part of the air is now crowded up above that level.

This is illustrated by Figs. 584 and 585. The former shows the crowding of the air above the zone of heating, and the latter the resulting isobaric slopes. Except at the bottom of the atmosphere, the isobaric surfaces slope downward on either hand from the equa-

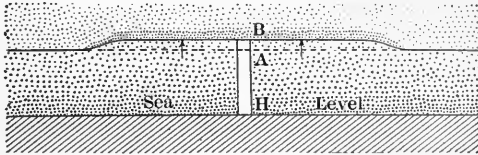

FIG. 584.—Expansion of the lower air as a result of heating, crowds the air above, and so increases its density and pressure, as compared with the density and pressure of air *at the same level* outside the heated area.

torial zone, and air always flows down an isobaric surface. Over the heated equatorial zone, therefore, the expanded air rises, and at some level above the bottom of the atmosphere it flows poleward down the isobaric surface (Fig. 586). This is the case in spite

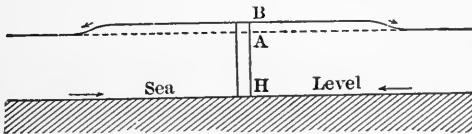

FIG. 585.—The condition of things represented in Fig. 584 gives rise to movements of air.

of the low pressure at the bottom of the atmosphere in equatorial latitudes.

When some of the air flows out poleward from the equatorial belt, the pressure at the bottom of the equatorial belt is diminished, because the amount of air above is diminished. At the same time the pressure on both sides of the equatorial belt is increased, because the amount of air is there increased. Furthermore, when the air of the equatorial belt expands, it pushes laterally as well as upward, and so tends to compress the air outside the belt where the expansion takes place.

Both the outward flow and the outward crowding of the air in the equatorial belt tend to increase the pressure of the air outside the zone of principal heating, but they do not make it apparent why the zones of greatest pressure should be in latitude 30° or a little above.

2. When the pressure in the equatorial belt is diminished by the outflow of air above, a barometric slope is established toward the equator from either side *at the bottom of the atmosphere*, as shown by the lower arrows. Fig. 585, even when the barometric slope is from the equator in the upper air. Thus a system of convective circulation is established. In the long run, the outflow of air from the equatorial belt toward the poles will be equaled by the inflow of air from higher latitudes on either side to the equatorial belt. The poleward-flowing upper air descends as it reaches higher and higher latitudes, and it takes the place of the air which moves equatorward. On the whole, the amount of ascending poleward-flowing air from the equatorial zone, equals the amount of descend-

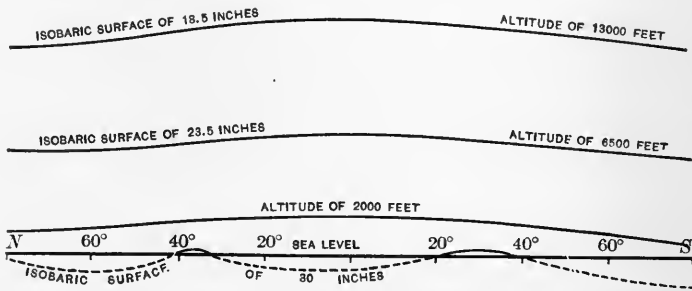

FIG. 586.—Slope of isobaric surfaces along meridians at various altitudes. (After Waldo.)

ing equatorward-flowing air from high latitudes. There must, therefore, be a *vertical plane* in the atmosphere in each hemisphere, on the equatorward side of which as much air ascends as descends on the poleward side. This vertical plane should be near latitude 30°, for this parallel divides the surface of the hemisphere, and therefore the volume of air in each hemisphere, into two nearly equal parts. This is regarded as a cause of the high-pressure belts at 30° in both hemispheres.

3. Given the high-pressure belts in extra-tropical latitudes, the circulation of the bottom air which follows helps to maintain them. The air moving poleward from these belts of high pressure turns to the right in the northern hemisphere, and to the left in the southern, becoming westerly winds in both hemispheres. In both, this turning causes these winds to crowd on the equatorward side of their lines of movement. This tends to maintain and



increase the pressure in the high-pressure belts, by crowding on their poleward sides.

Given the extra-tropical belts of high pressure, the numerous irregularities and changes of pressure from season to season, as shown by the isobaric charts, may be explained chiefly by variations in temperature.

**Permanent areas of low pressure.** Fig. 578 shows areas of low pressure in the North Pacific and North Atlantic oceans. These areas of low pressure are still more pronounced on the January chart (Fig. 582), and but feebly marked on the July chart (Fig. 583). No corresponding areas of low pressure are known in the southern hemispheres. No explanation of these areas of low pressure is here attempted.

**Temporary and local variations of pressure.** There are many variations of pressure not shown on seasonal or even on monthly isobaric charts, though they appear on daily weather maps. These will be studied in the next chapter. There are even variations of pressure which do not appear on the daily maps. Chief of them are the daily variations, presumably caused by the daily variations of temperature. Thus there are daily maxima at about 10 A.M. and 10 P.M., and daily minima at about 4 P.M. and 4 A.M. These daily changes range from 0.01 to 0.15 of an inch, the range being greatest in low latitudes. No satisfactory explanation of these variations has been given.

## CHAPTER XVII

### GENERAL CIRCULATION OF THE ATMOSPHERE

#### *Prevailing and Periodic Winds*

INEQUALITIES of atmospheric pressure involve atmospheric movements. Since atmospheric pressures are unequal, and since processes are constantly in operation which renew the inequalities, movements are continuous. Unequal insolation is the most important factor in disturbing the equilibrium of the air, and so in generating air movements, and in determining their initial direction; but the rotation of the earth has much influence in directing them, once they are started. Since the greater insolation is always in the same general zone, and since the rotation of the earth is always in the same direction, the air movements generated and directed by insolation and rotation are systematic, and result in a general circulation of the atmosphere.

It is to be borne in mind that the movement of air is always from a region of greater pressure to one of less pressure *at the same level*, or, in other words, always *down a barometric or isobaric slope*. The familiar saying that "the wind bloweth where it listeth" is true only in the sense that the air always listeth to blow down the steepest accessible isobaric gradient, and that where there is no gradient, it listeth not to blow.

#### *The General Effect of Unequal Insolation*

If the air were in equilibrium over the whole earth at a uniform, low temperature, and if it could then be heated by the sun for a time without involving horizontal movement, the effect would be to raise its surface over all areas where its temperature was increased, and to raise it most where it was heated most, that is, in the low latitudes (Fig. 586). As indicated in the last chapter (p. 595), the result would be the establishment of a barometric

gradient from the equatorial region toward the poles (Fig. 586), and this is the condition necessary for poleward movements of air.

Since the air in low latitudes is always being heated more effectively than that in higher latitudes,<sup>1</sup> movement should be essentially constant, above the bottom of the air, from the equatorial zone to the polar zones in both hemispheres. These poleward movements of air lessen the pressure at the bottom of the atmosphere in low latitudes, because air has moved away from that zone. As the pressure is thus lessened in the equatorial region, a barometric gradient is established *toward the equator at the bottom of the atmosphere* (Fig. 587), and air must then come in from higher latitudes. Here, then, we have two elements of a general circulation: a poleward movement in the upper air, and an equatorward movement in the lower air, and the causes which generate these movements are constantly in operation.

It should perhaps be noted that quite apart from circulatory movements, there would be lateral crowding by the expanding air of low latitudes (Fig. 584). In so far as this is effective, it would reduce the mass of air above any point of the surface where the air was expanding. It would also tend to increase the amount of air over areas poleward from the zone of heating, and so would tend to establish equatorward gradients in the lower part of the air. The result would be to increase the equatorward isobaric slope at the bottom of the atmosphere.

From unequal heating alone, therefore, there is a constant tendency to the movement of air (1) from low latitudes toward the poles above the bottom of the atmosphere, and (2) a compensatory movement from the higher latitudes toward the equator. *These are the most fundamental facts in the general circulation of*

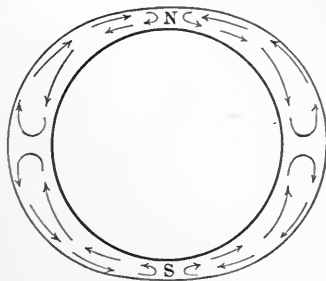

FIG. 587.—Diagram showing the general system of circulation which would be established by unequal heating, as a result of differences in latitude.

<sup>1</sup> High latitudes sometimes receive more heat per day than low latitudes (see p. 525), but the air of high latitudes is never so effectively heated, because of the abundance of ice, snow, ice-cold water, and frozen ground.

*the atmosphere.* They involve vertical as well as horizontal movements of air. The vertical movements are (1) upward in low latitudes, where the air (*a*) expands upward, and (*b*) is crowded upward by the cooler and heavier air which flows in below, and (2) downward in higher latitudes. The system of circulation which would be established by the greater heating of the low latitudes, *taken by itself*, is somewhat as shown in Fig. 587.

The general poleward movement of air from low latitudes seems to be clearly established by observation, but its return to low latitudes is much less clearly indicated in observed winds. Of its return there can be no question, but how and where it is effected is not well understood, for outside the low altitudes of the low latitudes (the trade-wind zones) no persistent equatorward movements of air are recorded. Much air moves equatorward in the aperiodic atmospheric disturbances, and perhaps the return is chiefly effected through them. These aperiodic movements will be studied in the next chapter.

It is to be noted that the isobaric gradients at the bottom of the atmosphere in low latitudes do not correspond with those in the upper air (Fig. 586); yet these apparently inharmonious gradients co-exist. The reasons for each have been given; their co-existence means that the tendency to the poleward slope is so strong that, *except in the lower part of the atmosphere*, it is not overcome by the causes which develop the equatorward gradient at the bottom of the atmosphere.

But for the influence of rotation and the unequal heating of land and water areas in the same latitude, the atmospheric movements just outlined would tend to follow meridians. Rotation affects the course of the atmospheric movements in more ways than one. It not only deflects all currents to the right in the northern hemisphere, and to the left in the southern, but it appears to be responsible, in part at least, for the concentration of the high pressures of extra-tropical latitudes into belts near the tropics (p. 596); and these belts of high pressure have an important influence on the course of circulation at the bottom of the atmosphere, and interfere with the simplicity of circulation outlined above.

#### *Effect of the Extra-tropical Belts of High Pressure*

In each high-pressure belt (Fig. 578) the isobaric surfaces are bowed up in the lower part of the atmosphere (Fig. 586), and from

each there is a barometric gradient both to north and south. From each of these belts, therefore, there should be a flow of air both southward and northward at the bottom of the atmosphere. If no other factors were involved, the *movements of the lower air* should

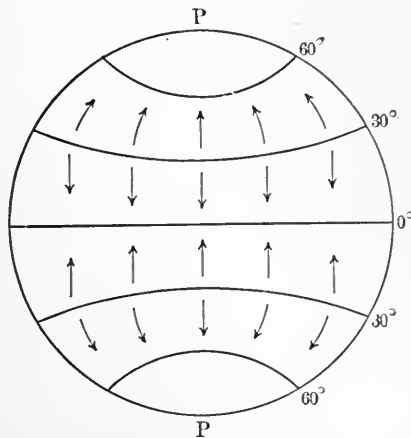

FIG. 588.—Diagram representing the general movements which would take place in the lower air if there were no rotation.

be those shown in Fig. 588; and if forces were in operation to constantly renew the high-pressure belt, these movements of air would be constant. At the center of the high-pressure belt, there would be little horizontal movement of the air. The narrow zone in this position is the *zone of tropical calms*.

It will be observed that the poleward flow in the lower part of the atmosphere from the high-pressure belts would be in much the same direction as the poleward flow of upper air from the equatorial zone, while the equatorward flow of lower air from the high-pressure belts would be opposed in direction to the flow in the upper air of the same latitude.

After the poleward gradients in the larger part of the atmosphere (Fig. 586), the barometric slopes in the lower air from the high-pressure belts are perhaps the most important fact in the general circulation of the atmosphere.

#### *The High-latitude Areas of Low Pressure*

The permanent areas of low pressure over the northern oceans (Figs. 578, 582, and 583) constitute another permanent factor in the

atmospheric circulation. Their influence is less commonly recognized than that of the high-pressure belts, but it is perhaps of more than minor importance. To these areas there must be a constant inflow of air, and from them it rises and flows out above, thus modifying the general course of the circulation, and helping to destroy its simplicity. It is perhaps significant that the great centers of glaciation in the glacial period lay on the continents to the east of these areas of permanent low pressure.

According to the outline given above, the atmospheric circulation in one hemisphere appears to be measurably independent of that in the other. This, however, is less true than would appear from the statements already made. The average pressure for the northern hemisphere for January has been estimated at 29.99 inches, and that for the southern hemisphere at the same time 29.79 inches. The average pressures for July are estimated at 29.87 inches in the northern hemisphere and 29.91 inches for the southern. It has been calculated that, to bring about the condition which exists in January, some 32,000,000 tons of air must have been shifted from the southern hemisphere into the northern since the preceding summer. This transfer is probably effected because the low temperature of the extensive land areas in the northern hemisphere so reduces the temperature and increases the density of the air over great areas in that hemisphere, that the north-poleward gradient in the upper air is increased, and the crest of the barometric surface (Fig. 586) shifted south of the equator. In other words, the *wind equator* and the thermal equator are then south of the geographic equator. The shifting of the thermal equator, and therefore of the wind equator, is shown in Figs. 539 and 540, respectively. The corresponding shifting of the wind zones is illustrated by Fig. 589.

These three factors, namely, (1) the poleward gradients in the upper air of low latitudes, (2) the gradients in the lower air from the high-pressure belts in extra-tropical latitudes, and (3) the gradients in the lower air toward the areas of low pressure in high latitudes, are the principal ones, named in the order of their importance, in the general circulation of the atmosphere.

#### *Direction of Winds*

Once wind is started, its direction may be influenced by various factors. Chief among them is the rotation of the earth, which affects the course of all winds except such as blow in the plane of

the equator. The farther they go, the more are their directions changed.

A generalized diagram of the observed winds of the lower air is shown in Fig. 590. This figure represents the winds blowing out

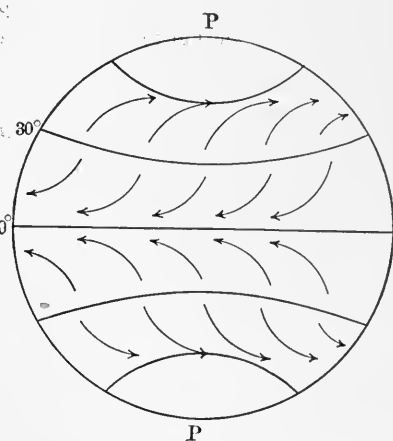
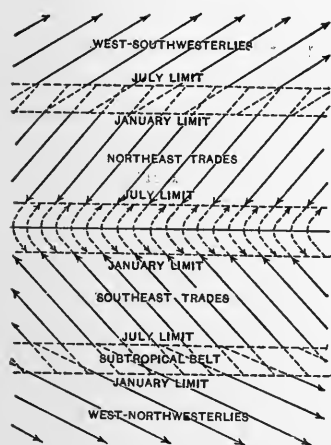

FIG. 589.—Diagram illustrating the shifting of wind zones. (After Davis.)

FIG. 590.—Generalized diagram of wind directions at the bottom of the atmosphere.

from the extra-tropical belts of high pressure, and following more or less systematic courses. The poleward winds from the high-pressure belts are turned toward the east in both hemispheres, and so become *westerly winds* (southwesterly in the northern hemisphere and northwesterly in the southern). The winds blowing toward the equator in the lower air from the belts of high pressure become easterly (northeasterly in the northern hemisphere and southeasterly in the southern) and are known as *trade-winds*. The zone along the thermal equator where the northeasterly and southeasterly trades meet, and where ascending currents of air are more pronounced than horizontal movements, is known as the *zone of equatorial calms*. The position of the zone of calms shifts a little with the sun, its center remaining near the thermal equator. (Compare Figs. 539 and 540.)

The trade-winds are remarkably persistent, and have long been known and utilized by navigators.

The westerly winds of middle latitudes and the trades of low

latitudes are the *prevailing* winds at the bottom of the atmosphere, and are sometimes called the *planetary winds*.

The explanation of the deviation of the winds from meridional courses, always to the right in the northern hemisphere and always to the left in the southern, is the same as that underlying the change in the direction of the swinging pendulum, and is illustrated by Fig. 591. This figure may be taken to represent the northern hemisphere as seen from above the North Pole. The curved arrows show the direction of rotation. The arrow at *n* represents a wind starting poleward. The arrows *o*, *p*, and *q* represent successive directions of the wind as it advances. Their departure

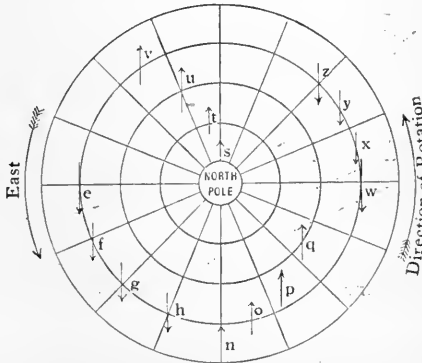

FIG. 591.—Diagram illustrating deflection of winds to the right in the northern hemisphere. The deflection is to the left in the southern hemisphere, for the same reason.

from meridians is to the right, and the departure becomes more pronounced as the latitude becomes higher. The arrow *w* represents a wind blowing westward, or contrary to the direction of rotation. Since the motion of the air in the direction of the arrow is much less rapid than the rotation of the earth in the opposite direction, the arrows *x*, *y*, and *z* represent *progressions backward*. Similarly the arrow *s*, near the pole, represents a wind blowing southward, and the arrows *t*, *u*, and *v* represent the successive directions which such a wind would have, the departures from the meridians being still to the right. The arrow *e* represents a wind starting eastward, and the arrows *f*, *g*, and *h*, the successive directions of the wind. The wind here *progresses forward*, because its direction corresponds with the direction of rotation. A corresponding diagram might be made for the



southern hemisphere which would show, in a similar way, the deflection of winds to the left of meridians.

By referring to Fig. 586, it will be seen that the trade-winds cannot have great depth. While they are pronounced at the surface, they must cease at some relatively slight elevation above, for the configuration of the isobaric surfaces changes. As a matter of observation, the trade-winds have been observed to cease at an elevation of about 10,000 feet on Teneriffe (Canary Islands, Lat. 28°). Their upper limit has also been noted on various mountains in South America and on the Hawaiian Islands, and is not far from the above figure.

The westerly winds, on the other hand, have much greater depth. Figs. 592 and 593 show the directions of winds in the United States (1) at the bottom of the atmosphere, and (2) in the upper air, as shown by the movements of the upper clouds. The movements of the lower part of the air are very different in the two cases, but the movements indicated by the upper clouds are to the eastward in both.

#### *The Circumpolar Whirl*

The circulation in each hemisphere is often looked upon as a great eddy centering at the pole. If this were the true view of the case, it would account for the low pressure in high latitudes and the high pressure in low latitudes, and the pressure should decrease steadily to each pole.

#### *Land and Water Circulation*

While the winds at the bottom of the atmosphere tend to fall into the general system shown in Fig. 590, the simplicity of the system is interfered with by various disturbing influences which modify the system of planetary winds. Chief of these disturbing factors is the unequal heating of the atmosphere over land and water. This not only interferes with the direction of planetary winds, but is itself the cause of winds.

Monsoons and land- and sea-breezes have already been cited as illustrations of the effects of the unequal heating of land and water.

The monsoon influence is probably much stronger than is commonly recognized, for it overcomes the prevailing winds on a large scale. Thus in winter, Eurasia is, on the average, a centre of air dispersion in the lower air (Fig. 582), while in summer, air flows in

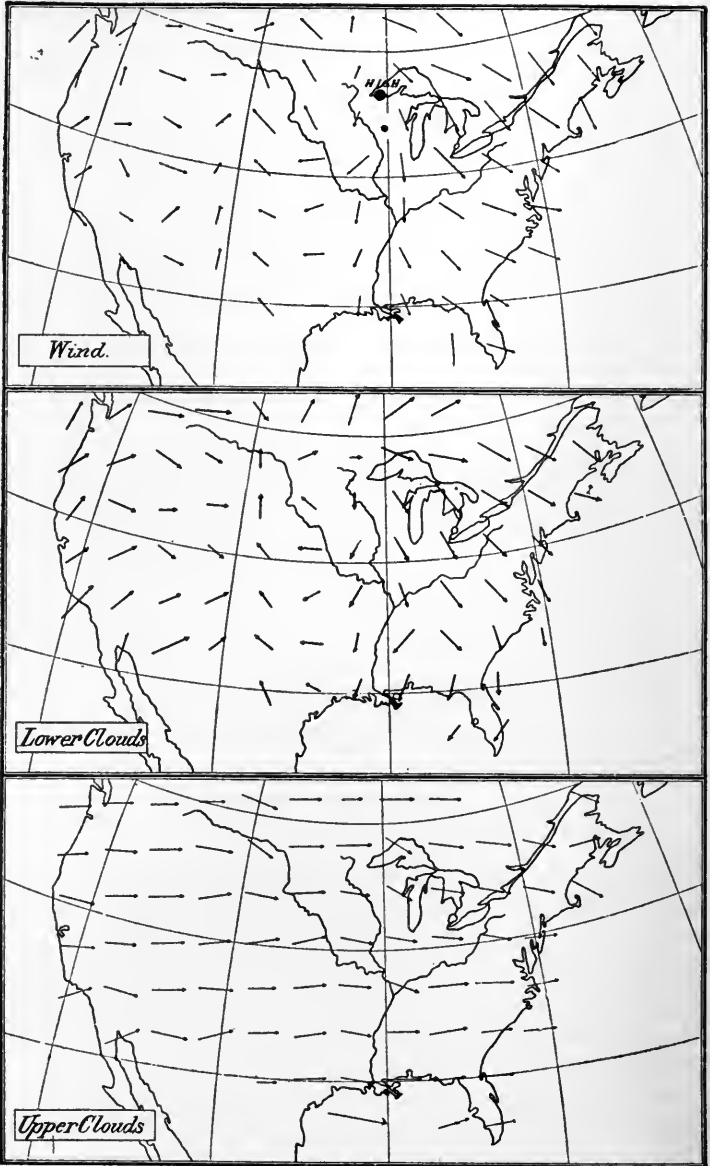

FIG. 592.—Chart showing the direction of air movements at the bottom of the atmosphere (upper figure), at the horizon of the lower clouds (middle figure), and at the level of the upper clouds (lower figure), at a time when the pressure is high about Lake Superior. The winds are westerly in the upper air, without reference to inequalities of pressure in the lower air. (U. S. Weather Bureau.)

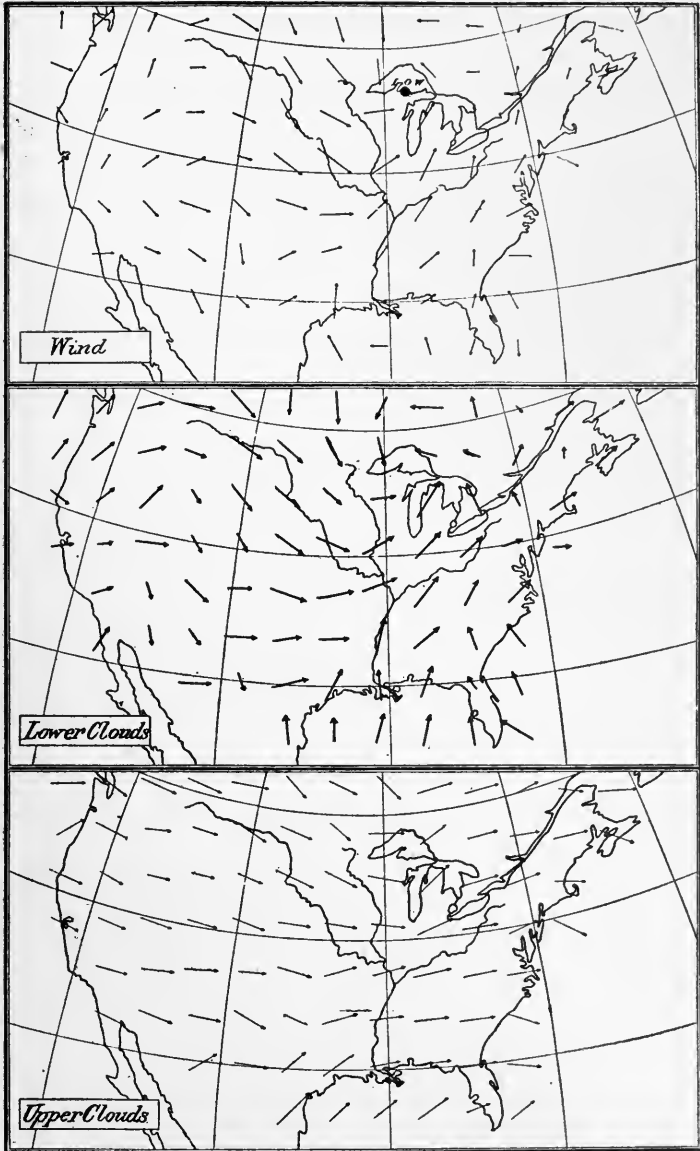

FIG. 593.—Figure showing the movements of the air when atmospheric pressure is low about Lake Superior. It will be noted that the movements in the upper air (lowest figure) are from the west as in the preceding case.

toward it, though most of its area is in the zone of the westerlies. The same influence is probably of great importance over and about every large land area, but it is only where it opposes and overcomes the prevailing wind that it is popularly recognized.

India is usually cited as affording the best illustration of the monsoon influence. This country is in the latitude of the northern

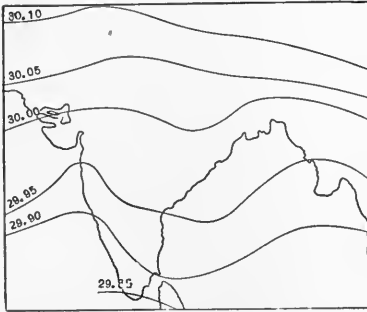

FIG. 594.—The isobars of India for January. (After Bartholomew.)



FIG. 595.—Figure showing the direction of winds in India in winter. (After Köppen.)

trades, where easterly (northeasterly) winds should prevail. In Fig. 594, the gradient is from northeast to southwest, and the direction of the wind (Fig. 595) is in harmony with the planetary system;

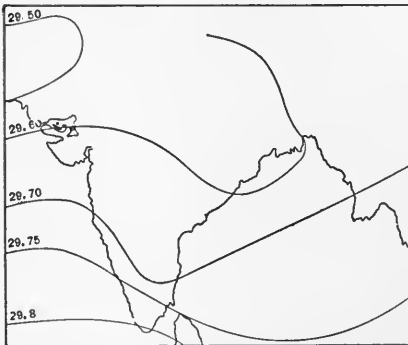

FIG. 596.—The isobars of India for August. (After Bartholomew.)

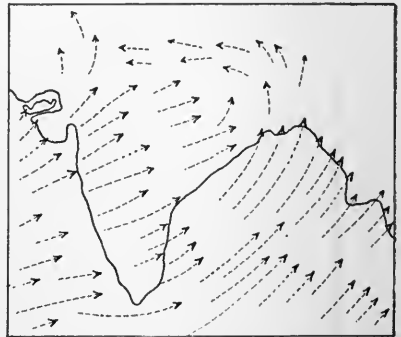

FIG. 597.—The winds of India in mid-summer. (After Köppen.)

but in Fig. 596 the isobaric gradient is to the northward, because the land is warmer than the sea and the winds blow in that direction (Fig. 597). That is, the planetary (northeast) wind is overcome

during the hot season by the winds which result from the seasonal change of temperature which establishes a seasonal gradient. At the same season, the low pressure north of India, developed by the heat of summer, counteracts the high pressure normal to this latitude, and the prevailing wind is displaced by seasonal winds blowing toward the area of low pressure. Figs. 598 and 599 show the

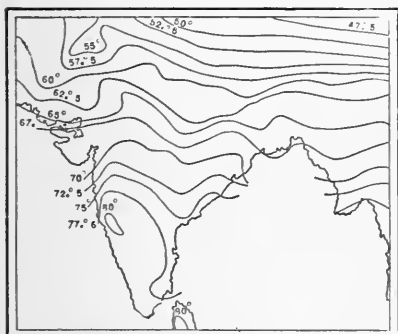

FIG. 598.—Isotherms of India for January. (After Buchan.)

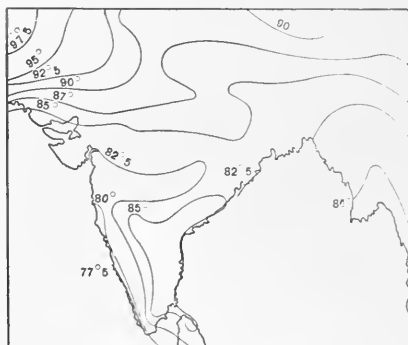

FIG. 599.—Isotherms of India for August. (After Buchan.)

isotherms for the same region at the corresponding seasons, and make clear the relation between pressure and temperature.

When the monsoon blows *with* the prevailing wind, as in western India in winter, the prevailing wind is strengthened; if the two

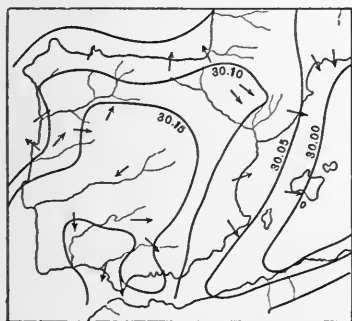

FIG. 600.—Isobars and winds in Spain and Portugal, month of January. (After Hann.)

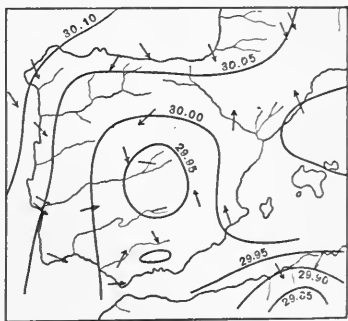

FIG. 601.—Isobars and winds in Spain and Portugal, month of July. (After Hann.)

tend to blow in opposite directions, as in western India in summer, the stronger prevails. Spain, in the zone of westerly winds, affords an excellent example of the same thing. Figs. 600 and 601 show

the conditions in winter and summer. In winter the isotherms over the plateau are low, and the isobars high, and the winds blow out from its center instead of toward it. In summer the case is reversed.

The general principle of the monsoon makes itself felt about the Great Lakes. At Chicago, which is in the zone of southwesterly winds, northeast winds predominate in spring, because the lake is then much cooler than the land, and the winds set toward the land and overcome the prevailing winds (Fig. 602). Similar diagrams

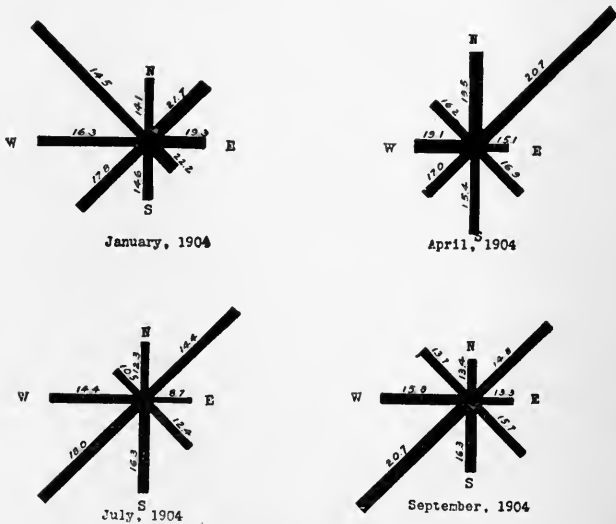

FIG. 602.—Diagram showing the direction and velocity of winds in Chicago during January, April, July, and September, 1904. The time during which the wind blew from any given direction is shown, relatively, by the length of the lines. The relative average velocity is shown by the width of the lines. The monsoon influence of the lake is seen in the preponderance of northeast winds in April. (Cox, U. S. Weather Bureau.)

for a station fifty miles from the lake would show less wind from the northeast in April. The same thing is illustrated by Fig. 603, which shows wind "roses" for Chicago and Key West. The former has a prolongation to the northeast, indicating primarily the landward winds in spring, though the principal direction of wind otherwise is southwest. Key West is in the zone of the trade-winds, and the easterly winds greatly predominate over all others.

The principle involved in the daily land- and sea-breezes along coasts (p. 561) is the same as that of the monsoon, but the resulting

winds are more local. They are not usually felt very far from shore, and do not extend to great heights. At Coney Island, the sea-breeze has been found to be limited to a height of about 500 feet at times when it has been determined. At slightly higher levels the air-currents were those of the prevailing winds. At some other places sea-breezes have been known to extend up 1300 feet.

On the coast of Massachusetts the sea-breeze sometimes starts as early as eight o'clock in the morning, though more commonly not till an hour or two later. At first it advances inland at the rate of 3 to 8 miles per hour, and later more slowly. It penetrates inland

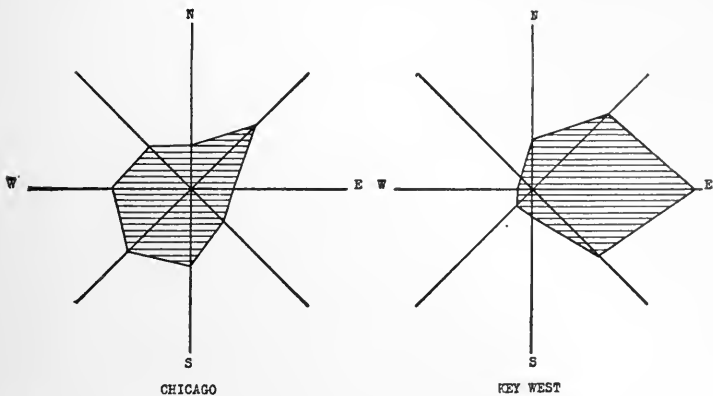

FIG. 603.—Wind “roses” for Chicago and Key West, 1902. The shaded parts of the diagrams shows the relative duration of the periods when the wind blew from different directions. The greater the distance from the crossing-point of the radiating lines, the longer the period. The influence of the lake, giving rise to lake breezes and to winds of monsoon character, is conspicuous at Chicago. Key West is in the zone of trade-winds. (Cox, U. S. Weather Bureau.)

10 to 20 miles, and sometimes gives rise to thunder-storms. On the coast of southern California, the land- and sea-breezes persist throughout the year, being much stronger in summer than in winter. Land-breezes are generally less well developed than sea-breezes.

Breezes corresponding to land- and sea-breezes are often felt about large lakes.

The sea-breeze is of consequence, not only by lowering the land temperature in hot weather, but by bringing pure air to the land. This is of much importance along densely populated coasts. The explanation of the sea-breezes has already been suggested (p. 561).

The unequal heating of high and low lands in the same latitude also causes slight and temporary departures from the normal planetary circulation (p. 562).

Besides the planetary winds, the seasonal winds, and minor periodic winds, whose times of coming and going are more or less regular, there are numerous winds which blow at irregular times, and whose coming cannot be foretold long in advance. These irregular winds are the chief cause of the uncertain elements of the weather. Some of them are due to unequal temperatures, some to unequal amounts of atmospheric moisture, and some to other causes.

Illustrations of aperiodic winds due to unequal temperature are whirlwinds and tornadoes, both of which are due to strong convection currents generated by excessive local heating, and some larger whirls of air, especially *tropical cyclones*. These will be referred to in the next chapter.

Again, just as waves of water generated by the wind are felt far beyond the place where they were generated, and long after the wind ceases to blow, so local disturbances, leading to the flow of air from one place to another, make themselves felt far beyond the place of disturbance. Movements therefore generate movements.

**Summary.** We may now recall the chief points thus far studied in connection with atmospheric circulation. They are as follows:

(1) Above the lower part of the atmosphere there is a poleward movement of the air from low latitudes.

(2) There must be a compensatory movement of air from high latitudes to low; but outside the extra-tropical belts of high pressure, this movement is not well defined.

(3) The extra-tropical high-pressure belts are the zones from which the dominant planetary winds at the bottom of the atmosphere start.

(a) These planetary winds tend to blow poleward and equatorward in each hemisphere, from the belts of high pressure.

(b) They are deflected to the right in the northern hemisphere, and to the left in the southern hemisphere, by the rotation of the earth, thus establishing the double trade-wind zone, with the equatorial calms in the centre, and two zones of westerly winds, with tropical calms on the equatorward margin of each.

(4) The simplicity of the system of planetary winds is interfered with by the great inequalities of temperature between land and sea in the same latitude. The isobaric gradients established by



unequal heating may be higher than those which direct the planetary winds. In such cases the planetary winds are overcome by seasonal winds, such as the monsoons, or by daily breezes, such as land- and sea-breezes, and mountain and valley breezes.

**Gradient, velocity, and directions of wind.** The slope of an isobaric surface is its *gradient*. Gradient is differently expressed in different countries. In England the barometric gradient is said to be 1 when the difference of pressure is 0.01 of an inch in 17 miles. In the United States, barometric gradient is commonly defined as the difference in pressure at the same level between two points which are distant from each other the length of 1° of latitude. Thus if two places 5° apart in latitude have a difference of pressure of 0.5 inch, the gradient is 0.10 of an inch. Stated mathematically,  $30 - 29.50 = .50 \div 5 = 0.10$ .

The greater the gradient, the greater the velocity of the wind. On the isobaric chart, high gradient is expressed by the crowding of isobaric lines. The crowding of such lines, therefore, means high winds. A gradient of 0.10 inch means a wind of about 30 miles an hour, and a gradient of 0.20 means a wind of about 55 miles an hour. These figures presume a plane surface. The actual velocity at the bottom of the atmosphere is much modified by the shape of the surface. The rougher the surface, the less the velocity. Observations have shown that the velocity of the wind at the height of low buildings (say 40 to 80 feet) on land is only about one-fourth as great as that at an elevation of 40 feet on the sea; while at a height of 100 to 150 feet, the velocity is half that over the sea at an elevation of 40 feet.

In general, the average velocity of winds is greatest in latitude 50° or thereabouts. The average velocity for the United States has been estimated at about 9.5 miles per hour, and for Europe, 10.3. The velocity is greater over the sea than over the land, largely because it is checked on land by friction with the uneven surface, with vegetation, buildings etc.<sup>1</sup> It is also greater in the upper air than in the lower, for the same reason. The following table gives the velocity of the wind at various levels above the bottom. It is based on observations on the movement of clouds at Blue Hill Observatory, near Boston.

<sup>1</sup> Helmholtz has calculated that if the whole body of air were set in motion at the uniform rate of 20 miles per hour, it would take nearly 43,000 years to slow it down to 10 miles as a result of friction.

## COMPUTED EASTERLY OR WESTERLY WIND VELOCITIES ALONG A MERIDIAN.

Latitude.	E=easterly, W=westery. Velocity of wind in miles per hour at various altitudes.			Increase in easterly velocities with each (about) 3300 feet in altitude.
	Sea-level.	About 3300 feet.	About 13,200 feet.	
N. Lat. 75°	E. 2.7	W. 0.2	W. 9.2	W. +3.0
70°	E. 2.0	W. 2.0	W. 14.3	W. 4.1
65°	W. 0.1	W. 4.9	W. 19.3	W. 4.8
60°	W. 2.4	W. 7.6	W. 23.1	W. 5.2
55°	W. 3.4	W. 8.7	W. 24.5	W. 5.3
50°	W. 3.3	W. 8.7	W. 24.9	W. 5.4
45°	W. 3.0	W. 8.5	W. 25.0	W. 5.5
40°	W. 1.6	W. 7.2	W. 24.0	W. 5.6
35°	E. 0.7	W. 5.0	W. 22.4	W. 5.8
30°	E. 5.3	W. 0.6	W. 18.2	W. 5.9
25°	E. 8.9	E. 3.1	W. 14.4	W. 5.8
20°	E. 9.4	E. 3.8	W. 13.0	W. 5.6
N. Lat. 15°	E. 7.8	E. 4.3	W. 6.1	W. 3.5
Equator 0°				
S. Lat. 15°	E. 15.6	E. 10.5	W. 4.8	W. 5.1
20°	E. 13.0	E. 8.2	W. 6.4	W. 4.8
25°	E. 6.4	E. 1.7	W. 12.5	W. 4.7
30°	W. 2.4	W. 7.0	W. 21.0	W. 4.7
35°	W. 7.7	W. 12.3	W. 26.1	W. 4.6
40°	W. 11.6	W. 16.2	W. 30.0	W. 4.6
45°	W. 14.9	W. 19.5	W. 33.3	W. 4.6
50°	W. 17.1	W. 21.7	W. 35.7	W. 4.6
55°	W. 17.0	W. 21.6	W. 35.6	W. 4.7
S. Lat. 60°	W. 13.6	W. 18.2	W. 32.2	W. +4.7

This table shows that there is an increase of velocity with increase of altitude, ranging from 1 to 2 miles per hour for 1000 feet. According to the table, the trade-winds do not reach up to altitudes of 13,200 feet, for at this altitude all winds are represented as blowing to the east. The table also represents them as extending farther from the equator, especially in the northern hemisphere, in low altitudes, than higher up.

## THE GENERAL CIRCULATION AND PRECIPITATION

Rainfall is of the utmost importance to most land life, both plant and animal. This is shown, in a general way, by the absence of forests and the meagreness of herbaceous vegetation in arid regions; and wherever plant life is scanty, animal life is also relatively scarce. Human industries, too, are much affected by

the amount and distribution of the rainfall, as shown by the fact that no arid region supports a dense population. Nevada, almost all of which receives less than 10 inches of rain per year, had, in 1900, only one inhabitant for each two and a half square miles. Only 3.4 per cent. of the population of the United States lives in the third of the country where the rainfall is less than 20 inches per year. The best of soil is unproductive unless adequately watered. Twenty inches of rain per year is generally considered to be the minimum for general agricultural purposes, but something depends on the latitude and something on the seasonal distribution of the rain. The warmer the climate, the more the rainfall needed, because of the greater evaporation; and the aggregate amount necessary is less if it falls when the growing crops need it most. If rainfall could be ideally distributed, the half of 20 inches would probably be adequate in the middle latitudes of the United States. Rain or snow falling at times when plants are not growing is, however, not worthless, for some of it remains underground, and is available for plants at a later time. The secret of the successful "dry farming," which is just now attracting much attention, consists in so treating the soil that the water which falls during all parts of the year is retained in the soil and subsoil till the growing season.

Land so situated that it may be irrigated is not directly dependent on rain and snow; but the water used in irrigation is derived from rainfall, though the fall is often far from the place where the water is used. Great as the results of irrigation are likely to be in our own country, it will never make more than a fraction of the arid land valuable for agricultural purposes, because the amount of water available is limited.

The distribution of rainfall is largely influenced by the winds, which bear moisture from the places where it is evaporated, to the places where the temperature favors its condensation and precipitation. Prevailing winds, periodic winds, and aperiodic winds all play their part in determining where rain falls, how much falls, and at what times of the year. The vertical movements of the air, too, have something to do with rainfall, and in some places are more important than the horizontal movements to which the name winds is usually restricted.

To know the rainfall (or snowfall) of any given region, it is needful to know (1) what winds affect it, (2) the topography of

the surface over which the winds have already blown before reaching it, and (3) the topographic situation and relations of the place itself.

**Rainfall in the zones of the trades.** In the trade-wind zones the winds are blowing from higher to lower latitudes, and therefore, on the whole, from cooler to warmer latitudes. As the air is warmed, it is capable of taking more moisture. So long as the trades blow on the sea, therefore, they would not ordinarily give rain. Where they blow over low lands, which in this latitude are warmer than the sea, they take moisture rather than give up what

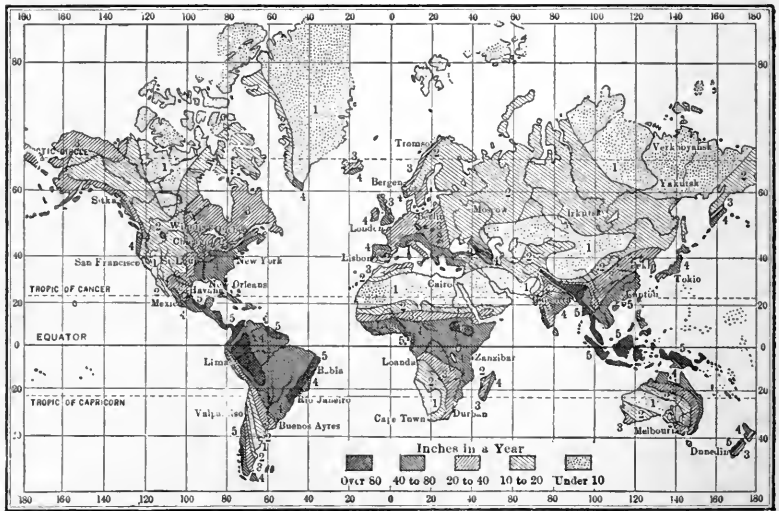

FIG. 604.—Map showing the precipitation for the world.

they have. On the sea and on low lands, therefore, the trade-winds are "dry" winds. Sahara and considerable parts of Australia are essentially desert, largely because of the drying influence of the trades.

If, however, the air of the trades is forced up over mountains, it is cooled, and some of its moisture may be condensed and may fall as rain or snow. *The windward sides of high mountains in the trade-wind zone should therefore have heavy rainfall.* An illustration is afforded by the east side of the Andes Mountains in tropical latitudes, where the rainfall is heavy (Fig. 604). Another illustration is afforded by the volcanic cones of the Hawaiian Islands. The trade-winds yield little rain to their lower slopes, but forced up

over the mountains, they yield abundant moisture in the cooler altitudes. The level of the rainfall is readily seen by the change in vegetation.

After the air of the trades passes over a mountain range, it descends, and is warmed both by contact with the warm surface and by compression. It therefore takes up moisture. The leeward sides of mountains in the trade-wind zones should therefore be regions of little precipitation. The west slope of the Andes Mountains is a case in point (Fig. 604). A high mountain range on the east side of a continent in the zone of the trades would tend to make all the area to the west of it dry, unless it also is affected by high mountains.

Since the trade-winds shift a little with the seasons (Fig. 589), the tracts which receive rain from them also shift. Tracts which have trade-wind rains at one season, but not at another, often have wet and dry seasons, and, in general, the dry season corresponds with the time of the trade-winds.

In the zone of *equatorial calms*, also called *doldrums*, the temperature is high, and the air, warmed by the sun daily, expands and is crowded upward by the cooler air which comes in from the zones of the trades. As it rises, the air expands and cools, and often gives up some of its moisture. In this zone, therefore, there are likely to be daily rains from cumulus clouds at the time of day when the upward currents are strongest, that is, in the afternoon. Since the doldrums shift north and south a few degrees yearly with the shifting of the thermal equator, a place near the equator which receives the daily rains during one season, may be without them at another time of the year.

In the zone of tropical calms (p. 601), air is descending rather than rising, and so yields little or no rain. Like the equatorial calms, these extra-tropical calms shift north and south a little with the sun. They are, on the whole, the driest latitudes of the globe, crossing Sahara, Arabia, Australia, and the southern part of South America.

**Rainfall in the zones of the prevailing westerlies.** The principles which apply to the trade-wind zones apply also in the zones of the westerly winds. These winds are, on the whole, blowing from lower to higher latitudes, and so are being gradually cooled. They might therefore yield some moisture, even at sea-level or on low land, and especially on land in the winter season. The heat of the

land in summer often prevents condensation and precipitation until the air has moved far to poleward. When such winds cross mountains, they yield moisture to their windward slopes and summits, and become dry on the leeward slopes.

Planetary winds alone considered, a high mountain range on the west side of a continent in the zones of westerly winds would make all the low land to the east of it dry.

An application of these principles will help us to understand the rainfall of the United States, so far as it is dependent on planetary winds.

Our prevailing winds for almost all the country are from the southwest. Coming on to the land from the Pacific in the winter, these winds reach the cooler land, and yield moisture, even at low levels. This gives the low lands of California their wet season. As the winds blow over the high mountains back from the coast, they yield more moisture, so that all the area west of the crest of the first high range is well supplied with rain and snow in the winter season. As the winds blow beyond the Sierras and Cascade Mountains, the air descends and becomes warmer, and therefore dry. East of these mountains lie the semi-arid lands of eastern Oregon and Washington, and the Great Basin with its Great Salt Lake.

When these winds reach the higher parts of the Rocky Mountains, which are often higher than the mountains farther west, they again yield some moisture. But farther east, all the way to the Atlantic, these winds, taken by themselves, would remain dry, for they cross no more high mountains, and they do not generally go far enough north to reach a temperature as low as that of the mountains they have passed. For some distance east of the mountains the rainfall is very deficient; but east of central Kansas and Nebraska the lands are well supplied with moisture. Southeast of a line running from about Galveston to Cleveland, the land might be supplied with moisture by the southwesterly winds from the Gulf, but there is abundant rainfall far to the west of this line. It is therefore clear that some factor other than the westerly winds is involved in the precipitation. This factor is the aperiodic *cyclonic* winds, to be studied in the next chapter. Passing over the country from east to west, the cyclones cause moist air to flow northward from the Gulf to higher and cooler latitudes. This change in latitude, together with the cooling of the air as it rises in the cyclone, is the cause of the precipitation which redeems the central and eastern parts of the

United States from the aridity which affects the belt next east of the Rockies.

The winds which blow from the Pacific to the continent in summer have a somewhat different effect upon rainfall, though the principles involved are the same. At this time of year, the winds which blow from the Pacific to the low lands of central and southern California find a temperature on the land higher than their own. These winds are therefore dry in this region, and give to much of California its dry season. Blowing inland, these winds reach mountains so high that the temperature is low enough to give rise to condensation and precipitation.

Farther north the case is somewhat different. In Washington, for example, the mountains near the coast are high enough to occasion precipitation even in summer. In Alaska, where some of the mountains are always covered with snow, precipitation is heavy in the summer, and at high altitudes it often falls as snow instead of rain.

Monsoon winds likewise yield moisture when they blow from warmer to cooler regions. In general they blow toward warmer regions, and so should be dry winds; but once started they are sometimes forced up over high mountains, and precipitation follows. The heaviest recorded rainfall on the southern slopes of the Himalayas, is due to monsoon winds. Numerous famines in India have followed the failure of the monsoon rains. The famine of 1876-78 affected 58,000,000 people directly, and is estimated to have cost 5,000,000 lives. As in the case of the planetary winds, it is the windward sides of the mountains which receive the heavy precipitation from the monsoons. It is clear, therefore, that the windward sides of high mountains are places of heavy rain- and snowfall.

Land and sea (or lake) breezes (daily) rarely yield much rain, though they often give rise to fogs when they blow from the warmer water to the cooler land. Such fogs may occasionally be seen, as at Chicago in the late autumn or early winter, sometimes advancing over the land with a wall-like front, varying from a few feet to many scores of feet in height.

Valley breezes sometimes give rise to heavy showers, as already noted.

## CHAPTER XVIII

### WEATHER MAPS

#### *Aperiodic Changes of Pressure*

FIG. 605 is a weather map for the United States for January 12, 1899. Like other weather maps, it shows (1) the distribution of atmospheric pressure, (2) the direction of the winds in various parts of the country, (3) the condition of the air with reference to cloudiness, rainfall, snowfall, etc., at all points, and (4) the temperature.

1. *Isobars.* The full lines of the weather map are isobars. The map shows a range of pressure from 30.6+ inches in the area centering about the Hudson River Valley, to 29.5— in the area centering in North Dakota. The pressure is high (over 30 inches) in the eastern half of the country, and low (less than 30 inches) in the western interior, and high again, but not very high, in an area near the Pacific coast.

The isobar of 30.6, in the eastern part of the United States, is a closed line. On either side of it is the isobar of 30.5. Since the pressure rises as the isobar of 30.6 is approached from either side, it is inferred to continue to rise after this isobar is passed. The area inside it is therefore inferred to have a pressure of more than 30.6 inches, but not so much as 30.7 inches, else another isobar would have been represented.

Similarly, all points between the isobars of 30.6 and 30.5 have pressures intermediate between those indicated by those figures. The pressure is higher near the former isobar, and less near the latter.

The center of this high-pressure area is marked "high." "High" on the weather map means an area where the pressure is distinctly higher than that of its surroundings, and generally exceeds 30 inches, and the word is placed in the center of such an area. The movements of air about a high are an *anticyclone*.



To the west of this "high" the pressure decreases steadily to North Dakota, where there is a center of low pressure, marked "low." "Low" means an area in which the pressure is less than 30 inches, and on the map the word is placed at the point in such an area where the pressure is lowest. The movements of air about a "low" constitute a *cyclone*. A cyclone is one type, and in middle latitudes the most important type, of a *storm*.

The isobar of 29.5 about the low in North Dakota is a closed line. Since the pressure is becoming less as this line is approached,

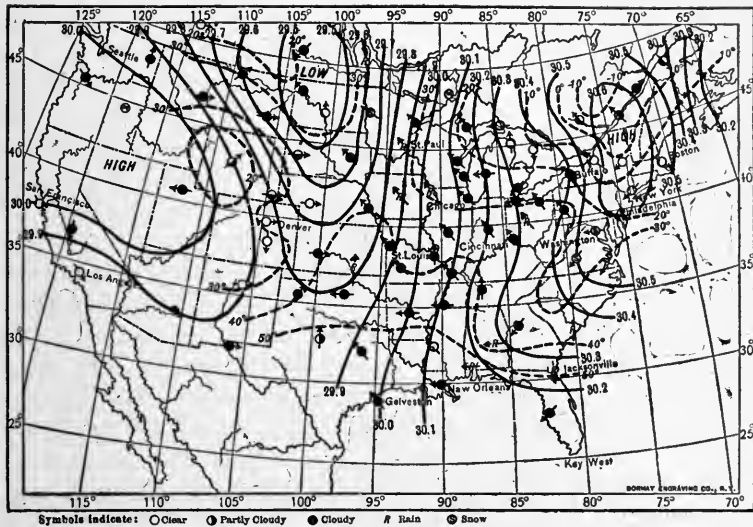

FIG. 605.—Weather map of the United States for January 12, 1899. The full lines are isobars, the dotted lines isotherms. (U. S. Weather Bureau.)

it is inferred that the pressure at all points within this isobar is less than 29.5, though nowhere so low as 29.4. At all points between the isobars of 29.5 and 29.6, the pressure is between these figures. West of the "low" the pressure increases. The pressure in the high near the Pacific coast is not so great as that in the high over the Hudson Valley.

Most weather maps show both lows and highs, or at least one of each. This means that there is generally at least one area of high pressure (anticyclone) and one of low pressure (cyclone) at the same time within the area of the United States. Since this is

the case, the atmospheric pressures are generally somewhat unequal in different parts of the country.

Weather maps are made by the Weather Bureau, a branch of the national Department of Agriculture. They are prepared in various central offices of the country. To these offices the facts concerning the pressure and the temperature of the air, the direction and velocity of the wind, the cloudiness, and the precipitation, are telegraphed daily from numerous points or "stations" established and maintained by the Government.

2. *Wind.* Wherever barometric pressures are unequal, isobaric surfaces are uneven. They are depressed in cyclones, and elevated in anticyclones. As a result, there must be winds from anticyclones to cyclones. On January 12, 1899 (Fig. 605), winds must have been blowing out from the highs in the east and west respectively, and toward the low in the northwest, on the day when the pressures were as indicated on the map. The arrows on the map show the direction of the winds, which blew as the arrows fly, as reported from the various stations.

It will be seen that winds do not blow straight out from the anticyclonic centres, nor straight in toward the cyclonic centers. They doubtless *start* straight out from each high, but they are deflected toward the right, as most of the arrows about the anticyclones show. Similarly, the winds which blow toward the cyclonic centers do not blow straight toward them, but are deflected a little to the right, as most of the arrows about the lows show. In the southern hemisphere the deflections would be to the left. Fig. 606 shows the theoretic circulation about highs and lows: A, northern hemisphere; B, southern hemisphere.

It will be noted that two arrows in the western high (Fig. 605) are directed toward the center of the high-pressure area. They probably mean that there are subordinate centres of lesser pressure within the general area of the anticyclone, and the winds blow toward them. If this is the case, the subordinate lows are too weak to be shown by the isobars, which represent differences of 0.1 inch.

Something as to the strength of the winds at various points may be inferred from the map. The distance from the center of the high in the east, Fig. 605, to Lake Michigan is about 800 miles. The difference in pressure is about 0.5 inch. The gradient is therefore about 1 (English system). This means a wind-velocity

of about 12 miles per hour—a fresh breeze—between these points. The velocity of the wind blowing from Michigan to North Dakota is about the same. The velocity of the wind from Texas to North Dakota is much less. In general, where isobars are crowded, the gradient is high and the winds strong. Where they are widely separated, the gradient is low and the air-flow gentle. The winds in cyclonic storms occasionally attain a velocity of 40 to 60 miles an hour; but the average is much less, and the cyclonic

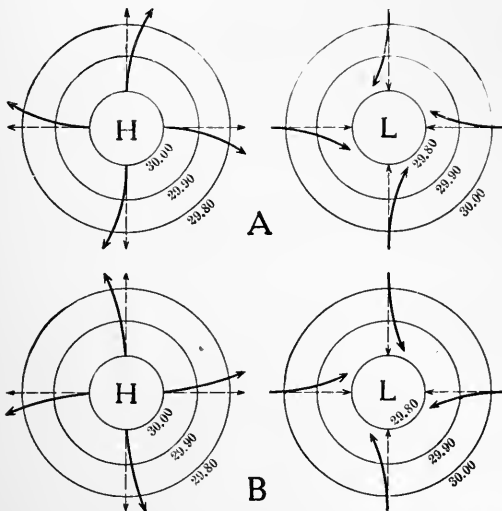

FIG. 606.—Diagram showing the deflection of air currents about highs and lows. A, northern hemisphere; B, southern hemisphere.

(not tornadic, p. 667) wind which is violent enough to be destructive is rare.

The circulation of air about a cyclone is vertical as well as horizontal: the air currents move in toward the center of the storm, and spirally up at the same time. This upward movement is of great consequence in its effect on precipitation. The upward and outward course of the air movement in the cyclone is shown in Fig. 607, which represents a vertical section of a cyclone, and shows that the outflow above is chiefly to the eastward, the direction in which prevailing winds blow.

3. *Cloudiness, precipitation, etc.* On the weather maps the open circle on the shaft of an arrow indicates clear skies; the

half-blackened circle shows that the sky is partly cloudy; while the black circle (Texas, Wyoming, etc.) indicates general cloudiness. Where *R* appears on the arrow, it means that rain is falling, as, for example, in Iowa and Alabama. Where *S* appears in the same position, it shows that snow is falling, as in north-western Minnesota, Virginia, and Maryland.

This weather map shows that more or less precipitation accompanies this cyclone, and the examination of a series of weather maps will show that cyclones are very often attended by rain or snow. Whether the precipitation takes the form of rain or snow depends on the temperature.

4. *Temperature.* The dotted lines of the weather map are isotherms. The isotherm of 50° F. (Fig. 605) crosses the Gulf States. South of it the temperature is above 50°, but not so high as 60°, within the area of this map. The isotherm of 40° is more irregular. It extends from Georgia to New Mexico, but between these points it turns north into Nebraska. All points between this isotherm and that of 50° have a temperature intermediate between 40° and 50°.

The isotherm of 30° is still more irregular. Dubuque, Ia., Chicago, Cleveland, Charlotte, N. C., and Norfolk, Va., have about the same temperature. An isotherm of 30° also extends from Idaho to New Mexico by a crooked course, while a third isotherm of 30° appears about the low. Two isotherms of 30° are therefore next each other on the map, one in the area to the east, and the other in the area to the southwest of the low.

The temperature between these isotherms is to be interpreted as follows: As the low is approached from the east, say from New York, the temperature rises. In the middle of Lake Superior the temperature is 20°, and at Duluth 30°. The next isotherm to the west, instead of being 40°, is 30°, and the one still farther west is 20°. This arrangement of isotherms means that the temperature west of the isotherm of 30° passing through Duluth is warmer than 30°, but not so warm as 40°; while farther west the temperature again becomes cooler, reaching 30° in the eastern part of North Dakota.

On the whole, the isotherms show two pronounced features: (1) they have little relation to parallels, for places in the same latitude may have very different temperatures, and places far apart in latitude may have the same temperature; and (2) the isotherms show a pronounced disposition to bend poleward where the isobars

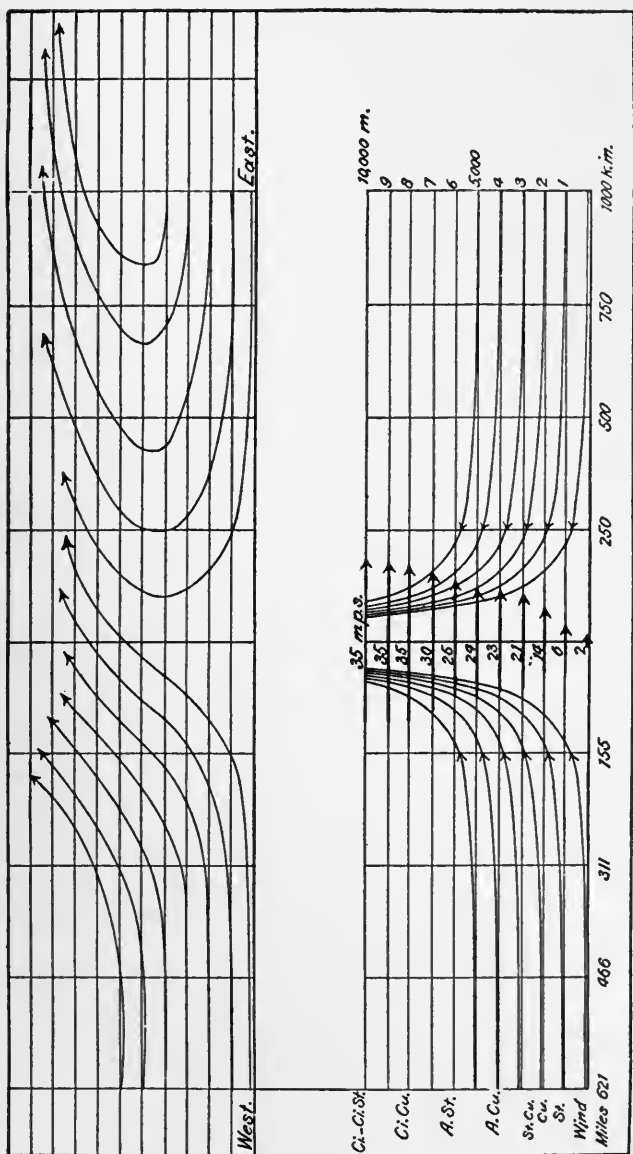
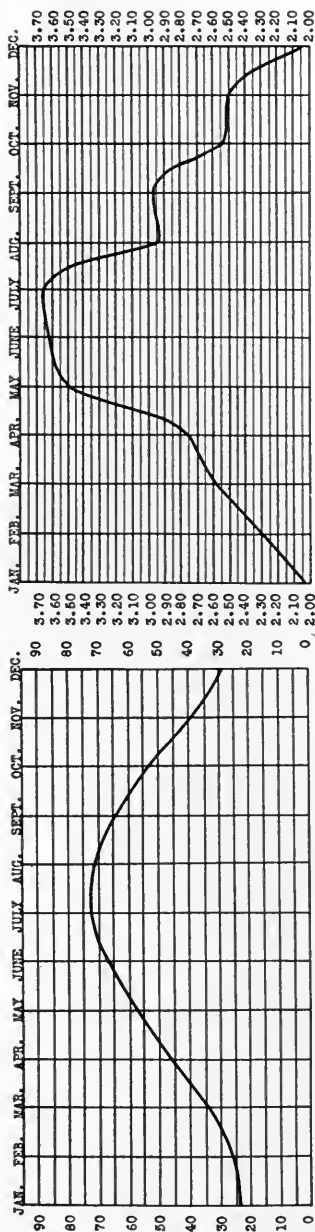
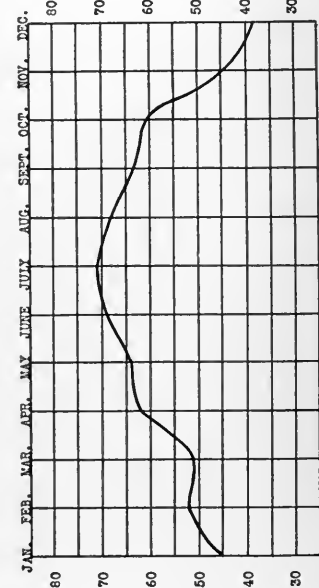

Fig. 607.—Diagram illustrating the general structure of a cyclone, and the general fact that the upper-air movements are in the direction of the prevailing winds. (U. S. Weather Bureau.)



A



B

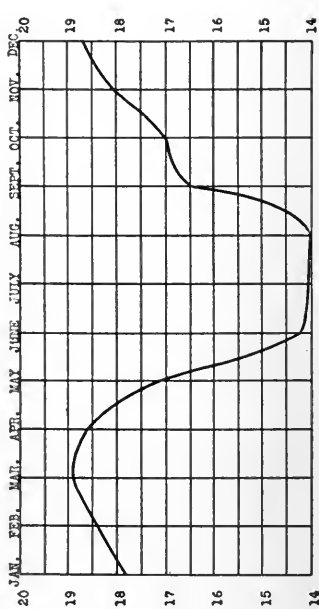

C

D

FIG. 608.—Graphs showing certain weather elements in Chicago. A, Average monthly temperature in degrees Fahrenheit; average for the year, 48.5°. B, Average monthly precipitation in inches; average for the year, 33.43 inches. C, Average monthly percentage of sunshine; average for the year, 58. D, Average monthly velocity of the wind in miles per hour; average velocity, 17 miles per hour. (Cox, U. S. Weather Bureau.)

indicate low pressure, and equatorward where the pressure is high.

Fig. 608 shows, by graphs, four of the weather elements for the year at Chicago. The figure shows that the winds are strongest in cold weather, that the proportion of sunshine is highest in mid-summer, while precipitation is greatest in the early summer. The same weather elements at other localities would give somewhat different graphs, and in some cases they would be very different (see Figs. 662 to 673).

All the weather maps which follow show some relationship between isobars and isotherms. In general the isotherms curve southward (equatorward) about a high, and northward (poleward) about a low. To this general rule there are some exceptions.

The temperature, the pressure, the winds, the cloudiness, the rain, etc., are the elements of the weather. All these things being shown on the above map, it is appropriately called a *weather map*.

The lows and highs are sometimes much more pronounced than those shown in Fig. 605. In Fig. 609 the low is more pronounced, the pressure ranging from 29.0 at the center, to 30.1 in the east and to 30.5 in the west. So great a range of pressure as shown by this map is not of common occurrence. The isobars are closer together in this figure than in the preceding, and therefore indicate stronger winds. The approximate velocity of the wind at various points may be calculated from the map. The direction of the winds about the low is the same as in Fig. 605. Cloudy skies prevail in the southeastern part of the low, and snow is falling at some points (Montreal, Duluth). The map also shows great ranges of temperature in areas not far apart. Thus there is a temperature of 30° F. at Sault Ste. Marie, and a temperature of -10° at Winnipeg, but little farther north; while Montreal has a temperature above that of Santa Fé. As in preceding illustrations, the low temperature goes with high pressure, and the higher temperature with low pressure.

Fig. 610 shows a large and less symmetrical low. The winds blow toward it, but are deflected to the right of its centre. Cloudiness prevails over a great area about the cyclone, and snow and rain are falling at some points.

The low of this map dominates almost the whole country. Measuring from the 30-inch isobar on the east to the 30-inch isobar on the west, the cyclone is about 1800 miles across. The isotherms

bend northward on the south side of this low, while they curve southward about the high north of Montana. Fig. 611 shows an

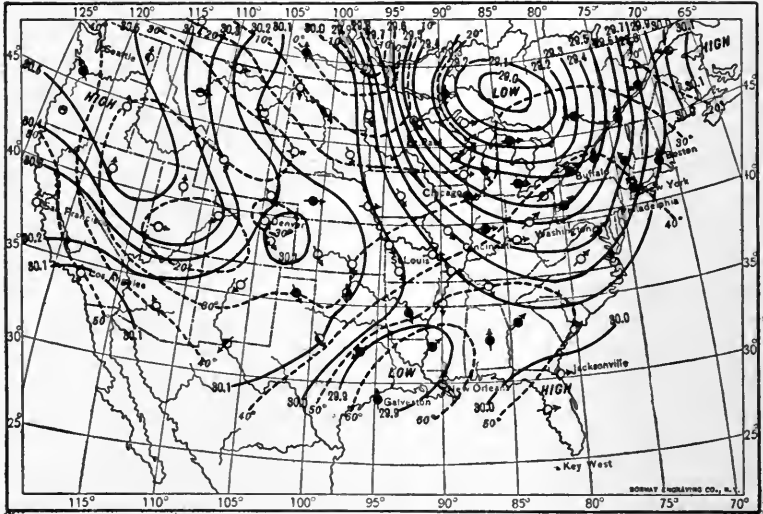

FIG. 609.—Weather map for January 16, 1901. (U. S. Weather Bureau.)

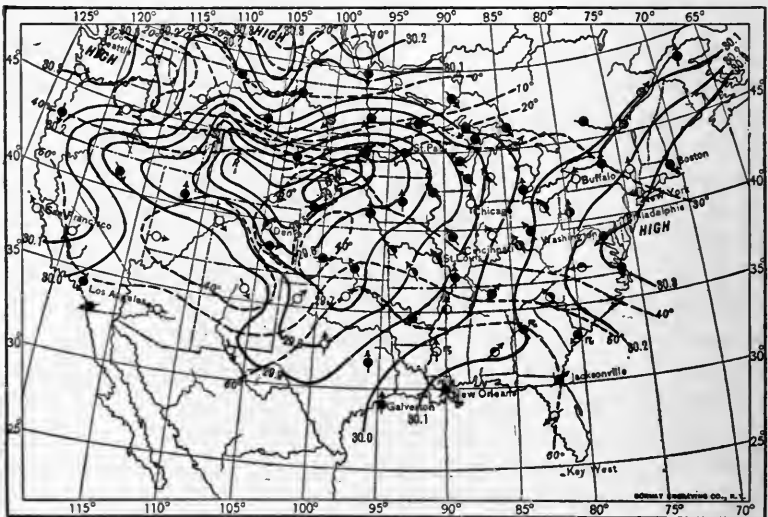

FIG. 610.—Weather map showing a large asymmetrical low, March 2, 1904. (U. S. Weather Bureau.)

elongate cyclone, one diameter of which is very long; and Fig. 612 shows its transformation the succeeding day. The isotherms of Fig.



612 show few peculiarities, save in the northwest (Nebraska, Wyoming, Montana), where the temperature drops from 20° near Rapid

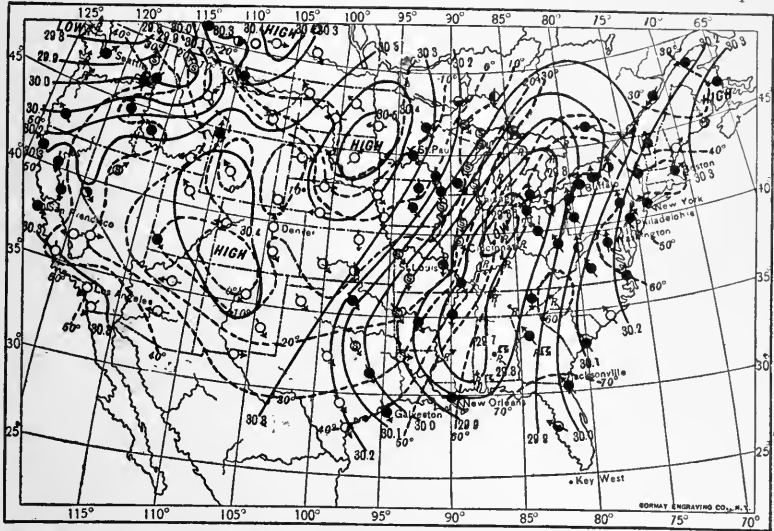

FIG. 611.—Weather map showing a large elliptical cyclone, January 22, 1906 (U. S. Weather Bureau.)

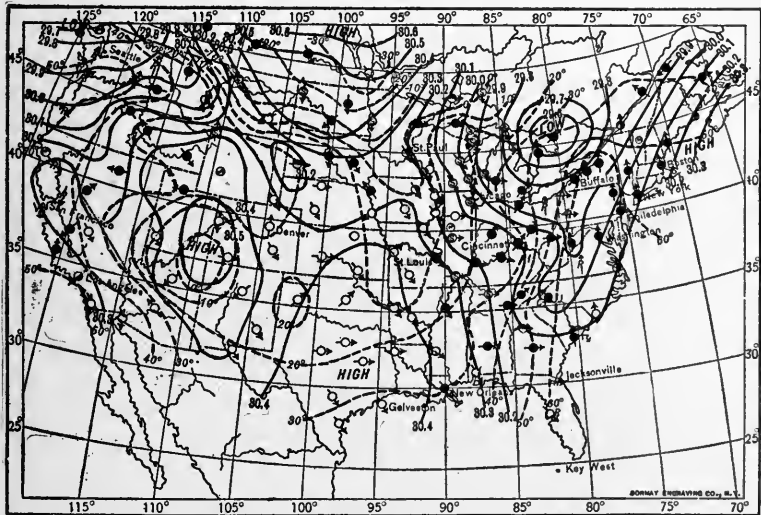

FIG. 612.—Weather map for January 23, 1906, showing great changes in the cyclone of the preceding day. (U. S. Weather Bureau.)

City, South Dakota, to  $-30^{\circ}$  at Q'Appelle, in Alberta, a difference far greater than can be accounted for by the difference in latitude.

Q'Appelle, it will be seen, is southeast of a high where the fall of temperature is pronounced, as shown by the crowding of the isotherms in South Dakota. The rapid change of temperature is in a region where the wind is strong, and from the northwest.

Around all the preceding cyclones some precipitation is indicated, while around most of the anticyclones there is an absence of precipitation. The chief reason for rainfall or snowfall about

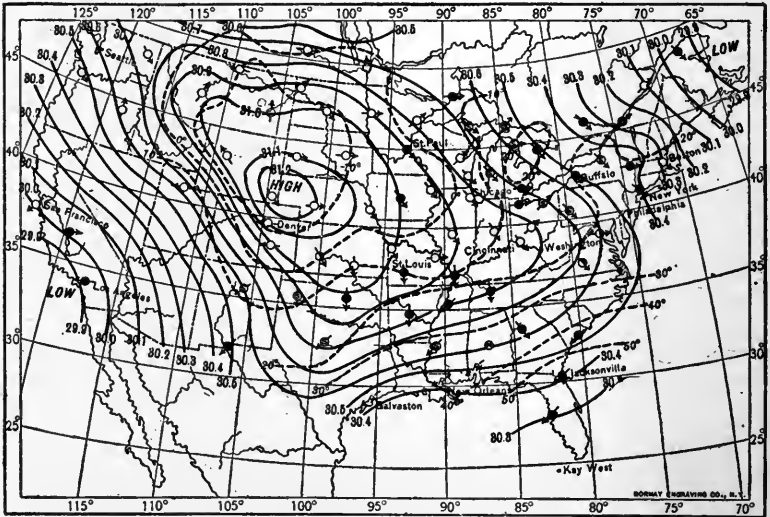

FIG. 613.—Weather map for December 9, 1898, showing a high of great area. (U. S. Weather Bureau.)

a low is as follows: The inflowing air produces an upward spiral current, and the rising air expands and is cooled (p. 537), and so gives up some of its moisture. In the southeast quadrant of the cyclone, additional precipitation results from the fact that the air entering the cyclone is passing from warmer to cooler latitudes. This is perhaps one reason why the precipitation about a cyclone is greatest in this quadrant. The right-handed movement of the air in the northern hemisphere tends to shift the center of principal precipitation somewhat to the east of south of the center of the cyclone.

In the anticyclone there is a descending spiral movement of air. The descending air comes from an altitude which is colder than that at the bottom of the atmosphere, and hence brings a low temperature. Since the air is compressed and warmed as it

descends, the winds from anticyclones generally bring clear weather. The downward- and outward-moving air may, however, so mingle

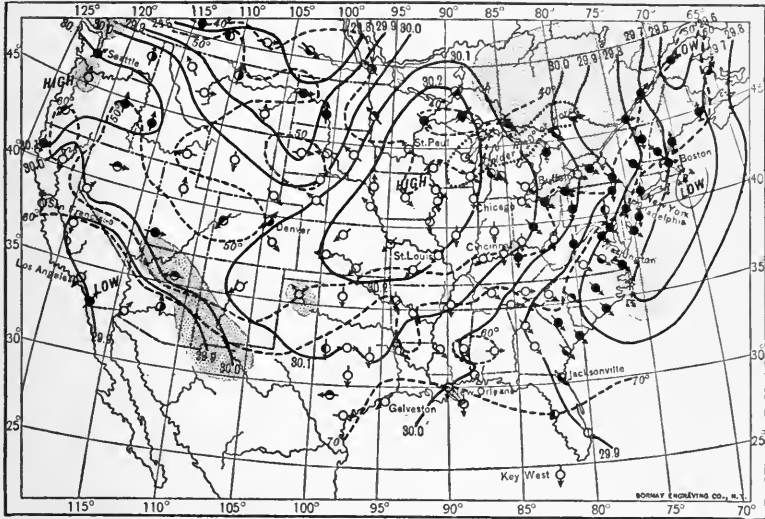

FIG. 614.—Weather map for September 24, 1903. The shaded area in this and succeeding maps represents precipitation. (U. S. Weather Bureau.)

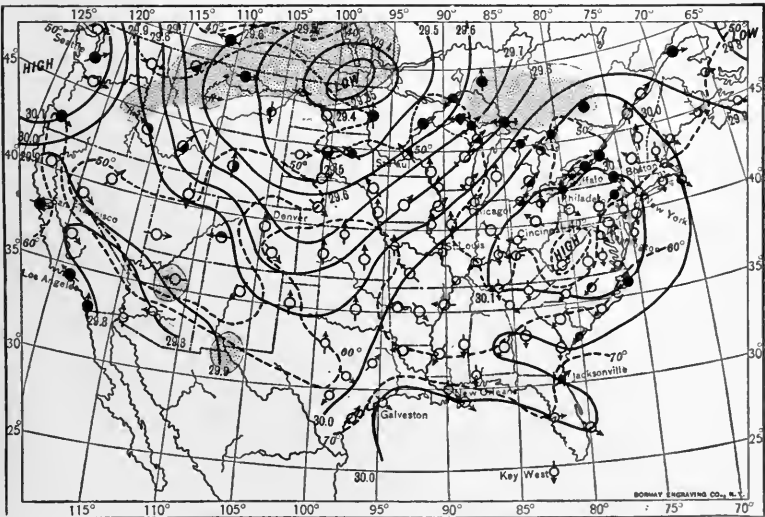

FIG. 615.—Weather map for September 25, 1903. (U. S. Weather Bureau.)

with the warm air about it as to cause some of the moisture of the latter to condense, giving rise to clouds, or even to precipitation.

Highs of great area, as well as lows of great area, sometimes occur. Fig. 613 shows a high or anticyclone some 2200 miles across, with a great range of pressure. The isotherms of this chart stand in very definite relations to the isobars, low temperatures going with high pressures. Denver, in the high, is about  $30^{\circ}$  colder than the southern part of Maine,  $3^{\circ}$  farther north, in a low.

**Movements of Cyclones and Anticyclones.** The highs and lows do not remain in the same place from day to day. This is shown by Figs. 614–620, as well as by the other weather maps which follow, showing the weather of successive days.

In Fig. 614 there is (1) a low over the Gulf of St. Lawrence; (2) a high central over Iowa; (3) a low over British Columbia; (4) a high in Oregon.

The map of the succeeding day (Fig. 615) shows (1) that the low of the St. Lawrence Gulf has moved to the east; (2) that the high of the interior has moved to West Virginia; (3) that the low

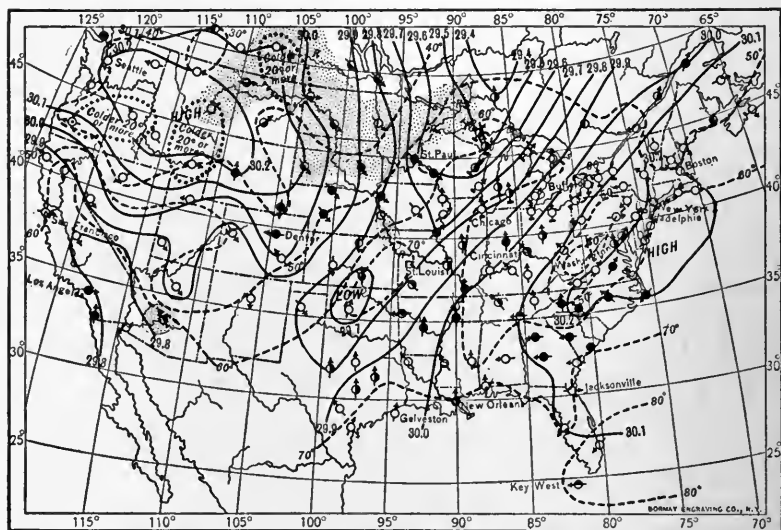

FIG. 616.—Weather map for September 26, 1903. (U. S. Weather Bureau.)

which was over British Columbia has moved to Dakota; while (4) the high of the Oregon coast remains about where it was.

The map of the succeeding day (Fig. 616) shows (1) that the high of the Virginias has moved on, but not so far as on the pre-

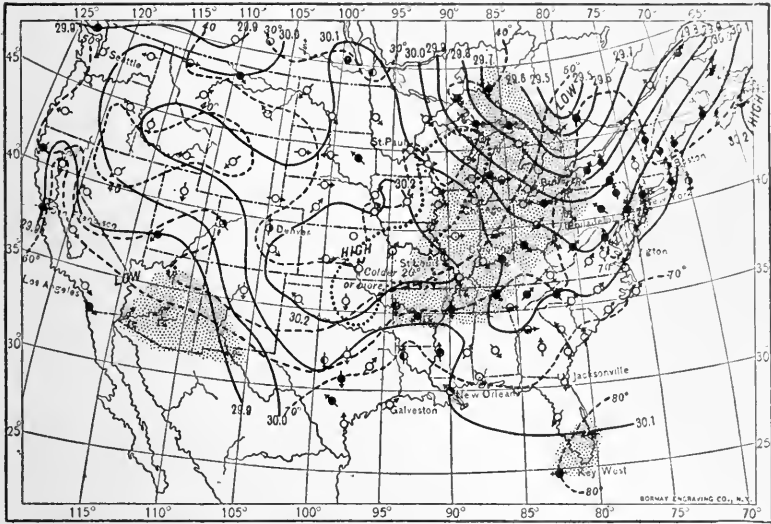

FIG. 617.—Weather map for September 27, 1903. The symbol which appears in central Arkansas and western Tennessee indicates a thunder-storm at or near the point where the symbol occurs, during the twelve hours preceding the issue of the weather map. (U. S. Weather Bureau.)

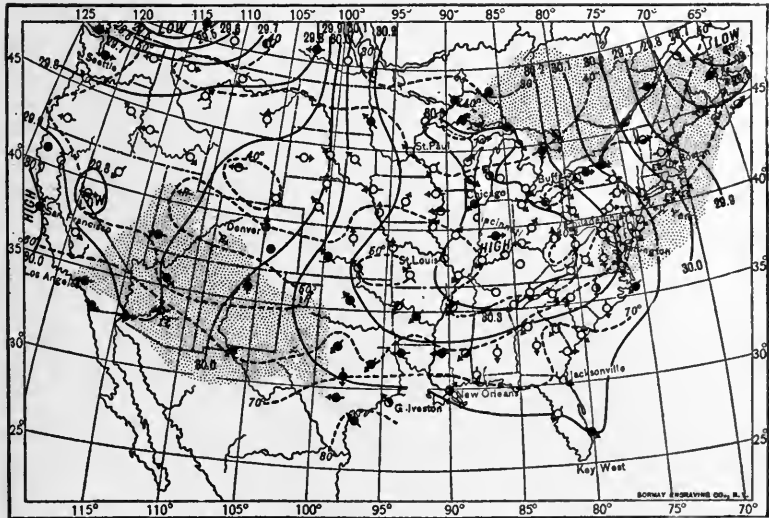

FIG. 618.—Weather map for September 28, 1903. (U. S. Weather Bureau.)

ceding day; (2) that the low which was over North Dakota is now north of Lake Superior; (3) that the high of Oregon has moved east to Idaho and Montana; and (4) that a weak low has developed in Indian Territory.

The map of the 27th (Fig. 617) shows (1) that the high which was over the Virginias has disappeared, presumably to the east; (2) that the low which was north of Lake Superior is now north of Lake Ontario; (3) that the high of Montana has moved southeast to Kansas; (4) that the weak low in Oklahoma and Indian Territory has disappeared; and (5) that another low has appeared in southern California. The succeeding map (Fig. 618) shows that all the highs and lows of the preceding map have advanced in a general easterly direction. Fig. 619 shows that the two lows of

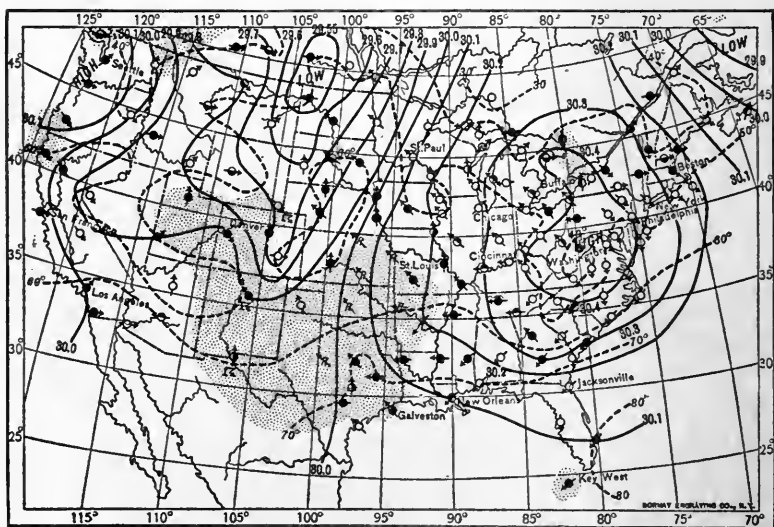

FIG. 619.—Weather map for September 29, 1903. (U. S. Weather Bureau.)

Fig. 618 near the Pacific have united, the southerly one having moved over to the more northerly—a not uncommon occurrence. Fig. 620 shows the progress of this low as well as of other highs and lows, and a great rain area about the central low.

While the highs and lows of these maps have all moved in a general easterly direction, the highs moved rather more to the south of east than the lows. The direction of the progress of the highs and lows shown by these maps is the normal one, though

individual cyclones and anticyclones depart notably from the normal. The average direction of the cyclone in our middle latitudes is about N. 80° E., or 10° north of east. The anticyclones have a somewhat more southerly course.

From the study of these maps not only the fact of movement, but the rate of movement of the highs and lows, may be calculated. Thus, from the 25th to the 26th (Figs. 615 and 616), the low of British Columbia moved about 1200 miles. From the 26th to the 27th, and again from the 27th to the 28th, the same

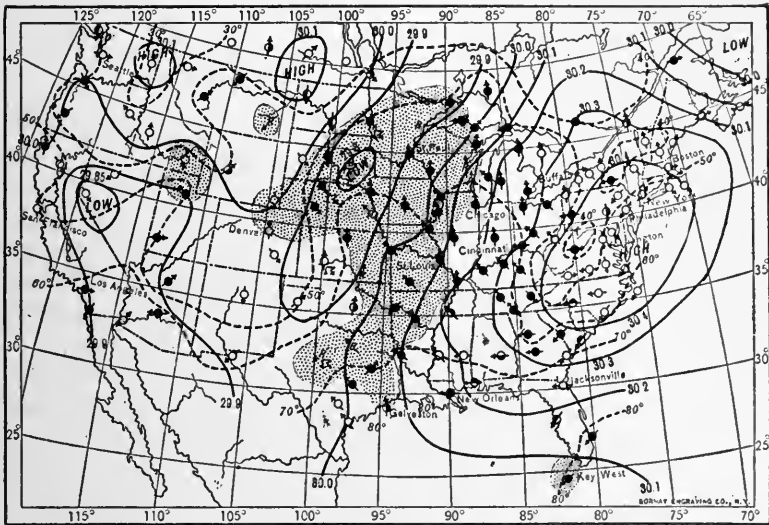

FIG. 620.—Weather map for September 30, 1903. (U. S. Weather Bureau.)

storm moved between 600 and 700 miles, while from the 28th to the 29th the movement was about 800 miles. The average velocity of cyclones in the United States is a little less than 29 miles per hour (about 700 miles per day); that of anticyclones somewhat less.

It is not to be understood that the rate of progress of the storm is the same as the velocity of the wind. The velocity of the wind depends on the isobaric gradients. A weak cyclone, that is, a cyclone in which differences of pressure are not great (Fig. 620), gives rise to weak winds, even though the center of the storm moves rapidly. A strong cyclone, that is, one in which the dif-

ferences of pressure are great (Fig. 609), gives origin to strong winds, even though the cyclone itself moves forward slowly.

Figs. 621 and 622 show the progress of lows and highs, or cyclones and anticyclones, from December 24 to December 25, 1904. The course of the low central over Oregon on the 24th, is indicated by the arrows on the map of the 25th. Figs. 623-626 show the movement of cyclones and anticyclones for four consecutive days in February, 1903, and especially the course of a low from Arizona (Fig. 623) to Maine (Fig. 626). Figs. 627 and 628 show similar features for November 26 and 27, 1898. The progress of highs and lows shown on these maps (Figs. 614-628) represents the general course of movement of most similar atmospheric disturbances.

The mean tracks of cyclones and anticyclones for the United States are shown in Fig. 629. The heavier lines show the average paths of anticyclones, and the lighter the tracks of cyclones. Some anticyclones enter the United States from the Pacific, while others originate on the land north and northwest of Montana. The anticyclones take either a northerly or a southerly route across the continent. The former extends through the Great Lakes region to southern New England, while the latter reaches the Atlantic or the South Atlantic coast. Anticyclones entering from the Pacific may take either of these courses, and those originating in the northwest may do the same, as shown by the figure.

The cyclones originate, or first appear, in various places. More of them originate near the places where anticyclones are generated than in any other place; but not a few originate in Colorado, the Great Basin, in Texas, and elsewhere. Those originating in the northwest usually pass through the Great Lakes region to northern New England. Those originating farther south may follow a southerly course to the Atlantic, or may pass to the northward. Tropical cyclones, to be mentioned later, sometimes reach the Gulf of Mexico from lower latitudes, and follow the coast thence to the northeast.

Still another set of lines in Fig. 629, marked 1 day, 2 days, 3 days, and 4 days, show the average rate of daily progress of the storms which come in from the northwest on successive days.

Weather maps are sometimes more complicated than those shown in the preceding figures. Fig. 630 is a weather map on which four highs and four lows, some of them feeble, appear.



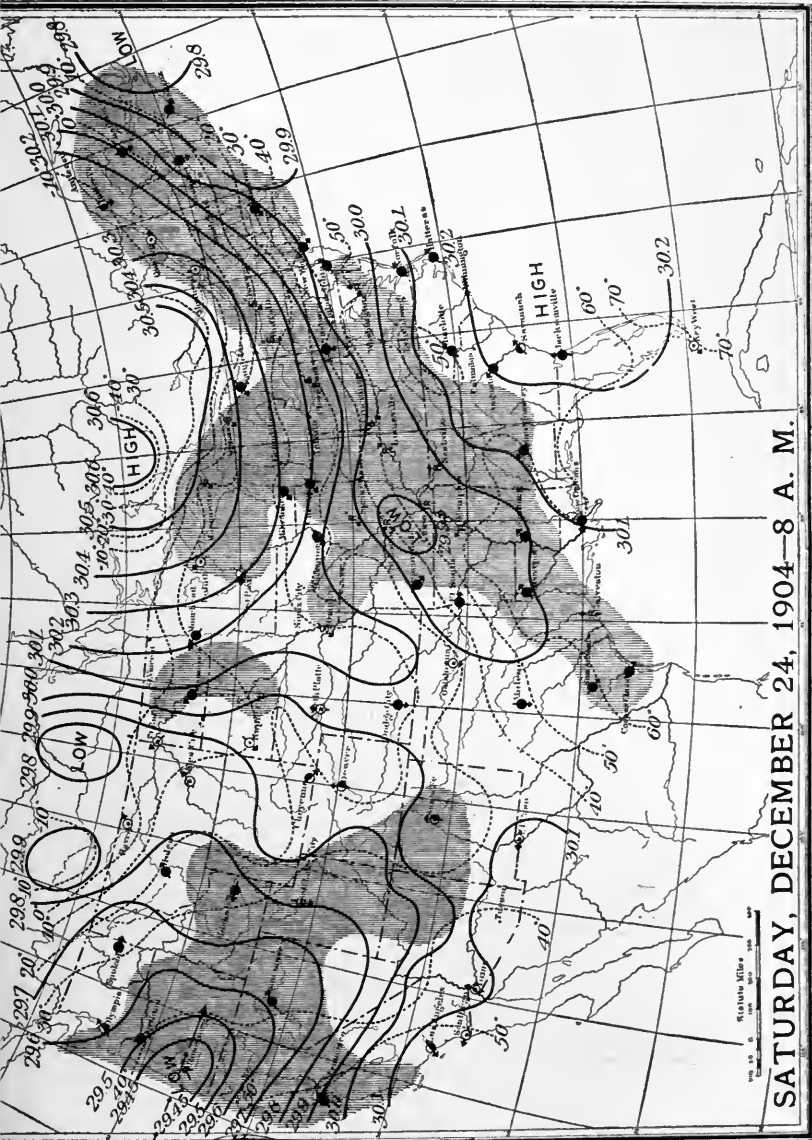

**SATURDAY, DECEMBER 24, 1904—8 A. M.**

Fig. 621.—The shading represents precipitation. (Cox, U. S. Weather Bureau.)

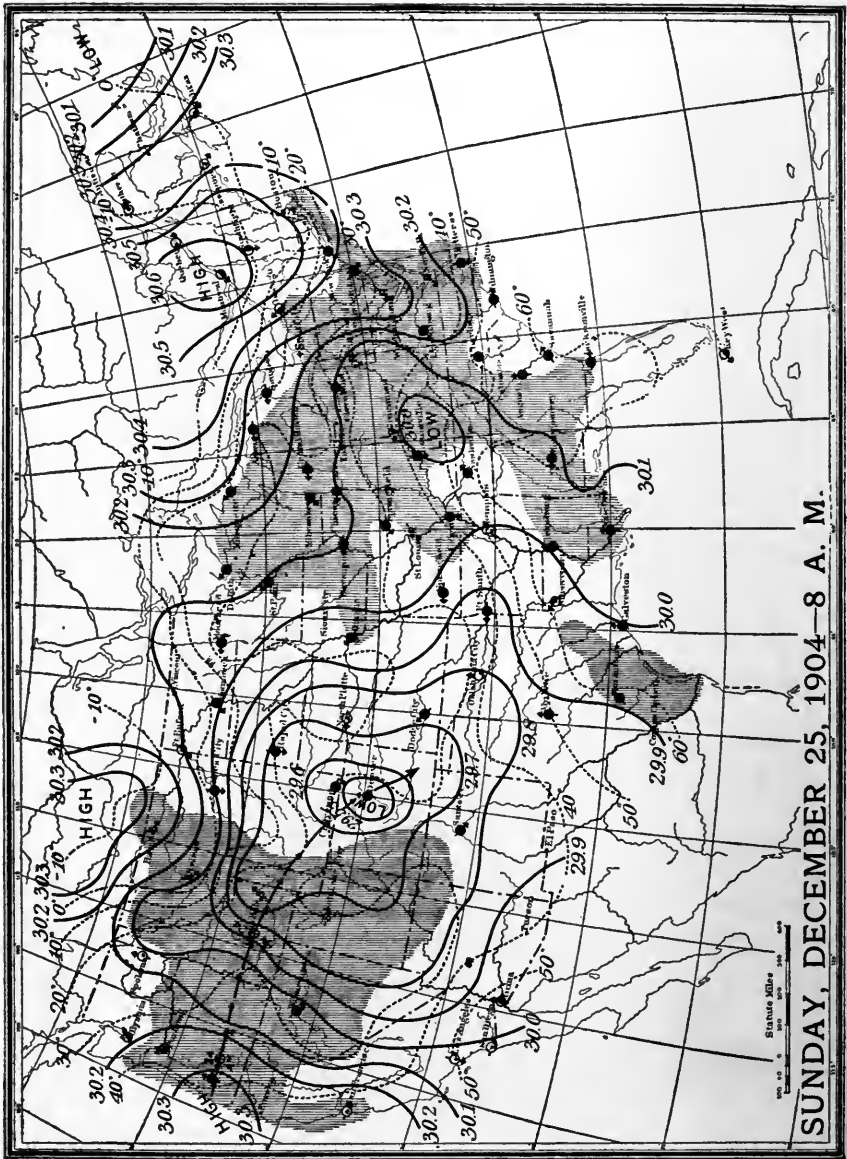
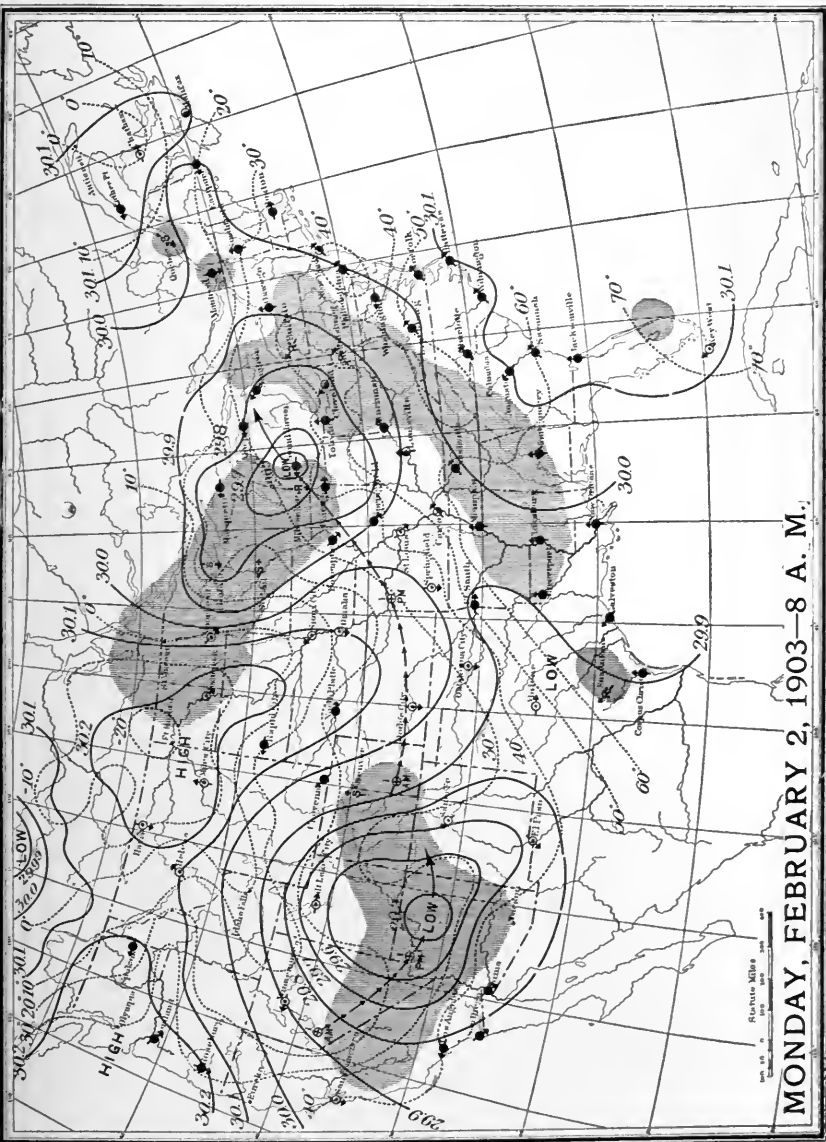
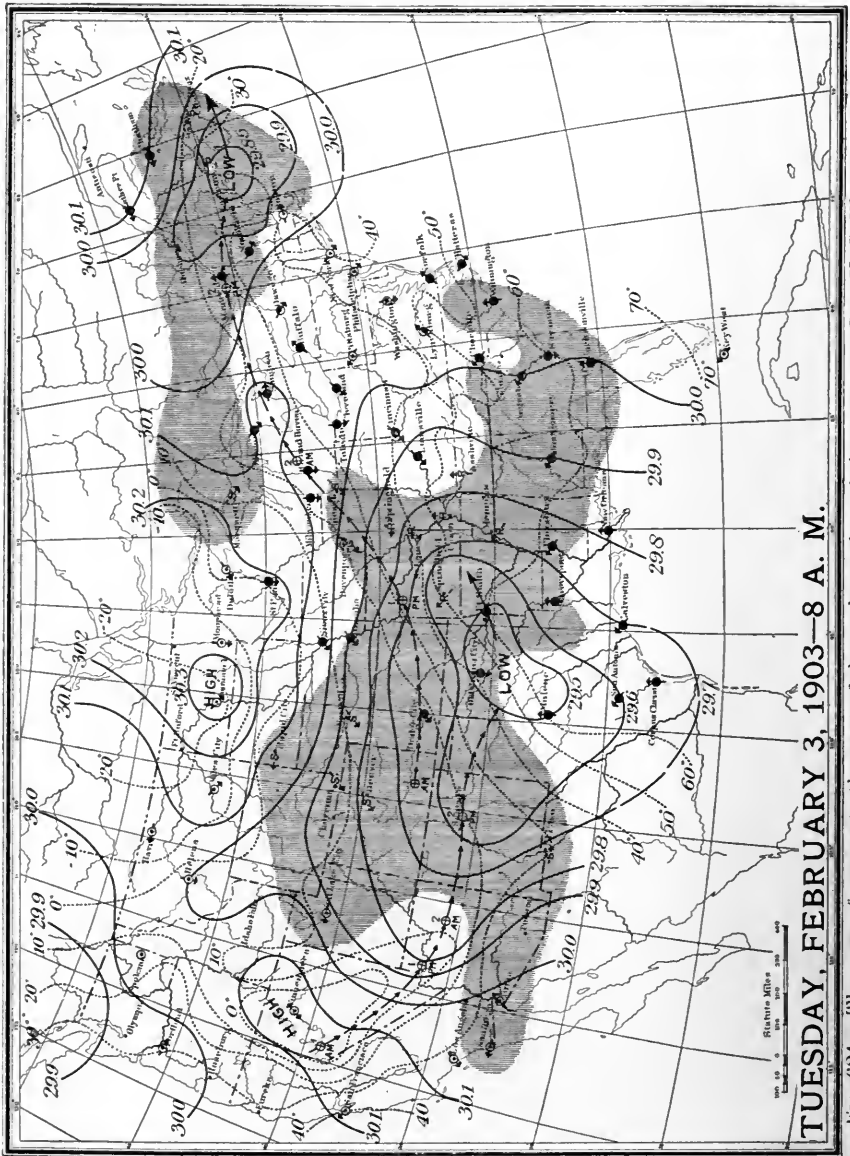

FIG. 622. (Cox, U. S. Weather Bureau.)



**MONDAY, FEBRUARY 2, 1903—8 A. M.**

Fig. 623.—The row of arrows ending at the low in Michigan shows the course of the storm from Colorado, and the arrows northwest of the cyclone in Arizona show the course of this storm thus far. (U. S. Weather Bureau.)



TUESDAY, FEBRUARY 3, 1903—8 A. M.

Fig. 624.—The rows of arrows to the west of the cyclones show their courses. (Cox, U. S. Weather Bureau.)

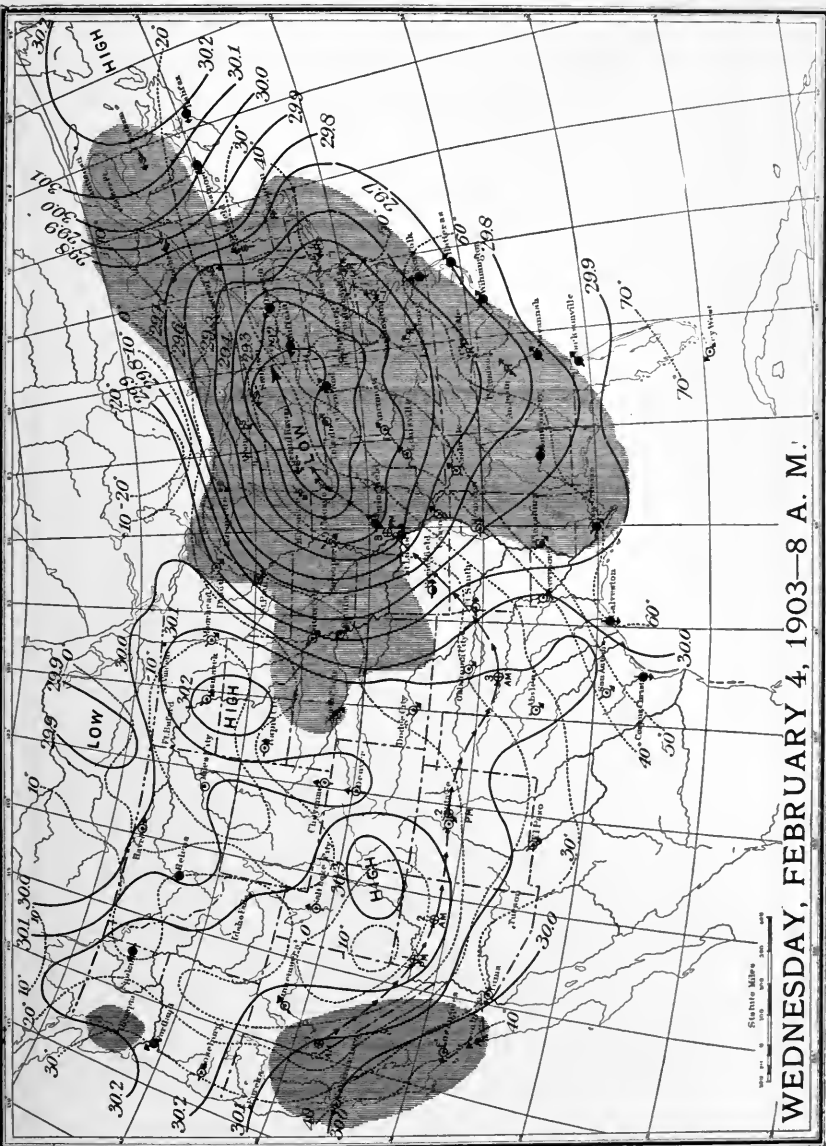

Fig. 625.—The rows of arrows have the same significance as in Figs. 623 and 624. (Cox, U. S. Weather Bureau.)

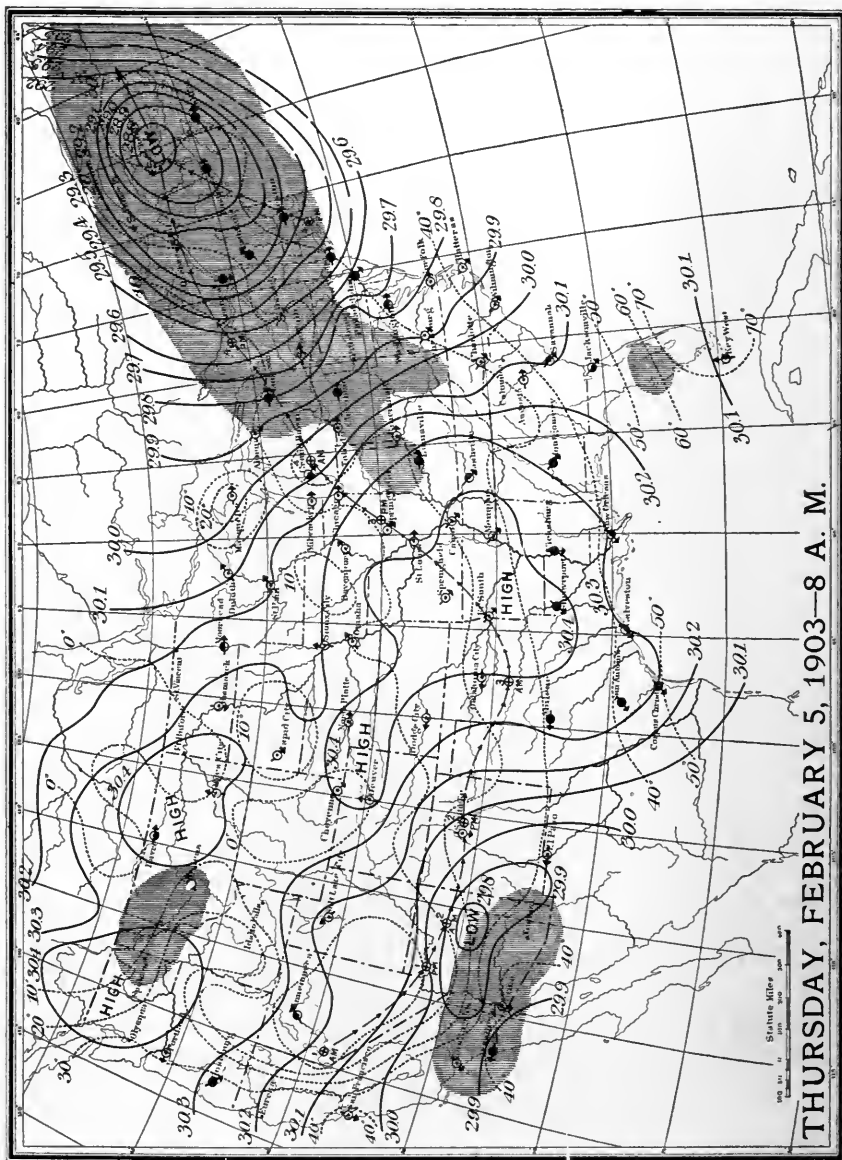

FIG. 626. (Cox, U. S. Weather Bureau.)

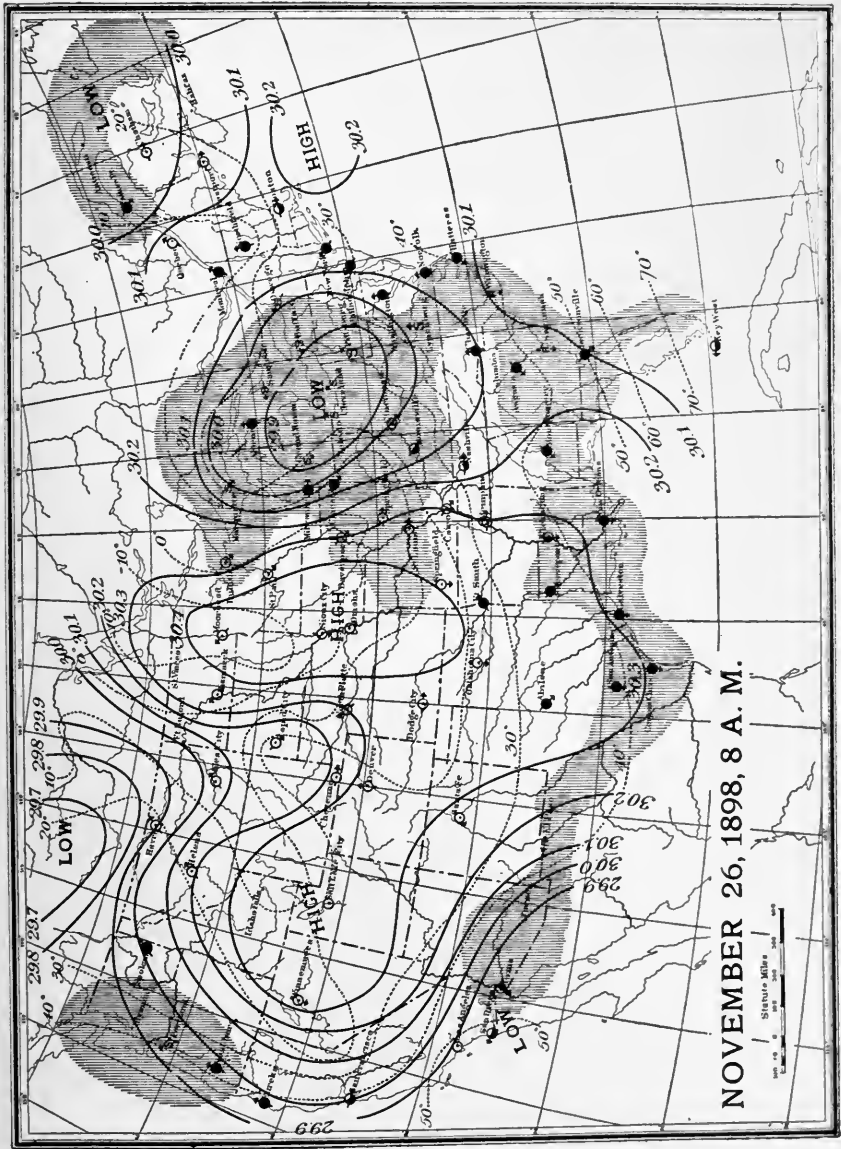

Fig. 627. (Cox, U. S. Weather Bureau.)

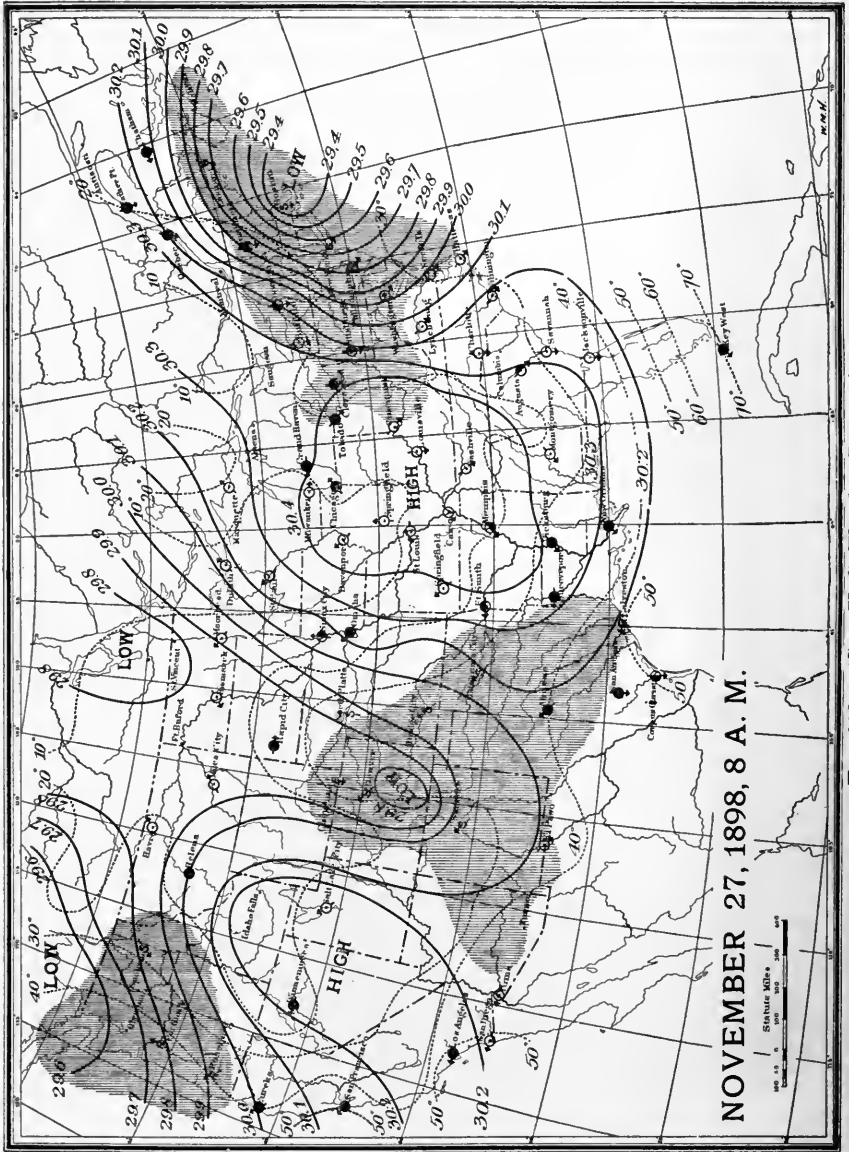

Fig. 628. (Cox, U. S. Weather Bureau.)



The map also gives some idea of the way lows and highs follow each other. The relations of isotherms and isobars are also instructive.

It will be readily seen that the passage of a cyclone involves a change in the direction of the wind. Thus in Fig. 623 the wind at Buffalo is easterly, though in the zone of westerly winds. The next day, after the storm centre has moved forward beyond Buffalo (Fig. 624), the wind is westerly. The easterly wind of an approaching cyclone is generally taken as a sign of rain throughout much of the eastern part of the United States.

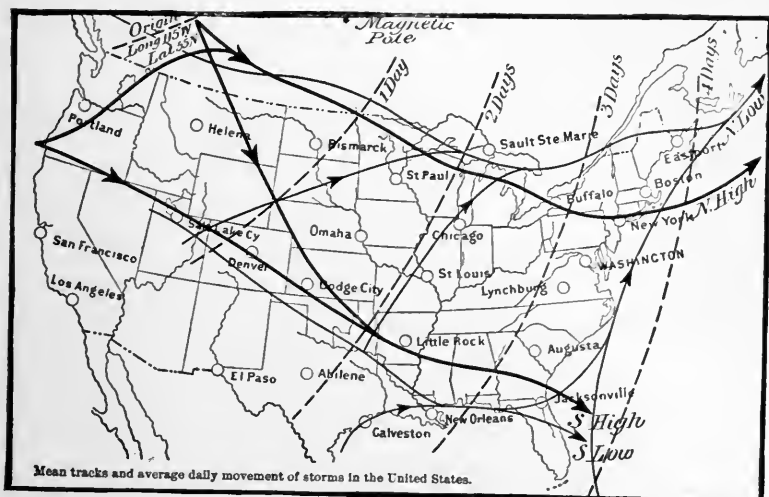

FIG. 629.—The heavier lines show the tracks of anticyclones, and the lighter lines the paths of cyclones. Off the South Atlantic coast anticyclones are likely to turn northward. (U. S. Weather Bureau.)

Cyclones do not affect the air to great heights. Even when the great whirl or eddy is 2000 miles across, as is sometimes the case, its height (depth) is rarely more than 4 or 5 miles.

**Weather conditions of cyclones and anticyclones.** During the passage of a cyclone some air is drawn from lower to higher, and therefore from warmer to cooler latitudes. In midsummer this often gives rise to the "hot wave" (Fig. 631), though "hot waves" are not always closely associated with cyclones. Similar winds are known as the sirocco in the western Mediterranean region, and they go by other names elsewhere.

"Cold waves" often attend the anticyclones. These winds are

known as *northers* in the southern part of the United States and sometimes as *blizzards* in the northern part, though this name

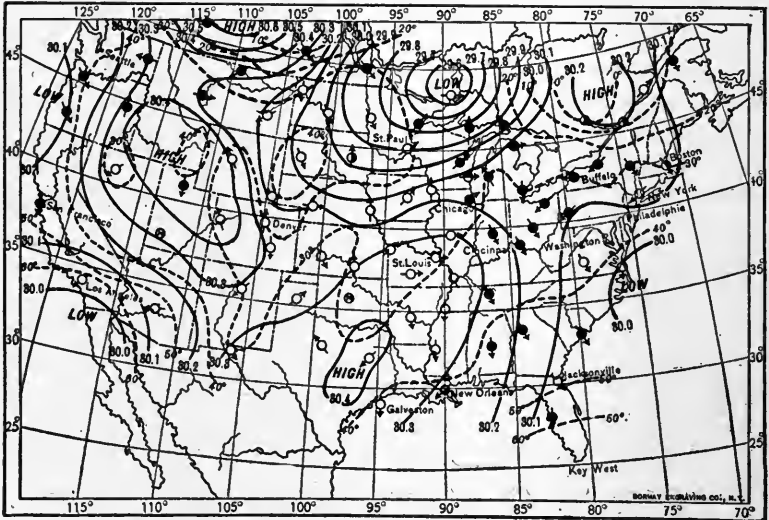

FIG. 630.—Weather map for December 8, 1900. (U. S. Weather Bureau.)

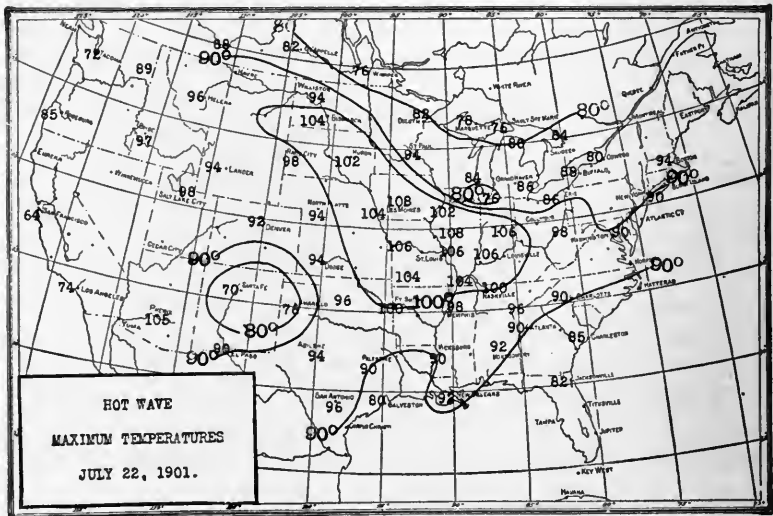

FIG. 631. (U. S. Weather Bureau.)

usually implies heavy snowfall and high wind, as well as low temperature. Fig. 632 shows a map for January 3, 1896,

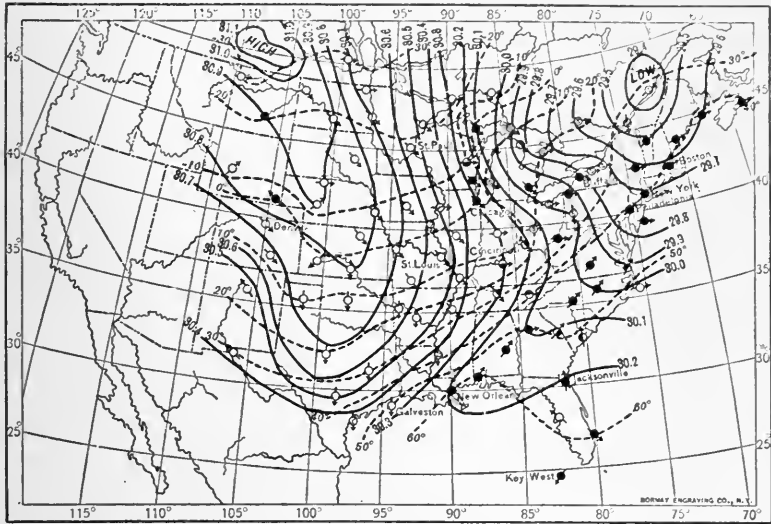

FIG. 632.—Map showing the minimum temperatures for January 3, 1896.  
(U. S. Weather Bureau.)

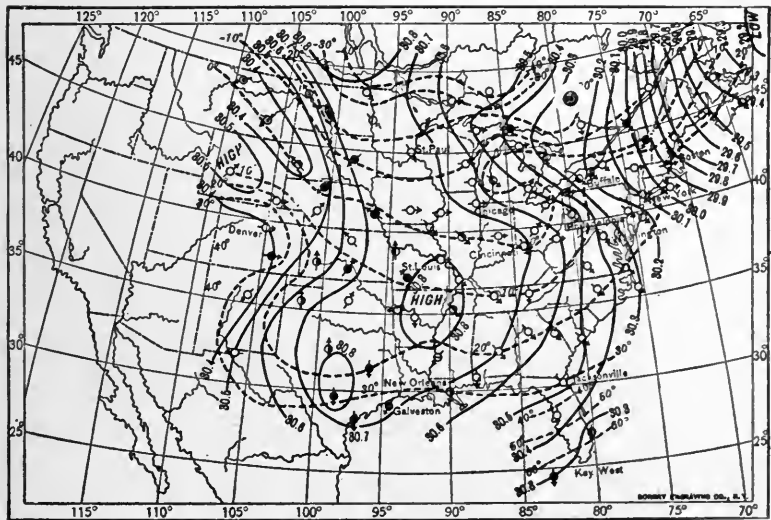

FIG. 633.—Map showing the minimum temperatures for January 4, 1896.  
This figure shows the progress of the cold wave from the preceding day.  
At this time a freezing temperature has reached the orange groves of  
Florida. (U. S. Weather Bureau.)

and Fig. 633 a map for the following day. The high of Montana has advanced to Arkansas and Mississippi, and a freezing temperature has been carried down to the orange groves of Florida.

The *mistral* of southern Europe belongs to the same class as the northers of our country.

**Origin of the cyclones and anticyclones of intermediate latitudes.** The origin of cyclones and anticyclones is not well understood. Centres of low pressure might be brought about by the excessive heating of certain areas; but this can hardly be the origin of most cyclones of temperate latitudes, for they are more common, stronger, and move faster in winter than in summer. In the winter season they often originate in areas covered with snow, where excessive heating is impossible. Similarly, anticyclones might be conceived to result from the unusual cooling of certain areas; but that this is not their course seems clear from the fact that they sometimes originate in warm regions, and from the further fact that they are not notably more abundant in cold weather than in warm weather.

The origin of both sorts of disturbances is probably to be referred to atmospheric movements rather than to atmospheric temperatures directly. The cyclones are frequently regarded as eddies in the descending air which started poleward from the equator. While this may be true, it does not appear to be a satisfactory statement concerning the origin of these common air-whirls.

**Tropical cyclones.** Cyclones sometimes originate in tropical regions, and follow courses very different from those of the cyclones in temperate latitudes. The cyclones of this class affecting North America usually originate in the West Indies, and are most common in the late summer and early autumn. They follow a north-westerly course until the latitude of Florida is reached. Here they commonly turn to the northward, and later to the northeastward, and have a tendency to follow the Atlantic coast. Figs. 634-637 show the course of one of these storms in August (27-30), 1893, and Fig. 638 shows the average path of the tropical cyclones for the months of August, September, and October, for the years 1878 to 1900. Storms of this sort are sometimes called *hurricanes*.

The tropical cyclones are usually more pronounced than those of temperate latitudes; that is, the gradient is higher and the winds therefore stronger. They often do great damage along the coast, both to shipping and to the low lands near the water. The storm which worked such devastation to Galveston in September, 1900, is shown

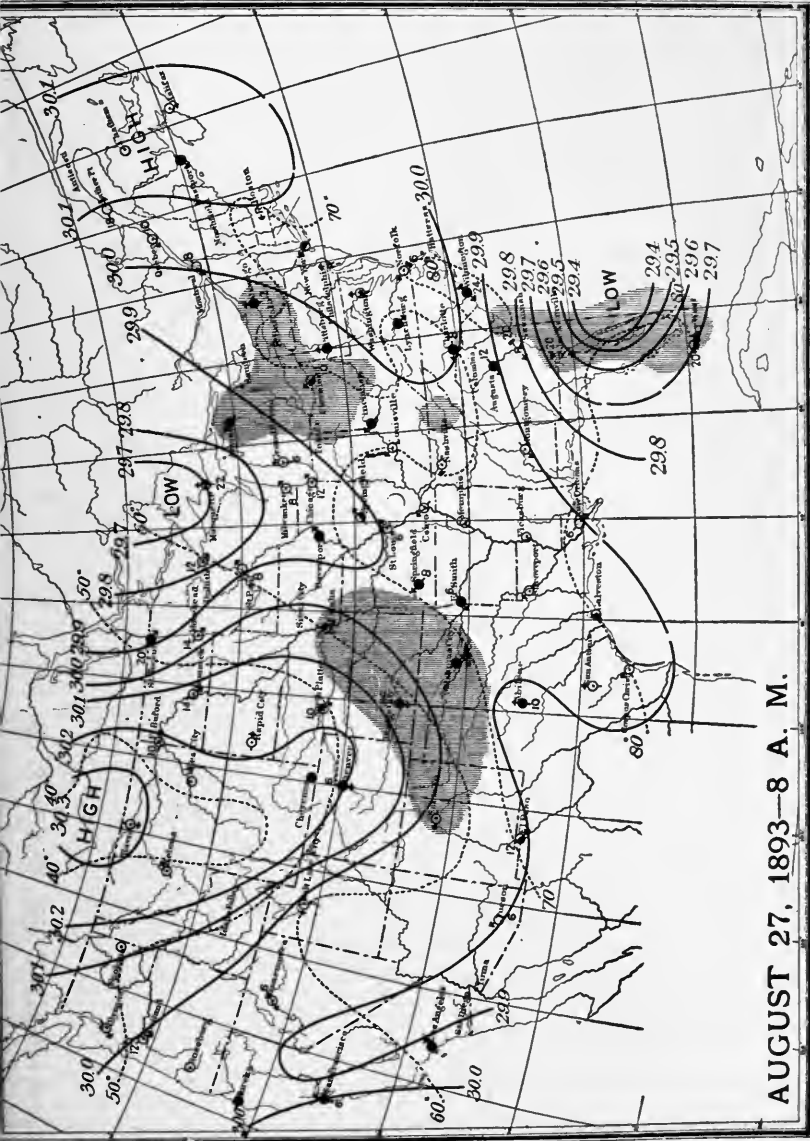
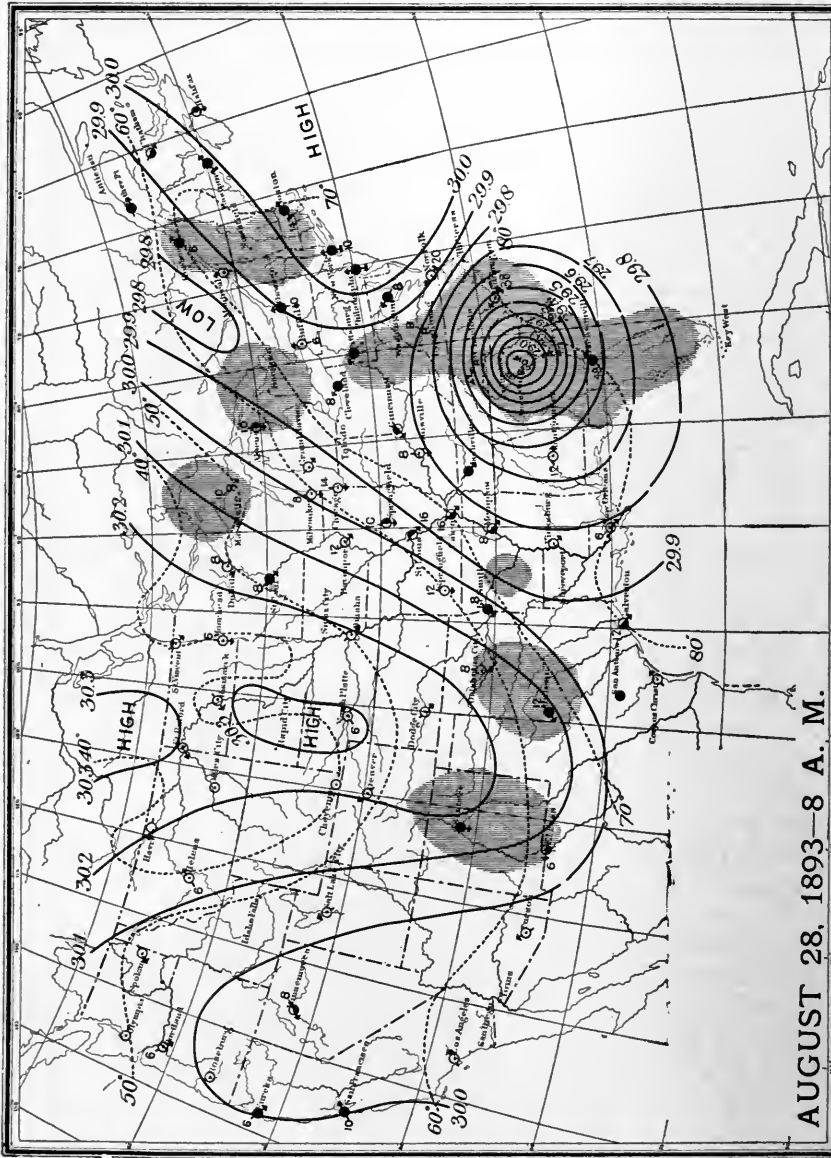
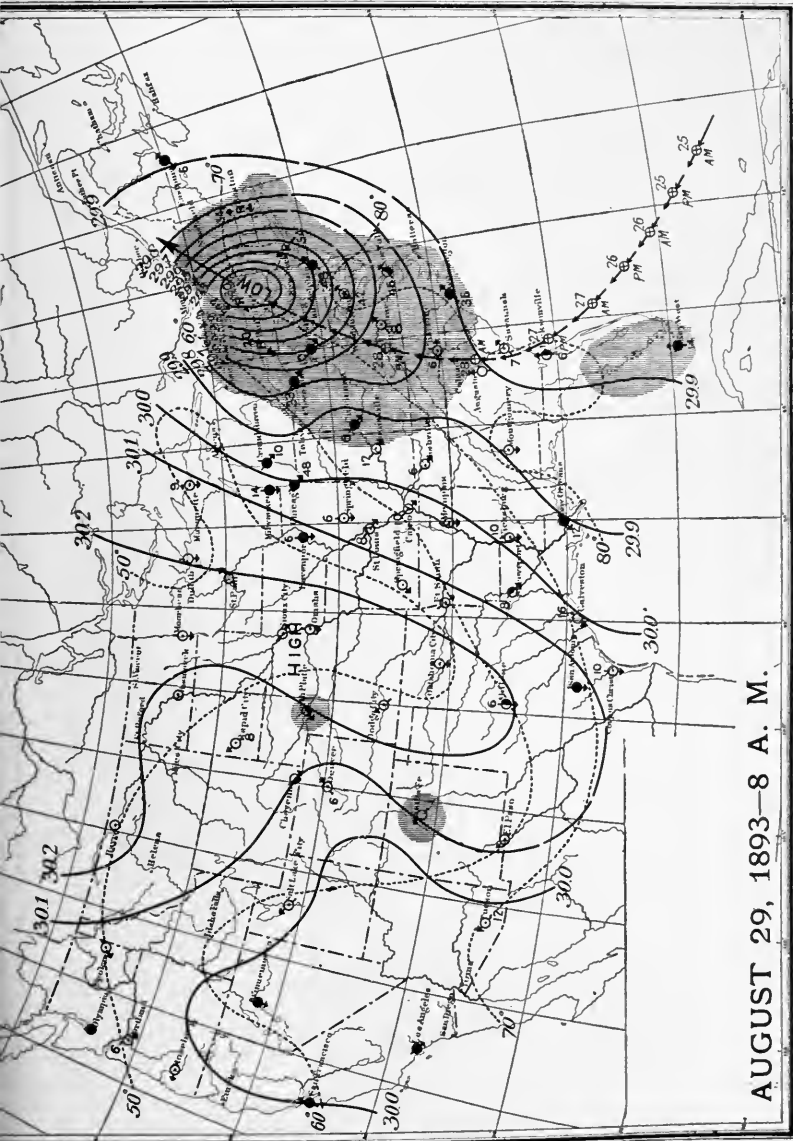

Fig. 634.—Weather map showing a tropical cyclone, central off Florida. (U. S. Weather Bureau.)

AUGUST 27, 1893—8 A. M.



AUGUST 28, 1893—8 A. M.



AUGUST 29, 1893-8 A. M.

FIG. 636.—Weather map showing further progress of the storm shown in Figs. 534 and 535.  
(U. S. Weather Bureau.)



FIG. 637.—Weather map showing the last of the storm shown in the preceding figures. (U. S. Weather Bureau.)



in Fig. 639, which also shows the course of the storm both before and after September 8. The strength of the storm was exceptional, and its course unusual, as will be seen by comparing Fig. 639 with Fig. 638. The unusual course was probably due to the combined influence of (1) the anticyclone central over New York, which tended to keep the tropical cyclone from advancing in that direction, and (2) the cyclone of the northwest, which favored the movement of the storm in that direction (Fig. 640). Fig. 639

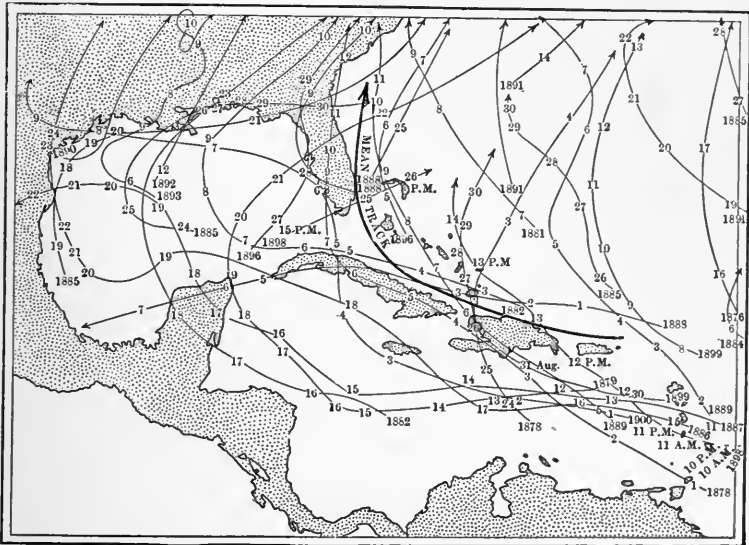

Fig. 638.—Course of West Indian storms for August, September, and October, 1878-1900. The lighter lines show the tracks of individual storms, the heavy lines the mean course. (U. S. Weather Bureau.)

shows that the rate of progress of the storm was very unequal. Thus northwest of Cuba its progress was much slower than it had been to the southeast. Just south of Florida it traveled only one-fourth as far in twelve hours as it traveled in one hour southeast of Cuba. Figs. 640-643 show the position and strength of the storm at four stages of its progress.

Tropical cyclones do not occur in the South Atlantic, and their point of origin is several degrees north of the equator, usually between  $10^{\circ}$  and  $20^{\circ}$ , in the North Atlantic. In the Pacific they occur on both sides of the equator. They come in the later part of the hot season of the latitudes where they occur, and are thought to be

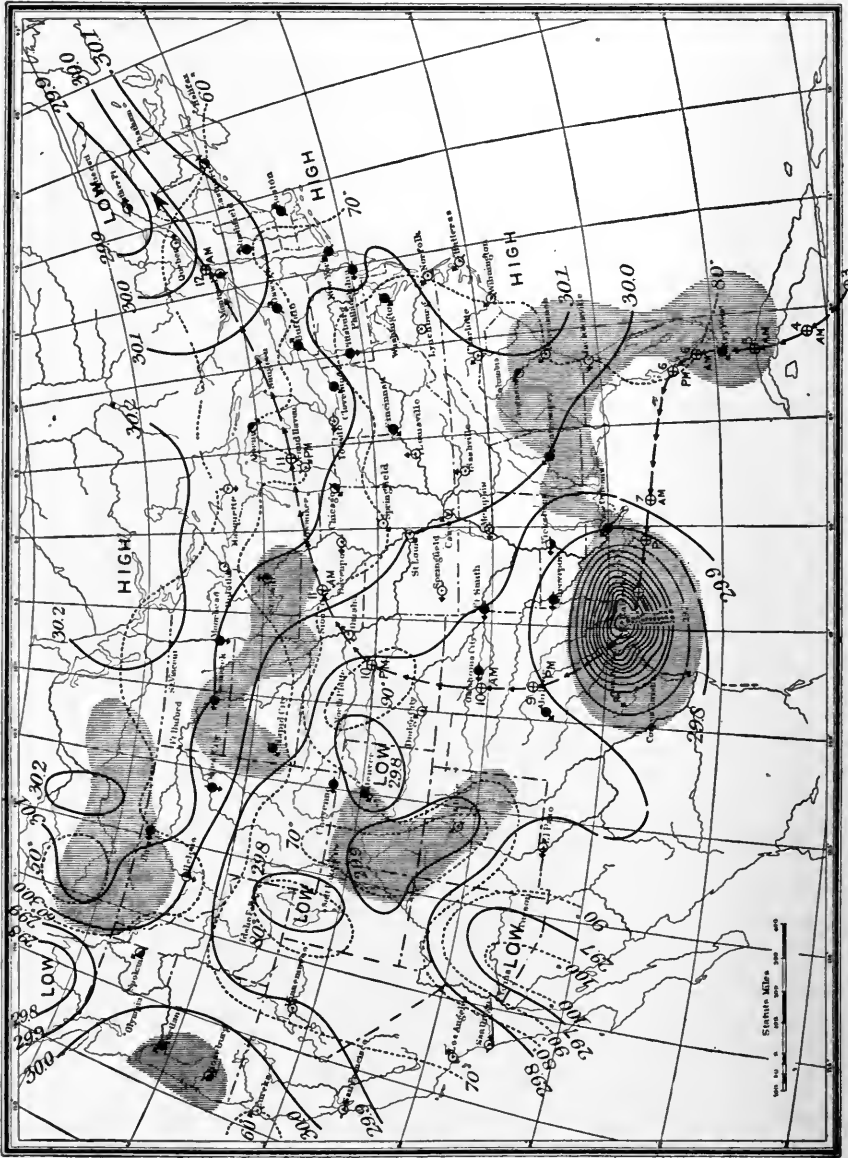

Fig. 639.—The Galveston storm of September 8, 1900. (U. S. Weather Bureau.)

caused by strong convection currents. Their apparently anomalous courses are probably to be explained by the courses of the prevailing winds. The lower part of the cyclone is in the horizon of the trades, but the upper part of the great eddy is probably above the trade-wind horizon and under the influence of northerly currents. The effect of these two controls appears to be to carry the storm somewhat to the north of west (in the northern hemisphere) until it escapes the control of the trades altogether, after which it is influ-

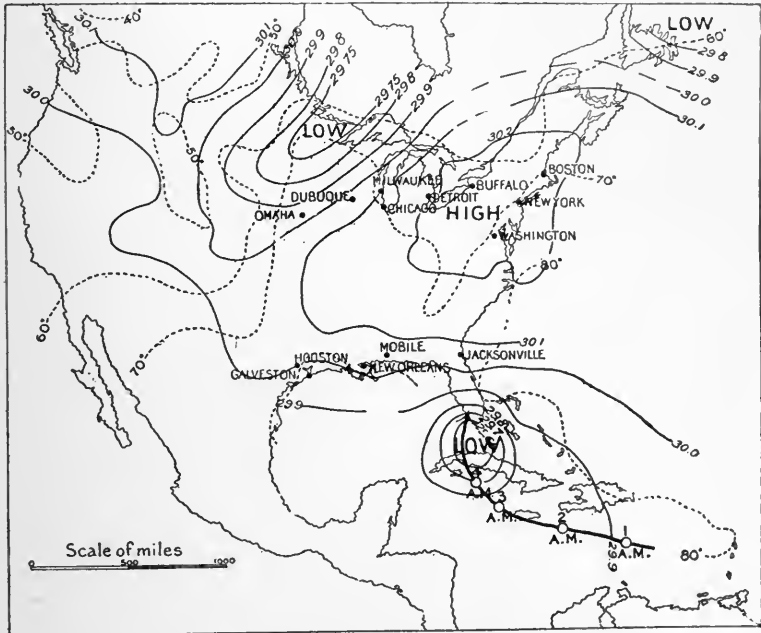

FIG. 640.—An early stage of the Galveston storm when it was central over western Cuba. (Nat. Geog. Mag.)

enced primarily by the southwest winds. The course of the storm after it escapes the trades, following a more northerly course than the prevailing winds, is probably influenced by the temperature of land and sea.

Storms similar to the West Indian hurricanes occur in the North Pacific, originating in the vicinity of the Philippines, and sweeping the coast of China. These storms are called *typhoons*. The courses of typhoons are shown in Fig. 644. The Society Islands and the low coral islands of the neighboring Low Archipelago were swept

by a destructive storm of this sort on February 7 and 8, 1906. The Hongkong typhoon of Sept. 18, 1906, was estimated to have destroyed 5000 lives, and property to the value of \$20,000,000.

**Weather predictions.** Weather predictions are based on the phenomena illustrated by the weather maps. Take, for example, the map of the 25th of September, 1903 (Fig. 615). Rain accompanies the cyclone which is central over Dakota. Since this storm

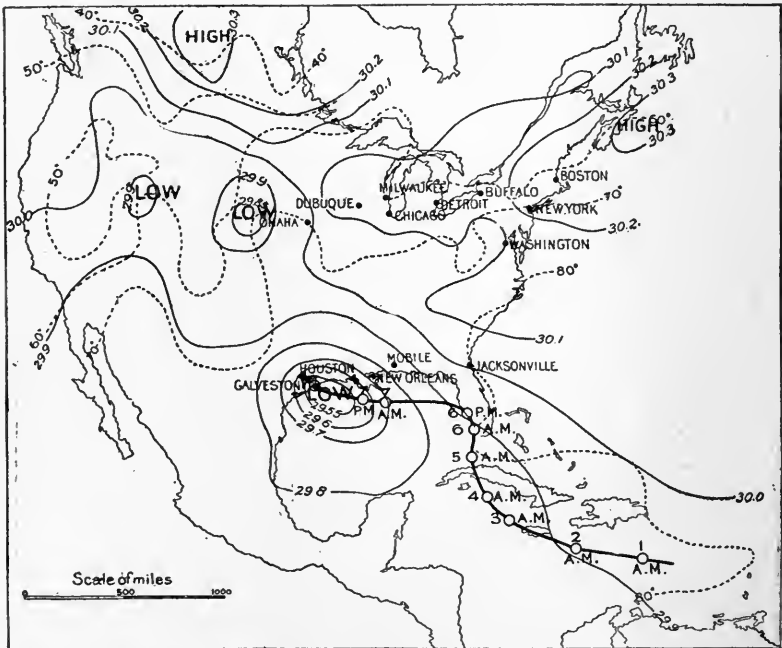

FIG. 641.—A later stage of the storm after its center had reached Galveston. (Nat. Geog. Mag.)

has, for the last twenty-four hours, been moving a little south of east at the rate of about 40 miles an hour, it is fair to presume that it will move in this same general direction at a similar rate for the next twenty-four hours. If, in this time, it advances to the Lake Superior region, it will probably bring with it weather similar to that which it is now giving to the region where it occurs. Hence on the 25th, the day when the weather conditions are shown in Fig. 615, the prediction might be made that rainfall is to be expected in about twenty-four hours in the region about the head of Lake Superior.

The map of the 26th (Fig. 616) shows that the course of the storm has changed a little, being slightly to the north of east, the common path of cyclones. That is, after descending a little to the south of east from British Columbia, cyclones are likely to turn to the east, or even a little to the north of east, in the middle longitudes of the United States (Fig. 629). On the 26th the prediction might be made that the low which is central north of Lake Superior (Fig. 616)

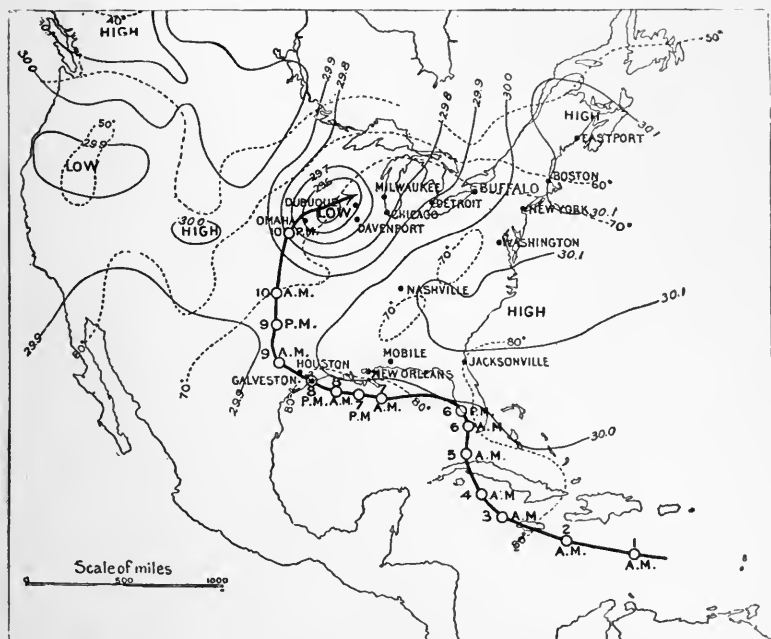

FIG. 642.—The same storm after it had become central about Dubuque, and much weaker. (Nat. Geog. Mag.)

will move on to the Gulf of St. Lawrence by the succeeding day, and that rain will accompany it. Rain for the region about Lake Huron and the area east of it may, therefore, be predicted. The map for the 27th (Fig. 617) shows that the area of precipitation extends far to the south. The preceding map had shown some cloudiness in this region, but had afforded no warrant for the prediction of such an area of cloudiness. Thunder-storms are shown in the southern part of the area of cloudiness.

Temperature changes as well as changes in precipitation may be predicted. Thus in Fig. 614 the isotherm of  $40^{\circ}$  bends south-

ward notably in the high central over Iowa. As the high moves east, it will probably carry the low temperature with it. Hence it is safe to predict that the temperature will fall in the area into which the anticyclone is to move. The map of the succeeding day (Fig. 615) shows that the temperature of western Virginia has fallen from about  $60^{\circ}$  to about  $40^{\circ}$  along the path of the high, while areas much farther north are warmer.

The same map (Fig. 615) shows that North Dakota and Alberta have a temperature of  $50^{\circ}$ , that is, a temperature  $10^{\circ}$  warmer than

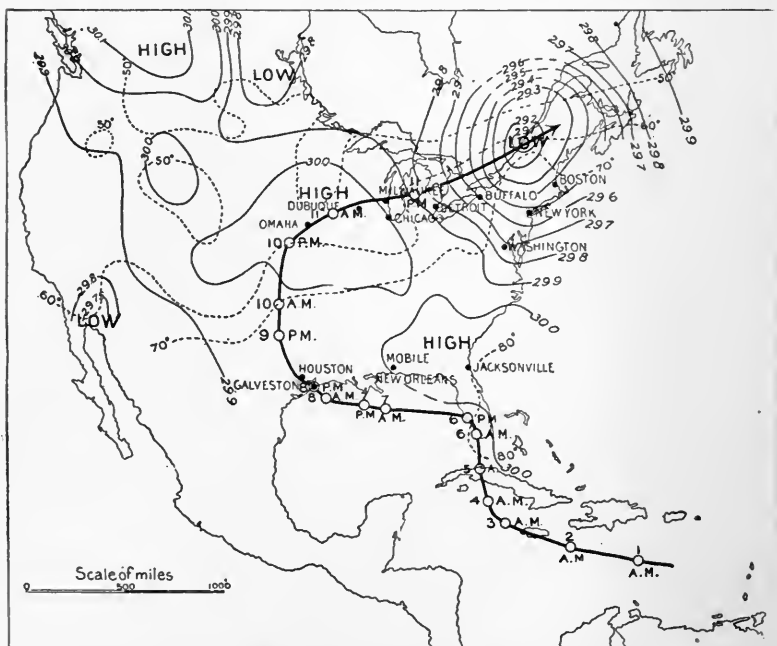

FIG. 643.—A still later stage after the center of the storm had reached New England. (Nat. Geog. Mag.)

that of western Virginia. It will be noted, too, that the relatively high temperature of Dakota, Montana, and Alberta goes with a low. As the low moves eastward, the presumption is that the temperature along its path will become somewhat higher. This is shown by the succeeding map (Fig. 616), which shows a temperature of about  $50^{\circ}$  north of Lake Superior. The same map shows how the isotherm of  $40^{\circ}$  bends to the southward in front of the high which is central over western Montana. On this day Winnipeg has about the same temper-

ature as Cheyenne, several hundred miles farther south. As the high of Montana moves eastward, it will be likely to carry cold temperature with it. From this map, therefore, it may be predicted that the temperature in Nebraska, Kansas, Iowa, and Missouri will fall. The next map (Fig. 617) shows that the temperature at Omaha has fallen from  $50^{\circ}$  to  $40^{\circ}$ , while that of eastern Kansas has fallen from  $70^{\circ}$  to  $40^{\circ}$ .

The time at which the precipitation which a given storm may bring to any given place will fall is calculated from the rate at which

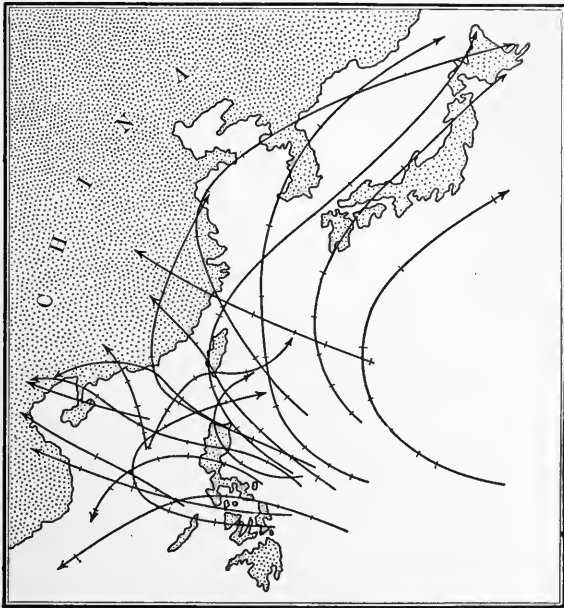

FIG. 644.—Typhoon tracks. (After Herbertson.)

the storm is progressing. Similarly, the time of arrival of a cold wave which an anticyclone is likely to bring is predicted on the basis of the rate of progress which the anticyclone is making. These rates are known in advance by telegraphic reports. Predictions concerning the weather may be made more readily for the central and eastern parts of the United States than for the western part, for the storms have been under observation longer before they reach the central and eastern parts.

Predictions may also be made as to the strength and direction

of wind. The principles involved will be readily understood, and the data on which the predictions are based are received by forecasters the same as data concerning temperature and rainfall.

**Failure of weather predictions.** Weather predictions often fail. The reasons are many. Among them may be mentioned the following:

1. The cyclones and anticyclones sometimes depart widely from the courses they are expected to take. They may veer so widely from their normal courses as to avoid altogether the places they were predicted to reach. Thus a storm may be in line for St. Paul, to which it is expected to bring rain and a rising temperature; but instead of keeping its normal course, it may turn off to the northward, and the rain which was predicted for St. Paul falls farther north.

2. Storms often change their rate of advance, so that they arrive earlier or later than predicted. Thus, if a storm which has been advancing at the rate of 600 miles in a day suddenly stops or advances but little, it does not bring the changes predicted to the areas into which it was expected to advance.

3. A third cause of the failure of predictions is found in the fact that storms sometimes appear and disappear without warning. Fig. 616 shows a low of which there had been no indication on the 25th, central over Oklahoma and Indian Territory; Fig. 617 shows that this low has disappeared. It occasionally happens that much more pronounced storms, promising great changes of weather, disappear. In such cases the predicted weather does not arrive, and the failure is charged to the forecaster.

4. Predictions are sometimes based on insufficient data. It will be noticed that on some weather maps the letter *M* appears in various circles. This means that reports from the station where the *M* appears are missing. If many reports are missing, the map is correspondingly imperfect, but the forecaster must use such data as he has, as well as he may, and issue a map.

5. Storms sometimes change their characters. Thus from the map of January 20, 1895 (Fig. 645), it could not be foreseen that the cyclone central in Colorado would develop the pronounced characteristics which appear on the map of the following day (Fig. 646).

6. In some situations storms are subject to many freaks. This is the case, for example, at Chicago. The frequently erratic behavior of storms here is probably due to the influence of the lake,



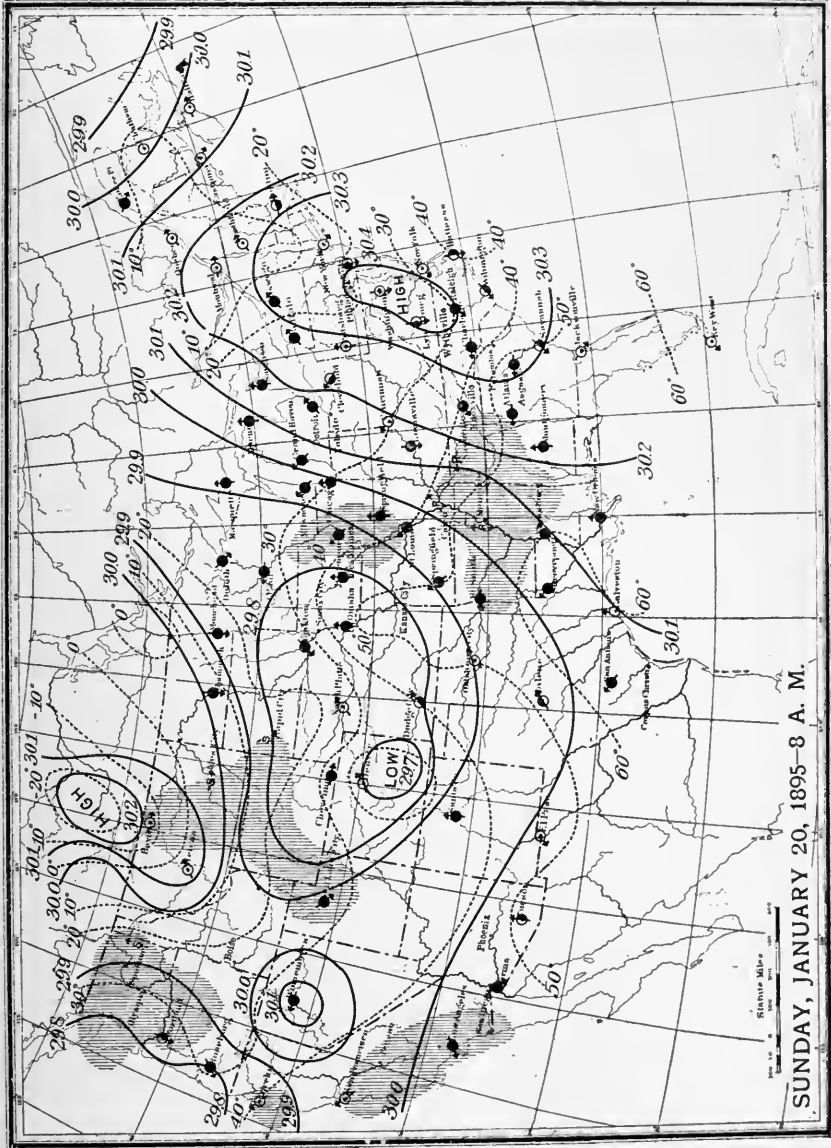

FIG. 645. (U. S. Weather Bureau.)

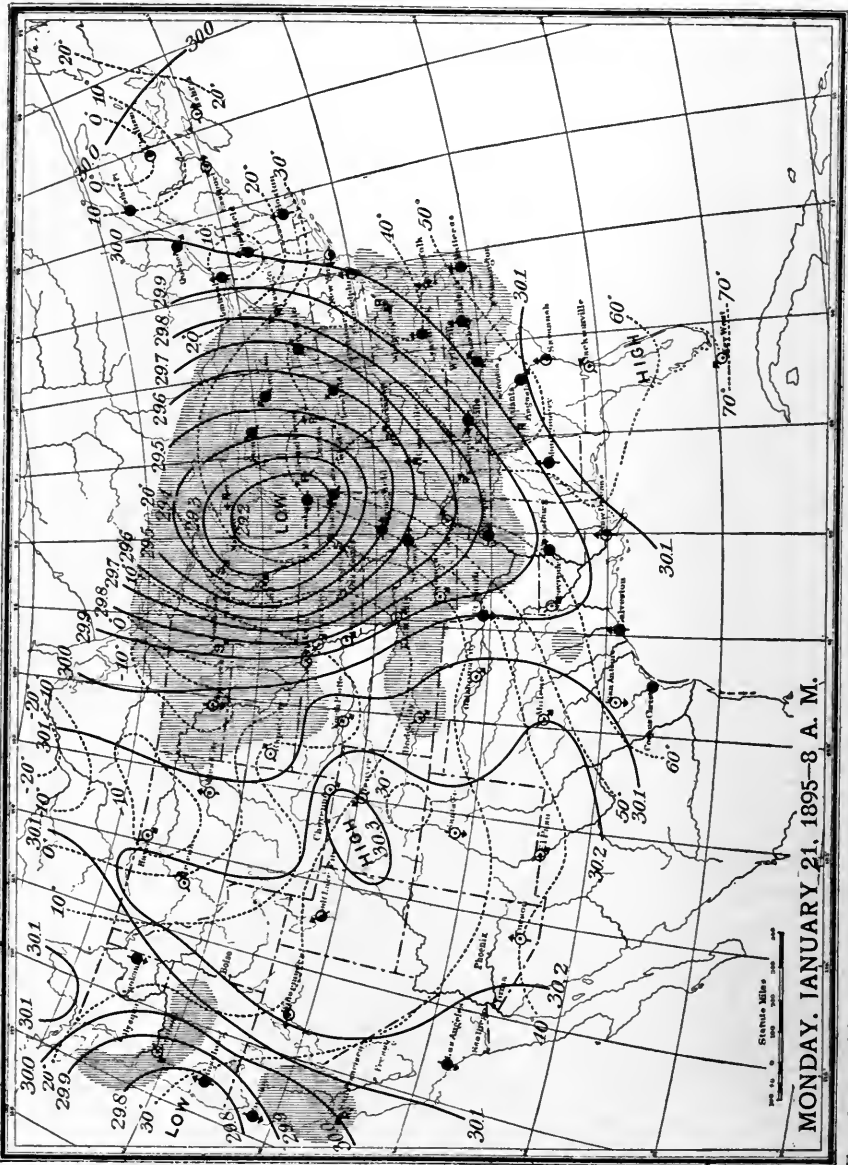

FIG. 646.—This map shows the storm of the preceding day greatly changed in character. (U. S. Weather Bureau.)

which modifies temperature and air currents. No other of our Great Lakes has so great extension in a north-south direction, and no other therefore presents so broad a front to the prevailing winds.

Forecasters, like other men, are fallible, but when they have to work with so many indeterminate elements, it is not strange that they sometimes make mistakes, and one mistake is likely to be remembered longer than many correct prognostications.

**Property saved by predictions of storms, frosts, floods, etc.** In spite of all shortcomings, the warnings of storms, floods, cold waves, etc., sent out by the Weather Bureau, have resulted in great benefit to various interests. The value of this service of the Weather Bureau is not always duly appreciated, and much less is heard of it than would have been heard of the losses which would have been incurred in the absence of the warnings. Unfortunately, it is not always possible to devise protection against the evils of which the Weather Bureau gives warnings.

It has been estimated that property valued at \$15,000,000 was saved in 1897 by warnings of impending floods. While this was exceptional, considerable sums are saved each year in this way. In 1903-4 the estimated value of the saving was \$1,000,000.

Shipping interests are served by storm warnings. Thus, in September, 1903, vessels valued at \$585,000 were temporarily held in ports along the coast of Florida by storm warnings.

Agricultural interests are also served by warnings of storms and of "cold waves," and especially of frosts. Warnings led to the protection of \$1,000,000 worth of fruit about Jacksonville, Fla., in 1901, with an estimated saving of half this amount. Other warnings of cold in 1901 are estimated to have been the means of saving \$3,400,000 worth of property. Fruit- and truck-farming are the phases of agricultural work most effectively served in this way.

#### *Special Types of Storms*

**Thunder-storms.** Thunder-storms are of common occurrence in the United States. They are most common in warm regions—that is, either in low latitudes, or in the summer season of middle latitudes. Not only this, but they are most common on days which are unusually warm, and during the warmer parts of these days. They are, however, not confined to the summer or to the warm part of the day, for there are occasional thunder-storms in the winter

in middle latitudes, and even in high latitudes, and there are thunderstorms at night. Peary reports a thunder-storm in North Greenland in midwinter.

The first indication of a thunder-storm is usually a large cumulus cloud (Fig. 647) which, in the zone of the westerly winds, generally

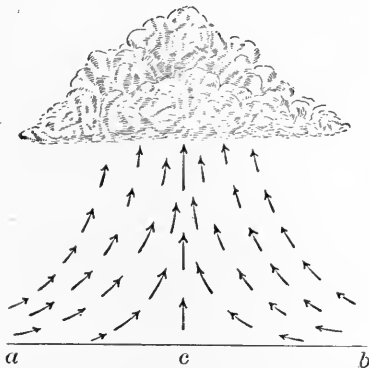

FIG. 647.—Ascending currents and cumulus clouds preparatory to thunder-storm. (After Ferrel.)

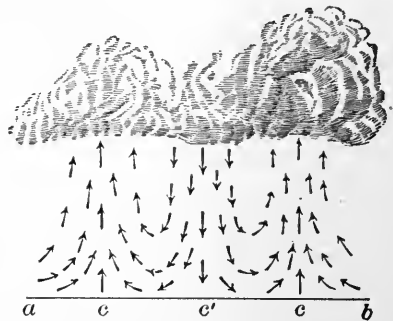

FIG. 648.—Air-Currents in thunder-storm. (After Ferrel.)

appears in the west. The cumulus cloud (or thunder-head) which yields the rain, like all cumulus clouds, is generated by an ascending current of moist air. It moves eastward, and seems to rise as it approaches the observer, but the rise is apparent only. As the cloud reaches the place of the observer, there is usually a sharp breeze, or "thunder-squall," rushing out before it. Shortly after the squall the rain begins to fall. The rainfall is often heavy and the drops large; but the downpour does not usually last more than an hour, and often much less. Sometimes, however, a second thunder-storm follows close upon the first (Fig. 648), thus prolonging the period of rainfall. When a thunder-storm has moved on to the east, the air is usually cooler and fresher, and the barometer distinctly higher.

As water vapor condenses in the air, the water particles become charged with electricity. The charge of the individual droplets increases as they increase in size, and the lightning is due to the discharge of the electricity from one part of a cloud to another, or from one cloud to another cloud, or from cloud to ground. Rain and snow bring down much electricity to the land and water.

The flash of lightning is followed by thunder, the noise being due to the vibrations in the air resulting from the disturbance caused by the electrical discharge. The thunder has been compared to the noise which follows any other violent disturbance in the air, such as the explosion of a rocket or the cracking of a whip (Davis). Rolling thunder may follow a prolonged flash of lightning, or it may be due to a succession of flashes but slightly separated from one another, or sometimes to the echoing of the thunder from hills and mountains.

In temperate latitudes the thunder-storms usually occur during the passage of cyclones, though they do not accompany all cyclones. They are more common on the south sides of cyclones than elsewhere, and they often occur at a considerable distance from the centre of the storm. In middle latitudes, thunder-storms, like cyclones, move in a general way from west to east; while in the zone of trade-winds they move from east to west. In both cases they move with the prevailing winds.

The forward movement of a thunder-storm is commonly 20 to 50 miles an hour. They often spread, and become weaker as they move forward (Fig. 649), and do not usually run long courses before

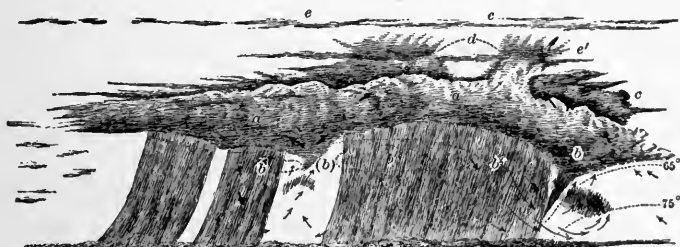

FIG. 649.—Vertical section of a thunder-storm which is moving toward the right. (After Köppen.)

disappearing. The period of a thunder-storm is usually much shorter than that of the cyclone which it accompanies.

It sometimes happens that lightning at a great distance illuminates the clouds over a region where the lightning itself cannot be seen. Where the clouds seen from a given point are thus illuminated by lightning which is itself invisible, the lightning of the clouds is called *heat lightning*. The heat lightning is simply a reflection of lightning. It is more likely to occur in hot weather

than at other times, because lightning is more common at such times.

Rainbows sometimes accompany or follow thunder-storms. They are always seen opposite the sun, and hence are seen in the

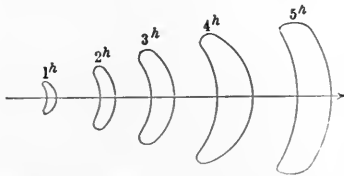

FIG. 650.—Shape of thunder-storm in ground-plan, illustrating growth and change as it progresses. (After Waldo.)

west in the morning, and in the east in the afternoon or evening. They are usually seen just after the passage of a thunder-storm, while a little rain is still falling, but after the sun has appeared. They are seen on looking in the direction opposite the sun; that is they are in the east in the evening, and in the west in the morn-

ing. The rainbow is due to the effects of the drops of water in the atmosphere on the sun's rays. A bow is also seen through water spray, such as that at a great fall, even when no rain is falling.

**Whirlwinds.** Distinct ascending whirls of air are often seen on hot days. They are especially well seen in dusty regions, for

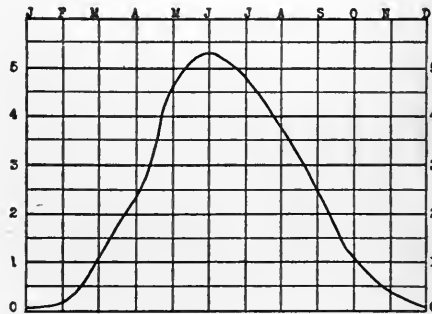

FIG. 651.—Graph showing the relative frequency of thunder-storms in Chicago in different months. (Cox, U. S. Weather Bureau.)

there the dust is swept up,\* making the whirl distinctly visible. They are often seen in dusty roads, plowed fields, etc., but are seen at their best in deserts. From a given point in the Mojave Desert of California, as many as eight or ten of these whirls, some of them rather conspicuous and imposing, may sometimes be seen at one time from a single point on a hot summer day. The whirl-

winds are probably caused by the excessive heating of the air at some point, and this excessive heating gives rise to a sharp convection current. It moves on for a time with the prevailing wind, but soon plays out.

In humid regions the whirlwinds do not usually appear to extend up to any considerable height, but in desert regions they often reach heights of 1000 feet or more, as shown by the whirling columns of dust. The rise is sometimes so great that the air is expanded and cooled enough to cause condensation of even the small amount of moisture contained in the desert air. Sharp showers may then occur. Showers of this sort are likely to be of short duration, but the rainfall is sometimes very heavy. If exceptionally heavy, such rains are known as *cloudbursts*. In such a storm in the summer of 1898, rain enough fell in a few minutes, in the vicinity of Bagdad, in the Mojave Desert of California, to occasion serious washouts along the railroad for several miles. A cloudburst at Clifton, S. C., June 6, 1903, caused the loss of more than fifty lives, and property damage to the estimated extent of \$3,500,000.

**Tornadoes.** When a convection current is very strong, but has very small diameter, the whirl sometimes becomes so intense as to cause great destruction. A whirling storm of this sort is known as a *tornado*. Tornadoes, like thunder-storms and whirlwinds, are phenomena of hot weather. They occur in the United States in the warm season, appearing earlier in the South and later in the North.

The tornado may be looked upon as a concentrated cyclone or an intensified whirlwind. The pressure in the center of the tornado is usually much lower than in the center of a cyclone. In a strong tornado the pressure at the center may be a fourth less than that of its surroundings. Herein lies the explanation of one phase of the destructive action of a tornado. During the passage of a tornado the pressure may be reduced from the normal amount, 14.7 lbs. per square inch, or 2117 lbs. per square foot, to three-fourths of this, or to 11 lbs. per square inch or 1584 lbs. per square foot. If such a tornado passes over a closed building in which the air pressure is normal (2117 lbs. per square foot), the pressure on the outside becomes 1584 lbs. The walls are therefore pushed out with a force of 533 lbs. per square foot, and unless they are very strong, they will collapse outward, as if the building had ex-

ploded. Often it is only the weakest part, such as a window, which yields.

Not only is the pressure at the center low, but the area of low pressure is very small. While a cyclone may be 1000 miles or more across, a tornado may be no more than one-eighth of a mile across, or even less. The result is that the pressure gradient in a tornado is very much higher than in a cyclone, and the winds are violent. Their velocities, estimated by the size and weight of the objects moved, have been thought to reach 400 or 500 miles per hour. With this velocity, or even a velocity which is much less, the destruction is great. Trees are overturned, buildings unroofed or even blown down, and bridges hurled from their foundations.

A tornado is often heralded by a funnel-shaped cloud (Fig. 652), the point of which may be far above the ground. As the funnel moves forward, its lower end may rise or fall. The tornado



FIG. 652.—Funnel-shaped cloud of a tornado. Solomon, Kan.  
(U. S. Weather Bureau.)

becomes especially destructive where the funnel sinks so as to approach or touch the ground. The cloud is due primarily to the condensation of the moisture in the sharp convection current, and the funnel shape is due to the expanding and spreading of the air as it rises.

The tornado is, of all storms, the most destructive, but it usu-



ally has a very narrow track, and does not commonly work destruction for a very great distance. After a short course it generally plays out, or rises so high as to cease to be destructive.

One of the most destructive, though not one of the most violent, tornadoes of recent times was that at St. Louis, May 27, 1896. It was an incident of a thunder-storm in the southeastern part of a cyclonic area central some distance northwest of St. Louis.

The humidity at St. Louis was exceptionally high, about 94. At noon the barometer at St. Louis stood at 29.87, the temperature was 80° F., and the velocity of the wind 12 miles per hour. By 1.45 the temperature had risen to 86°. At 2 o'clock the barom-

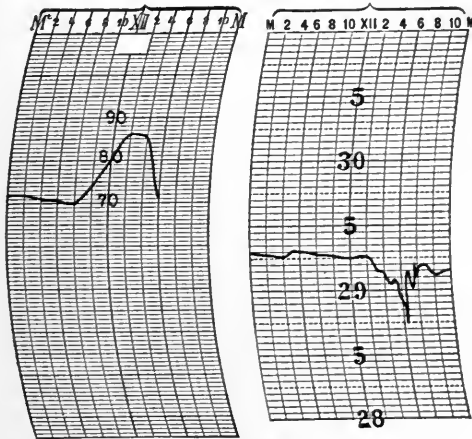

FIG. 653.—Thermograph (at left) and barograph (at right); traces at St. Louis during the tornado of May 27, 1896. (U. S. Weather Bureau.)

eter began to fall rapidly, and by 6 P.M. it had dropped to 29.59. Meanwhile the wind had become shifting, and shortly before 6 o'clock had attained a velocity of 45 miles per hour, and by 6 o'clock the temperature had fallen to 77°.

During the earlier part of the afternoon, cumulus clouds had been abundant, but by 4.30 they had settled into a stratus cloud. Soon after 5.00, thunder and lightning occurred, and rain began to fall at 5.43.

At 6.04 there was a marked increase in the violence of the wind, which shifted its direction rapidly. The barometer rose to 29.67, but fell almost instantly to 29.57, then rose to 29.67 in less

than five minutes, falling again .31 inch to 29.36 in fifteen minutes, and then rose almost instantly to 29.76. Sharp oscillations of barometric pressure occurred until 10 P.M. The wind probably attained a maximum velocity of 120 miles per hour at 6.18, with numerous and rapid changes in velocity and direction. The rainfall accompanying the storm was extremely severe, more than 2½ inches falling. The electrical display was brilliant.

The destruction began at about 6.10 P.M. and lasted for several minutes. The forward motion of the storm was at the rate of about 36 miles per hour. The width of the belt of destruction was about 1¼ miles where it entered the city, but it was constricted to less than a mile farther on.

One of the extraordinary features of the storm was the fact that its base was about 30 feet above the surface. Trees were

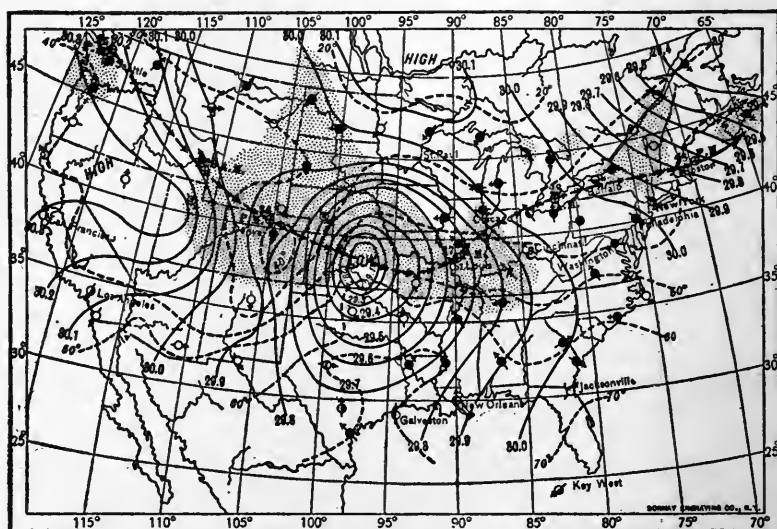

FIG. 654.—Weather map for the morning of the day (March 27, 1890) of the Louisville tornado. (U. S. Weather Bureau.)

twisted off at this level, and the principal destruction of houses was above the first floor. Evidences of great heat were visible after the storm, as shown in scarred branches and twigs, a phenomenon which has been noted in some other tornadoes.

As in other tornadoes, the wind played many curious freaks. Single stones and bricks were picked out of walls, while the walls

remained standing. In one case a span of horses attached to a loaded wagon were taken away, though the wagon was not overturned. The most extraordinary recorded instance of violence was in East St. Louis, where, at the approach to the bridge, a plank 2"×8" "was driven into . . . a steel girder with such velocity that it punched a hole in the webbing and remained sticking in the

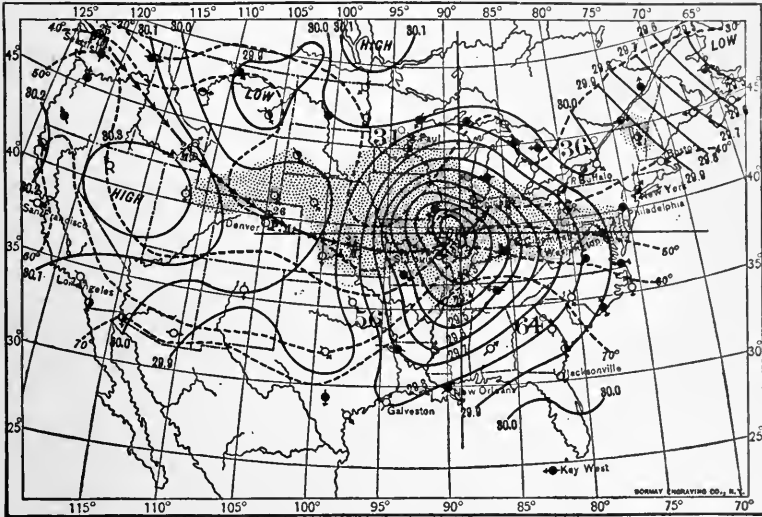

FIG. 655.—Weather map for the evening of March 27, 1890, at the time of the Louisville tornado. (U. S. Weather Bureau.)

girder." The destruction of property in and about St. Louis was estimated at about \$13,000,000.

The interpretation put upon the storm was that "tornadic action was developed successively at different points in the track of the general storm," which was a thunder-storm belonging to the class of thunder-storms "which move broadside in a southeasterly direction."

A more violent tornado was that at Louisville on the 27th of March, 1890, just before nine o'clock in the evening. Its rate of advance was nearly 40 miles per hour, but its diameter was so slight, about 300 yards, that it took but about three-fourths of a minute for the storm to pass a point. It was accompanied by "a most terrific electric display." Many weak buildings were wrecked, the walls falling toward the center of the storm. Sev-

enty-six persons were killed and about 200 injured in Louisville alone, and the loss of property was estimated at about \$2,500,000.

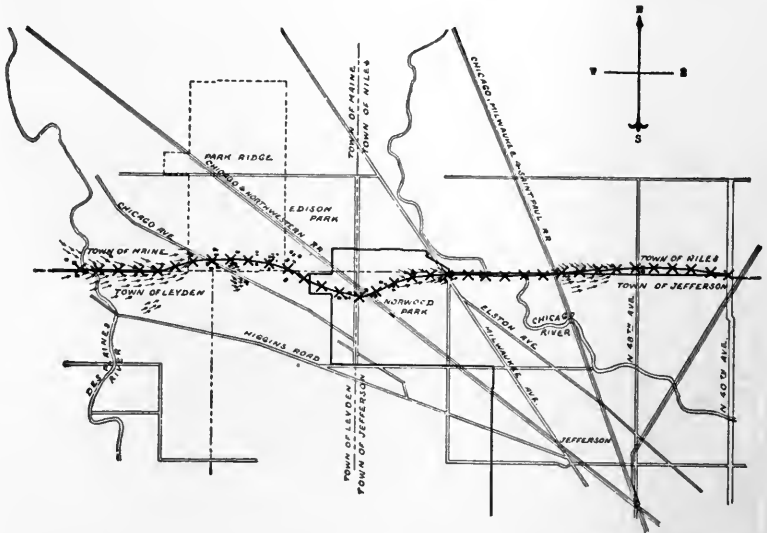

FIG. 656.—Track of tornado in the outskirts of Chicago, May 25, 1896. (Cox, U. S. Weather Bureau.)



FIG. 657.—General view of the wreckage caused by the tornado at Rochester, Minnesota, August 21, 1883.

The path of the storm was traced for 75 miles, and throughout this distance its width was nearly uniform. At least five tornadoes occurred in Kentucky the same night.

Fig. 656 shows the track of a tornado in the suburbs of Chicago on May 25, 1896.

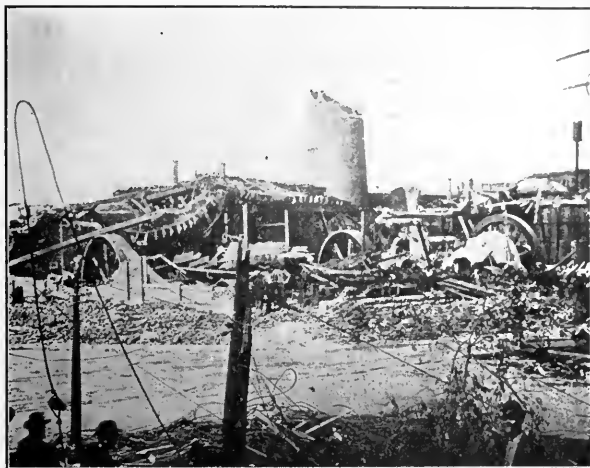

FIG. 658.—Wreckage of the Union Station Power-house at St. Louis, May 27, 1896. (U. S. Weather Bureau.)



FIG. 659.—Trees twisted off by tornadic winds. (U. S. Weather Bureau.)



FIG. 660.—Straws driven into dry wood by tornadic winds. (U. S. Weather Bureau.)

**Waterspouts.** Waterspouts are virtually tornadoes at sea. When the base of the upward spiral movement is as low down as the surface of the water, sea-water may be drawn up to some slight

extent by the ascending current. The lesser atmospheric pressure in the centre of the whirl will occasion the rise of the water to some extent at that point, and the upward current of air may catch it and carry it upward. The larger part of the water in a waterspout is, however, due to the condensation of the water vapor in the air, and not to the uplift of water from the sea.

**Foehn winds, Chinook winds, etc.** When warm, moist air is forced up over mountains, it precipitates some of its moisture. The precipitation sets free heat, so that the air is cooled much less than it would be otherwise. Beyond the crest of the mountains it de-

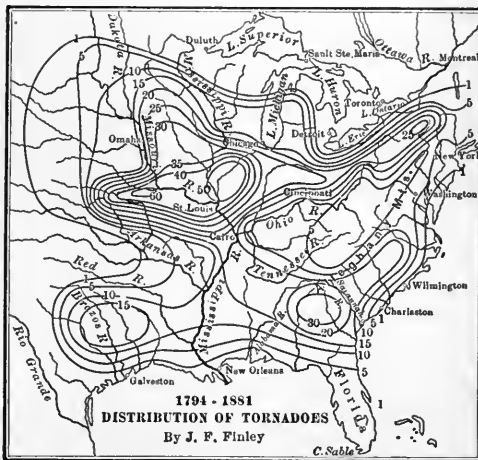

FIG. 661.—Distribution of tornadoes in the United States, 1794–1881.

scends, and is warmed in the process. It is warmed much more (often twice as much) in the descent than it was cooled in the ascent, because moisture is not condensed during the descent (p. 572). It may therefore descend as a hot wind. Such winds are known as *Foehn* winds in Switzerland and as *Chinook* winds in the United States, especially just east of the Rockies.

These winds may be beneficial or harmful. Thus the Chinook winds temper the rigorous winters of certain parts of the Northwestern States and the Canadian provinces east of the mountains. They frequently evaporate a foot or more of snow in a very few hours. Such winds are sometimes called *snow-eaters*. These winds make winter grazing possible over large areas. In Alberta

the Chinook has been declared to be "the grand characteristic of the climate as a whole, that on which the weather hinges." These winds sometimes develop with great suddenness. At Fort Assiniboine, Montana, on January 19, 1892, the temperature rose  $43^{\circ}$  F., from  $-5.5^{\circ}$  to  $37.5^{\circ}$ , in fifteen minutes, under the influence of the Chinook wind. In other cases the temperature has been known to rise  $80^{\circ}$  F. in six or eight hours. The Chinook winds of summer are sometimes so hot and drying as to wither vegetation, and sometimes to destroy crops completely.

## CHAPTER XIX

### CLIMATE

In the preceding discussions of temperature, rainfall, winds, and weather, much has been said or implied concerning climate. The principal points involved may be here summarized and applied to the principal zones of the earth.

**Definition.** Climate is the average succession of weather conditions for a considerable period of time. The summer climate of a place is shown by the weather of many summers, not by the weather of one. So with the climate of autumn or winter or spring. The average weather conditions for 10 years would give some approximation to the true climate, those for 25 years would give a closer approximation, and those for 50 or 100 years would be still better. The distinction between climate and weather is correctly recognized by such expressions as these: The winter climate of Chicago is cold and windy, but the winter weather of Chicago in 1905-6 was mild.

Climate is otherwise defined as "the sum total of meteorological conditions in so far as they affect animal or vegetable life." According to this conception of climate, those meteorological elements which have most influence on life are most important in climate (Hann).

The principal elements of climate are (1) temperature and (2) humidity, which includes (a) relative humidity (p. 570), (b) absolute humidity, (c) degree of cloudiness, and (d) precipitation. A climate may be described as *warm* or *cold*, *dry* or *moist*. In common speech, other elements of climate are often neglected, but there are others of importance, especially (3) wind.

Of these elements, temperature is, on the whole, the most important, but from some points of view, relative humidity and precipitation are hardly less important.

In characterizing the climate of a region, account is taken not only of the average temperature of the year and of the several



seasons, but also of the temperature of exceptional seasons and of the extremes of temperature during the season. These extremes are considered not merely for their effects on averages, but also on their own account. *Sensible* temperature, as distinct from *absolute* temperature, is also to be taken into account. Moist air of a given degree of heat seems much warmer than dry air of the same temperature when the temperature is high, and much colder when the temperature is low. Sunstroke is much more common where the relative humidity is high than where it is low. Sunstrokes are rare, for example, in the arid West, even with temperatures considerably above those of Chicago or New York. Sudden changes of temperature are also less injurious where the relative humidity is low than where it is high. Air of a given temperature seems much cooler when in motion than when quiet.

Similarly, climate takes account not only of the average amount of yearly precipitation, but of the variations of precipitation from year to year and from season to season, of its average distribution throughout the year and of departures from this average, and of the proportions which fall as rain and snow respectively.

The other elements of climate are considered in the same way, their variations and extremes as well as averages being taken into account.

**Uniformity and variability.** If the range of temperature is small, the distribution of precipitation somewhat equal, and the winds reasonably constant in direction and strength, the climate is *uniform*. If, on the other hand, the variations of these climatic elements are great, either in a year or in successive years, the climate is *variable*. The climate of the middle and northern latitudes of the United States, for example, is variable, (1) because the annual range of temperature is great, (2) because the range varies from year to year, (3) because corresponding seasons have very different temperatures, (4) because changes of temperature may be very sudden, and (5) because the amount and distribution of rainfall vary notably and irregularly from year to year, and from season to season. It is the variability of the weather which makes weather predictions important, and *variable weather makes a variable climate*.

Figs. 662-670 represent certain elements of variability. Fig. 662 shows the annual range of temperature in eight places: Duluth, Chicago, Memphis, and New Orleans in the upper part; and Denver, Chicago, New York, and San Francisco in the lower part. It will be

seen that the range is greater in the higher latitudes. It is  $120^{\circ}$  at Duluth,  $108^{\circ}$  at Chicago,  $87^{\circ}$  at Memphis, and  $70^{\circ}$  at New Orleans. Denver, Chicago, and New York do not differ widely in annual range of temperature, but the range at San Francisco, where the prevailing wind is from the sea, is notably less. Though near

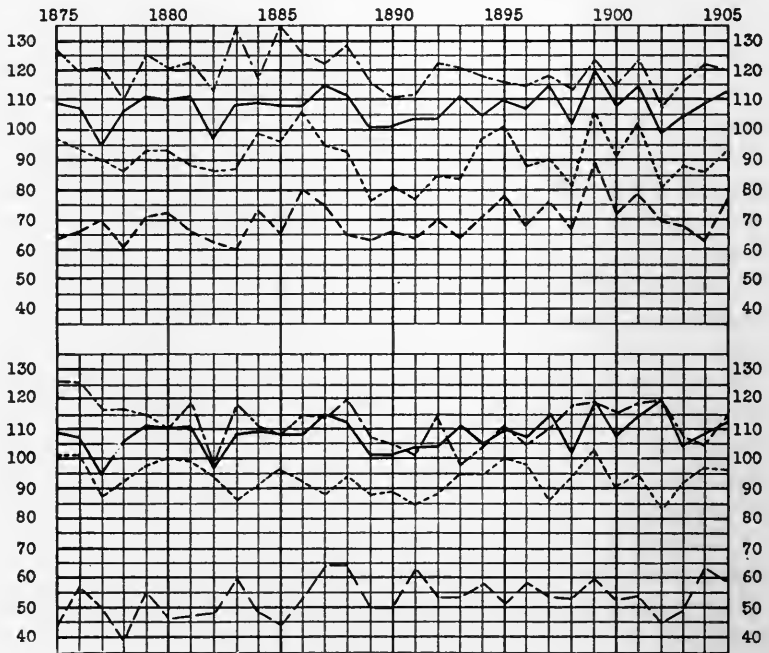

FIG. 662.—The upper part of the figure, reading from the top down, shows the annual range of temperature in degrees Fahrenheit at Duluth (average,  $120^{\circ}$ ), Chicago (average  $108^{\circ}$ ), Memphis (average  $87^{\circ}$ ), and New Orleans (average  $70^{\circ}$ ), four places in about the same longitude, but in different latitudes. The lower part of the figure, reading from the top down, shows the annual ranges of temperature in Denver (average  $113^{\circ}$ ), Chicago, New York (average  $94^{\circ}$ ), and San Francisco (average  $53^{\circ}$ ), four places in similar latitudes but in different positions with reference to the sea. (Cox, U. S. Weather Bureau.)

the sea, New York has a much greater range of temperature than San Francisco, because the prevailing winds are from the land.

Fig. 663 shows the average winter temperature by years for Chicago. It will be seen that the average temperature of some winters is  $7^{\circ}$  higher than that of other years. Fig. 664 shows the temperature of Chicago during two Januaries, when the weather was

abnormally warm. The average temperature for 1880 was  $40^{\circ}$ , and that for 1906,  $33^{\circ}$ . Fig. 665 shows that the average temperature for January at the same place is about  $23^{\circ}$ . It also shows the

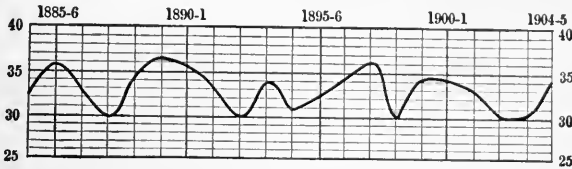

FIG. 663.—Average winter temperatures at Chicago in degrees Fahrenheit, 1885-1905. (Cox, U. S. Weather Bureau.)

mean monthly temperatures for several cities, the range being greater with increasing latitude, and with increasing distance from the sea in the direction whence the wind blows. Fig. 666 shows the

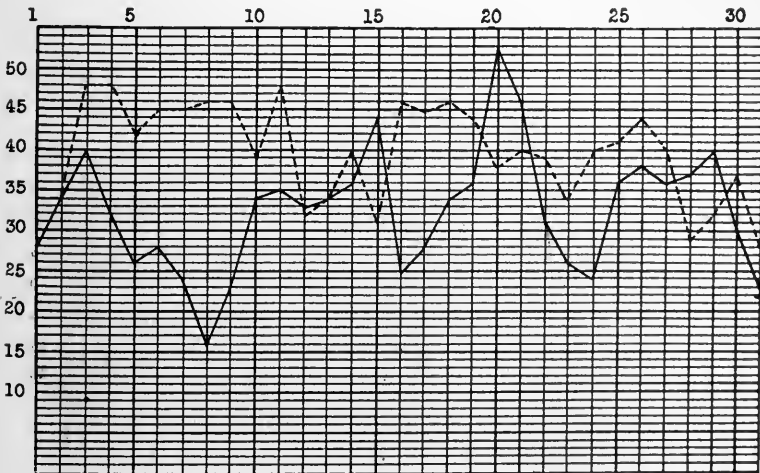

FIG. 664.—Mean daily temperatures during two warm Januaries at Chicago. The dotted line represents January, 1880, and the full line January, 1906. The numbers at the left are degrees Fahrenheit. The average temperature for the former month was  $40^{\circ}$  F., and for the latter  $33^{\circ}$ . The average temperature for January in Chicago is  $23^{\circ}$ . (Cox, U. S. Weather Bureau.)

variations in daily range which are sometimes possible in middle latitudes far from the sea. Fig. 667 shows the variation in snowfall in one locality for a period of twenty years, while Figs. 668 and

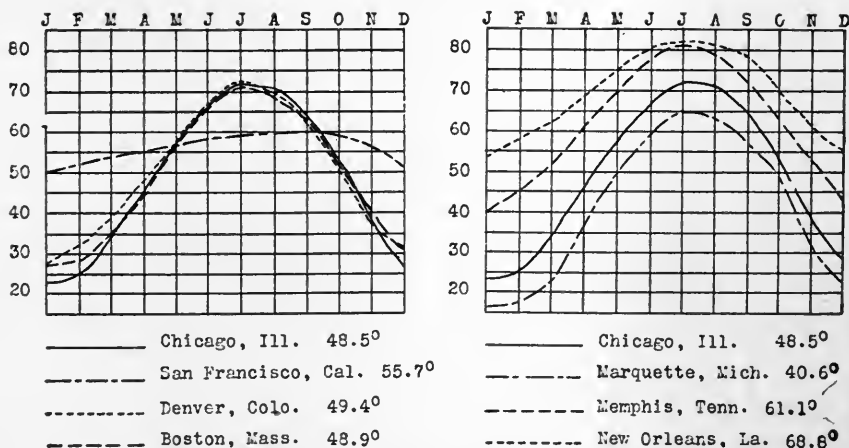

FIG. 665.—Mean monthly temperatures in degrees Fahrenheit at Chicago, San Francisco, Denver, and Boston, four places in similar latitudes; and for Chicago, Marquette, Memphis, and New Orleans, places in different latitudes in about the same longitude. Averages for the year are shown below the graphs. (Cox, U. S. Weather Bureau.)

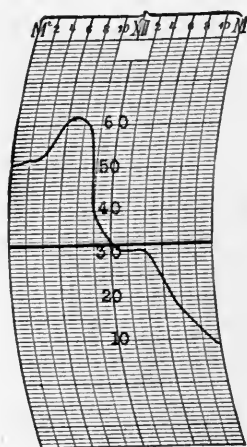

FIG. 666.

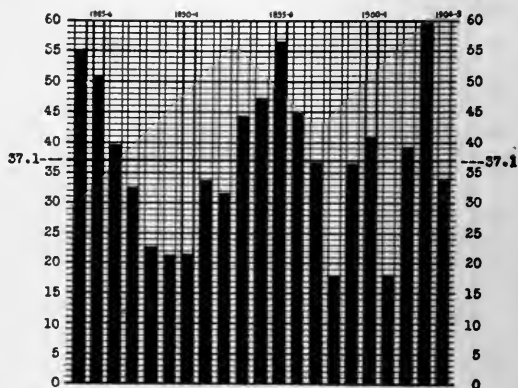

FIG. 667.

FIG. 666.—The range of temperature at Chicago for February 9, 1900, when the range was 53° F. (from 9° to 62°), and for March 24, 1891, when the temperature did not vary, being 32° throughout the day. The curves are illustrative of the great variation in daily range in "temperate" latitudes. (Cox, U. S. Weather Bureau.)

FIG. 667.—Total snowfall at Chicago, in inches, by winters, 1885-1905, showing the great variations. (Cox, U. S. Weather Bureau.)

669, and Figs. 670 and 671, show the great differences in the amount of snow at corresponding dates in successive years.

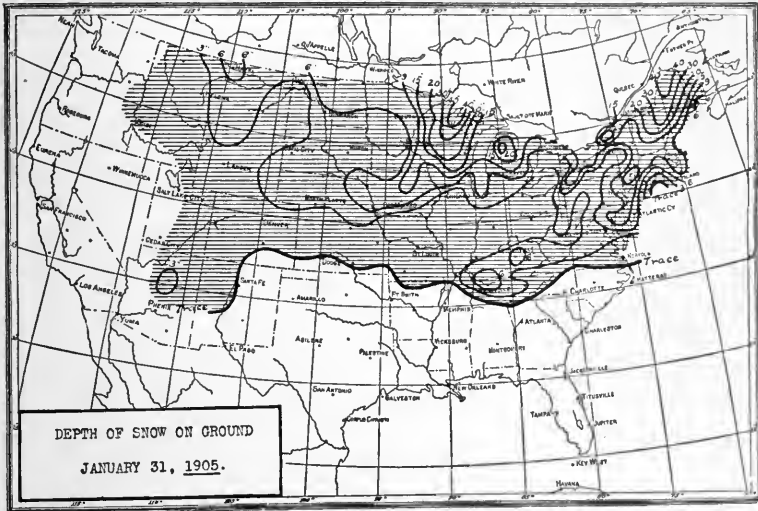

FIG. 668.—The numbers at the ends of the lines indicate the depth of snow in inches. (U. S. Weather Bureau.)

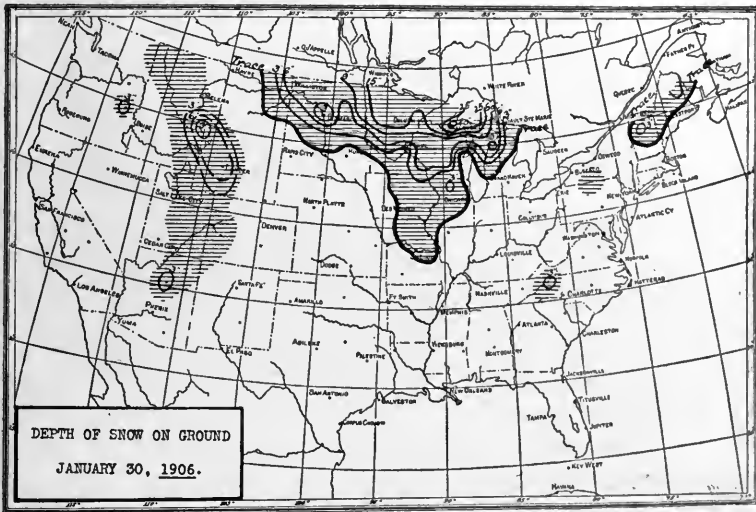

FIG. 669. (U. S. Weather Bureau.)

It will be seen that a variable climate varies in different ways. A climate which is regularly dry during one season of the year and

wet during another, is variable *within the year* with reference to precipitation, even though the range of temperature is not great; the

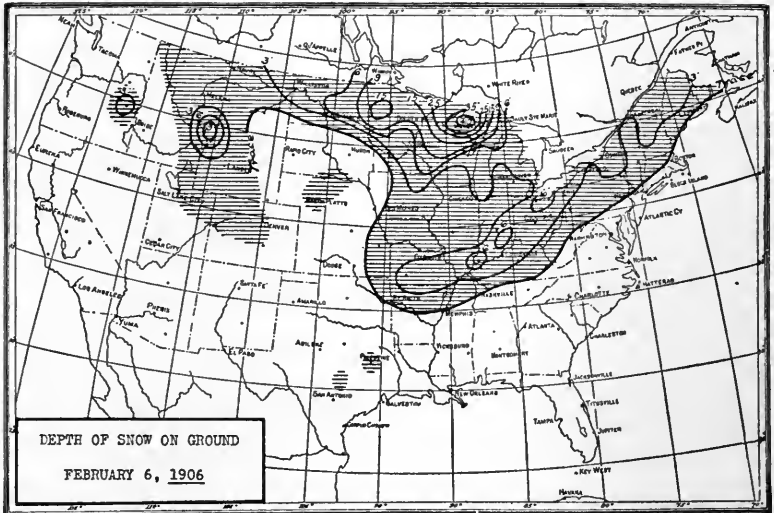

FIG. 670. (U. S. Weather Bureau.)

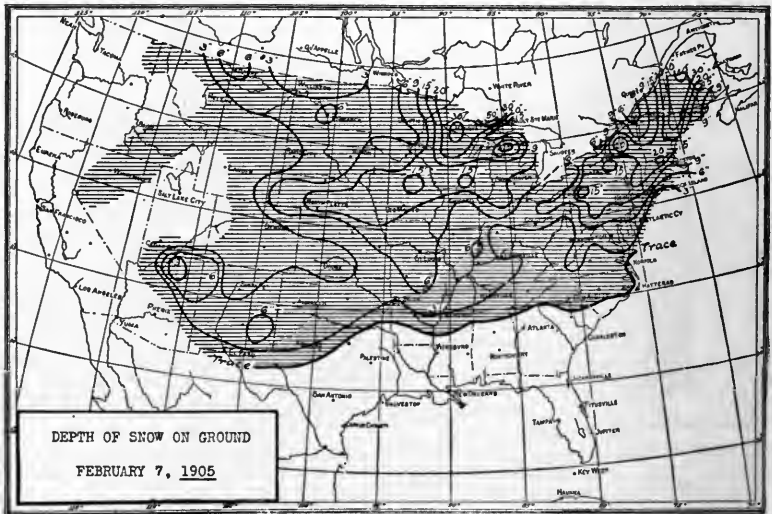

FIG. 671. (U. S. Weather Bureau.)

climate of such a region may, however, be very constant from year to year. Such a climate is found on the borders of the equatorial

calms, which shift a little north and south with the apparent shifting of the sun. A narrow belt on each border of the calm zone is therefore alternately in the calms and in the zone of the trades. At the former times it has plentiful rain, while at the latter it is generally dry.

A region which is hot at one time of the year and cold at another is variable *within the year* with respect to temperature. In such regions, too, one winter or summer may be much cooler or warmer than the next, giving a variation from year to year rather than from season to season. A climate which is variable with respect to temperature is not necessarily variable with respect to moisture. Commonly, however, variations in temperature and moisture go together.

In some regions the winds shift regularly from season to season, as where monsoons blow (Figs. 595 and 597), and again along the poleward borders of the trades. The climates of such places are variable *within the year* with respect to winds, and this makes them variable also with respect to some of the other elements of climate. Considered from year to year, the climates of such regions may be uniform.

These illustrations are sufficient to show that the meaning of "variable climate" is itself variable.

### *Classification of Climates*

As in the case of many other topics, climates may be classified in various ways, and each classification helps to emphasize some important point. One classification has already been suggested, namely, *uniform* and *variable*. Another classification has reference primarily to the *amount of heat received from the sun*. On this basis the earth is subdivided into climatic zones, the borders of which are parallels. The climatic zones based on insolation represent *solar climate*. Solar climate is so much modified by various factors other than insolation, that climatic zones bounded by lines other than parallels have been suggested. The effect of land and water on temperature has already been noted. So important is this effect that climates are also classified into *oceanic* and *continental*, and continental climates, in turn, are subdivided on the basis of (1) distance from the sea, (2) altitude, and (3) topographic relations. The controlling element in most of these classifications is temperature.

## Climatic Zones

On the basis of climate, the earth is divided into several zones. Those commonly recognized are (1) the *torrid zone*, which is centered about the equator, (2) the *temperate zones*, which occupy the extra-tropical latitudes, and (3) the *frigid zones*, which lie about the poles. Better names for these zones are the *tropical*,

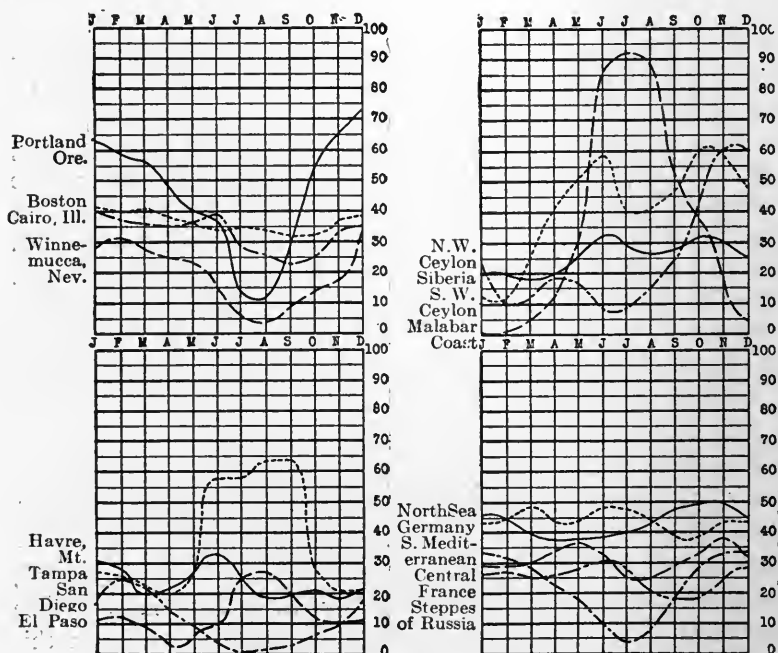

FIG. 672.—Graphs showing percentage of rainy days in each month for eight stations in the United States. (Cox, U. S. Weather Bureau.)

FIG. 673.—Graphs showing percentage of rainy days in each month for several stations in foreign lands.

the *intermediate*, and the *polar* zones<sup>1</sup> respectively, and these terms will be used hereafter. The limits of these zones have been variously defined. One classification defines them by *latitude*, a second by the direction of the *winds*, and a third by *temperature*.

<sup>1</sup>Ward, Bull. Am. Geog. Soc., Vol. XXXVII. 1905.



**Zones defined by latitude.** Defined by latitude, the tropical zone is limited poleward by the tropics, and the polar zones are limited, equatorward, by the Arctic and Antarctic circles respectively, while the intermediate zones lie between the tropical zone and the polar zones on either hand.

Stated in other terms, the *tropical zone*, according to this classification, is the zone (1) where the sun is vertical at some time during the year (except at the tropics, twice a year); (2) where variations in the length of day and night are least; (3) where the annual

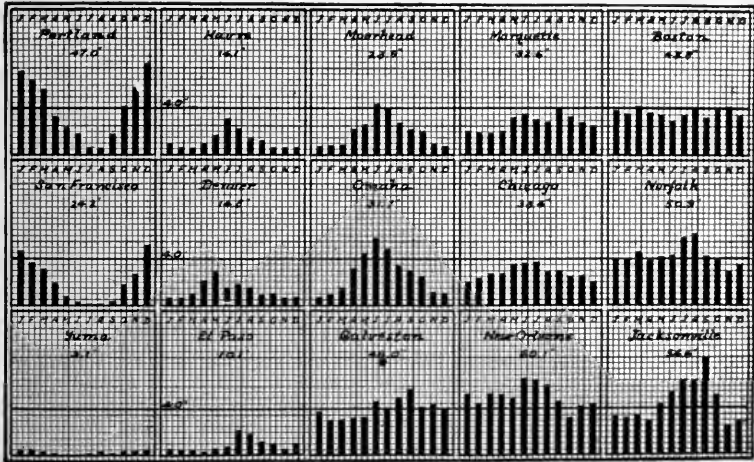

FIG. 674.—Comparative data, average monthly precipitation. The letters are the initial letters of the months. The places in the upper row, commencing at the upper left corner and reading to the right, are: Portland, Ore.; Havre, Mont.; Moorhead, Minn.; Marquette, Mich.; and Boston. In the second row: San Francisco; Denver; Omaha; Chicago; and Norfolk, Va. In the third row: Yuma, Ariz.; El Paso, Tex.; Galveston; New Orleans; and Jacksonville, Fla. (U. S. Weather Bureau.)

insolation is greatest and the average temperature highest; (4) where the range of annual insolation is least, and consequently (5) where the annual range of temperature is least.

The greater insolation of this zone is explained by the lesser obliquity of the sun's rays. At the equator, at noon, they depart nearly  $23\frac{1}{2}^{\circ}$  from verticality at a maximum; at the tropics, they depart nearly  $47^{\circ}$  from verticality at a maximum; and at intermediate latitudes by an intermediate amount. The average in-

clination of the sun's rays for this zone at noon is between  $17^{\circ}$  and  $18^{\circ}$ , while the average inclination for the intermediate zones is about  $45^{\circ}$ . The sun's rays, therefore, depart much less from verticality in the tropical zone than in the intermediate zones. The slight range of temperature in this zone is explained by two facts, namely, (a) within the tropical zone the days and nights are never very unequal (Fig. 536), and (b) the change in angle of the sun's rays during the year is less than elsewhere.

The *intermediate* (temperate) zones are the zones (1) where the sun's rays are never vertical; (2) where the days and nights are very unequal, each ranging from  $10\frac{1}{4}$  hours at the equatorward limit of the zone to nearly 24 hours at the poleward limit, in the course of the year, but where the sun never appears above the horizon for twenty-four hours consecutively; and (3) where the amount of annual insolation is less, and (4) its annual range greater, than below the tropics.

The *polar zones* are the zones (1) where the days and nights are sometimes more than twenty-four hours long. They are the zones (2) of least annual insolation, and (3) of greatest range of insolation.

According to this definition of the zones, the tropical zone is about  $47^{\circ}$  wide, each of the temperate zones about  $43^{\circ}$ , and each of the polar zones about  $23\frac{1}{2}^{\circ}$ .

This classification has the merit of simplicity, and it has a definite astronomical basis; but the limits of the zones thus defined do not always separate one sort of climate from another. As applied to actual climate, and to the things which climate affects, the subdivision seems arbitrary. Thus, the climate in that part of the intermediate zones near the tropics is essentially like that of the tropical zone, while the climate of that part of the intermediate zones next to the polar zones is not very different from that of the polar zones. On this basis there is far more difference between the climate of the lowest and the highest latitudes of an intermediate zone, than between the climate of the lowest latitudes of an intermediate zone and that of the highest latitudes of the tropical zone, or between the climate of the highest latitudes of the intermediate zone and that of the lowest latitudes of the polar zones.

**Zones defined by winds.**<sup>1</sup> If climatic zones be defined by

<sup>1</sup> Davis' Elementary Meteorology.

the direction of prevailing winds, the tropical (or trade-wind) zone is the zone where the trade-winds blow. It extends somewhat beyond the tropics, even to latitudes of  $30^\circ$  or  $35^\circ$  on the eastern sides of the oceans. The intermediate zones lie poleward from the trade-wind zone, and are characterized by prevailing westerly winds and variable climate, but they have no definite poleward boundaries. If definite poleward boundaries must be assigned, they might be placed at the polar circles, though the westerlies prevail beyond them. This definition has the merit of placing the dividing-line between the tropical and intermediate zones where the simple and uniform climate of the trade-wind zone gives place, poleward, to the more complex and variable climate of the zone where the westerlies prevail. This classification has the merit, therefore, of grouping together climates which are really similar. It takes account of climatic elements other than temperature. The poleward limits of the intermediate zones has a much less logical definition.

The lack of simplicity and of mathematical precision is sometimes considered an objection to the definition of zones by the direction of the winds. Thus, the zone of the trades shifts north and south with the seasons. On this basis, therefore, places near the border of the trade-wind zone are sometimes in that zone and sometimes in the zone of the westerly winds. As a matter of fact, this annual shifting of a place from one zone to another corresponds with actual climatic conditions, even if it is not simple. The basis of this definition of zones is therefore quite as rational as that of the preceding, and if it leaves the zones with rather vague boundaries, it is because nature has left them somewhat ill-defined.

**Zones defined by isotherms.** If the zones be defined on the basis of temperature, the dividing-lines between zones are isotherms. One proposed division makes the annual isotherms of  $68^\circ\text{F}$ . the equatorward limits of the intermediate zones, while their polar limits are the isotherms of  $50^\circ$  for the warmest month (Fig. 675). On this basis, the tropical zone is narrowed over the eastern sides of the oceans and broadened on the western sides, as a result of the influence of the lands.

On the whole, this seems a fairly satisfactory basis for the definition of climatic zones, though it lacks the mathematical

simplicity and precision of the first, and it fails to take account of some diverse elements of climate recognized by the second.<sup>1</sup>

Each climatic zone has at least two principal subdivisions, a continental and an oceanic. The oceanic climate of any zone prevails where there are extensive areas of water, and the continental climate prevails elsewhere.

**Oceanic climates.** Oceanic climates are less variable than continental climates in the matter of temperature. Between the

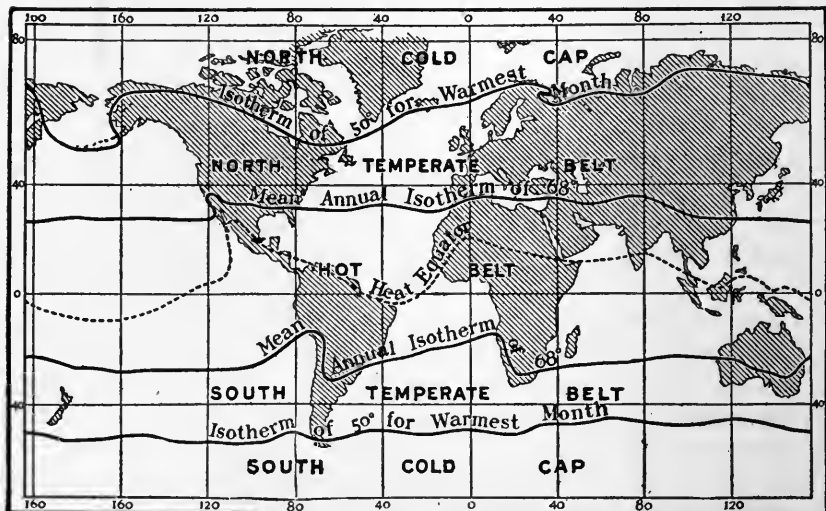

Fig. 675.—Temperature zones. Degrees F. (After Supan.)

latitudes of  $0^{\circ}$  and  $40^{\circ}$  the diurnal range of temperature is only  $2^{\circ}$  to  $3^{\circ}$  over the sea. It is far more on land. The annual range of temperature over the sea is also much less than that on land. This is illustrated by Fig. 676, which shows the annual variation on the island of Madeira (curve *M*) and at Bagdad (curve *Bd*) in Asia Minor. The former represents a marine climate, the latter a continental climate. In higher latitudes the differences are still greater, as shown by the curves *V* and *N*. The former represents the marine climate of Valentia on the southwest coast of Ireland, and the latter the continental climate of eastern Siberia.

The sea retards the annual march of temperature more than

<sup>1</sup> The classification of climates on the bases here considered is well discussed by Ward, *Bull. Geog. Soc. of Am.*, 1906, p. 401,

the land does (Fig. 677). The springs are therefore relatively colder and the autumns warmer than on land. The humidity of the oceanic climate is greater than that of continental climates. This results in more cloudiness and often in more rainfall, especially in winter. The winds of the sea are, on the whole, stronger than those of the land. The leeward shores of the oceans (the shores to which winds blow) have climates which are essentially oceanic. The more equable temperatures and the greater amount of mois-

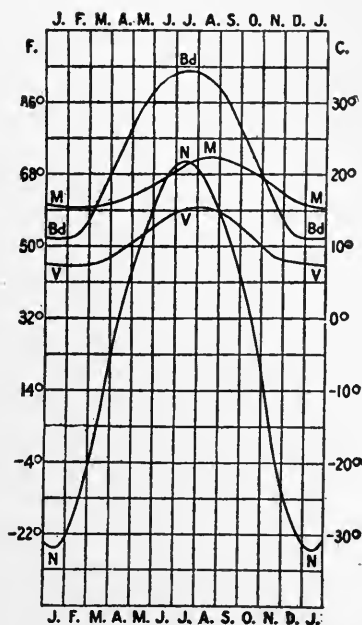

FIG. 676.—Graphs to illustrate oceanic and continental climates in different latitudes. *M* = Madeira, *Bd* = Bagdad, *V* = Valentia, and *N* = Eastern Siberia. (After Angot.)

ture on such coasts have important effects on vegetation and on animal life. These effects go beyond the mere facts of life and death, and even beyond degrees of thrift. For example, wheat has less protein in a marine climate than in a continental. Again, starch decreases and gluten increases with increase of temperature.<sup>1</sup> Potatoes grown in the arid West, where the necessary (but no unnecessary) water is supplied by irrigation, produce more nutritious

<sup>1</sup> Hann's Handbook of Climatology.

matter than those grown in moister climates. These are but illustrations of general facts.

**Continental climates.** In contrast with marine climates, continental climates have greater annual and daily ranges of tem-

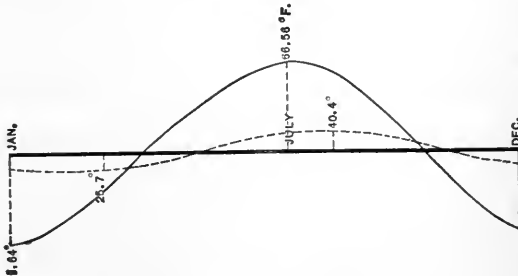

FIG. 677.—Annual march of temperature (in degrees Fahr.) in continental and oceanic climates. The horizontal line represents the annual average. (After Hann.)

perature, and the seasons lag less than over the sea. In high latitudes the skies are clearer and the winters colder; in low latitudes the winters are warmer than over the sea. The humidity and the rainfall are less, and the rain less frequent in the interiors of the continents than over the sea; but its amount and distribution are largely influenced by topography, winds, etc. The air over continents is also dustier than that over the sea.

The differences between oceanic and continental climates, so far as temperature is concerned, are indicated by the following tables:

	January.	July.	Year.	Range.
Mean temperature of oceans.....	17.9° C.	10.2° C.	18.3° C.	7.6° C.
Mean temperature of continents.....	7.3°	22.9°	15.0°	15.6°

Latitude.	0°.	10°.	20°.	30°.	40°.	50°.
Mean temperature of land hemisphere.....	44.8°	42.5°	36.4°	26.0°	15.7°	3.6°
Mean temperature of water hemisphere.....	22.2°	21.2°	19.6°	17.4°	12.7°	7.6°
Difference.....	22.6°	21.3°	16.8°	8.6°	3.0°	-4.0°

*Desert climates* are an extreme phase of continental climates. Here daily ranges of temperature are great. As a result, winds are

high by day, and the air often so dusty as to make travel difficult. The nights are calmer and cooler. As a result of the great daily ranges of temperature and the high winds, rock breaking, due to changes of temperature (p. 73), and dust and sand transportation by the wind (p. 55), are at a maximum. The dryness is hostile to plants, and therefore to animals.

Since the *littoral* (coastal) climate on the windward side of the continent is very like the oceanic climate of the same latitude,

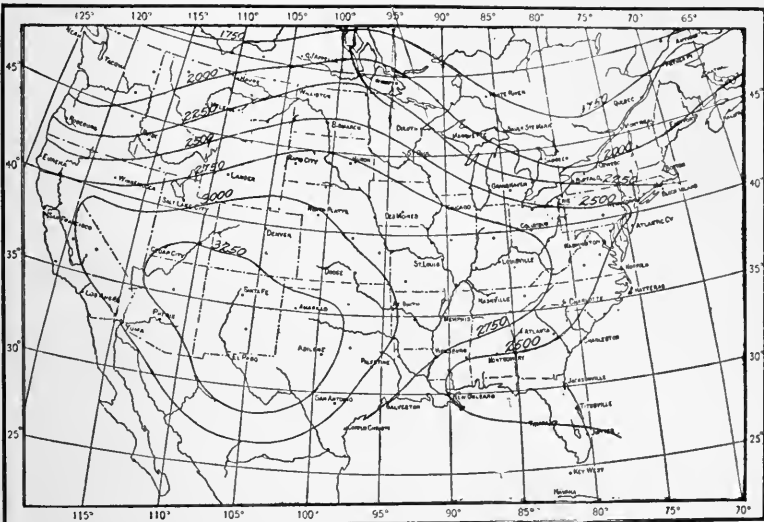

FIG. 678.—Figure showing sunshine in the United States in hours per year. The numbers on the lines show the hours per year. (After van Bieber.)

the west coasts of the continents, in the zones of westerly winds, have oceanic climates, and east coasts have continental climates. In the zone of trade-winds the reverse is the case.

The climate of the littoral zones is sometimes controlled largely by monsoon winds. So important are the monsoon winds that it is proper to speak of a monsoon climate. Monsoons are generally on shore in summer, and so give summer rains; but locally the monsoons give precipitation in winter.

**Mountain and plateau climates** differ from other continental climates, because of (1) the increased insolation and radiation which go with increase of altitude, (2) the lesser absolute humidity, (3) the lower temperature, (4) the greater range of solar temperature,

and (5) the greater frequency of precipitation, up to certain altitudes. The difference between soil temperature and air temperature is also greater than at lower levels.

Mountains, like oceans, have relatively pure air and high winds. They modify general winds and give rise to local winds, such as mountain and valley breezes. They interfere with free horizontal

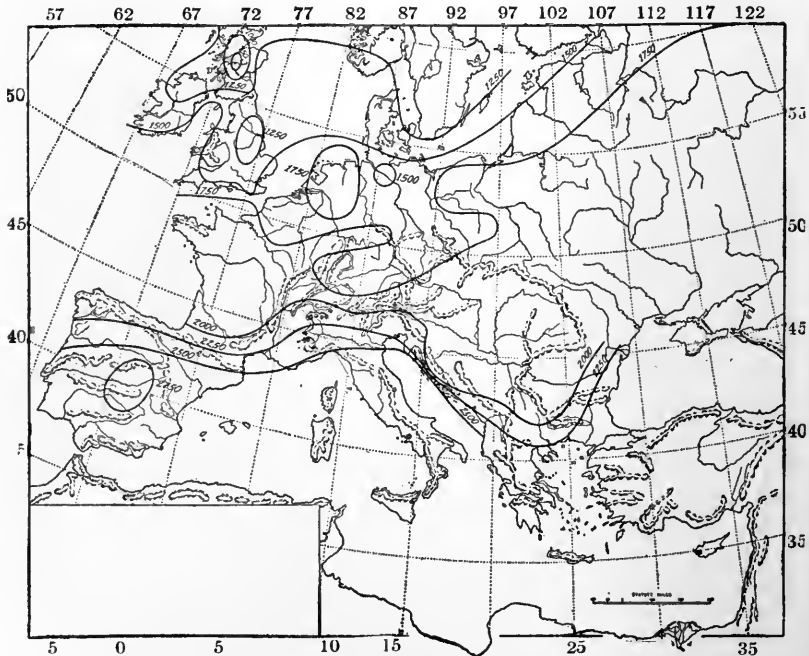

FIG. 679.—Figure showing sunshine in Europe in hours per year.  
(After König.)

interchange of air, so that pressure and moisture conditions may be quite different on opposite sides of a mountain range.

**Climatic effect of forests.** Forests also exert a modifying influence on continental climates. They lower the summer temperature by increasing the radiating and evaporating surfaces, and by increasing the cloudiness. They increase the relative humidity of the air; but it seems to be uncertain whether they have much effect on precipitation. The data for some regions seem to point to an affirmative answer, and for others to a negative one. In any case, they tend to hold back the water after it falls and to



retard the melting of snow, so that their general effect on the moisture of the region is much the same as it would be if the precipitation were increased. Forests also afford protection against winds.

With these distinctions in mind, we may study briefly the climates of the several zones.

## THE CLIMATES OF THE SEVERAL ZONES

### *The Tropical Zone*

The leading characteristic of the climate of this zone is its relatively high temperature. Uniformity of winds, temperature, and humidity are especially characteristic of the oceanic climate of this zone. On land the variation of all the principal elements of climate is greater.

The prevailing winds of the tropical zone are easterly,—northeasterly in the northern part of the zone and southeasterly in the southern part,—with a zone of calms (the doldrums) between (p. 603). So long as these winds blow over the sea or over low lands, they are, in general, dry winds (p. 616). Many lands in their path, notably Sahara and parts of Australia, are desert; but, where they blow over mountains or plateaus, they yield moisture to them, especially to their windward sides (p. 616). The abundant rainfall on the east slope of the Andes, on the tableland of Brazil, and on the higher parts of the Hawaiian Islands, are illustrations. Even in the Sahara there are mountains which occasion precipitation enough to support forests, but the descending streams soon disappear in the surrounding desert. For reasons which have already been pointed out (p. 617), the leeward sides of mountains in the zone of the trades get little moisture from the trade-winds. In many cases the water which falls on the mountains, and flows thence to the plains below, may be utilized there for irrigating the lands not favored by precipitation.

Monsoon winds are often pronounced in the tropical zone. They sometimes displace or greatly modify the trades, and become the controlling element in the precipitation, often giving rain to regions which would otherwise be dry. It is from the southwest monsoon that India and Farther India receive their heavy rains, concentrated in a wet season when the monsoon blows from sea to land. Since this monsoon blows during the warm season, rain

must fall at that time (July to September). Like other winds, monsoons which blow from the sea over low lands yield much less rain than those which blow over high lands. Monsoon winds often relieve the dryness which would otherwise exist on the west sides of mountains in the trade-wind zone.

The tropical zone is not entirely dependent on winds for its rainfall. Rainfall and cloudiness increase toward the center of the tropical zone, while the strength of the winds decreases. In the doldrums (p. 617) convection currents give daily (afternoon) rains, thus interrupting the generally arid low lands of the tropical zone by a middle or sub-equatorial belt of more abundant rainfall. In this belt flourish the forests of the Amazon and of middle Africa. Since the belt of calms shifts a little with the sun, the zone of daily rains also shifts. A place which is in the belt of daily rains at one time of the year may be in the path of the trades at another, and may therefore have alternating wet and dry seasons.

Near the poleward margin of the tropical zone also there is likely to be variation in precipitation, for places in such positions find themselves in the zone of dry trades in the summer and in the zone of variable winds in the winter. In neither case, however, are they favorably situated, so far as winds are concerned, for heavy rainfall, and have abundant moisture only where topography or some other special factor favors. The most pronounced desert of the whole earth, the Sahara, lies near the poleward border of the trade-wind zone.

Along the coasts of tropical lands the temperature is modified by the daily sea-breezes as well as by the monsoons. Because of the direction of the prevailing winds, the climates of the eastern coasts of continents in tropical latitudes are affected by the sea more than those of western coasts.

The range of temperature in the tropical deserts is very great. The annual temperature of Sahara is about 80° F. The temperature of the warmest month averages about 90° F. and that of the coldest about 70° F. The *average* annual range is therefore relatively slight; but the yearly extremes are far greater, for it sometimes reaches 120° F. (Fig. 540), and sometimes drops to 50°. Great as this range is, it is far less than that of most inland places in the intermediate zones, where extreme ranges of 120° are not uncommon. The daily range of temperature in tropical deserts is great.

*Climate of Intermediate Zones*

The average temperature of the intermediate zones is lower than that of the tropical zone, its annual range greater, and its daily range, *on the average*, less.

The lower average temperature of the intermediate zones results from the fact that they receive less heat per square mile than lower latitudes, where the rays are more nearly vertical. The range of temperature from season to season is greater, because of (1) the greater inequality of day and night, and (2) the greater range in the angle of the sun's rays. In latitude  $45^{\circ}$  there are, at the maximum (summer solstice), about  $15\frac{1}{2}$  hours of sunshine (and heating), and  $8\frac{1}{2}$  hours of night (cooling with no insolation), while at a minimum (winter solstice) there are but  $8\frac{1}{2}$  hours of sunshine with  $15\frac{1}{2}$  hours of night. Not only this, but when the days are longest the sun's rays are most nearly vertical, so that the heating power per hour is greatest when the days are longest, and least when they are shortest (Fig. 536). The result is that the summers, even in the latitude of  $45^{\circ}$ , may be very hot, while the winters, except near windward coasts, are very cold. The annual range includes summer heat which, at its maximum, is not less than that of the tropical zone, and winter cold which is often frigid. The annual range is greater in the higher latitudes of this zone than in the lower. These great extremes of annual temperature, as well as the sudden changes of temperature and of humidity which accompany the passage of cyclones and anticyclones, make the term "temperate" singularly inappropriate for the climate of the intermediate zones. These last statements are especially true of the Intermediate Zone of the Northern Hemisphere. They have less application to the Southern Hemisphere, where the area of land in middle latitudes is not so great.

Figs. 662 and 666 show different phases of the variations to which the temperature of intermediate latitudes is subject.

The effects of the cold winters and the hot summers of temperate latitudes make themselves felt in the temperature of the springs and autumns respectively, as already pointed out, but this point is of so much importance, climatically, that it will now be stated with greater fullness.

During the winter the ground is cooled, and in the higher latitudes of the intermediate zones the water in the ground is frozen to the depth of several feet. The frozen water in the ground

may be looked on as "stored-up" cold. Even where the rock is dry, it becomes cold in winter, and has much the same effect as ice on the air of the succeeding spring. Snow accumulated on the land in winter, and ice formed on lakes and ponds, have the same effect. When the lengthening days of spring come, with their less oblique rays of the sun, the snow and the frozen water in the ground must be melted and the soil and rock warmed, before the air in contact with it can fully respond to the increased insolation; for so long as the ground is cold, the air next to it cannot become very warm. In intermediate latitudes, therefore, the spring is retarded because of the snow, the ice, and the cold soil and rock. A simple analogy may be suggested. If a fire were built in a stove covered with ice, it would take notably longer for the stove to warm the room than if the fire were built in a stove already warm; for the ice must be melted before the stove can bring the air about it to a high temperature.

In the early autumn, on the other hand, the ground is warm from the heat of the summer, some of which has been absorbed and retained by the soil, the rock, etc. Warmth has been stored up, and the warmed ground helps to warm the air, so that, as the days shorten and the rays of the sun become more oblique, the temperature does not fall as fast as it would were the ground not warm. Thus, the effects of the summer's heat hold over into the autumn, as the effects of the winter's cold hold over into the spring. The result is that September is much warmer than March in middle latitudes, though insolation is essentially the same in the one month as in the other. Cold is more effectively stored up than heat, so that spring lags more than autumn.

The lagging effect produced by the storing up of heat and cold is shown by a comparison of the average monthly temperatures of individual places. The monthly averages for Chicago are as follows:

January, 23° F.	July, 75° F.
February, 27° F.	August, 72° F.
March, 35° F.	September, 65° F.
April, 50° F.	October, 53° F.
May, 61° F.	November, 39° F.
June, 70° F.	December, 30° F.

These figures show that the average temperature of Chicago

for March is less than that for November. The insolation of November is far less than that of March—is, indeed, but little less than that of January, the coldest month of the year. This notable lagging of the temperature behind that normal to the insolation is the result of the storing up of heat and cold. Again, the insolation of May is but little less than that of July, but the stored-up cold from the preceding winter prevents the insolation during May from having as much effect as it does in July, after the cold stored up in the preceding winter has been more largely dissipated.

The lagging of the seasons is greater in the higher latitudes of the intermediate zones than in the lower, and the effects are more pronounced inland than near coasts, and are less on west coasts than on east ones. These and other significant facts are shown by the tables on page 698.

Westerly winds prevail in the intermediate latitudes (p. 603), and many of the distinctive features of the climate of these zones, both as regards temperature and moisture, are determined by these winds. As they blow from sea to land, as from the Pacific to the American coasts, they are nearly saturated with moisture. Where they blow over land which is warmer than the sea (low lands in summer), they become *dry winds*, because they take up moisture; but when they blow over land which has a temperature lower than their own (most lands in winter and mountains at most times), some of their moisture is condensed and rain (or snow) falls. The windward slopes of high mountains in these zones are therefore well supplied with moisture, while plains to the lee of such mountains are likely to be dry. This is the explanation of the general aridity of the regions east of the Sierra Nevada and the Rocky Mountains. Though these regions have little rainfall, that which falls in the mountains is coming to be utilized to some extent in irrigating the valley lands adjacent.

Middle latitudes are fortunately not dependent entirely on the westerly winds for their rainfall. Cyclonic storms often furnish a sufficient supply of moisture where the westerlies are dry (p. 618). Thus east of the 98th meridian in the United States the rainfall is generally adequate for agriculture, though most of it is not supplied by the westerly winds from the Pacific.

The cyclone and the anticyclone are important factors in the temperature as well as the precipitation of the intermediate zones. They give us our greatest annual extremes of heat (cyclones in

MONTHLY AVERAGE TEMPERATURES (FAHRENHEIT) FOR FOUR PLACES  
IN LATITUDE 33° TO 35°

	Los Angeles.	Santa Fé.	Vicksburg.	Charleston.
January.....	53°	40°	48°	50°
February.....	55°	46°	51°	52°
March.....	58°	55°	57°	57°
April.....	60°	64°	66°	65°
May.....	63°	72°	73°	71°
June.....	67°	84°	81°	77°
July.....	70°	88°	83°	81°
August.....	73°	85°	82°	80°
September.....	71°	76°	76°	70°
October.....	64°	66°	67°	66°
November.....	60°	52°	57°	55°
December.....	53°	44°	50°	50°
Range.....	20°	48°	35°	31°

MONTHLY AVERAGE TEMPERATURES FOR FOUR PLACES IN LATITUDE 41°  
TO 43°

	Coast of North Carolina.	Long. 100°.	Chicago.	New York.
January.....	46°	23°	23°	30°
February.....	46°	28°	27°	31°
March.....	50°	30°	35°	36°
April.....	51°	55°	50°	47°
May.....	54°	64°	61°	59°
June.....	55°	75°	70°	70°
July.....	60°	81°	74°	73°
August.....	60°	77°	71°	71°
September.....	55°	67°	65°	65°
October.....	53°	56°	53°	55°
November.....	50°	41°	39°	42°
December.....	46°	31°	30°	34°
Range.....	14°	58°	51°	43°

MONTHLY AVERAGE TEMPERATURES IN THREE PLACES IN LATITUDE 48° TO 50°

	Seattle.	Winnipeg.	Mouth of the St. Lawrence.
January.....	35°	-6°	7°
February.....	37°	-1°	12°
March.....	44°	14°	22°
April.....	49°	38°	33°
May.....	56°	50°	44°
June.....	60°	63°	55°
July.....	64°	67°	60°
August.....	65°	65°	60°
September.....	59°	53°	50°
October.....	52°	40°	40°
November.....	45°	20°	30°
December.....	40°	4°	15°
Range.....	30°	73°	53°

summer) and cold (anticyclones in winter). They also occasion the great aperiodic changes of temperature which recur at short intervals ("spells" of heat and cold), as well as the sudden changes of weather, and so are an element of the variable climate of these zones. Figs. 668 to 671 represent one phase of the variations to which the continental climate of the intermediate zone is subject.

The climates of the northern and southern intermediate zones are very unlike, because of the greater expanse of land in the former. The climate of the southern zone is essentially oceanic, for the lands are limited. The prevalence of water reduces the extremes of temperature. Compared with the corresponding zone of the northern hemisphere, the cool summers are one of the most notable characteristics of this zone. Cloudiness and humidity are also prevalent, except in the lee of mountains. These characteristics make the climate relatively inhospitable, and the lands of the southern hemisphere in latitudes corresponding to those of London and New York are usually unproductive, more because of the cold summers, than because of the low temperatures of winter. A comparison of the annual and seasonal temperatures of southerly latitudes, say in latitudes of  $30^{\circ}$  to  $40^{\circ}$ , with those of the corresponding latitudes in the northern hemisphere is instructive (Figs. 538, 539, and 540).

The temperature of January and July for the northern and southern hemispheres (all latitudes) is shown in the following table:

	January.	July.	Difference.	Mean.
Northern hemisphere.....	8.0° C.	22.5° C.	14.5° C.	15.2° C.
Southern hemisphere.....	15.5°	12.4°	5.1°	14.9°
Earth as a whole.....	12.7°	17.4°	4.7°	15.0°

The oceanic climate of the north intermediate zone is comparable to that of the southern zone. The prevailing westerly winds tend to carry the oceanic climate over onto the western borders of the continents. Hence the mild climate of the western coasts of both North America and Europe. On both these coasts the range of temperature, like that of the tropical zone, is relatively low. Blowing over the cooler land, the oceanic winds give abundant moisture and often much cloudiness and fog, especially in the higher latitudes. In the Americas, the tempering and moist-

ening effect of the winds is limited to a relatively narrow belt, for in crossing the high mountains the air loses both the warmth and the moisture it brought from the ocean. Beyond the mountains therefore the direct effect of the ocean is little felt. The mountains separate climates of notably different types.

In western Europe, on the other hand, there are no high mountains facing the ocean for any considerable distance, and the moist climate, without great extremes of temperature, which characterizes the coast, passes gradually into the continental climate of the interior, with its drier air and clearer skies.

The continental interiors of the intermediate zones have much greater ranges of temperature than the western coasts, and the ranges become greater with increasing distance from the ocean, and with increasing latitude (Figs. 665 and 666). In Siberia, for example, in high latitudes and far from a western coast, are found the greatest annual ranges of temperature known (Fig. 547).

In these zones the prevailing westerly winds are interrupted by storms throughout the year, and the winds are stronger and moister in winter than in summer.

The interiors of the continents in this zone receive their precipitation largely from cyclonic winds, and the climate has the variability which always characterizes the lands of cyclones and anticyclones.

The eastern borders of the continents are in contrast with the western. On the former, continental rather than oceanic climates prevail. The differences are brought into effective contrast between Vancouver and Labrador, or between England and Kamchatka, on opposite sides of a continental area; or between Labrador and England, or Kamchatka and Vancouver, on opposite sides of an ocean (see Figs. 538 to 540). The contrast is greater on the opposite sides of the Atlantic, than on opposite sides of North America, (1) because the tempering effect of the Gulf Stream on western Europe is greater than that of the Japan Current on western America, and (2) because the Atlantic opens more broadly to the cold Arctic Ocean, allowing more ice-water to pass down the eastern coast of North America than along the corresponding coast of Asia.

#### *Climate of the Polar Zones*

The distribution of the sun's heat is more unequal in the polar zones than in lower latitudes (p. 525). At the poles there is



half a year of continuous night and half a year of continuous day. Between the poles and the polar circles, the inequality of heat distribution is somewhat less than at the poles, but still great. The seasonal range of insolation is greater here than in other latitudes, but, in spite of this fact, the annual range of temperature is less than in some other latitudes. This is because much of the surface is covered with snow or ice (or ice-cold water), and the heat received cannot bring the temperature of the surface above 32° F., so long as snow and ice remain. Where these conditions exist, the summer temperature of the air is raised but little above the freezing-point. Where the land is free from snow during the warm season, on the other hand, the annual range of temperature is great. The diurnal range of temperature is, on the average, not so great as in lower latitudes.

Precipitation in the polar zones is not usually heavy, and much of it falls as snow. Where the surface is continually covered with snow or ice, the precipitation is generally heaviest in the summer. The winds are then more heavily laden with moisture, and blowing over the surface of snow and ice, the air is chilled to the point of precipitation. Because of the low temperature of winter, the air of that season contains but little water vapor, and so gives but little rain or snow.

Even in very high latitudes, such as that of North Greenland, anomalous conditions of weather sometimes occur, and show how variable the climate may be. In the winter of 1894-5 a thunderstorm with rain occurred in latitude 78° 45'; and even in the midst of the long winter night, a temperature above the freezing-point has been known to occur in the same region.

These extraordinary phenomena are doubtless the result of extraordinary movements of air—in ways and for reasons not well understood.

#### *Rainfall and Agriculture, etc.*

The relation of rainfall to agriculture has already been mentioned (p. 615). It should be added that the beneficial effects of precipitation depend not only on its amount and distribution through the year, but also on its rate of fall. Besides the damage they occasion through floods, heavy downpours of rain are much less advantageous to crops than slow rains. Some figures on this point are shown in the following table.

## ANALYSIS OF RAINFALL AT IOWA CITY IN 1889 AND 1890

	1889.	1890.
Total rainfall. . . . .	724 mm.	687 mm.
Washing and flooding rains. . . . .	330 "	149 "
Insignificant rains. . . . .	36 "	29 "
Total utilizable rains. . . . .	358 "	509 "

Much may be done toward utilizing semi-arid lands by selection of the crops to be raised, with especial reference to the temperature and the moisture of the region to be tilled.

Hann calls attention to the fact that in Jamaica and the Barbadoes the sugar crop may be calculated with approximate accuracy from the amount of precipitation. In South Australia, land which has 8 to 10 inches of precipitation will support 8 or 9 sheep to the square mile. In New South Wales, 4 inches more of rainfall will allow the land to support 96 sheep per square mile; an increase of 7 inches more (20 inches in all) will allow an equal area of land to support 640 sheep. In Argentina, with 34 inches of precipitation, land will maintain 2630 sheep per square mile. These figures do not take account of possible differences of soil.

From the human point of view, winds are an important element of climate. Calms are enervating and winds stimulating. Hygienically, winds are of great importance where population is dense.

**Climate and life.** The distribution of life is controlled very largely by climate. The dry deserts of low latitudes, the deserts in the lee of lofty mountains, and the snow deserts of polar regions, are essentially climatic. Where rainfall is adequate and where temperature favors, life abounds wherever there is a proper soil; and even the accumulation of a proper soil is largely influenced by climate. The best soil, inherently, is worthless where water is wanting, or where the temperature is too low for plant life.

Of Australia it has been said that "Land without rain is worth nothing; and land in an Australian climate, with less than 10 inches a year, is worth next to nothing. Rain-water, without land, if the water can be stored in a reservoir and sent along a canal, is worth a great deal."<sup>1</sup>

<sup>1</sup> Wills, cited by Hann.

*Changes of Climate*

**Within historic time.** There appears to be little basis for the popular notion, especially among elderly people, that the climate is changing. There seems to be a natural disposition to exaggerate the striking features of notable seasons. Thus winters of heavy snow or of intense cold come, in time, to be the only winters which are distinctly remembered. Exceptional seasons thus come to stand for the normal winters of the past. Another reason for the notion that climate is changing appears, in many cases, to be that those who entertain this view have changed their place of residence, so that the comparison is unconsciously made between the climate of New York, for example, and that of Iowa, climates which are somewhat different. Actual records of climate, covering as much as a century for some parts of our country, do not afford any basis for the conclusion that the climate is changing materially.

Fluctuations of rainfall, temperature, etc., do occur in relatively short cycles. Thus there seems to be a faintly marked weather cycle of about eleven years, corresponding to the sun-spot cycle; but it is not yet clear that this periodic change is general or persistent. Hann says that the only thing which can be considered as proved is that there are traces of a parallelism in the march of certain meteorological elements and that of the sun-spot period.<sup>1</sup>

A longer cycle of about thirty-five years is indicated for Europe, where records have been kept longer than in our own country. This conclusion is based on the weather data of more than two centuries. Within the cycle of this duration there may be said to be two focal periods of a few years each, one when the rainfall is above and the temperature below the average, and the other when the rainfall is below and the temperature above. These two focal periods are not, however, symmetrically placed in the cycle. Thus the period of minimum rainfall may occur five years after the period of maximum rainfall, or it may occur thirty years after it. In view of this great irregularity, it may be doubted whether the cycle is to be regarded as based on laws which are universally applicable.

<sup>1</sup> Hann, *Handbook of Climatology*.

The focal periods, as set forth by Brückner, are as follows:

Wet and cool.	Interval between.	Dry and warm	Interval between.
1671-1675	25	1681-1685	45
1696-1700		1726-1730	
1741-1745	45	1756-1760	30
1766-1770	25	1786-1790	30
1816-1820	50	1820-1830	37
1851-1855	35	1861-1865	38

The reader may judge for himself as to the adequacy of the basis of the thirty-five-year period.

Variations of climate reflect themselves in the movements of the glaciers. This has been observed especially in connection with the glaciers of the Alps. The glaciers advance *after* (commonly some years after) the periods of maximum precipitation and minimum temperature, and retreat after the opposite conditions are most pronounced.

Certain historic facts have been interpreted to indicate changes of climate in some regions since the beginning of the historic period. Thus regions once populous are now too arid to support an abundant population. This is the case in southwestern Asia and northern Africa, where the ruins of aqueducts and irrigating canals exist where there are now no adequate sources of water.

**In geologic time.** Going still further back, there is abundant evidence of profound changes of climate in the course of the earth's history. There have been at least three periods and perhaps more, widely separated in time, when glaciation took place where glaciers do not now exist. During one of these periods of cold there were extensive glaciers in low latitudes, even in regions which now have tropical and sub-tropical climates (India, Australia, South Africa). The first of these periods of exceptional cold made its appearance early in the earth's history (at the beginning of the Paleozoic era, or perhaps even before), and the last (the late glacial period) has but just passed.

Warm climates, on the other hand, have persisted for long periods in polar regions, even down to relatively recent times.

Thus Greenland enjoyed a warm climate not long (geologically) before the development of its present ice-sheet. The data now known seem to indicate that the climate of the present time is cooler than that which has existed throughout the larger part of the earth's history.

Repeated changes in humidity seem to be as clearly indicated as changes in temperature. Arid climates have existed at various periods of the earth's history, in regions which have moist climates at the present time (e.g., New York and Ohio), and moist climates have been enjoyed by regions which are now essentially desert (e.g., Arizona). The aridity in the one case is indicated by salt and gypsum deposits, and the humidity in the other by conclusive evidence of luxuriant plant life in regions which are now desert.

In some cases the causes of these changes were doubtless local, and due to changes in topography; but in others this explanation is not applicable. It seems clear, therefore, that causes have long been in operation which bring about variations both in temperature and humidity. These causes have sometimes been thought to be (1) *geographic*, and due to the changes in the relations of land and water, or to changes in the topography of the land; (2) *astronomic*, due to changes in the shape of the earth's orbit, the precession of the equinoxes, etc.; and (3) *atmospheric*, due to changes in the constitution of the atmosphere. Still other causes have been conjectured. As the facts concerning these changes accumulate, they seem to be pointing to the third of these lines of explanation as the most plausible. It cannot be said, however, that final conclusions have been reached.<sup>1</sup>

<sup>1</sup> On this point see Chamberlin and Salisbury's *Earth History*.

PART IV  
THE OCEAN  
CHAPTER XX

GENERAL CONCEPTIONS.

THE ocean occupies the great depressions in the earth's surface (p. 5). The area of the depressed segments is about twice as great as that of the elevated segments; but since the water more than fills them, it spreads out over some 10,000,000 square miles of the continental platforms. The result is that the ocean water covers nearly three-fourths (about  $\frac{7}{10}$ ) of the earth's surface. All the oceans are connected at the surface, and are therefore in some sense one, though different names are applied to different parts; but the ocean basins proper are measurably distinct.

Although the depressions in which most of the ocean water lies are called *basins*, they have little resemblance to the homely vessel which this name suggests. This is readily seen by the construction of a diagram. An arc three feet long, with a radius of about four feet, represents approximately the eighth of a circle. If such a curve be drawn on the blackboard, it may be taken to represent the width of the Atlantic Ocean between the United States and Europe. If the top of the chalk-line be taken to represent the surface of the ocean, another line representing the bottom of the ocean could not be drawn below it with an ordinary crayon, without exaggerating the depth of the water.

Fig. 680 may help to give us some conception of the real shape of an ocean basin. It is, in general, convex upward, but locally, especially where it joins the continental platforms, it is often concave upward. Fig. 681 shows the belts where the bottom is concave upward. These belts are usually 100 to 300 miles in width.

**The sea-level.** The surface of the sea is in sharp contrast with that of the land, in that the former seems to be level. We are accustomed to speak of it as if it were free from all unevennesses, and it is the datum plane from which all elevations on land are measured. It is, therefore, of importance to understand what the sea-level really is.

In the first place, it is a curved surface, and its curvature is approximately that of an oblate and slightly imperfect spheroid (p. 482). But its surface corresponds only approximately to that of a spheroid, for the land-masses which rise above the ocean basins and which culminate in mountains attract the waters of the sea to themselves, and so act somewhat against the principal attraction of gravitation, which tends to draw all objects toward the center of the earth. The Andes Mountains, for example, rise far above the sea close at hand, and the water adjacent to them is pulled up somewhat above the normal spheroid level by their attractive force. It has been estimated that the sea-water at the mouth of the Indus on the coast of India is 300 feet higher (that is, 300 feet farther from the center of the earth) than that about the island of Ceylon at the southern end of the peninsula. This distortion of sea-level is due to the attraction of the Himalaya Mountains and the adjacent high lands. All land-masses act in the same way, and the distortion is greater the greater the mass of land above sea-level close to the shore.

The sea-level, therefore, does not correspond exactly with the curvature of a spheroid. Furthermore, the heights and masses of mountains vary from age to age, so that their distorting effects vary somewhat in long periods of time. If it is desired to record the elevation of a place, for example in California, in a way which will be permanently accurate, it should be recorded not only that it is, say, 500 feet above sea-level, but that, for example, it was 500 feet

Fig. 680.—Diagram to illustrate the form of an ocean basin.

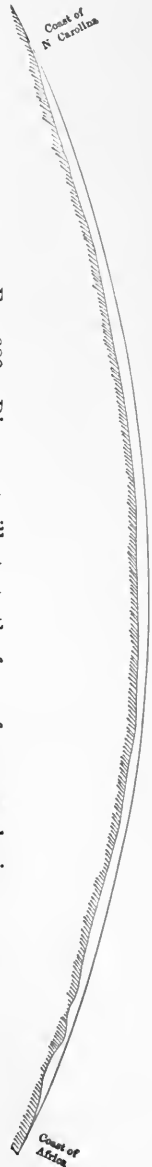

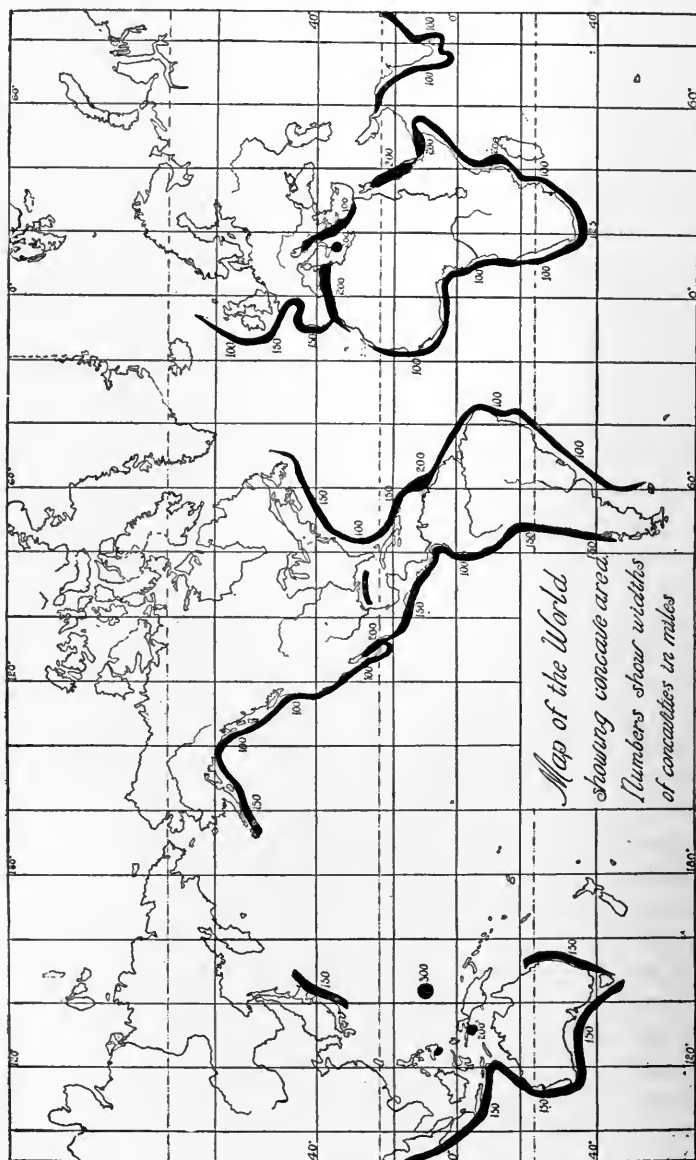

Fig. 681.—Chart showing in black the portions of the sea bottom which are concave upwards.



above sea-level in latitude  $40^{\circ}$  on the coast of California on January 1, 1900.

Apart from the more or less permanent distortions of the surface of the sea, due to the attraction of land-masses, there are temporary and slight inequalities of level, which will be considered later.

**What the physical geography of the sea includes.** The physical geography of the sea includes many things. Among them are (1) the distribution of its waters, (2) its depth at all points, (3) the topography of its bottom, (4) the composition of the water, (5) its color, (6) its temperature at all points at the surface and beneath it, (7) its movements, (8) its life, and (9) the material of its bottom.

The physical geography of the sea has become known, so far as it is now known, in various ways. The distribution of its waters has been made clear by outlining the areas of the land. The character of its waters is determined by chemical analysis. The movements of its waters are studied in various ways. Some of them, such as waves, may be studied from the shore; others, such as the currents, are less readily observed, but have become known, so far as they are known, (1) by their effects in changing the courses of sailing-vessels, (2) by observations on the course of objects floating in the water, (3) by their effects on temperature, and in various other ways.

Most of our knowledge concerning the depth of the ocean, its temperature, its life, the material and the topography of its bottom, and much concerning its movements, has been gained through expeditions which have been sent out from time to time to study these especial problems. The expeditions which have contributed to our knowledge of the ocean have been fitted out by governments in some cases, by societies in others, and by individuals or combinations of individuals in still others. The expedition which was carried out on the most elaborate scale was that of the Challenger, 1872-6, under the auspices of the British Government. This vessel made extended explorations in the Atlantic, the Pacific, and the Southern oceans (Fig. 682). The results of the observations made during the voyage of the Challenger, and inferences from them, have been published in a great series of large volumes which give us our most detailed knowledge of the sea. Numerous other lesser expeditions have made less

voluminous but still valuable contributions to our knowledge of the ocean. Here may be mentioned the work of the U. S. S. Mercury (Barbadoes to Sierra Leone, 1871), H. M. S. Lightning and H. M. S. Porcupine (Faroe Islands to the Mediterranean, 1868-70), the German frigate Gazelle (1874-6), and the U. S. Coast and Geodetic Survey steamer Blake (Gulf of Mexico, Caribbean Sea, east coast of the United States, 1877-80), and the work of the Coast and Geodetic Survey on the Gulf Stream (1845-59.) The

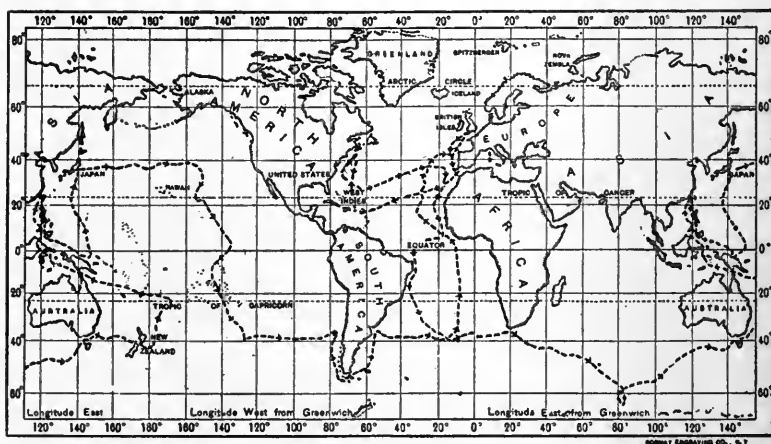

FIG. 682.—The course of H.M.S. Challenger, shown by broken line on oceanic areas.

expedition of Nansen into the Arctic region and the numerous expeditions of the last years into the Antarctic regions have given us much information concerning the waters of high latitudes. Some indication of the manner in which these expeditions do some of their work will appear in the following pages.

**Distribution of the ocean waters.** The distribution of the ocean waters has been outlined in a general way in connection with the distribution of the land (Chap. I.). The ocean encircles the earth in latitude  $60^{\circ}$  S., and from this encircling sea three great bodies of water, the Atlantic, the Pacific, and the Indian oceans respectively, extend northward. South of latitude  $60^{\circ}$  S. lies an elevated tract, Antarctica. It will be recalled that in the northern hemisphere the land makes an almost complete circuit in latitude  $60^{\circ}$  to  $70^{\circ}$ , whence it radiates southward in three (or

two) great arms, and that north of the encircling land lies the Arctic Ocean. The waters south of latitude  $40^{\circ}$  S. are often called the Southern Ocean. The Arctic Ocean is about one-thirty-seventh of the sea area, the Indian Ocean about one-eighth, the Southern Ocean one-fourth, the Atlantic one-fifth, and the Pacific three-eighths.

The unequal distribution of land and water in the northern and southern hemispheres has an important influence on their climates, as already stated.

**Depth.** The average depth of the ocean is estimated to be about  $2\frac{1}{2}$  miles, or between 12,000 and 13,000 feet. The average depth of the Pacific is estimated at  $2\frac{3}{4}$  miles; that of the Atlantic at  $2\frac{1}{2}$  miles; and that of the Indian and Southern oceans at  $2\frac{1}{4}$  miles. The average depth of the Arctic Ocean is not known, but Nansen found a depth of more than 12,000 feet off the continental shelf of Eurasia. The greatest known depth of ocean water is nearly six miles. This depth slightly exceeds the height of the highest mountain above sea-level. There are numerous places where the depth of the ocean exceeds four miles, and the area of very deep water is very much greater than the area of very high land. The tracts which are notably below the average depth of the ocean are often known as *deeps*.

The greatest known depth of water, 31,614 feet, is in the Pacific, near the Ladrone Islands. Another area of almost equal depth (30,930 feet) occurs in the Aldrich Deep northeast of New Zealand. A depth of nearly 28,000 feet is found in the Tuscarora deep east of Japan, and a depth of about 25,000 feet (nearly five miles) off the coast of Chile, in latitude  $24^{\circ}$  to  $25^{\circ}$  S.

None of these great depths is in the midst of the Pacific. Some of them are close to continental shores, and the others are in regions of abundant islands, and in surroundings where the water is not very deep. Most of them are in the western part of the ocean. In all cases the slopes down to these great depths are steep, as submarine slopes go, and the deeps have a pronounced tendency to elongation parallel to the nearest coasts or to adjacent submarine ridges, or to ridges the crests of which rise into islands.

The only area in the Atlantic where comparable depths are known is north of Porto Rico in the Blake Deep (lat.  $20^{\circ}$  N., long.  $65^{\circ}$  to  $68^{\circ}$ ), where a maximum depth of 27,366 feet has been sounded. This deep, too, is elongate, has steep slopes, and is parallel to the great ridge of which Porto Rico is a part, and near

which it lies. In few other places in the Atlantic does the depth reach 20,000 feet.

The Indian Ocean is not known to have depths much exceeding 20,000 feet, and the deepest known place in the Southern Ocean is still less.

The depth of the ocean becomes known by soundings. Soundings are made from ships, by reeling out a heavy metallic ball attached to a fine steel wire. (Why not a rope?) The ball is so fastened to the line as to be detached when it reaches the bottom (Fig. 683), because it is much simpler to leave it than to draw it up again. A sounding of 3000 fathoms may be made in about an hour.



FIG. 683.—The sounding-line. (Challenger Report.)

There is a more or less wide-spread notion that the deeper waters of the sea are so dense that weights will not sink readily, and that deep-sea sounding is attended with difficulty on this account. This is incorrect, for water is but slightly compressible, and the water in the deepest part of the ocean is but little heavier (probably not a twentieth), volume for volume, than that at the surface. There are difficulties connected with deep soundings, but their cause is not the great density of the deep water.

**Volume.** The average depth and the area of the oceans being known, the volume of water which they contain may be calculated. It is found to be nearly fifteen times the volume of land. If all the material of the land were carried to the sea and deposited in its basin, it would raise the level of the water about 650 feet. If the surface of the lithosphere were brought to a common level by planing down all continental platforms and building up the deep parts of the ocean basins,

the ocean water would cover the whole of the earth to a depth of about 9000 feet, or nearly two miles.

**Mass.** The mass (weight) of the sea is only about five times the mass of the land above the sea, since water is much lighter than an equal volume of rock. The mass of the sea is about 265 times the mass of the air which surrounds it, and about  $\frac{1}{4500}$  of the mass of the solid part of the earth.

**Topography of the bottom.** The larger part of the sea bottom is so nearly flat that if the water were removed the eye would scarcely detect its departure from flatness. Its topography is therefore very different from that of the land. As already indicated, the agent which does most to roughen the surface of the land is running water, and rivers do not flow on the bottom of the sea. The most notable difference between the topography of the sea bottom and that of the land is due to their absence.

In spite of the prevailing flatness of the sea bottom, its relief is not less than that of the land. Its irregularities of bottom are of several types. These are (1) *volcanic cones*, often built up from the bottom of the deep sea to the surface of the water, and even far above it (Chap. VII); (2) *relatively steep slopes or scarps*, such as those at the junction of the continental platforms with the deep sea basins, and such as occur about some of the pronounced deeps; (3) *valley-like depressions*, found especially in the shallow waters about the borders of the continents; (4) pronounced *swells* which may be compared to the mountain ridges of the land; and (5) *broad, plateau-like areas* rising notably above their surroundings, over which the water is relatively shallow. The general configuration of the bottom of the Atlantic is indicated by Fig. 5.

1. Volcanic cones are wide-spread, but are more numerous in the Pacific Ocean than elsewhere, and more numerous in its deeper western part than in its shallower eastern part. Though such cones seem to rise abruptly, their slopes are really much less steep than they seem. The summits of volcanic islands rarely have a slope of more than  $30^\circ$ , and their lower parts rarely more than  $6^\circ$  to  $10^\circ$ . Below the sea the slope is still gentler, rarely more than  $3^\circ$ , or 1 mile in 20. Figs. 684, 685, and 686 show slopes corresponding to 1 mile in 5, 1 in 10, and 1 in 20.

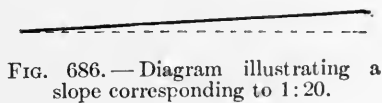
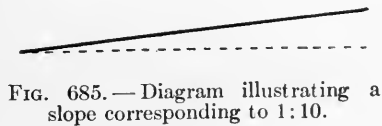
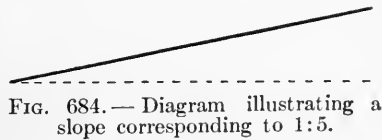

2. Though the slopes of the bottom at the edges of the continental shelves and about the deeps are steep, as slopes in the

ocean bottom go, they are much less steep than many slopes on the land. A slope of 1 mile in 8 is rare, and a slope of 1 mile in 20 (Fig. 686) can hardly be said to be common. The last would make a steep railway grade. Slopes of 1 in 60 are higher than the average steep slope at the edge of the continental shelves. Even up most of these "steep" slopes, therefore, railway trains could be run without change of grade.

In rare instances, slopes which would be regarded as very steep, even on land, are found on the sea bottom. Thus in the Mediterranean Sea, differences of 1500 feet are said to have been found between the bow and stern soundings. Such slopes or scarps are doubtless the result of faulting (p. 406).

3. Many continental shelves are affected by valleys which have the general characteristics of river valleys. Many of them seem to be continuations of valleys now in existence on the land. Thus, the Hudson, the Delaware, the Susquehanna, the St. Lawrence, the Saguenay, and other valleys have submerged continuations beneath the sea. The valley of the Hudson is continuous out to the edge of the continental shelf, where for 20 miles it becomes pronounced, with a maximum depth of 2400 feet below its surroundings, and 2844 feet below sea-level. Elsewhere it is shallow. The others are not so deep. The submerged continuations of the Delaware and the Susquehanna on the continental shelf are less than 100 feet below their surroundings, but those of the Saguenay and St. Lawrence, both of which extend out to the edge of the continental shelf, are much deeper.

Other submerged valleys, as some of those on the Pacific coast of the United States, do not seem to be the continuations of existing land valleys. Some of these valleys are hundreds of miles long and a thousand feet or more (maximum) deep. Such valleys are commonly believed to have been formed by rivers when the sea did not cover the areas where they exist (p. 173).

4. Examples of mountain-like swells are furnished by Cuba and the adjacent islands, which are really the crests of a great mountain system rising from deep water.

5. The plateau type of elevation is exemplified by the *dolphin ridge* of the Atlantic (Fig. 5). This broad, low "ridge," over which the water is less than 12,000 and sometimes as little as 5000 feet deep, traverses the Atlantic lengthwise, as far south as latitude 40° S., and divides its basin into two troughs, the one

to the east and the other to the west, where the water is somewhat deeper. In the southern Pacific, volcanic islands often rise from submerged plateaus.

From the foregoing it will be seen that great irregularities are found on the sea bottom as on the land, but that the many minor unevennesses of the land, especially those developed by running water, wind, glaciers, etc., find no analogies on the ocean's bed, except in shallow water.

## CHAPTER XXI

### COMPOSITION OF SEA-WATER

THE most distinctive characteristic of sea-water is its saltness; but besides common salt, it contains dissolved mineral matters of many other sorts. One hundred pounds of sea-water contain nearly  $3\frac{1}{2}$  (3.44) pounds of mineral matter. Of this mineral matter, common salt makes up more than three-fourths (about 77.758%). The other important minerals are magnesium chloride (10.878%), magnesium sulphate (4.737%), calcium sulphate (3.600%), potassium sulphate (2.465%), and calcium carbonate (.345%). Very many others occur in very small quantities. These mineral matters in the sea-water make it somewhat heavier than fresh water. If the weight of fresh water be taken as 1, the average weight of salt water is 1.026.

A cubic mile of fresh water weighs about 4,205,650,000 tons of 2240 pounds each, while a cubic mile of normally salt water weighs 4,314,996,900 tons. The mineral matter in a cubic mile of sea-water weighs about 151,025,000 tons. This, it will be seen, exceeds the difference between the weight of a cubic mile of fresh water and a cubic mile of sea-water. It follows, therefore, that a cubic mile of sea-water does not weigh the same as a cubic mile of fresh water plus the weight of the salts in the former. The reason is that when mineral matter is dissolved, it increases the volume of the water, but not by an amount equal to the volume of the mineral matter dissolved. If all the salts were taken out of the sea-water and removed from the ocean basins, the level of the sea would be drawn down more than 100 feet. If all the salts of the sea were taken out of solution and laid down as a layer of solid mineral matter on the ocean bottom, they would make a layer about 175 feet thick, and would raise the surface of the water (then without the salt) about 75 feet. If all the mineral matter now in solu-



tion in the sea were taken out of it, its aggregate volume would be equal to about one-fifth of the volume of all lands now above the sea-level.

**The mineral matter in solution.** Mineral matter is being constantly brought to the sea by rivers. The rivers are largely fed by springs, and the spring water, while underground, dissolves various sorts of mineral matter from the rocks, as we have seen (p. 96). The rivers are probably the chief source of the mineral matter in the sea, but the sea-water also dissolves mineral matter from the rocks beneath it. The amount of mineral matter carried in solution to the sea by rivers each year is estimated to be nearly half a cubic mile.

The rivers do not carry mineral matters to the sea in the proportions in which they exist in the sea-water. Of the minerals dissolved in river water, calcium carbonate is by far the most important, being nearly as abundant as all the rest, while common salt is one of the minor constituents, so small in amount as not to be detected by the taste. Yet the amount of the latter in the sea-water is more than 200 times that of the former. This great difference is one of the things to be explained.

It is to be noted that the mineral matters which are most abundant in the sea are not those which are most abundant in the rocks of the land. Those minerals of land rocks which are most soluble, such as calcium carbonate, get into river water, and thence to the sea, in greater quantity than those which are less soluble. Many minerals in the sea-water do not exist as such in the common rocks of the land, but are made by the combination of matter in the rocks with gases (especially  $\text{CO}_2$ ) in the air. Thus many volcanic rocks contain calcium in complex combinations. These complex compounds are broken up, and the calcium unites with the carbonic-acid gas of the air to form calcium carbonate. This is one of the prolific sources of this material carried by rivers to the sea. Again, common rocks do not contain salt, but some of them, such as granite, contain sodium, one of the elements of salt. When the sodium unites with chlorine, the result is salt. It takes much rock to yield a little salt. The great quantities of salt in the sea, therefore, must mean the decay of much greater quantities of rock.

Some mineral substances in the sea, on the other hand, are derived directly by solution from the rock. This is true of much

of the lime carbonate, which is the dissolved substance of limestone.

**Withdrawal of mineral matter from the sea.** Some of the substances in solution in the sea-water are extracted from the water by animals to make their shells, tests, etc. Most shells are made of calcium carbonate, but animals appear to be able to use the sulphate of calcium also in the making of their shells, transforming it into calcium carbonate. In spite of the abundant supply of calcium carbonate, therefore, the amount of this substance in the sea is relatively small, because animals, and some sea-plants as well, take it out to make shells and other hard parts about as fast as it is brought in. Silica also, though found in sea-water in small quantities only, is extracted by some animals and plants, as calcium carbonate is by others. Salt, on the other hand, is not used by any of the animals or plants of the sea, and so remains in solution, and most of all that has ever gone to the sea appears to be there still.

**A suggestion as to the age of the ocean.** At the rate at which salt is now being taken from the land to the sea by rivers, it would take some 370,000,000 years for the salt of the sea to have accumulated. It is by no means certain, however, that salt has always been carried in at the present rate, and it is certain that some of the salt which has been carried to the sea has been taken out again to make the great salt beds which occur in various parts of the earth. While, therefore, 370,000,000 years is not to be taken as the age of the ocean, it may give us some hint of the length of time during which it has been in existence.

**Gases in sea-water.** Besides the solids in solution in sea-water, there are numerous gases. The most abundant are those which exist in the air in abundance, namely, nitrogen, oxygen, and carbonic-acid gas. The amounts of these gases in solution vary from place to place and from time to time, but the averages of many analyses show that, of the total amount of gases in sea-water, nitrogen makes up about  $37\frac{1}{2}\%$ , oxygen about  $33\frac{1}{3}\%$ , and carbonic-acid gas about  $16\frac{1}{4}\%$ . In the aggregate, the amount of oxygen dissolved in the ocean water is rather more than  $\frac{1}{300}$  of the amount in the air; that of the nitrogen about  $\frac{1}{100}$ ; while that of the carbonic-acid gas is about 18 times the amount in the air.

The gases in the sea-water are dissolved chiefly from the atmosphere, in proportions determined by the pressure of each gas, by

its solubility, and by the temperature of the water. Gases are more soluble in cold water than in warm, and carbonic-acid gas is more soluble than oxygen, and this in turn is more soluble than nitrogen. Once dissolved at the surface, these gases are distributed through the ocean water by the movements of the water and by diffusion. Carbonic-acid gas is also furnished to the sea-water in abundance by the animals which live in the sea, and it issues from submarine volcanic vents.

The oxygen of the water is being constantly consumed by the animals which live in the sea, and its supply is being as constantly renewed by solution from the air. The amount in the sea-water decreases with increasing depth, and its paucity at great depths is probably one of the reasons why animal life is not more abundant there. Though constantly diffused downward, diffusion is a very slow process. The nitrogen of the water is little used, and the same nitrogen probably stays in solution from year to year and from age to age. The carbonic-acid gas of the sea is consumed by some of the plants of the sea, and some of that exhaled by the marine animals and volcanic vents escapes into the air. This is one of the sources of the carbonic-acid gas of the air.

The gases dissolved in the water do not greatly affect its volume, though they increase it slightly.

**Salinity, density, and movement.** The waters of different parts of the earth contain slightly different amounts of salt and other mineral matters. The variation comes about in different ways: (1) Evaporation is more rapid at some points than at others. Since the salts are left behind when sea-water evaporates, the water becomes more saline where evaporation is great. The greater the amount of mineral matter in solution, the greater the density of the water. (2) Where rainfall is great, the water is freshened and so made lighter. (3) Where rivers enter the sea, they bring in fresh water, which, mingling with the salt water, makes it lighter.

In all the above ways the salinity of the sea-water at the top of the ocean is being continually altered. Every alteration in salinity changes the density of the water, and unequal density causes movement. When the surface water becomes more dense than that beneath, it sinks, and the lighter water comes in over it from all sides. When the surface water becomes less dense than the surrounding water at the same level, the heavier water dis-

places the lighter, causing it to spread out on the surface, for the same reason that oil spreads on water. Since variations in the salinity of water are being constantly produced, motion due to inequalities of density resulting from inequalities of salinity, is also constant. Movements brought about in this way are partly vertical and partly horizontal. They are usually so slow as to be imperceptible, and may appropriately be called *creep*.

*Density of Water under Certain Conditions*

Pure water at 39.6° F. ....	1.00
“ “ “ 212° F. ....	.95
Surface sea-water at 60° F. ....	1.024 to 1.03
Sea-water five miles down. ....	1.06

**Salinity and color.** The water of the sea is generally blue or green, but its color varies from point to point and from time to time. It seems to be indicated by numerous observations that the blue color of sea-water is intensified by increase of salinity. The Gulf Stream is distinctly bluer than the less salty cold current off Labrador, and inland seas, such as the Mediterranean, which are more salty than the open ocean, are of deeper blue. The cold and less salty waters of high latitudes are often distinctly green. Many of the variations of color are due to the solid matter in suspension in the water. Microscopic animals and plants, and the sediment washed or blown out from the land or furnished by explosive volcanoes beneath the sea, all contribute to the observed variations.

## CHAPTER XXII

### THE TEMPERATURE OF THE SEA

THE temperature of the sea is to be considered both horizontally and vertically. In other words, account must be taken of the temperature both at the surface and beneath it.

**Temperature of the surface.** In general, the temperature of the surface of the ocean water decreases from the equator toward the poles, the same as the temperature of the land (Fig. 538). It varies from about 80° F. in the equatorial regions, to about 28° F. in the polar regions. When the temperature sinks below the latter figure, the sea-water freezes, and the temperature of the surface of the ice may sink as low as the temperature of the air above it; but the temperature of the water immediately beneath the ice does not sink much below 28° F. The decrease of temperature with increase of latitude is by no means regular, as shown by the isothermal charts. In Figs. 539 and 540, for example, the isothermal lines over the ocean are far from parallel with the parallels of latitude.

The notable departures of the ocean isotherms from the parallels of latitude are due to various causes. In the open ocean they are due chiefly to currents in the ocean water. Some of these currents are of water which is flowing into waters warmer than themselves, and some are of water flowing into waters cooler than themselves. The former are known as *cold currents*, and the latter as *warm currents*. A cold current deflects an isotherm equatorward, and a warm current deflects it poleward. Fig. 539 furnishes a good illustration of the effect of a warm current in the North Atlantic on the position of the isotherms.

There are other reasons why the temperature of the surface water of the ocean does not decrease steadily from equator to poles. Thus rivers entering the sea are sometimes (especially in

summer) warmer and sometimes (especially in winter) colder than the sea-water where they enter. Rivers, therefore, help to produce irregularities of surface temperatures. Enclosed or partially enclosed arms of the sea in low latitudes are generally warmer than the open ocean in the same latitude, and in such situations the highest temperatures of the sea are found. Thus the surface temperature of the Red Sea is sometimes 90° or even 100°.

**Temperature and movement.** Since water expands on being warmed, warm water is lighter than cold, if both are equally salt. Unequal surface temperatures therefore cause movement of the surface waters. The tendency of the resulting movement is to cause the colder waters of the higher latitudes to displace the warmer waters of the same level in lower latitudes, while the warmer waters of the latter zone spread widely over the surface. The movement is, therefore, circulatory. The movements due to this cause are always slow, but since the surface temperature is constantly kept unequal by unequal heating, by the inflow of rivers, and by melting ice, there must be constant movement of the surface waters as a result of the constantly renewed inequality of temperature.

The surface of the sea is subject to both seasonal and daily changes of temperature. Both are much less than the corresponding changes on land in the same latitude (p. 530).

**Temperature beneath the surface.** Except where the surface waters of the sea are at or near the freezing-point, the temperature becomes cooler with increasing depth. Even where the surface water is warmest, its temperature at the depth of a few hundred fathoms (rarely more than 800, and generally much less) is below 40° F., and that at the bottom still colder. The following table shows the average temperature of the sea at various depths:

Depth.	Temperature.
600 feet	60.7°
1,200 "	50.0°
3,000 "	40.1°
6,000 "	36.5°
13,200 "	35.2°

It is estimated that not more than one-fifth of the water of the ocean has a temperature as high as 40° F., while its average temperature is probably below 39° F. At the bottom of the deep sea

the temperature is generally below 35° F. The only parts of the ocean-bottom where the temperature is as high as 40° F. are the areas of shallow water and the enclosed seas of relatively low latitudes. Such areas do not constitute more than 8% of the area of the sea. Fig. 687 represents a temperature curve for the South Atlantic, and is fairly typical for the ocean in general. Fig. 688 shows a similar curve for the North Atlantic, and Figs. 689 to 691 show the temperature curves for other places.

The temperature of the sea does not everywhere decrease steadily from the surface down, for there are more or less well-defined currents beneath the surface, sometimes warmer and sometimes colder than their surroundings. Such currents introduce

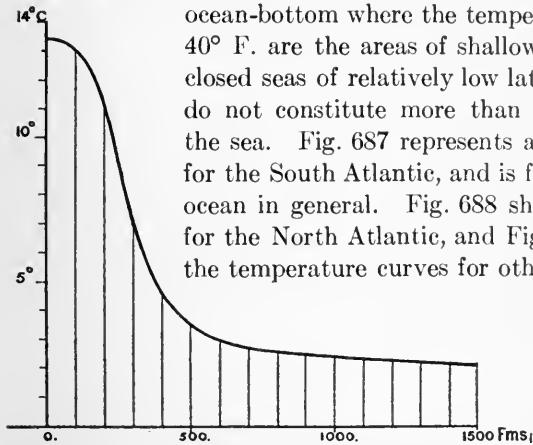

FIG. 687.—A temperature curve in the South Atlantic; latitude 35° 59' S., longitude 1° 34' E. (Challenger Report.)

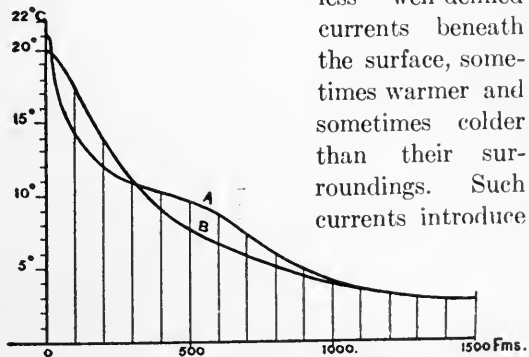

FIG. 688.—Temperature curves for the North Atlantic; A, latitude 33° 46' N., longitude 19° 17' W.; B, latitude 24° 20' N., longitude 24° 28' W. (Challenger Report.)

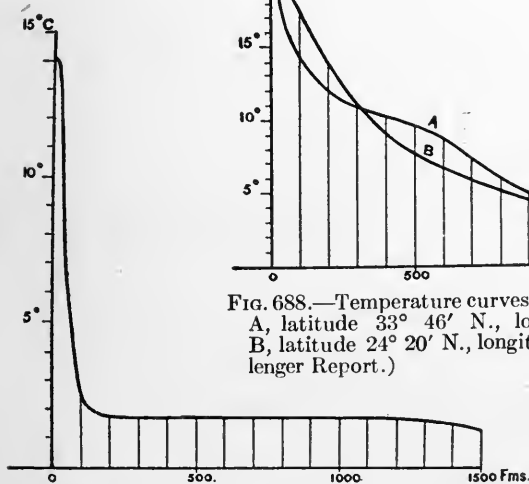

FIG. 689.—Temperature curve for the South Atlantic, where the water is affected by the Antarctic current; latitude 42° 32' S., longitude 56° 27' W. (Challenger Report.)

irregularities into the temperature curves (Fig. 692).

The temperatures of the deeper parts of enclosed seas in low latitudes present striking contrasts to the temperatures of the

deeper parts of the open sea. Thus the temperature of the Red Sea decreases from 90° F. or more at the surface, to 70° F. at a depth of 1200 feet, and then remains nearly constant to the bottom at 3600 feet. In the Mediterranean, the temperature falls from about 75° F. at the surface to 55° F. at a depth of 750 feet, and then remains essentially constant to the bottom, 13,000 feet, while the temperature of the ocean outside falls to 37° F. in its deeper parts. The high temperature of the deep waters of these enclosed seas is due to the submerged barriers which partially shut them off from the ocean, and do not allow the colder and therefore denser waters outside to flow in and displace the warmer and lighter waters below the top of the basin (Fig. 693). The temperature of the bottom of enclosed seas is, in general, approximately the

temperature of the adjacent open-sea water at the level corresponding to the top of the submerged barrier.

The phenomena of these and other similarly situated basins show that the sun shining on an enclosed body of water may, in the course of time, warm it to the

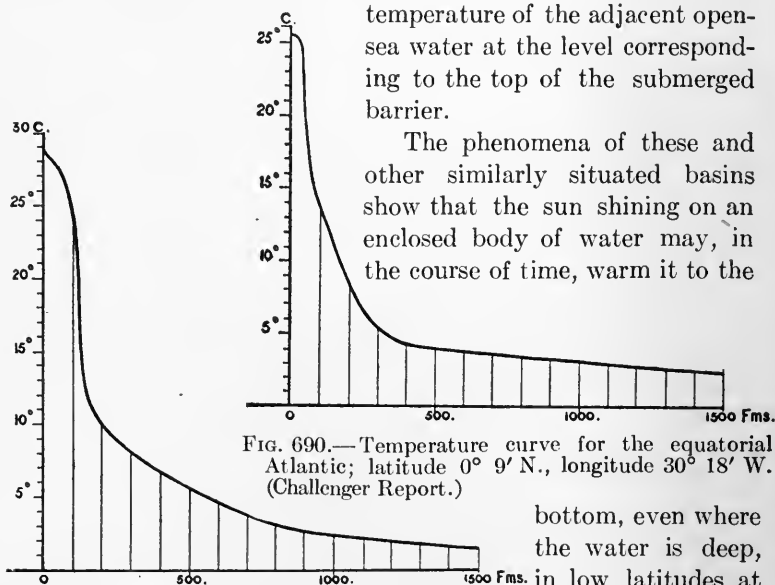

FIG. 690.—Temperature curve for the equatorial Atlantic; latitude 0° 9' N., longitude 30° 18' W. (Challenger Report.)

FIG. 691.—Temperature curve for the equatorial Pacific; latitude 0° 40' N., longitude 148° 41' E. (Challenger Report.)

bottom, even where the water is deep, in low latitudes at least. The low temperature of the body of the ocean is not,

therefore, due to the inability of the sun to heat it.

The reasons for the low temperature of the great body of the sea-water are readily understood. 1. The heat of the sun has little direct effect below some such depth as 200 to 300 feet, and none at all below 600 feet. Taken alone, this does not account



for the low temperature of the body of the ocean, as the phenomena of the enclosed basins show, but it is one of the elements of the prob-

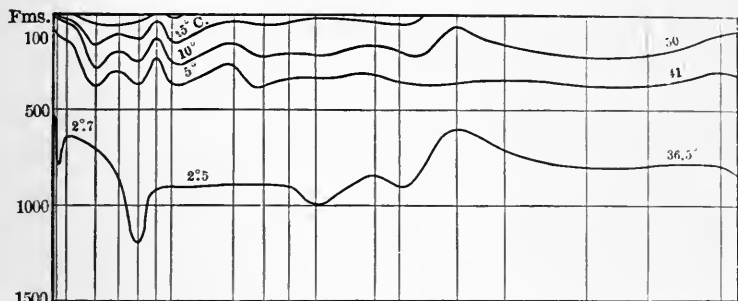

FIG. 692.—Temperatures in the South Atlantic between Falkland Islands, Rio de la Plata, Tristan d'Acunha Islands, and Cape of Good Hope. (Challenger Report.)

lem. The sun has been shining long enough to have warmed the ocean to its bottom, even by the slow (in water) process of conduction. 2. The bottom of the sea, though warmed by conduction from the lithosphere below, is warmed with extreme slowness.

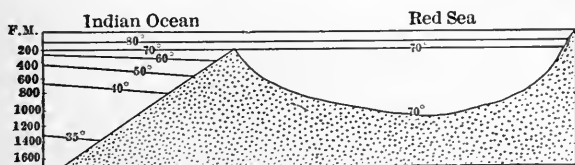

FIG. 693.—Diagrammatic section of Red Sea and the adjacent part of the Indian Ocean, to illustrate the effect of a barrier on the temperature of the waters. The temperature is expressed in degrees Fahrenheit. The numbers at the left show depth in fathoms.

As its temperature rises, the expanded water is crowded up by the colder, heavier water which gets beneath it. 3. The cold waters of the surface, whether produced by contact with the cold air or by the melting of ice and snow, tend constantly to sink. The supply of ice-water from the polar regions, especially from the Antarctic region, is very great, and though that which comes from the land is fresh, and therefore lighter than sea-water at the outset, it soon becomes salt by diffusion and by mixing with salt water. This enormous supply of ice-water is the great cause of the low average temperature of the sea. Without the polar ice-caps, the average temperature of the ocean would in time be raised perceptibly.

If the ice-caps were melted, it would probably go far toward restoring the genial climates of earlier times in high latitudes, when temperate and even subtropical plants and animals lived in Greenland and in Antarctica.

The temperature below the surface is ascertained by a thermometer constructed for this especial purpose. Its chief peculiarity is such construction as will enable it (1) to withstand the great pressure of deep water without having the position of the mercury in the tube influenced seriously by it, and (2) to register the temperature of any desired depth. Since the pressure in the sea increases a ton per square inch for a little less than a mile of descent, it will be seen that the ordinary thermometer used in the atmosphere would not be serviceable. A satisfactory thermometer was not devised until 1869, just before the departure of the Challenger expedition.

**The ice of the sea** has been referred to in other connections (pp. 210 and 269).

The movement of floating ice is controlled partly by the winds, and partly by the movements of the water in which the ice is floating.

## CHAPTER XXIII

### THE MOVEMENTS OF SEA-WATER

#### *Causes of Movement*

WE have seen that inequalities of density in sea-water arise chiefly from (1) unequal salinity, and (2) unequal temperature, and that these inequalities taken by themselves insure a constant, though slow, circulation of the waters of the sea. There are other causes, also, which produce movement. Chief among them are (3) inequalities of level, (4) the wind, and (5) the differential attraction of heavenly bodies, especially the moon and the sun. There are also (6) occasional causes, such as earthquakes, volcanic explosions in the sea, landslides on coasts, etc., which produce temporary and sometimes disastrous movements. The effect of (1) and (2) have been noticed already (pp. 719 and 722).

**Movements due to inequalities of level.** The inequalities of level which produce movement are brought about by (1) the inflow of land waters, which raise the surface at the point of inflow; (2) winds, which tend to pile up the waters along the shores against which they blow; (3) unequal rainfall, which tends to raise the surface where it falls; (4) unequal evaporation, which tends to lower the surface where it is excessive; and (5) variations in atmospheric pressure, the surface of the water being slightly depressed where atmospheric pressure is excessive.

All such inequalities of level in the surface of the sea cause movement. The movement begins as soon as the inequality of surface appears, and before it becomes considerable. The result is that the movements due to differences of level are generally slow. So far as they are due to rainfall, to inequalities of evaporation and to atmospheric pressure, they are generally imperceptible. The movement occasioned by the inflow of rivers is more noticeable, and is often distinctly felt for some distance off

shore. When waters are piled up against a shore by winds, there is sooner or later a return movement which tends to make the surface level again. During a storm on the coast of India in 1864 (Oct. 5), the water was raised 24 feet at Calcutta, drowning 48,000 people. The raising of the surface of the water was the most destructive element in the storm at Galveston, already referred to (p. 654).

Since the several causes producing inequalities of level are in constant operation, it follows that movements due to inequalities of level are constant.

It will be recalled that there are other inequalities of level, due to the attraction of land masses (p. 708). These inequalities are in some sense permanent, and therefore do not produce circulation of the sea-water.

**Movements due to the wind.** Winds not only produce temporary inequalities of level, as indicated above, but they affect the water in other and important ways. Their most familiar effect is in the generation of waves, but they also drag the water along beneath themselves. If a floating solid is dragged rapidly through the water, the water about it moves, and that immediately beneath the object moves faster than that farther below. If the object were so light as to sink but little into the water, there would still be movement of the water beneath because of the friction at the plane of contact. The air, though not a solid, acts in the same way. When it moves rapidly over water, it drags the surface water along with it.

Since winds are always blowing, the movements to which they give rise are always taking place. When winds have a more or less constant direction, as in the zone of trades, there must be a somewhat constant movement of the surface water in the same direction. A constant movement in one direction necessarily involves a return movement, that is a *circulation*, of the sea-water.

**Movements due to differential attraction of sun and moon.** Another cause of movement in sea-water is found in the attraction of bodies outside the earth, especially the sun and moon. Bodies attract each other in proportion to their masses, and inversely as the squares of their distances; that is, a body twice as massive as another has twice the attractive force *at the same distance*, and if one of two bodies of a given mass be twice as far

from a third body as the other is, their attractive forces on the third are to each other as  $\frac{1}{4}:1$  ( $\frac{1}{2}^2:1$ ).

The side of the earth towards the moon is nearer to the moon than the center of the earth is, and so is attracted more strongly than the center. The opposite side is attracted less strongly. Because of these inequalities of attraction, the mobile waters on the earth's surface are disturbed. The attraction of the sun produces similar but less pronounced effects. These inequalities of attraction of moon and sun on different parts of the earth are the cause of the movements known as *tides*.

**Movements due to occasional causes.** The aperiodic and more or less accidental causes of movement which belong in this class often produce violent wave movements which last but a short time. Illustrations of their nature and effects have already been given in connection with earthquakes. Landslides along the coast, submarine volcanic eruptions, etc., also occasion violent but temporary movements of the water of the sea.

### *Types of Movement*

The general types of movement resulting from these various causes are (1) *waves*, with their accompanying *undertow*, and *shore* or *littoral currents*, (2) *ocean currents*, (3) *drift* (slow ill-defined currents), (4) *tides*, and (5) *creep*. The first two and the fourth are more obvious than the third and fifth, and the importance of the less obvious is often overlooked.

### *Waves*

The nature and the work of waves has already been outlined (p. 318). Since the water in waves does not commonly move forward, waves do not involve a general circulation of the ocean water. In addition to what has been said concerning the work of waves, it may be added that in the aggregate the sea destroys more land by erosion than it makes by deposition, so that if nothing else interposed, the sea, by its continued gnawing at the shores, would ultimately destroy all land. It has already been pointed out that wave erosion tends to do away with large irregularities of coasts, though not with small ones (p. 320). In the long run, too, deposition along coasts tends to develop regularity of outline, but temporarily the coasts are often made very irregular (p. 328). On the whole, the final effect of coastal activities is to make the

coasts more regular if they have any considerable irregularity at the outset.

### *Currents*

Experience and observation have shown that there are more or less distinct currents in various parts of the ocean. This became known first through the effect of the moving water on the courses of sailing vessels, and it was later confirmed in various other ways, as by following the course of floating bottles.

The better-known currents are at the surface, extending down to depths of several hundred feet; but there are also currents beneath the surface, as shown by variations of temperature and by some other phenomena. Ocean currents are much less well defined than currents of running water on the land, because the former flow through a liquid, while the latter flow over a solid bed between solid banks. These currents of the ocean are the most distinct feature, though not the only one, of the oceanic circulation, which has already been referred to.

Fig. 694 shows the general course of movement of the surface waters of the seas. The figure represents a large part of the surface water as involved in movement. There is a westward movement of surface water in low latitudes in both the Atlantic and the Pacific oceans. These are the *equatorial currents* or *drifts*, as they are sometimes called. In each ocean the drift is double, and a narrow counter-current moves eastward between them. The equatorial current of the Atlantic is divided as South America is approached, one part being deflected to the southwest and the other to the northwest. A part of the latter flows through the Caribbean Sea and into the Gulf of Mexico. From this Gulf a distinct current issues through the narrow passageway between Cuba and Florida. This is the *Gulf Stream*. It is fed partly by the water which enters the Gulf from the equatorial drift, and partly by the large amount of water which enters the Gulf from the land, thus tending to raise the level of the water. The stream issuing from the Gulf has a velocity of more than four miles per hour where it is swiftest.

Escaping from its narrow passageway between Florida and Cuba, the Gulf Stream becomes wider and deeper. The current tends to drag along the mobile water beneath and beside it, and as more water becomes involved in the movement, the rate of progress

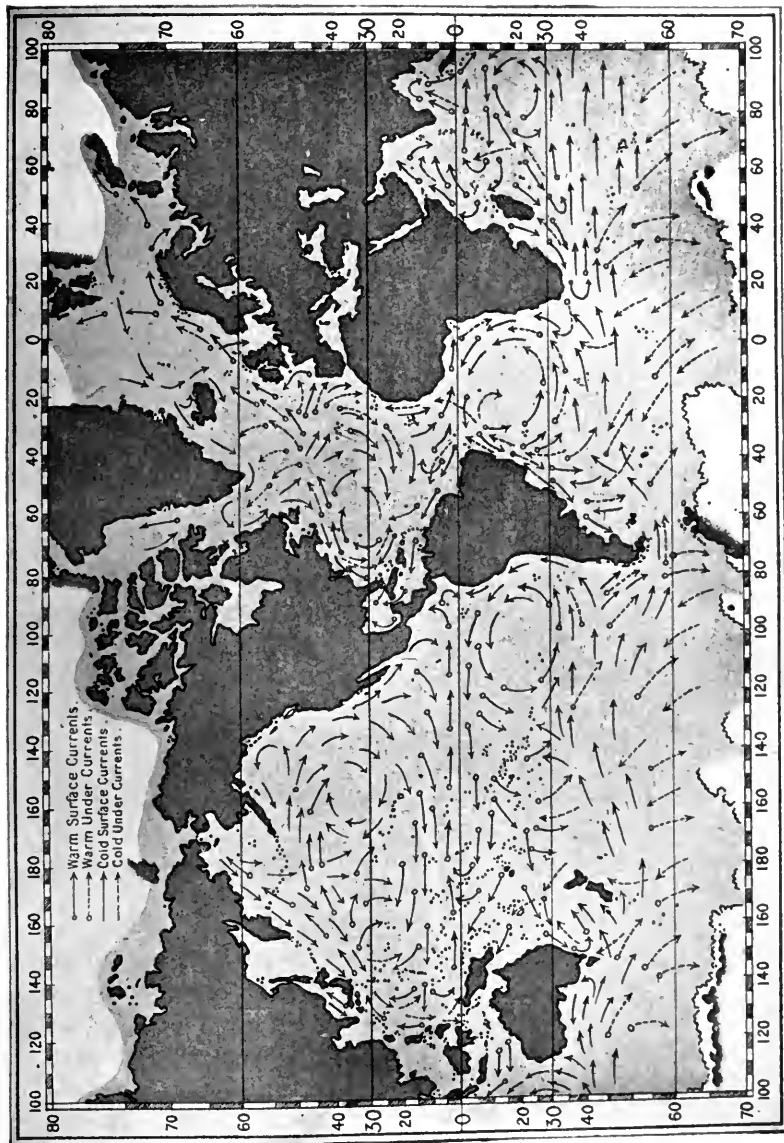

FIG. 694.—The courses of the ocean currents. (After Wild.)

becomes slower, and in the open ocean the rate of movement is perhaps no more than 10 to 15 miles per day. As the current becomes slow, its boundaries become less well defined. In the open ocean it is detected by its temperature, its color, its life, etc., more readily than by its motion.

After leaving the Gulf, the Gulf Stream manifests a pronounced tendency to turn to the eastward. Following this tendency, it crosses the Atlantic, approaching the coast of Europe in a latitude higher than that where it leaves America. Here it divides and spreads widely. Long before this point is reached, it has ceased to be a definite stream, and is to be looked upon rather as a general, wide-spread *drift* of water.

That part of the equatorial drift which is turned southward on the coast of South America first follows the coast of that continent, but soon shows a tendency to turn to the left (Fig. 694).

The equatorial drifts of the Pacific follow similar courses. The part corresponding to the Gulf Stream of the Atlantic is known as the Japan Current. The Indian Ocean has a south equatorial drift only, and its course corresponds to that of the southern part of the corresponding drifts of the other oceans.

All currents or drifts moving poleward from the equatorial region consist of warm water moving into cooler water, and they are known as *warm currents*.

The poleward movement of warm currents necessitates a return equatorward movement, and this movement is strengthened by the inequalities of temperature in high and low latitudes. The cold waters moving equatorward are deflected to the right in the northern hemisphere and to the left in the southern, and the tendency of this deflection is to concentrate them on the eastern coasts of the continents in both hemispheres.

The equatorward currents start from latitudes where ice abounds. They are cold, but not so salt (in summer) as normal sea-water. By virtue of their temperature, therefore, they would be denser than average sea-water; but by virtue of their deficiency of salt, they tend to be less dense than normal sea-water. As they flow equatorward, they become warmer and more salt, and finally attain such a degree of salinity that they sink and continue their courses toward the equator as cold undercurrents. On the other hand, the poleward (warm) currents start in low latitudes as surface currents, kept at the surface by their high temperature in



spite of their slight excess of salt. But in their poleward journey, they may sink beneath the cooler though fresher water, and continue as warm undercurrents. Undercurrents of both the types cited have been detected.

**Cause of ocean currents.** The equatorial drifts in the Atlantic and Pacific oceans correspond somewhat closely, both in position and direction, with the trade-winds. It is now generally believed that winds which are constant in direction will cause a general movement of the surface waters beneath them. It therefore seems rational to infer that the equatorial currents or drifts are generated by the trade-winds. The effect of the westward-moving equatorial currents is to bank up waters on the east coasts of the continents, especially South America. Some of this water moves eastward between the main west-bound currents, and constitutes the narrow *counter* current of the equatorial calms. This current of warm water is felt on the coast of Africa.

In extra-tropical latitudes the winds are less constant, and therefore less effective in generating currents. But in regions of strong monsoon winds, as about India, the drift of the surface waters changes with the shifting winds, thus showing the competency of winds to generate surface movements.

Were the ocean universal, the westward drift of the equatorial waters under the influence of the trade-winds would doubtless correspond with the trade-winds themselves; that is, they would encircle the earth. But where the waters of this equatorial drift reach a continent, as, for example, South America, they are deflected from their westerly course.

After the moving waters pass out of the control of the trade-winds, they are directed (1) by the continental borders, (2) by the configuration of the ocean bottom, (3) by the prevailing winds of the latitudes which they reach, and (4) by the rotation of the earth. Their courses are therefore determined partly by the causes which *generate* them, and partly by other causes which *direct* them.

Another factor which is of importance in the development of ocean currents is inequalities of temperature. This alone would not give rise to distinct currents, but movements thus generated (p. 722) may be concentrated and directed so as to emphasize the currents generated by the winds.

**Climatic effects of ocean currents.** The air over a warm ocean current is warmed by contact with the warm water. In

middle latitudes the prevailing westerly winds carry the warmed air over to the coasts of the continents to leeward, giving them, in winter, temperatures higher than they would otherwise have, and giving them, at the same time, an abundant supply of moisture. The winter temperature of the west coast of northern Europe is much less severe than it would be but for the Gulf Stream.

The amount of heat which the Gulf Stream carries northward from low latitudes has been estimated by Croll to be "one-fourth of all the heat received from the sun by the North Atlantic, from the tropic of Cancer up to the Arctic Circle." Its benefit, so far as the land is concerned, is primarily to Europe.

The similar warm current in the North Pacific lessens the severity of the winter climate of the northern part of western North America. Similar results would be seen in the southern hemisphere, were there land so situated as to feel the effects of the corresponding currents in the southern oceans.

One other atmospheric effect of currents should perhaps be mentioned. When the wind blows over a warm current, such as the Gulf Stream, it is warmed and takes up a goodly supply of moisture. On blowing from the current over colder water, its temperature is lowered, and some of its moisture may be condensed. The result is often a fog. Fogs are common along the leeward side of the Gulf Stream, in latitudes where the adjacent land or water is much cooler than the current itself. Fogs are more abundant in the latitude of Newfoundland than farther south, because the difference in the temperature of the Gulf Stream and its surroundings is here greater than farther south. Fogs also occur about the Gulf Stream when there is no wind. This appears to be due to the chilling of the warmer air by proximity to cooler air above or on either side.

Fogs, often grading into mist or into clouds which yield rain, are rather common in the northwestern parts of North America and Europe, especially in the cold season.

**Gradational effects of ocean currents.** Currents have relatively little effect on the ocean bottom, and almost none on coasts, because they rarely touch either. Where the water is shallow, however, as between Florida and Cuba, the Gulf Stream reaches and scours its bottom effectively, somewhat as a great river might. Since ocean currents do little eroding, except locally, they carry but little debris. They do, however, transport considerable quantities

of matter of organic origin. The waters, especially of warm currents, teem with minute organisms, and these organisms, or their shells after the organisms are dead, are often carried far, and finally scattered over the bottom of the ocean.

**Historical suggestions.** The currents of the Atlantic played an important part in the early history of America. Once Iceland was colonized by the Northmen, the currents southwest from the Arctic insured the early discovery of North America. The south equatorial current carried the Portuguese, bound for India, in 1500, to the shores of South America.

### *Tides*

The level of the ocean water rises and falls twice every day, or, more exactly, every 24 hours and 52 minutes. This periodic rise and fall of the water constitutes the *tides*. The tide rises (*flood-tide*) for about six hours, when it is *high*, and then falls (*ebb-tide*) for about six hours, when it is *low*.<sup>1</sup> The tide often "comes in" as a series of waves, the water after each wave failing to sink to its former level. In other cases it rises quickly, without distinct waves.

Tides are not perceptible in the open ocean, for there is nothing there to mark the slight rise of water; but they are readily seen wherever there is an island on the shores of which the rise and fall may be measured. The rise in the open sea has been estimated to be two to three feet. Along coasts, the variation in the water level between high and low tides is generally several feet. In bays which open broadly to the sea but narrow toward their heads, the range is sometimes 20 or 30 feet, or in rare cases 50 feet or more, as in the Bay of Fundy. Where the tide runs in among islands or passes through narrow straits, it often gives rise to distinct currents which scour the channels through which they flow.

The tide sometimes runs up a broad open river. As it advances up the channel, its progress is retarded by the shallowness of the water, and its front may become a steep and often wall-like wave. Such a wave is called a *bore*. The bore is felt in the Severn and the Wye of England, in the Seine of France, in the Petit-Codiac of Canada, in the Hugli of India, and the Tsien-Tang-Kiang of China. In the last-named river the waves are some-

<sup>1</sup> The ebb-tide is usually somewhat longer than the flood-tide.

times 25 feet high, and are disastrous to navigation. On one occasion, Captain Moore estimated that  $1\frac{1}{4}$  million tons of water went by a point in the river in a minute in the bore wave. Trading ships at Calcutta formerly hastened to the middle of the stream for safety on the approach of the bore.

Bores do not appear, even in the rivers subject to them, with every high tide. Favoring winds seem to be an important factor in their development, and they are stronger in *spring tides* (p. 744) than at other times.

High tides make themselves felt, though not as bores, up the Hudson River to Troy, where the range of the tide is more than two feet, and up the Delaware nearly to Trenton, though the salt water does not run up so far. The sea-tide raises the sea-level at the debouchures of these streams, and so dams back their waters. The tide runs 70 miles up the St. Johns River in New Brunswick, and is felt where the elevation of the river is 14 feet above mean sea-level. The tide runs up the estuary of the St. Lawrence 283 miles to Three Rivers, near Montreal.

Tides are imperceptible in small lakes and feeble in large lakes and enclosed seas. In Lake Michigan, for example, there is a tide of about two inches. Tides are feeble in all bodies of water connected with the open sea by a narrow passageway. Thus, at Galveston in the Gulf of Mexico, the range of the tide is less than one foot.

In many harbors, especially where the water is shallow, the rise and fall are enough to have an important effect on navigation. Vessels arriving at such harbors at low tide are often obliged to wait until high tide before entering. Tidal currents or *races* are sometimes so strong as to interfere with navigation. The race through Hell Gate near New York City is a case in point.

**The periodicity and the cause of tides.** The time between successive high or successive low tides is about half the time of the apparent revolution of the moon around the earth. It appears to have been this fact which suggested a connection between the tides and the apparent motions of the moon, a connection which was known, or at any rate suspected, some 2000 years ago, though not fully understood until the time of Newton, about 200 years ago.

The law of attraction between heavenly bodies has already been stated (p. 729). Without attempting to give a detailed explanation of the tides, the essential principles involved may be

readily understood.<sup>1</sup> We may consider first the tide produced by the moon.

If a weight be attached to a string and whirled, the string is put under tension. The weight constantly tends to move forward in a straight line, but it is prevented from doing so by the string. The tendency of the weight to depart from the circle in which the string holds it, is often called *centrifugal force*, though it is only inertia. The pull of the string which holds the weight is a *centripetal force*. The taut string therefore is affected by two opposite and equal forces.

The motion of the moon about the earth is not unlike the motion of the weight at the end of the string in the above illustration. In place of the string there is the attraction of gravitation, and the moon goes about the earth at such a rate that her centrifugal tendency is just balanced by the attraction of the earth. The center about which the moon revolves is not, however, the center of the earth but their common center of gravity. Since the earth is about 80 times as massive as the moon, the center of gravity of the two bodies is much nearer the center of the earth than the center of the moon. It is, in fact, 1000 miles below the surface of the earth, and 3000 miles from its center (Fig. 695). Both the moon and the earth revolve about this common center, as they travel together about the sun. The earth's center describes a circle with a radius of 3000 miles about the common center of gravity, while the moon describes a circle with a radius of about 237,000 miles about the same point. The conception may be made more definite by conceiving two very unequal weights at the opposite ends of a stiff but extremely light rod. These weights may be such that the two will be balanced, if the point corresponding to *g*, Fig. 695, is supported. If now the couple (*E* and *M*) be rotated, the center of *E* will rotate about *g* in a small circle, while the center of *M* will rotate about it in a much larger circle, each in about 28 days.

The earth and the moon attract each other and would fall together, but for the centrifugal tendency developed by the revolution. The distance of the two bodies from each other is determined by the balance between (1) their mutual attractions

<sup>1</sup> For further accounts of the tides, see the astronomies referred to on p. 505.

on the one hand, and (2) their centrifugal tendencies on the other. This balance is perfect at the center of the earth and at the center of the moon. But on the side of the earth nearest the moon the attraction is somewhat stronger than at the center of the earth, and overbalances the centrifugal tendency. *The attraction therefore tends to make the earth bulge up under the moon.* On the opposite side of the earth the attraction is weaker than at the center,

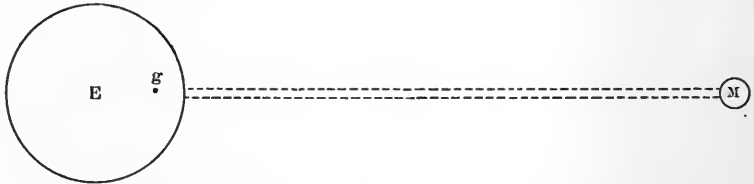

FIG. 695.—Diagram showing the position of the center of gravity, *g*, of the earth-moon system.

and is overbalanced by the centrifugal tendency. Here, also, there is therefore a tendency for the earth to bulge out, as a result of the differential attraction of the moon. If the mass of the earth were fluid, these bulgings or tides would be sensible. But the solid part of the earth is essentially rigid, and there is not time for its parts to yield sensibly to the strain set up by the differential attraction of the moon, before rotation carries them forward where there is no tendency to bulging. The surface waters, however, are mobile and respond to the distorting effect of the moon's differential attraction, with the result that the water is bulged up on opposite sides of the earth, so as to produce a slight elongation of the earth's diameter in the direction of the moon. These bulges of water are the *high tides*, and between them the tides are *low*.

The fact of the differential attraction of the moon may be stated in other terms. The distance of the center of the moon from the center of the earth is about 240,000 miles. The side of the earth nearest to the moon is therefore about 236,000 miles from the center of the moon, while the side farthest away is about 244,000 miles distant.

If the mass of the moon be taken as 1, the average pull of the moon on the earth is represented by the fraction  $\frac{1}{240000^2}$ . The fraction which represents the moon's pull on the side of the earth

nearest the moon is  $\frac{1}{236000^2}$ , and the fraction which represents the pull on the opposite side is  $\frac{1}{244000^2}$ . The solid part of the earth acts essentially as a unit, since its parts are not free to move on one another. The effect of the attractive force of the moon on the solid part of the earth is therefore essentially the same as it would be if it were all exerted on its center, that is, the same as the average pull of the moon on the earth,  $\frac{1}{240000^2}$ .

Since the waters on the surface are readily mobile, they respond to the differential attraction of the moon. The waters on the side nearest the moon, being pulled with a force stronger than the average pull on the solid part of the earth, are bulged up a little. The force of the moon's pull here is represented by the fraction  $\frac{1}{236000^2}$ , and  $\frac{1}{236000^2} - \frac{1}{240000^2}$  represents the moon's tide-producing force on the side of the earth nearest to it. The waters on the opposite side of the earth are farther from the moon than the center of the earth is, and so are pulled less strongly than the latter, and are allowed to bulge out. Mathematically the force on the side of the earth most distant from the moon is  $\frac{1}{244000^2}$ , and the tide-producing force there is  $\frac{1}{240000^2} - \frac{1}{244000^2}$ . The result is a rise of water on opposite sides of the earth at the same time. These are the *high* tides. Midway between the places where the tides are high the water is correspondingly lowered and the tides are *low*.

It will be seen from the above figures that the tide-producing force on the side of the earth away from the moon is slightly less than that on the side nearest the moon:

$$\frac{1}{240000^2} - \frac{1}{244000^2} < \frac{1}{236000^2} - \frac{1}{240000^2}.$$

The explanation of the tides is sometimes so troublesome that another statement of their cause is added:

"Let  $E$  (Fig. 696) represent the center of the earth, and  $M$  the moon. (The distance of the moon is greatly minimized.) Consider the tendency of the moon to displace the particle  $P$  on the surface of the earth. Let  $\overline{EB}$  represent the acceleration of  $M$  on

$E$  (the solid earth) in direction and amount. In the same units let  $\overline{PA}$  represent the acceleration of  $M$  on  $P$  in direction and amount. Since  $P$  and  $M$  are nearer together than  $E$  and  $M$ , it follows that  $\overline{PA}$  is greater than  $\overline{EB}$ .

Let the acceleration  $\overline{PA}$  be resolved into two components so that one of them shall be equal and parallel to  $\overline{EB}$ . It is  $\overline{PK}$  in the figure. The other component is found by using  $\overline{PA}$  as a diagonal and  $\overline{PK}$  as a side, and completing the parallelogram. It is  $\overline{PQ}$  in the figure. By the law of the parallelogram of forces  $\overline{PA}$  is exactly equivalent to  $\overline{PK}$  and  $\overline{PQ}$ , and conversely. By the preliminary theorem,  $\overline{EB}$  and  $\overline{PK}$  being parallel and equal do not

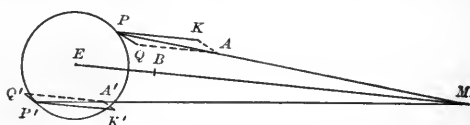

FIG. 696.—Diagram to illustrate the cause of tides. Explanation in text. (From Moulton's Introduction to Astronomy. By permission of The Macmillan Company.)

tend to change the relative positions of  $E$  and  $P$ , and therefore cause no tide. The remaining acceleration  $\overline{PQ}$  cannot be paired with any other, and is the tide-raising acceleration.

The part of the figure with accents is drawn from precisely the same principles.  $\overline{P'K'}$  is parallel and equal to  $\overline{EB}$ , and  $\overline{P'Q'}$  is the tide-raising acceleration.

Suppose figures are constructed for points all the way around the earth. The lines representing the tide-raising accelerations will be as given in Fig. 697. The method of drawing them is the

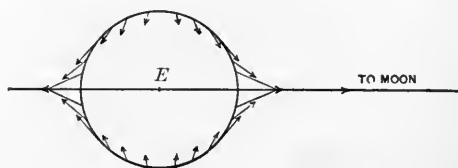

FIG. 697.—Diagram to illustrate tides. (From Moulton's Introduction to Astronomy. By permission of The Macmillan Company.)

geometrical counterpart of the rigorous mathematical treatment of the subject, and may be relied upon as giving the full explanation of the reason for the tides."<sup>1</sup>

<sup>1</sup> Moulton's Introduction to Astronomy.



**Tides if the ocean were universal.** If the earth were completely covered with a deep ocean, its surface would have two extensive tidal bulges or waves at the same time. The highest part of each would be a point, the one directly under the moon, and the other directly opposite it. Each wave would be hemispherical, and their borders would meet in a great circle, where the tide would be low. This circle may be conceived of as the trough of the tidal wave.

The period of the earth's rotation is shorter than that of the revolution of the moon about the earth. The result is that rotation tends to carry the high tides on beyond the position which the moon would give them. The moon tends to hold them back, and so they seem to travel about the surface of the earth in a direction opposed to its rotation. The tides are therefore said to *lag*.

Theoretically, successive high tides are  $180^\circ$  (12 hours) apart, and rotation of the earth alone considered, high tides at any place should recur every 12 hours. The longer period (12 hrs. 26 min.) is the result of the forward movement of the moon in its orbit about the earth (Fig. 698).

There are two points, *the tidal poles*, where the tide does not rise and fall. When the moon is vertical at the equator, it will be seen that the highest point of the high tide should be on the equator continuously, and that the great circle marking the position of the low tide will pass through the geographic poles. The poles will therefore have low tide continuously so long as the moon is vertical at the equator. Whatever the latitude where the moon is vertical, there will be a point, *the tidal pole*,  $90^\circ$  from the latitude where the moon is vertical, where there would be no rise and fall of the tide. Since the latitude where the moon is vertical varies from time to time, the position of the tidal poles varies.

The simplicity of the tidal movements outlined above is interfered with by many things, especially by (1) the continents, which stop the tidal wave, and (2) the shallowness of water in many places. The tidal wave travels more slowly in shallow water than in deep, for the same reason that other waves do. Since tides are retarded most in this way near continents and islands, their advance is here most irregular. Irregular tidal waves often interfere with one another.

**Solar tides.** The sun also attracts the earth and tends to

cause tides. If there were no moon we should still have tides produced by the sun.

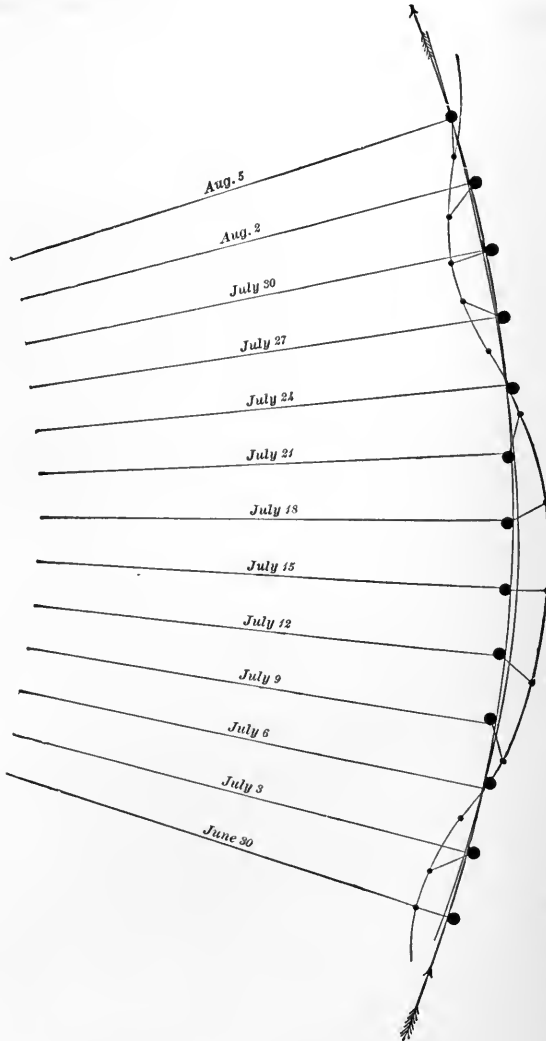

FIG. 698.—Diagram illustrating the motion of the moon about the earth. The larger circles represent the earth, and the smaller the moon on the line which represents its orbit.

In spite of its great distance from the earth (about 93,000,000 miles), the sun, because of its great size, attracts the earth much

more strongly than the moon does. If the moon's attraction were the stronger, the earth would revolve about the moon instead of the sun. But in spite of its greater attraction, *the tide-producing force* of the sun is less than that of the moon. It is not difficult to calculate their relative attractions. If the moon's mass be taken as 1, the mass of the sun is 26,648,000. Mass alone considered, the sun should attract the earth 26,648,000 times as strongly as the moon. The sun is about 389 times as far from the earth as the moon is. Distance alone considered, its pull should therefore be  $1/389^2$  ( $=1/151321$ ) of that of the moon.  $1/151321 \times 26,648,000 = 175$  approximately. That is, the sun pulls the earth with 175 times the force that the moon does.

It has been seen that the tide produced by the moon is due to the difference between the pull of the moon on the center of the earth and on the parts nearest to and farthest from it. Any tide which the sun produces must also be due to the difference between its pull on the center of the earth and on the sides nearest and farthest from it.

The sides of the earth nearest to the sun and farthest from it are 4000 miles nearer to and farther from the sun than the center of the earth is; but 4000 miles is a very much smaller part of 93,000,000 miles than it is of 240,000 miles. Hence the difference between the attractive force of the sun on the center and on the side of the earth nearest it is much less than the difference in the attractive force of the moon on the same points. In other words, *the differential pull of the sun is less than the differential pull of the moon*. The moon's tides are therefore higher than the sun's. Their ratio is 0.0342:0.0151. If the sun were as near the earth as the moon is, its tidal effect would be millions of times greater than now, and perhaps sufficient to disrupt the earth.

Some of the tides are the result of the combined influence of the moon and the sun, but since the lunar tides are the stronger, the solar tides serve merely to modify them. The solar influence



FIG. 699. — Diagram to illustrate the lagging of the tides. (After Comstock.)

strengthens the tides when sun and moon work together, and weakens the tides when they work against each other.

**Spring tides and neap tides.** When the sun and the moon stand in the relation to each other and to the earth shown in Fig. 700 (*New moon*), each tends to make high tides at the same points. When the relations are those shown in Fig. 701 (*Full moon*), the result is the same. At these times, and each occurs once a month,



FIG. 700.—Diagram to illustrate the relative positions of earth, moon, and sun at the time of full moon. Spring tide.



FIG. 701.—Diagram to illustrate the relative positions of earth, moon, and sun at the time of full moon. Spring tide.

the high tides are higher, and the low tides lower, than at other times. The tides of such times are called *Spring Tides*. Spring tides therefore have no relation to the spring season.

When the earth, moon, and sun sustain the relative positions shown in Fig. 702, and this occurs twice each month, the tidal influences of the sun and the moon are opposed, and the result is that the high tides are not so high, or the low tides so low, as under other conditions. The tides of such times are known as *Neap Tides*.

**Other variations in the height of high tides.** There are several other causes of variation in the height of high tides. Two of these causes show themselves daily, two have monthly periods, and one an annual period.

**The two successive high tides of a given place are often of unequal height.** One daily variation in the height of high tides is due to the fact that the high tide on the side of the earth away from the

moon is slightly lower than that on the side next the moon, for  
 $\frac{1}{236000^2} - \frac{1}{240000^2} > \frac{1}{240000^2} - \frac{1}{244000^2}$ . The difference is, however,



FIG. 702.—Diagram to illustrate the relative positions of sun, moon, and earth at the time of neap tides.

slight, and in the presence of larger variations is not commonly noticed.

Again, if the high tide on one side of the earth is highest at *A* (Fig. 703), the highest point in the high tide on the opposite side would be at *B*, if the ocean were universal and of uniform depth. From *A* on the one side, and from *B* on the other, the height of

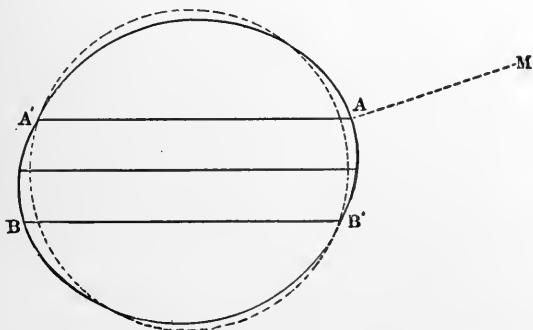

FIG. 703.—Diagram showing why successive high tides are often unequal.

the high tide diminishes in all directions. The point *A'* has high tide at the same time that *A* and *B* have, but the tide at *A'* is not so high as that at *A*. Twelve hours (and twenty-six minutes)

later, point *A* will have the same position relative to the moon that *A'* now has, because of the rotation of the earth and the revolution of the moon. The high tide which will occur at *A* when this point shall have reached the position *A'* will not be so high as that which it had when in the position *A*. Similarly the high tide which the point *A'* will have when it reaches the position *A*, will be higher than the preceding high tide at the same place. The amount of daily variation due to this cause is often considerable. Locally at least it is several feet. It is to be noted that it would not occur when the moon is vertical at the equator, for then all points on the same parallel stand in the same relation to the highest part of the tidal wave.

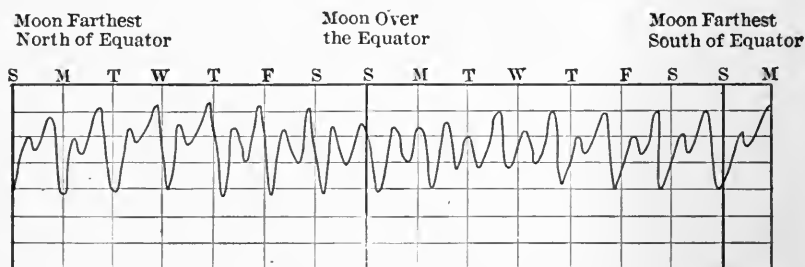

FIG. 704.—Diurnal inequality of the tides at San Francisco. The space between the vertical lines represents a day. The several crests of the curves represent high tides and the troughs low tides.

The *monthly* variations in the height of the high tide are less notable. One is due to the variation in the distance of the moon from the earth. This distance decreases from its maximum for about two weeks, and then increases from its minimum for about the same length of time. The variation in the distance of the moon from the earth makes a slight difference in the height of the tides, the high tides being highest and the low tides lowest when the moon is nearest. Another monthly variation at any given place, is due to the fact that the moon is vertical in different latitudes at different times. In this particular, its monthly range is comparable to the annual range of the sun.

The distance of the earth from the sun also varies during each year, and this variation has its appropriate effect, small though it is, on the height of the solar tides, and so on the height of the observed tides. Other variations in the distance of the sun from the earth occur in much longer periods of time, but they need not

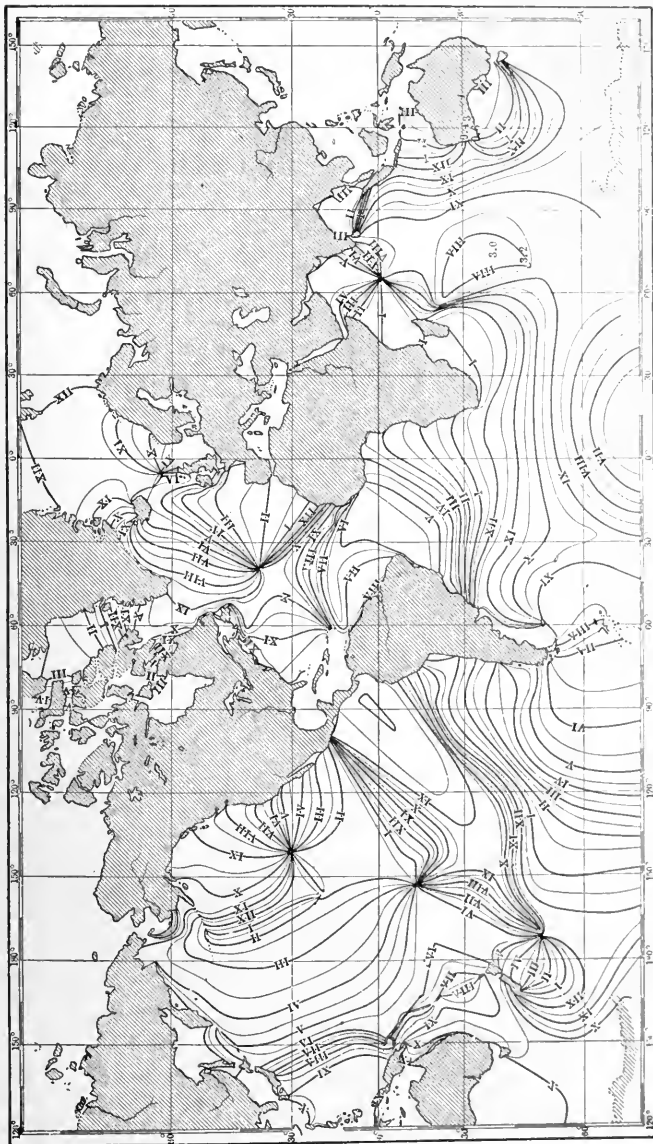

Fig. 705.—Cotidal lines for the world. (Nat. Geog. Mag., June, 1906.)

be considered here. The variations for any given place, produced by the apparent annual motions of the sun, are trivial.

The highest high tides in any given place should occur, theoretically, when the sun and the moon work together (spring tides), at that time of day when the moon is most nearly in the zenith, at that time of the month when the moon is nearest to the earth, and at that time of year when the sun is nearest to the earth.

**Cotidal lines.** If a line were drawn on the ocean surface, connecting all points which have the crest of the same high tide at the same time, it would be a cotidal line. Any line connecting points having the trough of the same tidal wave at the same time would also be a cotidal line; or in general, any line connecting points having the same phase of the same high tide at the same time, is a cotidal line. If the ocean were universal and equally deep, the cotidal lines would be the halves of great circles; but the continents and the shallow waters, the islands and the straits, cause many irregularities in them. The tide runs ahead, relatively, where the water is deep and lags when it is shallow.

**Rate of movement.** Theoretically the tide should move forward, from east to west, so as to complete a circuit in 24 hours and 52 minutes. This would give it great velocity in low latitudes, a velocity nearly equal to that of the rotation of the earth. This velocity is nearly reached in the deep and open sea, but nowhere else.

**Effects of tides on shores.** Since tides commonly rise in a series of waves, they affect shores much as wind waves do. The erosion effected by tidal currents among islands, and through straits has been referred to. Tidal scour often keeps thoroughfares open through tidal marshes, to which the tide has access through bays. Illustrations are found on the coast of New Jersey. Tidal scour also sometimes maintains deep waterways in bays to the great advantage of navigation.



## CHAPTER XXIV

### THE LIFE OF THE SEA

THE sea teems with plants and animals. The latter abound at and near the surface nearly everywhere; they abound at the bottom in shallow water, and they occur, though far less abundantly, at the bottom of even the deep sea. In the great body of water intermediate between the uppermost 100 fathoms and the bottom, life is nearly absent. It has been estimated that the amount of life in the sea exceeds that of the land, square mile for square mile; but there is probably no one level in the sea where life is so abundant as on the surface of the fertile parts of the land. Murray has estimated that the weight of the lime carbonate of the shells of organisms in the uppermost 100 fathoms of sea-water is something like 16 tons per square mile. This is far less than the weight of the plant and animal life per square mile on land in fertile regions.

The abundance of life in the sea-water may be shown in another way. If a bucket of water be dipped up from the surface of the ocean almost anywhere, it will be found to contain hundreds or even thousands of minute organisms, though most of them are too small to be visible to the unaided eye.

The distribution of the plant life of the sea differs somewhat from that of the animal life. Plant life is plentiful at the surface nearly everywhere, and at the bottom, down to the depth of about 50 fathoms. Where conditions are favorable, it occurs somewhat sparingly down to depths of nearly 200 fathoms or so; but below some such depth it is absent, probably because of the absence of sunlight. Animal life is abundant where plant life is, and also to considerably greater depths, beside being found to some extent over the whole of the ocean's bed.

The most important physical factors which influence the dis-

tribution of the various types of sea life are (1) temperature, and (2) depth of water. Other less important factors are (3) the clearness, (4) the degree of saltness, (5) the quietness or roughness, and (6) the presence or absence of ice. The relations of various types of life to one another are also important. Some are dependent on others for food, some are hostile to others, and some are rivals for the same sorts of food.

The manner in which most of these factors influence the distribution of life will be readily understood from analogy with the factors which control the distribution of land life. One factor, however, which finds no analogy in connection with the distribution of land life, is the depth of the water. Land life is restricted practically to the surface of the land, while sea life has a wide vertical range. The depth of the water affects the distribution only of those plants and animals which rest on the bottom; it has little effect on the range of those which float or swim near the surface.

The most important influence of depth appears to be in connection with the penetration of light and with the supply of oxygen. Light is so rapidly absorbed by the water that vision is virtually cut off at a depth of some 50 fathoms, though a little light penetrates to somewhat greater depths. But in the great body of the ocean darkness reigns. No form of plant life which depends directly on sunlight can live in darkness. This includes all forms of green plants, and some others. At the bottom, too, the water is not stirred, and any oxygen it contains must pass down from the surface after being dissolved there. As it is consumed below by the animals, the supply is renewed by diffusion, an extremely slow process.

Since the several factors which influence the distribution of sea life vary widely, the distribution of various types of life also varies widely. Some animals, such as coral polyps, are restricted to warm regions where the water is shallow, clear, and normally salt, while others, such as narwhales, seals, etc., are found only in cold waters. Still others range through great differences of temperature.

The plant life of the sea varies less with latitude than the plant life of the land, and less than the animal life of the sea.

The life of the sea is in strong contrast in many ways with that of the land. Thus most plants with which we are familiar on land are fixed in position, while many of the plants of the sea

float. Most animals on the land are free to move about, while a very considerable proportion of sea animals, such as coral polyps, barnacles, crinoids, etc., are fixed through most of their lives. Many others, though not fixed, move about but little, either lying on the bottom or burrowing into it. Some, on the other hand, such as many of those in the surface waters (pelagic life), appear to be always in motion.

The pressure of the water at the bottom of the ocean is very great, but the animals living there withstand it, because their tissues are full of liquids under equally high pressure, and these high internal pressures counterbalance the external pressure. If an animal from the bottom of the deep sea were brought suddenly to the surface it would explode. This has indeed happened in raising animals from the deep sea, even when the raising was by no means instantaneous.

The deep-sea animals have some notable peculiarities. Some are blind, but some have eyes, implying sight and therefore light. It has been conjectured that the phosphorescence of the animals themselves supplied the light. Some of the deep-sea animals also are ornamented, a fact which seems to have no rational explanation, unless the ornamentation is seen.

All the great groups of animal life are represented in the seawater. Even warm-blooded mammals (whales, narwhales, seals, walruses, etc.) abound in the frigid waters among icebergs and ice-floes. Some of these animals, like the seals and walruses, do not spend all their time in the water, but frequently crawl up on the floes of ice to warm themselves and sleep in the sun. From this highest class of animals (mammals) down to the lowest, every important subdivision of the animal kingdom is represented, though no birds spend all their time in the water. The variations of plant life are also great, though the higher forms, such as we are most familiar with on land, are wanting.

It is to be noted not only that the range of marine plants and animals is great, but that the largest living animals, the whales, are marine. Many of the marine plants, too, are of great size. Some seaweeds are six inches in diameter, and some are hundreds of feet long, exceeding in length the height of the tallest trees. They are, however, not so bulky as large trees, and the amount of solid matter which the largest seaweed contains is far less than that of the largest tree.

The life of the sea is important in many ways. Many of the animals, fish, oysters, clams, crabs, lobsters, etc., are used for food. The total value of food products derived from the sea is probably not less than \$500,000,000 per year. Other animals furnish other articles of commerce; for example, the seal furnishes fur and oil; the whale, oil and whalebone; the walrus, exceptionally strong leather, etc. Corals and sponges, the products of animal life, are also articles of commerce.

Many of the animals of the sea have shells or other hard parts. These hard parts accumulate on the bottom of the sea when the animals are through with them, and this is a chief source of the sediments of the sea bottom. When the shells, etc., accumulate with little admixture of other material, they may in time be solidified by cementation and form limestone. Most of the limestone now found on land was formed in this way beneath the sea, when the sea covered the areas where it now occurs. The animals which make the heavier shells or other secretions of calcium carbonate live chiefly in shallow water, and the seas in which the limestones of the land were formed were generally shallow.

## CHAPTER XXV

### MATERIALS OF THE SEA BOTTOM

**Dredging.** The material on the bottom of the sea has been made known by dredging. Various forms of apparatus have been used to bring up matter from the bottom. One, known as the Cup Lead, is shown in Fig. 706. *B* is a hollow inverted cone on a spike. Above the cone is a sliding disc, *D*, somewhat larger than the base of the cone. This piece of apparatus is let down and the cone sinks into the soft sediment and is filled with it. On being raised, the disc shuts down and prevents the escape of the contents of the cup, and also the access of new matter from higher levels.

Fig. 707 shows a dredge. The flaring strip of metal *E* is dragged along the bottom, and directs the surface sediment into the sack. Swabs are attached below to entangle animals missed by the dredge.

The bottom of the sea is generally covered with sediment which is, for the most part, in a loose or uncemented condition. This sediment has come from various sources. Some of it was carried to the sea by rivers, some of it was worn from the shores by the waves, some of it was blown out from the land, some of it is made up of the shells, etc., of the organisms which live in the water, and some of it is composed of fine debris thrown out from submarine volcanoes. Cosmic ("shooting-star") dust is also an element, though a very minor one.

The sediments derived from the land came from the disintegration of land rock. In their present state, however, they are to be looked upon as rock in the making, for all sediments in the sea



FIG. 706.—The cup lead. (Challenger Report.)

may become solid rock by cementation, and cementation is now taking place at many points in the bottom of the sea. Locally, it takes place as fast as the sediments accumulate.

Physically, the materials of the sea bottom may be grouped into several classes, namely: gravel, sand, mud, shells, coral, etc., and ooze.

Gravel is found chiefly along the borders of the land out to depths of a few fathoms, or at most a few scores of fathoms. Gravel and bowlders, carried out by icebergs, are occasionally found at great depths and far from land. Sand also is generally confined to relatively shallow water, but it occurs out to depths beyond that reached by gravel, but rarely out to 100 fathoms. Mud is much more widespread. While it frequently occurs in shallow water, it also extends out to a depth far beyond that reached by gravel and sand. In general, land-derived mud is not washed out far from the land, but in exceptional cases, as off the

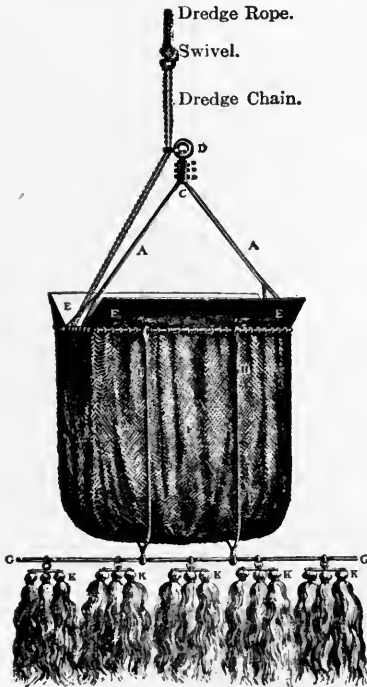

FIG. 707.—The dredge. (Challenger Report.)

mouths of rivers, it is carried hundreds or even a thousand miles.

Ooze is the name applied to the loose materials of the sea bottom composed primarily of the minute shells and tests of organisms which live in the water. Many of these organisms live near the surface of the water, and their shells, etc., sink when they die. The distinctive names of the oozes are derived from the names of the organisms which contributed most to them. Thus, *foraminiferal ooze* is the ooze in which shells of *foraminifera* are abundant, *diatom ooze* is ooze in which tests of *diatoms* predominate, etc. Foraminiferal ooze has a composition very similar to that of

chalk. Other oozes, such as diatom ooze, radiolarian ooze, etc., are made up largely of silica.

In the deepest part of the ocean, below the depth of some 2200 fathoms, the surface is covered with *red clay*. The origin of this clay has long been in question, but it is probably made up of material derived from many sources. A considerable part was doubtless derived from the fine material ejected from volcanoes; another part was probably carried out from the land by the wind, a part was probably derived from the shells and tests of animals which lived in the ocean, and cosmic dust doubtless enters into its composition. The materials from all these sources, so far as they enter into the composition of the red clay, are probably only the insoluble parts of the original material.

On the lands there is rock (conglomerate) composed of cemented gravel, rock (sandstone) composed of cemented sand, rock (shale) composed of cemented mud, and rock (limestone) composed of material derived from shells, corals, etc. None of these correspond to the deep-sea oozes, and none correspond to the red clay of the abysmal depths. In the lands, therefore, there are varieties of rock corresponding to all the sediments now making in the shallow water of the sea, but, so far as known, none corresponding to those of the deep waters. This suggests that the lands have been at some time beneath the sea, a conclusion which is borne out by the finding of the shells of marine species imbedded in the sandstone, shale, etc., of the land; but it also indicates that, *so far as now known, no part of the present continents was ever at the bottom of the deep ocean.*

## CHAPTER XXVI

### RELATION OF THE SEA TO THE REST OF THE EARTH

THE ocean has an important influence on the rest of the earth. This is felt in various ways, some of which have already been noted. By way of summary they may here be brought together.

1. Waves affect the coast-line; they wear away the land in some places and build new land in others. On the whole, destruction exceeds construction, so far as the land is concerned, so that the tendency of the ocean is to extend itself at the expense of the land.

2. Oceans modify the climate of the land, affecting both temperature and precipitation. The general influence on temperature arises from the fact that water is heated and cooled more slowly than land is. The air over the sea, therefore, has a lesser range of temperature than that over the land, and blowing to the land tends to carry the temperature of the sea, as well as abundant moisture, over to it. Winds from the ocean therefore temper the climate of the land both in summer and winter. The warm currents enhance the general effect of the sea in this respect. The climatic effect of the sea on the land is felt especially on the west sides of the continents, in the temperate zones, because of the westerly winds, and on the east sides of the continents in the zone of easterly winds. The cold currents of the sea have much less effect than warm ones on the climate of the land, because they tend to hug the east sides of the continents, so far as they stay at the surface; and in the latitudes where they occur the winds blow from them to the sea rather than to land.

3. The ocean is the great source of the water for rain and snow, and its precipitation from the atmosphere furnishes the conditions necessary for life on the land.

4. Through its effects on rainfall, snowfall, and temperature, the ocean has an important effect on the degradation of the land.



The total amount of rainfall for the earth is not accurately known. If it is as much as three feet per year, on the average, for the whole earth, and if all this were derived directly from the ocean, an amount equal to all the water in the ocean would be evaporated in about 3000 years. Since most of the water evaporated from the ocean falls again into the sea, or runs to it in rivers, or issues beneath it as springs, the amount of the ocean water is not, so far as known, growing less.

5. The ocean affords an enormous harvest of foodstuff annually, and many thousands of people depend on this harvest for their livelihood. Fisheries were among the earliest industries.

6. The ocean also plays an important part in the commerce of the world by serving as a great highway. The obstacle which the oceans long seemed to interpose to quick communication between continents separated by them, has been overcome during the last half century, and several cables now connect Europe and America, so that all the important news of either continent is known in the other almost as soon as it is at home. The Pacific, too, is bridged by cables, though their number is small.

Some conception of the rôle which the ocean plays in the affairs of the earth may perhaps be gained by picturing the conditions which would exist if there were no oceans.

#### REFERENCES

1. WILD, *Thalassa*: Marcus Ward & Co., London.
2. MAURY, *Physical Geography of the Sea*.
3. CHAMBERLIN AND SALISBURY, Chapter VI, Geologic Processes, and other text-books of Geology.
4. AGASSIZ, *Three Cruises of the Blake*: Houghton Mifflin & Co.
5. THOMSON, *The Depths of the Sea*, and *Voyage of the Challenger*: Macmillan.
6. *Challenger Reports*, especially *Narrative*, Vol. I, and *Summary*, First Part: Eyre & Spottiswoode, London.
7. MURRAY, Important articles on oceanography in *Geog. Jour.*, Vol. XII, pp. 113-137, and Vol. XIV, pp. 34-50, and 426-441; and *Scot. Geog. Mag.*, Vol. XV, pp. 505-522.
8. BIGSBEE, *Deep-sea Soundings and Dredgings*: U. S. Coast Surv., Washington.
9. TANNER, *Deep-sea Exploration*: U. S. Fish Commission, Washington
10. BELKNAP, *Deep-sea Soundings in the North Pacific*: U. S. Hydrographic Office, Washington.
11. FLINT, *Oceanography of the Pacific*: Smithsonian Institution.
12. *Jour. of Geol.*, Vol. XIII, pp. 469-484.



## INDEX

- Abert Lake, 40  
Abnormal temperature, 546  
Abrasion by ground-water, 105  
    by the wind, 70  
Absolute humidity, 570  
    temperature, 677  
Accidents to streams, 173  
Aconcagua, 445  
Agassiz, A., 474, 757  
Aggradation, 44  
Agonic lines, 477  
Agriculture and rainfall, 701  
Air, chemical work of, 71  
Aitkin, J., 290  
Alaska, coast of, 458  
Alden, W. C., (and Salisbury), R. D.,  
    78  
Aldrich deep, 711  
Alluvial cone, 182  
    fan, 183  
    plains, 183, 187  
        fertility of, 191  
    terraces, 203  
Alpine glaciers, 219  
Alps, glaciers of, 233  
Alps Mountains, 441  
    section of, 39  
Altitude and temperature, 537, 545  
Anchor-ice, 214  
Andes Mountains, 441  
Aneroid barometer, 583  
Annual isobars, 585  
    maximum temperatures, 550  
    minimum temperatures, 551  
    parallax, 488  
    range of temperature, 549, 552  
Antarctic Circle, 502  
Antarctica, ice-cap of, 216, 240  
Antecedent streams, 177  
Anticyclones, 620  
    movements of, 632  
    origin of, 648  
    tracks of, in United States, 636, 645  
Ants, effect on surface, 78  
Aperiodic changes of pressure, 620  
Aphelion, 489  
Appalachian Mountains, 39, 41  
Aral Sea, 297  
Arctic Circle, 502  
Areas of low pressure in high lati-  
    tudes, 597, 601  
Argon, 512  
Aridity, effect on temperature, 545  
Artesian wells, 94, 95  
Ashes, volcanic, 368  
Asteroids, 505  
Astronomic latitude, 491  
Atlantic, equatorial temperature  
    curves for, 723, 724  
Atmosphere, a mixture of gases, 513  
    carbonic-acid gas of, 514  
    constitution of, 512  
    density and altitude, 507  
    general conception of, 506  
    heating of, 521  
    height of, 508  
    history of, 510  
    impurities of, 513  
    mass of, 510  
    oxygen of, 514  
    relation to rest of earth, 507  
    temperature of, 520  
    volume of, 510  
    water-vapor of, 517  
    work of, 55  
Atmospheric moisture, effect on  
    movements, 569  
    function of, 564  
Atmospheric pressure, 582  
    temperature, effect on movement,  
        561  
Atolls, 470  
Attraction of sun and moon, cause of  
    ocean movement, 728  
Aurora, 509  
Autumn, 531

- Avalanches, 253  
 Axis of earth, 484  
   inclination of, 497
- Bad lands, 160  
 Balloon ascents, 508  
 Barometer, 582  
   aneroid, 583  
 Barometric gradient, 613  
 Bars, 327  
 Base-level, 131  
   temporary, 139  
 Bath, springs of, 99  
 Batholiths, 375  
 Bayous, 189  
 Beaches, 324, 325  
 Belknap, G. E., 757  
 Bigsbee, Lieut. Com. C. D., 757  
 Black Hills, 23  
 Blake deep, 711  
 Blizzards, 646  
 Boiling springs, 124  
 Bonney, T. G., 390  
 Bore, tidal, 735  
 Boulders, 251  
 Braided stream, 185  
 Brigham, Prof. A. P., 337  
 Buttes, 173  
 Bysmalith, 375
- Caldera, 305  
 California, model of, 37  
   rainfall in, 619  
 Campbell, M. R., 206  
 Canyon of the Yellowstone, 159  
 Canyons and gorges, 156  
 Carbon dioxide of atmosphere, 512  
 Carbonation, 72  
 Carbonic-acid gas, 512  
   in atmosphere, 514, 517  
   effect on temperature, 517  
   in ocean, 719  
 Cascade Mountains, 35  
 Caspian Sea, 297  
 Castle Geyser, 92  
 Catskill Mountains, 440, 446  
 Caucasus Mountains, 442  
 Caverns, 97  
 Central America, earthquakes in,  
   428  
 Challenger, course of, 710  
 Chamberlin, Prof. T. C., 112, 289, 290,  
   291, 337, 757  
 Changes of level, 43, 398, 400-404  
 Changes of temperature, effect of,  
   72  
 Charleston earthquake, 413  
 Chemical work of air, 71  
 Chemical work of ground-water, 96  
 Chesapeake Bay, drainage about, 174  
 Chile, coast of, 332, 459  
   earthquakes in, 416  
 Chimborazo, 445  
 Chinook winds, 673, 675  
 Chittenden, H. M., 113  
 Cinder buttes, 365  
 Cinders, volcanic, 368  
 Circle of illumination, 497  
 Circulation of the atmosphere, 598  
 Circumpolar whirl, 605  
 Cirques, 231, 249  
 Cirrus clouds, 576  
 Cliff glacier, 221, 222  
 Climate, 676  
   changes of, 703  
   continental, 683  
   oceanic, 683  
   of polar zones, 700  
   of tropical zone, 693  
 Climate and life, 702  
 Climates, classification of, 683  
 Climatic changes, causes of, 705  
   effects of ocean currents, 733  
   zones, 684  
 Cloudbursts, 667  
 Cloudiness, precipitation, etc., shown  
   on weather maps, 623  
 Clouds, 574  
   forms of, 576  
 Coal in the United States, distribu-  
   tion of, 455  
 Coastal plains, 17  
 Coast-line irregularities, distribution  
   of, 461  
 Coast-lines, affected by diastrophism,  
   463  
   affected by gradation, 462  
   affected by vulcanism, 464  
   effect on history, 465  
   irregularities of, 457  
   relief of, 460  
 Cold currents, 721  
 Cold waves, 645  
 Colorado, Grand Canyon of, 32, 33,  
   157  
 Colorado River, delta of, 199  
 Columnar structure, 388  
 Comets, 505  
 Compound alluvial fan, 183  
 Condensation of water-vapor, 572  
 Conduction, 526  
 Conglomerate, 49  
 Consequent falls, 168  
   streams, 177  
 Continental and oceanic tempera-  
   tures, 560  
   climate, 683, 690

- Continental glaciers, 234  
 changes produced by, 274  
 of Europe, 272  
 of North America, 270
- Continental platforms, 10, 11  
 shelves, 6, 22  
 slopes, 713
- Continents, grouping of, 11  
 outlines of, 457
- Contour interval, 20  
 map, explanation of, 19
- Contours, 20
- Convection, 93, 527
- Convection currents, 529
- Coon butte, 380, 381
- Copper ores in the United States,  
 distribution of, 454
- Coral islands, 469  
 reefs, 469
- Cornish, V., 78
- Corrasion, 129
- Corrosion, 129
- Coseismic lines, 425
- Cotidal lines, 747
- Counter currents, 733
- Cowles, H. C., 78
- Crater, 339
- Crater Lake, 297, 305, 306, 382
- Craterlets, 410
- Creep, 108, 133
- Crevasse of glaciers, 224
- Crustal deformation, 405  
 movements, 392
- Cumulus clouds, 576
- Currents, oceanic, 721, 730
- Cycle of erosion, 153
- Cyclone, 621  
 structure of, 625
- Cyclones, mean tracks of, in United  
 States, 636  
 movements of, 632  
 origin of, 648  
 paths of, 645  
 tropical, 648
- Cyclonic winds, 618
- Daily range of temperature 553,  
 559
- Daly, R. A., 206
- Dana, Prof. J. D., 473, 474
- Darwin, Charles, 474
- Davis, B. M., 113
- Davis, Prof. W. M., 203, 290, 511, 686
- Dead Sea, 297
- Deepening of valleys, 129
- Deep, 711
- Deflection of winds by rotation, 602,  
 604
- Degrees, length of, 494
- Delta of the Colorado River, 199,  
 200  
 the Danube, 202  
 the Mississippi, 181, 197  
 the Nile, 201  
 the Rhone River, 201  
 the St. Clair, 197
- Delta lakes, 310
- Delta-land, 330
- Deltas, 198, 199
- Density and movement of sea-water,  
 719
- Deposition by continental glaciers  
 276  
 by ground-water, 59  
 by running water, 179, 180
- Depth-limit of valleys, 131
- Desert climates, 690
- Dew, 573
- Dew-point, 570, 572
- Diastrophism, 303, 392  
 a cause of change of sea-level, 401  
 effects on coast-lines, 463
- Diatom ooze, 754
- Dikes, 375
- Diller, J. S., 337, 390, 391
- Dip compass, 479
- Direction of winds, 602, 613
- Distributary streams, 185
- Divides, permanency of, 140
- Dodge, Prof. R. E., 206
- Doldrums, 617
- Dolphin ridge, 714
- Drainage changed by glaciation, 285
- Drainage of the upper Ohio basin  
 285
- Dredging, 753
- Drift, 257  
 disposition of, 258  
 oceanic, 730, 732  
 topography, 260, 264
- Driftless area, 272
- Drowning of valleys, 173
- Drumlins, 265, 278, 279
- Dry farming, 615
- Dry winds, 697
- Dunes, 63  
 distribution of, 63  
 migration of, 67  
 shapes of, 65
- Dust, 55  
 in atmosphere, 518  
 distribution of, 62  
 sources of, 56
- Dust-wells, 227, 228
- Dutton, Major C. E., 206, 391, 434
- Earth, flattened form of, 482, 496  
 motions of, 484, 488

- Earth relations, 482  
 Earth, size of, 484  
 Earthquake fissures, 431  
 Earthquake wave, 424  
 Earthquakes, 408  
   beneath the sea, 420  
   Californian, 419  
   causes of, 430  
   distribution of, 429  
   frequency of, 427  
   in Italy, 418  
   in Japan, 412  
   in Mississippi valley, 417  
   in Panama, 428  
   strength and destructiveness, 408  
   surface changes caused by, 432  
 Earthworms, effect on surface, 78  
 Ebb-tide, 735  
 Eddying streams, 124  
 Elbruz Mountains, 445  
 Elk Mountains, 36, 39  
 Enchanted Mesa, 172  
 Englacal drift, 253  
 Entrenched meanders, 174  
 Eolian sand, 63, 69  
 Epicontinental seas, 7  
 Equator, 484  
 Equatorial calms, 603, 617  
   currents, 730  
   temperature curves for the At-  
   lantic, 724  
   temperature curves for the Pacific,  
   724  
 Equinoxes, 499  
 Erosion, 129  
   by continental glaciers, 274  
   by streams, 120  
   by wind, 55  
   conditions affecting rate of, 155  
 Eskers, 267  
 Evaporation, 80, 565  
   affected by temperature, 568  
   amount of, 567  
   effect of temperature on, 568  
   influenced by wind, 568  
   rate of, 566  
 Exfoliation, 74  
 Extinct lakes, 333  
 Extra-tropical belts of high pressure,  
   600  
  
 Fairchild, Prof. H. L., 291  
 Fall Line, 22  
 Fault, normal, 406  
   reversed, 406  
 Faulted mountain, 39  
 Faulting, 405, 406  
 Faults and folds, 406  
 Fault-scarps, 407  
  
 Fenneman, Prof. N. M., 337  
 Ferrel, W., 511  
 "Fetch" of waves, 321  
 Filling of lake basins, 302  
 Fiords, 248, 331  
 Fissure eruptions, 371  
 Fissures, 338  
 Flint, J. M., 757  
 Floe-ice, 212  
 Flood-plain meanders, 187  
 Floods of rivers, 115, 195  
   of Yellow River, 202  
 Flood-tide, 735  
 Flowing wells, 94  
 "Fluvial period" of history, 191  
 Fluvio-glacial deposits, 265  
 Foehn winds, 673  
 Fog, 574, 734  
 Folding, 405  
 Folds and faults, 406  
 Foraminiferal ooze, 754  
 Forests, climatic effect of, 692  
 Form of earth, 482  
 Fossils as evidence of change of level,  
   393  
 Foucault's pendulum, 486  
 Freezing and thawing, 72  
 Frigid zones, 684  
 Frost, 573  
 Fuji-yama, 445  
 Funnel-shaped cloud, 668  
  
 Galveston storm, 648, 654  
 Gannett, H., 206  
 Geikie, Prof. J., 78, 112, 290, 337  
 Geikie, Sir Archibald, 290, 337  
 General circulation and precipitation,  
   614  
 Geodetic latitude, 491  
 Geographic latitude, 491  
 Geography defined, 4  
 Geology defined, 3  
 Geysers, 90  
 Geyser tube, 91  
 Giant Geyser, 91  
 Gilbert, G. K., 205, 290, 337, 391,  
   434  
 Glacial boulders, 252  
   epochs, cause of, 273  
   grooves, 249, 250, 263  
   lakes, 311  
   period, 270  
   plains, 436  
   striae, 248, 250, 263  
 Glaciated valleys, 244  
 Glaciation and drainage, 280, 285  
   effects of, on human affairs, 287  
 Glacier movement, nature of, 231  
 Glaciers, 219

- Glaciers, conditions affecting rate of  
 movement, 230  
 crevasses of, 224  
 deposition by, 255  
 effect on shores, 330  
 erosion by, 242  
 movement of, 229  
 size of, 233  
 types of, 219  
 waste of, 229  
 work of, 242
- Glaciers and ice sheets, ancient, 270
- Gold and silver, distribution of, 454
- Gradation, 305  
 agents of, 44  
 effects on coast-lines, 462
- Gradient of wind, 613
- Graham Island, 379
- Grand Canyon of the Colorado, 32, 33, 157
- Granite, 52
- Gravity faults, 406
- Great Ararat, 445
- Great Bear Lake, 297
- Great Lakes, the, 284
- Great Plains, 23
- Great Salt Lake, 315
- Great sea waves, 412
- Greece, earthquakes of, 420
- Greely, Gen. A. W., 511
- Greenland, ice-cap of, 216, 235
- Ground-ice, 214
- Ground moraine, 257, 278
- Ground-swell, 319
- Ground-water, 83  
 abrasion by, 105  
 amount of, 86  
 deposition by, 99  
 descent of, 84  
 existence of, 83  
 movement of, 86  
 solution by, 96  
 source of, 83  
 surface, 85  
 work of, 80, 96
- Gulf Stream, 544, 730
- Gullies, 119
- Gulliver, F. P., 474
- Gully, growth of, 142
- Heat received in different latitudes, 524
- Heating of land and water, 530
- Heilprin, Prof. A., 390, 474
- Henry Mountains, 373
- Hanging valleys, 247
- Hann, Prof. J., 511, 689
- Harrington, M. W., 337
- Hawaiian volcanoes, 361
- Hayden, F. V., 511
- Hayes, Dr. C. W., 206
- "High." (See Anticyclone.)
- High-latitude areas of low pressure, 601
- High-latitude glaciers, 219
- High-pressure belts, 594
- High tides, 738  
 variation in height of, 744
- Hill, R. T., 390
- Himalayas, rainfall in, 619
- Hitchcock, A. S., 78
- Hogbacks, 171
- Hot waves, 645
- Hovey, E. O., 112, 390
- Humidity, 570  
 absolute, 570  
 effect on temperature, 545  
 relative, 570
- Hurricanes, 648
- Hydration, 105
- Hydrography defined, 3
- Ice and snow, work of, 207
- Ice of lakes, 207  
 of sea, 210  
 in soil, 207
- Icebergs, 269
- Ice-cap of Antarctica, 240  
 of Greenland, 235
- Ice-caps, 221, 234
- Ice cascade, 224
- Ice columns, 228
- Ice-fields, 218
- Ice-foot, 212
- Ice jams, 213
- Ice-packs, 212
- Ice-sheets, 221
- Ice-shove, 212
- Igneous rocks, 51
- Immediate run-off, 83
- Inclination of earth's axis, effects of, 497
- India, earthquakes in, 416  
 famines in, 619
- Inequalities of level, 727
- Insolation, 522  
 in different latitudes, 524
- Interior plains, 17, 22
- Intermediate zones, 684, 686  
 climate of, 695
- Intermittent streams, 118
- Intrusions of lava, 374
- Iron ores in the United States, distribution of, 455
- Irrigation, 193, 451
- Is-abnormal lines, 546

- Is-abnormal temperatures for January, 547  
 for July, 548
- Islands, origin of, 466
- Isobaric chart for January, 591  
 for July, 593
- Isobaric charts, 584
- Isobaric gradient, 587
- Isobaric surfaces, 587, 596
- Isobars, 584, 620  
 annual, 585  
 courses of, 588  
 and humidity, 594  
 and parallels, 589  
 and temperature, 590, 592  
 relation of, to land and water, 589
- Isogetic lines, 477
- Isothermal chart of United States, annual, 553  
 for April, 554  
 for January, 554  
 for July, 555  
 for October, 555
- Isothermal charts, 539
- Isothermal surfaces, 546
- Isotherms, 539  
 courses of, 540, 624
- Japan, earthquakes in, 412
- Jefferson, M. W., 206
- Jetties of the Mississippi, 128
- Johnson, L. C., 206
- Joints, 53
- Jordan, Pres. D. S., 434
- Jordan craters, 364
- Judd, Prof. J. W., 390
- Jupiter, 504
- Kames, 268
- Karst, 98  
 Karst topography, 98
- Kaskaskia, 189
- Kemp, Prof. J. F., 337
- Kenal, 445
- Kilauea, 363, 364
- Kilimanjaro, 445
- King, F. H., 112
- Krakatoa, 348
- Kümmel, H. B., 291
- Laccoliths, 374
- Lacustrine plains, 333, 437
- Lag of tides, 741
- Lake Agassiz, 282, 333  
 Agnes, 35  
 Baikal, 297  
 Balkash, 297  
 Bonneville, 314  
 Chad, 297
- Lake Chelan, 297  
 Como, 297  
 Erie, 297  
 Garda, 297  
 Huron, 297  
 Michigan, 297  
 Nyassa, 297  
 Ontario, 297  
 Pepin, 292  
 Pontchartrain, 310  
 St. Clair, delta of, 197  
 Superior, 297  
 Tanganyika, 297  
 Titicaca, 297  
 Victoria Nyanza, 297  
 Winnipeg, 297
- Lake basins, filling of, 302  
 origin of, 303
- Lake water, movements of, 300  
 sources of, 301
- Lakes, 292  
 area of, 295  
 changes of level of, 300  
 changes taking place in, 302  
 climatic effects of, 316  
 conditions necessary for, 301  
 depth of, 295, 296  
 distribution of, 293  
 economic advantages and disadvantages of, 316  
 fate of, 303  
 lowering of outlets, 303  
 origin of, 313  
 sections of, 298  
 topographic position of, 295  
 volume of water in, 297
- Lakes of Red River (La.) Valley, 300
- Land, materials of, 45
- Land and water, effect on temperature, 541  
 heating of, 530
- Land-breezes, 561, 610
- Land degradation, rate of, 154
- Landslides, 106
- Landslip Mountain, 106
- Land-tied islands, 329
- Land-water, source, 80
- Lateral moraines, 254  
 mode of origin, 257
- Latitude, 490  
 and sun altitude, 502  
 length of degrees, 494
- Lava, 338, 367
- Lava-flows of the northwest, 372
- Lead and zinc ores in the United States, distribution of, 456
- Le Conte, Prof. J., 473
- Leuk, springs of, 98
- Leverett, F., 290



- Life and climate, 702  
 Lightning, 665  
 Limestone, 49  
   origin of, 718  
 Limestone sinks, 97  
 Lithosphere, relief of, 9  
 Littoral climate, 691  
   currents, 319, 326, 729  
 Load of streams, 122, 128  
 Local variations of pressure, 597  
 Loess, 58, 59, 61  
 Lone Star Geyser, 92  
 Longitude, 491  
   and time, 490, 492  
 Louisville tornado, 670, 671  
 "Low." (See Cyclones)  
 Low tides, 738
- Magnetic declination, 477, 478  
   inclination, 479  
   intensity, 479  
   meridians, 475, 476  
 Magnetism, terrestrial, 475  
 Malaspina Glacier, 240  
 Mammoth Cave, 97  
 Mammoth Springs, 102  
 Mantle rock, 46  
 Mars, 504  
 Maryland vein, 100  
 Marysville buttes, 384  
 Massive rocks, 52  
 Materials of the land, 45  
 Mature topography, 152  
   valley, 149  
 Maturity of rivers, 150  
 Mauna Kea, 442-443  
 Mauna Loa, 339, 362, 365  
 McGee, W. J., 434  
 Mean monthly temperatures, 680  
 Medial moraine, 255  
 Medicinal springs, 90  
 Mercury, 504  
 Meridians, 484, 491  
 Merrill, G. P., 78, 206  
 Mesa, 34, 173  
 Metamorphic rocks, 53  
 Meteorites, 514  
 Meteorology defined, 3  
 Meteors, 509  
 Mill, H. R., 337  
 Milne, J., 434  
 Mineral matter of sea, 716  
   amount of, 716  
   source of, 717  
   withdrawal of, 718  
 Mineral springs, 90  
 Mississippi River, amount of sedi-  
   ment carried by, 121  
   delta of, 181, 197  
 Mississippi River, flat, 136  
   rate of erosion, 154  
 Mistral, 648  
 Moisture, effect on temperature, 545  
 Moisture of the air, 564  
 Monadnocks, 153, 171  
 Monoclinical folds, 406  
 Monsoon winds, 562, 605  
   of Chicago, 609  
   of India, 608  
   of Spain, 610  
 Mont Pelée, 350  
 Monument Park, 71  
 Moore, W., 511  
 Moraine-dams, 258  
 Motions of earth, 484  
 Moulton, Prof. F. R., 740  
 Mount Hood, 381  
   Mazama, 307  
   McKinley, 441  
   Rainier, 381, 383, 441  
   Shasta, 380, 381, 382  
   Whitney, 441  
   Wrangell, 445  
 Mountain breezes, 562  
   chain, 439  
   climate, 691  
   group, 439  
   range, 438  
   ridge, 438  
   system, 439  
 Mountains, 15, 33, 437  
   barriers to animals and plants, 452  
   barriers to transportation, 452  
   changes taking place in, 443  
   distribution of, 439  
   effects of, 450  
   produced by erosion, 445  
     by faulting, 448  
     by folding, 447  
     by intrusion, 447  
   height of, 440  
   in history, 38  
   in ocean, 442  
   origin of, 39, 445  
 Movement of sea-water, 719  
   causes of, 727  
 Mud cones, 389  
   volcanoes, 388  
 Murdoch, L. H., 337  
 Murray, Sir John, 337, 757
- Nansen, F., 291  
 Narrows, 169  
 Natural Bridge of Virginia, 163  
 Natural bridges, 98, 161  
 Natural levees, 187  
 Neap tides, 744  
 Needle Mountains, 34

- Neptune, 504  
 New Madrid earthquake, 418  
 Niagara Falls, 167  
 Nimbus clouds, 573  
 Nitrogen, 512, 513  
 Nitrogenous compounds, 513  
 Normal fault, 406  
 North Atlantic, temperature curve  
     for, 723  
 Northern lights, 509  
 Northers, 646  
 Nunatak, 237  
  
 Obsidian, 367  
 Ocean, the, 706  
     age of, 718  
 Ocean basins, 708  
     continuity of, 11  
 Ocean bottom, topography of, 713  
 Ocean currents, 721, 730  
     cause of, 733  
     climatic effects of, 733  
     effect on temperature, 544  
     gradational effects of, 734  
 Ocean, depth of, 711  
 Ocean life, 749  
 Ocean, mass of, 712  
 Ocean movements, types of, 729  
 Ocean, reasons for low temperature  
     of, 724  
     relation to rest of earth, 756  
     temperature of, 721, 722  
     volume of, 712  
 Ocean water, temperature and move-  
     ment, 722  
 Oceanic climates, 683, 688  
 Oceanography, defined, 3  
 Oceans, area of, 6  
 Old age of rivers, 150  
 Ores, distribution of, 452  
 Orizaba, 445  
 Ouachita Mountains, 23  
 Outwash plain, 266  
 Ox-bow lakes, 189  
 Oxygen of atmosphere, 512, 514  
 Ozark Mountains, 23  
  
 Pacific, equatorial temperature  
     curves for, 724  
 Paint-pots, 390  
 Palisade Ridge, 385, 387  
 Parallels, 490  
 Peary, Lieut. R. E., 291  
 Pelée, 58  
 Peneplains, 153  
 Perched boulder, 262, 264  
 Perihelion, 489  
 Periodic winds, 598  
 Petrification, 104  
 Petrified tree-trunks, 104  
 Physical geography of the sea, 709  
 Piedmont alluvial plain, 183  
 Piedmont glaciers, 222, 240  
 Piedmont plateau, 28  
 Piracy, 176  
 Plains, 15, 16, 435  
     topography of, 24  
 Planetary winds, 604  
 Plateau climate, 691  
 Plateaus, 15, 28, 437  
     origin of, 31  
     position and area of, 30  
 Polar circles, 502  
     zones, 684, 686  
     climate of, 700  
 Poles of earth, 484  
 Ponding, 175  
 Popocatepetl, 445  
 Population of the United States, 26  
 Pore space, 82  
 Pot-holes, 168, 169  
 Powell, Major J. W., 474  
 Precipitation, 80, 579, 616  
     and general circulation, 614  
     necessary for agriculture, 615  
 Pressure, aperiodic changes of, 620  
     atmospheric, 582  
     inequalities of, 583  
 Prevailing winds, 598, 604  
  
 Radiation, 526  
 Rafts, 308  
 Railway map of the United States,  
     453  
 Rain, 580  
 Rainfall, 614  
     and agriculture, 701  
     in California, 619  
     distribution of, 615  
     and sugar crops, 702  
     of the United States, 452, 618  
     zone of trades, 616  
     zones of westerlies, 617  
 Rain-making, 580  
 Rain-water, fate of, 81  
 Raised beaches, 394  
 Ravines, 119  
 Reade, T. M., 474  
 Recessional moraines, 277  
 Reconstructed glacier, 222  
 Red Sea, temperature of, 725  
 Red snow, 239  
 Reefs, 325  
 Reid, Prof. H. F., 290  
 Regolith, 46  
 Rejuvenation of streams, 174  
 Relative humidity, 570  
 Relief of lithosphere, 9

- Relief features of first order, 5, 12  
 of the land, 15  
 of sea bottom, 15  
 of second order, 15  
 Relief-map of United States, 27  
 Reversed fault, 406  
 Revolution of earth, 488  
 Rise of land (relative), evidences of, 393  
 River floods, 195  
 River ice, 213  
 River lakes, 308  
 River plains, 436  
 River system, history of, 141  
 Rivers, amount of water in, 114  
 effect on shores, 329  
 load of, 122  
 Rock, 47  
 Rock-basins, 275  
 Rock-breaking, 73, 111  
 Rock decay, 111  
 Rock flour, 251  
 Rock terraces, 170, 171  
 Rock waste, 46, 47  
 Roots, agents of weathering, 76  
 Rotation of earth, 484  
 Rotation, effect of, 488  
 winds deflected by, 602, 604  
 Running water, work of, 114  
 Run-off, 83  
 Russell, Prof. I. C., 205, 289, 290, 337, 390, 511  
 Salinity and movement, 719  
 Salt Lake, 315  
 Salt lakes, 314  
 Sand, 62  
 lodgment of, 62  
 sources of, 62  
 Sandstone, 49  
 San Francisco earthquake, 419  
 San Francisco Mountain, 381, 384, 386  
 Satellites, 505  
 Saturation, 569  
 Saturn, 504  
 Scandinavia, changes of level in, 393  
 Sea, temperature of, 721  
 Sea bottom, materials of, 753  
 Sea-breezes, 561, 610  
 Sea caves, 394  
 ice of, 726  
 Sea cliff, 321, 322, 323, 394  
 Sea-level, 400, 707  
 distortion by attraction, 707  
 inequalities of, 707, 727  
 Seasonal range of temperature, 559  
 Seasons, 531  
 change of, 533  
 Seasons in different latitudes, 534  
 Sea-water, composition of, 716  
 gases in, 718  
 movements, 727  
 salinity and color, 720  
 Secular changes of level, 392  
 Sedimentary rocks, 48  
 Sedimentation, a cause of change of sea-level, 400  
 Seepage, 89  
 Seiches, 300  
 Semi-arid lands, 618  
 Sensible temperature, 677  
 Seward glacier, 234  
 Shale, 49  
 Shaler, Prof. N. S., 112, 205, 290, 337, 434  
 Shepard, E. M. Prof., 434  
 "Shooting-star" dust, 753  
 Shooting-stars, 509, 514  
 Shore current, 318, 319  
 deposition by, 324  
 Shore-drift, 325  
 Shore ice, 333  
 lakes, 311  
 terraces, 334  
 Shore lines, 292  
 effect of glaciers on, 330  
 effect of rivers on, 329  
 effect of wind on, 330  
 topographic features of, 317  
 Sierra el Late Mountains, 34  
 Sills, 374, 375  
 Sinking of coasts, evidences of, 395  
 Sirocco, 645  
 Slichter, Prof. C. S., 112  
 Sliding, 105  
 Slumping, 105, 107, 135  
 Snake river, 31  
 Snow, 214, 580  
 Snow and ice, work of, 207  
 Snow-eaters, 674  
 Snowfall, 682  
 at Chicago, 680  
 in the United States, 556  
 Snow-fields, 215  
 Snowflakes, 81  
 Snow line, 215, 217  
 Soil, 46  
 Solar climate, 683  
 system, 504  
 tides, 743  
 Solstices, 499  
 Solution by ground-water, 96  
 Soufrière, 57, 350  
 Sounding line, 712  
 South Atlantic, temperatures in, 725  
 temperature curve for, 725  
 Spanish Peaks, 445

- Spits, 327  
 Spring, defined, 531  
 Spring tides, 736, 744  
 Springs, 89  
   mineral and medicinal, 90  
   temperature of, 89  
 Stalactites, 101  
 Stalagmites, 101  
 Standard-time zones, 495  
 St. Louis tornado, 669  
 Stone, G. H., 250  
 Storms, 621  
   special types of, 663  
 Stratified drift, 287  
 Stratified rocks, 48  
 Stratus clouds, 576  
 Stream water, sources of, 116  
 Streams, accidents to, 173  
   antecedent, 177  
   consequent, 177  
   deposition by, 179  
   erosive work of, 120  
   load of, 122  
 Stromboli, 341  
 Submarine volcanic extrusions, a  
   cause of change of sea-level,  
   401  
 Submerged forests, 396  
 Submerged valleys, 397, 714  
 Subsoil, 47  
 Summer, defined, 531  
 Summer and winter, differences,  
   532  
 Summer solstice, 499  
 Sun, varying distance of, 536  
 Sun-cracks, 135  
 Sun's distance, effect on tempera-  
   ture, 536  
 Supan, A., 688  
 Surf, 319  
 Suspension of sediment in rivers,  
   127  
 Tajumulco, 445  
 Talus, 74, 134  
 Talus glacier, 107  
 Tanner, Lieut. Com., Z. L., 757  
 Tarr, Prof. R. S., 337, 474  
 Taylor, F. B., 291, 337  
 Temperature of air, 520  
   effect on movement, 561  
   vertical movements, 563  
 Temperature and altitude, 537  
   and condensation of water-vapor,  
   572  
 Temperature changes with rise of air,  
   537  
   curve for the North Atlantic,  
   723  
 Temperature curve for the South  
   Atlantic, 723  
 Temperature, effect on evaporation,  
   568  
   of springs, 89  
   of sea, 721  
   on weather map, 624  
   zones, 688  
 Temperatures in South Atlantic, 725  
 Temporary base-level, 139  
 Terminal moraines, 257, 276  
 Terrestrial magnetism, 475  
 Texas, coast of, 461  
   model of, 36  
 Thermal equator, 602  
 Thermometer, 520  
   self-registering, 726  
 Thomson, Dr. C. Wyville, 757  
 Thrust-fault, 406  
 "Thunder-squall," 664  
 Thunder-storms, 610, 663, 666  
 Tidal currents, 736  
 Tidal poles, 741  
 Tidal races, 736  
 Tides, 729, 735  
   cause of, 736  
   effects of on shores, 748  
   lag of, 741  
   monthly variation of, 746  
   periodicity of, 736  
   rate of movement, 748  
 Timber jams, 308  
 Topographic features of shores, 317  
 Topographic relations, effect on tem-  
   perature, 545  
 Topographic unconformity, 332  
 Tornado near Chicago, 672  
   at Louisville, 670  
   at St. Louis, 669  
   at Rochester, Minn., 672  
 Tornadoes, 611, 657  
 Tower, N. S., 206  
 Trade-winds, 603, 617  
 Trade-wind zone, 687  
 Transportation by rivers, 127  
 Travertine, 101  
 Tributaries, growth of, 147  
 Tropic of Cancer, 501  
   of Capricorn, 501  
 Tropical belts of high pressure, 594  
   calms, 601, 617  
   cyclones, 611, 648  
   zone, 684, 685  
   climate of, 693  
 Turtle Mountain landslide, 106  
 Tuscarora deep, 711  
 Tyndall, J., 290  
 Typhoons, 655  
 Typhoon tracks, 659

- Udden, Prof. J. A., 78  
 Undertow, 318, 319, 729  
 Unequal heating of land and water,  
   effect on wind, 605  
 Unequal insolation, effect on winds,  
   598  
 Upham, Warren, 291, 337  
 Uranus, 504
- Valley, stages in history of, 148**  
 Valley breezes, 562  
   flats, 135  
   glacier, 219, 223  
   train, 266  
 Valleys, 118  
   courses of, 144  
   deepening of, 129  
   depth-limit of, 131  
   lengthening of, 140  
   widening of, 131  
   width-limit of, 134  
 Variable climate, 677  
 Veins, 100, 101  
 Velocity of wind, 613  
 Venus, 504  
 Vesuvius, 341  
 Volcanic "ash," 56, 368  
 Volcanic belts, 368  
   cinders, 368  
   cones, 378  
   dust, 56  
   eruptions, phenomena of, 366  
   gases, 368  
   glass, 367  
   mountains, 445  
   necks, 385  
   plugs, 385  
   vapors, 368  
 Volcano, 338  
 Volcanoes, active, 341  
   distribution, 368  
   explosive type, 340  
   number, 368  
   products of, 367  
   quiet type, 340  
   topographic effects of, 378  
 Vulcanism, 305, 338  
   causes of, 375  
   effect on coast-lines, 464
- Walcott, Dr. C. D., 206  
 Waldo, Frank, 511  
 Wall Lake, Iowa, 210  
 Ward, Prof. R. D. C., 511, 684  
 Warm currents, 721, 732  
 Warped shore-lines, 394  
 Warping, 405
- Washington, rainfall in, 619  
 Watchung Mountains, 387  
 Waterspouts, 673  
 Water surface, 85  
 Water table, 85  
 Water-vapor, 564  
   amount of, 568  
   of atmosphere, 512, 517  
   distribution of, 569  
   sources of, 565  
 Wave-cut terrace, 324  
 Waves, 318, 729  
   crest of, 318  
   deposition by, 324  
   erosive work of, 320  
   "fetch" of, 321  
   length of, 318  
   of translation, 319  
   period of, 318  
   trough of, 318  
 Weather Bureau, 622, 663  
 Weathering, 72, 76, 110, 129  
   conditions affecting, 111  
 Weather maps, 620, 627  
 Weather predictions, 656  
   failure of, 660  
   value of, 663  
 Weed, W. H., 113  
 Westerly winds, 603  
 West Indian storms, 653  
 Whirlwinds, 611, 666  
 Width-limit of valleys, 134  
 Wild, J. J., 757  
 Willis, Bailey, 206, 473  
 Wind, abrasion by, 70  
 Wind-carving, 70  
 Wind, cause of ocean movements,  
   728  
 Wind, direction, 613  
   in upper air, 606  
   effect on evaporation, 568  
   effect on shores, 330  
 Wind equator, 602  
 Wind-gap, 177  
 Wind gradient, 613  
 Wind, mechanical work of, 55  
 Wind roses, 609  
 Wind shown on weather maps,  
   622  
 Wind velocities, 613, 614  
 Wind zones, 686  
 Winds, affected by moisture, 569  
   deflected by rotation, 602, 604  
   due to unequal temperature, 561  
   effect on temperature, 543  
   gradational effect of, 62  
 Winter, defined, 531  
 Winter and summer, differences,  
   532

- Winter solstice, 499  
Woonsocket, artesian well at, 94  
Wyandotte Cave, 97, 101
- Yellow River of China, 196  
Yellowstone Canyon, 159  
Yellowstone Lake, 102  
Yellowstone National Park, 90, 103
- Young valley, 148  
Youthful topography, 152  
Youth of rivers, 150
- Zones of climate, 684  
  defined by isotherms, 687  
  by latitude, 685  
  by winds, 686



# Chamberlin and Salisbury's Geology

By THOMAS C. CHAMBERLIN AND ROLLIN D. SALISBURY,  
*Professors in the University of Chicago.* (American Science Series, Advanced Course.) 3 Volumes 8vo.

Volume I. Processes and Their Results. xix+654 pp. \$4.00  
Volumes II and III. Earth History. xxvi+692+xi+624 pp.  
*Vols. II and III not sold separately.* \$8.00.

**Chas. D. Walcott**, *Director of U. S. Geological Survey*:—I am impressed with the admirable plan of the work and with the thorough manner in which geological principles and processes and their results have been presented. The text is written in an entertaining style, and is supplemented by admirable illustrations, so that the student cannot fail to obtain a clear idea of the nature and work of geological agencies, of the present status of the science, and of the spirit which actuates the working geologist.

**Israel C. Russell**, *Professor in the University of Michigan*:—The work is certainly monumental, and, like Lyell's *Principles of Geology*, will in the future, I am confident, be recognized as marking the beginning of a new period in the development of the science of the earth.

**R. S. Woodward**, *Director of the Carnegie Institution*:—It is admirable for its science, admirable for its literary perfection, and admirable for its unequalled illustrations.

## College Geology

By T. C. CHAMBERLIN AND R. D. SALISBURY. (American Science Series.) xvi+978 pp. 8vo. \$3.50.

A one-volume text-book on the lines of the authors' widely known three-volume work. It supplies ample material for the average college course in geology.

**T. C. Hopkins**, *Professor in Syracuse University*:—I find it so far in advance of the other text-books I have seen that I decided to use it in my class.

**A. H. Purdue**, *Professor in the University of Arkansas*:—It probably will be the standard college text-book in Geology for several years to come.

**E. N. Lowe**, *Director of Geological Survey, Jackson, Miss.*:—It is an unrivaled text-book for a brief course in general geology.

HENRY HOLT & CO.

34 West 33d Street, New York  
623 So. Wabash Avenue, Chicago



## Salisbury's Physiography. Advanced Course

By ROLLIN D. SALISBURY, *Professor in the University of Chicago.* (American Science Series, Advanced Course.) xx+770 pp. 8vo. \$3.50.

While planned for courses in colleges and normal schools, it presupposes no previous study of physical geography.

**W. M. Davis, *Harvard University*:**—It is an important addition to college literature, the first book of college grade on physiography. The illustrations are for the most part remarkably successful and appropriate.

## Salisbury's Physiography for High Schools

By ROLLIN D. SALISBURY, *Professor in the University of Chicago.* (American Science Series, Briefer Course.) viii+531 pp. Large 12mo. \$1.50.

This is intended to cover the work in physical geography as given in the first or second year of the high school.

**W. H. Hawkes, *Ann Arbor (Mich.) High School*:**—I am of the opinion, after careful examination of the leading Physiographies on the market, that Salisbury's Briefer Course of Physiography is in the lead, in the method of treatment of the subject of Earth Science, its clearness of presentation of detail, and especially in the ways in which the subject matter is discussed in illustrative diagrams.

## Salisbury's Elementary Physiography

By ROLLIN D. SALISBURY, *Professor in the University of Chicago.* (American Science Series, Elementary Course.) xi+359 pp. 47 plates. Large 12mo. \$1.30.

This is particularly well adapted to first year pupils and short enough for a half-year course if need be.

**C. L. Walton, *Lake View High School, Chicago*:**—"It would seem that nothing further could be done in the way of perfecting a text-book in elementary physiography. As we are to have but five months of this study hereafter, I think no other book is so well adapted to our needs as this one."

HENRY HOLT & CO.

34 West 33d Street, New York  
623 So. Wabash Avenue, Chicago

## Elements of Geography

By ROLLIN D. SALISBURY, HARLAN H. BARROWS,  
and WALTER S. TOWER, *of the Department of Geog-*  
*raphy, University of Chicago.* (American Science Series.)  
ix+616 pp. 7 maps in color. 12mo. \$1.50.

A course in geography which is adapted to courses in colleges, normal schools and in the later years of the high school. It treats physiographic processes and features briefly and develops at greater length the relations of earth, air, and water to life and especially to human affairs.

**J. C. Branner, *Stanford University***:—It is a remarkably well written, well arranged, and well illustrated book, and is fairly bursting with information of the most trustworthy kind, and references to the best books and papers on special topics.

## Modern Geography

### The Effects of Physical Features on Living Things

By ROLLIN D. SALISBURY, HARLAN H. BARROWS,  
and WALTER S. TOWER, *of the Department of Geog-*  
*raphy, University of Chicago.* ix+496 pp. 7 maps in color.  
12mo. \$1.25.

This book is planned for use in the first or second year of the high school. Representing the "new" geography which stresses the geographic factor in human life, it lays a solid foundation of physiography but vitalizes it by constantly showing that broad physiographic principles underlie all commercial, industrial and economic activities of mankind.

**Caroline C. Haney, *Eastern High School, Detroit, Mich.***:—What we need in our curriculum is the humanizing of the technical so that the child may co-ordinate his everyday life and interests with his school work. This has been most successfully accomplished in *Modern Geography*.

## Laboratory Manuals of Geology and Physiography

By ROLLIN D. SALISBURY, *Professor in the University of Chicago*, and ARTHUR C. TROWBRIDGE, *Professor in the State University of Iowa.* 12mo. Paper, 25 cents each.

I. The Interpretation of Topographic Maps. 64 pp.

For beginning courses in physiography.

II. Studies in Geology. 68 pp.

Based on topographic maps and folios for classes in physiographic and structural geology.

III. Historical and Structural Geology. 76 pp.

**HENRY HOLT & CO.**

34 West 33d Street, New York  
623 So. Wabash Ave., Chicago







UNIVERSITY OF CALIFORNIA LIBRARY  
Los Angeles

This book is DUE on the last date stamped below.

NOV 9 1951

APR 21 1954

NOV 27 1959

Form L9-50m-11,'50(2554)444

The RALPH D. REED LIBRARY  
DEPARTMENT OF GEOLOGY  
UNIVERSITY of CALIFORNIA  
LOS ANGELES, CALIF.

UC SOUTHERN REGIONAL LIBRARY



**A** 000 582 760 5

UC SOUTHERN REGIONAL LIBRARY  
SERIALS ACQUISITION  
100 UNIVERSITY AVENUE  
ANN ARBOR MI 48106-1500  
TEL: 313/763-7000

