

MARINE BIOLOGICAL LABORATORY.

Received

June. 1905

Accession No.

226

Given by

Place,

****No book or pamphlet is to be removed from the Laboratory without the permission of the Trustees.**

202

MBL/WHOI



0 0301 0014292 3

THE
PHYSIOLOGY OF PLANTS

A TREATISE UPON THE
METABOLISM AND SOURCES OF ENERGY
IN PLANTS

BY

DR. W. PFEFFER

PROFESSOR OF BOTANY IN THE UNIVERSITY OF LEIPZIG

SECOND FULLY REVISED EDITION

TRANSLATED AND EDITED BY

ALFRED J. EWART, D.Sc., Ph.D., F.L.S.

WITH MANY ILLUSTRATIONS

VOLUME II

GROWTH, REPRODUCTION, AND MAINTENANCE

OXFORD
AT THE CLARENDON PRESS

M D C C C C I I I

HENRY FROWDE, M.A.
PUBLISHER TO THE UNIVERSITY OF OXFORD
LONDON, EDINEURGH
NEW YORK

2374

PREFACE TO VOL. II

IN pursuance of the plan adopted for the first volume, the present one, corresponding to Th. I, Bd. II of the German Edition, is issued as a book complete in itself. The Editor alone is responsible for the English rendering, and also for all matter enclosed in square brackets. In spite of these additions it has been found possible to compress the text considerably, while adhering strictly to the sense of the original German.

BIRMINGHAM,
Oct. 19, 1903.

CONTENTS

CHAPTER I

GROWTH

	PAGE
§ 1. General	1
2. Growth under Constant External Conditions	3
3. " " " " (continued)	7
4. Growth in Thickness and Growth-contraction	13
5. The Rapidity of Growth	15
6. The Measurement of Growth	19

CHAPTER II

THE MECHANICS OF GROWTH

7. General	24
8. The Growth of the Cell-wall	27
9. " " (continued)	31
10. The Growth of Starch-grains	35

CHAPTER III

GROWTH AND CELL-DIVISION

11. General	38
12. The Relation between Cellular and Nuclear Division	40
13. Mechanical Aids in the Differentiation of the Tissues	44
14. The Order of Cell-division	46

CHAPTER IV

THE ELASTICITY AND COHESION OF THE PLANT-BODY

15. Mechanical Strength and Rigidity	50
16. Elasticity and Cohesion of the Cell-wall	54
17. Elasticity and Cohesion of Tissues	57

CHAPTER V

THE STRAINS AND STRESSES IN TISSUES

18. General	61
19. The Development and Alteration of the Tissue-strains	65

CHAPTER VI

THE INFLUENCE OF THE EXTERNAL CONDITIONS ON GROWTH

PART I. GENERAL VIEW

	PAGE
§ 20. The Formal Conditions for Growth	68
21. Formative Reactions	71

PART II. THE INFLUENCE OF TEMPERATURE

22. The Cardinal Points for Growth	75
--	----

PART III. THE INFLUENCE OF LIGHT

23. General	84
24. Photomorphic Actions	85
25. The Reaction of a Phototonic Plant to Changes of Illumination	94
26. The Mode in which Light acts	98
27. The Action of Rays of Different Wave-length	101

PART IV. THE INFLUENCE OF MAGNETISM AND ELECTRICITY ON GROWTH

28.	106
-------------	-----

PART V. THE INFLUENCE OF GRAVITY AND OF CENTRIFUGAL FORCE ON GROWTH

29.	108
-------------	-----

PART VI. THE INFLUENCE OF CHEMICAL AGENCIES ON GROWTH

30. General	111
31. The Influence of Oxygen on Growth	114
32. Changes of Form produced by Chemical Agencies	115

PART VII. THE INFLUENCE OF THE PERCENTAGE OF WATER AND OF TURGIDITY

33. The Action on Vegetative Growth	118
34. The Influence on Form and Structure	120

PART VIII. THE INFLUENCE OF MECHANICAL AGENCIES ON GROWTH

35. Mechanical Actions	124
36. The Stimulus of Tension	127
37. Other Stimuli	129
38. Traumatic Effects	133

CHAPTER VII

THE CAUSES OF SPECIFIC SHAPE

39. General	136
-----------------------	-----

CONTENTS

vii

PART I. THE DIFFERENTIATION OF CELLS AND OF ORGANS		PAGE
§ 40. General		138
41. On Formative Induction and the Inherent Peculiarities of Cells and Organs .		141
42. Formative Induction (<i>continued</i>)		145
43. The Induction of Dorsiventrality		149
44. " " Polarity		154
PART II. CORRELATION AND REPRODUCTION		
45. General		161
46. Correlation		164
47. Reproduction and Regeneration		167
PART III. SYMBIOTIC REACTIONS		
48. Changes of Shape due to Symbiotic Interaction		170
49. Grafting and Graft-hybrids		173
50. Details concerning Symbiotic Unions and Interactions		176
PART IV. REVIEW OF THE INTERNAL FACTORS DETERMINING SPECIFIC SHAPE		
51. General		179
52. The Transference of Stimuli		181
53. " " (<i>continued</i>)		185
PART V. HYPOTHESES OF ULTIMATE STRUCTURE AND HEREDITY		
54. Theoretical		186
CHAPTER VIII		
VARIATION AND HEREDITY		
55. The Internal Conditions for Hereditary Variation		189
56. Facts concerning Variation		191
CHAPTER IX		
PERIODICITY OF GROWTH		
57. General		197
58. The Daily Periodicity of Growth		200
59. The Yearly Periodicity		204
60. The Influence of the External Conditions upon the Yearly Periodicity . . .		209
61. The Origin of Yearly Periodicity		212
62. Abscission and Leaf-fall		216
CHAPTER X		
THE POWER OF RESISTANCE TO EXTREMES		
PART I. THE CAUSES OF DEATH		
63. Death and Dormancy		219
64. Death and Senile Decay		221

PART II. RESISTANCE TO HEAT AND COLD		PAGE
§ 65. Supra-maximal Temperatures		224
66. Freezing and Cold-rigor		232
67. The Formation of Ice in Plants		239
68. How Cold causes Death		244
PART III. THE POWER OF RESISTANCE TO LIGHT		
69. The Injurious Action of Light		247
PART IV. THE EFFECTS OF THE WITHDRAWAL OF WATER		
70. Desiccation		249
71. Osmotic Agencies		256
PART V. CHEMICAL AGENCIES		
72. The General Properties of Poisons		258
73. The Detailed Action of Poisons		264
74. " " " <i>(continued)</i>		267
75. The Influence of Chemical Constitution on Poisonous Action		271
INDEX		275

PHYSIOLOGY OF PLANTS

VOLUME II. GROWTH, REPRODUCTION, AND MAINTENANCE

CHAPTER I

GROWTH

SECTION I. *General.*

METABOLISM necessarily accompanies all forms of vital activity, and hence also the growth and growth-movements occurring during the progress of development (cf. Vol. I, Chap. I). The character of the latter is determined by the inherited properties of the embryonic organism, and the formative activity is directed along a predetermined path leading ultimately to the production of a specifically distinct individual. It is not however possible to deduce the actual results as the necessary consequence of the given dispositions, that is from the interaction of various forms of energy with materials of definite structure. To render such deductive treatment possible still remains the ideal of Physiology, and only when this ideal has been attained shall we be able to obtain a comprehensive view of the interacting factors at work in the living organism.

In the present state of our knowledge, however, it will perhaps be best to treat the subject more empirically. Hence, neglecting special morphological peculiarities, we shall first deal with the character and progress of growth under normal and constant external conditions, and shall then discuss the mechanics of growth (Chap. II). The influence of the external (Chap. VI) and internal (Chap. VII) conditions upon growth will be treated as separate subjects.

The most difficult problems are those concerned with the autonomic direction and regulation of growth, and indeed our knowledge is here very fragmentary, for we are dealing with phenomena of extremely complex origin. Among the co-operating factors are the numerous and varied stimulating and mechanical interactions between different organs, between different cells, and between the different parts of the same protoplast. It is by interaction of this kind that the partial functions are correlated, and the character of the combination producing harmonious co-operation may differ according to the end in view (cf. Vol. I, Sect. 4).

Every form of growth is an automorphic change, that is, it is produced by the plant's own activity. The same is also the case when the external conditions modify the character or rapidity of the formative changes.

Hence the terms Photomorphosis, Chemomorphosis, Barymorphosis, merely indicate the forms of growth resulting from special external stimuli, and convey no information as to the internal factors involved, or as to the precise manner in which the changed mode of growth is produced. Nevertheless the various growth-reactions to special stimuli indicate the existence of specific powers and activities, and hence may enable the conditions for the existence of a particular organism to be determined, or may enable us to decide the importance of special external conditions in accelerating or retarding growth, or in modifying its character.

After a permanent form has been reached, and external growth has ceased, internal growth may still be possible. Instances of this are afforded by the sliding growth of certain cells, by the thickening of cell-walls, and by the intracellular formation and growth of starch-grains, as well as of crystals of proteids and of calcium oxalate. In the last two cases we are probably dealing with a simple process of crystallization, requiring only the accumulation or continued production of the crystallizing substance. On the other hand, the formation and growth of the cell-wall, and possibly also of starch-grains, are the result of protoplasmic activity. The production of a cell-wall composed of non-living substance is not however an essential condition of life, and it is precisely in the case of partial functions of this kind that causal relationships can most easily be traced. The complex mechanism of the protoplast, its mode of growth, and that of its organs form the fundamental and also the most difficult problems connected with vital activity. The varied mutual influences of cells upon each other depend upon the specific nature of the protoplasts they contain, and these influences may be such as to produce temporary or permanent modification in the structure of the protoplasts in question. Hence it is clear that we can more easily determine the means by which different cells and different organs influence each other, than we can the related processes taking place within the protoplast.

The different forms of growth may be classified according to their mode of origin, according to their biological importance, and according to the character of the external changes. Special terms are however not necessary for growth with and without cell-division, or for growth involving cell-fusion¹.

Growth by intussusception and by apposition are not always clearly distinct, and may also be accompanied by sliding growth.

The term growth may be used to indicate all formative processes leading to a change of shape or of structure. Growth is usually accompanied by an increase of volume, even although this may be due solely to the enlargement

¹ Cf. Wiesner, *Elementarstruktur*, 1892, pp. 194, 222; Roux, *Ergebnisse d. Anatomie u. Entwicklungsgesch. von Merkel u. Bonnet*, 1892, Bd. II, p. 434; *Programm d. Forschungsmethoden d. Entwicklungsmechanik*, 1897, p. 28. The occurrence of different modes of growth was mentioned by Meyer, *Pflanzenphysiol.*, 1838, Bd. II, p. 336.

of the intercellular spaces, and involve no increase of organic substance. A permanent change of shape may however occur without any change of volume, as for example when the growth in length of an organ is just counterbalanced by its decrease in diameter.

In all cases growth is a complex form of vital activity, in which metabolism, transformations of energy, and the incipient growth-changes themselves mutually influence and regulate each other. A supply of energy and of constructive material is therefore essential to growth, but even when both are available, growth may temporarily or permanently cease unless the protoplast can utilize them in the proper manner. The fact that a continuous supply of plastic material forms an essential condition for progressive growth, at once shows the importance of adequate nutrition.

Growth and development form an integral part of Physiology, and the study of the causes underlying them involves that of vital activity in general. The matter has long been treated from this point of view by botanists¹, and as much as a century ago numerous researches were performed which had as their aim the causal explanation of particular processes of growth.

Animal physiologists have hitherto mainly confined themselves to the study of the adult animal, although Bernard² pointed out that a causal explanation of the facts of development formed one of the tasks of Animal Physiology. Recently however numerous experiments have been made in this direction by zoologists³. There is however no reason for considering 'the mechanics of development,' as Roux calls it, to form a subject apart from Physiology.

The same problems and methods of research apply to animals as to plants, and many of the theoretical considerations of Driesch, Roux, and others deal with factors which have not only been long recognized in the case of plants, but have even found practical use.

SECTION 2. Growth under Constant External Conditions.

The entire character of the development of a plant and of its individual organs suffices to show that all the peculiarities of external form and internal structure are the result of the self-regulation of growth as regards its amount and character, as well as its localization in time and space⁴. In most plants

¹ Cf. the first edition, 1881, Bd. I, Introduction; Bd. II, chaps. iv, v; Sachs, *Lehrbuch der Botanik*, 1873; Vöchting, *Ueber Organbildung im Pflanzenreich*, 1878, pp. 4, 241. In these works not only are the attained facts discussed, but also the future aims of research are indicated. Hofmeister (*Allgem. Morphol.*, 1868), in spite of numerous errors in detail, made a praiseworthy attempt to place the facts of morphology and development upon a physiological basis. On the other hand, Nägeli (*Die Stärkekörner*, 1858) attempted to derive the shape and growth of starch-grains from the molecular reactions which give rise to them, and thus to explain their growth upon a molecular basis.

² Bernard, *Leçons sur les phénomènes de la vie*, 1885, Vol. I, p. 390.

³ Roux, *Programm u. Forschungsmethoden d. Entwicklungsmechanik*, 1897, p. 171, and the literature there quoted. On the scope of Physiology, cf. Vol. I, p. 8 of this book. Also Driesch, *Ergebnisse d. Anat. u. Entwicklungsgesch. von Merkel u. Bonnet*, 1898, Bd. VIII, p. 712.

⁴ We are not concerned either with the details of adult structure, or of development. Cf. Hofmeister, *Allgem. Morphologie*, 1863; Goebel, *Vergl. Entwicklungsgeschichte d. Pflanzenorgane*, 1883; *Organography*, 1900.

(Somatophytes) growth results in the production of adult parts and organs, whereas in such asomatic plants as bacteria, *Spirogyra*, and *Oscillaria* the products of growth may retain their embryonic character, and remain capable of growing and reproducing new individuals. This is only possible in small and lowly organized plants, for masses of embryonic cells do not possess the strength and rigidity required by large plants, and the embryonic character is usually lost in tissues or organs which undergo pronounced morphological and physiological differentiation.

Since the somatic parts must die sooner or later¹, the preservation of embryonic cells is necessary for the maintenance of the species. Spores and fertilized ova are in fact embryonic cells, and cuttings are able to produce new individuals because certain of their tissues remain embryonic and are able to reproduce missing parts.

In addition to forming new individuals, Somatophytes also retain embryonic cells and tissues which continually add new parts and organs to the parent plant, frequently until death ensues. These meristematic cells and tissues found at the growing points and along the cambial zones remain continually young, while the cells segmented from them give rise directly or after previous division to new tissue elements. These may either be superposed upon older ones, as when the stem of a tree increases in thickness, or may give rise to new organs, such as the new leaves formed upon a deciduous tree in spring.

The growth of an annual plant is also the result of the activity of locally preserved regions of embryonic tissue, and in many plants intercalary vegetative zones of longer or shorter duration may be produced in order to attain special ends².

Owing to this power of continued growth, combined with the fixed habitat, the life of most plants assumes a widely different character to that of a typical animal, which may live long after a permanent adult form and size have been attained. But even here there is no essential difference between the two kingdoms, for sponges and corals simulate plants in their fixed habitat and continuous growth, while in many of the lower animals and plants no definite somatic parts are as yet differentiated.

Since all living beings are derived from similar pre-existent ones, it follows that the continuity of the embryonic plasma is essential for the maintenance of a particular species. In other words, the consecutive generations are linked together by the embryonic substance to a single rhythmically repeated series. Since the ontogeny of a particular species always begins with the same embryonic materials, it must naturally follow the same path so long as the species remains constant.

¹ On the duration of life in somatic and embryonic cells cf. Sect. 64.

² For examples see Goebel, *Entwicklungsgesch. d. Pflanzenorgane*, 1883, pp. 153, 179, 212; Hofmeister, *Allgem. Morphol.*, 1868, pp. 240, 465. Cf. also Sect. 3.

No such direct repetition is possible in the case of those somatic cells which undergo permanent tissue differentiation, and hence whose development terminates with the assumption of their adult form. During this development very great growth in size may take place, as for example when a young internode of *Phascolus* or *Humulus* elongates more than a hundred times, or when a tiny leaf-rudiment develops into a large adult leaf. At first this increase in size is usually accompanied by cell-division, but the latter gradually decreases, so that usually the most active growth is mainly or entirely due to the increase in size of the individual cells.

The most rapid growth in Somatophytes usually takes place a little behind the growing apex, and hence a comparatively small amount of cell-division in the primary meristem is sufficient to give rise to a considerable total growth. All plants do not however follow this rule, which indeed does not apply at all to Asomatophytes. For example, in the case of bacteria, remarkably active growth in size takes place in embryonic cells, while in the rapidly growing hyphae of *Botrytis*, *Mucor*, and *Aspergillus*, the growing zone is restricted to the extreme apex, and is frequently not longer than the diameter of the hypha¹. Similar relationships hold good for such algae as *Vaucheria* and *Caulerpa*², for rhizoids and moss protonemas, and even for the root-hairs of Phanerogams³. Hence Sachs' supposition that the most active growth could never occur at the embryonic apex is obviously incorrect. Indeed Westermaier found that in the growing apices of Vascular Cryptogams the most active increase in size takes place in or near to the apical cell⁴.

In the case of the unicellular Somatophytes *Vaucheria* and *Mucor*, the entire plant retains the embryonic condition, but the growth of the cell-wall, and hence the elongation of the filaments or hyphae, takes place at their apices only. The same applies to *Aspergillus*, *Penicillium*, and *Sphaclaria*⁵, in which plants transverse divisions appear a little distance behind the growing apex. On the other hand, the lateral outgrowths of Characeae, *Pterothamnion*, and *Callithamnion*⁶ are formed from segments of

¹ On *Botrytis* see Reinhardt, Jahrb. f. wiss. Bot., 1892, Bd. XXIII, pp. 494, 554, and the literature there quoted; also Eidam, Cohn's Beiträge, 1887, Bd. IV, p. 209; *Mucor*: Errera, Bot. Ztg., 1884, pp. 535, 564.

² Askenasy, Neue Methode, d. Vertheilung d. Wachstumsintensität zu bestimmen, 1878, p. 28 (Verhandlgn. d. naturw.-med. Vereins zu Heidelberg, N. F., Bd. II, Heft 2); Berthold, Protoplasma-mechanik, 1886, p. 274; Reinke, Ueber *Caulerpa*, 1899, p. 71 (Wissenschaftl. Meeresunters., Kiel, N. F., Bd. v).

³ Haberlandt, Function u. Lage des Zellkerns, 1887, and Oesterr. Bot. Zeitschrift, 1889, No. 3; Reinhardt, l. c., p. 552; Sokolowa, Wachstum der Wurzelhaare u. Rhizoiden, 1897.

⁴ Sachs, Vorlesungen, 1887, 2. Aufl., p. 558; Westermaier, Jahrb. f. wiss. Bot., 1879-1881, Bd. XII, p. 439.

⁵ Geyler, Jahrb. f. wiss. Bot., 1865-1866, Bd. IV, p. 479; Pringsheim, Ueber d. Gang d. morphol. Differencirung d. Sphaclarien-Reihe, 1873, p. 145.

⁶ Nägeli, Pflanzenphysiol. Unters., 1855, Bd. I, p. 60; Askenasy, l. c., p. 28.

the apical cell, which undergo pronounced subsequent growth. Similarly, in many mushrooms and other large fungi¹ the products of apical division elongate considerably before ceasing to grow.

In flowering plants, the embryonic cells form the leaf-primordia, and hence determine the number and position of the appendicular organs, which attain their adult shape by subsequent growth. The first stage in the development of an organ was hence termed by Sachs² the morphological period, and the second, the physiological or biological period. It must however be remembered that the progress of development is continuous, so that there is no sharp line of demarcation between the two periods.

Nor can any sharp line of division be drawn between somatic and embryonic cells, for independently of the fact that under special circumstances vegetative apices may remain permanently dormant, numerous instances are known of somatic cells returning to an embryonic condition as the result of injury or of other influences. Moreover, such plants as *Vaucheria*, *Mucor*, &c., occupy an intermediate position between Somatophytes and Asomatophytes, while certain somatophytic fungi when submerged in a culture fluid develop an asomatophytic yeast-form.

It can easily be understood that the character of the cell is not always indicated by its microscopical appearance. The meristematic cells of flowering plants are however usually highly protoplasmic and possess relatively large nuclei. In the cells of *Spirogyra* however the nucleus is small, and the protoplasm mainly restricted to a peripheral film, but nevertheless the protoplasts remain capable of division and of reproducing new individuals after fusion or rejuvenescence. It is therefore uncertain whether the occurrence of solid protoplasts in primary meristems is mainly for the purpose of allowing rapid subsequent growth in bulk without the mass of protoplasm increasing, or whether this condensation of the protoplast has quite a different importance.

Every cell and part of a cell, every organ and the entire plant as well, pass more or less rapidly through a specific progress of development whose character is primarily determined by internal causes. This 'grand period of growth'³ has definite limits and attains a maximum at a particular phase of development, besides frequently exhibiting secondary maxima.

¹ De Bary, *Morphol. u. Biologie d. Pilze*, 1884, p. 53; A. Möller, *Schimper's bot. Mitthlg. a. d. Tropen*, 1895, Heft 7, p. 119.

² For further details see Sachs, *Flora*, 1893, p. 217; similar views were expressed by Harting, *Linnaea*, 1847, Bd. XIX, p. 474; cf. also Wiesner, *Sitzungs. d. Wiener Akad.*, 1883, Bd. LVIII, Abth. I, p. 464.

³ Correctly interpreted by Harting, *Linnaea*, 1847, Bd. XIX, pp. 447, 557; *Waarnemingen over d. groei van den plantenstengel*, 1867; cf. also Sachs, *Jahrb. f. wiss. Bot.*, 1860, Bd. II, p. 344; *Arbeit. d. Würzburger Instituts*, 1874, Bd. I, p. 190; and Wiesner, *Sitzungs. d. Wien. Akad.*, 1883, Bd. LXXXVIII, Abth. I, p. 464. The term 'grand period of growth' was first used by Sachs, *Lehrb.*, 1873, 3. Aufl., p. 731.

This law applies to animals as well as to plants, and it is not surprising that the grand periods for different organs, and even for special functions also, do not necessarily coincide either in amount or in time.

The growth-curve of an internode usually exhibits a single maximum only, whereas that of an entire tree shows annual summer maxima and winter minima in temperature climes. In tropical regions the maxima and minima occur during the wet and dry periods. The total annual growth in mass however attains a maximum at a certain age¹, before or after the first flowering and fruiting². The leaves and internodes³ on every shoot increase in size from below upwards, and the length of the cells increases to a maximum and then decreases again as we ascend a stem or pass outwards through successive annual rings⁴.

These differences are the result of processes of regulation and correlation, which even determine the position and size of the young primordia. That the size of the primordium is only of limited importance is shown by the fact that the primordium of a prophyll may be caused to develop into a foliage leaf.

According to Hartig (l. c.) and Moll (l. c.) the shortness of the basal internodes of a branch is due to fewer embryonic cells being devoted to their formation. The unequal size of the adult internodes of *Nitella* and *Chara* is however obviously produced by the different increase in length of the various segment-cells⁵.

SECTION 3. Growth under Constant External Conditions (*continued*).

A brief description of a few typical instances of growth may be of use to the general reader. For example, the different phases of growth can best be traced upon a growing root-apex⁶ by placing equidistant lines of Indian ink upon it, and observing the rapidity and amount of growth in the regions thus distinguished (Fig. 1). It can then be seen that the activity of growth in the segment-cells increases, until, owing to their own growth and that of the parts in front of them, they become from four to

¹ Cf. Hartig, *Lehrb. d. Anat. u. Physiol.*, 1891, pp. 259, 267.

² Vöchting, *Organbildung im Pflanzenreich*, 1884, II. Th., p. 127; Möbius, *Lehre von d. Fortpflanzung der Gewächse*, 1897, p. 88.

³ This was known to Hales, *Statics*, 1784, p. 184, and was further studied by Moll, *De invloed van celdeeling en cellstreking op den groei*, 1876. Cf. also Wiesner, l. c., p. 467; L. Montemartini, *Ricerche intorno all' accrescimento delle piante*, 1897, p. 6 (*Atti dell' istituto Botanico di Pavia*); Büsgen, *Bau u. Leben der Waldbäume*, 1897, p. 6. The variation in the size of leaves was known from Goethe onwards.

⁴ Sanio, *Jahrb. f. wiss. Bot.*, 1872, Bd. VII, p. 402; Hartig, l. c., p. 286; Büsgen, l. c., pp. 110, 116.

⁵ Cf. also Askenasy, l. c., 1878, p. 30.

⁶ Sachs, *Arbeit. d. Bot. Inst. in Würzburg*, 1873, pp. 414, 590. The main features were correctly determined by Ohlert, *Linnaea*, 1837, Bd. XI, p. 615; Wigand, *Bot. Unters.*, 1854, p. 159; Hofmeister, *Jahrb. f. wiss. Bot.*, 1863, Bd. III, p. 96; Frank, *Beiträge z. Pflanzenphysiol.*, 1868, p. 34; N. J. C. Müller, *Bot. Ztg.*, 1869, p. 387; 1871, p. 727; Cisielski, *Cohn's Beiträge*, 1871, Bd. I, II, p. 3. Cf. also Wettstein, *Sitzungsb. d. Wiener Akad.*, 1884, Bd. LXXXIX, Abth. 1, p. 59.

five millimetres distant from the apex (Figs. 1 and 2). From this point the rapidity of growth steadily decreases, and ceases at a distance from

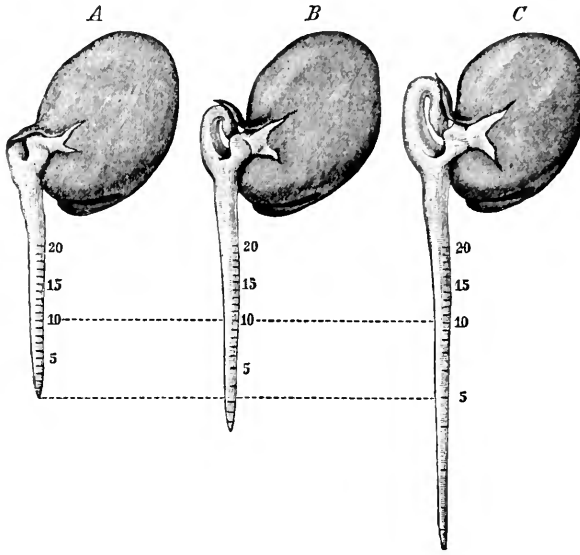

FIG. 1. Seedling of *Vicia Faba* (nat. size). *A* marked with lines of Indian ink 1 mm. apart; *B* after 6 hours', and *C* after 24 hours' growth at 23°, in moist sawdust behind a glass plate. *B* has increased 4.6 mm., *C* 20 mm. in length.

the extreme apex of ten millimetres.

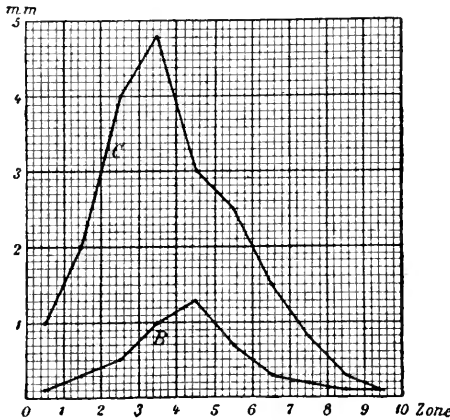

FIG. 2. Graphic representation of the amount of growth in the zones 0 to 10 in Fig. 1. *B* after 6 hours, *C* after 24 hours.

It is therefore evident that the elongation of the root is mainly due to the growth in length of the segment-cells just behind the actual apex. The localization of growth given by this means is never perfectly exact, but is correct in the main if the total amount of growth is not too great, so that the marks do not become too widely separated.

This mode of growth applies to all roots, including aerial roots, in which the growing zone may attain a length of 30 or even 110 mm.¹ The growing zone

¹ Sachs, l. c., 1874, Bd. 1, p. 593; Went, Ann. du Jard. Bot. d. Buitenzorg, 1895, T. XII, p. 20. In the slowly growing aerial roots which function as tendrils, the growing zone is no longer than in the case of subterranean roots. It may however be 20 mm. in length in the root-tendrils of *Vanilla aromatica*. Cf. Ewart, Ann. du Jard. Bot. de Buitenzorg, T. XV, 1898, pp. 234, 237.

usually does not exceed 10 mm. long in terrestrial and aquatic roots, and may not be more than 2 to 3 mm. in length in very small roots, or even less in other small objects. The latter form a transition to those fungi in which growth in length is restricted to the extreme apex of the elongating hypha, so that the growing zone may be less than 0.01 mm. long, and no distinction between embryonic and growing zones is possible.

Very small objects may be dusted with starch, red lead¹, &c., or accidentally adhering particles may be used as marks, as may also local thickenings, pits, &c.² The length of the growing region can also be estimated from the relative length of the internodes at the growing apex, or of the cells in the case of an algal filament. Thus in Fig. 3, if the cell 4 is equal in length to 5, it has ceased to grow, and if when 3 becomes equal to 4, a new segment 2 has appeared, it is evident that the zone of growth extends as far as the third segment. The method is not however very accurate, since all the cells and internodes do not attain the same adult length³.

At the apex of the stem the products of division develop differently, according to whether they form part of a nodal or internodal zone, for it is only the latter region that undergoes pronounced growth in length when a bud unfolds. The same applies to *Nitella*, in which alternate segments from the apical cell form the nodes and internodes.

Frequently also the activity of growth differs in different parts of the same internode, as for example when intercalary zones of growth are present at the bases of the internodes, as in the stems of grasses, docks, Equisetums, Cannas, &c. These zones have only a limited power of growth, which may suffice to add as much as 80 mm. to the length of an internode of *Polygonum orientale* and *Canna indica*, or even more than this in *Molinia caerulea*⁴. Many leaves (*Allium*, *Tulipa*, *Welwitschia*)

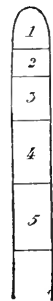

FIG. 3. Diagram of a row of cells growing apically.

¹ Haberlandt, Function u. Lage d. Zellkerns, 1887, p. 55; Reinhardt, Jahrb. f. wiss. Bot., 1893, Bd. XXIII, p. 552; Pfeffer, Unt. a. d. Bot. Inst. zu Tübingen, 1886, Bd. II, p. 277, footnote; Ewart, Trans. Liverpool Biol. Soc., Vol. VIII, 1894, p. 243. [Platinum black or the precipitated oxides of manganese are much more suitable.]

² For examples see Nägeli, Pflanzenphysiol. Unters., 1855, Bd. I, p. 60; Nägeli and Schwendener, Mikroskop, 1877, 2. Aufl., p. 545; Noll, Unters. über das Wachstum d. Zellmembran, 1887, p. 129; A. Nathansohn, Jahrb. f. wiss. Bot., 1898, Bd. XXXII, p. 671.

³ Details are given by Askenasy, l. c., 1878, Bd. II, p. 1 seq.

⁴ Grisebach, Archiv f. Naturgesch. von Erichson, 1843, Bd. IX, 1, p. 275, and 1844, Bd. X, 1, p. 134. Also Hartig, Linnaea, 1847, Bd. XIX, p. 479; Münter, Linnaea, 1841, Bd. XV, p. 209, and Bot. Ztg., 1843, p. 69; Sachs, Arbeit. d. Würzb. Inst., 1872, Bd. I, p. 127, and Flora, 1873, p. 323; Strehl, Unters. über Längenwachstum d. Wurzel u. des hypocotyl. Gliedes, 1874; Bennet, Bot. Jahrb., 1876, p. 743; Askenasy, l. c., 1878; Rützw., Bot. Centralbl., 1882, Bd. IX, p. 82; Wiesner, Sitzungsber. d. Wien. Akad., 1883, Bd. xcVIII, Abth. 1, p. 454; Schwendener and Krabbe, Jahrb. f. wiss. Bot., 1893, Bd. XXV, p. 340; Rothert, Cohn's Beitr. z. Biologie, 1896, Bd. VII, p. 77. Summaries are given by Hofmeister, Allgem. Morphol., 1868, pp. 417, 528. Cf. also Goebel, Vergl. Entwicklungsgeschichte der Pflanzenorgane, 1883.

continue to grow for a long time by means of a basal intercalary vegetative zone. The progress of development of the varied forms of simple and compound leaves suffices to indicate the existence of extremely complex growth relationships, and localized zones of active growth may appear simultaneously in the lamina and also in the petiole¹.

Not only apical and intercalary vegetative zones, but also zones in which only growth in length is active, may be present in trichomes, and also in the filaments of algae and fungi². *Oedogonium* affords an excellent example of localized intercalary growth due to the rapid stretching of a ring of cellulose deposited previously³. Moreover, the remarkable forms assumed by unicellular Diatoms and Desmids suffice to indicate that localized differences of growth are possible even in cells which retain their embryonic character⁴.

The progress of development at once shows that the different members of the same plant do not all grow at the same rate, or to the same size. Hence the curves representing the grand periods of growth may be low and flat in one case, but steep and abruptly ascending and descending in another. Similarly the curve may or may not exhibit secondary maxima and minima. When stipules serve as bud-scales they develop more rapidly than the other parts of the leaf, and hence possess a different growth-period. In some cases a gradual preparation is made during a period of slow growth for a sudden and rapid developmental activity. Thus the stalk of the sporogonium of *Pellia epiphylla* for a period of several months does not elongate more than 1 or 2 mm., and may then suddenly grow as much as 80 mm. in length within three or four days⁵. Similarly, after the winter buds have been formed on a deciduous tree, their growth entirely, or almost entirely, ceases for a time, and it never recommences in those buds which remain permanently dormant.

A good example of the influence of correlation in retarding growth is afforded by the sporangiophore of *Phycomyces nitens*, whose grand period

¹ Hofmeister, l. c., p. 519; Goebel, l. c., p. 212; Stebler, Jahrb. f. wiss. Bot., 1878, Bd. XI, p. 17; Sonntag, *ibid.*, 1887, Bd. XVIII, p. 246; Uhlitzsch, *Unters. über das Wachstum der Blattstiele*, 1887, and *Neue Beitr. z. Wachstum der Blattstiele*, 1887; Rothert, l. c., p. 28; Meissner, *Bot. Ztg.*, 1897, p. 203 (Conifer leaves); Goebel, *Organography*, 1901, Clar. Press, p. 503; Arnoldi, *Flora*, 1900, p. 440. On floral leaves see Pfitzer, *Verhandl. d. naturh.-med. Vereins zu Heidelberg*, 1882, N. F., Bd. II, Heft 2; Janse, *Bot. Centralbl.*, 1888, Bd. xxxiv, p. 325. On tendrils, &c., cf. Chap. XII.

² For examples see the literature quoted in Sect. 2; those of Nägeli, Askenasy, and Berthold deal with the growth in length of the segment-cells. On *Cladophora* see Klebs, *Unters. a. d. Bot. Inst. zu Tübingen*, 1888, Bd. II, p. 536; Brand, *Bot. Centralbl.*, 1899, Bd. LXXIX, p. 145; Nordhausen, *Jahrb. f. wiss. Bot.*, 1900, Bd. xxxv, p. 367. On hairs see Hirsch, *Fünftück's Beitr. z. wiss. Bot.*, 1900, Bd. IV, p. 1.

³ Hofmeister, *Pflanzenzelle*, 1867, p. 102; Nägeli and Schwendener, *Mikroskop*, 1877, 2. Aufl., p. 546; Berthold, *Protoplasmamechanik*, 1886, p. 275.

⁴ Concerning the unequal growth of cells of *Spirogyra* see Hofmeister, *Jahreshefte d. Vereins f. vaterl. Naturkunde in Württemberg*, 1874, Bd. xxx, p. 219.

⁵ Askenasy, *Bot. Ztg.*, 1874, p. 237. On the stamens of grasses see Sect. 5.

of growth, as determined by Errera¹, is graphically represented in Fig. 4. The retardation and stoppage of growth at the end of the first day occur when the plant's energies are directed towards the production of the sporangium. After this the stalk rapidly increases in length, until towards the end of its development the hourly increments of growth slowly decrease. The same applies to the sporangiophores of *Mucor mucedo* and of many other Mucorini, whereas that of *Pilobulus crystallinus* ceases to grow as soon as the sporangium is formed. In this case the grand period of growth is represented by the first part of the curve in Fig. 4. In the absence of light the sporangia of *Pilobulus* are not produced, and the sporangiophore continues its apical growth until long sterile filaments are formed².

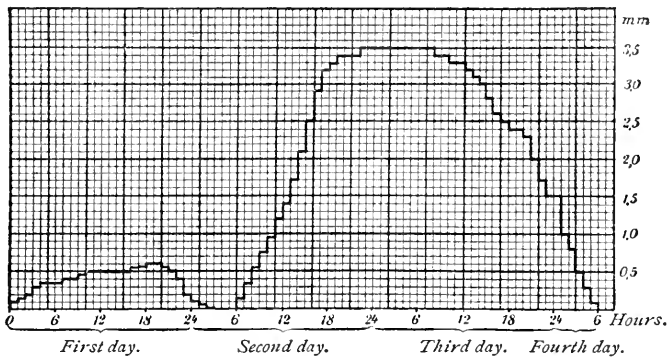

FIG. 4. Curve of grand period of growth of sporangiophore of *Phycomyces nitens* during development under favourable and constant external conditions. The ordinates give the hourly increments of growth in millimetres.

The relation between the regions where growth by cell-division and growth by cell-stretching are active, differs in stems as well as in roots, and the total length of the growing region may also vary considerably. In some plants it may be from 1 to 5 centimetres long, whereas in others, and especially in climbing plants, it may attain a length of from 10 to 50 centimetres. The growing zone may include either a small or large number of internodes, of which usually a few, but sometimes not more than one or two, have escaped from the bud and are undergoing active elongation³.

At the end of summer these latter zones are gradually transformed into permanent tissue, and fresh growing zones reappear in spring when the buds unfold. The same change can be produced by mechanically arresting growth. Thus after a root has been imbedded for some time in

¹ Errera, Bot. Ztg., 1884, p. 501 and plate 8.

² Gräntz, Ueber d. Einfluss des Lichtes auf d. Entwicklung einiger Pilze, 1898, p. 10. (Cf. Sect. 24.)

³ For details see Askenasy, l. c. (Neue Methode, &c.), 1878, p. 74. On rhizomes see Stahl, Ber. d. Bot. Ges., 1884, p. 384.

a plaster of Paris cast, only the meristematic apex remains capable of growth¹.

Changes must also occur whenever the relationship between the vegetative and elongating zones is disturbed, whether by internal or external agencies. Thus the length of the growing zone usually increases when growth becomes more active², and also when the stem is etiolated³, while the temperature, supply of water, and other external factors may also influence it⁴.

All growing zones must be sufficiently protected from unfavourable external influences, for soft meristematic tissues are especially liable to mechanical injury, and also readily shrivel when exposed to dry air. Hence the embryonic tissues in the bud are protected by the sheathing leaves, as is also the cambium cylinder by the layers of bark or cortex which enclose it. Similarly the root-cap shields the growing apex of the root as it grows between and forces apart the particles of soil. Indeed a protective covering is seldom absent from large growing apices, although the more minute growing ends of hairs, fungal hyphae, and rhizoids are naked, and a few roots even do not possess a root-cap. Growing apices of small diameter are relatively more resistant than larger ones, and hence on this account alone are more capable, even when without any special protection, of withstanding the different external influences to which they are exposed.

Intercalary vegetative zones can withstand direct pressure amounting to from 3 to 5 or more atmospheres, but must also be sufficiently strengthened to bear the strains and torsions due to the total weight of leaves and stem above them. This is commonly attained by the development of investing sheaths, which serve at the same time as

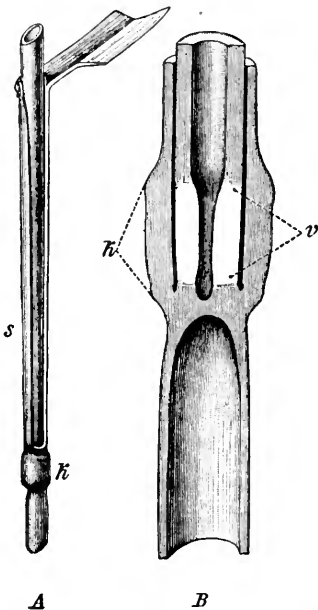

FIG. 5. Portion of stem of *Secale cereale*. A, nat. size. A portion of the leaf-sheath has been removed as far as the node *k*. B, longitudinal section through the node *k* magnified four diameters; *v*, growing intercalary zone at base of internode.

¹ Pfeffer, Druck- u. Arbeitsleistungen, 1893, pp. 352, 381.

² Hofmeister, Allgem. Morphol., 1868, p. 421; Sachs, Flora, 1873, p. 322; Askenasy, l. c., p. 74; Wettstein, Sitzungsber. der Wiener Akad., 1884, Bd. LXXXIX, p. 92; Rothert, Cohn's Beiträge z. Biologie, 1896, Bd. VII, p. 125; Montemartini, Ricerche intorno all' accrescimento d. piante, 1897, p. 9 (Atti d. Istituto Bot. d. Pavia). Cf. also Errera, Bot. Ztg., 1884, p. 536.

³ Cf. Strehl, Unters. ü. d. Längenwachstum d. Wurzeln, 1874, pp. 15, 21.

⁴ Cf. Askenasy, Ber. d. Bot. Ges., 1890, p. 82; Popovici, Bot. Centralbl., 1900, Bd. LXXXI, p. 33

a protection from the external world. The young stems of grasses and of *Cannas* are unable to bear the weight of the upper parts when the sheaths are removed, and hence sink downwards.

In the leaves of *Canna* and *Tulipa*, as well as in the stems of grasses, large transpiring surfaces lie above the vegetative zones. Hence large quantities of water and of food-materials must pass through the latter. It is probably of considerable importance that these growing zones, although they consist mainly of embryonic cells, also include a few spiral and annular vessels, and that the total length of the zone is always small. Further research is however necessary to determine the precise manner in which the necessarily rapid transmission of water and food-materials takes place through these meristematic zones¹.

SECTION 4. Growth in Thickness and Growth-contraction.

The grand period of growth in thickness can be determined from observations on the progress of development². These show that in the trees of temperate regions the annual grand period of growth of the xylem begins, and also ends, sooner than that of the phloem³. That the cambium should produce new tissues on both sides, and that it should be pushed outwards by the growth of the xylem cylinder, are facts which call for no special comment. The same happens in fact in many intercalary vegetative zones, and the growing apex of the root produces dermatogen segments on one side, and periblem and plerome segments on the other, while the latter by their subsequent growth push the root-apex onwards.

A definite correlation exists in each specific case between growth in thickness and growth in length. In some cases both are equally active, whereas in most stems and roots active growth in thickness begins in regions which have ceased to elongate. Occasionally a slight decrease in the diameter takes place after the commencement of active elongation, and similarly growth in thickness may be accompanied by a shortening of the organ affected. This latter occurs to a pronounced extent in many roots, those parts which have ceased to elongate contracting in length as secondary growth commences.

¹ Cf. A. Nathansohn, *Jahrb. f. wiss. Bot.*, 1898, Bd. XXXII, p. 671.

² Cf. de Bary, *Anat.*, 1877; Haberlandt, *Physiol. Anat.*, 1896, 2. Aufl., p. 490. Also M. Nordhausen, *Beitr. z. wiss. Bot. v. Fünftstück*, 1898, II, p. 356; Schwarz, *Physiol. Unters. ii. Dickenwachstum von *Pinus sylvestris**, 1898. On the grand period of growth in trees see Th. Hartig, *Lehrb. d. Anat. u. Physiol.*, 1891, p. 264; Jost, *Ber. d. Bot. Ges.*, 1892, p. 587; Christison, *Bot. Jahresb.*, 1894, I, p. 223; Reuss, *Bot. Centralbl.*, 1893, Bd. LV, p. 348; Schwarz, l. c. On the grand period of growth in thickness in other plants see Montemartini, l. c., 1897, p. 15; Macmillan, *American Naturalist*, 1891, p. 465 (Potato); F. Darwin, *Ann. of Bot.*, 1893, Vol. XXVIII, p. 459 (Cucumber).

³ Strasburger, *Bau u. Verrichtung d. Leitbahnen*, 1891, pp. 482, 500; Hülscher, *Bot. Centralbl.*, 1883, Bd. xv, p. 303.

The total contraction may amount in the course of two or three weeks to 10 per cent. of the length of the radicle of the beet-root, and 25 per cent. of the length of that of the clover¹. In the case of the roots of *Arum maculatum* and *Agave americana*, a shortening of as much as 50 per cent., and in those of *Oxalis elegans* even as much as 70 per cent., of the lengths of the roots has been observed². A slight shortening was also observed by Rimbach in the hypocotyls of a few seedlings (*Taraxacum*, *Atropa Belladonna*)³, and a more pronounced one by Berthold on the rhizoids of *Antithamnion cruciatum*⁴. In the latter case the filaments grow apically, and the segment-cells subsequently broaden and decrease in length by from 30 to 50 per cent.

By contractions of this kind the plants can be drawn deeper into the soil as soon as the younger parts of the roots have become sufficiently firmly attached, and indeed it may happen that the seedling is even drawn beneath the surface. It is by the annually repeated contraction of the roots that those rhizomes, bulbs, and tubers which grow vertically or obliquely upwards are kept imbedded in the soil. In order that the same constant depth may be maintained, a certain power of regulation is necessary, which is attained in the cases mentioned either by the non-formation of the contractile roots under the conditions existing beneath a certain depth, or by their assuming a horizontal direction of growth. Many plants normally produce contractile and non-contractile roots at the same time, while in others only the latter variety are formed⁵.

In the rhizoidal cells of *Antithamnion* it can be directly seen that the shortening is due to an active change of shape of living cells. In contractile roots the active cells are present in the inner cortex, and, according to de Vries, also in the central pith of fleshy roots. These cells shorten as they broaden, but their tendency to change of shape acts against, and is partially antagonized by, the wood-cylinder and epidermis to which the contractile tissues are attached. The wood-cylinder and epidermis are at first stretched by the actively growing cortex and pith, but when the latter tissues shorten, the wood and epidermis are subjected to longitudinal compression. These alterations in the tissue-strains can be seen by isolating the respective tissues and noting their changes of shape. They are also frequently indicated in the intact root by the folding and crumpling of the outer surface, and by the wavy curvature of the vascular cylinder. If the turgor of the thin-walled active cells is removed by plasmolysis, the root elongates slightly.

¹ De Vries, Landw. Jahrb., 1880, Bd. IX, p. 37; 1879, Bd. VIII, p. 474; 1877, Bd. VI, p. 928.

² Rimbach, Fünfstück's Beitr. zur wiss. Bot., 1897, Bd. XI, p. 1; 1899, Bd. XIII, p. 20, where the remaining literature is given. The drawing of seedlings into the soil was observed by Tittmann, Flora, 1810, Bd. II, p. 653.

³ Cf. also Jost, Bot. Ztg., 1890, p. 435.

⁴ Berthold, Jahrb. f. wiss. Bot., 1882, Bd. XIII, p. 607.

⁵ For details see Rimbach, l. c., p. 15. [Went observed no shortening in the aërial roots of Aroids (Ann. du Jard. Bot. de Buitenzorg, 1895, T. 1, p. 19), whereas a slight contraction may occur in those of *Vanilla aromatica* and other orchids.]

It is evident therefore that the contraction is not the result of a fall of osmotic pressure in the active cells, and it is also clear that the shortening of the root is not necessarily connected with the commencement of secondary growth. Several problems still remain to be solved, as for example whether any changes occur in the elasticity of the walls of the active cells, and whether their power of stretching undergoes local modification.

SECTION 5. The Rapidity of Growth.

Under optimal conditions the activity of growth may be accelerated to a certain specific limit dependent upon the character and age of the plant examined. In a condition of nature the average growth is slower than this, although the maximal possible activity for a particular plant may occasionally be more or less closely attained for short periods of time. The stems of climbing plants, such as *Humulus* and *Cucurbita*, may become 12 metres long in the course of a single summer, whereas those of seedlings of *Quercus* and *Abies* become barely 12 centimetres long in the same time, and many lichens grow not more than 2 to 5 millimetres in the course of a year even under favourable conditions¹. On the other hand a bamboo shoot has been observed to grow from 50 to 75 centimetres in length in twenty-four hours², and *Bambusa gigantea* may become 8.75 metres high in thirty-one days³. All tropical plants do not however grow with special rapidity, but in a warm moist climate, and in the absence of a winter-resting period, a greater total growth is possible, even in plants which do not grow more rapidly than those of temperate regions.

Even more active powers of growth are possessed by the cosmopolitan bacteria and fungi. In bacteria especially, since every cell remains embryonic, the total growing mass rapidly increases if the supply of food is ample and the injurious metabolic products are continually removed. On the other hand the growing zones in Somatophytes increase but slowly, or under special conditions not at all.

A rapidly growing bacterium can produce under favourable conditions two individuals of similar size within 20–30 minutes⁴. Even at the rate of one division an hour, the progeny of a single bacterium would amount in twenty-four hours to 16½ millions, in two days to 281½ billions, and in three days to 4,772 trillions of

¹ Krabbe, Cladoniaceen, 1891, p. 131. Cf. also Vallot, Rev. gén. de Bot., 1896, T. VIII, p. 201; C. F. W. Meyer, Nebenstud. meiner Beschäft. im Geb. d. Pflanzenkunde, 1825, p. 39; G. Bitter, Jahrb. f. wiss. Bot., 1898, Bd. XXXII, p. 126. For instances of more rapidly growing lichens see Fünfstück, Beitr. z. wiss. Bot., 1895, Bd. 1, p. 216.

² Kraus (Ann. du Jard. Bot. de Buitenzorg, 1895, T. XII, p. 199) observed 57 cm. growth in twenty-four hours in a species of *Dendrocalamus*, and in Kew Gardens a growth of 91 cm. has been seen in the same time (cf. Kraus, l. c., p. 198). See also Dingler, Flora, 1897, Erg.-bd., p. 281; Schibata, Jour. of the College of Science, Tokio Univ., 1900, Vol. XIII, p. 456.

³ According to Wallich. Cf. G. Kraus, l. c., p. 197.

⁴ Buchner and Nägeli, Sitzungsber. der Münchener Akad., 1880, p. 375; Brefeld, Unters. über Schimmelpilze, 1881, Heft 4, p. 46; Koch, Bot. Ztg., 1838, p. 294; Flüge, Mikroorganismen, 1896, 3. Aufl., Bd. 1, p. 420.

individuals¹. In the case of a cylindrical form, of length 0.002 and diameter 0.001 mm., 636 millions would have a total volume of 1 cubic mm. Hence the growth after one day would correspond to a volume of 0.022 cubic mm., after two days to 442 cm., and after three days to $7\frac{1}{2}$ million litres, or more than $7\frac{1}{2}$ million kilogrammes. A few days later the mass of bacteria would surpass the volume of the earth. The $16\frac{1}{2}$ million individuals resulting at the end of the first day would form, when placed end to end, a thread 33 metres long, and this would become 563,000 kilometres long at the end of the second day ($281\frac{1}{2}$ billion individuals), or about 14 times longer than the circumference of the earth at the equator.

The harvest yielded by a hectare ($2\frac{1}{2}$ acres) in the course of a year is trifling as compared with these practically unattainable values, for it amounts to about 8,000 kilogrammes dry weight (40,000 when moist) in the case of ordinary crops, while actively growing forest trees of from 40 to 120 years of age produce per hectare from 2,000 to 4,000 kilogrammes dry weight of wood, to which the weight of the fallen foliage must be added². In favourable tropical climates these values may be doubled or trebled³. Koorders in fact observed that in Java the rapidly growing *Albizzia moluccana* became 3 metres high in eight months⁴, whereas *Larix europaea* increases by about 0.25 metres, and *Pinus sylvestris* by 0.12 metres in the same time in Northern Europe. In nine years *Albizzia* becomes 33 metres high in Java, whereas the conifers mentioned, and also the beech, require 120 to 160 years to attain this height⁵.

The amount of growth is dependent upon the size of the growing region, and upon the duration and activity of growth in it. The relative rapidity of growth⁶ in a growing zone is given by noting the increment of growth of a unit length (linear growth-coefficient), area (superficial growth-coefficient), or volume (cubical growth-coefficient) in unit time. The actual rapidity of growth is not very great in such plants as *Bambusa* and *Humulus*, for the rapid elongation of these plants is mainly due to the abnormal length of the growing zones. On the other hand the linear growth-coefficient is very high in many fungi, in which the growing zone is restricted to the extreme apex of the hypha. This growing zone, which is not longer than 0.018 mm. in *Botrytis cinerea*, may increase in length by 0.018 to 0.034 mm. per minute, i.e. by 100 to 200 per cent.⁷ This equals a growth-coefficient of 1 to 2 in

¹ Cf. Cohn, Die Pflanze, 1882, p. 438.

² Cf. Schwarz, Forstliche Bot., 1892, p. 160, and similar sources.

³ See also Giltay, Bot. Centralbl., 1898, Bd. XVIII, p. 694.

⁴ Koorders, Beibl. z. Bot. Centralbl., 1895, Bd. v, p. 318. [Certain herbaceous temperate plants may grow even more actively, viz. *Helianthus annuus* and *Heracleum gigantum* may become 2 to 4 metres high in from four to six months.]

⁵ Cf. Ebermayer, Physiol. Chem., 1882, p. 41; also Hartig, Lehrb. d. Anat. u. Physiol., 1891, p. 257 seq.

⁶ Sachs, Lehrbuch, 1873, 3. Aufl., p. 731. Sachs' use of the term 'energy of growth' is not to be recommended, since this term should be employed in its strict physical sense. Cf. Pfeffer, Energetik, 1892, p. 231. Similarly the term 'rapidity of growth' is preferable to Askenasy's 'intensity of growth' (Verhandl. d. naturhist.-med. Vereins z. Heidelberg, 1878, Bd. II, p. 10).

⁷ Reinhardt, Jahrb. f. wiss. Bot., 1892, Bd. XXIII, p. 490.

millimetre-minute units, whereas in the case of a bacterium which can double its length in twenty minutes the growth-coefficient would not be more than 0.05. This latter is however higher than in most roots, shoots, hairs, and leaves, for it is rarely that a doubling of the length occurs within from one to two hours even in the most rapidly growing zones of these organs, the maximal growth-coefficients therefore lying between 0.016 and 0.008. It is mainly the small size of bacteria which renders possible the rapid nutrition necessary for their rapid growth, whereas the growing apex of a fungal hypha is nourished by the somatic regions behind it.

A hypha of *Botrytis cinerea* may elongate 1.08 to 2.04 mm. in length in an hour, in spite of the small size of the growing zone (0.018 mm.). This growth-coefficient (1 to 2 mm. per mm. per minute) is greater than that of *Phycomyces nitens* (0.12 to 0.3), which with a growing zone of 0.2 to 0.5 mm. (Errera, l. c. p. 535) elongates 3.6 mm. during the 60 minutes when growth is at its maximum. According to Pfitzer¹, the hypha of *Ancylistes closterii* may elongate as much as 0.1 mm. per minute, but since the length of the growing region is unknown, the growth-coefficient cannot be determined. The latter is probably even higher in the stalk of *Coprinus stercorearius*, which according to Brefeld² may increase in length 13.5 mm. in one hour (0.225 mm. per minute), while in *Dictiophora phalloidea*, one of the larger Phalloideae, A. Möller³ has observed an elongation of 120 mm. in two hours, or 1 mm. per minute. A good instance of rapid growth in length is afforded by *Oedogonium* when the ring of deposited cellulose stretches to the full possible extent.

The apically growing pollen-tubes of flowering plants seem in a few cases to attain a rapidity of growth equal to that exhibited by *Botrytis*⁴. Very rapid elongation also occurs during the stretching-growth of the staminal filaments of *Triticum* and *Secale*, for these, according to Askenasy, may increase in length from 4 to 7 mm. in two minutes, that is, by 37.5 per cent. per minute⁵ (linear growth-coefficient = 0.375). The most rapidly growing zone in the root of *Vicia* (Figs. 1 and 2) elongates from 1 mm. to 2.3 mm. in six hours, which gives a rapidity of growth of 0.36 per cent. per minute. A bamboo shoot which grows 913 mm. longer in twenty-four hours (0.635 mm. per minute) and which has a growing zone 50 mm. in length (G. Kraus, l. c.) has a growth-coefficient of 0.0127 (1.27 per cent. per minute). As a further instance of rapid growth the leaves of *Victoria regia* may be mentioned, which according to Caspary may become 308.3 mm. longer and 367 mm. broader in twenty-four hours⁶.

¹ Pfitzer, Monatsb. der Berl. Akad., 1872, p. 384; Beobachtungen ü. Bau u. Entwicklung der Orchideen, 1882, p. 2 (Verh. d. naturh.-med. Vereins zu Heidelberg).

² Brefeld, Unters. ü. Schimmelpilze, 1877, Heft 3, p. 61.

³ A. Möller, Schimper's Mittheil. a. d. Tropen, 1895, Heft 7, p. 119.

⁴ Lidfors, Jahrb. f. wiss. Bot., 1899, Bd. XXXIII, p. 301. Cf. also Stammeroff, Flora, 1897, p. 147. On the slower growth of hairs see Reinhardt, l. c., p. 522.

⁵ Askenasy, Verhandl. d. naturh.-med. Vereins zu Heidelberg, 1879, N. F., ii, p. 246; V. Rimpau, Bot. Centralbl., 1883, Bd. XI, p. 6.

⁶ Caspary, Flora, 1856, p. 136; O. Drude, Nov. Act. d. Leop.-Carolin. Akad., 1881, Bd. XLIII,

The secondary growth in thickness is never very rapid in the stems and roots of woody plants. Reuss observed a maximal daily increase of thickness in the stem of a lime of 0.21 mm.¹ F. Darwin found a maximum rate of growth in thickness in the case of a cucumber fruit of 0.01 mm. per minute, corresponding to an increase in weight of 0.1 gramme².

Temporary variations in the activity of growth occur during the grand period, and these may be distinctly perceptible during periods of observation of a minute or so in the case of rapidly growing plants. The variations usually occur at irregular intervals varying commonly from two to thirty minutes, and are sometimes sudden, but may also arise gradually. The first acceleration of growth is followed by a period of retardation or even by a complete temporary cessation of growth. One result of these variations is to cause the nutating apex to describe an irregular curve in space. Similar variations in the rapidity of growth are shown by slowly growing plants, provided that the observations are sufficiently prolonged.

These oscillations are autonomic in character, since they continue under constant external conditions. Similar rhythmic variations are shown by cilia, by pulsating vacuoles, and by streaming protoplasm when circulation turns into rotation and subsequently reappears. Hence it is hardly surprising that growth should also show variations of internal origin.

Sachs was correct in considering these growth-variations to be autonomic changes, even although the true undisturbed autonomic variations were never obtained either in his researches or in those of Reinke, Drude, and others³. For during the experiments the external conditions were not kept perfectly constant, and sufficient attention was not paid to the fact that the mere attachment of a thread, or the friction against the cover-glass in the case of microscopic objects, is sufficient to cause disturbances of growth. As a matter of fact, however, even when all these errors are avoided, autonomic variations of growth are shown by fungal hyphae in air and in water, and also by roots. Moreover two similar objects placed side by side may exhibit different variation rhythms.

The disturbing influences exercised in vascular plants by the tissue-strains, and by the mechanical retarding action of enclosing leaf-sheaths, are absent

p. 247. On the leaves of *Musa* see Benecke, Ber. d. Bot. Ges., 1893, p. 473; Maxwell, Bot. Centralbl., 1896, Bd. LXVII, p. 1. On the leaves of *Nelumbium* cf. Miyake, Bot. Magazine, Tokio, 1891, No. 141. Summaries are given by Pfitzer, l. c., 1882.

¹ H. Reuss, quoted by Büsgen, Bau u. Leben d. Waldbäume, 1897, p. 65.

² F. Darwin, Annals of Botany, 1893, Vol. xxviii, p. 485; cf. also Kraus, Sitzungsber. d. naturf. Ges. zu Halle, 1880, p. 94.

³ Sachs, Arb. d. Bot. Inst. in Würzburg, 1872, Bd. 1, p. 103; Reinke, Unters. ü. d. Wachstumsgeschwindigkeit, 1872 (Verhandl. d. Bot. Ver. f. Brandenburg, Bd. xiv); Bot. Ztg., 1876, p. 122; Drude, l. c., 1881, Bd. XLIII, p. 247 (Phanerogams); Hofmeister, Jahresb. des Ver. für Naturkunde in Württemberg, 1874, Bd. xxx, p. 222 (*Spirogyra*), Pfitzer, Monatsb. d. Berl. Akad., 1872, p. 384 (*Ancylistes*); Errera, Bot. Ztg., 1884, p. 497; Reinhardt, Jahrb. f. wiss. Bot., 1892, Bd. xxiii, p. 479 (Fungi).

from the filaments of algae and fungi. So also are the oscillations due to variations in the grand period of growth of successive internodes. These latter are also autonomic changes, and afford as good an indication of the plant's power of regulating its activity of growth, as does the sudden tearing of the cell-wall and rapid elongation of the deposited ring of cellulose in a cell of *Oedogonium* which is about to divide.

The following table gives a series of measurements made by Hofmeister¹ upon *Spirogyra princeps*. The readings from the micrometer scale ($1 = 0.0028$ mm.) are given and also the increments of growth in scale divisions per minute. As can be seen, growth continues slowly for some time, but suddenly is so accelerated that a cell elongates by $7\frac{1}{2}$ per cent. of its length in one minute.

Time.	Scale reading.	Growth per minute.
9.28 a.m.	85.8	
9.31 "	87.0	+ 0.4
9.43 "	90.0	+ 0.25
10.5 "	90.2	+ 0.09
10.10 "	90.7	+ 0.1
10.12 "	92.0	+ 0.65
10.13 "	91.8	- 0.2
11. "	93.7	- 0.04
11.10 "	93.8	+ 0.01
11.15 "	94.4	+ 0.12
11.25 "	96.0	+ 0.32
11.30 "	96.1	+ 0.02

SECTION 6. The Measurement of Growth.

In the case of rapidly growing plants the hourly growth can be measured by means of an ordinary metre rule. By viewing through a microscope the movement of the growing point can be directly seen, and can be rendered visible to a large audience by means of a projection lantern.

The Zeiss projection lantern permits of a magnification of from 10 to 10,000 diameters. The movement of swarm-spores and of streaming protoplasm can be sufficiently magnified to become visible on the screen by using a powerful electric light as the source of illumination, and passing the light through water and ferrous sulphate solution to render it less injurious. For the demonstration of growth, the first seedling leaf of *Avena* or *Hordeum* is very suitable when 25 to 30 mm. high, and it should be immersed in water in a glass vessel with parallel sides just before use. The shadow of a small fixed rod serves to indicate the movement of the growing object, which amounts to 60 mm. per minute, with a magnification of 4,000 when the actual growth is 0.015 mm.²

¹ Hofmeister, l. c., p. 222.

² For details see Pfeffer, *Jahrb. f. wiss. Bot.*, 1900, Bd. xxxv, p. 711.

For exact determinations, direct optical measurements are preferable to those made by attaching a thread to the growing apex, and magnifying the amount of growth by passing the thread round the axis of a long balanced pointer¹ (Fig. 7). The mere attachment of the thread and also the tension exerted by it may suffice to influence the rapidity of growth. The increase of the circumference by growth in thickness may be determined by Hales' method, by passing a fine thread round the plant, one end of the thread being fixed and the other attached to a magnifying lever². Various

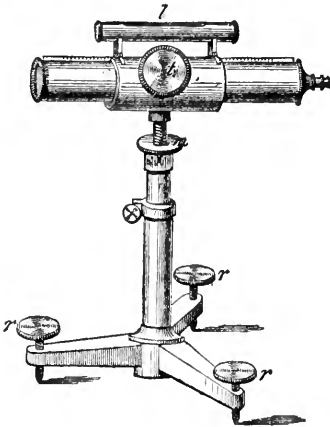

FIG. 6. Horizontal microscope for measuring growth. The coarse adjustment is made by raising or lowering the column *s*, the fine adjustment and also the measurement of growth are made by moving the graduated micrometer screw *m*. A micrometer is also present in the eye-piece and serves for still finer measurements. *l* = focussing screw, *l* = spirit-level, *r* = adjusting screws³.

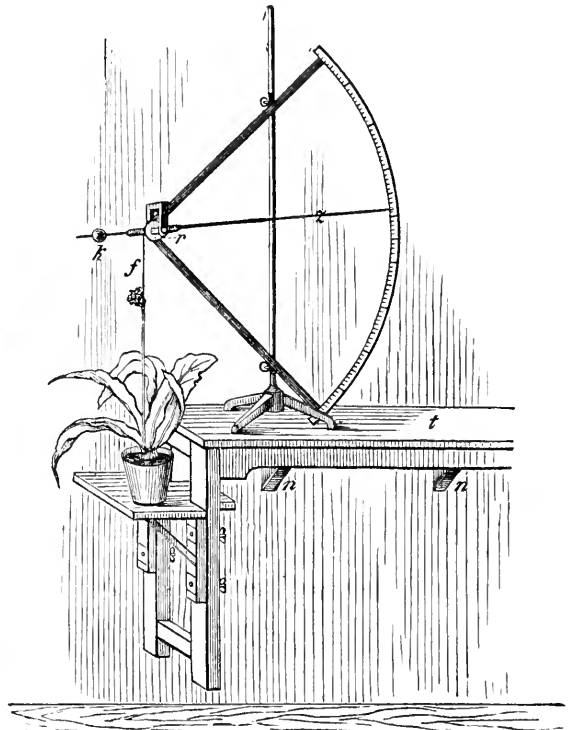

FIG. 7. Sachs' apparatus for measuring growth. One end of the silk thread *f* is attached to the plant, the other to the axis *r* of the pointer *z*, whose end moves downwards forty or eighty times the amount that the stem elongates. The table *t* rests on non-vibrating supports *n*, and by means of the movable platform *i* the plant can be placed at any desired height. A counterpoise is placed at *k*.

forms of callipers and of micrometer screw gauges may be used to measure the increase in diameter⁴. The latter may also be determined by observing

¹ Sachs, l. c., and Text-book, 1875, p. 680.

² Hales, *Statics*, 1748, p. 74; Reinke, *Bot. Ztg.*, 1876, pp. 114, 148.

³ For the source of this and of the following apparatus see *Bot. Ztg.*, 1887, p. 27. For similar instruments cf. Wiesner, *Zeitschr. f. Mikroskopie*, 1893, Bd. X, p. 147, and Sachs, *Arb. des Bot. Inst. in Würzburg*, 1878, Bd. II, p. 135.

⁴ Kraus, *Die Wasservertheilung in der Pflanze*, 1879, I, p. 74 (*Festschrift d. naturf. Ges. z. Halle*); Darwin and Bateson, *Annals of Botany*, Vol. VII, p. 468; 1890, Vol. IV, p. 118;

the movement of an attached metal point through a horizontal microscope, when the other surface of the object is placed against an immovable support. The growth in surface extent can be estimated in the same way by noting the distances between originally equidistant marks placed on the exterior of the object.

The growth of curving objects may be accurately determined by this last method, provided that the marks are placed at such distances that the difference between the arcs and chords of the segments of circles between

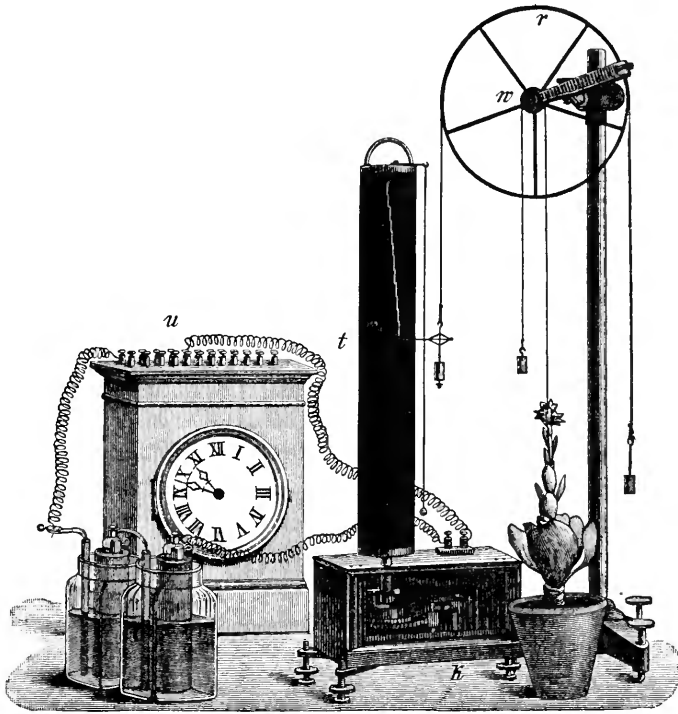

FIG. 8. Auxanometer for the automatic registration of growth. At regular intervals contact is made in the clock (*u*) and the current operates an electro-magnetic arrangement at *k*, producing a partial revolution of the cylinder (*t*).

each pair can be neglected. The Indian ink marks are made by means of a fine brush, or by the aid of a frame of parallel horsehairs, stretched over a cork, or in the case of large objects by means of a toothed dividing wheel¹.

Jost, *Ber. d. Bot. Ges.*, 1892, p. 600; Macmillan, *American Naturalist*, 1891; Frost, *Minnesota Bot. Studies*, 1894, IV, p. 182; Golden, *Bot. Centralbl.*, 1894, Bd. LIX, p. 169. The self-registering Zeiss micrometer is one of the best instruments for slender stems and tendrils. Cf. Ewart, *Ann. du Jard. bot. de Buitenzorg*, T. xv, 1898, p. 188.

¹ Hales, l. c., pp. 186, 193; Duhamel, *Naturgesch. d. Bäume*, 1765, Bd. II, p. 36; Colta, *Naturbeob. über die Bewegung d. Saftes*, 1806, p. 64; Wiesner, *Sitzungsber. der Wiener Akad.*, 1883, Bd. LXXXVIII, Abth. I, pp. 453, 473, 474; Grisebach, *Archiv f. Naturgesch.*, 1843, IX, Bd. I, p. 269. On the use of curved protractors cf. Sachs, *Arbeit. d. Bot. Inst. in Würzburg*, 1873, Bd. I, p. 391.

For prolonged experiments the use of self-registering auxanometers is advisable. An instrument of this kind was first employed by Sachs¹, who allowed the end of the pointer in Fig. 7 to write upon a smoked cylinder which made one revolution per hour. In the improved forms used by Wiesner, Baranetzky, and other authors², the growth was magnified by an axle and wheel arrangement. Other forms of magnifying levers have been used for the registration of growth in thickness.

The apparatus shown in Fig. 8 is the model constructed by Pfeffer on Baranetzky's principle. The cylinder *t* is covered with smoked paper, and makes a partial revolution at given intervals of time, according to how the clock is set.

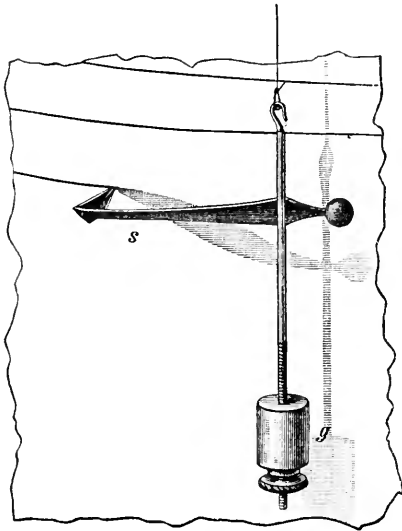

FIG. 9. Pen *s* writing on cylinder; *g* = poising weight.

A staircase curve is formed in which the heights of the steps give the increments of growth magnified by the ratio between the radii of *w* and *r*.

If the cylinder rotates continuously at one revolution per hour, the vertical distance between successive lines gives the hourly amount of growth magnified (Fig. 9). The cylinder may also make one rotation per day when growth is slow, and the curve may be directly traced on squared paper by means of a pen carrying ink made of aniline-blue and glycerine³. A quite satisfactory instrument may easily be constructed by allowing a smoked lamp chimney to be rotated by the minute or finger hand of an ordinary spring clock on which it has been accurately centred. A light straw may serve as the magnifying lever, a pin thrust through the end

of the long arm tracing the growth-curve.

By using electrical transmission, the plant and registering apparatus may be placed almost any distance apart (Frost, l. c.). Whenever the growth-movement is transmitted by means of threads, the length of these may be affected by changes of temperature and of the percentage of moisture in the air⁴. Platinum threads are unaffected by moisture, and have a low coefficient of expansion for

¹ Sachs, Arbeit. d. Bot. Inst. in Würzburg, 1872, Bd. 1, p. 113.

² Wiesner, Flora, 1876, p. 466; Baranetzky, Die tägliche Periodicität des Längenwachstums, 1879, p. 21; Cohn, Jahrb. d. schles. Ges. f. vaterl. Cultur, 1879; Pfeffer, Pflanzenphysiologie, 1881, II, p. 86; Bot. Ztg., 1887, p. 29. On the registration of growth in thickness cf. Macmillan, American Naturalist, May 1891; Reuss, Forstl. naturw. Zeitschrift, 1893, p. 146; Bot. Centralbl., 1893, Bd. LV, p. 348; Frost, Minnesota Bot. Studies, 1894, IV, p. 181; Golden, Bot. Centralbl., 1894, Bd. LIX, p. 169; Baranetzky, Ber. d. Bot. Ges., 1899, p. 20. On the methods employed in Animal Physiology cf. Langendorff, Physiol. Graphik, 1891; Marey, Méthode graphique, 1878.

³ For other forms of pen cf. Langendorff, l. c., p. 44. ⁴ Cf. Sachs, Flora, 1876, p. 108 seq.

heat. The latter error vanishes if the experiments are performed in a room at constant temperature. Threads of mixed hemp and silk may be constructed whose length is unaffected by moisture owing to the opposed hygroscopic changes of shape of the two substances.

Photographic registration will probably be largely employed in the future, for series of pictures may be obtained which when placed in a kinematograph show the phases of several days' or weeks' growth in a minute or so¹.

¹ Pfeffer, *Jahrb. f. wiss. Bot.*, 1900, Bd. XXXV, p. 738. Cf. also Langendorff, *l. c.*, p. 89; Marey, *Die Chromophotographie*, 1893.

CHAPTER II

THE MECHANICS OF GROWTH

SECTION 7. General.

IN a general study of the mechanics of growth we can confine ourselves to the individual cell, for the growth of a tissue is simply the result of the correlated growth of the cells of which it is composed. In the case of a dermatoplast, the cell-wall must grow, if any external change of shape is to be produced. The growth of the cell-wall is a vital phenomenon rendered possible by protoplasmic activity. For the continuance of growth, the proper performance and regulation of certain other functions are directly or indirectly necessary, while as the result of the growth of the cell the mass of protoplasm may increase, and a division of it and of the nucleus may be induced. At the same time the turgor is maintained by a sufficient production of soluble metabolic products. Similarly the cessation of the production of starch beyond a certain limit, and the formation of a new wall around a plasmolysed protoplast, afford good instances of automatically regulated growth.

It must, however, be remembered that growth is simply a special form of protoplasmic activity, and hence the study of this special function ultimately involves that of vital activity in general, for the internal factors concerned in growth are themselves vital complexes. Even if the mode of growth of the cell-wall were completely understood, we should have solved the mechanism of a particular partial function, but not that of growth in general. Indeed, in gymnoplasts which possess no cell-wall, we are at once confronted with the fundamental problem of protoplasmic growth. In this direction our knowledge is at present extremely deficient, and hence a few general remarks must suffice. More is known as to the mode of growth of the cell-wall and of the starch-grains, but the growth of crystals and crystalloids is a purely physical problem and need not be discussed here.

The power of imbibition and of swelling plays a most important part in metabolism, and hence in the liberation of energy as well as in the production of plastic material. Independently of where the particles of plastic material are finally deposited, their power of penetrating between the particles of pre-existent materials and causing growth by intus-

intussusception forms a fundamental property of both unicellular and multicellular organisms. The growth of a leaf or petiole takes place not by external deposition (apposition), but by the increase in size and numbers of the constituent cells. Similarly intussusception takes place when a crystal penetrates the protoplast, or when micellae, molecules, atoms, or electrons enter and unite with the organized substance of the nucleus or of other plasmatic organs. The distribution of the male fertilizing cell throughout the ovum affords another instance of intussusception.

Both intussusception and apposition are possible in bodies capable of swelling, whereas in impenetrable bodies such as crystals only the latter mode of growth is possible¹. The growth of the protoplasm, and also that of the cell-wall, takes place in both of these ways. The mode of growth is however often difficult to decide when similar material is added, although little doubt is possible when crystals of calcium oxalate or of other foreign substances are secondarily deposited within the substance of the protoplasm, or of the cell-wall.

Intussusception was recognized by Lamarck² as an essential property of the organism, and the term may be taken to include not only the introduction of formed particles from without, but also their production from other substances within the mass of growing material. In the same broad sense growth by apposition takes place when new cells, peripheral membranes, molecules, or atoms are superposed upon existing parts. There is no reason to restrict the term intussusception to the molecular processes involved in growth, or to cases in which similar substances are added to the growing materials. This error has been made by certain authors whose attention was concentrated upon a special form of growth³. In the ultimate resort all growth must take place by apposition, that is, by the addition of indivisible and impenetrable atoms⁴ to the chemical or physiological units, that is, to molecules or micellae. The latter may also possibly grow temporarily or permanently by intussusception, and since the two modes of growth may pass more or less gradually into one another, it is impossible to make a sharp distinction between them. Such a transition occurs when the segments formed from a meristem cell subsequently fuse together, and also when the mercury placed upon the surface of a zinc or lead plate gradually penetrates into it. Owing to the possible extreme complexity of growth, little permanent value attaches to the purely artificial distinction between cellular, lamellar, and molecular intussusception⁵.

¹ Albuminoid crystalloids which are capable of swelling also grow by apposition. Pfeffer, *Jahrb. f. wiss. Bot.*, 1872, Bd. VIII, p. 516.

² Lamarck, *Phil. zoolog.*, nouv. éd., 1830, I, p. 382 (1^{re} éd. 1808).

³ Cf. Krabbe, *Jahrb. f. wiss. Bot.*, 1887, Bd. xviii, p. 412; Noll, *Flora*, 1895, p. 80; Bütschli, *Unters. ii. Structuren*, 1898, p. 223. For a more general view see Pfeffer, *Stud. z. Energetik*, 1892, p. 250; Wiesner, *Elementarstruktur*, 1892, p. 193.

⁴ Pfeffer, *l. c.*, p. 254. [If, however, an atom is subdivided into several hundred or thousand *electrons*, growth by intussusception might be possible under special conditions inside it.]

⁵ Wiesner, *l. c.*, p. 223.

Whatever the precise mode of growth may be, it is always directed and regulated according to the specific structure of the organism, and to the special character of its vital activity. It is by the latter that permanent organs such as the nucleus are reproduced and maintained, and that new structures such as the cell-walls are formed which subserve special functions. The production of the cell-wall is closely analogous to the addition of new lamellae to a growing crystal introduced into a saturated solution¹, or to the production of a growing precipitation film around a drop of sulphate of copper when introduced into a solution of potassium ferrocyanide. From this point of view it is immaterial whether the cell-wall is produced from dead materials or by the transformation of living substance. The growth of an organism is, however, the result of a variety of interacting factors, whereas that of a crystal is a single simple reaction.

Owing to the power of regulation possessed by the organism, the same general forms of energy may be used to bring about the most varied formative changes. The latter are in the last resort based upon the molecular processes occurring in the protoplasm, i. e. upon chemical affinity and dissociation, upon physical polarity and molecular pressure, upon surface-tension energy, and the like. The molecular or osmotic pressure of solutions, though of great importance for the stretching-growth of dermatoplasts, and also for overcoming external resistance to growth, plays little or no part in the growth of gymnoplasts, or in that of the nucleus, plastids, and cytoplasm. Indeed the growth of the latter, and also the growth in thickness of the cell-wall, takes place against the osmotic pressure of the cell. The latter usually amounts to from 5 to 15 atmospheres, and hence is able to afford a considerable source of energy, though not so much as the other forms of energy mentioned. For example, a pressure of 2,500 atmospheres is necessary to prevent dry starch from absorbing water and swelling, while to prevent the freezing of water at -20° C. a pressure of 13,000 atmospheres would be required². The energy of crystallization and of chemical reaction may attain equally high values³. By the aid of such forces as these very great external work may be done, and even rocks split asunder. Hence it is hardly surprising to find that the cohesion of cellulose is not sufficiently great to prevent the formation and growth of crystals of calcium oxalate in the cell-wall. The cohesion of the protoplasm is so small as to offer only a trifling mechanical resistance to the growth of a body in its substance.

¹ In the absence of any such stimulus, a supersaturated solution can be produced. Cf. Ostwald, *Zeitschr. f. physikal. Chem.*, 1897, Bd. XXII, p. 289. On periodic crystallization cf. Liesegang, l. c., Bd. XXIII, p. 365.

² Clausius, *Die mechanische Wärmetheorie*, 1876, Bd. I, p. 174.

³ Lehmann, *Molekularphysik*, 1888, Bd. I, p. 349.

SECTION 8. The Growth of the Cell-wall.

Every increase of size or external change of shape in a typical plant protoplast involves a corresponding alteration in the shape or surface extent of the investing cellulose membrane. After the stretching-growth of the cell has ceased, the cell-wall commonly undergoes secondary thickening, which is definitely localized to form pitted, annular, spiral, or reticulate deposits. In addition physical and chemical changes may occur, and all of these processes are carried out and directed by the living protoplasm. The latter also provides the material for the growth of the cell-wall, which cannot take place unless direct contact is assured between the ectoplasm and the cell-wall.

As is usually the case, the same end may be attained in a variety of ways. Thus the newly formed cell-wall is not always composed of the same materials, and in certain cases it may be built up of secreted products, but in others by the direct metamorphosis of particles of the peripheral protoplasm. Similarly it is certain that the subsequent growth may take place either by apposition or by intussusception, and as far as our knowledge goes the secondary thickening usually, though not always, takes place by apposition. On the other hand, intussusception, together with the stretching of the plastic wall, is probably mainly responsible for the growth in surface extent. Growth by apposition combined with stretching will also keep a growing cell-wall of constant thickness.

The energy for growth by intussusception (active growth) is determined by the molecular processes involved in the penetration of the interpolated particles, and upon the power of swelling possessed by these. Growth by stretching is on the other hand the result of the osmotic pressure within the cell, and hence such passive growth is impossible unless this pressure is sufficiently great. The energy involved in growth by intussusception has a much higher mechanical intensity than osmotic energy, and moreover the latter must be overcome when, by the secondary growth in thickness of the cell-wall, the cavity of the cell is diminished.

Owing to the power of self-regulation possessed by the organism, a growing cell may temporarily retard or inhibit its growth when necessary. The same occurs in aerobic plants in the absence of oxygen, owing either to the processes leading to intussusception not being performed, or in the case of stretching-growth owing to the necessary diminution in the cohesion of the cell-wall not taking place. The osmotic pressure is usually unable to permanently stretch the cell-wall in the absence of any such plastic softening, for under ordinary circumstances it is not stretched to its limit of elasticity. This is shown by the fact that the tension in the walls may be increased by one-third without any permanent stretching, if weights are attached to the

tissue in the absence of oxygen¹. Indeed a temporary cessation of growth takes place in fungal hyphae when suddenly transferred from a concentrated to a dilute solution, although the effective internal pressure may be increased by 10 to 15 atmospheres.

By means of localized softening, as well as by intussusception, growth may be restricted to any particular area of the cell-wall, and hence a specific shape may be assumed. It has already been shown that the protoplasm is able to alter the properties of the cell-wall, and *Oedogonium* affords an instance of the sudden stretching of the deposited plastic cellulose without any previous increase of turgidity having occurred.

In all cases the harmonious co-operation of various forms of energy, as well as of preparatory and stimulating reactions, is necessary for the continuance of growth. Hence an alteration in any one of these factors may produce a cessation of growth, or a change in its character or activity. It is therefore easy to see that the retardation of growth produced by a decrease of turgidity does not necessarily indicate that the osmotic pressure provides the mechanical energy for growth, but may be simply owing to the fact that the maintenance of turgidity is one of the formal conditions for growth. The action of temperature is similar in character, and beyond a certain optimum a retardation and ultimate cessation of growth occur, although respiration and metabolism may be more active, and although the osmotic pressure may in certain cases slightly increase. A condition of turgidity is also essential for secondary growth in thickness, although this takes place against the osmotic pressure. In addition to its general importance the latter may also, by the stretching of the cell-wall it causes, aid in the deposition of new particles of cellulose between the older ones, and hence play a part in growth by intussusception. This, however, requires further proof².

Mechanical resistances exercise a direct retarding action upon growth, and cause it to cease when they are sufficiently powerful, but at the same time they may act as physiological stimuli. The growth of the cell-wall may continue, even though external growth is impossible, and as soon as the mechanical resistance is removed growth is resumed in those zones which remain meristematic. The conditions are, however, not quite the same when the mechanical resistance is such as to injure the tissues or to disturb their normal relationships, for a special traumatic stimulus is then exercised³.

¹ Pfeffer, Studien z. Energetik, 1892, p. 241; Pflanzenphysiol., 1. Aufl., Bd. II, p. 59. The fact that the cell-wall is not stretched to its limit of elasticity is also shown by de Vries, Unters. ü. d. mech. Ursache d. Zellstreckung, 1877, p. 113; Pfeffer, Druck- u. Arbeitsleistungen, 1893, p. 404, 429; Schwendener and Krabbe, Jahrb. f. wiss. Bot., 1893, Bd. XXV, p. 327.

² Something of this kind takes place during the growth of precipitation membranes.

³ Cf. Sect. 38, Injuries. Here the formation of callus is discussed. On tyloses cf. Schellenberg, Jahrb. f. wiss. Bot., 1896, Bd. XXIX, p. 261; Mellink, Bot. Ztg., 1886, p. 749.

A rise of turgidity may be the active cause in producing the commencement, or an acceleration, or even a retardation of growth under special conditions. As a matter of fact, however, variations in the rapidity of growth are very often unaccompanied by changes of turgidity. This applies to the acceleration of growth caused by a rise of temperature, or by the absence of light, as well as to the growth-curvatures caused by geotropic and heliotropic stimuli. Similarly no changes of turgor seem to be connected with the retardation of growth caused by the absence of oxygen, or with the cessation of growth during the winter resting period. As the cell increases in volume its turgor is kept constant by a corresponding production of osmotic substances¹, and it depends upon various circumstances whether the percentage of water increases or decreases. During stretching-growth the percentage of water usually increases², but decreases when secondary thickening occurs, while in the case of Ascomycetes the percentage of water may remain approximately constant.

Historical. The attempts to discriminate between the different co-operating factors concerned in the growth of organized bodies are mainly based upon observations made upon cell-walls and starch-grains. The first conscious attempts to refer growth to molecular processes were those of Nägeli³, and his conclusions retain great theoretical importance, although largely based upon the erroneous assumption that the growth of starch-grains takes place by intussusception. Nägeli also concluded that the cell-wall usually grows by intussusception, and only rarely by apposition. The predominant importance attached to intussusception was ultimately followed by a reaction to the other extreme, many authors⁴ considering that the cell-wall always grew in thickness by apposition, and hence always increased in surface extent by plastic stretching. In the meantime other arguments for intussusception were brought forward by certain authors⁵, and among these Strasburger, who now adopts the conclusion that growth may be brought about in various ways. This view was first put forward by Pfeffer⁶,

¹ Pfeffer, Druck- u. Arbeitsleistungen, 1893, pp. 412, 428; Studien z. Energetik, 1892, p. 245; Noll, Flora, 1895, Erg.-bd., p. 44; Wortmann, Ber. d. Bot. Ges., 1887, p. 461.

² Kraus, Ueber d. Wasservertheilung i. d. Pflanze, 1879, I (Festschr. d. naturf. Ges. z. Halle); 1880, II (Abhandl. d. naturf. Ges. z. Halle, Bd. xv).

³ Nägeli, Die Stärkekörner, 1858, p. 213.

⁴ Schmitz, Sitzungsber. d. niederrhein. Ges. f. Natur- u. Heilkunde, 6. Dec. 1880; Strasburger, Bau u. Wachstum d. Zellhäute, 1882; Klebs, Unters. a. d. bot. Inst. zu Tübingen, 1886, Bd. II, p. 372; Noll, Unters. ü. d. Wachstum der Zellmembran, 1887, p. 126; Wortmann, Bot. Ztg., 1889, p. 230; Zimmermann, Pflanzenzelle, 1887, p. 153; Askenasy, Ber. d. Bot. Ges., 1890, p. 85; Wiesner, Die Elementarstruktur, 1892; Strasburger, Jahrb. f. wiss. Bot., 1898, Bd. xxxi, p. 572. On Cystoliths see Giesenhagen, Flora, 1890, p. 90.

⁵ Leitgeb, Bau und Entwicklung d. Sporenhäute, 1884; Wille, Entwicklungsgeschichte d. Pollenkörner d. Angiospermen, 1886; Krabbe, Jahrb. f. wiss. Bot., 1887, Bd. xviii, p. 346. Cramer, Unters. ü. d. verticillirten Siphoneen, 1890, p. 35 (repr. from Denkschr. d. schweiz. naturf. Ges., Bd. xxxii); Correns, in Zimmermann's Beitr. z. Morphol. u. Physiol., 1893, Bd. 1, p. 256; Flora, 1889, p. 289; Pfeffer, Druck- u. Arbeitsleistungen, 1893, p. 429; Strasburger, 1898, l.c., &c.

⁶ Pfeffer, Studien zur Energetik, 1892, p. 240; Druck- u. Arbeitsleistungen, 1893, p. 429.

who has also given a detailed account of the preparatory and stimulatory processes involved in growth, as well as of the necessary transformations of energy. In addition, it may be mentioned that Sachs attached primary importance to the stretching of the cell-wall by the internal osmotic pressure, which he supposed to aid in the interstitial deposition of cellulose particles, and thus to allow growth in surface extent of the cell-wall by intussusception¹. The upholders of the theory that the growth of the cell-wall is due to apposition and plastic stretching assume, with the exception of Wortmann, that a softening action is exercised upon the cell-wall by the protoplasm, and that this precedes or accompanies the increase in surface extent by stretching. It is, however, not necessary to discuss the erroneous assumption of Wortmann and de Vries that a general parallelism exists between the activity of growth and the amount of stretching of the cell-wall².

A growth of the cell-wall by apposition has been proved in many cases by means of natural or artificial marks. Thus crystals of calcium oxalate adhere to the inner surface of the cell-wall in *Citrus* and *Pandanus*, and are then slowly imbedded by the internal apposition of new layers of cellulose³. Klebs and Noll have observed dead protoplasmic particles become imbedded in a similar manner, while Noll (l. c., p. 124) has demonstrated the deposition of new layers of colourless cellulose on cell-walls of *Caulerpa*, which had been stained with prussian blue.

Intussusception is most readily observed when foreign bodies such as silica, calcium oxalate, and carbonate are deposited in the wall in the form of minute particles or crystals. It is, however, always difficult and often impossible to observe any interpolation of particles of the same material as the ground substance of the cell-wall. According to Correns (l. c.), however, the latter does actually occur in the walls of *Glaeocapsa* and *Apiocystis*, while Cramer (l. c.) has observed an increase in the mass and volume of the walls of *Neomeris Kellerei* in the absence of any possibility of growth by apposition⁴. Growth by intussusception also takes place in the spore-membranes of Hepaticae (Leitgeb, l. c.), and also in the membranes of certain pollen-grains (Wille, l. c.; Strasburger, 1898, l. c., p. 574). According to C. Müller⁵, visible needle-shaped masses of cellulose are deposited in the cell-walls of the root-endodermis of *Spiraea filipendula*.

Growth by intussusception seems also to be indicated by the fact that when the external increase in size of a growing organ is mechanically prevented,

¹ Sachs, Lehrb. d. Bot., 1873, 3. Aufl., p. 699. Marriotte's suggestion (Œuvres de Mariotte, 1717, p. 132) that the pressure of the sap aids in growth by stretching the branches and leaves is only of historic interest.

² De Vries, Mechan. Ursachen d. Zellstreckung, 1877, p. 107; Wortmann, l. c., p. 234. Cf. also Pfeffer, Studien z. Energetik, 1892, p. 234; Druck- u. Arbeitsleistungen, 1896, p. 306. Schwendener and Krabbe, Jahrb. f. wiss. Bot., 1893, Bd. xxv, p. 323.

³ Pfitzer, Flora, 1872, p. 130; H. C. Müller, Entstehung von Kalkoxalat in Zellmembranen, Leipziger Dissert., 1890, p. 45.

⁴ Arguments of this kind were first put forward by Nägeli, Stärkeköerner, 1858, p. 281. See also Strasburger, Jahrb. f. wiss. Bot., 1898, Bd. xxxi, p. 572; H. Fitting, Bot. Ztg., 1900, p. 151.

⁵ Ueber die Einlagerung von Cellulose, 1897 (repr. from Ber. d. Deutsch. Pharm. Ges., Jahrg. VII, Heft 1).

the cell-walls continue to increase in surface extent for a time, although the stretching by the internal osmotic pressure steadily decreases, and is ultimately entirely antagonized by the external pressure¹. The cohesion of the cell-wall, however, does not decrease, nor is the limit of elasticity exceeded when the same or an increased osmotic pressure is allowed suddenly to act upon and stretch the cell-wall by removing the original external resistance. If the pressure is only partly released, growth in surface extent may continue in the cell-walls, although they are little if at all stretched. Rapid growth may indeed take place under such conditions, as, for example, in the cell-walls of the pith of certain stems, which are hardly at all stretched during their period of most active increase in size². This fact is hardly surprising, for we have already seen that growth by intussusception may take place without the aid of, or even against, the osmotic pressure. Indeed, the foldings produced in certain cell-walls are probably the result of the continuance of growth in walls which are no longer stretched³. Whenever growth in surface extent takes place in cell-walls of constant elasticity, although they are not under tension, this may be taken as a sure indication of growth by intussusception, for to produce growth by plastic stretching in walls under minimal tension would require the assumption of very special powers on the part of the protoplast. Sufficient has, however, been said to show that the matter is not quite so simple as Noll⁴ supposes it to be, for he inclines to regard all growth as the result of apposition.

Growth in surface extent by plastic stretching takes place in *Oedogonium*, and probably is a common phenomenon. Thus in many cases the thickness of the cell-wall or of certain layers of it decreases as the cell increases in size⁵.

It is not, however, always possible to say precisely which of these modes of growth are active, and it is, moreover, fairly certain that both intussusception and apposition are possible not only in growth by cell-division, but also during the subsequent increase in size of the individual cells.

SECTION 9. The Growth of the Cell-wall (*continued*).

We are not concerned with the visible changes of shape during the growth of the cell-wall, for however important these may be, they throw little or no light upon the physiological processes concerned in growth. The protoplast may produce a cell-wall either by the direct conversion of the peripheral particles of protoplasm into chitinous or more commonly

¹ Pfeffer, *Druck- u. Arbeitsleistungen*, 1893, p. 429.

² Kolkwitz, *Fünfstück's Beiträge z. wiss. Bot.*, 1897, I, p. 246.

³ Strasburger, l. c., p. 586; Kny, *Ber. d. Bot. Ges.*, 1893, p. 377; Zimmermann, *Beitr. z. Morph. u. Physiol.*, 1893, pp. 167, 198.

⁴ Noll, *Flora*, 1895, *Erg.-bd.*, p. 66.

⁵ Noll, *Exp. Unters. ü. d. Wachstum d. Zellhäute*, 1887, p. 132; *Flora*, 1895, *Erg.-bd.*, p. 73; Strasburger, *Jahrb. f. wiss. Bot.*, 1898, *Bd. XXXI*, p. 586; also the works of Schmitz, Klebs, &c., quoted in these publications. Frequently the cuticle becomes detached owing to the growth of the inner layers of the epidermal cell-walls, but this says nothing as to the causes of growth.

carbohydrate materials, or by the secretion and external deposition of particles of chitin or cellulose¹, while any subsequent changes in the cell-wall may also be produced in a variety of ways. These changes may also be very varied in character, without there being any reason for supposing that the cell-wall must be penetrated by living protoplasm². Hence it is possible that in growth by intussusception the interpolated particles of cellulose are derived from the decomposition of proteid and other substances, or are produced by the condensation of carbohydrates, or are deposited by precipitation from a solution permeating the cell-wall. Nothing definite is, however, known as yet, and the production of mucilaginous sheaths around certain Conjugatae³, &c., simply shows that materials secreted by the protoplast may pass through the cell-wall, and be deposited as an additional external layer which is also composed of a carbohydrate.

An intimate correlation exists between the different forms of growth, and the thickening⁴, cuticularization, or lignification of the cell-wall usually take place when the external growth of the cell has ceased. These changes serve definite purposes, and are not necessary to produce a cessation of growth, for the latter may also occur in meristematic cells, and no resumption of growth can be induced in many cells whose walls have undergone no secondary thickening and no perceptible change in character. A cessation of growth, therefore, does not always result from an incapacity for growth on the part of the cell-wall. Indeed, although no lignified membrane has as yet been observed to grow in surface extent⁵, it is not impossible that exceptions may occur, or that growth might not be resumed in such cells as the result of a retrogressive metamorphosis of the cell-wall. The frequent separation of the cuticle is due to its partial or incomplete inability to grow, but in some cases it appears to have this power⁶. Moreover in certain cases, as for example in the collenchyma at

¹ Strasburger (Jahrb. f. wiss. Bot., 1898, Bd. XXXI, p. 573) has recently brought forward additional instances of varied modes of growth in the cell-wall. Here also the remaining literature is given. Plasmolysis may usually, but not always, be produced in embryonic cells (Reinhardt, Festschrift für Schwendener, 1899, p. 425; Pfeffer, Druck- u. Arbeitsleistungen, 1893, p. 307). The latter is also exceptionally the case in adult cells, and hence no certain conclusions can be drawn from this fact as to the growth of the cell-wall, or its production from the peripheral layer of protoplasm.

² Cf. Vol. I, p. 484, and the literature there given; also Strasburger, l. c., p. 558. On extra-cellular protoplasm cf. Schütt, Jahrb. f. wiss. Bot., 1899, Bd. XXXIII, p. 594; Bot. Ztg., Ref., 1900, p. 245; O. Müller, Ber. d. Bot. Ges., 1899, p. 423; 1900, p. 492.

³ Klebs, Unters. a. d. Bot. Inst. z. Tübingen, 1886, Bd. XII, p. 411.

⁴ Cf. Hofmeister, Pflanzenzelle, 1869, p. 359; Klebs, Unters. a. d. Bot. Inst. zu Tübingen, 1888, Bd. II, p. 517. Further details in the works of Wortmann, Zacharias, Sokolowa. On primary meristems cf. Newcombe, Botanical Gazette, 1894, Vol. XIX, p. 232.

⁵ Schellenberg, Jahrb. f. wiss. Bot., 1896, Bd. XXIX, p. 255; Warburg, Ber. d. Bot. Ges., 1893, p. 440; Lange, Flora, 1891, pp. 393, 426; Nathansohn, Jahrb. f. wiss. Bot. 1898, Bd. XXXII, p. 683.

⁶ Nägeli, Stärkekörner, 1858, p. 283; Schmitz, Bildung und Wachstum der pflanzl. Zellhäute,

the nodes of grass-haulms, very thick-walled cells may remain capable of growth. Indeed the protoplast may diminish or remove the mechanical resistance to growth interposed by a thick cell-wall, either by dissolving away several layers of the latter, or by softening the whole of it¹.

The properties of the cell-wall form only one of the factors concerned in growth, and they can be locally or generally modified by the protoplast. Hence the processes of growth will never be deduced from the character and molecular structure of the cell-wall. The latter may still retain the power of growth when impregnated with abundant deposits of prussian blue² or of silica³. Pronounced impregnation with congo red⁴ does, however, result in a cessation of growth, but this may be due to a direct action upon the protoplast.

By means of special processes of regulation a cell may attain any given shape, although the cell-wall itself is equally capable of growth in all directions. It is owing to this self-regulation that the cells of a *Spirogyra* filament never exceed a certain diameter, although they remain meristematic. The same is the case with the hyphae of fungi and of *Vaucheria*, in which the cell-wall ceases to elongate immediately behind the parabolic growing apex⁵. The production of lateral shoots in *Cladophora* and *Caulerpa*⁶ shows that growth may be resumed in localized regions of an adult cell-wall.

The formation and growth of the cell-wall is the direct result of the activity of the cytoplasm, but the interaction of the latter with the nucleus is also essential. There is probably a certain advantage attained when this interaction takes place across as short a distance as possible, but nevertheless the nucleus does not always lie near to the region where the growth of the cell-wall is most active. In fact, Townsend⁷ has shown that very fine protoplasmic threads suffice to maintain the necessary connexion. It is therefore uncertain whether the common approximation of the nucleus towards the growing surface specially favours the growth of the cell-wall, as Haberlandt⁸ supposes, or whether it has some other importance. It has, indeed, not yet been determined whether this

1880, p. 8 (repr. from Sitzungsab. d. niederrhein. Ges.); Strasburger, Bau u. Wachstum d. Zellhäute, 1882, p. 189; Jahrb. f. wiss. Bot., 1898, Bd. xxxi, p. 588; Noll, Exp. Unters. u. Wachstum d. Zellmembranen, 1887, p. 133; Klebs, l. c., p. 562; Zacharias, Jahrb. f. wiss. Bot., 1889, Bd. xx, p. 113; Flora, 1891, p. 469, &c. On cuticle see Vol. I, Sect. 21.

¹ Pfeffer, Druck- u. Arbeitsleistungen, 1893, p. 401.

² Noll, l. c., p. 132.

³ Kohl, Kalksalze u. Kieselsäure i. d. Pflanze, 1889, p. 226.

⁴ Klebs, Unters. a. d. Botan. Institut z. Tübingen, 1888, Bd. II, p. 515; Sokolowa, Wachstum d. Wurzelhaare u. Rhizoiden, 1897, p. 67. External agencies act usually by influencing the protoplast.

⁵ On the path followed by the cellulose particles in the growing apex cf. Reinhardt, Jahrb. f. wiss. Bot., 1892, Bd. xxii, p. 543.

⁶ Nägeli, Zeitschr. f. wiss. Bot. von Schleiden u. Nägeli, 1846, Hefte 3-4, p. 82; Noll, l. c., 1887, p. 121; Klebs, l. c., p. 563; Zacharias, Flora, 1891, pp. 469, 482. The penetration of the cuticle is also mentioned.

⁷ Townsend, Jahrb. f. wiss. Bot., 1897, Bd. xxx, p. 484; Pfeffer, Sitzungsab. d. sächs. Ges. d. Wiss., 1896, p. 509; Vgl. Bd. I, pp. 44, 482, 593.

⁸ Haberlandt, Function u. Lage d. Zellkerns, 1887, p. 99; Sokolowa, Wachstum der Wurzelhaare u. Rhizoiden, 1897, p. 93; Mische, Flora, 1901, p. 105. The nucleus always remains at the bases of the root-hairs of *Trianea bogotensis*, although these grow at the apex only.

position of the nucleus, as well as the frequent accumulation of the protoplasm at the growing apices of hairs, pollen-tube, and fungal hyphae, are not merely the direct result of the processes involved in growth¹.

The above remarks apply to each individual cell in a tissue, although here the interactions of the cells upon one another must also be considered. Of the purely mechanical actions which act in a self-regulatory manner, it may be mentioned that the increase in size of the more rapidly growing cells and tissues is retarded by their attachment to or enclosure by less rapidly growing ones. As growth continues a portion of the osmotic pressure of the growing cells acts against this resistance, and only the remaining portion is available for maintaining the stretching tension in the growing cell-walls. Hence the retarding tissues become stretched and are under tension, while the actively growing ones are compressed, and are unable to grow when the pressure rises above a certain limit². Otherwise, however, the associated tissues, in the absence of any sliding displacement, grow at equal rates, although the walls of the cells subjected to pressure may be hardly stretched at all, while those under tension may be stretched to a very marked extent.

Growth may overcome a considerable external resistance, as is shown when a root or stem bursts a plaster cast in which it has been imbedded, or when an actively growing tissue stretches a neighbouring one beyond its limit of elasticity and causes it to rupture. The latter frequently happens during development, and since it is the direct result of growth, it is only produced when the latter is active and hence does not occur in the absence of oxygen.

Mechanical ruptures occur during the cracking of the bark of trees, and they involve living as well as dead tissues during the outward growth of endogenous organs. The splitting of the pith in the hollow stems of Umbelliferae and Gramineae is the result of the active tangential growth of the peripheral regions³, and the stems remain solid when the enlargement of their diameters is prevented by imbedding in a plaster cast⁴. Frequently also the spiral tracheides of the primary wood are torn asunder during the growth in length of the

¹ Berthold, *Protoplasmamechanik*, 1886, p. 267; Klebs, *l. c.*, p. 508; Reinhardt, *Jahrb. f. wiss. Bot.*, 1892, Bd. XXIII, p. 498. Such accumulations appear as secondary phenomena of geotropic and other curvatures, but rapid growth may occur in their absence. Sokolowa (*l. c.*, p. 87) discusses the influence of the direction of protoplasmic streaming. Cf. also Ewart, *The Physics and Physiology of Protoplasmic Streaming*, *Clar. Press*, 1903, pp. 34, 55.

² Pfeffer, *Druck- u. Arbeitsleistungen*, 1893, pp. 380, 426. The growing zone shortens when the apex of a root is fixed in a plaster cast. On the resumption of growth when the object is liberated cf. Pfeffer, *l. c.*, p. 351.

³ Cf. de Bary, *Comp. Anat.* (*Clar. Press*), 1884, pp. 214, 215, 557; Harting, *Linnaea*, 1847, Bd. XIX, p. 553.

⁴ Newcombe, *Annals of Botany*, 1894, Vol. VIII, p. 403; *Bot. Gazette*, 1894, Vol. XIX, p. 149.

stem, as can easily be seen after the cell has been dyed, and has subsequently been passively stretched to a certain extent¹. More frequently a plastic stretching of the walls of living cells (collenchyma, &c.) is produced as the result of external tension. Unequal strains may even be produced in the same cell-wall by the dissimilar rates of growth of its different layers, and it is in this way that the cuticle may be separated and thrown off.

None of the above facts are contradictory to the supposition that the protoplast may exert a controlling influence upon the growth of the outermost layers of the cell-wall, or even upon the contiguous walls of a dead cell. This last may in fact occur during the stretching of the walls of a dead spiral tracheide, perhaps by the aid of the softening action exercised by excreted enzymes. It is, indeed, difficult to see why the influence of the protoplast, which undoubtedly extends to the middle lamella, might not reach as far as the directly continuous wall of a neighbouring cell.

SECTION 10. The Growth of Starch-grains.

Starch-grains, whether formed by chloro- or leucoplastids, are able in virtue of their power of imbibition and swelling to take up dissolved substances, and hence to interpolate new particles between the older ones. They might therefore grow by intussusception, although as a matter of fact the researches of Schimper and of Meyer² have shown that starch-grains usually grow by apposition. Whether an increase in size by intussusception may also occur is doubtful, for Nägeli's arguments do not suffice to establish this view³.

According to Meyer, a starch-grain closely resembles a sphaerocrystal in its mode of growth, and the resemblance holds good whether the crystalline and anisotropous component particles are termed trichites (minute crystals) or micellae⁴. The structure and lamellation of the starch-grain are mainly the result of its growth by the apposition of successive layers, but, as in the cell-wall, secondary modification is possible by means of solvent and other agencies acting on the substance of the starch-grain. Meyer suggests that the watery central layers result from a partial solution of the starch first deposited, but it is also possible that the later layers may be denser at the outset. Starch, like reserve cellulose, may be partially or entirely dissolved when it is required as food, and hence at

¹ Nathansohn, *Jahrb. f. wiss. Bot.*, 1898, Bd. xxxii, p. 671. The older literature is given by Nathansohn.

² A. Schimper, *Bot. Zeitung*, 1881, p. 185; A. Meyer, *Unters. über d. Stärkekörner*, 1895.

³ Nägeli, *Die Stärkekörner*, 1858, p. 213. Cf. II, p. 33. Nägeli's arguments are given by Meyer, *l. c.*, p. 138. Cf. also Nägeli, *Bot. Zeitung*, 1881, p. 633.

⁴ Cf. also Bütschli, *Unters. über Strukturen*, 1898, p. 300.

any time a solution or a renewed deposition of starch may occur¹. A starch-grain does not dissolve solely from the outer surface, but also from within, so that frequently a skeleton of the grain is produced. Typical sphaerocrystals often dissolve in an equally peculiar manner², and changes in the conditions during their formation may result in the production of denser layers than those first formed³.

The shape and growth of a starch-grain depends upon a variety of factors, such as the specific character and activity of the amyloplastid (leuco- or chloroplastid), the position of the starch-grain in it, and also upon a number of circumstances which influence these relationships and others also (Meyer, l. c., p. 172). Hence the starch-grains in the same cell are not always precisely similar, and in diversely differentiated cells of the same plant they may assume widely different shapes, as for example are those in the laticiferous cells of *Euphorbia* when compared with those in other cells of the same plant. Usually the starch-grain



FIG. 10. Chloroplastids from the stem of *Pellionia Daveauana* showing stages in the production of an excentric starch-grain capped by a flattened chlorophyllous plastid.

only continues to grow so long as it is in contact with the plastid, and when the latter is attached to one side only, growth takes place in this direction and an excentric lamellation results (Fig. 10). The enlarging starch-grain not only regulates its own growth by means of the distension and shifting of the bulk of the plastid

which it causes, but also, as in the case of a growing crystal, the part already deposited influences the shape of the subsequent additions⁴.

The fact and arguments brought forward by Meyer (l. c., pp. 13, 154) do not entirely dispose of the possibility of a certain amount of intussusception occurring in starch-grains, for even in a typical sphaerocrystal an interpolation of new particles may take place without the volume of the crystal appreciably increasing. The fact remains, however, that the main growth of the starch-grain takes place by the apposition of new layers, and hence all of Nägeli's arguments which were based upon the contrary hypothesis fall to the ground. According to Meyer (l. c., p. 147), the inner layers of the starch-grain become more watery after they have been deposited, whereas Schimper (l. c.) concludes that the differentiation is present at the outset, the particles in the older layers being deposited closer together. Meyer (l. c., pp. 155, 245) has, however,

¹ On the solution and re-formation of starch-grains cf. Vol. I, pp. 318-320, 326, 473. On the mode of solution cf. A. Meyer, l. c., p. 228; Salter, *Jahrb. f. wiss. Bot.*, 1898, Bd. XXXII, p. 164.

² Hansen, *Arbeit. d. Botan. Instituts in Würzburg*, 1884, Bd. III, p. 110.

³ A. Meyer, l. c., p. 100; *Bot. Ztg.*, 1896, p. 328; Lehmann, *Molecularphysik*, 1888, Bd. I, p. 354. On the so-called artificial starch-grains see Bütschli, *Ueber die Herstellung von künstl. Stärkekörnern*, 1896; *Unters. über Structuren*, 1898, p. 239; Rodewald and Kattein, *Zeitschr. f. physikal. Chem.*, 1900, Bd. XXXIII, p. 579.

⁴ A. Meyer, l. c., p. 167; Rothert, *Ber. d. Bot. Ges.*, 1897, p. 236; Salter, l. c.

shown that, contrary to Nägeli's assumption, the outer layers are not always denser than the inner. Similarly, the internal strains observed in starch-grains could easily be produced by apposition combined with subsequent internal changes, and no arguments as to the mode of growth can be deduced from the supposed molecular structure, which is itself a mere hypothetical abstraction.

The formation and growth of the starch-grain is more closely connected with the vital activity than is the deposition of proteids or of calcium oxalate by crystallization. If, however, the causes are discovered which lead to the assumption of a definite shape by the crystals of calcium oxalate in a particular cell, we should be able to deduce the conditions existing in the cell during their formation. In the absence of any stimulus to crystallization, a supersaturated solution may be produced, a drop of which will crystallize centripetally around a suitable particle to form a sphaerocrystal¹. The formation of such supersaturated droplets is a common phenomenon within the cell, and they may either crystallize individually or by aggregation².

¹ Hansen, l. c., p. 120; Meyer, l. c., pp. 151, 192. Cf. also Bütschli, *Unters. ii. Structuren*, 1898, pp. 204, 300.

² Cf. Ostwald, *Lehrb. d. allgem. Chem.*, 2. Aufl., 1891, Bd. 1, p. 1041, and Bütschli, l. c.

CHAPTER III

GROWTH AND CELL-DIVISION

SECTION II. General.

THE existence of large non-cellular plants such as *Vaucheria*, *Caulerpa*, and *Mucor* shows that cell-division does not form an essential condition for the continuance of growth, but in cellular plants a stoppage of cell-division is always ultimately followed by a cessation of growth, and similarly when growth is prevented cell-division also soon ceases. Under normal conditions the cell divides when it reaches a certain size. The rapidity of growth and the frequency of division are in fact intimately correlated in each cell, the former regulating the latter. The magnitude at which division occurs varies greatly in different plants, and in the case of the cells of bacteria it is reached while they are excessively minute, and far smaller than the cells of other plants can ever become. Even when growth is inhibited by external pressure, the meristematic cells and nuclei in the cambium and in the young apices retain about the same size that they average during their most active growth and division. The apical cells of *Sphacelaria* and *Callithamnion*, as well as the embryonic cells of a *Spirogyra* filament, behave similarly, although they are always considerably larger than the cells in the primary meristem of a flowering plant.

The size of the embryonic cells usually varies within narrow limits, but the segment-cells derived from them undergo secondary differentiation to subserve a variety of purposes, and their properties and size are subject to corresponding modification. Thus in the sporangia of *Mucor* and *Saprolegnia*, just as in the somatic segments of *Sphacelaria*¹, the dividing-cells decrease in size. During tissue-differentiation, however, the reverse is usually the case, for the segment-cells divide less frequently, or not at all, as they increase in size by stretching-growth and attain their adult shape. Indeed in the laticiferous tubes of *Euphorbia* the cellular segmentation is suppressed, in spite of their steady growth and of the frequent divisions of the nucleus.

¹ For figures see Goebel's Outlines, Clar. Press, 1887, p. 67; also Jahrb. f. wiss. Bot., 1865-66, Bd. IV, Taf. 34.

The same takes place in *Vaucheria* and *Mucor*, and that these organisms possess a latent power of inducing cell-division is shown during the formation of sporangia, and also by the fact that under special conditions *Mucor* assumes a yeast-like form, in which a tendency to divide is shown while the cells are still exceedingly minute¹.

In this last case the change is induced by the external conditions, which, however, merely act by modifying the internal disposition of the cell. The same takes place when the external conditions induce or prevent the production of sporangia and consequent cell-division in *Saprolegnia* or *Vaucheria*. Indeed various external agencies, such as light, contact, gravity, or moisture, may influence not only the shape of the plant but also the size of its component cells. Not only somatic but also embryonic cells may be affected in this way, as is shown by the changes in the size of a bacterium or of a *Spirogyra* cell according to the cultural conditions². We shall also see that cell-division may be suppressed in plants in which it normally follows nuclear division, although the latter continues.

Between the extremes of size represented by a bacterium with a maximum diameter of 0.001 mm., and by *Caulerpa* in which it may exceed 300 mm., all grades exist. The isodiametric cells of the primary meristem vary from 0.005 to 0.024 mm. in diameter, and it is only as regards their longitudinal axes that the cambium-cells exceed these numbers³. In the cells of permanent tissues the diameter lies usually between 0.02 and 0.09 mm.; although certain cells, such as bast and wood-fibres, laticiferous cells, &c., may attain a considerable length. The small size of the component cells renders possible a greater complexity of tissue-differentiation, and it is easy to see the advantage of using cells of approximately similar size for the construction of both large and small organs. Indeed, if the cells in a particular organ, or in the entire plant, were enlarged 100 to 1,000 times, its continued existence would become impossible without a pronounced and far-reaching change of structure.

The size of the protoplast cannot fall below a certain limit, although it is not certain whether the minimal size is ever reached. To reduce the cell of a Phanerogam to the minute dimensions of a bacterium would necessitate

¹ Klebs, Bedingungen d. Fortpflanzung bei Algen u. Pilzen, 1896, p. 524. The older literature is given by Klebs. A segmentation into cells can be caused by artificially dividing a filament of *Vaucheria* into pieces, each forming new division-walls at its ends.

² Migula, Ueber d. Einfluss stark verdünnter Säurelösung auf Algenzellen, 1888, p. 17. Cf. also Klebs, Arbeit. d. Bot. Inst. in Tübingen, 1888, Bd. II, p. 537.

³ Sachs, Flora, 1893, p. 49; Amelung, *ibid.*, p. 176; Strasburger, Hist. Beiträge, 1893, Heft 5, p. 117. According to Nägeli (Theorie d. Abstammungslehre, 1884), a large lime-tree is composed of about 2,000 billion cells. [A tree 25 metres high and 1 metre diameter might have an approximate total bulk of 50 million cubic cms. in summer time, including the roots and leaves. Taking the average diameter of the cells as 0.004 cm., and their average length as 0.05 cm., the bulk of each would be 0.0000025 cub. cm., which gives a total of 20,000,000,000,000 in the entire tree. On the dimensions and volume of bacteria see Fischer's Bacteria, Clar. Press, 1900, p. 4.]

a corresponding reduction of the nucleus. The size of the latter, however, varies to a relatively small extent¹, and it is in correspondence with this fact that the nucleus forms so large a portion of the bulk of a small embryonic cell².

SECTION 12. The Relation between Cellular and Nuclear Division³.

These two phenomena, though closely related ones, do not always follow one another in the same regular sequence either as regards time or place. A separation between them occurs normally, for example, in *Chara* and *Cladophora*⁴, in laticiferous cells, and may also be induced in other plants by special external agencies. That the nucleus should be able to divide independently of the cytoplasm is no more surprising than that the chloroplastids should be able to increase in number by fission without cell-division necessarily occurring. Where, however, a cell contains a single chloroplastid or a small definite number of them, their division precedes cell-division, just as does nuclear division in uninucleate cells. It is, therefore, impossible to say whether the mechanical aid of the cytoplasm is or is not necessary in such cases for the division of the nucleus⁵.

The final work of separation is performed by the cytoplasm, as is very clearly shown in *Spirogyra* and *Cladophora*, and in gymnoplasts it does not involve the interposition of a cell-plate or dividing membrane between the two segments⁶. Nor need the formation of the cell-plate necessarily always take place in the same manner.

Under special external conditions it may be possible to discriminate between the above factors. Thus, according to Demoor⁷, low temperatures, a deficiency

¹ On the changes of size in nuclei see Schwarz, Cohn's Beiträge, 1892, Bd. v, p. 80; Zacharias, Flora, 1895, Erg.-bd., p. 217; Strasburger, 1893, l. c., p. 117.

² These relative sizes are the result of definite directive agencies, which also determine the enlargement of the vacuoles and the reduction of the protoplasm to a peripheral film. The latter, therefore, are not the primary causes inducing a cessation of cell-division. The bulk of the protoplasm is, however, one factor in inducing division, and hence an inequilateral distribution of the protoplasm, nucleus, or nuclei may be the immediate cause of an unequal division. Cf. O. Hertwig, Zellen u. Gewebe, 1895, p. 180; Driesch, Ergeb. d. Anat. u. Entwicklungsgesch. von Merkel u. Bonnet, 1898, Bd. VIII, p. 749. Mottier (Annals of Bot., 1899, Vol. XIII, p. 358) produced the unequal distribution of the cell-contents by means of centrifugal force.

³ For details see Zimmermann, Morphol. u. Physiol. des pflanzlichen Zellkerns, 1896; O. Hertwig, Zellen u. Gewebe, 1893; Delage, La structure du protoplasma et l'hérédité, 1895. Further, Strasburger, Jahrb. f. wiss. Bot., 1897, Bd. xxx, p. 155, and 1898, Bd. xxxi, p. 511; Histologische Beiträge, 1900, Heft 6, and the works there quoted. None of the speculations upon the mechanics of division is based upon a sure foundation (Chap. xv).

⁴ Cf. e. g. Strasburger, Histol. Beiträge, 1893, Heft 5, p. 108.

⁵ Cf. R. Hertwig, Abhandl. d. Münchner Akad., 1898, Bd. xix, p. 698.

⁶ In regard to animal cells see also Hoffmann, Bot. Ztg., 1898, Ref., p. 214. On the influence of artificial division on cell-wall formation see Townsend, Jahrb. f. wiss. Bot., 1897, Bd. xxx, p. 484.

⁷ Demoor, L'étude de la physiol. de la cellule, 1894, p. 30 (repr. from Archiv. d. Biol.,

of oxygen, and also treatment with chloroform or ammonia, cause cell-division and the formation of a cell-plate to be suppressed although the division of the nucleus may continue. A similar result was observed by Wildemann in Desmids at low temperatures, by Gerasimoff in *Spirogyra*, and by Klebahn in the filaments of an *Oedogonium* attacked by a fungus (*Lagenidium*)¹. Nor is it surprising that in Gerasimoff's observations on *Spirogyra* cell-division commenced, but not nuclear division.

Although we cannot precisely determine the different factors involved, there is no doubt that cell-division is a physiological process, and is not the direct result of the same surface-tension forces that produce the segmentation of a free fluid thread into a series of spherical drops². Cell-division, with the nuclear and cytoplasmic movements it involves, may in fact occur in spherical cells, but it is suppressed in the long thin tubular cells of *Vaucheria*, and of laticiferous systems. In these latter cases the internal osmotic pressure keeps the protoplasmic lining tightly pressed against the cell-wall, and hence renders it impossible for the surface-tension action in question to come into play. In plasmolysed protoplasts, however, such segmentation often occurs, but although physical laws act inside the protoplast as well as outside it, it must be remembered that the protoplasm is by no means a homogeneous fluid, and that its surface tension as well as the cohesion of its parts may undergo local alteration as the direct result of its physiological activity.

The partition-walls in a cellular tissue do approximately correspond in position to the flattened dividing films in a mass of soap-bubbles of equal size, but it is an open question whether the surface-tension-forces exercise a directive action upon the physiological processes involved in cell-division. No safe conclusions can be drawn from the similarity of the final result in the two cases, for the living organism often produces purposeful shapes and arrangements which superficially seem to obey a definite physical law.

The similarity between the arrangement of the partition-walls in a dividing tissue with that in a froth of soap-bubbles was first pointed out by Berthold³.

T. XIII). Demoor supposes that the nuclei may divide independently after the death of the cytoplasm, and in the absence of oxygen. These results, however, are not altogether satisfactory. Cf. Samassa, Ueber d. Einwirkung von Gasen auf d. Plasmaströmung, 1898, p. 6.

¹ De Wildemann, quoted by Demoor, l. c., p. 82; Gerasimoff, Ueber kernlose Zellen der Conjugaten, 1892 (repr. from Bull. d. l. Soc. d. Nat. d. Moscou); Ueber ein Verfahren, kernlose Zellen zu erhalten, 1896, *ibid.*; Klebahn, *Jahrb. f. wiss. Bot.*, 1892, pp. 24, 263. Further details by Hertwig, l. c.; Zimmermann, l. c.

² Cf. Berthold, *Protoplasmamechanik*, 1886, p. 87. No such breaking-up occurs in the elongated chlorophyll bands of *Spirogyra*. Cf. Berthold, l. c., p. 170. It is not known why the plasmodium of a Myxomycete, when imbedded in gelatine, breaks up into pieces in a manner resembling the free-cell formation in a zoosporangium of *Saprolegnia*. Cf. Pfeffer, *Zur Kenntniss d. Plasmahaut u. d. Vacuolen*, 1890, p. 277, footnote; Demoor, l. c., p. 244.

³ Berthold, *Protoplasmamechanik*, 1886, p. 220; Errera, *Ber. d. Bot. Ges.*, 1886, p. 441; *Bot. Centralbl.*, 1888, Bd. xxxiv, p. 395; de Wildemann, *L'attache d. cloisons cellulaires*, 1893. In

Usually the cell divides into two segments by a wall at right angles to the long axis of the cell. This is, however, not a general law, as Sachs supposed¹, and during free cell-formation the dividing lines are not at right angles but follow different lines of equilibrium. In addition, the cell-plate formed across a cylindrical cell which is undergoing simple division may at the outset be obliquely inclined to the long axis of the cell², while the longitudinal divisions of elongated cambium-cells do not follow the law of the smallest possible division-walls (cf. Berthold, l. c.). Nor is Hofmeister³ correct in supposing that the last dividing-wall is always at right angles to the direction in which growth was previously most active. This does, however, apply to simple cell-division, so long as the size at which division occurs remains the same, and only the increase in size regulates the divisions. The partition-walls in *Spirogyra* are formed according to this law, as well as in many cells in which growth and division take place in two or three directions. If in such cases mechanical obstacles render growth possible in one direction only, then the divisions follow the same plan as in a filament of *Spirogyra*⁴.

These relationships remain the same whether cellular and nuclear division take place simultaneously or separately, and the same laws apply to nuclear as to cellular division. Kny (l. c., p. 397) allowed spores of *Equisetum* to germinate between glass plates, and observed that the axes of the nuclear spindles were parallel and the cell-plates therefore at right angles to the glass plates and to the direction of growth. The same took place when the glass plates were illuminated on one side only, for it was mechanically impossible for the prothallus to respond to light by placing its direction of growth, and consequently the axes of the nuclear spindles, parallel to the incident ray, as it does under ordinary circumstances⁵. It follows from the above that the direction of nuclear division may determine that of cell-division.

[Kny⁶ also finds that pressure may actually induce cell-division in the pith of *Impatiens*, and that very pronounced pressure will cause the periclinal divisions of the cambium to cease and anticlinal ones to appear. In many cases he finds that pressure induces the formation of cell-walls parallel to its direction, while tension favours the production of walls at right angles to its line of action. Whether the action of tension and pressure upon cell-division is direct or indirect remains, however, still uncertain.—Ed.]

these works the physical principles are also discussed. Cf. also Zimmermann, Beitr. z. Morph. u. Physiol., 1893, Bd. 1, p. 159.

¹ Sachs, Arbeit. d. Bot. Inst. in Würzburg, 1879, Bd. II, p. 46; Flora, 1892, p. 63; 1894, p. 221.

² See de Wildemann, l. c., pp. 5, 19, 28, 73; and also Berthold, l. c., p. 244.

³ Hofmeister, Jahrb. f. wiss. Bot., 1862, Bd. III, p. 272; Pflanzenzelle, 1867, p. 129. Hofmeister specially mentioned that cell-division is the result and not the cause of growth, while Sachs put forward the law of division at right angles without seeking any causal explanation of it.

⁴ Kny, Ber. d. Bot. Ges., 1896, p. 378. Cf. also Pfeffer, Druck- und Arbeitsleistungen, 1893, p. 358. On experiments with animals see O. Hertwig, Zellen und Gewebe, 1893, p. 176; 1898, p. 99; Braun, Biol. Centralbl., 1894, Bd. XIV, p. 340; Zimmermann, Zellkern, 1896, p. 87.

⁵ Stahl, Ber. d. Bot. Ges., 1885, p. 334. See also Buchtien, Bibl. Bot., 1887, Heft 8, p. 16.

⁶ Jahrb. f. wiss. Bot., 1901, Bd. XXXVII, p. 55.

Not only may such changes as are involved in the substitution of amitosis for mitosis, in the reduction of the chromosomes, and in the production of giant nuclei, occur at different periods of development, but also the external conditions may influence the shape of the nucleus and the mode of nuclear division to a greater or less degree. A striking instance of the latter is afforded by the fact that the nucleus of *Spirogyra* may divide mitotically or amitotically according to the external conditions.

Thus, according to Nathansohn¹, *Spirogyra orbicularis* and a few other species only divide by amitosis in water containing 0.5% of ether. Mitotic division recommences in pure water, so that, as in the production of *Mucor*-yeast, we have an instance of a direct modification of the formative activity by the external conditions. In this case the transmission of the embryonic plasma is possible by amitosis, although in other cases the conditions for amitosis may never occur in particular cells so long as they are capable of division. Amitotic division, however, frequently occurs in dividing-cells, such as those of callus-tissue and of certain animal tissues.

It has in several cases been noticed that the process of mitosis may be influenced by the external conditions², and it is not inconceivable that it may be found possible to induce the reduction of the chromosomes by artificial means, or to produce a division of the nucleus in adult cells³.

Huie⁴ in fact observed that chemical stimulation of the tentacles of *Drosera* induced the nuclei of the cells of the head to pass through the commencing stages of karyokinesis.

It is for general reasons not surprising that Ziegler⁵, and also Boveri⁶, should have observed a division of the centrosome, as well as fission and a partial spindle-formation, in a non-nucleated mass of cytoplasm from the egg of a sea-urchin.

¹ Pfeffer, Bericht d. sächsischen Ges. d. Wissenschaften, 1899, p. 6; Nathansohn, Jahrb. f. wiss. Bot., 1900, Bd. xxxv, p. 48. The remaining literature is quoted in the latter work. V. Häcker, Anatom. Anzeiger, 1900, Bd. xvii, p. 9.

² Cf. O. Hertwig, Zellen u. Gewebe, 1893, p. 194; Zimmermann, Morphol. u. Physiol. d. pflanz. Zellkerns, 1896, p. 82; Němec, Bot. Centralbl., 1899, Bd. LXXVII, p. 241; Flora, 1899, p. 214; Häcker, l. c.

³ See Strasburger, Jahrb. f. wiss. Bot. 1897, Bd. xxx, p. 406; Klebs, Biolog. Centralbl., 1899, Bd. XIX, p. 220.

⁴ Huie, Quart. Journ. of Microscop. Science, 1896, Vol. xxxix, p. 423; Bot. Centralbl., 1899, Bd. LXXIX, p. 97; O. Rosenberg, Physiolog.-cytolog. Untersuch. über *Drosera rotundifolia*, 1899, pp. 2, 96.

⁵ Ziegler, Archiv f. Entwicklungsmech., 1897, Bd. VI, p. 289.

⁶ Boveri, Zur Physiol. d. Kern- u. Zelltheilung, 1897, p. 13. According to R. Hertwig (Abhandl. d. Bayr. Akad., 1898, Bd. xxix, p. 697), *Actinosphaerium Eichhorni* possesses centrosomes only in certain stages of development. On the occurrence of centrosomes in the vegetable kingdom see Strasburger, Jahrb. f. wiss. Bot., 1897, Bd. xxx, p. 387.

SECTION 13. Mechanical Aids in the Differentiation of the Tissues.

The primitive arrangement of the new cell-segments is only rarely maintained permanently. It usually undergoes more or less marked secondary alterations and displacement as the result of the subsequent growth in the elongating zones, and still more, owing to heterogeneous tissue-differentiation. The internal factors which primarily determine the subsequent history of a particular segment-cell are not open to discussion except from the standpoint of a problem of heredity, but we can give a general outline of the mechanical ways and means utilized by the plant as aids to tissue-differentiation.

It is in all cases the inherent tendency of the different cells to specific modes of growth which is primarily responsible for the differentiation of the tissues, for it is by the varying growth-activities of different cells that the tissue-strains are produced, and with them the numerous direct and stimulating actions which they exercise upon the growth of individual cells.

Certain cells divide less frequently than others and hence become larger, although the rate of growth may be uniform, while growth may be retarded or prevented in cells attached to or surrounded by slowly growing or adult tissues. A growing tissue may in fact mould itself to the space available like so much plastic material, although frequently a cell or tissue makes room for its own growth by penetrating between other cells, or by crushing other tissues which are unable to resist the pressure brought to bear upon them. Many embryo-sacs grow in this manner, and the phellogen layer is able to make room for a slight formation of cork, even when the stem is imbedded in a rigid plaster cast¹. Similarly, the growing vascular bundles may expand towards the centre of the stem and compress the pith. On the other hand, an actively growing compressed tissue may aid the growth of other tissues by stretching them, or may even tear them asunder.

The union between the component cells in a growing tissue is frequently partially or entirely dissolved, as for example during the formation of intercellular spaces, and during the separation of the abscission layers² in fruits and leaves. This is attained by the partial or complete conversion of the middle lamella of the common partition-wall into substances which imbibe water, and swell or dissolve, so that a slight strain suffices to cause a separation between the contiguous layers in question. Frequently the weight of the organ or the tendency of the cells to become rounded is

¹ Newcombe, Bot. Gazette, 1894, Vol. XIX, p. 223. On deep-seated phellogen cf. de Bary, Comp. Anat. (Clar. Press), 1884, p. 551 seq.

² This term is for many reasons preferable to that of 'absciss-layer.'

sufficient for this purpose. The expansion of the tissues themselves, as well as the stresses and strains due to neighbouring actively growing zones, act in the same way in enlarging the intercellular spaces. The large intercellular spaces in the petioles of *Nymphaea* and *Calla* are produced in an actively growing tissue, which expands against the resistance of the stretched peripheral tissues, whereas the hollow internodes of grass-haulms are produced by the passive stretching and rupture of pith.

All uniformly extensible limiting membranes when stretched by internal pressure tend to become spherical, and this applies to the cell as well as to an india-rubber balloon or soap-bubble. Owing to their mutual pressure, however, the cells may become polygonal in homogeneous tissues, and the varied shapes of unicellular organisms show that in the absence of such mutual pressures, soft cell-walls may diverge very greatly from the spherical outline. In addition, cells of special shape and intercellular spaces of remarkable outline may be produced in tissues¹.

The appearance of intercellular spaces renders it possible for the contiguous cells to grow into these spaces, just as the epidermal cells may grow outwards to form hairs. In both cases, however, the process is under the plant's control, and this applies to the formation of the internal hairs in the intercellular spaces of *Nymphaea*, as well as to the production of the endocarpal hairs in the loculi of the fruits of *Citrus*. Similarly the formation of tyloses within the cavities of the vessels is a localized phenomenon, and only takes place at a certain age². Most pollen-tubes and the hyphae of many parasitic fungi grow along the intercellular spaces, applying themselves closely to the cell-walls and enlarging the narrower spaces by means of the pressure exercised by the growing apex as it penetrates between the boundary walls. In other cases, however, the tubes or hyphae excrete enzymes which exercise a solvent action upon cellulose, and either loosen the union between the cells or enable the filaments to bore through the cell-walls.

It is therefore hardly surprising that certain cells should become longer than others of similar origin, and should penetrate between the latter by a process of sliding growth. This commonly occurs to a slight extent and is often extremely pronounced. A good example is afforded by the laticiferous tubes of *Euphorbia*, which exhibit continued apical growth and send ramifications into each new portion of the tissue in which they occur. Sliding growth also forms an essential condition for the formation of bast and wood-fibres, and indeed of all secondary prosenchymatous

¹ Zimmermann, Beiträge z. Morphol. u. Physiol., 1893, p. 198, and the literature there quoted.

² Schellenberg, Jahrb. f. wiss. Bot., 1896, Bd. XXIX, p. 261; Mellink, Bot. Ztg., 1886, p. 749.

elements which are distinctly longer than the cambium-cells which produce them¹.

If we suppose that first intercellular spaces are formed, and that then the elongating cells grow into these, the two processes involved are more easily understood, although as a matter of fact they seem always to occur simultaneously. It remains, however, uncertain whether the surrounding cells are forcibly pushed apart, or whether they aid the penetrating cells by separating to make way for them. The shape and growth of the laticiferous tubes is undoubtedly partly determined by the tissues in which they grow, either by the mechanical restriction or chemotropic attraction of the growing tubes to certain paths, or by a combination of these factors, as in the case of pollen-tubes. In the latter case rapid sliding growth is possible without causing any permanent discontinuity in the tissue sufficient to appreciably affect its mechanical rigidity.

Cells and cell-filaments may unite to form a loose mycelium or even a solid mass of pseudoparenchyma² such as is produced by the closely webbed hyphae of certain fungi. In lichens the symbiotic algae and fungi are closely apposed, and fusion may even occur between them. A satisfactory explanation of the factors which produce and regulate these secondary associations would be of considerable general importance, for in sliding growth and in grafting we have instances of the combination of cells and tissues which were originally separate.

SECTION 14. The Order of Cell-division.

In the growing regions of vegetative organs, two similar halves are usually produced at each division, and since the walls intersect at right angles, the resulting general arrangement is easily traced. Similarly the nature of the curves which will be produced by the growth of aggregations of similar cells can be predicted beforehand, and in spite of the common occurrence of secondary alterations and displacements, these curves can be recognized in many tissues. Conversely the primary and secondary arrangement in the tissue afford indications as to the mode of division of the cells composing it. Moreover, a knowledge of the conventional

¹ Hofmeister (*Pflanzenzelle*, 1867, p. 162) first drew attention to the existence of sliding growth, and Krabbe (*Das gleitende Wachstum*, 1886, p. 41) discussed its importance in the growth of vessels, &c. Nathansohn (*Jahrb. f. wiss. Bot.*, 1898, Bd. xxxii, p. 682) has shown that it also occurs between the tracheides and parenchyma of intercalary zones of growth, and between the vascular bundles and cortex of roots. See also Kohl, *Mechanik der Reizkrümmungen*, 1894, p. 33; and on *Rivularia*, Schwendener, *Sitzungsb. d. Berl. Akad.*, 1894, p. 958. There are naturally different varieties of sliding growth.

² Lindau (*Festschrift für Schwendener*, 1899, p. 28) suggests the term 'plectenchyma.' Cf. also Bitter, *Jahrb. f. wiss. Bot.*, 1899, Bd. xxxiv, p. 230; Askenasy, *Ber. d. Bot. Ges.*, 1888, p. 130 (*Algae*).

arrangement is of use in studying the divisions and grouping of the cells in the tissues or growing organs. It must, however, always be remembered that all such geometrical constructions are only of value as representations of actual arrangements in the tissues, and do not indicate or explain the organizing activity which produces them in organs of very dissimilar morphological value. The geometric grouping of the cell-walls will never afford any insight into the processes which determine and govern growth and cell-division, and hence only a short account of the commoner modes of arrangement need be given¹.

The simplest cases occur in the cell-filaments of algae and of hairs, in which the dividing walls are at right angles to the side walls. By the concrescence of such cell-filaments with rectangular outlines to form a plate or quadratic column, we get a tissue in which the dividing walls are parallel to the planes of symmetry in a corresponding crystal of the regular system. A similar crystalline arrangement, in which the layers of cells correspond to the lamellae of the crystal, can be produced by the continuous and regular division of a cell and its segments into similar halves.

If the growing end of a filament broadens laterally it will segment at right angles to the transverse walls. This takes place in the fan-shaped

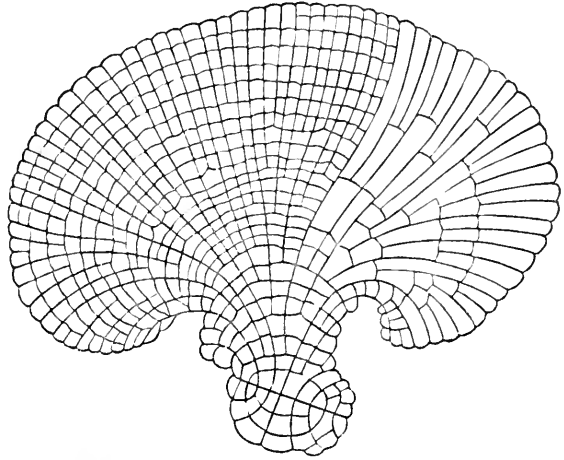

FIG. 11. *Melobesia Lejolisii* seen from the upper surface. A number of the dividing-walls are omitted on the right. (After Rosanoff and Sachs.)

¹ For details see Sachs, Arbeit. d. Bot. Inst. in Würzburg, 1878, Bd. II, pp. 46, 185; Lectures on Physiology (Clar. Press), 1887, pp. 431, 448; also Goebel, Entwicklungsgesch. d. Pflanzenorgane, 1883, p. 136; Schwendener, Monatsb. d. Berl. Akad., 1880, p. 412; Haberlandt, Physiol. Anat., 1896, 2. Aufl., p. 67. [Church (Annals of Botany, Vol. xv, 1901, p. 482) has recently endeavoured to establish an explanation of phyllotaxis upon a similar geometrical basis. He considers that the leaf-primordia primitively arise in the spaces formed by the intersections at right angles of oppositely winding logarithmic spirals, and that the adult phyllotaxis (Archimedean spirals reduced on elongated stems to practically parallel straight lines or *orthostichies*) is produced by secondary modification of the primitive arrangement. The latter is supposed to be the direct physical result of the mechanical distribution of energy within the protoplasmic substance of the plant-apex (l.c., p. 488), and is considered to be the natural corollary to the orthogonal intersection of the dividing-walls in growing tissues. There are, however, exceptions to the latter, and similarly it has yet to be shown that the above theory applies to the arrangement of all leaf-primordia. Cf. Church, On the Relation of Phyllotaxis to Mechanical Laws, 1901-2. See also Vöchting, Ueber den Sprossscheitel der *Linaria vulgaris*, Jahrb. f. wiss. Bot., Bd. xxxviii, 1902, p. 83.]

thallus of *Melobesia*, for the apical cells in each cell-row divide longitudinally at fairly regular intervals, and so reduce the tangentially enlarging terminal cells to their original size¹. Similar relationships are shown in sections across the secondary wood of young stems of *Pinus*.

When the rows of cells are curved so as to form a series of confocal parabolas, we have an arrangement like that shown in the darker part of Fig. 12. To obtain a close resemblance we must assume that each row of cells broadens away from the apex and divides longitudinally at regular intervals as in *Melobesia*. The arrangement of the dividing-walls in the apices of roots and stems does actually correspond roughly to a system of confocal paraboloids of revolution with trajectories

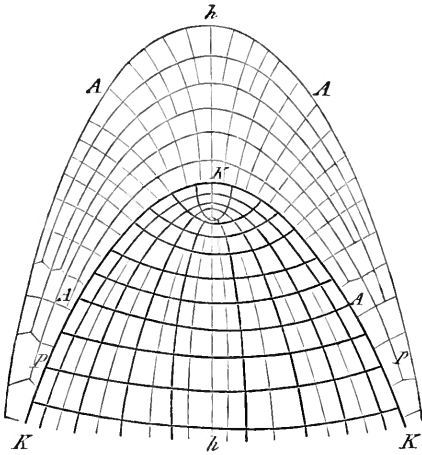

FIG. 12. Geometric diagram of a root-apex (after Sachs). h h =axis of revolution; KKK =periclinal; AA, PP =anticlinals.

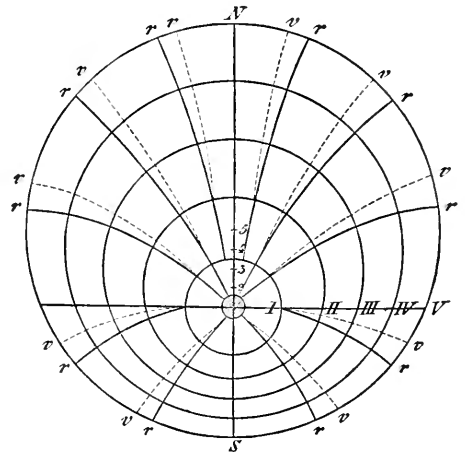

FIG. 13. Geometric diagram of the annual rings and medullary rays in an excentric wood-cylinder. The construction is based on a system of excentric circles whose centres lie on the axis of symmetry NS at 2, 3, 4, and 5. r =geometric trajectories; v =the slightly diverging actual course of the medullary rays.

intersecting them at right angles. Sachs termed walls parallel to the periphery, periclinals (KK , Fig. 12), and those corresponding to the orthogonal trajectories, anticlinals (AA, PP , Fig. 12). The walls lying in the plane of a longitudinal section are at right angles to the visible primary anticlinals, and in a transverse section across the apex they will appear as orthogonal trajectories of the periclinals, that is, as division-walls at right angles to the surface. The series of walls in a particular transverse section have been termed 'transversals' by Sachs, and they will usually be formed by the interceptions of the radii and circumferences of a system of concentric or excentric circles.

Even when the periclinals form circles or ellipses instead of parabolas,

¹ [A still more regular arrangement is shown by the thallus of *Coleochaete scutata*, as to the origin of which cf. Goebel's *Outlines*, Clar. Press, 1887, p. 47.]

the anticlinal walls at right angles to these will correspond geometrically to a system of orthogonal trajectories (cf. Fig. 13). The same figure shows the course of the guiding lines when the points of maximum and minimum growth lie on the axis of symmetry. In the latter case (lower half of Fig. 13) the arrangement corresponds to that in the shoot-apex and root-apex (darker part of Fig. 12). In the root-cap the most active growth takes place along the axis of symmetry, and this usually gives an arrangement as in the upper part of Fig. 13. This was termed by Sachs the conical, divergent, or coaxial type, whereas the common type is a system of confocal layers.

Similar arrangements may, however, be produced in different ways, and various causes may induce displacements sufficient to modify or even completely change the primitive construction ¹.

¹ See Sachs, l. c., 1878, p. 195; Schwendener, l. c., pp. 418, 430; Krabbe, Sitzungsber. d. Berl. Akad., 1882, p. 1,093.

CHAPTER IV

THE ELASTICITY AND COHESION OF THE PLANT-BODY

SECTION 15. Mechanical Strength and Rigidity.

THE plant and all its organs must be adapted to the mechanical demands made upon them. Thus, the stem of an oak must not only be able to firmly support its crown of foliage, but must also be strong enough to withstand the leverage exercised by strong winds. Even young oak stems are, however, not nearly so much bent as are the slender haulms of rye, which at once become erect in calm pauses, even though previously the ears touched the earth. In spite of its great power of bending, the rye haulm possesses considerable rigidity, for if the basal portion is fixed horizontally, the free portion is not only able to bear the weight of the ears, but also to raise them by performing an upward geotropic curvature, although the basal region may then be required to withstand a shearing stress of 5 kilogrammes. A long grass-haulm, which is about 400 times longer than its diameter, is a much more slender structure than a rigid factory chimney. The latter is indeed not nearly so resistant as the trunk of an ordinary tree, for if the crown of foliage from a tree of corresponding size were fixed to a factory chimney, a gentle breeze would cause the latter to snap across. In the crown itself the base of a moderately large branch is frequently subject to a shearing stress of 5,000 kilogrammes¹. Less rigidity is required in roots, but they are often subjected to considerable tension when the stem, bent by the wind, tends to drag them out of the ground. Similarly tendrils and the stems of climbing plants have considerable tensile strength, but usually a relatively small degree of mechanical rigidity. The maximal tensile strain for a square stem of *Uncaria* with a side of 5 mm. may be as much as 90 kilogrammes (360 kgs. per sq. cm.), and for the flexible bases of attached tendrils of *Strychnos laurina* 2 mm. in diameter

¹ Pfeffer, Druck- u. Arbeitsleistungen, 1893, p. 410; Meischke, Jahrb. f. wiss. Bot., 1899, Bd. XXXIII, p. 359. [The following definitions may render the text clearer: the two factors concerned in the elasticity of a body are (1) its compressibility, (2) its rigidity. The compressibility may be defined as the ratio of the cubical compression per unit volume to the pressure producing it, and it is therefore the reciprocal of the *volume-elasticity*. Rigidity is dependent upon the power of resisting external forces (shearing stresses) which produce change of shape without change of volume. A tensile stress upon a root may not only alter its shape if it elongates, but also its volume. The power of resisting tensile stress is therefore dependent upon the volume-elasticity as well as upon the rigidity, both of which again depend upon the degree and mode of cohesion between the non-homogeneous materials of which the root is composed.]

averages 11–12 kilogrammes (300–340 kgs. per sq. cm.), whereas the breaking strain for a copper wire is about 6,000 kgs. per sq. cm.¹

All the organs of a plant must at every period of their development be able to resist all the stresses and strains they are called upon to bear. In intercalary vegetative zones this is largely attained by the aid of sheathing leaves, while in the case of foliage leaves with flexible petioles and thin laminae the latter are set parallel to the direction of violent winds by the torsion or bending of the stalk, and so lessen the strain upon them. The impact of the water upon plants growing in running streams is lessened in the same way, and in all such cases the degree of flexibility is of considerable importance.

Small plants have an advantage in many respects, but nevertheless have relatively the same resistances to overcome as large plants. The latter are, however, unable to exist in a foaming mountain torrent in which small algae may cling to the stones, and marine algae are able to defy the erosive action of the waves on rocky coasts.

The existence of climbing plants shows that the stem need not always have sufficient rigidity for its own support, and the same applies to many aquatic plants which are buoyed up by the water in which they grow. In all such plants, however, the osmotic pressure of the living turgid cells enables them to resist considerable external pressures, and also the internal tissue-strains due to growth.

The cell-walls practically constitute the entire skeletal framework of the plant, and the fact that this framework is typically composed of innumerable small chambers is of great importance, not only in the general economy of the plant, but also in giving large ones the required rigidity. Similarly, this minute subdivision enables succulent plants to acquire sufficient rigidity in spite of the high percentage of water and small amount of solid substance they contain.

It is only in the case of trees, shrubs, and a few herbs, in which very many of the cell-walls become hard and rigid, that the plant remains erect after death. Most herbs and nearly all young or succulent organs droop when the turgidity cannot be maintained owing to the loss of water, as well as when it disappears on death. In such cases, the same physical causes operate that make a bladder firm and rigid when air or water is forced into it, and cause it to collapse and become flabby when its walls are no longer stretched. Similarly, the tissue-strains aid in maintaining the rigidity of growing organs, although such rigidity as is necessary in the trunks of trees can only be attained by means of thick cell-walls. It would indeed be a serious matter if the trunks of trees lost their rigidity and collapsed whenever the water-supply was deficient.

¹ Cf. Ewart, *Ann. du Jard. bot. de Buitenzorg*, 1898, T. XV, pp. 194, 214.

In the higher plants certain cells always develop thicker walls than the rest, and obviously have mainly a mechanical strengthening function. As the cell-wall thickens, diosmotic exchanges become increasingly difficult, so that the protoplast ultimately perishes in the sclerenchymatous cells of the cortex, pericycle, phloem, and wood when these elements are fully formed. The plant in this way sacrifices certain of its living protoplasts for the benefit of the remainder, and frequently living cells have their powers of exchange diminished by a thickening of the cell-wall sufficient to endow particular tissues with the necessary strength. Instances of such are afforded by collenchyma cells, as well as by the common occurrence of secondary thickening in the cortical cells of woody branches. It must also be remembered that dead elements may subserve other functions, as is instanced by the transport of water in dead wood-elements, and by the importance of cork in the regulation of transpiration.

The strengthening parts are arranged in all the higher plants in the form of a skeletal framework, the meshes of which are filled by the softer cells and tissues. The latter play an important part in joining together the strengthening framework, and so increasing the rigidity of the whole. Thin-walled turgid parenchyma, though easily torn by longitudinal tensions, can withstand considerable pressure. The union with longitudinally elongated bast and wood-fibres avoids the former danger, while the varied characters of the strengthening cell-walls, as well as their different arrangements, render possible various degrees of flexibility in plants and their organs. In this respect it is of great importance that the plant should be able to produce walls of different elasticity from similar materials.

In spite of individual differences, a general purposeful arrangement is recognizable, and the plant endeavours to gain sufficient strength with a minimum amount of strengthening materials. Thus frequently the strengthening cells form a continuous or interrupted hollow cylinder, the parts of which are joined together by the softer tissues or by special cross-ties, which counteract lateral strains and torsions, and prevent rupture. Similar arrangements to those adopted by plants are also employed by engineers to economize their constructive material. For example, a hollow cylinder, or a system of tied girders, gives a much more rigid structure, and can bear a greater strain than a solid rod composed of the same materials and having the same sectional area. The hollow stems of grasses are, therefore, mechanically advantageous. Furthermore, in long leaves and flattened stems in which bending is practically possible only in one plane, the mechanical cells are mainly present just beneath the upper and under surfaces, and this arrangement corresponds very closely to a double series of tied girders. Where mainly longitudinal tensions are involved, as in roots, and in the stems and petioles of certain

water-plants, the tensile strength is dependent solely upon the character of the material and its sectional area. Hence we find that the vascular bundles, and the mechanical tissues as well, occupy a more central position. A similar tendency is shown in rhizomes as compared with the upright stems of the same plant.

More especially in the herbaceous stems of monocotyledons, as Schwendener has shown, are the mechanical tissues arranged as close to the periphery as possible, that is, in the position where they give the greatest rigidity to the plant. Similar purposeful arrangements are exhibited in leaves and petioles, as well as in the herbaceous stems of dicotyledons. In the latter, peripheral layers of collenchyma or sclerenchyma are often present, and these, together with the somewhat more centrally placed ring of vascular bundles, form the main strengthening tissues. As the subsequent secondary growth progresses, the wood-cylinder acquires an increasing importance, and ultimately performs practically the entire mechanical function. In any case the ultimate rupture of the bark would render it incapable of yielding the required support. Frequently peripheral strands of mechanical tissue alternate with chlorophyllous parenchyma, and even when a continuous peripheral layer of sclerenchyma is present, as in the leathery leaves of conifers, it is interrupted beneath the stomata¹. Not only in leaves, but also in young stems, the arrangement of the mechanical tissues is such as to interfere as little as possible with other functions such as absorption and photosynthesis, and indeed the plant frequently sacrifices some of its strength or wastes a certain amount of constructive materials in order to favour the performance of important functions.

When necessary, special structures may be developed to protect the softer peripheral tissues from external pressure. Thus, the epidermis is frequently strengthened by secondary thickening of its walls, or by radiating strands of sclerenchyma, as in the acicular leaves of *Hakea brachyrhyncha*², in which strands of sclerenchyma extend between the central cylinder and the epidermis, leaving spaces filled with loose thin-walled parenchyma. In the case of soft-walled parenchyma cells, the smaller their diameter the greater is the total pressure they can withstand. Hence, in the extremely large cells of *Caulerpa*, transverse bars of cellulose are formed, which aid in stiffening the outer walls³. Transverse cell-walls and the cellular partitions formed across the large air-spaces of aquatic plants act in the same manner, and the interposition of solid nodes at regular intervals in the haulms of grasses and bamboos confers greater

¹ Cf. de Bary, *Comp. Anat.*, *Clar. Press Trans.*, 1884, p. 418 sq.

² A figure is given in Mohl's *Vermischte Schriften*, 1845, Pl. VII, Fig. 2.

³ Klemm, *Flora*, 1893, p. 463; Reinke, *Ueber Caulerpa*, 1899, and the literature quoted in those works.

mechanical rigidity, and aids in preventing kinking, especially if a large number of the bundles cross at the nodes. In general the pith is protected from external pressure by the vascular cylinder which encloses it, just as the cortex is frequently shielded from pressure by a hypodermal layer of sclerenchyma. In addition, the phloem is often covered by an outer layer of pericyclic sclerenchyma, while in the lime the masses of hard bast-fibres form a kind of skeletal framework in whose meshes the soft phloem tissue is sheltered.

For further details reference may be made to Haberlandt's comprehensive summary, and to the original paper by Schwendener¹. Branches and petioles are usually stronger towards their bases, where the greatest leverage is exerted, and this increase in the case of the haulms of grasses and sedges may very closely approximate to the required distribution of strength. In many cases, as in the leaves of *Phormium tenax*, longitudinal foldings or other changes of shape aid in conferring the required rigidity. Stahl and also Wiesner² have found that certain peculiarities of structure are for the purpose of avoiding the injurious effect of storms of wind, rain, or hail.

Etiological explanations do not, however, afford any insight into the physiological processes involved. The latter may be influenced by the external conditions, and these within certain limits also affect the rigidity of the plant. Thus the cell-walls are thinner and weaker in etiolated plants than in normal ones, and the strength of the plant and of special organs is partly dependent upon the demands made upon them. This power of response is very marked in the petioles of *Helleborus niger*, which can normally bear a load of 400 grammes, but may support a weight of 3,500 grammes if the load is very gradually increased. This is owing to the fact that certain thin-walled cells in the leaf-stalk develop into a pronounced ring of sclerenchyma³.

SECTION 16. Elasticity and Cohesion of the Cell-wall.

The great differences in the rigidity and elasticity of different cell-walls are mainly the result of their specific molecular structure. Thus certain bast-fibres whose walls are composed of cellulose have a tensile strength equal to that of wrought iron (13 kilogrammes per sq. millimetre), or even of steel (25 kgs.)⁴, whereas the elastic limit of the walls of parenchy-

¹ G. Haberlandt, *Physiol. Anat.*, 1896, 2. Aufl., p. 134. Cf. also Detlefsen, *Arb. d. Bot. Inst. in Würzburg*, 1884, Bd. III, pp. 144, 408, and the criticism of this work by Zimmermann, *Bot. Centralbl.*, 1884, Bd. XIX, p. 149; Schwendener, *Das mechan. Princip im Bau d. Monocotylen*, 1874.

² Stahl, *Regenfall u. Blattgestalt*, 1893, pp. 149, 170; Wiesner, *Ann. du Jard. bot. de Buitenzorg*, 1897, T. XIV, p. 283 sq.

³ For instances of the influence of pressure and strains upon the thickening and strength of the tendrils and hooks of tropical climbers see Ewart, *Ann. du Jard. bot. de Buitenzorg*, 1898, T. XV, pp. 193-195, 213, 217, 235.

⁴ For details see G. Haberlandt, *Physiol. Anat.*, 1896, 2. Aufl., pp. 143, 121. Cf. also

matous and meristematic cells is reached with a load of from 1 to 4 kgs. per sq. mm. Further, the cell-walls in the staminal filaments of *Cynareae* resemble india-rubber in so far as they can be stretched to double their length without the limit of elasticity being exceeded¹, whereas the walls of bast-fibres and of other cells are incapable of elastic stretching amounting to more than 0.5 to 1.5 per cent. of their length. Most lignified fibres behave similarly, but in *Cocos nucifera* and *Caryota urens*, as well as in *Agave americana*, certain lignified fibres may be stretched as much as 20 per cent. of their length without breaking. Suberized membranes cannot usually stretch by more than one to two per cent., but in the endodermis of *Prunus* an elongation of as much as 10 to 12 per cent. may be possible². The elastic properties of the cuticle agree in general with those of cork, but in the filaments of *Cynareae* it must be capable of as marked an elastic stretching as may take place in the cellulose walls of the epidermal cells.

Lignified cell-walls occupy an intermediate position between the extremes exhibited by different cellulose membranes as regards their power of imbibition and swelling, but this is probably because the former occur only in adult organs and are applied to much less varied purposes. The cohesion and elasticity of the cell-wall is not increased by lignification, and may even be slightly diminished according to Sonntag and Schellenberg; nor is the lignification of the cell-wall necessary to stop further growth. It may, however, render the cell-membrane more resistant to chemical and other disorganizing agencies. By covering the greater part of its surface with cuticle or cork, the plant is, however, enabled to regulate the rate of transpiration, and hence these changes are of great importance. When abundantly impregnated with silica, the cell-wall becomes harder and more brittle, but apparently without its tensile strength increasing³.

Walls containing the same or nearly the same percentage of water may differ as regards their elasticity and cohesion, but naturally as a wall absorbs more and more water, and its particles are pushed further and further apart, their cohesion, and hence the rigidity of the whole, must diminish, as is indeed the case in gelatinous membranes⁴. The tensile strength increases considerably as the imbibed water evaporates from swollen walls, and a slight increase also occurs when membranes dry which

Th. v. Weinzierl, Sitzungsber. d. Wien. Akad., 1877, Bd. LXXVI, Abth. 1, p. 411; Sonntag, Landw. Jahrb., 1892, Bd. XXI, p. 839; Schwendener, Bericht d. Bot. Ges., 1894, p. 243; Schellenberg, Jahrb. f. wiss. Bot., 1896, Bd. XXIX, p. 240.

¹ Pfeffer, Physiol. Unters., 1873, p. 106. The elastic stretching of these filaments was noticed by Covolo in 1764. Cf. Pfeffer, l. c., p. 81.

² Schwendener, Die Schutzscheiden u. ihre Verstärkungen, 1882, p. 40; Haberlandt, l. c., p. 121.

³ Cf. Ott, Bot. Centralbl., 1900, Bd. LXXXIV, p. 291.

⁴ See Reinke, Unters. über die Quellung, 1879, p. 30 (Hanstein's Bot. Abhandl., Bd. IV).

normally contain little water and are relatively rigid¹. The possible amount of elastic stretching seems at the same time to increase, and it is well known that completely dry cell-walls, if not impregnated with fat or oil, are brittle and can be pulverized. In the living plant, however, the cell-membranes are nearly or completely saturated with water, and hence we need only discuss their properties in this condition.

It is worthy of note that, at least in the mechanical cells, rupture occurs almost immediately the limit of elasticity is exceeded, whereas the breaking strain for metals is usually far beyond that at which they begin to undergo permanent elongation or change of shape (best wrought iron = 32 and 63, strongest steel wire = 50 and 130 kgs. per sq. mm. respectively)². This coincidence between the limits of elasticity and of cohesion (absolute rigidity) in cell-walls is especially well shown in the wood of maples and poplars, strips of which when subjected to longitudinal tension break before the limit of elasticity is reached, and is in harmony with the fact that a complicated structure cannot be strained beyond the limit of elasticity with safety, even although no actual rupture occurs. In accordance with this, the cell-walls of growing cells are not stretched up to their limits of elasticity, although when subjected to increased tension they may undergo a pronounced permanent elongation by plastic stretching. Thus Ambronn³ has shown that the limit of elasticity of collenchyma cells is exceeded by a load of 1 to 2 kgs. per sq. mm., whereas breaking occurs only when a load of 8 to 12 kgs. is reached. It is worthy of note that the elongation ceases with small loads in a few hours, possibly as the after effect of some such vital action upon the cohesion of the cell-wall as may also influence the growth in surface extent of the cell-wall. In any case an exact determination of the limits of elasticity is rendered very difficult in the case of bodies saturated with imbibed water, owing to the influence of tension and pressure upon the amount of water they contain⁴, and hence upon their

¹ This seems to apply to all organized bodies capable of imbibition, whether derived from animals or plants. According to Weinzierl (l.c., p. 460), the maximal tensile strength is reached when the percentage of water is reduced to a certain low limit.

² [In the case of platinum wire, however, the breaking strain (34 kgs. per sq. mm.) is very little greater than that at which permanent stretching begins, whereas strips of the wood of the oak and birch undergo permanent elongation with loads of 2.3 and 1.6 kgs. per sq. mm. respectively, but break only with loads of 5.6 and 4.3 kgs. per sq. mm. See Landolt and Börnstein's Tabellen, p. 275.]

³ Ambronn, *Jahrb. f. wiss. Bot.*, 1879-81, Bd. XII, p. 521; J. Cohn, *ibid.*, 1892, Bd. XXIV, p. 166; C. Müller, *Ber. d. Bot. Ges.*, 1890, p. 165; Haberlandt, l. c., p. 139.

⁴ Reinke, l. c., p. 17; Lehmann, *Molekularphysik*, 1888, Bd. I, p. 530. [There is in such cases no exact relationship between the amount of elongation and the stretching force, equal increments of the latter producing less elongation beyond a certain limit; that is, Young's modulus of elasticity increases beyond a certain degree of tension, just as it does in the case of a muscle fibre. Cf. Mackendrick's *Physiology*, Vol. I, p. 398. On the staminal filaments of *Cynareae*, cf. Pfeffer, l. c., p. 108. The modulus of elasticity of strongly stretched india-rubber and of elastic sinews increases progressively as the tension increases, and this although the sectional area decreases and no water is lost.]

elasticity. Similarly, many solids undergo slight progressive elongation when heavily loaded for some time.

The strength of wooden beams and hempen ropes has frequently been tested for technical purposes, but the first determinations of the strength with regard to the actual sectional area of component cell-walls were made by Schwendener and others. These values are, it is true, mere approximations, but suffice to establish the properties discussed above. As instances of a pronounced power of elastic stretching may be mentioned the spore-membranes of *Ascobatus* and other Ascomycetes, the medullary hyphae of *Usnea barbata*¹, the walls of laticiferous tubes², and the cellulose membranes in the expansive parenchyma of the fruit of *Impatiens*³. Growing cell-walls are readily extensible, but their limit of elasticity is low for suddenly applied strains. The modulus of elasticity, however, almost always increases as the membrane becomes adult, so that a greater strain is required to produce the same extension.

The elasticity and cohesion of the different layers of the cell-wall may differ according to their percentage of imbibed water, and according to their degree of cuticularization, lignification, or infiltration with waxy or mineral matters. When the power of swelling or optical behaviour differs along particular axes, a special micellar arrangement is presupposed, and hence the elasticity and cohesion may be unequal along two or even three axes. In the cylindrical cells of the staminal filaments of *Cynareae*, for example, the cell-walls appear to be less extensible tangentially than they are longitudinally. At least they retain the same transverse diameter when subjected to an internal rise of osmotic pressure sufficient to cause an elongation amounting to 20 or 30 per cent. of their length⁴.

SECTION 17. Elasticity and Cohesion of Tissues.

The elasticity and cohesion of the tissues is not dependent solely upon the properties of the cell-walls, but is also influenced by the turgor of the living cells, as well as by the manner in which the component cells are arranged and joined together. For example, turgid cells and tissues are comparatively rigid, but become flaccid and droop when turgidity is lessened or removed. An increasing external pressure will force more and more water from the turgid cells, which therefore contract to a smaller volume, while at the same time the concentration of the cell-sap increases, and hence the internal osmotic pressure rises. This takes place on the concave

¹ Haberlandt, l. c., p. 174.

² Schwendener, Sitzungsab. d. Berl. Akad., 1885, p. 326.

³ Eichholz, Jahrb. f. wiss. Bot., 1886, Bd. xvii, p. 561. Further instances are given by Küster, Sitzungsab. d. Berl. Akad., 1899, p. 825 (*Derbesia*); Nicotra, Sull' elasticità di tensione, &c., 1897-8 (repr. from Rend. dell' Accademia di Acireale, Vol. ix).

⁴ Pfeffer, Physiol. Unters., 1873, p. 110.

side of a turgid shoot or root when forcibly bent, and in some cases, as for example in the motile pulvini of *Oxalis* leaves, the active bending results in a pronounced compression of the cells on the concave side.

The escape of water takes a certain time, and hence partly arises the fact that thin-walled cells and tissues behave like a stick of sealing-wax, in that they are plastic under steady pressure and are capable of slow bending, but are brittle to sudden pressure and snap when rapidly bent. This brittleness is only shown in the turgid condition, but is also largely the result of the properties of the cell-walls. Hence it is not shown by the turgid staminal filaments of *Cynareae*, whose cell-walls are capable of considerable elastic stretching. Turgidity becomes of less and less importance as the cell-walls grow stronger and thicker, and the resistance to longitudinal tension is always independent of the turgor. In fact a turgid shoot is torn asunder by a smaller tensile strain than when it is flaccid, for in the first case the walls are already under considerable osmotic tension.

The arrangement and mode of union of the component cells are also of considerable importance with regard to the elasticity and power of stretching of tissues in response to tension. Thus in a loose tissue, as in a chain of india-rubber rings, the elongation may largely result from a change in shape of the component cells, coupled with a distortion of the bounding walls of the air-spaces. In tissues composed of cylindrical cells the elongation of the organ is the sum of that of the individual cell-walls, so long as no internal displacement or rupture occurs¹. The elasticity of the cell-wall usually increases when stretching growth ceases; growing cells which are stretched considerably are naturally the ones which shorten most when turgor is removed. Again, the growing regions of shoots and roots, owing to the properties of their cell-walls, are more or less plastic, and by steady pressure can be caused to assume abnormal curves or shapes, a fact well known to gardeners. These curvatures become permanent if the growing region is held fixed until adult tissue is formed.

This plasticity was studied by Sachs and also de Vries², and it is owing to it that a strongly shaken shoot curves in the direction of the greatest bending³. A drooping shoot can be more easily bent and wound around

¹ Nägeli and Schwendener, *Mikroskop*, 1877, 2. Aufl., p. 404.

² Sachs, *Lehrbuch*, 1873, 3. Aufl., p. 691; *Arbeit. d. Bot. Inst. in Würzburg*, 1873, Bd. 1, p. 393; de Vries, l. c., 1874, Bd. 1, p. 539. On the plasticity of tendrils cf. Pfeffer, *Unters. a. d. Bot. Inst. in Tübingen*, 1885, Bd. 1, p. 489.

³ Hofmeister, *Jahrb. f. wiss. Bot.*, 1860, Bd. 11, p. 237; Prillieux, *Ann. d. sci. nat.*, 1868, 5^e sér., T. IX, p. 248; Sachs, *Lehrb.*, 1873, 3. Aufl., p. 692. Kerner (*Schutzmittel d. Pollens*, 1871, p. 34) observed similar curvatures in rubbed or shaken flower-stalks. On the decrease in the diameter of shaken shoots cf. Kraus, *Sitzungsab. d. naturf. Ges. z. Halle*, 1881, p. 27. Shaking may also act as a stimulus.

a stick than a turgid one, and the new position may be rendered permanent by growth when turgidity is restored.

Rigidity and tension. The tension of a cell-wall due to turgor renders the cell more or less rigid, in the same way as when air or water is forced into a bladder or balloon. There is, however, no exact relation between the tension of the wall and the rigidity of the cell. Still less is this the case in tissues, for here the tissue-strains are variously modified by changes of turgidity, and the arrangement of the component cells is also of importance. The fundamental mechanical principles involved are dealt with by Nägeli and Schwendener, and the latter also discusses the mechanics of systems of tied girders¹. Hofmeister² ignored the importance of turgidity, and his discussions are by no means clear.

The amount of stretching is always dependent upon the elasticity and thickness of the cell-wall, as well as upon the osmotic pressure. The amount of tangential stretching varies inversely as the square of the radius of curvature, and hence small thin-walled cells are able to resist a high internal osmotic pressure, since the free portions of the walls are always strongly curved. In cylindrical cells the force of longitudinal extension due to the internal hydrostatic pressure is dependent upon the sectional area, and decreases with it³. Thick and highly elastic walls experience a very slight and often hardly perceptible shortening when turgor is removed by plasmolysis or death, but in growing cells, and in the staminal filaments of *Cynareae*, a pronounced shortening can be produced in this manner. By attaching weights until the tissue has regained its original length, it is possible in some cases to approximately calculate the original osmotic pressure from these data and from the sectional area of the tissue.

A plasmolysed cylindrical cell, when forcibly stretched, decreases in diameter for the same reasons as in the case of a stretched india-rubber tube. The latter becomes distended when water is forced into it, and to produce elongation without any lateral distension would require very special arrangements. The necessary conditions are, however, fulfilled in the cells of the staminal filaments of *Cynareae*, for these may be elongated 20 to 30 per cent. of their length by increasing turgor, without their diameters being altered⁴. This is possibly partly due to the unequal elasticities of the different portions of the cell-wall, and it is in fact possible in such cases that partial plasmolysis may cause a cell to elongate slightly.

A cylinder of metal or india-rubber, when strongly stretched, experiences a slight increase of volume⁵, and this presumably applies also to cylindrical cells when under considerable tension. The fall of hydrostatic pressure produced thereby is of little importance, for the absorption of water will rapidly restore the original osmotic pressure.

¹ Nägeli and Schwendener, *Mikroskop*, 1877, 2. Aufl., p. 404; Schwendener, *Das mechanische Princip im Bau der Monocotylen*, 1874, p. 109.

² Hofmeister, *Pflanzenzelle*, 1867, pp. 268, 273. Cf. Pfeffer, *Physiol. Unters.*, 1873, p. 147.

³ Pfeffer, *Period. Beweg. d. Blattorgane*, 1875, p. 114; Nägeli and Schwendener, *l. c.*, p. 412.

⁴ Pfeffer, *Physiol. Unters.*, 1873, p. 103.

⁵ Nägeli and Schwendener, *l. c.*, p. 399.

The cells of growing regions are the ones most stretched by turgor, as de Vries and Wortmann have shown¹. These authors, however, were incorrect in assuming that the greatest stretching was always shown at the most active period of growth, for Schwendener and Krabbe² frequently found that no such coincidence existed even in flowering plants. Even in the following values obtained from the young shoot of *Phaseolus multiflorus* it will be seen that in the second zone the percentage growth is only two-fifths that in the first zone, whereas the percentage contraction on plasmolysis has decreased by barely one-third of that in the first zone.

Zones in order from the apex.	Original length of zones.	Length after 18 hours.	Length after plasmolysis.	Growth in 18 hours.	Contraction on plasmolysis.	Percentage growth.	Percentage contraction.
I	14.75	21	19	6.25	2	42	9.5
II	16.25	19	17.75	2.75	1.25	17	6.6
III	15.5	15.5	15.5	0.0	0.0	0.0	0.0

The stretching due to turgor amounts in the cells of growing regions usually to from 3 to 20 per cent. of their length³. In some cases, however, as for example in *Spirogyra*⁴, the shortening on plasmolysis is only 2 per cent. of the length.

¹ De Vries, *Unters. ii. d. mech. Ursachen d. Zellstreckung*, 1877. This author also performed (*Arbeit. d. Bot. Inst. in Würzburg*, 1874, Bd. 1, p. 536; 1877, l. c., p. 117) stretching experiments on turgid and plasmolysed shoots. Wortmann, *Bot. Ztg.*, 1889, p. 234; cf. Bd. 11, p. 34. This method was first used by Dutrochet (*Mém. p. servir à l'histoire d. végétaux et d. animaux*, Bruxelles, 1837, p. 228), who determined the stretching due to osmotic pressure by the contractions occurring in saline solutions. Cf. also Pfeffer, *Physiol. Unters.*, 1873, p. 140. De Vries (l. c., 1877) used the plasmolytic method to determine the amount of stretching in the different growing zones.

² Schwendener and Krabbe, *Jahrb. f. wiss. Bot.*, 1893, Bd. xxv, p. 323.

³ De Vries, l. c.; Schwendener and Krabbe, l. c. Cf. also Pfeffer, *Druck- und Arbeitsleistungen*, 1896, p. 306. On fungi and algae cf. also Laurent, *Étude sur la turgescence chez les Phycomycètes*, 1885, p. 12 (*Bull. d. l'Acad. d. Bruxelles*, 3^e sér., T. x).

⁴ Pfeffer, l. c., 1896, p. 386.

CHAPTER V

THE STRAINS AND STRESSES IN TISSUES¹

SECTION 18. General.

THE existence of strains in the tissues is shown by the curvatures and changes of shape when particular tissues are wholly or partially isolated. If, for example, the epidermis with a portion of the subjacent tissue is removed in long tangential slices from a young petiole of *Rheum* or *Begonia*, or from a young stem of *Helianthus* or *Polygonum*, these strips shorten by from 1 to 4 per cent. of their length, while the central cylinder elongates by from 2 to 6 per cent. The latter was, therefore, compressed in the intact shoot, whereas the outermost tissues were stretched and under tension. The length of the intact shoot represents

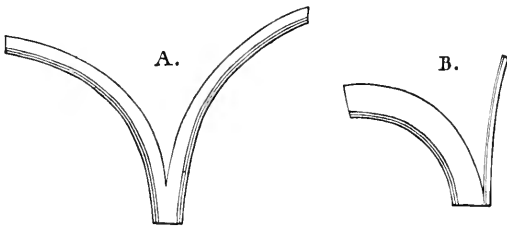

FIG. 14. Median slices from a nearly adult internode of *Coleus Blumei*. A, halved medianly; B, sliced peripherally.

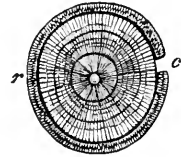

FIG. 15. Section of a three-year-old branch of *Salix Caprea*, from which the bark (*c*) has been removed and then reapplied.

the balance between the tendency of the epidermis to contract and of the central cylinder to expand. Hence, if a longitudinal slice from the centre of the stem is cut vertically into halves, these curve apart (cf. Fig. 14). Similarly, longitudinal strips from the inflorescence axis of *Taraxacum Deus-Leonis* curve outwards, and this bending continues in water until they are spirally coiled. These curvatures afford a general indication of the tissue-strains, but the absolute values can only be determined by finding the weight, as tension or pressure per unit area, necessary to restore the isolated tissue to its original length.

Transverse or tangential strains also exist, and these become very pronounced during secondary growth, for the increase in the diameter of

¹ [Throughout the following chapter this and similar expressions are given in their physical terms, although direct equivalents of the vague German words are current in botanical physiology. To speak of a tissue-tension when we often mean a tissue-compression, and in general a tissue-strain, is absurd, and the use of the terms negative tension and positive tension for tension and compression is highly confusing, and should be abandoned. A force producing a change of shape (strain) but no alteration of volume is a *shearing stress*.]

the wood-cylinder causes the bark to be passively stretched. Hence an isolated ring of bark shortens, and no longer meets around the stem when reapplied to it (cf. Fig. 15, *c*). The radial pressure exerted by the stretched bark upon the cambium and wood-cylinder is inversely proportional to the square of the radius, and directly proportional to the intensity of the tangential tension. The wood-cylinders of trees and shrubs are neither compressed nor elongated perceptibly even by the most pronounced tissue-strains, but the pith and other parenchymatous tissues may change considerably in shape when isolated.

The longitudinal strains in turgid stems and petioles have been investigated more especially by G. Kraus¹. The following table gives the values obtained by him in growing adult internodes of *Helianthus tuberosus*, the measurements being taken immediately on isolation without immersion in water. The changes of length are given in percentages of the length of each internode.

	Internodes numbered in order. I = youngest.	Length of internodes in mm.	Percentage change of length of the isolated tissues.		
			Epidermis.	Cortex + wood.	Pith.
<i>Helianthus tuberosus</i>	I-IV	35.4	- 4.3	- 1.7	+ 6.8
	V-VI	70.8	- 1.7	0.0	+ 6.6
	VI-VII	113.5	- 0.9	- 0.4	+ 4.4
	VIII	91.3	- 0.5	0.0	+ 3.2

Transverse strains. The epidermis is under tension in stems and petioles which undergo no secondary thickening, but a shortening of isolated rings of cortex was observed by Kraus² to appear first at the points where the internodes begin to broaden. Later this shortening increases in the stem of *Helianthus tuberosus* to as much as 3 to 4 per cent., and decreases again in the older basal internodes. The strains do not, however, always follow so regular a course. In the case of various woody plants, Krabbe³ observed a shortening of the isolated bark of from 1.5 to 4.5 per cent. after secondary growth had commenced.

Similar longitudinal and transverse strains exist in the internodes of grasses⁴, as well as in the motile pulvini of *Phaseolus* or *Mimosa*⁵. Fig. 16 represents a median longitudinal slice from the primary pulvinus of a leaf of

¹ Kraus, Bot. Ztg., 1867, and Table 1. Also Sachs, Physiology, 1865, p. 468, and Textbook, p. 769.

² Kraus, l. c., pp. 107, 115. Cf. also Hofmeister, Pflanzenzelle, 1867, p. 271.

³ Krabbe, Sitzungsab. d. Berl. Akad., 1882, p. 1,102; Wachstum des Verdickungsringes, 1884, p. 8.

⁴ Pfeffer, Druck- u. Arbeitsleistungen, 1893, p. 400.

⁵ Millardet, Nouv. rech. sur la périodicité de la tension, 1869, p. 13; Pfeffer, Physiol. Unters., 1873, p. 18, and Periodische Bewegungen, 1875, p. 3.

Mimosa pudica, and shows that the wood-cylinder (A and B, *h*) is compressed by the surrounding tissues. In the latter again the epidermis is stretched by the parenchyma within, as is shown in Fig. 16 B, by the curvatures resulting on slicing away strips of the cortex (*c* and *d*) from the wood-cylinder (*h*) and epidermis (*e*).

Pronounced tissue-differentiation is not necessary for the production of these strains, and the peripheral layers of the sporophores of Basidiomycetes are, for example, under tension¹. In higher plants, as the vascular bundles differentiate they become subjected to longitudinal tension, and this also applies to the bundles of the root, although the tension is much weaker². When, however, a contractile root subsequently shortens owing to the activity of the cortex, the strains are reversed, the cortex being under tension while the epidermis and vascular bundles are subjected to longitudinal compression.

Conclusions as to the strains in the tissues may be made from the changes of shape on isolation, or on removing certain parts. Thus the surface of a transverse section may become wavy, owing to the protrusion of the compressed tissues, and the retraction of those under tension. This can easily be seen in the nodes of grasses, the pulvini of *Phaseolus* and *Mimosa*, and also in old roots³. The transverse strains are more or less modified when the longitudinal strains are removed, for the elongation of the compressed pith which then occurs decreases its diameter, and correspondingly diminishes the radial pressure exerted by it. Similarly, the diameter of the cortex, and hence also the inwardly directed pressure exerted by it, tend to diminish when it is no longer stretched longitudinally. The mode in which these forces balance in the intact plant is, however, a purely physical problem⁴.

The magnitude of the shearing stresses becomes, in some cases, so great as to rupture resistant cell-walls and tissues, but even when the limit of elasticity is not exceeded the stresses may amount to 5, or even more than 15 atmospheres. Thus the tangential tension in the bark of trees often reaches 10 atmospheres, for Krabbe found that a weight of 100 grammes was frequently necessary to stretch an isolated millimetre square strip of bark to its original length⁵.

The stresses in the tissues of stems are often as great as this⁶, and

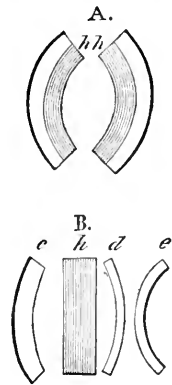

FIG. 16. The sections have been previously laid in water. (Magnified.)

¹ On algae cf. E. Küster, Sitzungsab. d. Berl. Akad., 1899, p. 819.

² Sachs, Arbeit. d. Bot. Inst. in Würzburg, 1873, Bd. I, p. 435. On the strains in the subterranean branches of *Yucca* and *Dracaena* cf. Sachs, Lehrbuch, 4th ed., p. 770.

³ Cf. Pfeffer, l. c., 1893, p. 404; de Vries, Landw. Jahrb., 1880, Bd. IX, p. 41; Detlefsen, Arb. d. Bot. Inst. in Würzburg, 1878, Bd. II, p. 38.

⁴ Various problems are clearly set forth by Nägeli and Schwendener, Mikroskop, 1877, 2nd ed., pp. 406, 414.

⁵ Krabbe, Sitzungsab. d. Berl. Akad., 1882. Cf. Exp. 30 on p. 1,116, in which 200 grammes were necessary per 2 sq. mm., i. e. 10,000 grammes per sq. cm., or a little less than 10 atmospheres (1 atmos. = 1,033 grammes per sq. cm.).

⁶ The earliest researches are those of Hofmeister (Pflanzenzelle, 1867, p. 276; Flora, 1862, p. 150). Kraus (Bot. Ztg., 1867, Tab., p. 9) did not measure the sectional area of the loaded

N. J. C. Müller even found that a pressure of $13\frac{1}{2}$ atmospheres (14 kgs. per sq. cm.) was required to prevent the pith of *Helianthus* from expanding¹. Pronounced strains also exist in motile pulvini², and in the nodes of grasses³.

These high values are hardly surprising, since growing organs may exert equally great pressure upon external objects. Within the plant the stretched tissues correspond to the external resistance, and the whole or a part of the osmotic pressure of the compressed tissues may be brought to bear upon them⁴. The whole of this pressure comes into play in the parenchyma of grass nodes⁵, and in the pith of *Helianthus*⁶, whereas in other cases the osmotic tension of the walls of the compressed tissue is only partly neutralized by the counteraction of the passively stretched tissues upon them⁷.

The History of our knowledge of the strains in tissues is closely connected with the study of certain movements. Thus Duhamel⁸ and also Lindsay⁹ recognized their importance for particular curvatures, which latter may be very rapid when pre-existent stresses are suddenly brought into play. Dutrochet¹⁰ distinguished between the stresses due to turgor and those due to the antagonism of the tissues, and also recognized that movements and changes in the strains might be produced by alterations of turgor and of the percentage of imbibed water in the cell-walls, as well as by growth. Hofmeister¹¹ attempted to refer the tissue-strains almost solely to the condition of imbibition of the cell-walls, and undervalued or neglected the importance of turgor. On the other hand, we owe to Hofmeister some valuable conclusions as to the appearance of stresses during the development of growing organs, and as to the distribution of the resulting strains in tissues as well as in cell-walls. Our knowledge was further broadened by Sachs¹², and more especially by G. Kraus¹³, while Nägeli and Schwendener have given us a clear view of the general physical principles involved in the correct interpretation of the tissue-strains¹⁴.

strips, and also incorrectly concluded that the change of dimension on isolation was directly proportional to the previous tension. [The stress and resultant strain are directly proportional only in the case of similar homogeneous materials.]

¹ N. J. C. Müller, *Bot. Unters.*, 1872, Bd. I, p. 53.

² Pfeffer, *Die periodischen Bewegungen d. Blattorgane*, 1875, pp. 105, 111.

³ *Id.*, *Druck- u. Arbeitsleistungen*, 1893, p. 401.

⁴ *Id.*, l. c., pp. 380, 400, 426.

⁵ *Id.*, l. c., p. 400.

⁶ Kolkwitz, *Fünfstück's Beiträge z. wiss. Bot.*, 1897, Bd. I, p. 246.

⁷ Pfeffer, l. c., pp. 380, 426; Schwendener and Krabbe, *Jahrb. f. wiss. Bot.*, 1893, Bd. XXV, p. 327; Kolkwitz, l. c.

⁸ Duhamel, *De l'exploitation des bois*, 1764, T. II, p. 479.

⁹ Lindsay, quoted in Pfeffer's *Physiol. Unters.*, 1873, p. 3.

¹⁰ Dutrochet, *Mémoires*, Bruxelles, 1837, pp. 225-235. Many of these conclusions were published in detail from 1824 onwards. Johnson (*Ann. d. sci. nat.*, 1835, 2^e sér., T. IV, p. 321) observed many instances of tissue-strains, but did not interpret them correctly.

¹¹ Hofmeister, *Jahrb. f. wiss. Bot.*, 1859, Bd. II, p. 237, and 1863, Bd. III, p. 81; *Flora*, 1862, p. 497; *Pflanzenzelle*, 1867, p. 267 seq.

¹² Sachs, *Experimentalphysiol.*, 1865, p. 465.

¹³ Kraus, *Bot. Ztg.*, 1867, p. 105, and 1871, p. 67; *Jahrb. f. wiss. Bot.*, 1869-70, Bd. VII, p. 209.

¹⁴ Nägeli and Schwendener, *Mikroskop*, 1867, 1. Aufl., p. 402.

SECTION 19. The Development and Alteration of the Tissue-strains.

It has already been mentioned that the tissue-strains result from the unequal activities of growth of different cells and tissues. These strains can only become pronounced when cells or tissues are formed, which offer considerable resistance to the longitudinal or radial expansion of more rapidly growing ones. Hence, in the primary meristems of stems and roots, and generally in plastic tissues, no pronounced strains are produced. The formation of relatively rigid tissues, such as the vascular bundles and sclerenchyma which ultimately cease to grow, renders possible the production of high internal strains, for these tissues may offer sufficient resistance to the expansion of those still capable of growth as to produce an enforced cessation of the latter function.

The strains thus produced usually undergo further changes, due to alterations of turgor, to the death of certain tissues, to thickening of the cell-walls and changes in their elasticity, as well as to internal processes of growth. Thus the compression disappears from the pith as it dies, and when stems become hollow owing to the rupture of the pith, the original compression has passed into a strong tension. Again, the transverse tensions increase when secondary thickening begins, and, more especially in roots, the previous longitudinal tensions in the wood and cortex become reversed at this time.

In some cases, as for example in the staminal filaments of *Cynareae*, and in the pulvini of *Mimosa* and *Phaseolus*, the stresses and strains produced during development persist during the entire life of the organ. In most cases, however, the tissues of an adult organ undergo less change of shape when isolated than they do towards the close of their development. G. Kraus erroneously concluded from this that the longitudinal strains were greatest when growth was most active, whereas this might result from the thickening or increased elasticity of the cell-walls without growth decreasing at all. There is, however, a certain diminution of the strains in most adult organs, although a resumption of growth or its acceleration may cause them to increase again¹.

Strains in the cuticle and cell-wall. That the cuticle is under strain is shown by the fact that the outward curvature of epidermal strips from *Agave* and *Hyacinthus* is produced in water, even when only the outer wall is present. The same takes place when a transverse section from an internode of *Nitella* or of a pollen-grain is cut in two². Again, the dissimilar character and power of swelling of the different lamellae of the cell-wall is shown by the twisting and curving occurring in the isolated outer wall of the epidermis, in moss peristomes, in

¹ On the tensions during perennation in winter cf. G. Kraus, Bot. Zeitung, 1867, p. 118.

² Hofmeister, Jahrb. f. wiss. Bot., 1863, Bd. III, p. 82; Pflanzenzelle, 1867, p. 267.

elaters, and in the spores of *Equisetum*, when moistened and dried. The layers of starch-grains are also under strain¹.

The growth of isolated tissues. Since the tissues are usually not fully turgid when isolated, they may at first undergo either a further elongation or shortening when placed in water. Tissues which were compressed in the intact organ and their growth prevented, now begin to grow, and in many cases cylinders of pith may become 40 per cent. longer². If growth is inhibited by the absence of oxygen, or by placing the pith in water at 0° C., only a slight elongation takes place, and this ceases when maximal turgidity is reached³. Under these circumstances a split dandelion stalk only curves to a moderate extent, whereas when growth is possible it gradually rolls up into a spiral.

It is hardly surprising that, as Sachs⁴ found, certain parts of the isolated pith-cylinder elongate distinctly in air saturated with water-vapour, for the same thing takes place when the younger parts of a shoot suspended in air grow by withdrawing water from the shrivelling older parts.

EXTERNAL INFLUENCES may permanently or temporarily affect the tissue-strains, just as in the case of growth and turgor, but the physiological reactions involved will be fully discussed in connexion with the processes of growth and movement. The direct physical effects of changes of temperature or of the percentage of water are easily predicted, although it must be remembered that a considerably increased stress may produce no perceptible result when the elasticity of the cell-walls is very high.

Water-percentage. Since the walls are unequally stretched, and the rigidity of thin-walled cells depends largely upon their turgor, the tissue-strains are usually distinctly affected by a decrease in the percentage of water, and in extreme cases may even be reversed. A decrease of volume also occurs, and G. Kraus⁵ showed that tree-stems and fruits swell slightly at night, and decrease again in daytime, when transpiration is active and the percentage of water reaches a minimum. The variations in the diameter of tree-trunks are, however, usually less than 1 per cent.

It is only when the loss of water is very great that the water of imbibition is withdrawn from the cell-wall, but even then the decrease of volume only

¹ Nägeli, Die Stärkekörner, 1858, p. 39; Nägeli and Schwendener, Mikroskop, 1877, 2. Aufl., p. 430.

² Kraus, Bot. Ztg., 1867, p. 123; N. J. C. Müller, Bot. Unters., 1872, Bd. I, p. 51. The elongating pith often undergoes a slight decrease of diameter. Cf. Bateson, Annals of Botany, 1890-I, Vol. IV, p. 117.

³ Schwendener and Krabbe, Jahrb. f. wiss. Bot., 1893, Bd. xxv, p. 327; Krabbe, *ibid.*, 1896, Bd. xxix, p. 450. Cf. II, § 10.

⁴ Sachs, Textbook, 2nd Ed., Clar. Press Trans., p. 850; Physiology, 1887, Clar. Press Trans., pp. 572, 573.

⁵ Kraus, Die tägliche Schwellungsperiode d. Pflanze, 1881 (repr. from Abhandl. d. naturf. Ges. zu Halle, Bd. xv), and Ann. d. Jardin botan. d. Buitenzorg, 1895, T. xii, p. 210. Cf. also Kaiser, Die tägliche Periodicität d. Baumstämme, Halle, 1879; Reuss, Bot. Centralbl., 1893, Bd. LV, p. 348; Friedrich, Bot. Ztg., 1897, p. 369; Fr. Darwin, Annals of Botany, 1893, Vol. VII, p. 485 (fruits). That stems increase in circumference when supplied with water was first shown by Hales, Statics, 1748, p. 74; Duhamel, De l'exploitation des bois, 1764, T. I, p. 331.

produces a shortening of 0.1 to 2 per cent. in the case of wood-cylinders¹, although in very swollen walls the decrease of volume on drying is naturally considerably greater. In this way powerful molecular forces may be called into play, leading ultimately to the rupture of the drying wood.

Temperature. The changes of turgor and of volume produced by alterations of temperature have little influence upon the tissue-strains², although the formation of ice in the plant may cause them to greatly diminish, and may even lead to a pronounced sinking of the branches of trees³.

Very marked curvatures and changes of position may result as physiological reactions to temperature, and these involve alterations in turgor or growth. Presumably a fall of temperature may produce in this way either a decrease or increase of the strains in the tissues, according to the character of the plant concerned. It is indeed possible that the drooping and flaccidity observed in some cases at from 1 to -2° C., without any formation of ice occurring, result from a physiological depression of turgor. The latter fact, however, has still to be determined, and indeed a physiological depression of turgor does not generally result when the temperature is lowered to the freezing-point, as is shown by the fact that the contractile staminal filaments of *Cynareae* do not shorten when cooled to 0° C., nor do the pulvini of *Mimosa* lose their motility⁴. The pronounced strains leading to cracks and ruptures during severe frosts⁵ are not merely the direct result of the contraction caused by the low temperature, but are largely due to the withdrawal of imbibed water from the cell-walls during the formation of ice, causing them to shrink and contract just as when they are dried.

¹ Hildebrand, Ann. d. Physik u. Chemie, 1888, N. F., Bd. xxxiv, p. 395. According to Villari (ibid., 1868, Bd. cxxxiii, pp. 412, 417) the elongation is greater radially than longitudinally, and the same is also the case for the expansion of dry wood by heat. For further literature see Nördlinger, Die technischen Eigenschaften d. Holzes, 1860; Hartig, Holz d. Nadelbäume, 1886, p. 101; Kitao, Bull. of College of Agriculture of Tokio, 1898, Vol. III, p. 299.

² Cf. True, Annals of Botany, 1895, Vol. IX, p. 399.

³ H. R. Göppert, Wärmeentwicklung, 1830, p. 112; Gefrieren u. Erfrieren, 1883, p. 10; Hofmeister, Zelle, 1867, p. 279; Moll, Influence d. l. gelée s. l. plantes toujours vertes, 1880, p. 9 (repr. from Archiv. Néerlandaises, T. IX). Cf. also Wille, Bot. Centralbl., 1884, Bd. xviii, p. 220; Johow, Bot. Jahrb., 1888, p. 525; Vöchting, Berichte d. Bot. Ges., 1898, p. 51; Geleznow, Rech. s. l. quant. et l. répartition. d. l'eau d. l. tige d. plant. ligneuses, Mélang. biolog. t. d. Bull. d. l'Acad. d. St.-Petersbourg, 1872, T. IX, p. 667. The older literature is quoted there. See also Bot. Ztg., 1867, p. 383.

⁴ In most cases it has not been determined whether the sinking was due to the tissues themselves becoming flaccid, or merely to an insufficient supply of water. According to Kraus (Bot. Ztg., 1867, p. 124), a fall of temperature of from 38 to 14° C. produces only a slight, but below 7° C. a pronounced, fall of the tissue-strains as measured by the changes of size on isolation, but this requires further explanation. Krabbe's results (Jahrb. f. wiss. Bot., 1896, Bd. xxix, p. 447) do not prove that at from 0 to 5° C. the absorption of water is retarded by the plasmatic membrane, and, in fact, Rysselberghe has shown that plasmolysis is produced by the same strength of solution at 0° C. as at 15° C.

⁵ Göppert, Erfrieren d. Pflanzen, 1883, p. 14; Müller-Thurgau, Landwirt. Jahrb., 1886, Bd. xv, p. 483; Hartig, Forstlich-naturwiss. Zeitschrift, 1894, p. 255; Frank, Krankheiten d. Pflanzen, 1895, 2. Aufl., Bd. I, p. 210. Duhamel (De l'exploitation d. bois, 1764, T. I, p. 324) observed a slight decrease in the circumference of trees when frozen.

CHAPTER VI

THE INFLUENCE OF THE EXTERNAL CONDITIONS ON GROWTH

PART I

GENERAL VIEW

SECTION 20. **The Formal Conditions for Growth.**

A SUFFICIENT supply of food and water and a certain temperature form three conditions essential for all life and growth. Oxygen and calcium are necessary for most plants, but not for all, while particular organic compounds serve as food for some metatrophic plants, but not for others. Light is necessary to the aerial organs of green plants, but not to non-chlorophyllous plants and organs. With regard to all these factors, moreover, the quantitative requirements of different plants vary within wide limits.

Growth is also influenced by various non-essential agencies, some of which, such as poisons and the like, are not present under natural conditions. Poisons, when presented in sufficient dilution, may allow slow and feeble growth, but when an appropriate dilution is reached the plant commonly responds by a physiological counter-action, involving an increase of metabolism, and frequently also of growth and of movement. A similar reaction, coupled with a special formation of healing tissue, is shown as the result of injury. These reactions, as well as the heliotropic, geotropic, and nyctitropic ones, are of great importance to the plant under normal conditions, but nevertheless they are not essential factors for growth, which may take place equally well when none of them are exercised. As a matter of fact, every external agency, when sufficiently intense, must exert some influence or other upon the organism, and even magnetic forces must affect plants, directly or indirectly, in some way or other¹.

On the other hand, the absence or insufficiency of any one of the essential factors renders growth impossible, and a retardation and ultimate cessation of the latter infallibly occurs when either the temperature or

¹ Cf. Ewart, *On Protoplasmic Streaming*, 1903, Clar. Press, pp. 45-52.

the percentage of water falls below the minimal limit. Similarly, active vegetation begins in spring only when a sufficient temperature is reached, even although all the other conditions were previously amply satisfied.

The result produced depends upon the receptivity and power of response of the particular plant at the given time, that is, upon its general tone. The latter is influenced by the supply of water and of food, as well as by the most varied external agencies, so that the effect of temperature is not the same, at least quantitatively, upon drooping or starved plants as upon turgid and well-nourished ones. Indeed, in some cases changes of tone may lead to the reversal of the response to a particular stimulus. Hence, the relationship between a varying factor and the physiological response it produces can only be empirically determined for a particular set of external conditions, and it may vary when these alter. The joint effect of two factors cannot therefore always be predicted from the results they produce when acting singly.

A sufficient alteration in any one of the essential factors, co-operating in the production of growth, must necessarily produce a change and ultimate cessation of the latter. Thus, a rise of temperature above the optimum produces a retardation and ultimate cessation of growth, although the activity of respiration is much increased, while metabolism may still continue after the absence of oxygen has caused the growth of an aerobe to cease. Again, a plant may be rendered immotile or incapable of CO_2 -assimilation by moderate anaesthetization, although respiration persists. A complete temporary cessation of all vital functions can probably only be produced by the action of extreme cold and by desiccation upon resistant seeds, spores, and adult plants. According to the agency producing partial or complete arrest of the vital functions we may speak of *heat-rigor*, *cold-rigor*, *dry-rigor*, or *rigor mortis*, and to indicate the agencies necessary for the production and maintenance of the power of response, we may follow Sachs and use such terms as *thermotonus* and *phototonus*¹.

For each essential external agency a minimum and maximum limit can be recognized between which growth is possible, while the optimum point is that at which it is most active. Similar curves are given by the action of non-essential agencies of steadily increasing intensity, although the cardinal points for different functions may differ widely. A pronounced optimum need not necessarily be shown, however, and thus the respiratory curve steadily rises with increasing temperature until the plant is injured or killed, whereas the curve of CO_2 -assimilation exhibits a very pronounced optimum and then falls again².

¹ Sachs, *Flora*, 1863, p. 449. Cf. also Czapek, *Jahrb. f. wiss. Bot.*, 1898, Bd. xxxii, p. 195.

² Cf. Errera, *Essais d. phil. bot. sur l'optimum*, 1896 (*Rev. de l'Univ. de Bruxelles*, T. 1).

The curves for different functions naturally do not necessarily follow precisely the same course. Thus the respiratory curve may not have reached its maximum at a temperature at which growth has nearly or quite ceased. The best conditions for development will, however, not always be those at which growth is most active, and in fact an excessive development of the vegetative organs hinders or prevents flowering. Again, certain fungi and algae only complete their life-cycles under the stimulus of changes in the external conditions. There is, therefore, a certain biological optimum for the most advantageous development, but this optimum varies according to the ends and purposes in view¹. For example, the optimal conditions for the production of *Mucor*-yeast differ widely from those for the formation of a sporangiferous mycelium. These conclusions apply equally well whether all the factors are variable, or all but one are constant, for in the latter case the variable factor will determine whether the optimal activity of growth is or is not reached².

The cardinal points are liable to slight variations, and hence can only approximately be determined. Growth, for example, continues for a time under conditions which ultimately cause a complete cessation of all vital activity. This cessation follows more or less rapidly according to whether the permanent maximum is largely or only slightly surpassed. In the case of a temporary anaerobe, growth may continue for a longer or shorter time in the absence of oxygen, according to the character of the food-material and of the organism itself. Similarly, the growth of organs requiring light may not be pathologically disturbed until after several days' darkness. This power of withstanding fatally injurious influences for a short time is of great importance for the maintenance of plants in nature. Indeed, an organ which was injured by a few hours' absence of light could not survive the alternation of night and day.

The position of the maximum and minimum points is largely dependent upon the power of accommodation the plant possesses, and it is indeed possible to gradually accustom plants and animals to doses of poisons which previously would have been fatal. Similarly, plants may accommodate themselves to concentrated media, to subminimal or supra-maximal percentages of oxygen, and even to a certain extent to extremes of temperature. A change in the external conditions may produce more or less corresponding internal alterations, and hence may cause a slight or a pronounced displacement of the cardinal points for a particular agency. This is well illustrated by the fact that the resistance to heat, and to other influences as well, is greatly increased by desiccation.

¹ Schimper, Pflanzengeographie, 1898, p. 50.

² Cf. Wollny, Forsch. a. d. Gebiete der Agriculturphysik, 1897, Bd. xx, p. 53.

The activity of growth corresponding to a new temperature is rapidly assumed, whereas a change of illumination often acts extremely slowly, the after-effect of the previous conditions persisting for a long time. Sudden changes of temperature, or of concentration, also produce a certain disturbance which may take the form either of a transitory retardation or acceleration of growth, or the one reaction may follow the other.

In addition to the essential external agencies which regulate growth and render it possible, others may exercise a special stimulating action upon it. This occurs during the reaction to wounding, and when the perennation period is shortened by treatment with chloroform. Chemical stimuli are required to induce the germination of certain seeds and spores, and indeed it is hardly surprising that nutrient materials should act as a stimulus to germination upon the spores of many mould fungi. In such cases, by satisfying special requirements, influences retarding growth are removed. On the other hand, a direct retardation is produced upon the growth of nitrifying bacteria by small traces of sugar, which for most plants is an excellent food-material.

SECTION 21. Formative Reactions.

The external conditions influence not only the rapidity of growth but also its character, and frequently in such a manner as to produce pronounced change of shape. Thus the land and water forms of different plants, as well as the stages in the life-cycle of a metoxenous fungus, may differ so greatly as to appear like distinct species to the unscientific observer. Similarly, special external conditions may cause the non-production of certain organs, or the omission of certain stages in the life-cycles of a few plants. Not only may generally distributed influences produce special growths, but also localized ones, as is illustrated by the formation of galls, and by the formation of callus-tissue over wounds. Similarly, the unilateral action of light, gravity, moisture, or oxygen may induce asymmetric growth, and thus lead to dorsiventrality, or to the production of curvatures which are of great importance in the correct orientation of the plant and its organs.

At the same time the internal structure may also be affected, and indeed internal formative changes may occur subsequently to the attainment of adult shape¹, as, for example, when an internal injury is healed in an adult organ, or when an increased stress causes a thickening of the cell-walls in the mechanical tissues of a stem, or when an increase of transpiration

¹ Numerous instances are given in Goebel's *Organography*, Clar. Press, 1900. Cf. also Schumann, *Bot. Centralbl.*, 1891, Bd. XLV, p. 357.

causes a more pronounced development of cuticle in an adult leaf. Frequently different influences produce similar results, and this fact is often of economic value. Then a deficiency of water or food, and indeed unfavourable conditions in general, induce or increase the tendency to perennation, or to produce perennating organs, or the formation of reproductive organs, such as flowers, spores, and the like. In this way reactions are awakened which are directed towards the maintenance and preservation of the species. Such reactions are purposeful in character in this respect, as are also the various tropistic curvatures produced by external stimuli in the preservation and maintenance of the individual plant. As might be expected, radiant energy in the form of light is more effective in producing changes of shape than is heat, for except as regards the radiant heat directly received during insolation, no arrangement of the parts can prevent the plant ultimately assuming a temperature approximating closely to that of the surrounding medium, even when transpiration is active¹.

The amount of the reaction is mainly determined by the inherited properties of the plant, and in most cases the range of the reaction is very limited, either in regard to all or to single stimuli. Plants which have only a slight power of adaptation are either unable to exist or grow but feebly under conditions which permit of the luxuriant growth of plants of more plastic character. Not all plants are, however, able to reacquire this property of plasticity when once it has been lost, or to transmit it to their descendants, and in such cases only a limited range of distribution is possible.

The energy for growth and movement is in all cases derived from the external world, and external stimuli may also induce the local or general utilization of this energy, or may retard or inhibit particular functional activities, and call potential powers into play which were previously not exercised. Since, however, the action of a particular stimulus is dependent upon the nature of the organism or of the part of it affected, no complete view of the processes involved in growth and in growth-reactions can be given until the internal factors concerned are fully known. Hence such terms as Chemomorphosis and Photomorphosis² simply indicate formative changes resulting from particular agencies, and do not afford any explanation as to how these changes are brought about. All such changes are in fact automorphic in character, since they result from the plant's own

¹ Extremes of temperature induce spore-production by creating unfavourable conditions.

² The term *heteromorphosis* (Vol. I, p. 24) has been applied by Loeb (Unters. z. physiol. Morph. d. Thiere, I. Heteromorphose, 1891; cf. Hertwig, Die Zelle u. d. Gewebe, 1898, p. 182) to new growths occurring in unusual situations, or which assume peculiar shapes. Hence the terms 'zenomorphosis' or 'aitiomorphosis' (*aitios*, founder) may be used in the more general sense. From the latter term, aitionomic, aitiogenic, aitiotropism, aitionasty may be derived.

activity, the external agency simply acting as a stimulus which directs this activity along particular channels.

Not only different plants, but also the different organs of the same plant, have dissimilar powers of response, and hence have been termed *anisotropic* by Sachs¹. The opposed geotropic irritabilities of the stem and root is one instance of anisotropy, and another is afforded by the dissimilar behaviour of the upper and under surfaces of dorsiventral organs. Here, and in other cases also, the anisotropy is accompanied by differences of structure, but there may be a physiological dissimilarity without any visible morphological one.

Whenever anisotropy is present, a diffuse stimulus acting with equal intensity on all sides may produce an unequally distributed reaction, such as a curvature or thickening on a particular side. To produce such an effect on an isotropic and physiologically radial organ the stimulus must either act on one side only or with greater intensity on that side.

From a physiological point of view the orienting curvatures produced by one-sided stimulation may be termed 'tropistic' (*geotropism*, *heliotropism*). Curvatures produced by diffuse stimuli owing to the physiological dorsiventrality of the organ affected may be termed 'nastic' (*photonasty*, *geonasty*, *autonasty*), while to indicate the side whose growth is accelerated the terms *epinasty*, *hyponasty*, *paranasty* may be used (viz. *photoepinasty*). Unilateral thickening by internal or external causes may be called 'trophic,' and the term 'auxesis' (*photoauxesis*) may be used to denote the predominant formation of leaves, roots, or hairs upon a particular side².

¹ Sachs, Arb. d. Würzb. Inst., 1879, Bd. II, p. 226. Cf. Czapek, Jahrb. f. wiss. Bot., 1898, Bd. xxxii, p. 302.

² For the morphological terminology cf. Goebel's *Organography*, Clar. Press, 1900, p. 65 seq. Schimper (quoted by Hofmeister, *Allg. Morphol.*, 1868, p. 604) applied the terms 'epinasty' and 'hyponasty' to the excentric growth in thickness of branches, but following de Vries (Arb. d. Würzb. Inst., 1872, Bd. I, p. 252) they have been used to denote the unequal growth in length of two opposed sides. 'Photonasty' was used by Pfeffer (*Pflanzenphysiol.*, 1880, I. Aufl., Bd. II, p. 287) and 'paranasty' by Holl (Arb. d. Würzb. Inst., 1885, Bd. III, p. 229) in the same sense. Wiesner (*Ber. d. Bot. Ges.*, 1895, p. 485; *Sitzungsbd. d. Wien. Akad.*, 1895, Bd. CIV, I, p. 83) denoted excentric growth in thickness by the term 'trophism,' while Weisse (*Ber. d. Bot. Ges.*, 1895, p. 385; cf. also Czapek, *Jahrb. f. wiss. Bot.*, 1898, Bd. xxxii, p. 289) proposed the term 'auxesis' to indicate the formation of appendages on dorsiventral organs.

[This terminology cannot be said to be satisfactory, nor does it even tabulate the observed phenomena into well-defined and separable groups. Gravity, for example, is not a one-sided stimulus, but is more perfectly diffused than any other, since even in lofty trees it has practically the same intensity at all parts, the maximal difference in its intensity at base and apex being $\frac{1}{4} \frac{1}{1000} g$. The primary geotropic curvatures are the result of a diffuse stimulus acting upon the physiologically bipolar embryo; the fact that the force of gravity is directed towards the centre of the earth is immaterial to the point at issue, and if the cell-contents were of uniform density throughout no geotropic response would be possible. A horizontally-placed radicle curves downwards because the same stimulus produces unequal growth-responses in its upper and under surfaces, i. e. because in this position it becomes for the moment physiologically dorsiventral. This is probably due to the fact that the settling of the denser materials on the under but normally lateral sides of the cells acts as a stimulus awakening unequal growth-responses, but in any case the power of discrimination lies in

None of these phrases give any explanation of the phenomena they are used to connote, and hence when we say that an organ curves towards a source of illumination because of its heliotropic irritability, we are simply expressing an ascertained fact in a conveniently abbreviated form, without explaining why such curvature is possible or how it is produced. Indeed, the classification of the phenomena will differ according to whether predominant importance is attached to the properties of the organism, the mode of response, the resulting growth, or to the aims and purposes. Many observers have unfortunately devoted their attention to artificially classifying the phenomena observed, and have entirely neglected the explanation of the causes underlying them¹. From a general point of view we may distinguish between—

A. Essential formal conditions.

(a) Sources of energy and food.

(b) Stimulating factors (temperature, oxygen, &c.).

B. Accessory non-essential factors. These act mainly as stimuli.

With regard to the essential and non-essential stimuli and their results, we may distinguish between—

A. Accelerating and retarding stimuli, which either influence the rapidity of growth generally, or locally, as in all curvatures.

B. Formative or morphogenic stimuli, leading to local or general changes of shape.

(a) Exciting stimuli, which induce or inhibit the development of the organism, or of its resting primordia.

(b) Morphogenic stimuli, such as may lead to changes of shape or may even cause the primordium of a root to develop into a shoot.

(c) Regenerative and degenerative stimuli, which induce or suppress the formation of special organs.

(d) Special generative stimuli, which induce formations not normally produced.

According to the mode of stimulation we may discuss in all cases—

A. Direct stimulation.

B. Indirect stimulation, in which the disposition is altered and thus a special result produced.

the organism, for in the vertical position the same stimulus is inoperative. In the case of heliotropic curvatures, the intensity of the illumination differs considerably at the outset on the two sides, even in semi-transparent unicellular organs, and we do not know whether it is the direction of the light or the difference of illumination on the two sides which acts as a stimulus. Only in the former case would there be any analogy with a geotropic curvature. Again, the term 'trophic' is used in *Animal Physiology* (trophic nerves, trophic fibres, trophism) in a widely different sense to that suggested above. Further, the term 'auxesis' has long been used in its original general sense, 'heterauxesis' merely denoting irregular growth whatever its origin (cf. Vines, *Physiology*, 1886, pp. 376, 422), and this use has been generally accepted.]

¹ Herbst, *Biol. Centralbl.*, 1895, Bd. xv, p. 822.

C. Correlative stimulation, in which functions not directly affected are indirectly modified. This occurs very commonly, although growth is not always perceptibly influenced.

Lastly, in all the above types we are concerned with—

- (1) Homogeneous or diffuse stimuli; (2) unilateral or directive stimuli; (3) transitory stimuli; (4) stationary or permanent stimuli.

Transitory stimuli usually produce no permanent formative changes. In the case of wound-reactions we are dealing partly with a permanent stimulus owing to the persistent after-effect. Similar classifications apply to internal stimuli, which are, however, more difficult to determine. The difficulty of classification is rendered still greater by the fact that frequently the same agent may produce several effects, and that the nature of these may differ according to the other conditions. Thus, in the presence of particular food, light becomes non-essential for certain facultatively heterotrophic algae, and oxygen for certain facultative anaerobes. Further, a change in the external conditions causes *Vaucheria* to produce sexual organs instead of swarm-spores, and vice versa. Moreover, no definite distinction can be made between normal and abnormal growth. Indeed, any one who had only seen the aquatic form of an amphibious plant or the yeast form of *Mucor* would regard the aerial forms as abnormal growths due to the unusual conditions. Pathological growths, whatever their origin may be, always result from definite causes, and in many cases their study, although really a subject apart, affords important evidence as to the normal progress of various functions.

Historical. Dutrochet¹ was the first to clearly distinguish between the essential formal conditions for growth and the reactions due to external agencies or arising from internal stimuli. These relationships were further discussed by Sachs, and a deeper view into the nature and mode of such responses has been given by Pfeffer².

PART II

THE INFLUENCE OF TEMPERATURE

SECTION 22. The Cardinal Points for Growth.

THE dependence of growth on temperature is well shown by the partial or complete arrest of growth during cold spring days, and its resumption or increased rapidity when the temperature rises sufficiently. Similar observations reveal the dissimilar requirements of different plants

¹ Dutrochet, Rech. anat. et physiol. s. l. structure interne d. animaux et végétaux, 1824, pp. 8-162.

² Pfeffer, Die Reizbarkeit d. Pflanzen, 1893, pp. 12, 18 (repr. from Verhandl. d. Ges. deutsch. Naturf. u. Aerzte, 1893); Sachs, Flora, 1863, p. 449. Sachs termed all movements resulting from stimuli *paratonic*.

as regards temperature. This is also shown in the appended table, in which it will be seen that the minima, optima, and maxima diverge widely in different cases.

TABLE I.

	MINIMUM ° C.	OPTIMUM ° C.	MAXIMUM ° C.	
<i>Triticum vulgare</i> . . .	0-5	29	42	Uloth and Sachs
<i>Sinapis alba</i> . . .	0	27	over 37	Kirchner and de Vries
<i>Acer platanoides</i> . . .	7-8	24	26	Tietz
<i>Pinus sylvestris</i> . . .	7-8	27	34	Tietz
<i>Phaseolus multiflorus</i>	9	34	46	Sachs
<i>Zea Mays</i>	9	34	46	Sachs
<i>Cucurbita Pepo</i> . . .	14	34	46	Sachs
<i>Cucumis sativus</i> . . .	15-18	31-37	44-50	Haberlandt
<i>Vaucheria repens</i> . . .	0-3	10-20	30	Klebs
<i>Hydrurus foetidus</i> . . .	0 (?)	10 or under	below 16	Klebs
<i>Ulothrix zonata</i> . . .	0	below 15	below 24	Klebs
<i>Saccharomyces</i> . . .	0 (?) - 6	28-34	34-40	Pedersen, Hansen
<i>Penicillium glaucum</i> . . .	1-5	25-27	31-36	Thiele
<i>Mucor racemosus</i> . . .	4	20-25	33	Klebs
<i>Eurotium repens</i> . . .	7	25-30	38	Klebs
<i>Aspergillus niger</i> . . .	7-10	33-37	40-43	Thiele
„ <i>fumigatus</i>	15	38-40	60	Cohn
<i>Putrefactive bacteria</i> (mostly)	0-10	24-36	35-45	
<i>Bacillus subtilis</i> . . .	below 5	24	50	Cohn, Brefeld, Schreiber
„ <i>cyaneo-fuscus</i>	0	10	22 (?)	Beyerinck, Bot. Ztg., 1891, p. 709
<i>Acetic bacteria</i> . . .	below 8	18-33	30-36	Henneberg, Centralbl. f. Bact., 1898, IV, p. 19
<i>Bacillus anthracis</i> . . .	12-14	37	42-43	} Cf. Flügge, l. c.
„ <i>tuberculosis</i> . . .	30	38	41	
<i>Thermophile bacteria</i> . . .	33-50	60-70	75	Cf. Fischer's Bacteria

The direct influence of temperature on growth can be seen from Table II, taken from Koppen, which gives the lengths attained by seedlings originally of the same size after they have been kept 48 hours at the given temperature.

TABLE II.

Temperature.	<i>Lupinus albus.</i>	<i>Pisum sativum.</i>	<i>Vicia Faba.</i>	<i>Zea Mays.</i>	<i>Triticum vulgare.</i>
° C.	mm.	mm.	mm.	mm.	mm.
10.4	—	5.5	—	—	4.6
14.4	9.1	5.0	—	—	4.5
17.0	11.0	5.3	—	—	6.9
21.4	25.0	25.5	9.3	3.0	41.8
24.5	3.10	30.0	10.1	10.8	59.1
25.1	40.0	27.8	11.2	18.5	59.2
26.6	54.1	53.9	21.5	29.6	86.0
28.5	50.1	40.4	15.3	26.5	73.4
30.2	43.8	38.5	5.6	64.6	104.9
31.1	43.3	38.9	8.0	49.4	91.4
33.6	12.9	8.0	—	50.2	40.3
36.5	12.6	8.7	—	20.7	5.4
39.6	6.1	—	—	11.2	—

In certain cases the maxima and minima surpass the limits of 0° C. and 75° C., for in the hot springs of America certain lowly-organized algae are said to grow in water at 85° C. or even 93° C., while on the Arctic coasts algae flourish in sea-water whose temperature falls to -1.8° C. and perhaps never exceeds 0° C.¹

In the hot springs of Carlsbad *Oscillarias* appear first at 53.7° C. according to Cohn², and as the temperature falls other species of *Oscillaria*, as well as of Diatoms and other algae, appear. At Bex an alga occurs in water at 57° C. according to Serres³, while in the hot springs of the Yellowstone Park Weed⁴ found algae in running water at 70-85° C., and Brewer⁵ found algae in water at 90-93° C. at Pluto Creek in California. Tsilinsky⁶, however, could only detect living bacteria germs in water at Ischia up to a temperature of 70° C.

Weed and Brewer do not state whether the algae actually grew in the water at the temperatures given, and if they came from parts at a lower temperature, the spores and resistant forms might easily retain their vitality for some time,

¹ Kjellman, Bot. Ztg., 1875, p. 771. On the temperature in the depths of the ocean cf. Walther, Einleitung i. d. Geologie als historische Wissenschaft, 1893-4, Bd. I, p. 47.

² Cohn, Flora, 1862, p. 328. Cf. also Hoppe-Seyler, Pflüger's Archiv f. Physiol., 1875, Bd. XI, p. 118. For the older literature see de Candolle, Physiologie, 1835, T. II, p. 662; Ehrenberg, Monatsb. d. Berlin. Akad., 1858, p. 493; Lauder Lindsay, Bot. Ztg., 1861, p. 358; Hoppe-Seyler, l. c., p. 113.

³ Serres, Bot. Centralbl., 1880, p. 257.

⁴ Weed, Bot. Centralbl., 1890, Bd. XLIV, p. 400.

⁵ Brewer, quoted by Weed, l. c. A general summary is given by C. W. Davenport, Archiv f. Entwicklungsmechanik, 1895, Bd. II, p. 233.

⁶ Tsilinsky, Ann. d. l'Institut Pasteur, 1899, Bd. XIII, p. 788.

just as the spores of certain bacteria do when boiled. Hence all such observations, and more especially those dealing with transitory temperatures, need to be accepted with great caution. How easily errors may arise is shown by the fact that Hoppe-Seyler observed a surface-temperature of 44–45° C. in a streamlet whose deeper layers were cooled by the continual access of cold water to 25° C., and contained numerous fishes that fell into heat-rigor when brought to the surface. Observations with regard to temporary low temperatures are equally liable to error¹.

No plant is known which can accommodate itself to the lowest as well as to the highest extremes given above, the greatest observed range amounting to less than 50° C., and being usually much less than this, as is in fact of necessity the case when the maximal limit is low. The latter applies to *Hydrurus*, whose maximal limit of 16° C. is 60° C. lower than that of thermophile bacteria. Thermophile organisms have a high optimum as well as a high maximum, but a moderate rise of the minimum point does not always involve a corresponding rise of the optimum.

Owing to the dissimilarity between the situations of their cardinal points, certain plants grow best at temperatures which do not permit of the growth of others. Thus, a few species of thermophile bacteria first begin to develop at temperatures sufficiently high to kill most plants, and their most active growth occurs in nutrient solutions hot enough (60–70° C.) to scald one's finger. The spores of these organisms are widely distributed, but it is only rarely that they find the temperatures necessary for their development. Such organisms as these, as well as the thermophile *Aspergillus fumigatus*, are of importance in that they can continue the process of decomposition in manure-heaps and the like, in which the fermentative activity of the commoner micro-organisms has caused so great a rise of temperature as to prevent their further development.

The greatest extremes are shown among fungi, bacteria, and the lower algae, although most of these plants exhibit a range of accommodation little or no greater than that of flowering plants, in which the optimum lies usually between 24° and 34° C., the maximum between 26° and 46° C., and the minimum between 0° and 16° C. The minimum is often higher in tropical plants than in those of temperate regions², although here also plants exist which have a high minimum. Other plants, such as *Hydrurus* and *Ulothrix zonata*, require a low temperature, so that it is only in spring that most streams are cold enough for them, and in summer they die down and perennate by means of resting spores³.

¹ Cf. Ewart, *Annals of Botany*, Vol. XII, 1898, pp. 367–73.

² This was first pointed out by de Candolle, *Physiologie*, 1833, Bd. II, p. 277. See also Sachs, *Jahrb. f. wiss. Bot.*, 1860, Bd. II, p. 365; Haberlandt, *Wiss. Unters. a. d. Geb. d. Pflanzenbaues*, 1875, I, p. 117.

³ Cf. the literature quoted, and also G. Lagerheim, *Ber. d. Bot. Ges.*, 1888, p. 73; Oltmanns, *Jahrb. f. wiss. Bot.*, 1891, Bd. XXIII, p. 358; Noll, *Flora*, 1892, p. 288; Goebel, *Pflanzenbiol. Schilderungen*, 1893, II, p. 246; Kerner, *Bot. Ztg.*, 1873, p. 437.

The alga of red snow (*Sphaerella nivalis*) also grows at a low temperature, but it is not certain whether, like the Arctic algae, it can grow actively when the temperature is permanently maintained at or below 0° C. Such plants as *Helleborus niger*, *Crocus*, *Tussilago Farfara*, and *Soldanella* grow and flower in winter or spring, and in *Ficaria ranunculoides* the aerial organs die down in summer after a period of active vegetation in spring just as they do in *Hydrurus*.

The temperature does not always lie within the limits for growth, and in all such cases the plant, if not in itself sufficiently resistant, must perennate over the unfavourable period by means of special vegetative organs, by seeds, or by spores. Almost all the flowering plants of temperate regions perennate in some form or other through at least one period of the year, and such plants as *Ulothrix* and *Hydrurus*, whose vegetative parts are killed by a temperature of $20-24^{\circ}$ C., perennate during summer in the form of spores.

Organisms which grow under extremes of temperature are subject to very little competition, and hence we should expect that all readily disseminated organisms capable of withstanding temperatures over 50° C. would ultimately find their way to a hot spring. The fact that each thermophile organism has its own temperature-limit shows that the power of adaptability is not in all cases the same, and that this power is not capable of indefinite extension under the action of regularly recurring conditions of heat or cold. It is, however, not impossible that organisms may be able to exist or grow at temperatures approaching 100° C., although development could hardly occur if the organism were completely frozen. The latter, however, only takes place in small organisms at temperatures several degrees below 0° C.

The cardinal points can never be determined with more than approximate accuracy, since their position is influenced by the external conditions, by the duration of the exposure, by the age of the plant, and by its previous treatment. Growth may in fact continue for a time at temperatures which ultimately bring about its cessation or even the death of the plant. Hence growth can never be aroused at such temperatures, although at more equable ones the growth of a partially injured plant may slowly be resumed again¹.

The influence of the external conditions on the cardinal points. Brefeld² observed that the sporophore of *Coprinus stercorearius* was formed in light at

¹ Kirchner, Cohn's Beitr. z. Biol., 1883, Bd. III, p. 362; Askenasy, Ber. d. Bot. Ges., 1890, p. 75; Pfeffer, Druck- u. Arbeitsleistung, 1893, p. 354; True, Annals of Bot., 1895, Vol. IX, p. 387; Hilbrig, Ueber d. Einfluss supramaximaler Temperatur auf das Wachstum, Leipziger Dissertation, 1900.

² Brefeld, Bot. Unters. ü. Schimmelpilze, 1877, III, p. 93; Gräntz, Einfluss d. Lichtes a. d. Entwicklung einiger Pilze, Leipziger Dissertation, 1898, p. 29.

12° C., but in darkness at 15° C. Heald¹ found that the spores of ferns will germinate in darkness at 32° C., although at ordinary temperatures they only germinate in light. The character and quantity of food supplied is also of importance. Thus Thiele² found that 31° C. was the maximal temperature for the growth of *Penicillium glaucum* on sugar solution, but 35 to 36° C. when fed with formic acid or glycerine, whereas in the case of *Aspergillus* the highest maximum is reached on the most favourable nutrient material (sugar). Further, according to Rabinowitsch³, the minimum for facultatively anaerobic thermophile bacteria sinks to from 34 to 44° C. in the absence of oxygen, but rises to 50° C. in its presence.

Gradual accommodation may also cause a certain displacement of the cardinal points. Thus Dieudonné⁴ was able to reduce the minimum for *Bacillus anthracis* from 12 or 14° C. to 10° C. Similarly, by gradually increasing the temperature of successive cultures, the same author raised the maximum of *Bacillus fluorescens* from 35 to 41.5° C., and that of the bacillus of red milk from 37 to 41.5° C., while Tsilinsky⁵ succeeded in raising the maximum for *Bacillus subtilis* from 50 to 58° C. in the course of thirty generations. The previous cultural conditions seem also to exercise some influence upon the cardinal temperatures for flowering plants. Thus the minimum for germination varies slightly in the case of seeds obtained from similar plants growing under different conditions⁶, and the period of development is shortened when the seeds of cereals grown in the North are planted in more Southern regions⁷.

The dissimilar cardinal points for different forms of growth. The minimal and maximal temperatures for growth seem to be further apart for vegetative growth than for the production of reproductive organs.

	Limits for vegetation.	For production of reproductive organs.
<i>Vaucheria repens</i> ⁸	0 to 30° C.	3 to 26° C. (zoospores).
<i>Anixiopsis stercorarius</i> ⁹	3 to 37° C.	8 to 34° C. (perithecia).
<i>Saccharomyces cerevisiae</i> ¹⁰	0 to 40° C.	11 to 37° C. (spores).

¹ Heald, Gametophytic Regeneration, Leipziger Dissertation, 1897, p. 62.

² Thiele, Temperaturgrenzen d. Schimmelpilze, Leipziger Dissertation, 1896, p. 36. Some forms of *Penicillium glaucum* seem to have a high maximum. On bacteria cf. Nägeli, Theorie d. Gährung, 1879, p. 91.

³ Rabinowitsch, Zeitschr. f. Hygiene u. Infection, 1895, Bd. XX, p. 159.

⁴ Dieudonné, Centralbl. f. Bact., 1894, Bd. XVI, p. 965; Biol. Centralbl., 1895, Bd. XV, p. 109; Flüge, Mikroorganismen, 1896, 3. Aufl., Bd. I, p. 483.

⁵ Tsilinsky, Ann. d. l'Institut Pasteur, 1899, T. XIII, p. 793.

⁶ Tietz, Ueber die Keimung einiger Coniferen u. Laubhölzer, 1874, p. 29; Haberlandt, Schutzeinricht. d. Keimpflanze, 1877, p. 38; N. J. C. Müller, Bot. Unters., 1879, Bd. II, p. 1.

⁷ Schiebeler, Bot. Centralbl., 1886, Bd. XXVIII, p. 205.

⁸ Klebs, Bedingungen d. Fortpflanzung, 1896, p. 40. On *Saprolegnia* see id., Jahrb. f. wiss. Bot., 1899, Bd. XXXIII, p. 552. On fungi in general cf. id., Jahrb. f. wiss. Bot., 1900.

⁹ Hansen, Bot. Ztg., 1897, p. 129, and Klebs, l. c., 1896, p. 488; l. c., 1900; Bachmann, Bot. Ztg., 1895, p. 130; F. Gräntz, Einfluss d. Lichtes auf die Entwicklung einiger Pilze, Leipzig, 1898, p. 53.

¹⁰ Hansen, Meddelelser fra Carlsberg Laboratoriet, 1888, Bd. II, p. 32 of abstract. For a general summary see Jörgensen, Mikroorganismen d. Gährungsindustrie, 1898, 4. Aufl., pp. 180,

The same applies to *Bacillus anthracis*, *B. tumescens*, and *B. subtilis*¹. Similarly, many of the higher plants are unable to flower at low temperatures at which vegetative growth continues, or at high ones which cause it to increase in activity².

In some cases germination may be possible at temperatures which do not permit further growth³, whereas in other cases the stimulus of a high (or low) temperature may be necessary to start the germination of plants which are subsequently able to develop at a more equable one. This may apply to *Pilobolus torridus*, whose spores only germinate at from 30 to 35° C.⁴ Moreover, the germination of certain seeds, such as cucumbers, is accelerated by previous warming.

Formative changes. These are very pronounced when we are dealing with the formation or suppression of perennating parts or reproductive organs. Apart from this, the general shape of the plant may be influenced by the temperature, though usually not to any great extent. Thus, green plants grown at low temperatures are usually more compact⁵, and in the case of fungi and bacteria peculiar growth-forms may be produced at abnormal temperatures⁶.

A change of temperature is usually rapidly followed by a corresponding alteration in the activity of growth⁷. A certain transient disturbing influence is probably also exercised, although this is usually not sufficiently pronounced to perceptibly affect growth. In the case of the thermonastic movements of leaves and flowers, a change of temperature produces a transient acceleration of growth⁸. Again, a change from a low to a more

208. On the conditions for spore-formation cf. Beyerinck, *Centralbl. f. Bact. u. Parasit.*, 1898, 2. Abth., Bd. IV, p. 662.

¹ O. Schreiber, *Centralbl. f. Bact.*, 1896, Bd. XX, p. 431. There, and also by Flügge, *Mikroorganismen*, 1896, 3. Aufl., Bd. I, p. 432, additional literature is quoted.

² Möbius, *Beitr. z. Lehre v. d. Fortpflanzung d. Gewächse*, 1897, p. 108, and the literature there given; Schimper, *Pflanzengeographie*, 1898, p. 51.

³ Sachs, *Jahrb. f. wiss. Bot.*, 1860, Bd. II, p. 336 (seeds); Wiesner, *Sitzungsber. d. Wiener Akad.*, 1873, Bd. LXVII, 1. Abth., p. 9 (*Penicillium*).

⁴ Brefeld, *Bot. Unters. ii. Schimmelpilze*, 1881, Heft 4, pp. 20, 71.

⁵ Kerner, *Pflanzenleben*, 1887, Bd. I, p. 408; Bd. II, p. 497; Schimper, *Pflanzengeographie*, 1898, p. 40. On seedlings cf. Sachs, *Jahresb. d. Agriculturchem.*, 1859-60, p. 98; Bialoblocki, *Versuchsstat.*, 1870, Bd. XIII, p. 441. On the length of the growing zone in roots cf. Popovici, *Bot. Centralbl.*, 1900, Bd. LXXXI, p. 91. On the influence of the temperature on the seasonal variations of butterflies cf. O. Hertwig, *Zellen u. Gewebe*, 1898, p. 120; Standfuss, *Biol. Centralbl.*, 1899, Bd. XIX, p. 75.

⁶ On acetic bacteria cf. Hansen, *Meddelelser fra Carlsberg Laboratoriet*, 1894, Bd. III, Ref., p. 198; Lafar, *Techn. Mykologie*, 1897, Bd. I, p. 347. [Vöchting (*Bot. Ztg.*, 1902, p. 88) finds that 'Marjolin' potatoes form vegetative shoots only above 20° C., while at very low temperatures, and also when the supply of water is deficient, they produce tubers only.]

⁷ Pedersen, *Arb. d. Bot. Inst. z. Würzburg*, 1874, Bd. I, p. 563; Askenasy, *Ber. d. Bot. Ges.*, 1890, p. 75; Godlewski, *Anzeig. d. Akad. d. Wiss. in Krakau*, 1890, p. 171; True, *Annals of Botany*, 1895, Vol. IX, p. 390. Köppen (*Wärme und Pflanzenwachsthum*, 1870; *Bot. Jahresb.*, 1875, p. 778) incorrectly supposed that a transitory retardation of growth ensued.

⁸ The stimulating effect of a rise of temperature may differ from that produced by a corresponding fall. According to Kinzel (*Versuchsstat.*, 1900, Bd. LIV, p. 134) the germination of various seeds is favoured by changes of temperature.

equable temperature appears to act as a stimulus upon *Vaucheria* and *Oedogonium*, inducing a formation of swarm-spores¹. A frequent repetition of such changes of temperature very possibly may shorten the normal resting periods. Here, and in other cases also, it is less the stimulating action of the mere change, than the direct action of the new temperature which is of importance. It is not quite certain whether the disturbance of growth observed by Schreiber², when spores of *Bacillus anthracis* which had germinated at 38° C. were brought to 18° C., was due to the direct action of the lower temperature, or to the stimulating action of the change.

In nature plants are subjected to sudden as well as to gradual changes of temperature, so that the existence of a power of rapid accommodation is of great importance. This does not, however, exclude the possibility of a special power of reaction to changes of temperature being developed for particular purposes. The rate of growth of each organ is proportional to its temperature, and the general vital activity is not disturbed by the temporary adaptation of the various parts to slightly different temperatures³. If, however, certain organs are kept permanently at injurious extremes of temperature, the other organs are also ultimately affected owing to the interdependence of the various parts.

It is not known why growth should decrease beyond a certain temperature, although respiration continues to increase and molecular movements in general become more rapid. The temperature curve of growth is, moreover, by no means always the same, and it is even possible that two maxima may be shown. So far as is known, the curve at first ascends slowly from the minimum, but then more rapidly. As it approaches the optimum it again ascends more slowly, and beyond the optimum it falls slowly or rapidly according to the nearness or remoteness of the maximum from the optimum.

History. After Lefebvre⁴ had determined the maximum and minimum for the germination of *Raphanus*, these extremes and also the optimum were determined for a variety of seedlings by de Candolle⁵, as well as by Edwards and Colin⁶. The whole subject was then closely investigated by Sachs⁷, and many authors have subsequently carried out researches upon seedlings, as well as with lower organisms.

Methods. The cardinal points can only be approximately determined, and

¹ Klebs, Bedingungen d. Fortpflanzung, 1896, pp. 49, 269. No such effect was observed in *Hydrurus*.

² Schreiber, Centralbl. f. Bact., 1896, Bd. xx, p. 372.

³ Godlewski, Anzeig. d. Akad. d. Wiss. z. Krakau, 1890, p. 172.

⁴ Lefebvre, Expér. s. l. germination, 1801, p. 124.

⁵ De Candolle, Pflanzenphysiologie, 1835, Bd. II.

⁶ Edwards and Colin, Ann. d. sci. nat., 1834, 2^e sér., T. I, p. 270; 1836, 2^e sér., T. v, p. 7.

⁷ Sachs, Jahrb. f. wiss. Bot., 1860, Bd. II, p. 338.

the discordant results of different authors are partly the result of the different methods employed. Thus in some cases the temperatures observed were those at which germination commenced (Sachs), and in others they were those at which pre-existent growth ceased (de Vries, Kirchner, &c.). When all the different phases of growth are to be investigated, the best results will be obtained with rapidly developing organisms. In many cases, however, sufficient precautions have not been taken to maintain constant temperatures. These can easily be assured in the hot chambers used for the culture of bacteria¹. In the case of plants requiring light, it is best to place these in bell-jars sunk under water in a large aquarium kept at constant temperature. A steady stream of dry air must be drawn through the bell-jar, and must be warmed to the same temperature by passing it through a coiled tube immersed in the water of the aquarium². A simpler arrangement (Fig. 17) suffices to keep the temperature constant to 1° C. in diffuse daylight.

To obtain low temperatures, cellars, ice-chests, water cooled by ice, &c., may be used³, but no good automatic arrangement has as yet been devised⁴. Many hot stages and chambers of greater or less accuracy have been constructed for microscopical observations⁵. In Pfeffer's hot stage, the hot chamber is surrounded by water at constant temperature, and considerable accuracy is ensured⁶.

The following is the chief literature concerned with the determination of the cardinal points of the higher plants:

Sachs, 1860, l. c.; Köppen, *Wärme u. Pflanzenwachstum*, 1870; de Vries, *Matériaux p. l. connaissance de l'influence d. l. température*, 1870 (repr. from

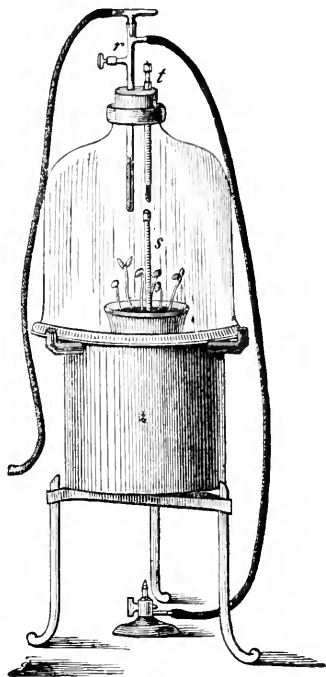

FIG. 17. Apparatus for constant temperature. Between the double walls of the zinc vessel *z* is water kept at constant temperature by the regulator *r* *t* and *s* are thermometers.

¹ Figures are given in most price-lists. Cf. also Pfeffer, *Zeitschr. f. wiss. Mikr.*, 1890, Bd. VII, p. 443, and in *Ber. d. Bot. Ges.*, 1895, p. 49, Pfeffer describes the arrangement for a warm room at constant temperatures.

² An arrangement suitable for special purposes was used by Jost, *Bot. Ztg.*, 1897, p. 25.

³ Uloth (*Flora*, 1871, p. 185; 1875, p. 266) observed that the radicles of certain plants grew on ice, and were able to penetrate it owing to the 'plasticity' of the ice under the pressures exerted by the root-apex.

⁴ Cf. Oltmanns, *Jahrb. f. wiss. Bot.*, 1892, Bd. XXIII, p. 362.

⁵ See Zimmermann, *Das Mikroskop*, 1895, p. 224; Behrens, *Zeitschr. f. wiss. Mikr.*, 1895, Bd. XII, p. 2; R. Kraus, *Centralbl. f. Bact.*, 1898, I. Abth., Bd. XXIII, p. 16.

⁶ Pfeffer, *Zeitschr. f. wiss. Mikr.*, 1890, Bd. VII, p. 433. A slightly improved form is figured by Ewart, *Protoplasmic Streaming*, Clar. Press, 1903, p. 60, Fig. 9.

Archiv. Néerlandaises, 1870, T. v); Haberlandt, Versuchsst., 1874, Bd. xvii, p. 113, and *Wiss. pract. Unters. a. d. Gebiete des Pflanzenbaues*, 1875, I, p. 109; Tietz, *Keimung einiger Coniferen u. Laubhölzer*, 1874; Just, *Cohn's Beitr. z. Biolog.*, 1877, Bd. II, p. 324; N. J. C. Müller, *Bot. Unters.*, 1879, Bd. II, p. 1; Kirchner, *Cohn's Beitr. z. Biolog.*, 1883, III, p. 339; Askenasy, *Ber. d. Bot. Ges.*, 1890, p. 61. Tabulated summaries are given by Nobbe, *Samenkunde*, 1876, p. 231; Detmer, *Vergl. Physiol. d. Keimungsprocesses*, 1880, p. 425.

ALGAE. Oltmanns, *Jahrb. f. wiss. Bot.*, 1891, Bd. xxiii, p. 358; Klebs, *Bedingungen d. Fortpflanzung*, 1896, and the literature there quoted.

FUNGI. Literature is given by de Bary, *Pilze*, 1884, pp. 375, 379; Zopf, *Pilze*, 1890, p. 201. Also Cohn, *Ber. d. schles. Ges. f. vaterl. Cultur*, 1888, p. 150; Schostakowitsch, *Flora, Erg.-bd.*, 1895, p. 369; Thiele, *Temperaturgrenzen d. Schimmelpilzes*, 1896; Klebs, *Bedingungen d. Fortpflanzung*, 1896, p. 446 seq.; *Jahrb. f. wiss. Bot.*, 1899, Bd. xxxiii, p. 549; 1900, Bd. xxxv, p. 80.

SACCHAROMYCES. Pedersen, *Rech. s. l. propagation d. l. levure*, 1878; Hansen, *Meddelelser f. Carlsberg Lab.*, 1888, T. II, French abstract, p. 114. Summaries by Jörgensen, *Mikroorganismen d. Gährungsindustrie*, 1898; Ad. Mayer, *Gährungschemie*, 1895, 4. Aufl., p. 150.

BACTERIA. Literature is given by Flügge, *Mikroorganismen*, 1896, 3. Aufl., I, p. 132; Migula, *System d. Bact.*, 1897, I, p. 358; Lafar, *Techn. Mykologie*, 1897, I, p. 70. On thermophile bacteria: Rabinowitsch, *Zeitsch. f. Hygiene u. Infectionskr.*, 1895, Bd. xx, p. 154; Kedzior, *Centralbl. f. Bact.*, 1897, 2. Abth., Bd. III, p. 154; Miyoshi, *Journal of the College of Science, Tokyo*, 1897, Vol. x, p. 143; Laxa, *Centralbl. f. Bact.*, 1898, 2. Abth., Bd. iv, p. 362; Tsilinsky, *Ann. d. l'Institut Pasteur*, 1899, T. XIII, pp. 500, 788; Sames, *Centralbl. f. Bact.*, 1. Abth., 1900, Bd. xxviii, p. 444; Michaelis, *Centralbl. f. Bact.*, 2. Abth., 1900, Bd. vi, p. 231.

PART III

THE INFLUENCE OF LIGHT

SECTION 23. General.

MANY bacteria and fungi are able to live and grow in complete darkness, but exposure to light forms one of the essential conditions for the complete development of all green plants which obtain their organic food by photosynthesis. Hence such plants grow slowly or not at all in the shade of dense woods, or beneath a certain depth of water. In addition to its importance as a source of energy, the shape and growth of particular organs, or of the entire plant, are influenced by light, as is instanced by the abnormal shapes of seedlings grown in darkness, as well as by the non-formation of chlorophyll. This influence of light is not confined to green

plants, for in darkness certain fungi either cease to form particular organs, or these assume abnormal shapes.

Exposure to light is not a general condition for growth, and hence even in chlorophyllous plants certain organs may be withdrawn from it. Thus subterranean roots mostly grow in complete darkness, and little or no light reaches the inner living tissues of thick or corky aerial organs. As might be expected, the formative changes produced by light are most pronounced in the case of those organs which utilize it as a source of energy, but all organs which normally carry out their functions above the substratum may exhibit a power of photomorphic response. It is in accordance with the special character and distribution of the light-stimulus that it should be a most important directive and formative agency, and that it should on the whole induce more pronounced growth-reactions than the more generally distributed factor of temperature.

In darkness a plant continues to grow normally so long as it remains in a condition of phototonus, i. e. so long as the influence of the previous exposure persists. This period is frequently very prolonged, so that exposure to darkness exercises no such direct retarding influence upon growth as does a low temperature. If the plant is kept for a sufficient length of time in darkness for its phototonus to be lost, it either falls into a condition of dark-rigor and ceases to grow, or its growth becomes abnormal in character. This may take place even when an ample supply of food is assured, but in green plants the effect produced may be increased as the result of starvation. As a general rule, however, growth appears to be somewhat quickened in darkness, and retarded by exposure to light, so long as the exposures are not too prolonged, and the plant or organ is well nourished and is in a growing condition.

The direct and indirect influences exerted by light and by different light-rays need to be distinguished as far as possible from one another. We are at present concerned more especially with the stimulatory action of light, and shall only incidentally discuss results due to the production or non-production of organic food. Insolation always produces a rise of temperature, and usually also increases the activity of transpiration, but these subjects have already been dealt with. The curvatures due to heliotropism will form the subject of a later chapter¹.

SECTION 24. Photomorphic Actions.

The shapes of certain plants are little or not at all affected by the presence or absence of light, while in other cases pronounced differences

¹ For the influence of light on the distribution of plants see Schimper, *Pflanzengeographie*, 1898, p. 61; and on that of algae cf. Berthold, Report of the Naples Zool. Station, 1882, Vol. III, p. 393; Oltmanns, *Jahrb. f. wiss. Bot.*, 1891, Bd. XXIII, p. 416.

are shown. The growth of certain organs is favoured by exposure to light, and that of others retarded, while in some cases, though not in all, the stimulus of light is necessary for the formation of particular organs. A few instances of the more important of these light-reactions must suffice.

Etiolation. In addition to the non-formation of chlorophyll, plants grown in darkness usually have longer internodes and smaller leaves¹.

All plants do not, however, react in the same way, and thus the elongated leaves of Liliaceae become longer and narrower in darkness², while the etiolated leaves of *Beta vulgaris* attain a comparatively large size. The elongation of certain leaves in darkness is, in certain cases, of importance in hastening the escape of the leaf from the leaf-sheath, or from the layers of soil which surround it and cut off the light from it. The elongation of the internodes in darkness is of similar importance in bringing the leaves to light and air, especially when bulbs, tubers, or seeds are buried deeply in the soil. There is, further, an obvious economy in reducing as far as possible the size of the

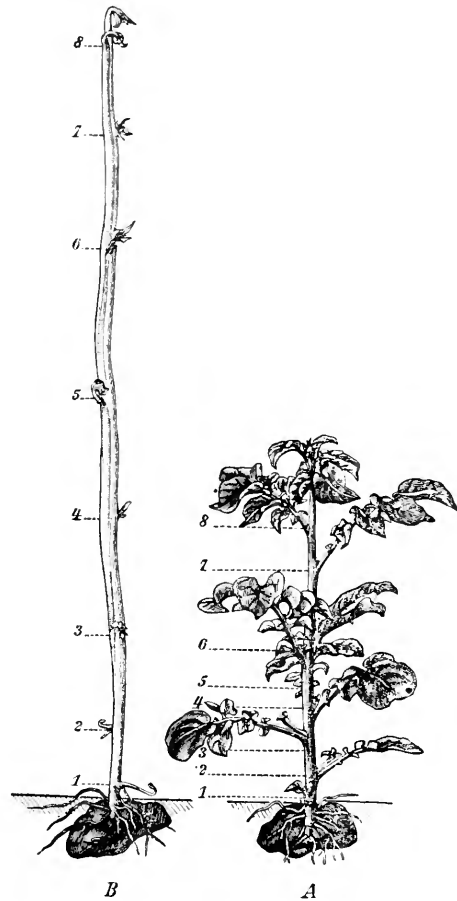

FIG. 18. Potato plants grown from tubers. *A* in light, *B* in darkness. The corresponding internodes are numbered from below upwards.

etiolated leaves, if these can only perform their natural functions when exposed to light.

The hypocotyls of seedlings whose cotyledons do not come above

¹ Sachs, Bot. Ztg., 1863, Beilage; Kraus, Jahrb. f. wiss. Bot., 1869-70, Bd. VII, p. 209; Wiesner, Sitzungsab. d. Wien. Akad., 1893, Bd. CII, I, p. 319; Ber. d. Bot. Ges., 1891, p. 46; Rauwenhoff, Ann. d. sci. nat., 1878, 6^e sér., T. V, p. 311; Kraus, Ueber einige Beziehungen des Lichtes zur Stoff- u. Formbildung, 1878 (Forsch. a. d. Geb. d. Agric.-physik, Bd. II); Godlewsky, Biol. Centralbl., 1889, Bd. IX, p. 481; Ricôme, Compt. rend., 1900, T. XXXI, p. 1251. The leaves of certain conifers turn green in darkness, but others do not. Cf. Wiesner, l. c., 1893, p. 344; Jost, Jahrb. f. wiss. Bot., 1897, Bd. XXVII, p. 442.

² For exceptions, see Walz, Bot. Jahresb., 1875, p. 787; Wiesner, l. c., 1893, p. 319.

ground, undergo little or no increased elongation in darkness (*Pisum*, *Aesculus*, *Tropaeolum*), and the same applies to hop stems, to the spring shoots of *Dioscorea Batatas*, and to the lower internodes on the stems of *Bryonia dioica* (Sachs, Wiesner, l.c.). The absence of light produces, however, pronounced changes in flattened chlorophyllous stems, and in *Phyllocactus* and *Opuntia* this may go so far as to lead to the production in darkness of stems with a more or less radial structure¹. The same thing happens in the assimilating aerial roots of certain orchids, which are flattened when grown in light², while the green aerial roots of *Taenio-phyllum Zollingeri* only grow when exposed to light³. On the other hand, subterranean and aquatic roots acquire similar shapes in darkness and in light⁴.

Very weak continuous or intermittent illumination distinctly influences the shape of an etiolated plant, and direct experiments, as well as compara-

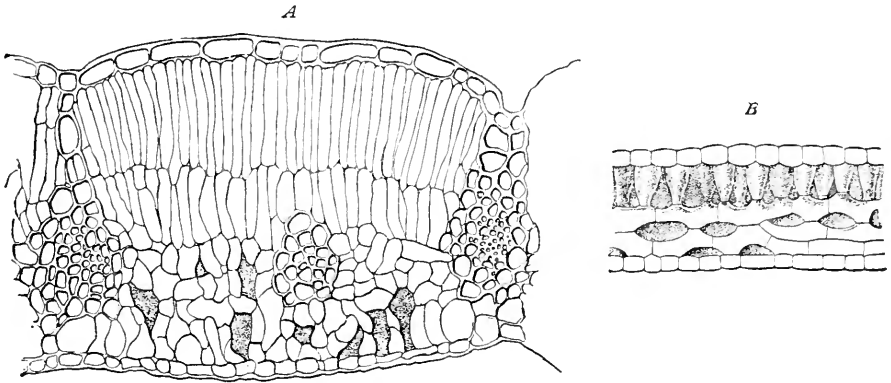

FIG. 19. Transverse sections of leaves of *Fagus sylvatica*. *A* exposed to sunlight, *B* from a shaded locality. (After Stahl.)

tive observations upon the same plant grown in sunny and in shady localities⁵, suffice to show that the internodes become shorter and the plant more condensed as the intensity of the light increases, while the leaves attain their maximal size at a certain medium intensity of illumination⁶. This latter is owing to the fact that moderate light stimulates the growth of the leaves, whereas intense light retards it.

¹ Vöchting, Jahrb. f. wiss. Bot., 1894, Bd. xxvi, p. 465; Goebel, Flora, 1895, p. 96; Organography, 1900, I, p. 247. The etiolated shoot usually grows longer in darkness, although the individual internodes are in part smaller than those formed in light.

² Janczewski, Ann. d. sci. nat., 1885, 7^e sér., T. II, p. 55; Goebel, Organography, p. 246 seq.

³ Wiesner, Sitzungsber. d. Wien. Akad., 1897, Bd. cvI, I, p. 97.

⁴ Nobbe, Versuchszt., 1867, Bd. ix, p. 80; Famintzin, Bot. Ztg., 1873, p. 366; Strehl, Unters. ii. d. Längenwachsthum, 1874, p. 24; Walz, Bot. Jahresb., 1875, p. 787; Godlewski, Bot. Ztg., 1879, p. 91; Teodoresco, Ann. d. sci. nat., 1899, 8^e sér., T. x, p. 211.

⁵ Other factors (transpiration, &c.) also enter into play.

⁶ Sachs, Experimentalphysiol., 1863, p. 33; Bot. Ztg., 1871, p. 681; Stahl, Ueber d. Einfluss

Nevertheless, the leaves which have the greatest surface have not always the greatest thickness and weight, nor does their tissue-differentiation and power of photosynthesis by any means always reach the maximum possible¹.

The influence of light in favouring the development of palisade parenchyma is a factor of great biological utility, and in plants growing in deep shade this layer may be developed feebly or not at all² (Fig. 19). Again, in the absence of light the thickening of the cell-walls is less pronounced, and hence etiolated shoots and leaves are less rigid than normal³. The laying of cereals is in fact usually due to the basal portions of the haulm being so much shaded by close planting that they become etiolated, and do not acquire sufficient strength to support the ripened ears. Owing to the lessened rigidity of the cell-walls, the tissue-strains are less pronounced in etiolated stems than in those exposed to light, and indeed they may, in some cases, be so altered by the relatively more active growth of the cortex, that the latter instead of being stretched is compressed longitudinally⁴.

Etiolation was recognized by Ray, and later by Bonnet, as being due to the absence or deficiency of light⁵. Senebier and de Candolle pointed out that specific differences exist in this respect between different plants, and between the different parts of the same plant⁶. Our knowledge was further extended by Sachs, G. Kraus, and subsequent authors. Senebier observed that

des sonnigen u. schattigen Standorts, &c., 1883, p. 29; Dufour, Ann. d. sci. nat., 1887, 8^e sér., T. v, p. 407; Wiesner, Sitzungsber. d. Wien. Akad., 1893, Bd. CII, I, p. 321; Teodoresco, Rev. gén. d. Bot., 1899, T. XI, p. 433. The stages in the sizes of the leaves are well shown by ivy plants growing in the clefts of rocks.

¹ Géneau de Lamarlière, Rev. gén. d. Bot., 1892, T. IV, p. 481.

² Haberlandt, Physiol. Anat., 1896, 2. Aufl., pp. 253, 260; Teodoresco, Ann. d. sci. nat., 1899, 8^e sér., T. x, p. 433, and Rev. gén., l. c. If the light is too intense the differentiation of the tissues is again decreased (Bonnier, Rev. gén. d. Bot., 1895, T. VII, p. 412). On *Marchantia* cf. Kammerling, Flora, 1897, Erg.-bd., p. 53. On subterranean leaves cf. Thomas, Rev. gén. d. Bot., 1900, T. XII, p. 394.

³ Kraus, Jahrb. f. wiss. Bot., 1869-70, Bd. VII, p. 209; Batalin, Bull. d. l'Acad. de St.-Pétersbourg, 1871, T. xv, p. 21; Rauwenhoff, Ann. d. sci. nat., 1878, 6^e sér., T. v, p. 267. The cells in elongated etiolated stems are usually somewhat longer than in normal internodes, but are smaller than usual in the small leaves formed in darkness (G. Kraus, l. c., pp. 234, 259; Rauwenhoff, l. c., pp. 285, 310; Batalin, Bot. Ztg., 1871, p. 676; Prantl, Arbeit. d. Würzburger Instituts, 1873, Bd. I, p. 384). Hales (Statics, 1748, p. 188) was the first to observe the greater softness of etiolated plants, while Knight (Phil. Trans., 1801, II, p. 348) showed that roots freed from the soil form firmer wood. Cf. also Wiesner, Bot. Ztg., 1884, p. 675. On the influence of etiolation on hairs cf. Schober, Bot. Centralbl., 1886, Bd. XXVIII, p. 39; on cystoliths, Kohl, Kalksalze u. Kieselsäure i. d. Pflanze, 1889, p. 139.

⁴ Sachs, Bot. Ztg., 1863, Beilage, p. 13; Kraus, l. c., pp. 240, 250. Cf. also Rauwenhoff, l. c., p. 295.

⁵ Ray, Historia plantarum, 1686, Vol. 1, p. 15; Bonnet, Recherches sur les feuilles, 1762, 122-89.

⁶ Senebier, Phys.-chem. Abhandl., 1785, 2. Thl., pp. 52, 103, 110; de Candolle, Physiologie végétale, 1832, Bd. III, p. 1078. De Candolle erroneously supposed that only green parts can become etiolated.

when a shoot is led into a dark chamber, only the part in darkness is etiolated, and if the distal extremity grows into light again, it assumes the normal shape. Under such circumstances starvation is avoided, and hence the leaves on the darkened portion of the stem are usually larger than those formed on plants kept in total darkness¹. On the other hand, the action of light in favouring the development of the illuminated parts may, by correlation, retard the growth of the darkened portions, and in fact Jost² obtained non-green leaves of normal size and shape on darkened shoots of *Mimosa pudica* and *Phaseolus multiflorus* by continually removing the buds formed on the parts exposed to light. Jost³ also observed that the buds on an attached branch of the beech did not develop in darkness, but did so when the branch was isolated. Similarly, Godlewski⁴ found that an increased activity of growth in the hypocotyls of seedlings of *Raphanus sativus* retarded the growth of the cotyledons, and vice versa. Since such correlating actions always enter into play, it is not possible to say whether the greater production of runners in *Glechoma hederacea*, and of climbing shoots in *Ampelopsis hederacea*⁵, in weak light, is due to the direct action of the weak illumination upon these organs, or to the retardation of the growth of the main shoot. It is also a phenomenon of correlation when the removal of the foliage causes the primordia of bud-scales to develop into foliage leaves. The scales on the rhizomes of *Adoxa*, *Paris*, &c., are, however, unable to develop into green leaves when the primordia are exposed to light, whereas on the stolons of *Hieracium*⁶ and *Circaea*⁷ the primordia develop into foliage leaves when illuminated, and into scale-leaves in darkness.

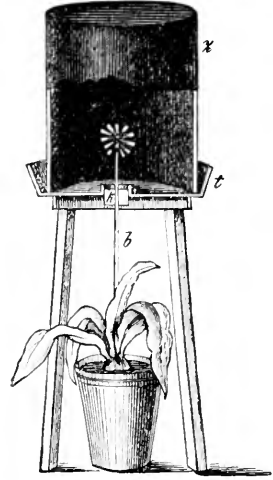

FIG. 23. Apparatus for partial etiolation. The apex of the flowering shoot *a* is passed through the opening *k* in the clay saucer *l*, which is closed by cork and cotton-wool. The dark cylinder *z* is pressed into the sand covering the floor of *l*.

In the case of fungi, and other heterotrophic plants, the etiolation effects produced by the absence of light are not complicated by any direct influence upon nutrition. Even in the case of autotrophic plants the etiolation effects are mainly the result of the absence of the stimulating action of light. Certain fungi, algae, and mosses are in fact unable, in the absence of light, to progress beyond a certain embryonic stage, and are unable to produce reproductive organs.

¹ Sachs, Vorlesungen, 1887, 2. Aufl., p. 541; Amelung, Flora, 1894, p. 204; Teodoresco, Rev. gén. d. Bot., 1889, T. XI, p. 369.

² Jost, Jahrb. f. wiss. Bot., 1897, Bd. XXVII, p. 478; 1898, Bd. XXXI, p. 377.

³ Id., Ber. d. Bot. Ges., 1894, p. 194.

⁴ Godlewski, Bot. Ztg., 1879, p. 105.

⁵ Maige, Compt. rend., 1898, T. CXXVII, p. 420.

⁶ Nägeli, Sitzungsber. d. Münch. Akad., 1866, II, p. 209.

⁷ Goebel, Bot. Ztg., 1880, p. 794; Organography, 1900, I, p. 256.

Fungi. *Coprinus nyctemerus* only produces a mycelium in darkness, whereas *C. stercorarius*, *C. plicatilis*, and *C. ephemerus* form sporocarps with or without a complete pileus. Above 15° C., however, *C. stercorarius* is able to form a complete pileus on fruits formed from the mycelium or from sclerotia¹. In this and other species of *Coprinus* the stipe elongates considerably in darkness, whether the pileus is formed or not, but in *Coprinus ephemerus* only a minimal elongation occurs.

Similarly, the formation of sporangia is suppressed in *Pilobolus microsporus* by darkness, but not in other species of this genus nor in many other Mucorineae². Even here light may act favourably, for, according to A. Lendner³, on certain nutrient media *Mucor flavidus* only produces sporangia when illuminated. Under similar conditions sporangia are formed by *Mucor racemosus* in darkness, but the spores differentiate only when exposed to light. As before, the sporophore of many but not of all Mucorineae becomes longer in darkness, even when the sporangium is formed. This over-elongation is, however, but slight in *Pilobolus microsporus*, if a formation of sporangia has been induced by previous illumination, so that the power of apical growth has been lost. In the absence of sporangia, however, the apical growth continues, and *Pilobolus* produces extremely long sporophores in continuous darkness. A comparatively short exposure to light, however, suffices to induce the production of sporangia in *Pilobolus microsporus* ($\frac{1}{4}$ to 5 hours), or the full development of the pileus in *Coprinus* (3 to 20 hours, Gräntz, l. c., pp. 38, 49).

Similar peculiarities are exhibited by other fungi⁴. Thus in many Hymenomyces light is necessary for the production or growth of the sporophore, whereas those of *Agaricus campestris* develop normally in darkness. *Sphaerobolus stellatus* again is sterile in darkness (Brefeld), whereas light is not essential to the common mould-fungi (*Penicillium glaucum*, *Aspergillus niger*, *Mucor stolonifer*, &c.), and indeed Elfving (l. c., p. 50) found that light of moderate intensity produces a slightly lessened increase of dry weight. Klein⁵ observed that the formation of conidia was retarded by light, which probably indicates that the optimal intensity of light is very low for this function.

*Algae and Bryophyta*⁶. *Batrachospermum* grows actively in weak light,

¹ Brefeld, Unters. a. d. Gesamtgeb. d. Mykologie, 1889, Heft 8, p. 275; 1877, Heft 3, pp. 87, 114; Bot. Ztg., 1877, p. 402; Gräntz, Einfluss d. Lichtes a. d. Entwicklung einiger Pilze, Leipziger Dissert., 1898, p. 20.

² Brefeld, Unters. a. d. Gesamtgeb. d. Mykologie, 1881, Heft 4, p. 76, and 1889, Heft 8, p. 275; Gräntz, l. c., p. 6.

³ Lendner, Ann. d. sci. nat., 1897, 8^e sér., T. III, p. 60.

⁴ Schulzer v. Müggenburg, Flora, 1878, p. 122; Schröter, Jahresb. d. Schles. Ges. f. vaterl. Cultur, 1884, p. 290; Hartig, Der ächte Hausschwamm, 1885, p. 18; Elfving, Einwirkung d. Lichtes auf Pilze, 1890; Bachmann, Bot. Ztg., 1895, p. 130; Klebs, Bedingungen d. Fortpflanzung, 1896, p. 475; Holtermann, Mykol. Unters. a. d. Tropen, 1898, pp. 92, 114. Cf. also Zopf, Pilze, 1890, p. 199; Goebel, Organography, 1900, I, p. 227; Klebs, Jahrb. f. wiss. Bot., 1900, Bd. XXXV, p. 140; Ternetz, *ibid.*, p. 309.

⁵ Klein, Bot. Ztg., 1885, p. 6.

⁶ Cf. Berthold, Jahrb. f. wiss. Bot., 1882, Bd. XIII, p. 672; Klemm, Flora, 1893, p. 469; Goebel, Organography, 1900, I, p. 227. On the etiology of a lichen (*Baconyces*) see Krabbe, Bot. Ztg., 1882, p. 93.

but does not pass beyond the embryonic stage described as *Chantransia*¹. Very feeble illumination suffices for the germination of moss spores and for the formation of protonemata, but not for the production of the gametophytic buds². Under similar conditions the germinating spores of liver-worts are often unable to form the embryonic thallus³. In such cases, of course, the formation of reproductive organs is suppressed, and, among algae, *Vaucheria repens* and *V. clavata* form zoospores in weak light, but sexual organs only under somewhat more intense illumination⁴. The same applies to *Oedogonium diplandrum*, and the conjugation of *Spirogyra* is favourably influenced by light⁵.

Flowering plants. In weak light many flowering plants are unable to pass through all the stages in their development. Thus, *Campanula rotundifolia* forms only round leaves when feebly illuminated, and, if the light is kept permanently reduced, the shoots bearing elongated leaves ultimately produce round ones⁶. Again, many plants produce few or no flowers in feeble light, although in others the flowers are able to develop and open in darkness⁷.

In all herbaceous plants with subterranean bulbous, tuberous, or rhizomic stems (*Helleborus*, *Ranunculus*, *Narcissus*), the first stages in the embryology of the flower are passed through in complete or nearly complete darkness, and hence Senebier's⁸ observation, that the flowers of *Crocus*, *Tulipa*, &c., are able to carry out their normal development in darkness, is hardly surprising. Sachs⁹ obtained normally shaped flowers on darkened aërial shoots of *Cucurbita*, *Ipomoea*, *Phaseolus*, and *Petunia*, the colour also being normal, except in those parts which become green in light (cf. Fig. 20, p. 89). In *Cucurbita* and *Tropaeolum* the flower-buds did not merely grow and expand in darkness, but were actually formed *ab initio* under these conditions. All plants, however, are not able to produce flowers on darkened shoots¹⁰, and in many cases the stimulus of light

¹ Sirodot, Les Batrachospermes, 1884; Goebel, Flora, 1889, p. 6; Klebs, Biol. Centralbl., 1893, p. 646. On other algae see Berthold, l. c., p. 673.

² Goebel, Klebs, l. c.; Schostakowitsch, Flora, 1894, p. 358.

³ Leitgeb, Die Keimung d. Lebermoossporen in ihrer Beziehung zum Licht, 1876, p. 3 (repr. from Sitzungsber. d. Wien. Akad.); Goebel, Klebs, Schostakowitsch, l. c.; Goebel, Organography, 1900, I, p. 239.

⁴ Klebs, Bedingungen d. Fortpflanzung, 1896, p. 19. The amount of light required varies somewhat according to the other conditions.

⁵ Klebs (l. c., pp. 246, 276) gives other instances. On the prothalli of ferns see Prantl, Bot. Ztg., 1879, p. 701; Klebs, Biol. Centralbl., 1893, Bd. XIII, p. 652; Heim, Flora, 1896, p. 329.

⁶ Goebel, Flora, 1896, p. 1; Organography, 1900, I, p. 214. Familler (Flora, 1900, p. 95) states that other disturbing influences may induce a production of round leaves in this plant.

⁷ Vöchting, Jahrb. f. wiss. Bot., 1893, Bd. xxv, p. 155; Ber. d. Bot. Ges., 1898, p. 47; Möbius, Biol. Centralbl., 1892, Bd. XII, p. 109; Beitr. z. Lehre v. d. Fortpflanzung, 1897, p. 93; Curtel, Ann. d. sci. nat., 1898, 8^e sér., T. VI, p. 269; Wiesner, Compt. rend., 1898, May 2.

⁸ Senebier, Physik.-chem. Abhandl., 1785, 2. Thl., p. 52. Cf. also de Candolle, Physiol. végét., 1832, T. III, p. 1081. The perianth-tube of *Crocus* becomes longer than usual in complete darkness, its function being to carry the flower up to the light (and air).

⁹ Sachs, Bot. Ztg., 1863, Beilage, p. 15; *ibid.*, 1865, p. 117; Arb. d. Würzb. Instituts, 1887, Bd. III, p. 387; Amelung, Flora, 1894, p. 207.

¹⁰ Vöchting, l. c., 1893, p. 177; Askenasy, Bot. Ztg., 1876, p. 1; Walz, Bot. Jahresb., 1875, p. 786. Cf. also Vol. I, § 88.

seems necessary for the production of flowers, entirely apart from its importance for photosynthesis. Many plants do not flower in weak light, and Vöchting (l. c., 1898, p. 47) was able to cultivate *Mimulus luteus* in weak light for seven years without it flowering.

General. It is evident that the formative action of light may be confined to the embryonic or post-embryonic development, or may affect both of these. The formation of the primordia appears usually to be independent of light, but in many Cryptogams and Phanerogams light is essential for the formation of reproductive organs. The buds which give rise to the aerial shoots of rhizomes develop independently of light, but the latter is essential if the subsequent growth of the shoot is to take place normally. On the other hand, even those fungus-spores which are only formed in light are able to germinate in darkness. Buds expand and seeds germinate in darkness or in light of insufficient intensity for continued development, whereas the spores of certain chlorophyllous Cryptogams only germinate when illuminated. The stimulus of light is also necessary to bring those leaves which remain small in darkness to their full development, and if the stimulus is sufficiently intense it may persist long enough to enable the rest of the development to be completed in darkness.

Light is necessary for the germination of the spores of ferns¹, and for that of the spores and gemmae of Bryophyta², whereas the spores of *Equisetum*, *Marsilia*, and *Pilularia* will germinate in darkness³. At 32° C., however, the spores of ferns will germinate in darkness⁴, as will also those of mosses, when placed in sugar solution⁵. Exposure to light is essential for the germination of the seeds of *Viscum album*, but not for those of tropical species and of *Loranthus europaeus*⁶. Illumination apparently favours the germination of many seeds, and the partly contradictory results of various authors are probably due to the unequal ripeness of the seeds and the dissimilar intensity of the light, and to variations

¹ Borodin, Bull. d. l'Acad. d. St.-Petersbourg, 1868, T. XIII, p. 432; Heald, Gametophytic Regeneration, Leipziger Dissert., 1897, p. 44. The other literature is quoted there. On the etiology of fern prothalli see Prantl, Bot. Ztg., 1879, p. 701.

Mosses, Borodin, l. c., p. 438; Heald, l. c. Hepaticae, Leitgeb, Die Keimung d. Lebermoossporen in ihrer Beziehung zum Licht, 1876, p. 3 (repr. from Sitzungsab. d. Wien. Akad., 1876, Bd. LXXIV, 1. Abth.). Gemmae, Borodin, l. c.; Pfeffer, Arbeit. d. Würzburg. Instituts, 1871, Bd. I, p. 80; Correns, Unters. über Vermehrung der Laubmoose, 1899, p. 424.

Sadebeck, Bot. Ztg., 1877, p. 44; Stahl, Ber. d. Bot. Ges., 1885, p. 334; Heald, l. c., p. 63. The spores of most fungi germinate equally well in darkness and in diffuse light. Cf. Hoffmann, Jahrb. f. wiss. Bot., 1860, Bd. II, p. 321, and the works of de Bary and Brefeld; also Zopf, Pilze, 1890, p. 199. According to de Bary (Ann. d. sci. nat., 1863, 4^e sér., T. XX, p. 37) the spores of *Peronospora macrospora* germinate best in darkness.

⁴ Heald, l. c., p. 62.

⁵ Goebel, Flora, 1896, p. 75; Heald, l. c., p. 54.

⁶ Wiesner, Ber. d. Bot. Ges., 1897, p. 512; Sitzungsab. d. Wien. Akad., 1894, Bd. CIII, 1. Abth., p. 401; 1893, Bd. CII, 1. Abth., p. 323. According to Raciborski (Extrait d. Bull. d. l'Inst. Botan. d. Buitenzorg, 1900, 6) the stimulus of light is necessary for the germination of the seeds of *Nicotiana*. [This does not apply to the seeds of *Nicotiana rustica* if properly sown, but the seedlings rapidly die in darkness.]

in the other external conditions¹. Trees form more foliage buds in light than in darkness, and in weak light this fact, together with the death of certain of the branches, causes the plant to assume a less compact character than when under stronger illumination².

Light of sufficient intensity retards growth, and in many cases growth is accelerated when the plant is removed from diffuse daylight to darkness. Darkness favours the formation of roots upon the shoots of Cactaceae, and upon the stems of etiolated plants³. Nevertheless, ordinary illumination does not suppress the formation of roots upon stems submerged in water and exposed to light, and in water-cultures exposure of the main root to light only slightly retards the development of lateral roots. Feeble illumination, however, suffices to inhibit the formation of tubers upon single subterranean shoots of the potato, but not if all of them are exposed to light⁴. Similarly, the growth of the buds on the potato is retarded by light, and other cases may be found in which darkness favours the development and growth of organs which are not normally exposed to light. The apical growth of the stem of *Phyllocactus* which has ceased in light recommences in darkness⁵, and fully grown but still young internodes of *Myriophyllum*, *Elodea*, and *Ceratophyllum* undergo further elongation by stretching-growth when placed in darkness⁶. On the other hand, the runners of *Adoxa* cease to grow in darkness, and instead form their tuberous bulbs⁷.

Unilateral illumination may induce various changes in the growth or production of organs on the illuminated or shaded sides. Thus roots are formed mainly or entirely on the shaded sides of stems of *Hedera helix*⁸ and *Lepismium radicans*⁹. Similarly, rhizoids appear mainly on the shaded side of a gemma of *Marchantia*¹⁰, and only on that surface in

¹ Heinricher, Ber. d. Bot. Ges., 1899, p. 308; Wiesner, Sitzungsber. d. Wien. Akad., 1894, Bd. CIII, 1. Abth., p. 427; Jönsson, Bot. Jahresb., 1893, Bd. 1, p. 39; Cieslar, Forsch. a. d. Gebiete d. Agriculturphysik, 1893, Bd. VI; Nobbe, Samenkunde, 1876, p. 239. [Most small seeds, such as those of many Solanaceae, Orchidaceae, Scrophulariaceae, and Gramineae, rapidly perish after germinating in darkness, partly owing to the small store of nutriment they contain. Careful control is needed to distinguish this effect from a true stimulating action of light.]

² Vöchting, Organbildung, 1884, II, p. 66; N. J. C. Müller, Bot. Unters., 1877, Bd. 1, p. 500; Hartig, Lehrb. d. Anat. u. Physiol., 1891, p. 256; Jost, Ber. d. Bot. Ges., 1894, p. 194; Wiesner, Sitzungsber. d. Wien. Akad., 1895, Bd. CIV, I, p. 669; Büsgen, Waldbäume, 1897, p. 22.

³ De Candolle, Ann. d. sci. nat., 1826, T. VII, p. 12; Physiologie, 1835, T. II, p. 341; Sachs, Bot. Ztg., 1863, Beilage, p. 1; Arb. d. Würzburg. Inst., 1880, Bd. II, p. 486; Vöchting, Organbildung im Pflanzenreich, 1878, pp. 148, 152. Darkness favours the development of rhizoids on *Chara* (Richter, Flora, 1894, p. 407), but does not cause them to appear on the upper nodes.

⁴ Vöchting, Bibl. Bot., 1887, Heft 4; Jahrb. f. wiss. Bot., 1899, Bd. XXXIV, p. 1. Other cases are also given.

⁵ Id., Jahrb. f. wiss. Bot., 1894, Bd. XXVI, pp. 450, 465.

⁶ Möbins, Biol. Centralbl., 1894, Bd. XV, p. 33.

⁷ Stahl, Ber. d. Bot. Ges., 1894, p. 389.

⁸ Sachs, Vorlesungen, 1887, 2. Aufl., p. 529. Czapek (Flora, 1898, p. 425) states that the hypocotyl behaves similarly.

⁹ Vöchting, Organbildung, 1878, I, p. 148.

¹⁰ Zimmermann, Arb. d. Bot. Inst. in Würzburg, 1882, Bd. II, p. 666; Pfeffer, Unters. a. d. Bot. Inst. zu Tübingen, 1885, Bd. 1, p. 530.

the case of fern prothalli. Furthermore, the buds on a shoot of *Salix* or *Populus* develop mainly on the illuminated side¹, while, according to Kny², the growth of coleochaete is most active on the exposed side. The chlorophyllous assimilating branches of *Caulerpa*³, and many other algae, develop mainly on the side exposed to light, whereas in *Polyporus*, and a few allied plants⁴, the spore-bearing hymenium develops on the shaded surface.

SECTION 25. The Reaction of a Phototonic Plant to Changes of Illumination.

Exposure to light does not form an essential general condition for growth, and beyond a certain varying intensity of illumination every plant is ultimately killed. This intensity is not reached in nature in the case of those plants which normally grow in full sunlight, whereas many shade-loving plants are killed by a shorter or longer exposure to the sun. The same applies to bacteria, certain species of which cease to grow in diffuse daylight. It is indeed possible that organisms may exist which are so sensitive to light, that they can only grow in complete darkness.

The above facts have been determined by researches upon the fatally injurious action of intense light⁵, but no exact experiments have been made upon the maximal and optimal intensities for growth. Wiesner⁶ observed a cessation of growth in various seedlings when exposed to light of only 1,300–5,000 candle-power, but this was probably the result of the heat radiated from the gas-flame, for no stoppage occurs in damp air or under water in the much more intense sunlight, and Oltmanns (l.c.) observed that seedlings continued to grow when they were exposed to electrical light of 500,000 candle-power.

Within certain limits, a decrease in the illumination produces an accelerated rate of growth in a phototonic plant, and an increase a diminished rate. This effect has been observed on lower and higher plants, on green and non-green plants, on positively and negatively

¹ Wiesner, Sitzungsab. d. Wien. Akad., 1895, Bd. CIV, I, p. 685.

² Kny, Ber. d. Bot. Ges., 1884, p. 93.

³ Noll, Arb. d. Bot. Inst. in Würzburg, 1888, Bd. III, p. 472; Klemm, Flora, 1893, p. 472. Cf. also Stahl, Jahrb. f. wiss. Bot., 1892, Bd. XXIII, p. 339; Berthold, Jahrb. f. wiss. Bot., 1882, Bd. XIII, p. 673.

⁴ Schulzer v. Muggenburg, Flora, 1878, p. 122; Sachs, Arb. d. Bot. Inst. in Würzburg, 1879, Bd. II, p. 252; Holtermann, Mykol. Unters. a. d. Tropen, 1898, p. 115.

⁵ As regards algae cf. Berthold, Jahrb. f. wiss. Bot., 1882, Bd. XIII, p. 569; Ewart, Annals of Botany, 1898, Vol. XII, p. 379; West, *ibid.*, p. 33. The literature on bacteria is given by Flüge, Mikroorganismen, 1896, 3. Aufl., Bd. I, p. 441, and by Migula, Syst. d. Bact., 1897, Bd. I, p. 361. On yeast cf. Lohmann, Einfluss intensiven Lichtes auf die Zelltheilung von *Saccharomyces*, Rostock, 1896, p. 71.

⁶ Wiesner, Ueber die heliotrop. Erscheinungen im Pflanzenreich, 1878, I, p. 37; 1880, II, p. 13. See the abstract by Oltmanns, Flora, 1897, p. 20.

geotropic organs, and also on organs in which the stimulus of light is necessary to awaken growth, that is, to produce the proper condition of phototonus¹. In the latter case, exposure to light at first causes an acceleration of growth, owing to the removal of the partial or complete dark-rigor. As the conjoint result of this phototonic action, and the retarding effect of intense light, it follows that the growth, and hence the resulting adult size of the leaf, are greatest at a certain optimal intensity of light, and diminish above and below it. If no phototonic action is necessary for growth, this will then, in general, be most active in darkness. Hence the excessive elongation of etiolated stems in darkness, which is partly aided by the longer duration of growth.

Growth, however, is in all cases the result of a variety of co-operating factors, which may at once, or after a time, be unequally affected by a change in the illumination. Hence the curve showing the dependence of growth upon assimilation need not in all cases be the same, and may in fact show secondary maxima and minima² when phototonic or photosynthetic (nutritive) effects come into play. Growth is, moreover, not the sole factor in vital activity, and hence, from a general biological standpoint, there is a certain optimum intensity of illumination for every plant requiring light, which in general is not that of intense sunlight, but of bright diffuse daylight, or, in the case of shade-loving plants, comparatively feeble diffuse light³. The optimal intensity of illumination for the interior of a cell, especially if chlorophyllous, will naturally be considerably lower, and does not necessarily coincide with the optimal intensity of external illumination⁴, of which only a fraction is ever actually utilized by the plant. The various adaptations and structural relationships of plants to light have been closely studied by Wiesner (l. c.).

So long as the plant remains in a condition of phototonus, its growth is much less affected by changes of illumination than by changes of temperature. Thus even the change from bright light to complete darkness, or vice versa, usually affects the rate of growth by from 5 to 30 per cent., and only rarely by as much as 50 per cent., while small changes of illumination produce no perceptible effect. A rise or fall of temperature almost immediately affects the rate of growth, whereas a pronounced change in the intensity of the illumination does not become perceptible,

¹ On leaves cf. Prantl, *Arb. d. Bot. Inst. in Würzburg*, 1873, Bd. I, p. 371; G. Kraus, *Jahrb. f. wiss. Bot.*, 1869-70, Bd. VII, p. 228.

² Wiesner (l. c., 1880, II, p. 15) obtained such curves, but possibly other factors besides the light-rays entered into play.

³ Wiesner, *Sitzungsbd. d. Wien. Akad.*, 1893, Bd. CII, p. 291; 1895, Bd. CIV, I, p. 605; 1900, Bd. CIX, I, p. 436; *Ber. d. Bot. Ges.*, 1894, p. 78; *Denksch. d. Wien. Akad.*, 1896, Bd. LXIV, p. 73; 1898, Bd. LXVII, p. 1; Schimper, *Pflanzengeographie*, 1896, p. 61.

⁴ Ewart, *Annals of Botany*, Vol. XII, 1898, p. 383 seq. Here, and in Wiesner's experiments, the photo-chemical intensity of the light was determined by means of sensitized paper.

even in very sensitive organs, until after the lapse of 10 to 30 minutes. Indeed, we shall see later, in discussing the daily periodicity of growth, that the adjustment to the new conditions of illumination may not be completed until after 4 to 12 hours. Apart from the gradual alteration no transitory disturbance seems to be produced as the result of a sudden change of illumination, but in certain photonastic movements the reaction to light may take place rapidly, and the same applies to the movements of such motile organisms as *Bacterium photometricum* and *Monas Okenii*.

The influence of light on growth was investigated by Sachs and Baranetzky on shoots, by Prantl and Stebler on leaves, and by Strehl on roots, in connexion with the daily periodicity¹. These authors also in part determined to what degree light and darkness produce a rapid effect on growth, and fuller investigations were made subsequently by Reinke, Vines, Godlewski, and Stammeroff². The fact that negatively geotropic organs exhibit similar responses in their rate

of growth to positively heliotropic ones, when exposed to changes of illumination, was shown by Müller's and Wiesner's observations on negatively heliotropic aerial roots, by F. Darwin's on the root of *Sinapis alba*, and by Stammeroff's (l. c., p. 149) on the rhizoids of *Marchantia*³. In an experiment by Darwin on the root of *Sinapis alba*, in which the growth was measured microscopically, the average hourly increments of growth in light were 0.514 mm. during the morning, 0.992 mm. in darkness during the afternoon, and 0.583 mm. while exposed to light during the evening.

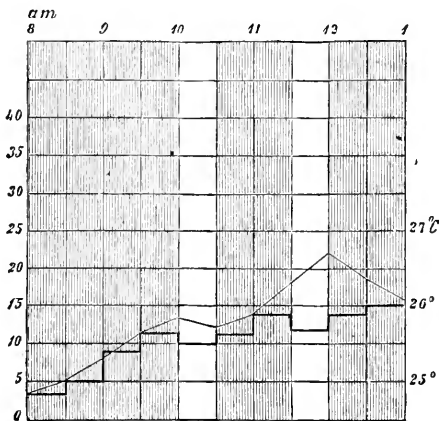

FIG. 21. Growth curve of *Phycomyces* in light and darkness. The fainter line shows the variations of temperature, and the white bands show the periods of exposure to light.

In an experiment by Vines (Fig. 21) on *Phycomyces nitens* grown on bread moistened with sugar solution, the increments of growth were also measured by means of a microscope. The numbers 5, 10, 15 give the increments of

¹ Sachs, Arb. d. Bot. Inst. in Würzburg, 1872, Bd. 1, p. 99; Baranetzky, Die tägliche Periodicität im Längenwachsthum, 1879 (Mém. d. l'Acad. d. St.-Petersbourg, T. XXVII); Prantl, Arb. d. Bot. Inst. in Würzburg, 1873, Bd. 1, p. 371; Stebler, Jahrb. f. wiss. Bot., 1878, Bd. XI, p. 47; Strehl, Unters. ü. d. Längenwachsthum d. Wurzel u. Hypocotyl, 1874, p. 19.

² Reinke, Bot. Ztg., 1876, p. 139; Vines, Arb. d. Bot. Inst. in Würzburg, 1878, Bd. 11, p. 137; Godlewski, Anzeig. d. Akad. d. Wiss. zu Krakau, 1890, p. 169; Stammeroff, Flora, 1897, p. 149 (fungi, pollen-tubes, and rhizoids). On pollen-tubes see also Mangin, Bot. Centralbl., 1887, Bd. XXXII, p. 68; Kny, Sitzungsber. d. Bot. Vereins d. Mark Brandenburg, 12. Juni 1881; Strasburger, Befruchtung u. Zelltheilung, 1877, p. 23; Ewart, Trans. Liverpool Biol. Soc., 1894, Vol. IX, p. 196.

³ H. Müller, Flora, 1876, p. 95; Wiesner, Die heliotrop. Erscheinungen, 1880, II, p. 17; Fr. Darwin, Arb. d. Bot. Inst. in Würzburg, 1880, Bd. 1, p. 521.

growth in micrometer divisions, those on the right give the temperature, which is indicated by the thin line. During each half-hour's exposure to light (10 to 10.30 and 11.30 to 12) the amount of growth decreased. That roots grow more rapidly in darkness than in light is shown by the following results obtained by Wolkoff¹ with *Pisum sativum*:—

Amount of growth.	In darkness.	In diffuse light.
1st day	195 mm.	161 mm.
2nd „	239 „	153 „
3rd „	250 „	210 „
4th „	126 „	113 „
5th „	113 „	78 „
Total in 5 days	923 mm.	715 mm.

The influence of prolonged feeble illumination is well shown by the following experiments by Morgen², in which seedlings of *Lepidium sativum* were grown between February 7 and March 8 at varying distances from a window. It will be seen that the length of the hypocotyl increases as the light decreases, although the dry weight decreases. The lessened growth of the root in the more shaded plants is probably correlated with the increased growth of the hypocotyl combined with the scantier supply of food.

Position of the plants.	Dry weight of 100 plants in grammes.	Average length	
		of the hypocotyl in centimetres.	of the root in centimetres.
In the window . . .	0.228	1.36	6.70
1 metre distant . . .	0.150	3.05	5.40
2 metres distant . . .	0.120	3.20	3.20
3 metres distant . . .	0.108	3.15	3.95
In semi-darkness . . .	0.096	3.60	3.40

Light may also exercise various inductive actions, and the day's exposure may influence the growth during the subsequent night. Thus, in *Pilobolus microsporus* the tendency to sporangium formation induced during the day finds expression during the following night³, and similarly the formation of the pileus and the elongation of the stipe of *Coprinus stercorearius* take place normally during the evening and night⁴. The entire

¹ Mentioned in Sachs' Textbook, p. 808.

² Morgen, Bot. Ztg., 1877, p. 588.

³ Klein, Jahrb. f. wiss. Bot., 1872, Bd. VIII, p. 357; Gräntz, Einfluss d. Lichtes a. d. Entwicklung einiger Pilze, 1898, p. 6.

⁴ Brefeld, Unters. ü. Schimmelpilze, 1877, Heft 3, p. 32; Gräntz, l. c., p. 23.

phenomenon will, however, take place under continued illumination, which also does not retard the cell-division of *Spirogyra*¹, although, as in the case of most algae, this takes place usually at night. It is not yet certain whether this periodicity in autotrophic plants is due to the direct stimulating action of the presence or absence of light, or whether in correlation with the activity of photosynthetic assimilation during the daytime, growth and its accompanying formative changes are somewhat retarded. There is, however, no general tendency towards the performance of growth mainly at night-time, or to withdraw the embryonic cells from exposure to light². As a matter of fact, in nature growth is often more active in the daytime than at night, and the protection of the apical meristem by enfolding leaves, and of the cambium by bark, is mainly for the purpose of avoiding desiccation and mechanical injury. Moreover, respiration and metabolism in general are but little influenced by the normal exposure to light³.

Plants are able to grow when continuously illuminated both in the polar regions and under artificial conditions⁴, but the future must show whether all plants grow normally under light of constant intensity. For various reasons the same total quantity of light will not produce the same physiological effects when spread over the entire twenty-four hours, as when restricted to twelve hours of the day, or an even shorter period. Thus in the first case the intensity of light required to induce the commencement of growth might never be reached, while on the other hand periods of darkness might be required for the production of primordia able to continue their development in light.

SECTION 26. The Mode in which Light acts.

Of the stimulating actions of light, its direct retarding action on growth seems to be of general occurrence, whereas its phototonic action is restricted to special plants and plant organs. Since both these reactions may take place at the same time, and may be combined with effects due to correlation, the final result may have a very complex origin. In non-chlorophyllous plants the photosynthetic influence of light does not come into consideration, and the same applies to all autotrophic plants which are abundantly supplied with nutriment. Thus, leaves which

¹ Famintzin, *Jahrb. f. wiss. Bot.*, 1867-8, Bd. VI, p. 40. Strasburger (*Zellbildung u. Zelltheilung*, 1880, 3. Aufl., p. 171) was able to produce cell-division in the daytime by cooling *Spirogyra* filaments below 5°C. during the night. On the continuous illumination of other algae cf. Klebs. *Bedingungen d. Fortpflanzung*, 1896, p. 27.

² Cf. Sachs, *Bot. Ztg.*, 1863, Beilage, p. 1; *Experimentalphysiol.*, 1865, p. 30.

³ Kolkwitz, *Jahrb. f. wiss. Bot.*, 1899, Bd. XXXIII, p. 128.

⁴ Bonnier, *Rev. gén. d. Bot.*, 1895, T. VII, pp. 242, 412 (flowering plants).

attain their normal size only when in a phototonic condition remain small in darkness, even when abundantly supplied with food-materials¹, while the internodes become elongated even when the supply of food is scanty. Hence leaves and stems when exposed to light in an atmosphere deprived of carbon dioxide² assume their normal shape and size if adequately supplied with food, although no photosynthetic production of food is possible³. This applies to shoots nourished by the assimilating parts exposed to air⁴, or by reserves stored up in rhizomes, tubers, bulbs, or seeds. In the latter case the shoot or seedling dies of starvation as soon as the supply of food is exhausted⁵. The best supply of food will not cause phototonic leaves to grow, or fern and moss spores to germinate in darkness, but the latter will germinate when exposed to light in an atmosphere deprived of carbon dioxide⁶. The fact that fern spores will germinate at 32° C. shows that they are sufficiently supplied with food, and when sugar causes the spores of *Hepaticae* to germinate in darkness, it probably acts primarily as an exciting stimulus.

Correlative influences must always play an important part in producing the phenomena of etiolation. Thus in *Phaseolus* and *Mimosa* it is evidently the active growth of the parts exposed to light which retards or inhibits that of the leaf-primordia on shoots kept in darkness, for these begin to grow when the growing apices are removed from the parts exposed to light, and probably the same would occur if the growth of these parts was mechanically prevented.

Sachs erroneously concluded that the small size of etiolated leaves was merely due to the deficiency of food, while G. Kraus supposed that the leaves were only able to grow by means of the food they themselves assimilated⁷, and others have assumed that etiolated leaves remain small in correlation to the increased growth of the stem⁸. A generally correct view of etiolation was first put forward by Godlewski⁹, and also in the first edition of Pfeffer's *Physiology*.

¹ Sachs, *Bot. Ztg.*, 1863, p. 28; Kraus, *Jahrb. f. wiss. Bot.*, 1869-70, Bd. VII, p. 212; Batalin, *Bot. Ztg.*, 1871, p. 672.

² The apparatus shown in Fig. 48, p. 318, Vol. I, may serve for this purpose. A better arrangement, which may be adapted for single shoots, is shown in Fig. 62, p. 523, Vol. I.

³ [The inner chlorophyllous cells may obtain supplies of carbon dioxide from the inner living non-chlorophyllous cells, and also in solution in the water derived from the roots.]

⁴ De Vries, *Arb. d. Bot. Inst. in Würzburg*, 1878, Bd. II, p. 120; Vöchting, *Bot. Ztg.*, 1891, p. 113; *Jahrb. f. wiss. Bot.*, 1893, Bd. XXV, p. 178; Jost, *Ber. d. Bot. Ges.*, 1894, p. 191.

⁵ Godlewski, *Bot. Ztg.*, 1879, p. 89. The same follows from the behaviour in red and blue light.

⁶ Heald, *Gametophytic Regeneration*, Leipz. Diss., 1897, p. 47.

⁷ Sachs, *Lectures on Physiology*, 1887, 2nd ed., p. 541; Kraus, *Jahrb. f. wiss. Bot.*, 1869-70, Bd. VII, p. 212. Batalin's supposition (*Bot. Ztg.*, 1871, p. 674) that the small size of etiolated leaves is due to the suppression of cell-division in darkness requires no discussion.

⁸ Kraus, *Flora*, 1878, p. 145; Mer, *Bull. d. l. Soc. Bot. d. France*, 1875, T. XXII, p. 190; Rzentowsky, *Bot. Jahresb.*, 1876, p. 745.

⁹ Godlewski, *Bot. Ztg.*, 1879, p. 113.

Naturally a deficiency of food retards or prevents growth. Hence the formation of flowers in *Phanerogams*¹, and of sexual organs in *Vaucheria*², is partially or entirely suppressed when the plants are exposed to light in air deprived of carbon dioxide. Nor is it surprising that in many cases the adult leaves die after being kept for a time in continuous darkness, or when the absence of carbon dioxide renders impossible the performance of the normal functional activity³.

Both the supply of water and the temperature influence the phenomena of etiolation, and in some cases to a considerable extent⁴. Certain green algae, moreover, are able to develop in darkness if provided with suitable food, and although the green and red bacteria which contain chlorophyll and assimilate carbon dioxide by photosynthesis perish in darkness, they may be able to develop on special nutrient media in the absence of light.

Under similar illumination the length of the internodes of *Taraxacum* is but little influenced by rich or scanty supplies of water, whereas the internodes of both *Sempervivum* and *Plantago* become considerably longer in moist air⁵. It is, however, uncertain whether the increased growth is dependent solely upon the higher turgidity, or is also due to a stimulating action exercised by the decreased transpiration. Palladin⁶ is, however, incorrect in ascribing the action of light solely to its influence upon transpiration, for this is only one of the factors influencing growth, and the formative effect of light is shown even when the transpiration is kept constant.

A low temperature decreases the elongation of the internodes, and since in Alpine regions every evening, and also on cloudy days, the temperature falls considerably, and often as low as zero centigrade, growth takes place mainly in the daytime, and therefore under strong illumination. Hence plants under such conditions acquire a more compact and condensed habit, which peculiarity is also aided by the fact that transpiration is active during the growth periods. In the extreme North a similar effect is produced by the length of the summer days during the season of vegetative activity. Alpine plants when grown at low levels assume their normal habit if exposed to low temperatures during the night, or if cultivated under continuous illumination⁷. For example, Edelweiss

¹ Vöchting, *Jahrb. f. wiss. Bot.*, 1893, Bd. xxv, p. 178.

² Klebs, *Bedingungen d. Fortpflanzung*, 1896, pp. 19, 103.

³ Vöchting, *Bot. Ztg.*, 1891, p. 140; Ewart, *Journ. of Linn. Soc.*, Vol. xxxi, 1896, pp. 559-73; Jost, *Jahrb. f. wiss. Bot.*, 1897, Bd. xxvii, pp. 450, 478; MacDougal, *Bot. Ztg.*, 1897, p. 162; *Journ. of Linn. Soc.*, Vol. xxxi, 1896, p. 526; Teodoresco, *Rev. gén. de Bot.*, 1899, T. xi, p. 463.

⁴ Further instances are given by Klebs, *Bedingungen der Fortpflanzung*, 1896, pp. 103, 131.

⁵ Wiesner, *Sitzungsber. d. Wien. Akad.*, 1893, Bd. cii, I, p. 327; *Ber. d. Bot. Ges.*, 1891, p. 46; Godlewski, *Anzeig. d. Akad. d. Wiss. zu Krakau*, 1890, p. 170; W. Brenner, *Flora*, 1900, p. 387.

⁶ Palladin, *Rev. gén. d. Bot.*, 1893, T. ii, p. 170.

⁷ Bonnier, *Rev. gén.*, 1890, T. ii, p. 513; 1895, T. vii, p. 412; *Ann. d. sci. nat.*, 1894, 7^e sér., T. xx, p. 217; *Compt. rend.*, 1898, T. cxxii, p. 307; Pfeffer, *Physiol.*, I. Aufl., Bd. ii, p. 106; Kerner, *Pflanzenleben*, 1891, Bd. ii, p. 494; Schimper, *Pflanzengeographie*, 1898, pp. 739, 753; Curtel, *Rev. gén.*, 1890, T. ii, p. 16; Stenström, *Flora*, 1895, pp. 145, 155. On the

retains its characteristic appearance when cultivated on the plains, if placed in an ice-chest every evening, and exposed to bright light during the day.

The precise character of the stimulatory action of light has yet to be determined, but it is certainly not the result of any direct influence upon turgidity, for the latter does not increase in darkness, and hence is not responsible for the over-elongation of an etiolated stem¹. Nor are the cell-walls stretched beyond their elastic limit in growing etiolated organs, as is shown by the immediate cessation of growth in the absence of oxygen. Similarly in etiolated leaves which have fallen into dark-rigor, growth is reawakened by exposure to light without the turgor being increased or the elastic properties of the cell-walls being modified². Nor are the thickening, lignification, and other metamorphoses of the cell-wall of decisive importance in regulating its growth in surface-extent, but rather serve to adapt the adult cell to special functions. All such changes are vital phenomena, and the stimulatory action of light is undoubtedly of similar character, and is not merely due to the direct mechanical influence of the illumination upon the cell-walls. We are indeed unable even to say whether the action of light is chemical in nature, or whether in some other way it effects a change in the internal conditions regulating growth³. The hypothesis that light retards the motility of the protoplasmic micellae⁴, and hence decreases the activity of growth, is incapable of experimental proof, and it is a mere self-deception to suppose that the action of light upon growing cells can be explained by this assumption.

SECTION 27. The Action of Rays of Different Wave-length.

Although the less refrangible rays are most active in photosynthesis, it is the more refrangible ones (blue to ultra-violet) which exercise the greatest

anatomical peculiarities of Alpine plants cf. Bonnier, l. c., and the literature quoted by Haberlandt, *Physiol. Anat.*, 1896, 2. Aufl., p. 260.

¹ This explanation was propounded by de Vries, *Bot. Ztg.*, 1879, p. 852, but Weng (Pfeffer, *Pflanzenphysiologie*, 1881, 1. Aufl., Bd. II, p. 145) showed that no rise of turgidity occurs in darkness, and this was confirmed by de Vries, *Jahrb. f. wiss. Bot.*, 1884, Bd. XIV, p. 561; Wortmann, *Bot. Ztg.*, 1889, p. 296; Stange, *Bot. Ztg.*, 1892, p. 412. Cf. also Copeland, *Einfluss von Licht und Temperatur auf den Turgor*, Haller Diss., 1896, p. 53. The photonastic movements of pulvini involve in part decreases of turgidity in darkness, and the pileus of *Coprinus* droops in darkness and becomes turgid again on exposure to light. Cf. Brefeld, *Bot. Unters. über Schimmelpilze*, 1877, Heft 3, p. 114; Gräntz, *Einfluss des Lichtes auf einige Pilze*, 1898, p. 34.

² Godlewski (*Anzeig. d. Akad. d. Wiss. zu Krakau*, 1890, p. 287) found the same stretching of the cell-wall by turgor to exist in etiolated as in non-etiolated organs.

³ No sure conclusions can be drawn from the action of light on plasmodia.

⁴ Vines, *Arb. d. Bot. Inst. zu Würzburg*, 1878, Bd. 1, p. 144. [The fact that strong light retards protoplasmic streaming affords no support to this hypothesis, for moderate illumination either exercises no effect on streaming or accelerates it. Moreover no direct connexion exists between growth and streaming. Cf. Ewart, *On the Physics and Physiology of Protoplasmic Streaming*, 1903, Clar. Press, pp. 55 and 69.]

influence upon growth and upon all irritable movements or curvatures. Hence, the shape and growth of a well-nourished plant remain the same behind a solution of cupric oxide in ammonia as in somewhat weakened white light, whereas behind a solution of potassium bichromate, which allows the red and yellow rays to pass, but cuts off the blue and ultra-violet ones, flowering plants turn green, but otherwise grow as though in darkness or in very feeble light¹. The same applies to most plants which are etiolated by darkness. Thus *Pilobolus microsporus* and *Coprinus*, as regards the formation of sporangia, and of the pileus and stipe respectively, behave behind potassium bichromate solution as though in darkness, and behind cuprammonia as though in daylight². In this case the formative processes are induced by light, whereas such as are retarded by ordinary light will be favoured by reddish-yellow light, and retarded by blue light. Thus according to J. Klein³ the formation of spores in *Botrytis cinerea*, and according to Klebs⁴ that of zoospores in *Vaucheria*, is induced by darkness or by cutting off the blue and violet rays. The retarding and ultimately fatal effect exercised by ordinary light upon bacteria, and by concentrated light upon all plants, is due mainly to the more refrangible rays.

There are, however, certain exceptions. Thus according to G. Kraus⁵ the stalk of the pyrenocarpous fructification of *Claviceps microcephala* becomes equally long in red and in blue light, but shorter than in darkness. Similarly the red and yellow rays excite the germination of fern and moss spores, but not the blue and violet ones⁶. The germination takes place equally well in the absence of carbon dioxide, and hence the red and yellow rays act not by producing organic food, but as an exciting stimulus.

In general the formative influence of the less refrangible rays appears to be somewhat greater than its heliotropic action, for the latter is often absent in reddish-yellow light, whereas a distinct difference in shape can usually be seen between green plants grown in red light and in darkness.

¹ Sachs, Bot. Ztg., 1864, p. 371; G. Kraus, *ibid.*, 1876, p. 505; Vines, Arb. d. Bot. Inst. in Würzburg, 1878, Bd. I, pp. 120, 139; Wiesner, Sitzgsb. d. Wien. Akad., 1893, Bd. CII, I, p. 322; Teodoresco, Ann. d. sci. nat., 1899, 8^e sér., T. X, p. 140. Anatomical peculiarities have been studied by Teodoresco, l. c., and also by Rauwenhoff, Ann. d. sci. nat., 1878, 6^e sér., T. V, p. 282. The first observations which were in the main correct were made by Senebier, Phys.-chem. Abhandl., 1785, Bd. II, p. 29; Physiol. végétale, 1800, T. IV, p. 273.

² Brefeld, Bot. Unters. über Schimmelpilze, 1877, Heft 3, p. 96; 1889, VIII, p. 290; Gräntz, Ueber d. Einwirkung d. Lichts auf Pilze, 1898, pp. 18, 29; Lendner, Ann. d. sci. nat., 1897, 8^e sér., T. III, p. 63; Elfving, Einwirkung d. Lichtes auf Pilze, 1890, p. 43. On the retarding action of the blue rays on growth cf. Vines, Arb. d. Bot. Inst. in Würzburg, 1878, Bd. II, p. 139.

³ Klein, Bot. Ztg., 1885, p. 6.

⁴ Klebs, Bedingungen d. Fortpflanzung, 1896, pp. 25, 35.

⁵ G. Kraus, Bot. Ztg., 1876, p. 505. According to Sorokin (Bot. Jahresb., 1874, p. 216) a few fungi grow less in blue light than in darkness.

⁶ Borodin, Bull. d. l'Acad. d. St.-Pétersbourg, 1868, T. XIII, p. 436; Heald, Gametophytic Regeneration, 1897, pp. 47, 61.

Pilobolus and *Coprinus* assume the same shape in red light that they do in darkness, and according to Teodoresco (l. c.) plants grow in monochromatic green light just as though in darkness. According to Bert and G. Kraus, however, the green rays accelerate the onset of dark-rigor in the leaves of *Mimosa pudica*¹, and Kraus states they cause the stalk of the fructification of *Claviceps microcephala* to remain much shorter than in reddish-yellow or blue light or in darkness. It is indeed possible that the isolated green rays may exercise an injurious effect, but nevertheless the above results require further proof, and it needs also to be determined whether the injurious effect is only produced after prolonged exposure, the plants behaving at first as if in darkness. Indeed in all cases the primary effects of the different rays need to be distinguished from the effects following prolonged exposure, and possibly the primary action on growth and on heliotropism would follow similar curves in the absence of any secondary effects. This need not, however, be the case, for heliotropism is a special form of irritability and is not developed in all organs.

The ultra-violet rays seem also to have a pronounced formative influence, and hence this action is correspondingly decreased when they are removed from ordinary light. In such light, however, the remaining blue rays exert sufficient influence to induce the formation of sporangia and sporophores in *Pilobolus* and *Coprinus*², and of sexual organs in *Vaucheria*³. For the same reason the absence of the ultra-violet rays does not produce any immediate effect upon flowering plants, but usually ultimately influences the development as a whole, and in certain cases appears to cause a diminished production of flowers.

Sachs⁴ grew plants of *Tropaolum majus* in light passed in one case through water, and in the other through sulphate of quinine, to remove the ultra-violet rays, and found that in the first case numerous, but in the second hardly any flowers were produced. C. de Candolle⁵ obtained similar results with this plant, but observed less pronounced differences when *Lobelia erinus* was cultivated behind quinine sulphate or aesculin solutions, and behind water. Sachs was not, however, justified in assuming that the ultra-violet rays favour the formation

¹ Bert, Mém. d. l'Acad. d. sc. phys. et nat. d. Bordeaux, 1870, T. VII, p. 28; Compt. rend., 1878, T. LXXXVII, p. 695; Kraus, Bot. Ztg., 1876, p. 508. Kraus used alcoholic solutions of cupric chloride, whereas Bert and Teodoresco (l. c., p. 169) employed coloured films. Gerland (Ann. d. Phys. u. Chem., 1878, Bd. CXLVIII, p. 108) found that plants developed behind a solution of chlorophyll as though in weak diffuse daylight. [Either the solutions of chlorophyll were weak, or were not renewed often enough, for behind strong solutions of chlorophyll seedlings of barley, maize, mustard, cress, and castor-oil plant are as much etiolated as in darkness.]

² Grätz, l. c., pp. 19, 29; Lendner, l. c., p. 61. Elfving (l. c., p. 40) states that a greater crop of fungus is obtained in the absence of the ultra-violet rays.

³ Klebs, Bedingungen d. Fortpflanzung, 1896, p. 110. Cf. also M. E. Pennington, Contr. from the Bot. Lab. of the Univ. of Pennsylvania, 1897, Vol. 1, p. 250.

⁴ Sachs, Arb. d. Bot. Inst. in Würzburg, 1887, Bd. III, p. 372.

⁵ C. de Candolle, Archives d. sci. phys. et nat. d. Genève, 1892, T. XXVIII, p. 265.

of flowers¹, for the reaction is not shown in all cases, and it is well known that the production of flowers is largely dependent upon the vegetative activity. In fact de Candolle found that the growth and increase of dry weight were diminished by the absence of the ultra-violet rays, and it is possible that a similar result might be produced by the partial or complete absence of the violet-blue rays, or by a uniform diminution of all the more refrangible rays.

It is evidently by no means easy to distinguish between the direct and indirect effects produced by the absence of particular rays, but in general it is the more refrangible rays which exercise the most pronounced phototonic and formative action, and which also influence the rapidity of growth to the greatest extent. The same applies to adult ferns and mosses, although germination is excited in the spores of these plants by the less refrangible rays of the spectrum, which is an exception to the general rule.

The relative activity of the different rays of the spectrum has not been precisely determined, and hence it is impossible to say whether the curves for the retarding, phototonic, and formative actions exactly coincide or not. In general, however, it may be said that these curves, like that showing the heliotropic effect, attain a maximum in the more refrangible rays, fall nearly or quite to zero in the green or yellow part of the spectrum, and frequently, though not always, again rise to a second smaller maximum in the red end of the spectrum. These rays, however, appear to influence different functions in various degrees in certain cases. Thus in *Pilobolus crystallinus* the orange rays are able to induce heliotropic curvature but not the formation of sporangia².

So far as is at present known the action of the different rays of the spectrum gives similar curves in regard to heliotropic and phototactic movements, to protoplasmic streaming and movements of the chloroplastids, as well as to the photonastic movements produced by growth or by changes of turgor. On the other hand, it is the less refrangible rays which are most active in photosynthesis, and to a less degree in the development of chlorophyll, and probably also in decomposing the organic acids accumulated by succulent plants in darkness. It does not, however, follow that metabolism in general is more affected by the red rays, for growth itself involves metabolic changes, which are therefore directly or indirectly affected most pronouncedly by the more refrangible rays. Which rays are primarily responsible for the action of light in favouring the synthesis of proteids can hardly be determined until the direct and

¹ Cf. also Klebs, *Probleme d. Fortpflanzung*, 1895, p. 18; Vöchting, *Jahrb. f. wiss. Bot.*, 1893, Bd. xxv, p. 201.

² Brefeld, *Unters. über Schimmelpilze*, 1881, IV, p. 77; Gräntz, *Einfluss d. Lichtes auf Pilze*, 1898, p. 19. It is possible that this is due to the unequal sensitivity.

indirect effects are clearly separated¹. Although the ultra-violet 'chemical' rays exert in most cases a greater chemical activity than light-waves of lesser frequency, the latter are able to induce various chemical actions, the difference being merely one of degree and not of kind. Moreover, by means of absorptive or fluorescent sensitizers the region of greatest chemical activity can be considerably displaced, as when the presence of cosin in a photographic film heightens the relative photo-chemical action of the feebly actinic green rays.

In the red and orange rays green plants assume abnormal shapes owing to the absence of the restraining influence of the more refrangible rays, whereas the latter alone are unable to produce sufficient food for normal development.

The absence of the ultra-violet rays may act by disturbing the harmonious combination required for normal growth, and it is easily comprehensible why the plant may suffer when illuminated by any single group of rays which in themselves are necessary or useful to it. For if certain functions are stimulated more than others, their harmonious co-operation is disturbed, and in the absence of a sufficient power of adjustment the plant of necessity ultimately falls ill or develops abnormally. It is possible that the somewhat problematic injurious action of monochromatic green light may arise in this manner, without its exercising any direct effect upon growth.

Since it depends upon the specific properties of the substance or organism as to whether light exercises any photo-chemical or physiological action upon it, it is hardly surprising that different plants may respond differently to the same light stimulus, or that a response may either be produced only by a limited region of the spectrum, or in varying degrees by rays of different wave-length.

Plants are able to perceive, and often to markedly respond to, rays, such as the ultra-red and ultra-violet rays, which make no impression upon the retina. This question in fact needs to be applied to every known form of radiant energy, whether naturally or artificially produced. Electrical radiations, i. e. ether waves of which the shortest measured (.6 cm.) is nearly 10^8 times longer than that of the last visible red ray (7×10^{-9} cm.), are in fact able to produce certain physiological effects. Whether this also applies to the Röntgen rays² has yet to be determined, for it is not certain whether the positive results, which only a few workers have been able

¹ Teodoresco (Ann. d. sci. nat., 1899, 8^e sér., T. X, p. 259) quotes a portion of the literature.

² In regard to bacteria see Wittlin. Centralbl. f. Bact., 1896, 2. Abth., Bd. II, p. 676; Beck and Schultz, Zeitschr. f. Hygiene, 1897, Bd. XXIII, p. 490; Rieder, Beiheft z. Bot. Centralbl., 1898-9, Bd. VIII, p. 250. For other actions, including tropistic ones, cf. Schober, Ber. d. Bot. Ges., 1896, p. 108; Lopriore, Bot. Centralbl., 1898, Bd. LXXIII, p. 451; Maldiney and Thouvenin, Rev. gén. d. Bot., 1898, T. x, p. 81; Atkinson, Beiheft z. Bot. Centralbl., 1898-9, Bd. VIII, p. 288; Schaudinn, Pflüger's Archiv f. Physiol., 1899, Bd. LXXVII, p. 29 (Protozoa).

to obtain, were produced owing to their using more concentrated rays, or owing to some accidental external conditions. It is also doubtful whether the Becquerel rays¹, or other forms of radiant energy which are not directly visible, produce any physiological effects on plants.

PART IV

THE INFLUENCE OF MAGNETISM AND ELECTRICITY ON GROWTH

SECTION 28.

Weak electrical currents continually circulate in plants, and these are produced by differences of potential between the earth and the atmosphere, as well as by those created and maintained by chemical and physical agencies at work in the plant itself. It is possible that these currents may influence metabolism, and various tropistic actions of electrical currents have already been discovered. No satisfactory proof has however been given that weak electrical currents directly influence growth, when the currents are led through the soil, and precautions are taken to avoid secondary effects². The accelerations and retardations observed by certain authors were due to electrolytic actions upon the constituents of the soil, or to other accessory circumstances. Similarly Müller-Hetlingen³ found that the growth of a seedling was not affected when weak currents were led longitudinally through it. The retardation observed by Elfving⁴ was

¹ Cf. de Haen, *Ann. d. Phys. u. Chem.*, 1899, Bd. LXXVIII, p. 902; Curie, *Compt. rend.*, 1899, T. CXXIX, p. 823; Le Bon, *ibid.*, 1899, T. CXXVIII, p. 174; Giesel, *Ber. d. Chem. Ges.*, 1900, p. 3569. A summary of the literature for 1899 is given in *Beibl. zu Ann. d. Phys. u. Chem.*, 1899, Bd. XXIII, p. lix.

² Wollny, *Forschung. a. d. Gebiete der Agriculturphysiol.*, 1888, Bd. XI, p. 88; 1893, Bd. XVI, p. 243, and the literature there given. A few other works by Chodat, Leod, &c., are quoted in the *Bot. Jahresb.*, 1893, p. 36; 1894, p. 232; Ahlfvengren, *Bot. Centralbl.*, 1899, Bd. LXXIX, p. 53; Euler, *Biol. Centralbl.*, 1901, Bd. XXI, p. 1. Cf. also Solvay, *Du rôle d. l'électricité d. l. phénom. d. l. vie*, 1894. [For the most part these researches, and later ones also, lack the requisite physical precision, and it is highly advisable that the vague use of the term 'weak' electrical currents should be replaced by definite quantitative statements in recognized physical units, the coulombs and current-density being given in all cases.]

³ Pflüger's *Archiv f. Physiologie*, 1883, Bd. XXXI, p. 212.

⁴ Elfving, *Bot. Ztg.*, 1882, p. 257. [Since protoplasm conducts as an electrolyte (cf. Ewart, *On Protoplasmic Streaming*, 1903, *Clar. Press*, pp. 96, 123), no current below the potential required to produce permanent dissociation is able to traverse it. A 'weak' current produces no effect simply because it does not pass through the protoplasm at all; a strong one of sufficient potential unavoidably exercises an electrolytic effect, and this is not confined to the points of exit and entry, but takes place along the path of the current in every cell which contains special substances not present elsewhere, or present in very small amount only. Moreover the resistance offered by plants to the passage of a current is extremely great, and in the absence of other conducting channels, differences of electrical potential between the earth and the atmosphere can only produce electrical currents through an intervening electrolyte when the difference of potential is greater than the back potential due to the products of electrolysis. In the case of bacteria, the electrolytic products formed at the poles naturally influence the composition of the nutrient medium, and hence the development of the organisms, often to a fatal extent. Cf. Cohn and Mendelssohn, *Cohn's Beiträge z. Biolog.*, 1879,

probably due to the use of stronger currents, which always injure and ultimately kill the plant.

Electrical currents of high potential and short duration, such as single or alternating induction shocks or discharges, act primarily like mechanical disturbances or shocks, and hence produce certain irritable responses, and when intense exert injurious or fatal effects¹. Possibly an intermediate intensity of stimulation might, as in other cases, slightly accelerate growth, as well as respiration and other forms of vital activity.

Growth does not seem to be affected even in the strong magnetic fields used by Cisielski and Reinke², although G. Tolomei³ states that a certain acceleration of germination is produced in strong magnetic fields. Errera⁴ observed no influence of magnetism upon cell-division or nuclear division, and Reinke⁵ found that protoplasmic streaming was unaffected. [A pronounced secondary effect is, however, produced after prolonged exposure as the result of inductive action⁶. Since of the different constituents of the cell some (cellulose, albumen, chlorophyll) are paramagnetic in air and are attracted by magnets, whereas others (starch, sugar, oil, water) are diamagnetic and are repelled, it is theoretically only necessary to obtain sufficiently strong fields to produce all the internal stimulatory effects of which gravity and centrifugal force are capable, for these are undoubtedly due to the different densities of the constituents of the living cells, and if these were all alike no perception of such stimuli would be possible. This of course leaves out of question the mechanical stresses and strains due to the mass-attraction upon the entire organism; but that geotropism, for example, is not due to any such action is at once shown by the fact that roots still grow downwards in media of the same or of even greater density. As a matter of fact, however, the required magnetic intensities are probably incapable of attainment⁷.]

III, p. 141. See also Flüggé, *Mikroorganismen*, 1896, 3. Aufl., Bd. I, p. 445; J. Möller, *Centralbl. f. Bact.*, 1897, 2. Abth., Bd. III, p. 110.]

¹ Experiments of this kind were performed by v. Humboldt (see Ingenhousz, *Ernährung d. Pflanzen*, 1798, p. 42). The older literature is given by Treviranus, *Physiologie*, Bd. II, p. 709; de Candolle, *Physiol. végétale*, T. III, p. 1088; Nobbe, *Samenkunde*, 1876, p. 252.

² Cisielski, *Cohn's Beitr. z. Biol.*, 1872, Bd. I, 2, p. 6; Reinke, *Bot. Ztg.*, 1876, p. 133. Negative results have also been obtained with animals by Hermann (*Pflüger's Archiv f. Physiol.*, 1888, Bd. XLIII, p. 228).

³ Tolomei, *Bot. Jahresb.*, 1893, p. 37. [If small seeds, such as linseed, cress, mustard, turnip, cabbage, or wheat, are allowed to germinate on wet sand or sawdust, just above which a strong electro-magnet is vertically or horizontally suspended, germination is often slightly accelerated in the neighbourhood of the magnet. The same effect may, however, be produced when the magnet is not excited or when a bar of soft iron is laid across its poles. It is in fact merely due to the influence of the mass of iron upon the distribution of moisture, and is shown when the surrounding air is comparatively dry, but not when it is kept uniformly moist.]

⁴ Errera, *Bull. d. l. Soc. Bot. d. Belgique*, 1890, T. XXIX, p. 17.

⁵ Reinke, *Pflüger's Archiv f. Physiol.*, 1882, Bd. XXVIII, p. 140.

⁶ Ewart, *Proc. of the Royal Society*, Jan. 1902, p. 469.

⁷ *Id.*, *On Protoplasmic Streaming*, *Clar. Press*, 1903, pp. 45, 49.

PART V

THE INFLUENCE OF GRAVITY AND OF CENTRIFUGAL FORCE UPON GROWTH

SECTION 29.

Since all parts of the plant are subject to the laws of mass-attraction, a sufficient increase of the force of gravity would render plants unable to bear their own weight. A similar effect is produced on seedlings of *Lupinus luteus* when subjected to a centrifugal force 30 times greater than that of gravity¹, and if it were increased to 1,000 g. the stoutest stem would probably be unable to remain erect. Such forces cause abnormal displacements of the contents of large cells², and these are sufficient to cause the death of a filament of *Chara* when subjected for a short time to a centrifugal force equal to 2,000 g.³ In fact the application of a sufficiently powerful centrifugal force must ultimately render the development of every plant impossible.

The trifling differences in the force of gravitation at different parts of the earth's surface exercise no physiological effects worth mentioning, and in its constant and continuous action gravity differs markedly from such variable factors as light, heat, and the supply of nutriment. These agencies may act either as diffuse or as unilateral stimuli, whereas gravity always acts perpendicularly to the surface of the earth⁴. The weight and statical moment of an organ may be altered by growth, and hence also the mechanical demands it makes upon the supporting parts. In this way stimulatory reactions due to pressure and tension may be aroused.

Most plants have acquired by adaptive modification the power of responding to gravity by setting themselves in a definite position, and among such irritable responses the geotropic curvatures of roots are most prominent. Gravitation is also responsible for various barymorphotic reactions, including certain forms of dorsiventrality and of polarity. In

¹ Schwarz, Unters. a. d. Bot. Inst. zu Tübingen, 1881, Bd. 1, p. 80. [The plants will naturally be fixed with the free portion of the stem pointing inwards to the axis of rotation, and the required force would be obtained at the rim of a wheel of 1 foot radius when performing 30 rotations per second. The centrifugal force at the earth's surface, due to its rotation, partly counteracts the force of gravitation, but only to a very slight extent, since even at the equator it only corresponds to an acceleration of 0.12 ft. per sec.², or about $\frac{1}{800}$ th that of gravity. Thus if v = velocity, r = radius, a = acceleration, and T = time of one rotation,

$$\text{then } a = \frac{v^2}{r}; \text{ but } v = \frac{2\pi r}{T} \therefore a = \frac{4\pi^2 r}{T^2} = 0.12 \text{ ft. per sec.}^2$$

Hence the force of gravity at the earth's equator would increase hardly at all if the earth ceased to rotate, and it would only be neutralized when the earth performed a revolution every $1\frac{1}{4}$ hours.]

² [Owing to the varying densities of the cell-constituents. If they all had the same density no such displacement would occur.]

³ Mottier, Annals of Botany, 1899, Vol. XIII, p. 346.

⁴ [Nevertheless as regards the plant it is a more perfectly diffused stimulus than any other, since it has practically exactly the same intensity at all points of any growing organ.]

this respect, however, gravity is not as manifold in its action as is light, nor is it of such fundamental importance as Hofmeister supposed¹. From a phylogenetic point of view, however, the ever-present and approximately constant force of gravity probably played an important part in the induction of fixed polarity, which even now is capable of modification by the same force.

The inherent tendency to form buds at the apical end of the axis, and roots at its basal end, is influenced or even suppressed by various external conditions, including gravity. Thus when the downwardly growing rhizomes of *Yucca* or *Cordyline* are inverted, the hitherto dormant apical bud begins to develop².

In many plants gravity favours the development of buds upon the upper surface of twigs laid horizontally, especially at the apical end, and distinctly influences or induces the development of roots from the under surface of the basal end³. Hence in horizontal or obliquely inclined shoots of *Opuntia Ficus-indica*⁴, as well as in the root-tubers of *Thladiantha dubia*⁵, the buds develop mainly on the upper side, while a renewed formation of roots is induced on the under surface of branches of *Heterocentron diversifolium* when laid horizontally⁶. Similarly the action of gravity is such as to favour the development of rhizoids on the under surface of gemmae of *Marchantia*⁷, and on that of the female prothallus of *Marsilia*⁸.

In a few cases the anisophylly of leafy shoots and of flowers is induced or strengthened by gravity, which is in some cases responsible for the unequal anisotropic thickening of plagiotropic organs⁹. Nördlinger¹⁰, for example, observed that the concentric (isotropic) growth in thickness of a vertical stem was replaced by excentric (anisotropic) growth when it was fixed in a nearly horizontal position. These experiments do not, however, afford conclusive proof, since the influence of the changed tensions and pressures on the upper and under surfaces has not been

¹ Hofmeister, Allgem. Morphol., 1868, p. 579.

² Sachs, Arb. d. Bot. Inst. in Würzburg, 1880, Bd. II, p. 475; Lectures on Physiology, 1887, p. 536; Vöchting, Bot. Ztg., 1880, p. 601. A similar result is, however, also produced by cutting off the rhizomes.

³ Vöchting, Organbildung im Pflanzenreich, 1878, I, p. 164; 1884, II, pp. 40, 95; Sachs, Arb. d. Bot. Inst. in Würzburg, 1880, Bd. II, p. 474. Earlier observations were made by Duhamel, Physique d. arbres, 1758, T. II, p. 122.

⁴ Sachs, l. c., 1882, p. 760.

⁵ Id., l. c., p. 704.

⁶ Vöchting, Organbildung, 1878, I, p. 189.

⁷ Pfeffer, Arb. a. d. Bot. Inst. in Würzburg, 1871, Bd. I, p. 77; Unters. a. d. Bot. Inst. zu Tübingen, 1885, Bd. I, p. 529 (*Marchantia*); Leitgeb, Bot. Ztg., 1872, p. 766; Kny, Entwicklung d. Marchantiaceen, 1875, p. 12 (repr. from aus Nova Acta d. Leopold., Bd. XXXVII) (*Lunularia*).

⁸ Leitgeb, Zur Embryologie d. Farne, 1878, p. 7 (repr. from Sitzungsber. d. Wien. Akad., Bd. LXXVII, I. Abth.).

⁹ Wiesner, Ber. d. Bot. Ges., 1895, p. 481; 1896, p. 181; Sitzungsber. d. Wien. Akad., 1892, Bd. CI, I, p. 677; Bot. Ztg., 1882, p. 697; Büsgen, Waldbäume, 1897, p. 99; Haberlandt, Physiol. Anat., 2. Aufl., p. 513; Detlefsen, Arb. d. Bot. Inst. in Würzburg, 1882, Bd. II, p. 686; Kny, Bot. Ztg., 1877, p. 417; Hofmeister, Allgem. Morphol., 1868, p. 604; Mohl, Bot. Ztg., 1862, p. 274; Schimper, Ber. d. Naturf.-vers. in Göttingen, 1854, p. 87; de Candolle, Pflanzenphysiol., 1833, Bd. I, p. 71.

¹⁰ Nördlinger, Der Holzring als Grundlage d. Baumkörpers, 1871, p. 24; Wiesner, Ber. d. Bot. Ges., 1896, p. 180.

sufficiently considered. At the same time the main stems of Gymnosperms become hypotrophic, and those of the oak epitrophic, when placed horizontally, just as in the case of the lateral branches of these plants, and of *Fagus* and *Tilia*. Finally, if grass-haulms are laid horizontally and their growth in length mechanically restrained, the under sides of the nodes, which would become convex if geotropic curvature were allowed, become instead distinctly thicker on this side¹.

It appears that the inversion of a shoot frequently somewhat retards its growth in length, and that this is slightly accelerated when it is returned to its normal position.

Thus Vöchting² found that the drooping branches of the weeping willow grew more slowly than the erect ones, and according to Raciborski³ the stem-apices of certain tropical climbers undergo a retardation of growth if they fail to come into contact with a support, and therefore hang downwards, and they may even ultimately die. A retardation of growth was also observed by J. Richter⁴ in inverted shoots of *Chara*, and by Elfving⁵ in the inverted sporangiophore of *Phycomyces nitens*. In the last case microscopical measurements were made at short intervals of time alternately in the inverted and normal position, and during each period of inversion the same retardation was shown. A similar action has been observed by J. Ray⁶ in the case of *Sterigmatocystis alba*.

In their normal position, however, the growth of stems and roots would not appear to be perceptibly affected by considerable increases of gravitational force. At least Elfving (l. c.) and Fr. Schwarz⁷ observed the same rate of growth in control plants, and in those subjected to centrifugal forces of from 30 to 50 g. Still higher forces would, however, undoubtedly produce some effect, even if merely by the increased pressures and tensions they create⁸. Mottier⁹, however, observed that the rate of growth remained normal in maize roots after being subjected for 24 hours to a centrifugal force of 1,800 g. Elfving and Schwarz also found that no change in the rate of growth took place in seedlings or in the sporangiophore of *Phycomyces* when rotated horizontally on a klinostat, so that geotropic curvature was avoided, but the force of gravity directed perpendicularly to the long axis of the growing organ. Under such circumstances, however, growth is

¹ Pfeffer, Druck- u. Arbeitsleistungen, 1893, p. 396, and the literature there given.

² Vöchting, Bot. Ztg., 1880, p. 599; Organbildung, 1884, p. 78; Sorauer, Forsch. a. d. Geb. d. Agric., 1885, Bd. VIII, p. 235. Vöchting (Bewegung d. Blüten, 1882, p. 122) found that the inverted peduncles of certain flowers become shorter and thicker than when grown in the normal position.

³ Raciborski, Flora, 1900, p. 35. Correlative influences require consideration in all such cases.

⁴ Richter, Flora, 1894, p. 402.

⁵ Elfving, Beitrag z. Kennt. d. Einwirkung der Schwerkraft auf Pflanzen, 1880 (repr. from Act. Soc. Sci. Fennic., Bd. XII). The experiments are not altogether satisfactory.

⁶ Ray, Rev. gén. d. Bot., 1897, T. IX, p. 255.

⁷ Schwarz, Unters. a. d. Bot. Inst. in Tübingen, 1881, Bd. I, p. 53.

⁸ [These could be practically eliminated by using aquatic plants or seedlings immersed in well-aerated nutrient solutions in closed tubes.]

⁹ Mottier, Annals of Botany, 1899, Vol. XIII, p. 355.

reawakened in the nodes of adult grass-haulms¹, in which therefore gravity seems to induce a premature cessation of growth when it acts parallel to the long axis of the stem.

As far as can be judged, gravity acts mainly as an orienting stimulus, which is not generally essential. Hence plants are able to grow when its orienting action is eliminated, as in free-swimming algae, bacteria, and zoospores². Similarly the mistletoe frequently grows in all directions in space from the boughs on which it is fixed, and those runners which grow erect or horizontally according to the intensity of the illumination, are only feebly or not at all influenced by gravity. Indeed many of the higher plants might be able to complete their entire life-cycle on a revolving klinostat, as *Phycomyces* is actually able to do, in spite of the pronounced influence of gravity upon its shape and direction of growth under normal conditions.

PART VI

THE INFLUENCE OF CHEMICAL AGENCIES ON GROWTH

SECTION 30. General.

Beyond a certain optimal concentration every substance, whether nutrient or not, exerts a retarding or inhibitory effect upon growth, due either to the osmotic or to the poisonous action of the substance in question³.

Within certain specific limits, however, plants may accommodate themselves to unusually concentrated nutrient solutions, while a deficiency of food diminishes the activity of growth and of respiration, and may even cause the plant to work more economically⁴. Not only food-substances, but others also may influence growth. For example, sub-maximal doses of various poisons frequently cause a transitory or even a prolonged increase of respiration, and often of growth also⁵. An increase in the activity of respiration or of protoplasmic streaming is, however, not necessarily accompanied by an increased activity of growth, for these results are due to a complex of accelerating and retarding influences.

¹ Elfving, Verh. d. Grasknotens am Klinostaten, 1884 (repr. from Öfversigt af Finska Vetensk. Soc. Förhandlingar, 1884); Barth, Geotrop. Wachsthumskrümmung d. Knoten, Leipziger Dissert., 1894, p. 32.

² [An organism all of whose constituents were of the same density as the medium in which it floated would be absolutely irresponsive to and unaffected by gravity, so long as it was at rest, but if it moved with constant velocity in irregular curves, every time the vertical component of its velocity increased a gravitational force would act upon it, and when the vertical component decreased this would be of negative sign. The actual velocity of movement of micro-organisms is however so small that such influences are negligible.]

³ On the influence of partial or complete starvation cf. Frank, Krankheiten der Pflanze, 1895, 2. Aufl., Bd. I, p. 278.

⁴ On the effect of sudden changes cf. Reinhardt, Jahrb. f. wiss. Bot., 1892, Bd. xxiii, p. 495; Sokolowa, Das Wachstum d. Wurzelhaare u. Rhizoiden, 1897, and the literature previously given.

⁵ Ono, Die Wachsthumbschleunigung einiger Algen u. Pilze durch chemische Reize, 1900; Journ. Coll. Sci. Imp. Univ., Tokyo.

In certain cases resting organs may be prematurely awakened to renewed activity by means of chemical stimuli. Thus treatment with chloroform induces a resumption of growth and a development of the buds in plants during the winter resting period. In addition, special chemical stimuli are requisite for the development of many spores, and for that of the seeds of a few Phanerogams. The chemotropic movements shown by so many freely motile organisms, as well as those shown by the leaves of carnivorous plants, such as *Drosera* or *Dionaea*, afford good instances of responses produced by special chemical substances.

Chemical stimuli may also exercise a retarding action. Thus Winogradsky and Omeliansky¹ have found that the development of the nitrate and nitrite bacteria is retarded or suppressed by the presence of very small traces of substances, such as peptone, glucose, and asparagin, which have a high nutritive value for most bacteria and fungi. In this way, the process of nitrification is suppressed until the growth of those denitrifying organisms, which consume nitrates and nitrites with loss of nitrogen, has ceased owing to the consumption or decomposition of the glucose, peptone, &c., which they also require. Further, the nitrite bacteria which oxidize ammonia can withstand the presence of large quantities of ammonium salts, which, even when in considerable dilution, retard or inhibit the development of the nitrate bacteria which oxidize nitrites to nitrates. Similarly the development of most bacteria is prevented by the presence of small amounts of acid, even when produced by the organism itself, whereas some species, and most fungi, are highly resistant to acids². If, however, the acid is neutralized, or if in the case of the nitrate and nitrite bacteria the sugar or peptone is removed, the organisms resume their growth, the removal of the retarding agency acting as a favourable stimulus to their development.

The following table by Winogradsky and Omeliansky gives the percentage of certain substances which retards and inhibits the development of nitrite and nitrate bacteria. The ammonia was presented in the form of the sulphate.

	<i>Nitrite bacteria.</i>		<i>Nitrate bacteria.</i>	
	Development		Development	
	Retarded.	Inhibited.	Retarded.	Inhibited.
Glucose	0.025 to 0.05	0.2	0.05	0.2 to 0.3
Peptone	0.025	0.2	0.8	1.25
Asparagin	0.05	0.3	0.05	0.5 to 1.0
Ammonia	—	—	0.0005	0.015

¹ Winogradsky and Omeliansky, *Centralbl. f. Bact.*, 1899, II, Bd. v. p. 436. Duggar (quoted by Pfeffer) has found that 1 % peptone retards the germination of *Ustilago avenarum*.

² Cf. Flüggé, *Mikroorganismen*, 1896, 3. Aufl., Bd. I, p. 456; Zumstein, *Jahrb. f. wiss. Bot.*, 1899, Bd. xxxiv, p. 174 (*Euglena*). Concerning the plants which grow on alkaline soils see Davy, *Investigation of the Native Vegetation of Alkali Lands*, 1898 (Report of the University of California).

These facts are important because they show that a general or local retardation, or a reawakening of growth, may be produced in a self-regulatory manner by the products of the plant's own activity, and the former may occur even when the supply of food and the other external conditions are at an optimum. Similar results may apparently be produced not only by the quantity, but also by the quality of the food supplied, so that a seed or spore amply supplied with stored food-materials may only be able to germinate when a particular nutrient solution, or nutrient or non-nutrient substance, exerts an exciting chemical stimulus upon it. In fact the importance of a food-material is not to be measured solely by the supply of energy it yields, and by its use for constructive metabolism, as is instanced by the important effects exercised by ferments and by small traces of iron.

After treatment with ether the temporary retardation of the growth of seedlings is followed by a temporary acceleration above the normal rate¹. Excessive doses act injuriously, and weak ones produce little or no effect, so that the results of different authors are frequently contradictory².

The spores of certain fungi are unable to germinate unless subjected to certain chemical stimuli. Thus Duggar³ found that the spores of *Botrytis vulgaris* will germinate on pure water, but not those of *Aspergillus flavus*, *A. niger*, *Penicillium glaucum*, and *Phycomyces nitens*. After resting on paraffin, however, all the spores of *Aspergillus flavus*, and most of those of *A. niger*, develop a long germ-tube, and a certain percentage of the other spores can be caused to germinate by special stimulation. On a nutrient solution the direct influence of the food absorbed and its indirect stimulating effect may act conjointly upon germination, as well as upon the subsequent development. In darkness, for example, sugar and, to a less extent, peptone excite the germination of moss-spores, which in light takes place on pure water⁴.

The spores of *Merulius lacrymans*⁵ germinate only on alkaline media, and those of *Onygena equina* only after they have been subjected to the action of the gastric juice⁶. Further researches will probably reveal other special pecu-

¹ Townsend, Annals of Botany, 1897, Vol. XI, p. 522.

² Detmer, Landw. Jahrb., 1882, Bd. XI, p. 227; Elfving, Einwirkung von Aether u. Chloroform auf Pflanzen, 1886, p. 12 (Öfvertryck af Finska Vet. Soc. Förh., Bd. xxviii); Tassi, Bot. Jahrb., 1887, p. 27; Heckel, *ibid.*, 1889, p. 12; Sandsten, Minnesota Bot. Studies, 1898, 2nd ser., Vol. 1, p. 53. On the influence of CO₂, see Lopriore, Jahrb. f. wiss. Bot., 1895, Bd. xxviii, p. 623; Jensen, Centralbl. f. Bact., 1900, Bd. VI, p. 762 (yeast); On the action of tartrate of iron on *Zygnema*, see Klebs, Unt. a. d. Bot. Institut in Tübingen, 1886, Bd. II, p. 545.

³ Benecke (Jahrb. f. wiss. Bot., 1895, Bd. xxviii, p. 501) observed that the spores of certain fungi do not germinate in the absence of potassium.

⁴ Goebel, Flora, 1896, p. 75; Heald, Gametophytic Regeneration, Leipz. Dissertat., 1897, p. 54.

⁵ R. Hartig, Der echte Hausschwamm, 1885, p. 25.

⁶ Ward, Phil. Trans., 1899, Vol. Cxci, p. 278. Cf. de Bary, l. c., p. 376.

liarities¹. The fact that the seeds of *Orobanche* and *Lathraea*² will only germinate on the root of a host-plant, and certain pollen-grains³ only in the stigmatic fluid, seems to show that special chemical stimuli are required in these cases. The numerous researches on the influence of chemical agents upon the germination of other seeds⁴ have brought to light no facts of special scientific value.

SECTION 31. The Influence of Oxygen on Growth.

Most aerobic plants cease to grow when the air around them contains less than from 3 to 0.1 per cent. of oxygen. Certain aerobic organisms such as the sulphur-bacteria are adapted to very small percentages of oxygen, and cease to grow when the oxygen-pressure reaches that of the air at sea-level, whereas the maximal pressure for ordinary plants is from 2 to 30 times that of the atmosphere. Hence the curves showing the influence of oxygen on growth vary in different cases⁵. Very commonly growth is accelerated when the normal oxygen-pressure of the air is lowered, but frequently an increased percentage of oxygen also accelerates growth, so that the curve exhibits a primary and a secondary optimum. The position of the cardinal points varies somewhat according to the stage of development and to the external conditions. In fact certain anaerobes are capable under special conditions of developing in ordinary air. Chudiakow⁶ also found that *Bactridium butyricum*, which normally does not develop when the air-pressure rises above 15 mm. of mercury, can gradually be accommodated to an air-pressure of 50 mm. of mercury (oxygen-pressure = 10 mm. Hg).

The influence of oxygen on growth has been studied by Bert, Wieler, Jentys, Jaccard, and Fr. Schaible⁷.

Increased oxygen-pressure. Above a certain concentration oxygen acts as a poison, and hence before this concentration is reached a certain retarding influence is exercised upon growth. In such experiments the percentage of oxygen may be varied while the total pressure is kept equal to that of the atmosphere. A mere rise of gaseous pressure, if sufficiently great, will produce a retardation and ultimate cessation of growth by antagonizing turgor just as an external mechanical resistance would do. Jentys found that pure oxygen under a pressure of from

¹ See de Bary, Fungi, Bacteria, and Mycetozoa, 1886.

² Heinricher, Jahrb. f. wiss. Bot., 1897, Bd. XXXI, p. 77.

³ Molisch, Sitzgsb. d. Wien. Akad., 1893, Bd. CII, I, p. 428. See also Lidfors, Jahrb. f. wiss. Bot., 1899, Bd. XXXIII, p. 240.

⁴ Nobbe, Samenkunde, 1876, p. 269; Sigmund, Versuchsstat., 1896, Bd. XLVII, p. 1.

⁵ A higher oxygen-pressure is required for germination than for the subsequent growth of the seedlings. Cf. Schaible, Beitr. z. wiss. Bot. von Fünfstück, 1900, Bd. IV, p. 93.

⁶ Chudiakow, Centralbl. f. Bact., 1898, Bd. IV, p. 392.

⁷ Bert, La pression barométrique, 1878; Wieler, Unters. a. d. Bot. Inst. in Tübingen, 1883, Bd. I, p. 189. Methods are given there and in the following works: Jentys, Unters. a. d. Pot. Inst. in Tübingen, 1888, Bd. II, p. 419; Jaccard, Rev. gén. d. Bot., 1893, T. v, p. 289; Schaible, Beitr. z. wiss. Pot. v. Fünfstück, 1900, Bd. IV, p. 93.

three to four atmospheres (= the same density of oxygen as in air under a pressure of 14-19 atmospheres) commonly caused a retardation of growth, and usually produced permanent injury when under a pressure of six atmospheres. The experiments were performed upon ordinary terrestrial plants, and the results were clearly due mostly to the action of the concentrated oxygen, for in air at a pressure of three to six atmospheres growth is not retarded, and may even in some cases be accelerated (Jaccard). The same result is also produced by pure oxygen at atmospheric pressure (Wiesner), but a secondary maximum is not shown by all plants.

A diminution of the atmospheric pressure usually causes a distinct acceleration of growth in strongly aerobic plants, and this appears to attain its maximal value when the pressure falls to between a quarter and a seventh of an atmosphere. Growth may then be accelerated to two or three times its original rapidity in some plants (Wieler), while Jaccard observed that potatoes grew seven times more rapidly under such circumstances. The result is due partly to the decreased density of the oxygen, and partly to the decreased air-pressure. Experiments performed by diluting air with indifferent gases show that a reduced partial pressure of oxygen does act as an accelerating stimulus to growth, and the fact that different authors are not in precise agreement as to the respective parts played by these two factors probably shows that the duration of the experiments and the nature of the plant are of considerable importance. Wieler found that a mere diminution of air-pressure produced no effect upon growth, possibly because his experiments lasted for a shorter time than those of Jaccard and Schaible. That duration is a factor of great importance is shown by the fact that prolonged tension may at first produce a retardation, but subsequently an acceleration of growth.

It is possible that the decreased air-pressure acts by removing a portion of the external pressure antagonizing turgor, and hence increasing the tension exerted by the internal osmotic pressure upon the cell-wall. In any case, however, the action is a stimulatory one, for a correspondingly increased tension of the cell-wall does not produce any mechanical acceleration of growth. This mechanical theory of Schaible's is in fact based upon an erroneous view as to the importance of turgor in growth. Apparently, therefore, either a decrease of air-pressure or a diminution of the partial pressure of oxygen may act as stimuli accelerating growth, although if the time of exposure is short the period of induction may not be sufficiently prolonged for the production of a perceptible result. [Vöchting observed (Bot. Ztg., 1892, p. 94) that a reduction of the percentage of oxygen to 3 per cent. suppressed the formation of root-hairs on the roots of the potato.]

SECTION 32. Changes of Form produced by Chemical Agencies.

All growth is necessarily accompanied by the chemical changes involved in metabolism, and it can be influenced to a greater or less degree by chemical agencies of external origin. The quantity of food often influences the shape and growth of a plant to a pronounced extent¹. For

¹ Cf. Frank, *Krankheiten der Pflanzen*, 1895, 2. Aufl., Bd. I, p. 278.

example, either an excess or deficiency of food may suppress the formation of flowers; in the first case owing to the excessive development of the vegetative parts, and in the second because a starved plant lacks the vigour required for the production of reproductive organs. If not too severe, however, partial starvation usually accelerates the formation of reproductive organs on a previously well-nourished plant.

When growth is enfeebled by the action of poisons, the plant does not necessarily acquire the same shape as when it is starved. Nor is it surprising that the result produced should depend as much upon the specific character and prevailing condition of the plant as upon the chemical agency applied. Hence no general laws can be laid down for the action of a particular substance. It is, however, certain that changes of shape may be produced by starvation or over-feeding, by a mere change in the proportions or character of the nutriment, by acids, alkalies, and poisons, as well as by enzymes and special stimulatory substances¹. All these factors may take part in determining the mode of growth of a plant, the position and character of the various primordia, and hence the shape of the adult plant. It does not, however, follow that particular chemical stimuli are always requisite for the production of sporangia or of flowers, or to determine the subsequent development of a generalized primordium.

Fungi. Organisms with pronounced powers of adaptation are naturally the ones which respond most markedly to chemical stimuli. This applies especially to those Thallophyta in which the stages of the life-cycle are determined by the external conditions.

The fact that a deficiency of food very often induces the formation of spores is of considerable importance, and in fact the stimulus of partial starvation is required for the production of the spores of bacteria², the sporangia of Myxomycetes³, and in part also for the spore-formation of Saccharomycetes⁴. Similarly a deficiency of food induces the formation of zygotes in *Basidiobolus ranarum*⁵, and apparently in other Mucorineae also, while the same agency is responsible for the production of zoospores and oospores by *Saprolegnia*⁶. The abstriction of conidia begins on the mycelia of *Nectria cinnabarina* and *Ascoidea rubescens* when food becomes scanty, and the same cause induces the formation of asci in *Ascophanus carneus*⁷, and of the sporophore of *Coprinus ephemerus* (Klebs, l. c.).

¹ As regards animals see Hertwig, Zelle u. Gewebe, 1898, p. 124.

² Buchner, Centralbl. f. Bact., 1896, Bd. xx, p. 806; Schreiber, *ibid.*, p. 431; Stephanidis, Bot. Centralbl., 1900, Bd. LXXXII, p. 325; Klebs, Jahrb. f. wiss. Bot., 1900, Bd. XXXV, p. 96.

³ Klebs, l. c., p. 98.

⁴ *Id.*, l. c., p. 94. Various agencies favour spore-formation in non-fermenting yeast. Cf. Hansen, Centralbl. f. Bact., 2. Abth., 1898, Bd. v, p. 1; Jörgensen, Mikroorganismen d. Gährungsindustrie, 1898, 4. Aufl., p. 195; Beyerinck, Centralbl. f. Bact., 2. Abth., 1898, Bd. IV, p. 662.

⁵ Raciborski, Flora, 1896, p. 129.

⁶ Klebs, l. c., pp. 91, 102.

⁷ Ternetz, Jahrb. f. wiss. Bot., 1900, Bd. XXXV, p. 298.

These responses are best shown when the previous nutritive conditions were such as to permit of active vegetation. If the plants are too much starved, or their growth almost suppressed by alkalies, acids, or poisons, the production of reproductive bodies almost or entirely ceases. Feeble vegetative growth is also possible under conditions which do not permit of the inception of new developments, and we have already seen that, as regards temperature and light, the maxima and minima for vegetative growth are further apart than for reproductive activity. The same applies in the case of oxygen, a smaller quantity of which suffices for the production of the simpler reproductive organs, than for those of morphologically higher value. Thus according to Klebs¹ the sporangia of *Sporodinia grandis* are formed in air reduced to a pressure of 15 mm. of mercury, whereas the production of conjugating hyphae begins when the pressure is raised to 20 mm., and actual conjugation only takes place above 60 mm. pressure (= air with 1.7 per cent. of oxygen). Van Tieghem and others erroneously supposed that the formation of zygotes was induced by a deficiency of oxygen², but this latter does actually cause or favour the passage of the plasmodia of Myxomycetes into certain resistant forms. In the case of anaerobic bacteria it is apparently, on the contrary, the presence of oxygen which induces the formation of spores, or other resting conditions.

In some cases inequalities in the distribution of food produce growth-responses, and the quality of the food-materials is also of importance. Thus, according to Klebs³, *Saprolegnia* grows very well upon meat-extract, peptone, or gelatine, but produces no reproductive organs, whereas glutamin, asparagin, and an abundance of phosphates favour the development of oogonia.

These agencies, as well as acids, alkalies, and poisons, also influence vegetative activity⁴. Thus fermenting Mucor-yeast is not only produced when the organism grows immersed in nutrient sugary solutions in which the supply of oxygen is scanty, but also to a greater or less extent under the action of citric acid and other external agencies⁵. In addition to *Mucor* certain other fungi form yeast-like growths under the action of the same and other agencies⁶. On the other hand the shapes of various species of *Saccharomyces*⁷ are influenced by the cultural and nutrient conditions, and the same also applies to many bacteria⁸.

¹ Klebs, Jahrb. f. wiss. Bot., 1898, Bd. xxxii, pp. 66, 132; *ibid.*, 1900, p. 92.

² Cf. Klebs, l. c., 1900, p. 133.

³ *Id.*, l. c., 1890, p. 111.

⁴ See also Matruchot, Rech. s. l. dével. d. Mucédin., 1892; Bachmann, Bot. Ztg., 1895, p. 107; Jahrb. f. wiss. Bot., 1899, Bd. xxxiv, p. 322; Planchon, Ann. d. sci. nat., 1900, 8^e sér., T. xi, p. 1; Werner, Die Bedingungen d. Conidienbildung bei einigen Pilzen, Dissert., 1898; Ensich, Notes s. l. Myxomycetes, 1899.

⁵ See Klebs, Bedingungen d. Fortpflanzung, 1896, p. 509, and the literature there given.

⁶ *Id.*, l. c.; also Zopf, Pilze, 1890, p. 17; Schostakowitsch, Flora, 1895, Erg.-bd., p. 362; Raciborski, Flora, 1896, p. 126.

⁷ Hansen, Compt. rend. d. Labor. d. Carlsberg, 1900, T. v, p. 1; Jörgensen, Mikroorganismen d. Gährungsindustrie, 1898, 4. Aufl., p. 195, and the literature there given.

⁸ Flügge, Mikroorganismen, 1896, 3. Aufl., Bd. I, pp. 52, 430, 478, &c.; Migula, System d. Bact., 1897, Bd. I, pp. 173, 212. On acetic bacteria, cf. Hansen, Centralbl. f. Bact., 2. Abth., 1895, Bd. I, p. 36; Compt. rend. d. Labor. d. Carlsberg, 1900, T. v, p. 39; Henneberg, Centralbl. f. Bact., 1898, 2. Abth., Bd. iv, p. 16.

Algae. Klebs¹ has shown that the presence of 1 per cent. solutions of inulin, amygdalin, or aesculin enables *Conferva* to form zoospores in darkness, whereas solutions of grape- or cane-sugar are ineffective. Similarly *Hydrodictyon* ceases to form zoospores in 0.2 per cent. of Knop's nutrient solution, but rapidly produces them when returned to water². *Vaucheria* and *Chlamidomonas* behave similarly, and, as in the case of fungi, algae usually require a higher oxygen-pressure for the formation of sexual than of asexual reproductive organs. Thus *Vaucheria* is able to grow under an air-pressure reduced to 3 mm. of mercury, but forms normal sexual organs only when the pressure reaches 18 mm.

Phanerogams. Various changes of shape, and even of structure, are produced as the result of partial or complete starvation, as well as by the action of particular chemical substances³.

PART VII

THE INFLUENCE OF THE PERCENTAGE OF WATER AND OF TURGIDITY

SECTION 33. The Action on Vegetative Growth.

Growth is very closely dependent upon the supply of water, for even a slight fall of turgor causes it to be distinctly slowed owing to the diminished stretching growth of the cell-walls, while it often ceases before the tension of the cell-wall due to turgor is entirely removed. Hence plants drooping for want of water grow but slowly or not at all.

Externally applied solutions of neutral salts act similarly in retarding or arresting the growth in surface extent of the cell-wall by antagonizing the internal osmotic pressure⁴. Growth may be completely arrested by solutions isosmotic with the cell-sap without any plasmolysis occurring, although the cell is still rich in water, and continues to respire and exhibit active metabolism. Moreover, plasmolysed protoplasts may even be able to form a new cell-wall around themselves, without any subsequent increase in surface extent being possible.

¹ Klebs, Bedingungen d. Fortpflanzung, 1896, p. 351. Cf. also Senn, Bot. Ztg., 1899, p. 97. Starved fern-prothalli also form no sexual organs, Prantl, Bot. Ztg., 1881, p. 754.

² According to Livingstone (Bot. Gazette, 1900, Vol. xxx, p. 289), the mere change in the osmotic concentration of the medium acts in this manner upon *Stigeoclonium*.

³ Cf. Frank, Krankheiten der Pflanzen, 1895, 2. Aufl., Bd. I, p. 278. Also Dassonville, Rev. gén. d. Bot., 1896, T. VIII, p. 284; Bonnier, Compt. rend., 1897, T. CXXV, p. 794; Pethybridge, Beitr. z. Kenntniss d. Einwirkung d. anorgan. Salze, Göttingen, 1899; Teodororesco, Rev. gén. d. Bot., 1899, T. XI, p. 445; Gottschery, Ann. d. sci. nat., 1899, 8^e sér., T. IX, p. 61.

⁴ Cf. de Vries, Mechan. Ursache d. Zellstreckung, 1877, p. 57; Klebs, Unters. a. d. Bot. Inst. zu Tübingen, 1886, Bd. II, p. 489; Wieler, Ber. d. Bot. Ges., 1887, p. 375; Stange, Bot. Ztg., 1892, p. 253; True, Annals of Botany, 1895, Vol. IX, p. 365; Reinhardt, Bot. Festschrift f. Schwendener, 1899, p. 431.

Plants differ greatly with regard to their power of developing upon solutions of less or greater osmotic concentration. Thus many are unable to grow upon solutions isosmotic with 1 to 2 per cent. sodium chloride, or upon such solutions themselves, whereas many algae and fungi can grow upon solutions containing 17 to 20 per cent. of salt, or isosmotic with these. Hence certain organisms occur naturally in salt lakes whose water is nearly saturated with salt, while a few small algae often appear in saturated solutions of potassium nitrate.

This power of accommodation is due either to the absorption of an equivalent amount of salt, or to the production of osmotic substances by metabolism until the original turgor is restored¹. The requisite rise in the concentration of the cell-sap is usually rapidly produced, but nevertheless even then a sudden change of concentration produces a certain disturbance, as is evidenced by the temporary retardation or cessation of growth². This result is produced by sudden decreases, as well as by sudden increases, of concentration. In the second case transitory plasmolysis may take place, whereas thin-walled cells may burst when organisms growing in concentrated solutions are suddenly placed in dilute ones³. This occurs when *Bryopsis* or *Derbesia* are placed in fresh water, whereas the marine algae of estuaries are able to adapt themselves to daily changes from fresh to salt water. Many plants which succumb to rapid changes can survive gradual ones⁴, and Errera has shown that after continued cultivation on concentrated solutions the spores of *Aspergillus niger* acquire the power of

¹ See the works of Eschenhagen, Stange, Oltmanns, Richter, Bruhns, Fischer, Klebs, quoted in Vol. I, p. 421. Also Errera, Bull. d. l'Acad. royale d. Belgique, 1899, p. 95; Yasuda, Jour. Coll. Sc. Imp. Univ. Tokyo, 1900, Vol. XIII, p. 101 (flagellates, infusoria); Pettersson, Archiv. f. Hygiene, 1900, Bd. XXXVII (bacteria).

² Stange, Bot. Ztg., 1892, p. 255; Richter, Flora, 1892, p. 55; Oltmanns, Jahrb. f. wiss. Bot., 1891, Bd. XXI, p. 370; Flora, 1895, p. 47; True, Annals of Botany, 1895, Vol. IX, p. 366.

³ Cf. Eschenhagen, Einfluss von Lösungen versch. Concentration auf Schimmelpilze, 1889, p. 35 (fungi); Noll, Arb. d. Bot. Inst. in Würzburg, 1888, Bd. III, p. 522 (algae); Lidfors, Jahrb. f. wiss. Bot. 1899, Bd. XXXIII, p. 247 (pollen); Fischer, Zeitschr. f. Hygiene u. Infektionskrankheiten, 1900, Bd. XXXV, p. 1. Many pollen-tubes burst when they have attained a certain size without the concentration of the external medium changing, and visible solid particles may even be forced through the wall without any permanent pore being produced. Cf. Ewart, Trans. Liverpool Biol. Soc., Vol. IX, 1895, p. 191. Fischer has observed a similar rupture (*plasmolyse*) of bacteria and also of infusoria (Jahrb. f. wiss. Bot., 1895, Bd. XXVII, p. 73) when transferred to *concentrated* solutions. Fischer supposed this was due to the rapid penetration of the dissolved salt producing an increased pressure inside the cell, but this is incorrect, for the most rapid diosmosis cannot do more than equalize the pressures inside and outside the cell. If however growth were retarded while the production of osmotic substances continued or increased, the pressure inside the cell might easily rapidly surpass the elastic limit of the cell-wall, and so produce a mechanical rupture. The bursting of pollen-tubes is probably produced in this manner.

⁴ Cf. Richter, Flora, 1892, p. 54 (algae); Stahl, Bot. Ztg., 1884, p. 166 (plasmodia); Karsten, Diatom. d. Kieler Bucht, 1899, p. 152; Massart, Archiv. d. Biol., 1889, T. IX, p. 547 (bacteria); A. Fischer, 1900, l. c. (bacteria). For instances of cells which cannot be plasmolysed see Pfeffer, Druck- u. Arbeitsleist., 1893, p. 307; Reinhardt, Botan. Festschrift für Schwendener, 1899, p. 48.

immediately germinating on such solutions, a power which is only gradually lost when the cultures are continued on dilute media¹.

The rate of growth of terrestrial plants varies considerably according to the amount of transpiration and to the supply of water, and in addition to the direct action by influencing the percentage of water, Godlewski² observed a transitory disturbance of growth when the rate of transpiration was suddenly increased. The optimal percentage of water for growth is attained when the plant is fully turgid, for if the aeriferous intercellular spaces of terrestrial and also of many aquatic plants are filled with water, the aeration of the tissues is impeded, and growth, respiration, and metabolism in general are retarded³. Most marine algae are unable to develop when the osmotic concentration of the saline medium falls below a certain limit, possibly partly because of the tendency of their gelatinous walls to undergo excessive absorption of water and swelling when insufficiently checked by the surrounding medium.

SECTION 34. The Influence on Form and Structure.

The supply of water not only influences the distribution of plants⁴, but also affects the formation of cuticle and the development of the conducting channels. The diminished growth produced by a deficiency of water is of importance by keeping the exposed surface area of the plant as small as possible, and hence reducing the loss by transpiration⁵. Xerophytic characters induced in this manner may be more or less completely lost when the plant receives an abundance of water. The power of adaptation is, however, not always sufficiently great to lead to pronounced changes of shape and structure, although in many amphibious plants, such as *Ranunculus fluitans*, *Sagittaria*, and certain algae, the terrestrial and aquatic forms are so distinct as to appear like different species. Similarly in many aquatic plants the parts above water acquire different shapes to those beneath it. Thus the floating leaves of *Ranunculus aquatilis*, *Nuphar luteum*, *Potamogeton natans*, and the aerial leaves of *Sagittaria* differ widely from the submerged leaves, which alone are formed so long as the plant is under water⁶. Under such conditions,

¹ Errera, Bull. d. l'Acad. royale d. Belgique, 1899, p. 95.

² Godlewski, Anzeig. d. Acad. d. Wiss. zu Krakau, 1890, p. 170.

³ Wollny, Forsch. a. d. Gebiete d. Agriculturphysik, 1897, Bd. xx, p. 56; Ad. Mayer, Jour. f. Landw., 1898, p. 167.

⁴ Cf. Schimper, Pflanzengeographie, 1898, p. 3.

⁵ Cf. Sorauer, Bot. Ztg., 1873, p. 145; 1878, p. 1; de Vries, Landw. Jahrb., 1877, Bd. vi, p. 896; Frank, Krankheiten d. Pflanzen, 1895, 4. Aufl., Bd. I, p. 272; Wollny, Forsch. a. d. Gebiete d. Agriculturphysik, 1897, Bd. xx, p. 56, and the literature there given.

⁶ Askenasy, Bot. Ztg., 1870, p. 193; Schenck, Biol. d. Wassergewächse, 1886; Goebel, Pflanzenbiol. Schild., 1893, II, p. 283; Organography, 1900, Part I, p. 260; Wächter, Flora, 1897,

that is when the water is too deep, no flowers are produced, even when the floral primordia are normally developed beneath the surface¹. Similarly the conidia of *Aspergillus niger* and the sporangia of *Mucor* and *Pilobolus* are not formed under water or within solid media², whereas all the reproductive organs of *Saprolegnia* are formed when the plant is entirely submerged. Corresponding peculiarities are exhibited by terrestrial and aquatic mosses³.

An increase in the concentration of the external medium without any change in its composition causes *Vaucheria*, *Botrydium*, and Myxomycetes to produce perennating bodies which are specially resistant to drought⁴. Somewhat analogous to this is the fact that Phanerogams which will not flower in moist habitats, do so when the supply of water is reduced, possibly because of the lessened development of the vegetative organs⁵.

In many cases the change acts by inducing a modification of turgor, which, however, only provides the means for stretching growth without inducing it. The influence of transpiration in favouring the development of the cuticle and of the conducting channels seems to be directly connected with the movements of water it induces. Immersion in water necessarily reduces the supply of oxygen, and this may be a factor of decisive importance.

Since, however, a tendril is able to distinguish between solids and liquids, it is not impossible that the stem and leaves of aquatic plants can perceive and respond directly to the gaseous or liquid condition of the medium surrounding them. Moreover different parts may be dissimilarly affected by changes of the medium, and in this way stimulatory responses are aroused. Since the result may be due to the co-operation of a variety of factors, it is often difficult to determine the precise origin of a particular response.

p. 367. According to Brand (Bot. Centralbl., 1894, Bd. LVII, p. 168), *Nuphar luteum* forms no floating leaves below 12° C.

¹ Cf. Schenck, l. c., p. 112; Goebel, 1893, l. c., p. 369.

² Klebs, Bedingungen d. Fortpflanzung, 1896, pp. 453, 472; Jahrb. f. wiss. Bot., 1898, Bd. XXXII, p. 32; 1900, Bd. XXXV, p. 115; J. Ray, Rev. gén. d. Bot., 1897, T. IX, p. 257; Gräntz, Einfluss d. Lichts auf einige Pilze, 1898, p. 61; Werner, Die Bedingungen der Conidienbildung bei einigen Pilzen, Dissert., 1898; Bachmann, Jahrb. f. wiss. Bot., 1899, Bd. XXXIV, p. 322; Ternetz, Jahrb. f. wiss. Bot., 1900, Bd. XXXV, p. 298; Celakovsky, Bot. Centralbl., 1900, Bd. LXXXIII, p. 292.

³ Cf. Schenck, l. c., p. 49; Lorch, Flora, 1894, p. 424; Goebel, Organography, 1900, Part 1, p. 261.

⁴ De Bary, Morphol. u. Biol. d. Pilze, 1884, p. 460 (Myxomycetes). On algae cf. Cienkowski, Mélang. biol. du Bull. d. l'Acad. d. St.-Petersbourg, 1876, T. IX, p. 537; Rostafinski and Woronin, Bot. Ztg., 1877, p. 660; Stahl, Bot. Ztg., 1879, p. 129; Klebs, Bedingungen d. Fortpflanzung, 1896, pp. 223, 331, &c.; Matruchot and Molliard, Compt. rend., 1900, T. CXXXI, p. 1248 (*Stichococcus*); Livingstone, Bot. Gazette, 1900, Vol. XXX, p. 289.

⁵ On the premature ripening of cereals see Frank, Krankheiten d. Pflanzen, 1895, Bd. 1, p. 267.

A diminution of turgor retards growth, but some other factor must be responsible for the fact that the fully turgid roots of terrestrial plants grow more slowly in damp air or in water than in soil, whereas contact with soil retards the growth of the roots of such aquatic plants as *Lemna*, *Hydrocharis*, and *Azolla*¹. Wakker has shown that these results are not due to an insufficient supply of oxygen, although this is in some cases responsible for the slower growth of the stems of terrestrial plants when submerged in water².

In the case of *Hydrocharis Morsus-ranae*, *Ranunculus sceleratus*, and *Marsilia quadrifolia*, the petioles of the floating leaves cease to elongate as soon as the lamina reaches the surface, while if the water-level is raised a corresponding growth in length is induced in the petiole³. This purposeful reaction takes place when the air above is fully saturated with moisture, and hence is not due to any increase of transpiration, and consequent fall of turgor, nor has Karsten succeeded in showing that it is due to an alteration in the supply of oxygen. Covering the leaf with a thin film of water suffices to cause the elongation of the petiole; hence the latter can hardly be the result of the increased pressure of the water, or of the increased tension on the petiole due to the upthrust of the water on the leaf. [The upthrust of the water on the leaf is, in the absence of any compression, independent of the depth of immersion. In the case of a water-lily leaf of say 100 sq. cm. area on one surface, and 2 mm. thick, the increased tension on the petiole when the leaf was submerged would be equal to 12 grammes if the density of the leaf as a whole was 0.4, assuming that the tension is *nil* when the leaf floats on the surface. On a petiole of 0.4 sq. cm. sectional area this would give a tension of 30 grammes per sq. cm., which, though relatively small, might easily evoke a stimulatory response in a sensitive organ, for it is frequently the case that an applied tension accelerates growth. In any case the question is one that can easily be answered by direct experiment.]

The aeriferous system and air-bladders of aquatic plants are usually better developed when the plant grows in water than when it develops in air⁴, and this also applies to the local or general formation of the different forms of aerenchyma⁵. On the other hand, ordinary aerial leaves undergo less anatomical differentiation when development under water renders transpiration impossible⁶.

¹ Sachs, Arb. d. Bot. Inst. in Würzburg, 1874, Bd. I, pp. 409, 589; Wakker, Jahrb. f. wiss. Bot., 1898, Bd. XXXII, p. 77.

² Frank, Cohn's Beitr. z. Biol., 1872, Bd. I, p. 76; Vöchting, Organbildung, 1878, p. 131; Wakker, l. c. According to Mazé (Annal. d. l'Institut Pasteur, 1900, T. XIV, p. 250), all seeds are not able to germinate under water.

³ Frank, Cohn's Beitr. z. Biol., 1872, Bd. I, p. 31; Karsten, Bot. Ztg., 1888, p. 566; Goebel, Pflanzenbiol. Schilderungen, 1893, p. 311.

⁴ Schenck, Jahrb. f. wiss. Bot., 1889, Bd. XX, p. 526; Goebel, Organography, 1900, Part I, p. 260.

⁵ Schenck, l. c., p. 526; Goebel, Pflanzenbiol. Schilderungen, 1893, p. 256; Wieler, Jahrb. f. wiss. Bot., 1898, Bd. XXXI, p. 519; v. Tubeuf, Forstl. naturw. Zeitschr., 1898, p. 519; Devaux, Ann. d. sci. nat., 1900, 8^e sér., T. XII, p. 221.

⁶ Eberdt, Ber. d. Bot. Ges., 1881, p. 371; Kohl, Transpiration d. Pflz., 1886, pp. 94, 114; Lesage, Compt. rend., 1894, T. CXVIII, p. 255; Bonnier, Ann. d. sci. nat., 1894, 7^e sér., T. XX, p. 350; Junger, Bibl. bot., 1895, Heft 32, p. 1. Also de Bary, Comp. Anat., 1884, pp. 511, 530; Kohl, l. c., p. 91; Keller, Biol. Centralbl., 1898, Bd. XVIII, p. 241; Wollenweber, Bot. Centralbl.,

Similar powers of accommodatory response are possessed by fungi. Thus Klebs¹ has found that *Sporodinia grandis*, *Penicillium*, and *Aspergillus* form no sporangia under water, or in air saturated with moisture. This is because transpiration supplies the stimulus for their formation, although not for the production of zygotes, which is favoured by damp air. Hence by varying the moistness of the air the production of sporangia or of zygotes can be induced at will. *Eurotium*, on the contrary, usually forms conidia when the supply of water diminishes. In certain fungi the spores and sporangia normally appear under water, so that it is not surprising that *Mortierella van Tieghemi* is able to produce its sporangia in fully saturated air in which no transpiration is possible². Other factors may also enter into play, and the influence of the percentage of oxygen on the formation of sporangia, though slight in the case of *Sporodinia*, is pronounced in that of *Mortierella*.

The shapes of algae vary widely according to whether they grow submerged or on damp substrata. Moreover *Vaucheria* forms zoospores when transferred from damp soil to water, and in running water the formation of sexual organs is suppressed³. Whether the water acts mechanically or as an inhibitory stimulus is uncertain⁴.

The formation of primordia is not always affected to the same degree as the subsequent development. Thus certain aquatic plants form flower-buds under water, but these do not open, whereas in other cases immersal in water injuriously affects the development of primordia formed in air⁵. Further, a deficiency of water affects the formation of root-primordia less than it does their subsequent growth, while immersal in water accelerates the latter⁶.

The action of saline solutions is not the same as when the turgor is diminished by transpiration. Hence even when the former only act osmotically, they do not always produce the same changes of shape as result from a fall of turgor due to increased transpiration⁷.

1898, Bd. LXXIV, p. 184; Jahn, Fünfstück's Beitr. z. wiss. Bot., 1897, I, p. 281; Lazniewski, Flora, 1896, p. 260; Schimper, Pflanzengeographie, 1898, p. 20. On the influence of moisture on the development of hairs, thorns, &c., cf. Goebel, Organography, 1900, p. 262.

¹ Klebs, Jahrb. f. wiss. Bot., 1898, Bd. XXXII, p. 61; 1900, Bd. XXXV, p. 115; Ternetz, Jahrb. f. wiss. Bot., 1900, Bd. XXXV, p. 298; Schmid, Bot. Centralbl., 1898, Bd. LXXVI, p. 302. According to Celakovsky (Bot. Centralbl., 1900, Bd. LXXXIII, p. 292), sporangia and conidia develop in oil, i. e. in the absence of transpiration, so that the transition to the new medium must act in some other way.

² Bachmann, Jahrb. f. wiss. Bot., 1899, Bd. XXXIV, p. 323. Cf. Klebs, 1900, l. c., p. 122.

³ Klebs, Bedingungen d. Fortpflanzung, 1896, p. 223.

⁴ Cf. Klebs, *ibid.*, p. 441 (*Hydrurus*); Goebel, Pflanzenbiol. Schilderungen, 1893, 2. Theil, p. 441.

⁵ Gräntz, Einfluss d. Lichts auf einige Pilze, 1898, p. 61.

⁶ Vöchting, Organbildung i. Pflanzenreich, 1878, pp. 125, 142; Pfeffer, Arb. a. d. Bot. Inst. in Würzburg, 1871, Bd. I, p. 97.

⁷ Schimper, Pflanzengeographie, 1898, p. 98; Diels, Jahrb. f. wiss. Bot., 1898, Bd. XXXII, p. 308; Dasselville, Rev. gén. d. Bot., 1898, T. X, p. 15; Otto, Ber. d. Bot. Ges., 1899, p. 139; Eberhardt, Compt. rend., 1900, T. CXXXI, pp. 193, 513; Beauverie, Compt. rend., 1901, T. CXXXII, p. 226. On algae cf. Famintzin, Mélang. biol. d. Bull. d. l'Acad. de St.-Petersbourg, 1871, T. VIII, p. 226.

PART VIII

THE INFLUENCE OF MECHANICAL AGENCIES ON GROWTH

SECTION 35. Mechanical Actions.

Apart from the fact that a sufficient mechanical resistance renders growth impossible, various stimulatory influences are exercised by tension, pressure, and mechanical vibrations or disturbances. Growing plants are able to overcome considerable external resistances, as when a root or shoot pushes aside large stones, or bursts open masonry into which it has penetrated by some crevice. Under such circumstances, the tension of the cell-walls is gradually replaced by the external pressure, against which the whole of the internal osmotic pressure finally acts when the growing tissue has filled the crevice. Even when external growth has ceased the thickening of the cell-walls may still further increase the pressure which the growing tissue is capable of exerting¹.

The observed pressures are, however, not greater than could be produced by the osmotic pressure alone, which usually corresponds to that of from 1.5 to 4 per cent. solutions of potassium nitrate, that is from 4.3 to 15 atmospheres, or from 4.5 to 15.5 kilogrammes per sq. cm. In *Spirogyra*, *Chara*, and in the root of *Zea Mais*, the osmotic pressure does not alter when growth is mechanically restrained, whereas in the root of *Faba vulgaris* it may increase by about one-third its previous value. Even if it only rose in this way to six atmospheres, a 10 cm. thick and 100 cm. long piece of a cylindrical stem or root could support a total external pressure of 6,000 kilogrammes. Moreover, when a root flattens itself to the shape of a crevice, as its surface increases or it develops lateral roots, so also does the total pressure it is capable of exerting increase. In small objects the total pressure is not very great, but nevertheless the radicle of *Faba* can exert a longitudinal pressure of 300 grammes, which is sufficient, when lateral curvature is prevented, to enable the apex to bore into a potato-tuber and grow through it².

The full pressure against a fixed resistance develops with varying rapidity, and usually slower and slower towards the end. The maximum is nearly attained after from two to four days in the case of rapidly growing organs, such as the roots of *Faba*, but the fact that the investing plaster-cast may only be ruptured after two to three weeks shows that the pressure may undergo a further slow increase during this time. The length of this period is due to the fact that the surface-growth of the cell

¹ Pfeffer, Druck- u. Arbeitsleistungen durch wachsende Pflanzen, 1893.

² Id., l. c., p. 362; Peirce, Bot. Ztg., 1894, p. 169.

gradually decreases as the tension of the walls is antagonized by the external pressure, and it may cease before the full osmotic pressure comes into play against the external resistance. When the reaction involves a rise of turgor, however, the maximum pressure appears to be attained in a few days.

The same principles hold good when the resistance to growth is offered by living or dead plant-tissues, as during the production of tissue-strains by the action of compressed tissues against stretched ones. In a plaster-cast the tissue-strains decrease and finally disappear when the maximal external pressure is reached. On removing from the cast, the original tissue-strains and also the original osmotic tensions in the walls of the individual cells return. This happens very suddenly when a root bursts the cast, and hence it is of importance that the cell-wall retains during its imprisonment the power of resisting the original osmotic tension.

When a root pushes an object in front of it, although it performs more work, its rapidity of growth is not perceptibly affected unless the resistance offered is very great. The rate of growth is, for example, practically the same in tenacious soil as in water or moist air, if the other factors are constant. The radicle of *Faba* can exert a maximal apical pressure of 300 to 400 grammes, and grows nearly as rapidly in a clay soil, offering a resistance of 100 to 120 grammes, as in water¹. Krabbe² has found that the growth in thickness of our forest trees is not affected by an increased pressure equal to between 2 and 4 atmospheres, but is retarded by one of 10 to 15 atmospheres.

A soft growing organ will accommodate itself to a certain extent to the shape of the space in which it is confined, and in this way the Chinese have long been accustomed to give gourds and cucumbers all kinds of remarkable shapes by confining them in moulds when young³. The cessation of external growth as the result of external pressure is naturally followed by a cessation of cell-division, and hence in plaster-casts the primary meristem and cambium remain in an inactive condition, while segment-cells previously formed differentiate somewhat abnormally and in part do not attain the usual size⁴.

Methods. The fact that plants can overcome considerable external resistances has long been known, but Pfeffer was the first to correctly explain this phenomenon⁵.

¹ Pfeffer, 1893, l. c., pp. 328, 422. See also Wakker, *Jahrb. f. wiss. Bot.*, 1898, Bd. XXXII, p. 90. The supposition that the root-apex grows more rapidly when the growth of the elongating zone is mechanically retarded is erroneous. Cf. Pfeffer, *Jahrb. f. wiss. Bot.*, 1895, Bd. XXVII, p. 481.

² Krabbe, *Wachstum d. Verdickungsringes u. d. Holzzellen*, 1884, pp. 55, 60; Friedrich, *Bot. Ztg.*, 1897, p. 371.

³ Cf. Pfeffer, 1893, l. c., p. 267.

⁴ Pfeffer, 1893, l. c., p. 356; Newcombe, *Effect of Mechanical Resistance on Growth*, *Leipziger Dissert.*, 1893; *Annals of Botany*, 1894, Vol. VIII, p. 403; *Bot. Gazette*, 1894, Vol. XIX, p. 149; Krabbe, *Wachstum d. Verdickungsringes u. d. Holzzellen*, 1884, pp. 50, 60.

⁵ Pfeffer, *Druck- u. Arbeitsleistungen*, 1893; *Studien zur Energetik d. Pflanze*, 1892.

He mostly employed the method of imbedding in plaster-casts, and measured either the longitudinal pressure (Fig. 22) or the radial pressure (Fig. 23) by causing it to

act against a spring. The pressure is given by the distance between the needle points at *f*, the spring having been previously tested by known weights. In some cases the resistance was kept constant during growth by means of a special arrangement (Pfeffer, l. c., p. 261).

The turgidity was determined by comparison with non-diosmosing osmotic solutions, and the gradual disappearance of the tension in the cell-wall is shown by the fact that a root which shortens on plasmolysis before imbedding, does not do so if removed from the cast after two or three days and tested.

Water-pressure. Not only air-pressure but also water-pressure is able to retard growth. Thus a submerged plant can only enlarge its air-spaces by overcoming the pressure of the water outside, but where air-spaces are absent and the plant

FIG. 22. Apparatus to show the force with which a root elongates. *w*=radicle of seedling growing in pot (*a*) filled with sawdust (*b*). It is imbedded in the plaster-cast (*c*), but the apex in the separate cast (*d*), which is pressed against the spring (*l*), causing the points at (*f*) to approach.

is readily permeable, the pressure of the water exercises no perceptible result on growth, for it acts equally on all parts inside and outside, and rapid readjustment takes place to any change of pressure. Bacteria and other organisms grow in fact

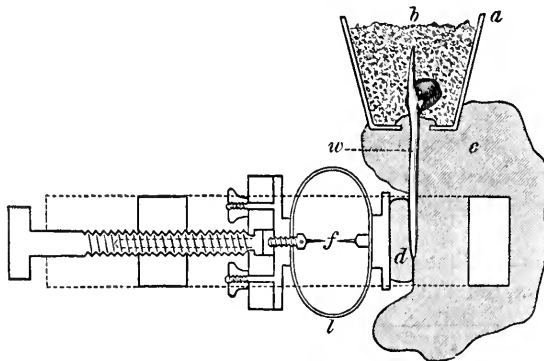

FIG. 23. Apparatus to show radial pressure exerted by a growing root. Lettering as in Fig. 22.

in the greatest depths of the ocean¹, and according to Melsens² yeast grows in a nutrient fluid under a pressure of 8,000 atmospheres.

¹ Fischer, *Centralbl. f. Bact.*, 2. Abth., 1900, Bd. VI, p. 58.

² Melsens, *Compt. rend.*, 1870, T. LXX, p. 831. Cf. also Cétés, *Compt. rend.*, 1884, T. XCIX, p. 111; Roger, *Compt. rend.*, 1894, T. CXIX, p. 963. Berthold (*Mittheil. a. d. zool. Station in*

SECTION 36. The Stimulus of Tension.

Increased tension often causes an organ to increase greatly in strength. Thus Hegler¹ found that the hypocotyl of a seedling of *Helianthus annuus*, having an original breaking strain of 160 grammes, was able to bear 250 grammes after it had been stretched by a weight of 150 grammes for two days. Under the influence of further loads of 250 and 300 grammes the tensile strength rose in a few more days to 400 grammes. The petiole of *Helleborus niger*, with a breaking strain of 400 grammes, was able to bear a breaking strain of 3.5 kilogrammes after it had been subjected to increasing loads for five days, whereas an unloaded petiole underwent little change in the same time. In the case of the hooks of certain tropical climbers, loads of from 0.1 to 1 gramme may produce a distinct effect upon the growth and strength of the attaching organ², whilst as the result of tension the flattened base of the tendrils of *Bauhinia* becomes nearly circular in outline (Ewart, l. c., p. 222).

This power of response seems to be possessed by most young organs capable of growth, for positive results have been obtained with the stems, petioles, and peduncles of a variety of plants, with tendrils and also with the internodes of *Chara*³. That the strength of an attaching or supporting organ should increase within certain limits according to the strains to which it is subjected is of great biological importance. The influence of use and disuse upon the development of the muscles, and even of the bones of animals, is well known⁴.

In plants the increase of strength is commonly due merely to an increase in the thickness or in the elasticity of the walls of pre-existent cells, and naturally the reaction is most prominently shown in the mechanical tissues. Hegler often observed a more abundant development of collenchyma, or an increase in the thickness of the walls of these or of sclerenchyma cells, as the result of increased tension. In the petiole of *Helleborus niger* strong tension causes large numbers of thick-walled bast-fibres to be formed from phloem elements which usually remain thin-walled⁵.

Neapel, 1882, Bd. III, p. 431) states that the water-pressure exercises no noticeable influence upon the distribution of marine algae. [It may be doubted whether this statement applies to such floating forms as *Sargassum*, or to the fixed forms provided with air-bladders (*Fucus*, *Ascophyllum*) which are specially adapted for life between the tide-marks. The pressure cannot be entirely without effect, since it influences the physical surroundings of the plant, but the illumination is undoubtedly a far more potent factor. In any case Melsens' results need confirmation. A pressure of 8,000 atmospheres corresponds to that of 50 miles of sea-water, or 50 tons per sq. inch.]

¹ See Pfeffer, Sitzsb. d. Sächs. Ges. d. Wiss., 1891, p. 639. Similar effects have been observed by Vöchting (Nachr. d. k. Ges. d. Wiss. zu Göttingen, 1902, Heft 5, pp. 5, 6), though not always to the expected extent, and in decapitated stems hardly at all.

² Ewart, Ann. du Jard. Bot. de Buitenzorg, 1898, T. XV, pp. 193, 200, 203, 207.

³ Richter, Flora, 1894, p. 418.

⁴ Hertwig, Die Zelle u. d. Gewebe, 1898, p. 106.

⁵ Thick-walled bast-fibres sometimes appear in the petiole of *Helleborus niger* when growing

In the case of the tendrils and hooks of numerous tropical climbers, contact induces an increased secondary growth by cambial activity, and this is, within certain limits, proportional to the weight supported by them¹.

An increased tension causes in many plants a certain acceleration of growth which may amount to as much as 20 per cent. of the original rapidity, and this is followed, when the tension is suddenly applied, by a retardation of in some cases one-fifth the previous rapidity of growth, and lasting from one to two days². A similar retardation is produced by a sudden increase in the osmotic tension of the cell-walls, and probably the disturbances produced by a suddenly increased and prolonged strain act in a similar manner. It is, however, doubtful whether the excessive elongation of such plants as *Ranunculus fluitans*, *Glyceria fluitans*, and *Potamogeton natans* in rapidly flowing water³ is solely due to the increased tension acting upon them, for the increased flow of water might act in other ways.

The stimulus of tension acts locally, and hence new growths formed beyond the point of application of the tension are not affected by it. Apparently tensions of internal origin act similarly to artificially produced ones. Newcombe⁴ has also observed that when a stem is enclosed in a plaster-cast the cells of the mechanical tissues remain thinner-walled than usual. The same occurs in the wood-elements even when a rapid transpiration-current is maintained through them, and hence it follows that other factors besides the flow of water through them are responsible for the thickening of the walls of the tracheae and tracheides.

When a shoot is strongly bent the cell-walls on the convex side develop thicker walls because of the tension to which they are subjected⁵. Knight⁶ observed that in a tree fixed so as to swing in one plane, the annual rings were more strongly developed in this plane, possibly because of the alternating tensions on the two sides. Similarly the pull of the aërial parts upon the roots must act as a stimulus strengthening the latter, and in general the mechanical demand largely determines the degree of development of the organs of attachment. Thus

under natural conditions, and in that of *Helleborus viridis* a thick layer of such fibres is normally present. Cf. Küster, Flora, 1900, p. 173.

¹ Ewart, Ann. du Jard. Bot. de Buitenzorg, 1898, T. xv, p. 187 seq.

² The transitory retardation was first observed by Baranetzky, Tägl. Periodicität d. Längenwachstums, 1879, p. 20 (Mém. d. l'Acad. d. St.-Petersbourg, 7^e sér., T. xxvii), and more closely investigated by Scholz (Cohn's Beitr. z. Biol., 1887, Bd. iv, p. 323), and by Hegler (ibid. 1893, Bd. vi, p. 383).

³ Kerner, Pflanzenleben, 1891, Bd. II, p. 495; Goebel, Pflanzenbiol. Schilderungen, 1893, II, p. 331; Jungner, Bibl. bot., 1895, Heft 32, p. 21.

⁴ Newcombe, Effect of Mechanical Resistance on the Growth, 1893, p. 40; Annals of Botany, 1894, Vol. VIII, p. 234.

⁵ Pfeffer, Ber. d. Sächs. Ges. d. Wiss., 1891, p. 642; Elfving, Zur Kenntniss d. Krümmungserscheinungen, 1888.

⁶ Knight, Phil. Trans., 1803, II, p. 280; ibid., 1811, p. 217 (observations on roots); Büsgen, Bau u. Leben der Waldbäume, 1897, p. 68.

Ray¹ found that *Sterigmatocystis* becomes more firmly attached when the culture-fluid is kept in motion, and very striking responses to stress and strain are given by many other attaching organs, such as hooks, tendrils, and aerial roots².

SECTION 37. Other Stimuli.

When an organ grows against an immovable object, the mechanical retardation of growth induces certain secondary stimulatory effects upon it, and upon other organs as well³. The changes of tension act in this way, and growth may also be affected by contact, and by mechanical vibrations in certain organs which have acquired the power of responding to such stimuli. The leaves of *Mimosa pudica*, for example, respond to all mechanical vibrations, however produced, whereas tendrils respond only to contact with solid bodies, and not to contact with liquids, such as water or mercury. Tendrils are thus able to discriminate between liquids and solids by means of their sense of touch, and they are unaffected by contact with wet gelatine if it contains sufficient water.

The stimulus of contact causes an acceleration of growth in tendrils, and also in the sporangiophore of *Phycomyces*, and this leads to a curvature if the stimulus is applied to one side only, or if the organ is more sensitive on one side than on the other. In addition the same stimulus often produces a pronounced secondary thickening in tendrils, twining petioles, or the hooks of climbers. Contact is also requisite to induce the production of attaching disks on the tendrils of *Ampelopsis* and certain Bignoniaceae, and also the formation of the parasitic emergences of *Cuscuta*⁴. Similarly the attaching organs of certain algae and fungi are only formed in contact with solid bodies.

In some cases contact retards growth, as when the edge of a mushroom comes into contact with a grass-stem, which it grows round and encloses⁵, owing to growth being retarded at the point of contact. According to Schwarz the elongation of the root-hairs is retarded by contact with solid bodies⁶, and disturbances of growth due to contact are largely responsible for the peculiar shapes assumed by root-hairs and fungal hyphae⁷.

¹ J. Ray, Rev. Gén. d. Bot., 1897, T. IX, p. 252.

² Ewart, Ann. du Jard. Bot. de Buitenzorg, 1898, T. XV, pp. 208, 218, 222, 231, 234.

³ Pfeffer, Druck- u. Arbeitsleistungen, 1893, pp. 333, 427.

⁴ On the Haptera of Podostemonaceae cf. Warming, Bot. Ztg., 1883, p. 193.

⁵ Macaire, Mém. d. l. Soc. d. Genève, II, Pt. II, p. 124, quoted by Treviranus, Physiologie, Bd. II, p. 194; J. Schmitz, Linnaea, 1843, Bd. XIV, p. 448. Frequently it is the grass-haulm which bores through the mushroom.

⁶ Fr. Schwarz, Unters. a. d. Bot. Inst. zu Tübingen, 1883, Bd. 1, p. 179.

⁷ Id., l. c.; Reinhardt, Jahrb. f. wiss. Bot., 1892, Ed. XXIII, p. 495; C. Sokolowa, Wachsthum d. Wurzelhaare u. Rhizoiden, 1897.

Various authors¹ have shown that the formation of attaching organs in *Botrytis cinerea*, *Mucor stolonifer*, and a few other fungi is induced by contact, and that the production and development of the rhizoids² and attaching disks³ of certain, but not of all algae, are induced or accelerated by the same cause. The formation of root-hairs on aërial roots is determined mainly by the percentage of moisture, and not by contact, for in moist air they appear on all sides of the root⁴. Pfeffer erroneously considered that the stimulus of contact favoured the formation of root-hairs on the gemmae of *Marchantia*⁵, and Goebel's observations do not prove that contact induces the development of the rhizoids of *Riccia fluitans*⁶. Sachs concluded that contact is in some cases responsible for the development of the pitchers of *Nepenthes*, but the experiments are not conclusive⁷. According to Raciborski, certain tropical ferns only form sporophylls when their rhizomes are fixed to a support, but this is probably the result of some indirect action⁸.

Growth is affected in other ways by mechanical agencies, and since blows, pressure, and tension are all fatal when sufficiently intense, it is only to be expected that when somewhat less intense they should exercise a certain retarding action. Further, single or repeated changes of tension and pressure, such as are produced by bending, torsion, or shaking, may influence the rapidity of growth. At the same time, however, other factors, such as changes in the supply of food and oxygen, or in the rate of transpiration, may co-operate in producing the result observed.

Both terrestrial and aquatic plants must be able to resist the varying stresses which the movements of wind and water bring to bear upon them if they are to survive⁹. Thus large algae are unable to develop in mountain torrents, because they would at once be torn from the rock, whereas small algae, diatoms, and other organisms may exist directly beneath a waterfall. The power of resistance is increased by minuteness, but nevertheless many microscopic organisms may be injured and finally killed by strong continuous mechanical shocks or vibrations. On the other hand, mechanical stimuli strengthen certain organs, and it is not impossible that some motile organisms may be unable to develop if not permitted to exercise the function of locomotion.

¹ De Bary, Bot. Ztg., 1886, p. 412; Wortmann, Bot. Ztg., 1881, p. 385; Ward, Annals of Botany, 1888, Vol. II, p. 332; Büseng, Bot. Ztg., 1893, p. 53.

² Borge, Bot. Centralbl., 1895, Bd. LXI, p. 319; Bitter, Jahrb. f. wiss. Bot., 1899, Bd. xxxiv, p. 230; Ber. d. Bot. Ges., 1899, pp. 264, 272.

³ On the attaching disks of *Plocamium* cf. Goebel, Organography, 1900, I, pp. 40, 269.

⁴ Cf. Ewart, Ann. d. Jard. Bot. d. Buitenzorg, 1898, T. xv, p. 237. The disk on the tendril of *Ampelopsis Veitchii* produces numerous hairs as the result of contact (Darwin, Climbing Plants, 1875, p. 1, footnote; Cohn, Bot. Ztg., 1878, p. 27).

⁵ Pfeffer, Unters. a. d. Bot. Inst. zu Tübingen, 1885, Bd. 1, p. 528.

⁶ Goebel, Organography, 1900, I, p. 268.

⁷ Mentioned by Goebel, Pflanzenbiol. Schilderungen, 1891, II, p. 96.

⁸ Raciborski, Flora, 1900, p. 25.

⁹ On the mechanical action of rain cf. Wiesner, Bot. Centralbl., 1896, Bd. LXV, p. 42, and Ann. d. Jard. Bot. d. Buitenzorg, 1897, T. xiv, p. 283.

Unpublished researches by Pollock have shown that if the aërial organs are caused to bend gently to and fro, their growth is often at first accelerated, owing either to changes of the tissue-strains or to plastic stretching. Subsequently a certain retardation of growth ensues, and finally, in spite of the continued disturbances, approximately the original rate of growth is resumed. Horvath, Schmidt, and also Meltzer¹ state that violent shaking retards the development of bacteria in nutrient liquids, and ultimately kills them, while Meltzer has shown that some species are more sensitive than others. It is not, however, quite certain that the result is entirely a mechanical effect, for other factors alter when a culture-fluid is continuously shaken. Plasmodia seem to be very sensitive to mechanical shocks and vibrations, whereas the algae which live beneath waterfalls must be highly resistant. Bacteria, yeast², and fungi³ often develop a little more rapidly when the culture-fluid is gently stirred, probably because the supply of food and oxygen is favourably affected.

The molecular movements in the protoplast, to which all physiological reactions are ultimately due, may not only be affected by movements in mass caused by mechanical shocks, but also may be affected by wave vibrations in the ether, such as those of radiant heat, light, and electricity, or by directly transferred molecular vibrations, as when heat is conducted to a plant by an enveloping medium. Just as a particular tone will cause a string to vibrate and iodide of nitrogen placed on it to explode, so it is also possible that particular sound-waves may induce resonant vibrations in the protoplasm, and hence produce molecular disturbances involving physiological reactions. Reinke⁴ in fact found that after 24 hours bacteria had developed hardly at all in a culture-fluid in which a gilded brass tube had been kept in continued longitudinal vibration, and hence concluded that sound-waves hinder development. The experiment is not, however, conclusive, for in small vessels the reflected waves would produce irregular vibrations, and probably considerable internal friction. The true effect of the sound-waves in liquids should be merely one of regular compression and relaxation, and this, if violent, might easily produce a marked effect.

If the mechanical agency causes an injury, the usual wound-reaction ensues, but even without this, changes of tone and correlative influences

¹ Horvath, Pflüger's Archiv, 1878, Bd. XVII, p. 125. Cf. also Nägeli, Theorie d. Gährung, 1878, p. 88; B. Schmidt, Centralbl. f. Bact., 1892, Bd. XI, p. 691; Meltzer, Zeitschr. f. Biol., 1894, Bd. XXX, p. 464. A summary is given by Flüge, Mikroorganismen, 3. Aufl., 1896, I, p. 135.

² Hansen, Meddelelser fra Carlsberg Laboratoriet, 1882, Bd. I, French abstract, p. 94. On the influence of shaking on fermentation cf. Buchner and Rapp, Zeitschr. f. Biol., 1899, N. F., Bd. XIX, p. 108.

³ Ray, Rev. Gén. d. Bot., 1897, T. IX, p. 254. The elimination of the directive action of gravity may be one co-operating factor.

⁴ Reinke, Pflüger's Archiv f. Physiol., 1880, Bd. XXIII, p. 434. The action of enzymes has been supposed to be due to the transference of molecular vibrations.

may come into play. Thus, when the growth of an organ is mechanically prevented, the same influence of correlation is felt in the other parts as when the organ in question is entirely removed. The formation of callus affords a good instance of how slight differences of pressure may, when combined with correlative influences, affect the productive activity. Thus, according to Tittmann¹, a piece of the shoot of *Populus* forms callus with equal readiness on both cut surfaces in moist air, but only on the upper end when the lower one is imbedded in moist sand. If, however, the upper end is enclosed in a plaster-cast, the callus appears on the end imbedded in sand, so that it always grows where the pressure is least, the difference of pressure acting as the stimulus inducing this particular form of productive activity. Similar powers of discrimination probably play an important part in directing and determining the formation and mode of development of new organs and tissues. Any actual attempt at a new growth, however, is able in the first instance to generate a considerable pressure, and hence a rigid plaster-cast can prevent the outward growth of lateral roots, but not the formation of the primordia².

Noll³ observed that new lateral rootlets were produced only on the convex side of a bent root, although primordia formed previously to bending grew out on the concave side as well. The hyphae of *Mucor* and other fungi behave similarly, whereas bent stems of Phanerogams form roots on all sides, or on none⁴. Although the increased tension on the convex side causes the cell-walls to become thicker there, the above reaction can hardly be directly due to the altered tissue-strains, since it also occurs in *Mucor*, in which the tension of the convex wall is, it is true, increased, but the external pressure remains unaffected.

The terms *mechanomorphosis*⁵, *mechanotropism*, and *mechanical stimuli* may be used in this connexion, and plants may be sensitive to stimuli of tension, pressure, contact, and vibration. No special terms are as yet required for the other forms of sensitivity to mechanical agencies. Verworn terms the results of contact-stimulation *thigmotropic* and *thigmomorphic* reactions, whereas Errera uses the terms *haptotropism* and *haptomorphism*⁶.

¹ Tittmann, Jahrb. f. wiss. Bot., 1895, Bd. xxvii, p. 169.

² Pfeffer, Druck- u. Arbeitsleistungen, 1893, p. 356.

³ Noll, Landwirth. Jahrb., 1900, Bd. xxix, p. 422.

⁴ Vöchting, Organbildung, 1878, I, p. 194; 1884, II, p. 45.

⁵ Herbst restricted these terms to the results of tension and pressure.

⁶ Verworn, Psycho-physiolog. Protistenstudien, 1889, p. 90; Errera, Bot. Ztg., 1884, p. 584, footnote. Sachs (Flora, 1893, p. 9, footnote) suggested the word *piesotropism*. Loeb (Heliotropismus d. Thiere, 1889, p. 28) used the word *stereotropism* to denote the tendency to assume a definite position with regard to the substratum. *Somatotropism* is used in a similar sense.

SECTION 38. Traumatic Effects.

Severe injuries produce reactions which not only affect the part injured, but often more distant ones also. Probably the smallest injury is not without effect, though no visible response may ensue. The reaction is mainly directed towards the repairment of the injury, and the whole of the phenomena involved in the traumatic response may be grouped under the term wound-reaction. In simple cases the wound-reaction involves little more than the replacement of a missing part, such as the two new pieces of the peripheral membrane formed when a plasmodium is cut in two, or the transverse walls formed at the opened ends of filaments of *Vaucheria*. When multicellular hairs or filaments of *Spirogyra* are cut through, the exposed transverse walls assume the same peculiarities as the original external walls.

In tissues the injured cells usually die, and the reaction takes place in the neighbouring living cells, and may spread to others more remote. Frequently the reaction merely consists in the cuticularization or other changes of the exposed cell-walls, but often a cork-layer may be formed over the exposed surface, either from a new cork-cambium, or by the gradual modification of the callus-tissue formed at first. The growth of the callus-tissue often leads to the filling up of wounds, or the replacement of the missing parts, and roots and buds may even be produced from it¹. At the same time, the renewed activity of growth is accompanied and frequently preceded by an increase in the respiratory activity, and in the production of heat. The latter, and other responses also, may even occur in tissues of such character that no growth is possible, or in which it is mechanically prevented. Among such reactions are alterations in the rate of protoplasmic streaming or its appearance, changes in the mode of cell-division, and modifications of the normal metabolism leading to the production of gum over wounds.

The increased respiratory activity and the appearance of streaming may spread to some distance, even when the growth-changes are restricted to the immediate neighbourhood of the injury. When, however, entire organs are removed, or conducting channels broken, the ensuing general disturbance may lead to growth-reactions in the most widely distant organs. Thus, the removal of the assimilating leaves naturally unfavourably affects the growth of the roots, while the plant strives to replace missing organs wherever this may be possible, whether near to the injury or far away from it. The results due to the mere absence of an organ and other secondary

¹ Cf. Frank, *Krankheiten d. Pflanzen*, 2. Aufl., 1892, Bd. 1, p. 31; Sorauer, *Pflanzenkrankheiten*, 1886, 2. Aufl., Bd. 1, p. 533; Reehinger, *Verh. d. Zool.-Bot. Ges.*, 1893, p. 310; Mäule, *Bibl. bot.*, 1895, Heft 33; Peters, *Zur Kenntniss d. Wundholzbildung*, 1897; Massart, *La cicatrisation chez les végétaux*, 1898; Küster, *Flora*, 1899, p. 142.

effects must be distinguished, as far as possible, from the true wound-reaction, although a clear distinction cannot always be made.

The wound-reaction is an important means of self-regulation, for it is not only produced by external injuries, but also to a certain extent by the natural death or removal of particular cells or organs. In all cases the reaction is the result of disturbances modifying certain factors and producing alterations in the vital activity. Thus transpiration and diosmosis are affected by the exposed position of an externally injured region, and it is probably these factors which determine the formation of cuticle on exposed cells. The changes of the tissue-strains produced when an organ is removed also act as stimuli, and the removal of an organ may permit growth where mechanical pressure rendered it impossible previously. Thus the pith grows somewhat when isolated from young stems which have themselves ceased to grow. Similarly the cambium, which is only capable of producing an increase of thickness in adult stems, grows freely on a cut surface and spreads out to form a callus. Special stimuli are, however, often involved, for injuries may induce growth in single cells or tissues, which were quiescent in the adult plant, although no mechanical resistance was offered to their growth. This applies to the formation of tyloses, which only appear when the wood has attained a certain age, or when an injury acts as a stimulus to their formation¹, although the open lumina of the tracheae have been available for a long time previously.

Similarly the formation of cork over exposed surfaces is not the direct and unavoidable result of the exposure, for the leaf-scars of some leaves do not become covered by cork, nor do the cells surrounding the intercellular spaces. In some plants, moreover, an internal formation of cork occurs, and a cork-layer is formed around an inserted wooden peg, but not around the penetrating root of a parasite. It is, however, always possible that in certain cases the increased transpiration may induce or accelerate the formation of cork².

Traumatic reactions may not only lead to changes of shape, but also may produce either an acceleration or a retardation of growth. The stretching growth of a decapitated root is only slightly retarded³, whereas when the tip is cut off the first seedling leaf of *Avena sativa*, a pronounced but temporary slowing of

¹ Cf. Frank, *Krankheiten d. Pflanzen*, 2. Aufl., p. 35; Mäule, *Bibl. bot.*, 1895, Heft 33; Massart, *La cicatrisation chez les végétaux*, 1898, p. 43; Warburg, *Ber. d. Bot. Ges.*, 1893, p. 427; Bd. II, p. 51. Cf. Kny, *Die Verwachsungen an d. Wurzelhaaren d. Marchantiaceen* (repr. from *Sitzungsber. d. Bot. Vereins d. Prov. Brandenburg*, 1879, Bd. xxxi); Dixon, *Notes from the Botanical School of Trinity College, Dublin*, 1901, p. 141; Nordhausen, *Jahrb. f. wiss. Bot.*, 1900, Bd. xxxv, p. 372. Cells penetrate others in many algae, in the growth of the zoosporangium of *Saprolegnia*, and in the formation of new rhizoids from the inner tissue-cells of *Marchantia*.

² Kny, *Ber. d. Bot. Ges.*, 1889, p. 154.

³ Czapek, *Jahrb. f. wiss. Bot.*, 1895, Bd. xxvii, p. 246.

growth ensues¹. Townsend found that shortly after the radicle of a seedling had been injured, the growth of the shoot was retarded, but subsequently underwent a transitory acceleration². In this way it results that there is no difference in size between intact plants and those which have been slightly injured³. In the case of the unicellular *Phycomyces nitens*, it is only natural that the abstriction of a hypha of the mycelium should produce a pronounced retardation in the growth of the sporangiophore, but this effect also soon passes away⁴.

¹ Rothert, Cohn's Beitr. z. Biologie, 1896, Bd. VII, p. 202. According to Scholtz (ibid., 1893, Bd. VI, p. 331) the peduncle of *Cobaea scandens* ceases to grow when the flower-bud is cut off.

² Townsend, Annals of Botany, 1897, Vol. XI, p. 509.

³ Kny, Annals of Botany, 1894, Vol. VIII, p. 265.

⁴ Townsend, l. c., p. 527.

CHAPTER VII

THE CAUSES OF SPECIFIC SHAPE

SECTION 39. **General.**

EVERY physiological effect is the result of the activity of the living organism, and the best knowledge of the external conditions for growth affords no insight into the internal mechanism or specific structure which, in interaction with the different functional activities, determines the progress of development. The structure of a germ of unknown origin affords little or no indication as to the character of the plant that would arise from it, since we are entirely ignorant of what constitutes life, and hence scientific research must avoid mere speculation and restrict itself to determining the various interrelated factors which co-operate with and direct this unknown mechanism¹.

The progress of development is primarily determined by the hereditary characters impressed on the germ, and the attainment of one stage of development largely determines the progress to the next, so that the shape of an adult is not so much the direct consequence of the properties of the embryonic germ, as the result of tendencies which arise automatically and in a predetermined manner during development. It is, for example, the growth of a cell which produces its division, and although in Asomatophytes the daughter-cells repeat the same rhythm, in Somatophytes the originally equipotential cells follow different lines of development. The commencement of such differentiation brings new factors into play, and determines a new point of departure for the further development. In this manner the morphological differentiation and the functional division of labour progress side by side, and lead firstly to the formation of stem and root, and subsequently to the development of lateral appendages upon these.

The primitive meristems of stem and root are alike in character, and it is the influence of the parts already formed which determines the development of the equipotential meristem cells into the appropriate elements of the root and stem respectively. In fact few cells have perfect autonomy even in the

¹ See the admirable discussions in H. Spencer's *Principles of Biology*, 1878, and in the article 'Lebenskraft' by Lotze in Wagner's *Handwörterbuch der Physiologie*, 1842, Bd. I. In these works are developed the fundamental principles upon which all modern discussions are based. The subject is not altered by being clothed in a modern dress, which often merely reflects the changeable theories current at the time.

lower plants, but instead they are subjected to various forms of control by neighbouring or far-removed parts, and their potential powers so regulated as to render harmonious co-operation possible.

These general conclusions are justified, even in the absence of any close insight into the complex interactions which take place in the living organism. The reactions involved bear a general similarity to those produced by changes in the external conditions, and they may be compared to those arising from the various forms of symbiosis, whether conjunctive, disjunctive, antagonistic, or reciprocal.

Any change in the external conditions which directly or indirectly modifies one or more of the internal conditions must unavoidably produce some change in the vital activity of the organism, or even in its structure also. The changed activity is, however, the direct result of the altered internal disposition so long as the new external conditions remain constant, and to indicate the primary importance of the hereditary properties of the organism it is permissible to use such terms as automorphosis, self-differentiation, autoplasy, autotropism, and autonasty, although there is no form of vital activity which is independent of the external conditions. By the words aitiomorphosis, heteromorphosis, aiotropism, and aitionasty, we merely indicate certain reactions which changes in the external conditions produce by modifying the vital activity, while the terms photomorphosis, chemomorphosis, photonasty, heliotropism, indicate the external agency which produces the reaction. If the external conditions are kept constant, it becomes possible to determine whether particular phenomena are, in the above sense, of autonomic (internal) or aitionomic (external) origin.

It must, however, be remembered that the properties of the entire organism or of a single organ may undergo automatic alteration, so that it may react differently to the same external conditions. Thus light is necessary for the normal development of the leaf-primordia formed in darkness; the induction or alteration of the geotropic sensibility may produce special curvatures during development; and, lastly, the appearance of dorsiventrality or of a localized irritability produces the conditions for response to unaltered external conditions or to diffusely applied stimuli. In general, the importance of the external conditions always depends upon the condition of the organism at the time, and every physiological effect may be due to a change in the properties of the organism, or to an alteration in the external conditions, or to both combined.

External factors are more readily controlled and their influence determined than is possible in the case of internal ones. Indeed it is frequently impossible to determine whether the reaction is due to one or to several internal factors, or to decide the part played by changes in the properties of the protoplasm. When, however, a result can be definitely ascribed to the action of a tension of internal origin, or to that of some metabolic product,

the same point has been reached as when a particular reaction has been traced to an external agency, for all stimuli, whether of internal or external origin, act by modifying the vital activity, and it is immaterial whence a stimulus is derived if its character and mode of application are the same. The sole difference is that the interactions within the organism are much more complicated and that the properties of each cell are subject to progressive and periodic modification during its development. Moreover a cell in a tissue does not float in a homogeneous medium, but has its various regions exposed to dissimilar physiological, physical, chemical, and mechanical surroundings.

PART I

THE DIFFERENTIATION OF CELLS AND OF ORGANS

SECTION 40. **General.**

Development is determined and controlled firstly by the specific properties of the organism, and secondly by the formal and directive action of the external conditions. These influences may either be of internal origin (correlative) and derived from other cells or organs of the same plant, or they may be due to the external conditions. In unicellular organisms the only correlative influences to be considered are those exerted by the different organs of the cell upon each other. Here also the external conditions, and those arising within the cell itself as growth progresses, exercise a directive influence upon the progress of development. This is also the case when all the segments preserve their embryonic character, as in asomatophytes, whereas in somatophytes cells of similar origin subsequently undergo dissimilar differentiation. Even here the problem ultimately returns to the individual cell, for the dissimilar differentiation of the cells in tissues is determined by the varying properties of the segment-cells, and by directive factors external to them.

The more intimately the properties of the cell are known, the more readily we shall be able to decide how far and by what conditions a particular line of development is produced by the restriction of certain potential powers of the cell and the utilization of others. We may then also decide as to the respective parts played by changes in the properties of the cells concerned, and by variations in the extracellular directive factors, in producing dissimilar differentiation. A careful study of the reactions to changes in the external conditions is, therefore, of vital importance as an aid to the comprehension of the internal factors concerned in development. We presume that the internal factors are similar in character when the same response is given in different cases to the same change in the external conditions, but when different responses are given we can safely assume that the internal dispositions diverge widely in the plants concerned.

Instances have already been given to show that different organisms vary widely as regards their properties, powers, and needs, that the shape may change in correspondence with the external conditions, and that alterations in the latter may be essential for the completion of the life-cycle. In addition many new or unusual growths are only formed under the action of special stimuli, which may also be required for the development of sporangia, flowers, and other organs.

In most cases the germ develops normally under constant and uniform external conditions, the subsequent differentiation resulting from its inherited properties. Such development is automorphic, but in some cases a physiologically radial germ-cell has its main axis of growth determined by external stimuli, and organisms may exist which are unable to develop in the absence of the appropriate orienting stimulus.

When tissue-differentiation and division of labour begin, it requires to be determined whether the different meristems diverge from one another in their specific characters, or whether they remain similar and equipotential. The latter is usually the case, so that the dissimilar differentiation of segment-cells is determined by the action of external factors, or of internal ones, such as the influences arising from the preformed parts. The outermost layer of meristem unavoidably develops into the epidermis, and if the outer layers are removed, the most external layer of living meristem forms a new epidermis. Similarly a further injury may cause cells which would have developed into vascular or parenchymatous elements, according to their position, to form callus-tissue and a layer of cork.

It has not yet been found possible to raise a flowering plant from an artificially isolated meristem cell, but in many plants single cells or groups of cells may form buds on root, stem, or leaf, and these may develop into new plants, showing that the original cells were similar in character and possessed of the same productive powers. This vegetative reproduction is favoured by the disturbance or interruption of the correlative determining influences exerted by associated parts, and the mode of removal or plane of incision may determine whether a particular group of cells develops into a root or shoot¹. Even when the new formations are produced from cells which under normal conditions had ceased to grow, the experiments are completely satisfactory, for the segment-cells could not possess the general powers requisite for the formation of a new plant unless these powers were inherent in the original cells.

So long as the determining factors remain constant, the character of development will be unaltered, and the fact that the formative activity of the stem- and root-apices is comparatively unaffected by a variety of agencies, simply shows that these agencies exert no pronounced influence upon the

¹ Vöchting, Organbildung im Pflanzenreich, 1878, I, p. 240; 1884, II, p. 36.

internal disposition and the factors which regulate it. In certain cases, however, the root-apex may be transformed into a shoot-apex, and vice versa, a fact which affords further evidence of the inherent similarity between the meristems of the root and shoot.

This transformation occurs normally in the root of *Neottia Nidus-avis*, whose apex, after forming leaf-primordia, throws off the root-cap and grows onwards as a stem¹. The same has sometimes been observed in the root-apex of *Anthurium longifolium*², and in cuttings of *Selaginella* the lower primordia of rhizophores frequently develop into roots, the upper ones into shoots³. Beyerinck⁴ has observed on a variety of plants, more especially on *Rumex Acetosella*, the conversion of root-primordia into shoots, and the transformation of an embryonic adventitious bud bearing rudimentary leaves into a root. Such changes are aided by removing so much of the plant that the stem- or root-primordia are left in positions where the opposite kind of organ would normally be developed.

A good instance of the influence of the preformed parts is shown by the thallus of *Marchantia*, in which the dorsiventrality, when once induced, cannot be reversed in the growths formed under altered conditions, although such reversal is easily induced in the prothalli of ferns.

The internal disposition is not necessarily the same in all parts of a given plant, and hence it is not surprising that external conditions which cause embryonic cells in the older parts of the stem to produce roots, may not be able to induce the formation of roots on buds. In every case it can only empirically be determined whether an induced alteration of disposition is labile and changeable by varied external conditions, or whether the induction is stable and permanent⁵. The latter is the case when internal or external agencies induce the formation of the primordium of a root or shoot, which passes on its own characters to the meristematic apex, and so determines the entire subsequent development of the shoot or root. The same also applies to the growing thallus of *Marchantia*, in which the dorsiventrality, when once induced, is impressed upon all subsequent growths.

Instances of labile induction are afforded when the changed shape or structure induced by an orienting stimulus disappears in the new growths formed after the stimulus has been removed. No sharp distinction can, however, be drawn, for an instance of an apparently stable induction may

¹ Irmisch, Biol. d. Orchideen, 1853, p. 26; Prillieux, Ann. d. sci. nat., 1856, 4^e sér., T. v, p. 279; Beyerinck, Beobacht. u. Betracht. ii. Wurzelknospen u. Nebenwurzeln, 1886, p. 17. Beer states that the same occurs in the orchid *Catasetum tridentatum* (quoted by Irmisch).

² Goebel, Bot. Ztg., 1878, p. 645. Karsten (Flora, 1861, p. 232) observed the development of a flower from a root-apex.

³ Pfeffer, in Hanstein's Bot. Abhandl., 1871, I, Heft 4, p. 67; Beyerinck, l. c., pp. 3, 16; Behrens, Flora, 1897, Erg.-bd., p. 158. Behrens observed the same change on *Selaginella denticulata*, which possesses true roots.

⁴ Beyerinck, l. c., pp. 13, 42; Philippi, Ber. d. Bot. Ges., 1901, p. 95.

⁵ Pfeffer, Pflanzenphysiologie, 1. Aufl., Bd. 11, p. 163.

under special conditions prove to be labile, as when a root-apex is converted into that of a shoot. Automatic alterations of the previous conditions must also occur when a vegetating plant begins to flower. In fact a particular disposition, whether inherited or subsequently induced, is stable only so long as it is not acted on by any influence capable of reversing or modifying it.

SECTION 41. On Formative Induction and the Inherent Peculiarities of Cells and Organs.

The progress of development is determined by the changing properties of the growing parts, and by the external influences exercised upon them. Hence the course followed is liable to modification until with the cessation of growth the power of morphological response is lost. Thus buds may be induced to develop into long shoots or into dwarf spurs according to the conditions; the leaf-primordia of aquatic plants may similarly be caused to form either aquatic or aerial leaves, while the primordia of *Prunus*, *Padus*, and other trees, which normally develop into bud-scales, may form foliage leaves when the buds which would rest over winter are caused to undergo direct development by removing all the foliage¹. Naturally if the bud happened to be partially opened at the time, the oldest primordia take on partially or entirely the character of bud-scales, while the younger ones pass by gradual transitions into foliage leaves. Similar gradual transitions must occur when an induced dorsiventrality is reversed by the changed direction of the orienting stimulus.

The principles are essentially the same whether we are dealing with an organ of limited growth, such as a leaf-primordium, or with a shoot-apex in which the determining factors may act not only on the developing primordia, but also upon the primary meristem. In each case the extent to which the general powers of the meristem cells are automatically altered or suppressed during the process of differentiation has to be separately determined, as well as the extent to which the observed modification is due to the influence of neighbouring parts. All primordia are not, however, specifically and permanently dissimilar, for otherwise a root-apex could not be converted into that of a shoot. Similarly the leaf-primordia probably possess at first more or less generalized properties, for although they have never been directly converted into root- and shoot-apices, still the reactions resulting from injuries show that the young leaf-primordia possess the general characters of the embryonic meristem.

Considerable change of shape is possible without the embryonic property being lost, as is shown by the peculiar forms assumed by such

¹ Cf. Goebel, Bot. Ztg., 1880, p. 807.

Asomatophytes as bacteria and yeast under special cultural conditions, and by bryophytes and many thallophyta during the normal development from the spore. Similarly in flowering plants all cells capable of producing rooting buds must retain the general embryonic properties required for the production of a new individual. Possibly in some cases such cells may in part be adult, but may revert to the embryonic condition by a retrogressive change excited by the renewed growth. In Asomatophytes also, an artificially induced modification of the germ-plasma may be eliminated in the course of one or more generations, and so the original embryonic condition regained.

Specific differences do actually exist between the typical embryonic cells of the cambium and of the vegetative apex, and these differences are still more marked in the case of somatic cells which retain the power of producing buds, and in which therefore the germ-plasma is present, but in a dormant condition.

The fact that an embryonic cell, which normally would develop into a vascular element, may form an epidermal cell when an operative injury causes it to be freely exposed, is proof positive that the special course of development of a particular cell is not the result of any specific peculiarity, but of the interaction of its general properties with determining factors due to its position. The same applies to the rudimentary tissue-differentiation which the cell-segments derived from the apical cell of a moss undergo. Even in the early divisions of the fertilized oosphere which mark off the root from the shoot, the polarity is one of position only and does not involve any inherent specific dissimilarity of the segment-cells. These remain, in fact, of generalized character, so that it has actually been found possible to develop an entire plant of *Orobanche* from a portion of the suspensor.

In the case of the different foliar organs, the courses of development may at first coincide and subsequently diverge, or they may diverge from the first appearance of the leaf-primordium. It is also possible that the determining factors which would lead to the production of a floral leaf might subsequently alter so that a foliage leaf was produced instead, and a zigzag development of this kind probably occurs when a change in the external conditions causes a leafy axis to develop in place of a flower.

All primordia of generalized character and powers may be termed indifferent, neutral, or indeterminate¹, whereas primordia or cells which have acquired specific differentiation by the partial suppression or modifica-

¹ Vöchting (*Organbildung*, I, p. 240; II, p. 36; *Bot. Ztg.*, 1895, p. 90) throughout uses the term 'indifferent primordia' in the above general sense, and it is not easy to see why Goebel (*Flora*, 1895, *Erg.-bd.*, p. 212) should object to it. Goebel (*Organography*, 1900, I, p. 8) assumes that a primordium is specifically differentiated as soon as it becomes visible, an assumption which has proved to be incorrect. An apparent dissimilarity may be merely the result of the suppression of certain of the potential powers under the predominating conditions.

tion of their generalized embryonic properties are said to be specifically determined or differentiated. Such post-embryonic primordia may be distinguished as specifically foliar, radicular, or caulicular (leaf, root, stem). Naturally all specific leaf-primordia or stem-meristems are equipotential among themselves, although they may undergo dissimilar differentiation under varied conditions.

Every phase of development is the inevitable result of the existent and pre-existent conditions, and even although factors of entirely obscure internal origin are among the most important of these, there is no need to invoke the aid of a mystical vital force in explanation of the phenomena of life and growth. Nor are the superficial morphological explanations derived from a kind of abstract idealism of any value, though often of tempting simplicity.

The living organism is able, in virtue of its peculiar structure and properties, to carry out reactions or give responses which are not normally produced, and may never have occurred in any previous ancestor. This would be the case if an introduced insect produced a special kind of gall upon a plant, although the two organisms had never before come into contact. Many plants are also able to respond extremely well to chemical substances which do not occur in nature, and which therefore may never have been presented to any ancestor.

Deformations and abnormal growths indicate, therefore, the reactive powers of the organism, but afford no sure guide in determining problems of phylogeny¹. Although from a phylogenetic standpoint a foliage leaf may be regarded as a sterile sporophyll, it does not necessarily follow that the early stages in the development of a foliage leaf or even of a petal are such as would lead, if continued, to the production of a fertile sporophyll. It is indeed hardly to be expected that the ontogeny of an organ or of an individual should precisely recapitulate all the winding deviations of its phylogenetic development. Moreover the attainment of any advantageous peculiarity by selection and survival may involve the appearance of new properties which played no part in the progress of phylogeny, since they appear only when it is completed.

In the progress of development the conditions for the formation of new organs are created according to definite laws. Thus secondary roots are formed after the differentiation of the tissues in the primary root, and appear in definite relation to the positions of the vascular bundles. Similarly, the leaf-primordia develop in some cases immediately at the growing apex, but in *Elodea* and in other plants at a slight distance from it. The growing apex of a root remains

¹ Goebel, *Vergl. Entwicklungsgesch. d. Pflanzenorgane*, 1883, p. 424; *Organography*, 1900, I, p. 177; Sachs, *Flora*, 1893, p. 233.

meristematic in a plaster-cast, but the tissue-differentiation progresses closer to the apex, and with it the appearance of secondary roots¹.

The production of a locality for their development forms one of the conditions for the formation of lateral appendages, which, however, only appear when the required tendency to such formation exists. These determinants normally successively reappear as the growing apex elongates, but this is not always the case, as is shown by the absence of lateral roots from some main roots, and by the non-formation of leaves on stem-tendrils. The plant is able to automatically regulate the frequency with which the conditions for the development of a lateral appendage are repeated, and thus determines whether they shall appear close together as in the case of leaves, or far apart as in roots.

The mode of development of the cotyledons shows that leaves occupying definite positions may be formed without being preceded by special primordia. Hence when leaf-primordia are close together we have only to consider how far their natural tendency to occupy particular positions may be modified by their immediate relationship to one another, and by their interactions during the subsequent course of development. The problems of phyllotaxis fall, however, more within the province of morphology, and the various works based upon Schwendener's theory of phyllotaxis are at variance on the essential point as to whether the primordia are in contact at the moment of their formation or not². Schwendener's theory is in fact really based upon the consideration of the adult structure, and the embryonic phyllotaxis is considered as representing the adult one so long as no secondary modifications are produced by torsion and displacement during development, or by the diminution in size of the successive lateral axes. Such discussions can, of course, never reveal the inherent causes which determine the embryonic phyllotaxis, or the laws which regulate the latter.

Young primordia are easily deformed by pressure³, and in addition differences of pressure may exercise pronounced stimulatory effects, as is shown by the effect of trifling differences of pressure in determining at which end of a segment of a branch callus shall develop. On the other hand a primordium may be formed against considerable external pressure, and Hofmeister³ long ago concluded that the productive activity of the apex of the stem could be but little influenced by the pressure existing in the bud.

¹ Pfeffer, *Druck- u. Arbeitsleistungen*, 1893, p. 335.

² S. Schwendener, *Mechan. Theorie d. Blattstellungen*, 1878; *Sitzungsber. d. Berlin. Akad.*, 1894, p. 979; 1895, p. 465; 1899, p. 50; 1900, p. 1042; *Vöchting, Jahrb. f. wiss. Bot.*, 1898, Bd. XXXI, p. 454; A. Weisse, *Jahrb. f. wiss. Bot.*, 1897, Bd. XXXI, p. 456 and in Goebel, *Organography*, 1900, I, p. 77; K. Schumann, *Morphol. Studien*, 1899, p. 311; L. Jost, *Bot. Ztg.*, 1899, p. 193; W. Arnoldi, *Flora*, 1900, p. 440; Winkler, *Jahrb. f. wiss. Bot.*, 1901, Bd. XXXVI, p. 1. [Church (The Relation of Phyllotaxis to Mechanical Laws, Pts. I-IV, 1901-2) has pointed out that in many cases the supposed necessity for torsion, pressure, and displacement to explain phyllotaxis arrangement simply arises from a miscomprehension of the mathematics of the subject, which is, however, hardly yet ripe for purely mathematical treatment. The primordial papillae of the leaves on fern rhizomes and of other plants also are certainly not in contact, and the statement that the actual boundaries of the primordia may extend beyond the visible papilla is simply an improbable assumption made to bolster up a doubtful fact.]

³ Hofmeister, *Allgem. Morphol.*, 1868, p. 639.

Mechanical pressure is not, however, responsible for the non-formation of leaves on stem-tendrils, or for the differentiation of leaf-primordia into leaves, petals, or stamens according to the determining factors due to their position. It is also due to internal processes of automatic regulation that a flowering plant ultimately produces floral leaves with a different phyllotaxis to that of leafy branches. When a flattened cactus stem becomes triangular the phyllotaxis changes from $\frac{1}{2}$ to $\frac{1}{3}$ ¹, and this is to a certain extent comparable with the fact that in roots the number of vascular bundles determines the number of rows of secondary roots. It is therefore evident that a regular arrangement of the lateral appendages is easily possible, even when they never come into contact and hence do not exert mutual pressure. The fact that leaf-primordia may appear where there is most room for them, or where the pressure is least, is not necessarily the result of a direct mechanical action, but may be due to internal processes of automatic regulation, possibly aided by the stimulatory action of differences of pressure.

SECTION 42. Formative Induction (*continued*).

The varied metamorphoses which the equipotential segment-cells undergo after the divisions of the meristem have ceased may involve the gradual or almost immediate loss of the embryonic character. If, however, divisions occur in cells which have already undergone slight differentiation, the products may be dissimilar from the outset, as is, for example, the case when a cell of *Spirogyra* separates a non-nucleated segment from itself². In other cases dissimilarity may exist between the two segments, although no external sign of it is immediately perceptible. It is then naturally difficult to say whether the differentiation began previously to the division, during it, or after it was completed. Such growing cells are as readily capable, within the limits possible to them, of responding to stimuli by changes of shape as are purely embryonic undifferentiated cells, whose general powers of development are always held in check and regulated by the conditions existing at the time.

A pollen-grain with its pollen-tube affords a good instance of a specially differentiated cell which retains a power of active growth³. In living tissues, moreover, a non-nucleated mass of protoplasm would be able

¹ Vöchting, *Jahrb. f. wiss. Bot.*, 1894, Bd. xxvi, p. 484. Cf. also Kny, *Ber. d. Bot. Ges.*, 1898, p. 60; Weise, *ibid.*, 1899, p. 343; Correns, *Festschrift für Schwendener*, 1899, p. 395; Church, *The Relation of Phyllotaxis to Mechanical Laws*, Pts. I-IV, 1901-2.

² Gerassimoff, *Ueber die kernlosen Zellen bei einigen Conjugaten*, 1896; *Ueber ein Verfahren, kernlose Zellen zu erhalten*, 1896 (repr. from *Bull. d. l. Soc. Imp. d. Naturalistes d. Moscou*); Townsend, *Jahrb. f. wiss. Bot.*, 1897, Bd. xxx, p. 484.

³ Pollen-tubes may be grown to a considerable though always limited length. It remains, however, possible that either the pollen-tube might be able to reproduce its kind, or that the pollen-grain possesses general embryonic properties and might be caused to reproduce an entire plant.

to grow if in protoplasmic connexion with neighbouring cells¹. The laticiferous tubes of Euphorbias afford a further instance of the retention of a power of apical growth in cells which are specifically differentiated². Certain meristems of restricted activity have possibly lost their generalized embryonic characters, but it appears that the phellogen and other cambiums possess general powers of development, although under existing conditions their formative activity is closely restricted to certain channels.

Plants possess great powers of reproduction, owing to the fact that the meristems of the different parts retain their general embryonic character and power of development. In animals, however, this power of reproduction is lost owing to the high specialization, and hence it is impossible to say whether a meristem of normally restricted activity might reproduce the entire animal under appropriate conditions; whether, for example, the meristematic tissue which replaces a missing limb of a Crustacean might be gradually induced to reproduce the entire animal. In worms this power seems to be possessed to a greater or less extent by those tissues which remain capable of growth. The power of development of a cell cannot, however, be told from its external appearance, and in fact cells may remain embryonic, although they take on the appearance and even the properties of differentiated somatic cells. Any cell capable of directly or indirectly reproducing the entire organism must possess an entire replica of the original germ-plasma or idioplasm. These general powers may be modified or suppressed under normal conditions, so that the cell only exercises its full powers of formative activity when the inhibitory or retarding influences which normally act upon it are removed.

Instances have already been given to show that in many cases special stimuli are required to awaken a plant from a resting period, and that such resting periods may be either automatically induced in the entire plant or in certain organs at particular periods in the life-cycle, or they may directly or indirectly result from such agencies as cold, drought, and even oxygen in the case of anaerobes. Even when special chemical stimuli are required to induce germination, the fact that no living or nutrient substance need enter the seed or spore shows that these possess the germ-plasma in its entirety and also a sufficient supply of food. Similarly the fact that an ovum can only develop when fertilized does not show that a portion of the germ-plasma is absent from it, for the direct development of the ovum might be prevented by an automatic inhibition which the stimulus of fertilization removes. This must in fact apply to all sexual cells which are capable of parthenogenetic development with or without the aid of special

¹ Cf. Townsend, Jahrb. f. wiss. Bot., 1897, Bd. xxx, p. 484.

² The laticiferous tissue develops and grows as an independent circulatory system, but nevertheless every meristem which can produce a new plant has *ipso facto* the power of producing a new laticiferous cell.

non-vital stimuli. It is of course possible that the ova of highly specialized plants lack a portion of the germ-plasma which the sperm adds to them, but it is equally possible that in many cases at least they may be capable of development when appropriately stimulated.

In any case the possibility that fertilization involves a stimulatory reaction as well as the addition of the missing germ-plasma must be borne in mind, and it is in fact possible that the two reactions may be separated and that a certain development may be induced in the ovum without the introduction of any living material. Winkler in fact found that a watery extract of the sperm of an Echinoderm induced partial segmentation of the ovum, and Loeb states that treatment with a solution of magnesium chloride, or even a temporary increase in the osmotic pressure of the surrounding medium, produced the same effect¹.

Nathansohn found that the ovum of *Marsilea vestita* at 18°C. only produces an embryo when fertilized, whereas at 35°C. a certain number of the ova develop parthenogenetically. Most of the ova of *Marsilea Drummondii* do the same at 18°C., whereas at 9°C. only a few are capable of parthenogenetic development. A rise of temperature therefore favours parthenogenesis in both cases, and the previous cultural conditions, as well as the ripeness of the original spores, seem also to exercise a certain influence.

The induction and inhibition of growth in both vegetative and reproductive cells are not always the result of chemical stimuli, and the latter, though the character of the substance is of importance, do not always depend upon dissociation, i. e. upon the number and properties of the ions in solution. Fertilization is certainly not a mere process of chemical stimulation, as Loeb supposes, for the union of two protoplasts to form a new organism involves a mixing of characters which may result in the appearance of new peculiarities capable of hereditary transmission.

Since the fact that a cell possesses full embryonic reproductive powers is only shown when the conditions permit or induce the exercise of these powers, we cannot always with safety say which cells in an inactive tissue retain their embryonic powers, and which have lost them. The former seems to apply to all the living cells of mosses, and to certain of those of flowering-plants, such as the cambial, pericyclic, and cortical cells. It may often be the case that an embryonic protoplast may prevent any further exercise of its reproductive powers by enclosing itself in a cell-wall incapable of further growth.

¹ Winkler, Ueber die Furchung unbefruchteter Eier: Nachr. d. Ges. d. Wiss. z. Göttingen, 1900, Heft 2; Loeb, American Journal of Physiology, 1899, Vol. III, pp. 137, 434; 1900, Vol. IV, pp. 178, 430.

² Nathansohn, Ber. d. Bot. Ges., 1900, p. 99. The literature on parthenogenesis in plants is given there. Cf. also Klebs, Jahrb. f. wiss. Bot., 1900, Bd. XXXV, p. 189.

In tissues protoplasmic transference between neighbouring protoplasts may remove, maintain, or restore the embryonic character of particular cells. Hitherto it has not been found possible to bring isolated embryonic cells or primordia of flowering plants to further development, but the same also applies to the fertilized phanerogamic ovum, which possesses full embryonic powers and would undoubtedly develop if nourished under appropriate external conditions.

The assumption of certain authors that amitotic nuclear division indicates an incapability for reproduction is at once disproved by the fact that direct nuclear division occurs normally in many typical embryonic cells. Both forms of nuclear division may naturally result in the production of cells incapable of further growth. In *Chara* the nodal cells divide by karyokinesis and remain capable of reproducing new plants, whereas the internodal cells which divide by amitosis have not this power¹. The nodes of higher plants often retain high reproductive powers, although these are much restricted in the intact plant in spite of the presence of typical embryonic cells.

The products of cellular division in plant-primordia at first possess general powers, and subsequently undergo specific differentiation involving reparable or irreparable modifications of these powers. Weismann has assumed the existence of two special protoplasmic masses, one the reproductive, concerned solely in reproduction, the other vegetative or somatic, and carrying out growth and the vegetative functions of the individual. The facts of plant physiology at once reveal the untenable character of this hypothesis². In addition a very large part of the zoological controversies on the development of the ovum has arisen owing to attempts to make the facts fit preconceived ideas, or owing to hasty generalizations from insufficient data³. If all these theories and the special terms connected with them are put on one side, a general agreement exists between the facts observed in plants and in animals, for in both cases the specific differentiation of the embryonic cells of an organism is determined by their position and by the general external conditions brought to bear upon them. The observed facts have, however, received various interpretations, and it is also disputed whether cells, which in the intact organism develop always in the same manner, are specifically differentiated at a comparatively early period of development or whether they retain general embryonic powers for a long time. In this respect neighbouring cells may behave very differently, so that the dissimilarity is merely one of degree, and is due to the fact that the changes in question occur at earlier or later dates. Plants afford much better material than animals for the study of such problems, for, owing to the high specialization of the individual cells of animals, they are far less capable of reproducing the entire organism than are the less highly differentiated ones of plants.

¹ Debski, *Jahrb. f. wiss. Bot.*, 1898, Bd. XXXII, p. 656; Hegler, *Bot. Centralbl.*, 1895, Bd. LXIV, p. 203; Strasburger, *Histologische Beiträge*, 1893, Heft 5, p. 99; Richter, *Flora*, 1894, p. 417.

² O. Hertwig, *Die Zelle u. d. Gewebe*, 1898, II, p. 58, and the literature there given.

³ Cf. O. Hertwig, l. c., pp. 58, 212; *Zeit- und Streitfragen d. Biologie*, 1897, Heft 2; Roux, *Programm u. Forschungsmethoden d. Entwicklungsmechanik*, 1897; Driesch, *Analyt. Theorie d. organ. Entwicklung*, 1894; *Resultate u. Probleme d. Entwicklungsphysiol. d. Thiere*, 1898 (*Ergeb. d. Anat. u. Entwicklungsgesch.*, edited by Merkel and Bonnet, Bd. VIII).

Insufficient attention is commonly paid to the facts that a labile induction can be modified or suppressed with or without a transitional reaction, and that in regeneration we have a correlative action in which the remaining parts influence or direct the formative activity of the meristematic cell or tissue which reproduces the missing parts. In the absence of such directive influences the embryonic cells of a tissue may be incapable of reproducing a new organism.

To indicate the fact that particular embryonic cells or primordia under the same conditions always produce similar organs, it is permissible with His to distinguish between the germinal tracts of different organs, or with Roux to speak of them as mosaic work, even though a variety of dissimilar factors co-operate in inducing the specific differentiation.

SECTION 43. The Induction of Dorsiventrality.

Morphological and anatomical dorsiventrality may result partly from the external conditions, and partly from the internal disposition, and when once induced it may either be permanent or reversible¹.

An aitionomic dorsiventrality lies before us whenever a particular orienting agency induces a formation of roots, branches, or hairs more on one side than on the other, as well as when the internal structure is affected. Such dorsiventrality naturally becomes permanent in adult parts, whether it is induced by light, gravity, contact, or mechanical agencies. A radial shoot for example acquires an enforced bilaterality when the stimulus of light causes the leaves to develop only on the lateral flanks of its plagiotropic branches. Conversely a dorsiventral organ may become radial, as occurs when the apex of a dorsiventral shoot of *Selaginella* develops into an erect sporangiferous cone, and when, in the sympodial branches of the elm, a lateral bud continues the onward growth of the radial main axis². Diffuse stimuli may induce or favour the development of dorsiventrality or of dorsiventral organs, as is shown by comparing etiolated leaves and branches with those grown under uniform exposure. Finally it must be remembered that physiological dorsiventrality may exist without finding expression in the form of visible morphological or anatomical differentiation.

A good instance of permanent aitionomic induction is afforded by *Marchantia*, for the isobilateral meristem developed at the growing point has the dorsiventrality of the older parts continually impressed upon it. This power must reside in the cells right up to the growing point, for the smallest piece retains its original dorsiventrality when removed and turned upside down. That the meristem at the growing apex is isobilateral is shown by the fact that the dorsal surface of a gemma is always the one that was most strongly illuminated when it commenced to develop adult tissue. This

¹ Cf. Goebel, *Organography*, 1900, I, p. 67.

² Cf. Goebel, l. c., p. 73.

orientation is permanently induced within two or three days, and before any morphological differentiation is perceptible¹.

Leitgeb has shown that unilateral illumination induces the permanent dorsiventrality in the germ-filaments growing from the spores of *Marchantia*, *Duxalia*, *Grimaldia*, and other Marchantiaceae². The same probably applies to the strongly dorsiventral foliose Hepaticae, for when the under surface is brightly illuminated the dorsiventrality is slightly weakened but not reversed³. It has in all cases to be determined whether the dorsiventrality can be induced under homogeneous illumination, or whether unilateral

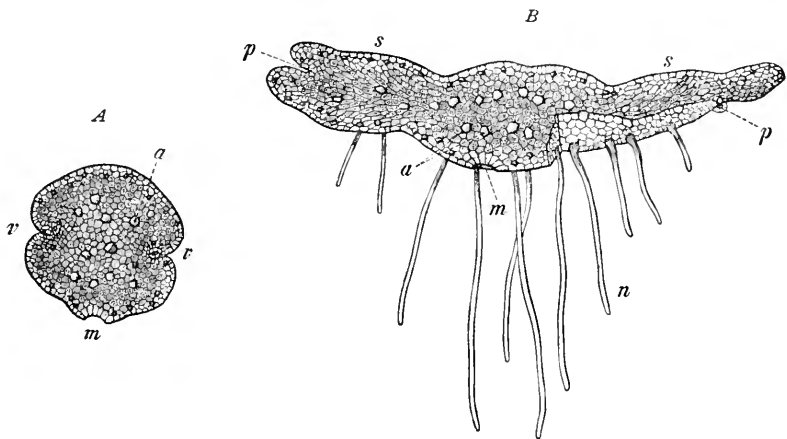

FIG. 24. *A*. Gemma of *Marchantia polymorpha*, showing the two growing points in the groove at *v*. *B*. Later stage, showing the new growths *s, s*; the growing apices *p, p*; *a*, the cells which on the under surfaces develop rhizoids *n*; *m*, insertion of stalk of gemma.

illumination forms an essential condition for its production. The latter appears to be the case in *Marchantia*, according to Czapek⁴, for small weakly plants of radial structure developed from gemmae kept slowly rotating on a clinostat for two or three months. It appears from this that, as might be expected, the development of the dorsiventrality is a condition for vigorous growth.

The equally strongly marked dorsiventrality of fern prothalli is, however, the result of the localized inductive action of the existent external conditions. Thus the rhizoids and sexual organs are developed on the

¹ Pfeffer, Arb. d. Bot. Inst. in Würzburg, 1871, Bd. I, p. 77. Mirbel (Mém. d. l'Acad. d. Sci. de l'Inst. de France, 1835, T. XIII, p. 337) was unable to determine the internal factors involved. Cf. Pfeffer, Unters. a. d. Bot. Inst. zu Tübingen, 1885, Bd. I, p. 528. That *Lunularia* behaves similarly to *Marchantia* has been shown by Leitgeb, Bot. Ztg., 1872, p. 766; Kny, Die Entw. d. Packeriaceen, 1875, p. 12 (Nova Acta d. Leopold. Acad., Bd. xxxvii); Vöchting, Jahrb. f. wiss. Bot., 1885, Bd. XVI, p. 378.

² Leitgeb, Die Keimung der Lebermoossporen in ihrer Beziehung zum Licht, 1876 (Sitzungsber. d. Wien. Akad., Bd. LXXIV, Abth. 1). Cf. also Goebel, Organography, 1900, I, p. 227.

³ Pfeffer, l. c., p. 94.

⁴ Czapek, Jahrb. f. wiss. Bot., 1898, Bd. xxxii, p. 261.

upper surfaces of the new growths formed from fern prothalli floating on water and illuminated from beneath. Evidently the older tissues exercise in this case no determining influence upon the new growth¹, although a certain directive action may be exercised, which might perhaps suffice to impress the original dorsiventrality upon new growths formed under homogeneous illumination. If any such tendency actually exists it must be very feeble, for a trifling difference in the illumination of the two sides suffices to overcome it. Occasionally rhizoids and sexual organs appear on both surfaces, so that a prothallus might conceivably develop as a bilateral but not dorsiventral structure. The bilateral shoots of *Thuja*, for example, develop equally well when no dorsiventral structure has been induced in their tissues, owing to the removal of the unilateral exposure to which they are normally subjected.

The flattened lateral axes of *Thuja occidentalis* and other Cupressineae branch in one plane and bear scale-like adpressed leaves (Fig. 25, *b*). These form four rows, one dorsal, one ventral, and two marginal. A transverse section of such a twig shows usually a general anatomical arrangement corresponding to that of a dorsiventral leaf, for stomata are present on the shaded under surfaces, and palisade parenchyma is present on the upper surfaces exposed to light. This differentiation is directly induced by the unequal illumination of the two surfaces, and merely covering the upper surface with black cloth is sufficient to reverse the dorsiventrality of the new growths, and to weaken that of the parts which were at the time in process of formation². In this last case the leaf-bases are more affected than the leaf-apices, because in young leaves the apices are in a more forward condition of development than the bases. The twigs of *Biota orientalis* which branch in a vertical plane usually show no dorsiventrality because they are equally exposed on all sides, whereas when subjected to unilateral illumination they also develop the above-mentioned dorsiventral structure³. It is therefore evident that a labile, as in *Thuja* and prothallia, as well as a stable dorsiventrality, as in *Marchantia*, can be induced by the action of external stimuli, and the mode of response of labile organs to inducing stimuli is the same in character as that of those possessing inherent dorsiventrality.

The shoots of *Thuja*, *Biota*, and *Chamaecyparis* are especially instructive, for they show that in them and in cuttings taken from them⁴ the bilateral

¹ Leitgeb, *Flora*, 1877, p. 174; 1879, p. 317; *Sitzungsb. d. Wien. Akad.*, 1879, Bd. LXXX, I, p. 201; Prantl, *Bot. Ztg.*, 1879, p. 697. Bauke (*Bot. Ztg.*, 1878, p. 771; *Flora*, 1879, p. 44; *Sitzungsb. d. Brandenburg. Bot. Vereins.*, 1879, p. 121) erroneously supposed that the dorsiventrality was induced solely by gravity. Leitgeb (*Ber. d. Bot. Ges.*, 1885, p. 169) states that the sporophytic buds of apogamous prothalli also appear on the shaded side.

² Frank, *Jahrb. f. wiss. Bot.*, 1873-4, Bd. IX, p. 147; Pick, *Bot. Centralbl.*, 1882, Bd. XI, p. 440; Czapek, *Jahrb. f. wiss. Bot.*, 1898, Bd. XXXII, p. 268. Anatomical details are given by Klemm, *Jahrb. f. wiss. Bot.*, 1886, Bd. XVII, p. 499.

³ Pick, l. c.

⁴ Mohl, *Vermischte Schriften*, 1845, p. 22. Cf. Frank, l. c., p. 183, footnote.

arrangement is maintained by the influence of the preformed parts, when once the radial structure of the seedling has undergone its ontogenetic conversion into the bilateral arrangement. The radial shoots of seedlings, however, if removed as cuttings preserve their embryonic radial arrangement, owing to the energetic influence of the preformed parts, and in this condition form the plants with radially arranged needle-leaves known as *Retinispora*¹ (Fig. 25, a). These, while retaining their radial character, may even produce occasional flowers and seeds. It is, however, hardly surprising that, especially in old *Retinispora* plants, single or numerous bilateral *Thuja* shoots may appear (Fig. 25, b). Such changes are due to alterations in the internal character, such as occur in a more pronounced degree when a root-apex turns into that of a shoot.



FIG. 25. Branch of *Retinispora* (a, a) with *Thuja* shoots (b, b).

Experiment has shown that cuttings do not always retain the special character of the shoot-system from which they are taken, and this is only to be expected considering the disturbance of the normal correlation produced by the removal. That the radial shoots of ivy seedlings acquire the adult bilateral structure, however, when cultivated separately as cuttings, is a fact well known to gardeners², and without doubt further investigations in this direction would reveal numerous interesting facts.

As in *Thuja*, the plagiotropic position of the lateral shoots of *Taxus baccata*, *Abies pectinata*, *A. canadensis*, &c., provides the condition for the development of the aitionomic dorsiventrality. The buds are at first radial, and may develop into radial shoots when a lateral axis grows vertically upwards to take the place of the decapitated main axis. In the plagiotropic position the orienting growth-movement of the needle-leaves produces a two-rowed arrangement, the lessened growth of the upwardly directed leaves results in a certain anisophylly³, and lastly the stem undergoes

¹ Beissner, *Gartenflora*, 1879, p. 109; *Handbuch d. Nadelholzkunde*, 1891, p. 35; Beyerinck, *Bot. Ztg.*, 1890, p. 517; Goebel, *Organography*, 1900, I, p. 154.

² Beyerinck, l. c., p. 535; Goebel, l. c., p. 161. For other instances see Hoffmann, *Bot. Ztg.*, 1884, p. 214; Büsigen, *Waldbäume*, 1897, p. 224; de Vries, *Die Mutationstheorie*, 1901, p. 32. The condition prevailing at the time of removal naturally influences the subsequent behaviour, so that it is hardly surprising that plants developed from leaves of a *Begonia* which was ready to flower should themselves flower earlier than usual (Goebel, l. c., p. 46). Similar differences were observed by Vöchting (*Jahrb. f. wiss. Bot.*, 1900, Bd. xxxiv, p. 102) in plants developed from cuttings taken at different seasons of the year.

³ Frank, *Bot. Ztg.*, 1868, p. 880, and *Die natürl. wagerechte Richtung v. Pflanzentheilen*, 1870,

more or less hypertrophy¹. In all these cases we are dealing with localized induction, for if a shoot is twisted so that the dorsal side faces downwards the dorsiventrality is reversed². According to Frank the same takes place in darkness, but nevertheless under normal conditions the action of gravity apparently co-operates with that of light in inducing the dorsiventrality³.

The dorsiventrality of the individual needle-leaves of *Taxus* is due to internal causes, as in most foliage leaves, but in *Thuja* we have an instance of local autonomic and labile induction. In the absence of any continued apical growth it is usually impossible to say whether the preformed parts would impress their own arrangement upon the new growths, although this is actually the case in the growing leaf of *Lycopodium*. Little or no such action comes into play during the limited period of growth of flowers, whose symmetry is mainly determined by internal causes. Nevertheless Vöchting⁴ has shown that the dorsiventrality of the flowers of *Epilobium angustifolium*, *Hemerocallis fulva*, and *Clarkia pulchella*, whose primordia are radially arranged, is induced by the action of gravity, whereas in *Amaryllis formosissima* the autonomic dorsiventrality is increased or diminished according to the position of the flower with regard to the earth.

When a primordium grows apically, the apical meristem is subjected to the directive influence of the specialized tissues developed from it. In case this action is exercised only over a short distance it can be eliminated by the interpolation of a small portion of non-dorsiventral tissue. This happens during the development of the gemmae of *Marchantia*, and apparently the stalk of the sporangium of *Selaginella* serves this purpose. If the primordium of a sporangium produces a leafy shoot on a cutting, it probably has the subsequently inherent dorsiventrality induced in it by some external stimulus, such as unequal illumination during the process of conversion⁵. Once the inductive action becomes fixed it acts as though due to internal causes, and hence all side-shoots of *Selaginella* and of *Marchantia* appear as though inherently dorsiventral. Even when the dorsiventrality or polarity is a normal property of the organism, the primary induction may be due to an external stimulus. It then needs in every case to be determined whether the dorsiventrality is not acquired without

p. 22; Kny, Bot. Ztg., 1873, p. 434; Czapek, Jahrb. f. wiss. Bot., 1893, Bd. XXXII, p. 267. On anisophylly cf. also Meissner, Bot. Ztg., 1897, p. 203; 1901, p. 25.

¹ Cf. Czapek, l. c., p. 268.

² As the result of inductive action Kny (l. c.) finds that the anisophylly is not at first reversed when buds expand in an inverted position.

³ Goebel, Organography, 1900, I, p. 251.

⁴ Vöchting, Jahrb. f. wiss. Bot., 1886, Bd. XVII, p. 297; Hildebrand, Ber. d. Bot. Ges., 1886, p. 329 (*Cleome*); Goebel, l. c., p. 111. Differences of illumination may be effective in certain cases.

⁵ Behrens, Flora, 1897, Erg.-bd., p. 163.

the aid of some external stimulus, or whether it is an hereditary property developed under all circumstances, and the external stimulus simply exercises a directive orienting action.

As is generally the case, the same end may be attained in various ways, and a special discussion of the causes influencing symmetrical shape is given by Goebel¹. In the shoots of *Goldfussia anisophylla* and *Centradenia floribunda* the anisophylly is inherent, whereas in *Goldfussia isophylla*, *Centradenia rosea*, and *Selaginella sanguinolenta* it is locally induced and therefore reversible². In *Selaginella Krausiana* the dorsiventrality and anisophylly can only be somewhat weakened by illuminating the ventral surface of the growing apices. The dorsiventrality of many species of *Lycopodium* is however induced by light, while light and gravity combined induce the localized dorsiventrality of *Hedera helix*³. It is however often the case in leaves that pronounced anisophylly, dorsiventrality, and asymmetry are due to internal causes. The same applies to certain inflorescences, whereas in others the dorsiventrality is induced by such stimuli as light and gravity⁴. The rhizome of *Nuphar luteum* is radial when buried in mud, but becomes dorsiventral on exposure to light. The stems of various mosses appear to show all stages of transition from locally to permanently induced dorsiventrality. Various external stimuli, mainly that of light, appear to play a more or less important part in inducing the differentiation of the sporogonium⁵.

Stahl⁶ has observed that unilateral illumination influences the shape of the lichen *Endocarpon* to a remarkable extent, and it would be of interest to know the factors involved in the case of such a symbiotic organism.

SECTION 44. The Induction of Polarity.

Such apolar spherical organisms as *Pleurococcus* and *Micrococcus* have no main axis of symmetry, and even in such cylindrical plants as *Bacillus* or *Spirillum* the opposite poles are similar in character. All the higher plants

¹ Goebel, *Organography*, 1900, I, p. 84 seq.; Wiesner, *Sitzungsab. d. Wiener Akad.*, 1868, Bd. LVIII, I, p. 382; *ibid.*, 1892, Bd. CI, I, p. 694; *Ber. d. Bot. Ges.*, 1895, p. 491; *ibid.*, 1896, p. 180; Frank, *Bot. Ztg.*, 1868, p. 873; *Jahrb. f. wiss. Bot.*, 1873-4, Bd. IX, p. 185; *Die natürl. wagrechte Richtung von Pflanzentheilen*, 1878, p. 34; Pfeffer, *Arb. d. Bot. Inst. in Würzburg*, 1871, Bd. I, p. 77; Goebel, *Bot. Ztg.*, 1880, p. 839; Rosenvinge, *Rev. gén. d. Bot.*, 1889, I, p. 53; Weisse, *Ber. d. Bot. Ges.*, 1895, p. 376; 1896, p. 96; Figdor, *ibid.*, 1897, *Generalvers.*, p. 70; Czapek, *Flora*, 1898, p. 427.

² Wiesner, Frank, and Weisse state that in horizontally placed shoots the leaves on the upper surface are often somewhat smaller than usual.

³ Sachs, *Arb. d. Bot. Inst. in Würzburg*, 1879, Bd. II, p. 257; Czapek, *Sitzungsab. d. Wien. Akad.*, 1895, Bd. CIV, I, p. 41.

⁴ Goebel, *l. c.*, p. 128; Ricome, *Ann. d. sci. nat.*, 1899, 8^e sér., T. VII, p. 293.

⁵ Raciborski, *Flora*, 1894, p. 32; Goebel, *l. c.*, p. 242.

⁶ Wichura, *Jahrb. f. wiss. Bot.*, 1860, Bd. II, p. 197; Goebel, *Flora*, 1895, p. 459; 1896, p. 480; *Organography*, 1900, I, p. 239; Correns, *Bot. Festschrift für Schwendener*, 1899, p. 395.

⁷ Stahl, *Beitr. z. Entwicklung d. Flechten*, 1877, II, p. 18. Observations on the influence of light and other agencies upon the symmetry of algae have been made by Berthold, *Jahrb. f. wiss. Bot.*, 1882, Bd. XIII, p. 569; Noll, *Arb. des Würzburger Inst.*, 1888, Bd. II, p. 472; Reinke, *Ueber Caulerpa*, 1899, p. 57; Goebel, *Organography*, 1900, I, p. 238.

and also most algae are bipolar (verticibasal), and this polarity is exhibited even in the lateral shoots whose bases and apices differ more or less widely¹. As in the case of the transverse polarity known as dorsiventrality, it requires to be determined in each case whether the similar or dissimilar polarity is due to internal or external causes, and whether it is labile or stable in character.

In the equipotential apical meristems of both shoot and root it is the influence of the preformed parts which determines the mode of development, independently of whether a radial arrangement or a labile or stable dorsiventrality results. The cells of the primary meristem cannot possess any inherent polarity, for if they were endowed with a fixed verticibasality like the swarm-spores of *Chlamidomonas*, no such conversion of the growing apex of a root into that of a shoot could take place as actually occurs. That they possess no transverse polarity is shown by the fact that the same group of cambium cells may according to circumstances give rise to the primordium of either a shoot or a root.

The differentiation and division of labour for particular functions involves a certain fixation of polarity, although this is not always externally perceptible. It is best shown when a plant is cut into pieces, each of which strives to replace the missing parts. For in both root and shoot, new shoots tend to be formed at the normally upper end of each, and new roots at the normally lower end, even when the pieces are hung upside down (Fig. 26). Vöchting has hence denoted the respective ends of such pieces

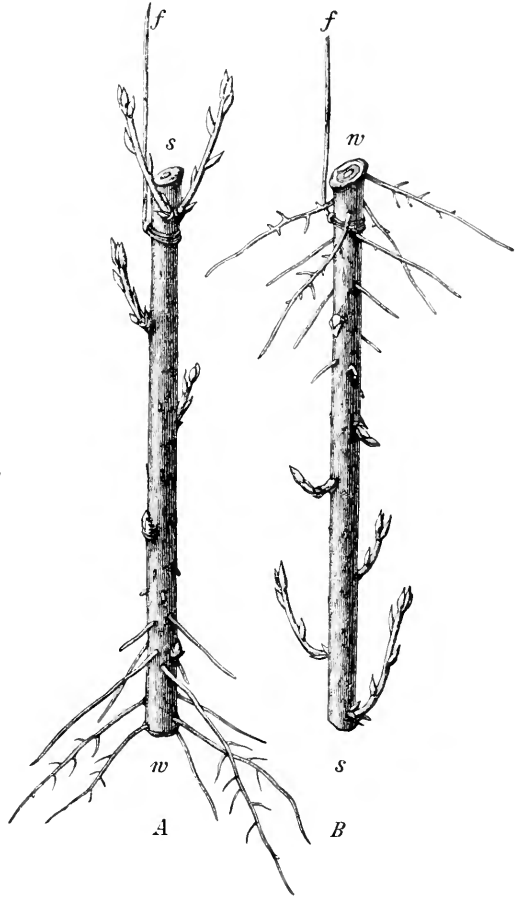

FIG. 26. Stems of *Salix* sprouting in darkness. They are suspended by threads (*f*), *A*, in the normal, *B*, in the inverted position. Even in *B* the shoots are developed at the shoot-pole (*s*), the roots at the root-pole (*w*).

¹ For details see Goebel, *Organography*, 1900, I, p. 64, and with regard to animals, Hertwig, *Lehrb. d. Zoologie*, 1897, 4. Aufl., p. 107.

as root and shoot poles respectively, and we may compare the phenomenon with the behaviour of a magnet when broken into pieces, for each retains a N. and S. pole and these lie at the same ends of each piece. Both root and shoot are so constructed that when inverted they cannot carry on the functions of translocation and correlation as well as normally. This is at once shown by experiments in which the shoot-pole is caused to develop roots, and the root-pole, a leafy axis.

Probably in many cases, especially in plants with little or no tissue differentiation, it will be found that an adult portion of the shoot can serve equally well, when inverted, as a channel of communication between the

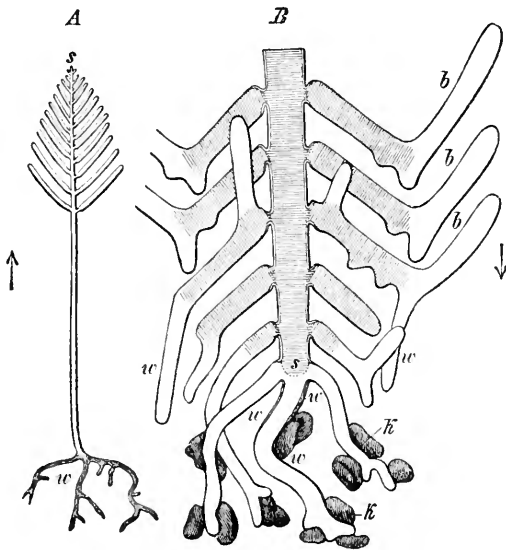

FIG. 27. *Bryopsis muscosa*. A Normally erect plant. B Apex of an inverted plant forming rhizoids. *w* The shaded part was present before inversion, the unshaded grew after it. *k*=sand-grains; *b*=leaf-members; *s*=apex of stem. (After Noll.)

root and upper portion of the plant. Noll¹ in fact finds this to be actually the case in the non-septate plant *Bryopsis muscosa* (Fig. 27), for if inverted, and the stem-apex with the leaf-members near to it buried in sand, they develop into a root-system, whereas from the older leaf-members, from the base of the stem, or even from the roots, the original branching stem-axis is restored. Furthermore such algae as *Spirogyra* and other floating forms have no inherent verticibasality, for they only form attaching rhizoids and exhibit dissimilar poles under special external conditions.

Even in flowering plants the conversion of a root-apex into that of a shoot would probably be a common occurrence were it not for the energetic determining influence exercised by the differentiated tissues.

Flowering plants possess therefore a relatively stable verticibasality, whereas this is extremely labile in *Bryopsis*, and it is hence questionable whether it is stable in the bipolar zoospores of this alga². The asexual zoospores of *Oedogonium* attach themselves by the pigmented end which

¹ Noll, Arb. d. Bot. Inst. in Würzburg, 1888, Bd. III, p. 468. Similar results were obtained with *Caulerpa prolifera* by Noll, l. c., p. 470; Janse, Jahrb. f. wiss. Bot., 1890, Bd. XXI, p. 237; Klemm, Flora, 1893, p. 460; Winkler, Jahrb. f. wiss. Bot., 1900, Bd. XXXV, p. 449; Noll, Ber. d. Bot. Ges., 1900, p. 445. The inductive action is mainly due to light.

² Pringsheim (1871), Gesammelte Abhandl., 1895, I, p. 115.

therefore always develops the attaching organ, but it has not been determined whether this dissimilar polarity is accompanied by a stable physiological verticibasality. The latter is, however, apparently the case in *Euglena* and *Chlamidomonas*, for here the bipolarity seems to be determined during the process of cell-division.

The apparently stable verticibasality of the prothallia of *Equisetum limosum* and *E. variegatum* is according to Stahl¹ induced by light, for the first division-wall is formed at right angles to the incident ray, the exposed cell (*p*, Fig. 28) being the prothallus cell, and the shaded one (*r*) forming the first rhizoid. This differentiation induced by light is necessary for the formation of the prothallus, and the normal development is disturbed when the spores are equally illuminated on all sides.

The protoplasts of many spores are probably either apolar, or possess extremely labile polarity. This might still be the case, even when the germ-tube normally always appears at a certain point, owing to the structure of the external coats. Those pollen-grains in which the exosporium is beset with pores at all points are probably apolar, for the endosporium may protrude at any one of these places.

The ovum of Fucaceae is fertilized outside the oogonium and does not seem to require an orienting stimulus to determine the direction of the first plane of division which marks off the shoot-segment from that of the root. The ova of *Pelvetia canaliculata* and *Ascophyllum nodosum* have, however, no fixed polarity, for the shoot-segment is always the one exposed to light². The ova of *Fucus serratus* are, on the other hand, inherently bipolar, for Rosenvinge was unable to detect any influence of the external conditions upon the direction of the primary divisions.

Nor has it been found possible to alter the direction of the planes of divisions with regard to the archegonium in the ova of ferns³, although Leitgeb found that a slight change was produced in the case of *Marsilea*

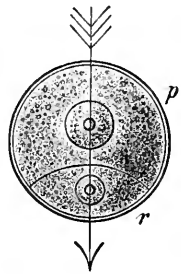

FIG. 28. Germinating spore of *Equisetum*. The arrow shows the direction of the incident rays. (After Stahl.)

¹ Stahl, Ber. d. Bot. Ges., 1885, p. 34; Buchtien, Bibl. bot., 1887, Heft 8; Kny, Ber. d. Bot. Ges., 1896, p. 378.

² Rosenvinge, Rev. gén. d. Bot., 1889, T. 1, p. 126. Farmer and Williams (Phil. Trans., 1898, Vol. CXC, p. 641) doubt whether light exercises any such orienting influence. It is also possible that in some species the distribution of oxygen, or the point of entry of the sperm, may determine the polarity of the morphologically radial ovum. Cf. Behrens, Ber. d. Bot. Ges., 1886, p. 92; Strasburger, Botan. Practic., 2. Aufl., p. 401. See also Roux, Archiv f. mikr. Anat., 1887, Bd. XXIX, p. 157; Winkler, Ber. d. Bot. Ges., 1900, p. 297. In *Cystoseira barbata* unilateral illumination induces the subsequently fixed polarity.

³ Leitgeb, Sitzungsab. d. Wien. Akad., 1879, Bd. LXXX, I, p. 201; Heinricher, Mitth. a. d. Bot. Inst. zu Graz, 1888, Heft 2, p. 239.

by the stimulus of gravity¹. The first division plane is in this case parallel to the long axis of the archegonium, but is always at right angles to the perpendicular when the archegonium is placed in various horizontal positions. The upper segment in this case always forms the shoot, the lower the root, so that the ovum does not possess any fixed inherent polarity within the limits mentioned. Whether the ova of ferns have a fixed autonomic polarity must remain uncertain, for we do not know the extent to which the archegonium and prothallium influence the direction of the first planes of division. Nor is it known whether the egg-cell in the embryo-sac of a flowering-plant is inherently bipolar, or whether like a meristem cell it is radial in character, and has its polarity determined by interaction with its point of attachment, as in lateral shoots and as in the vegetative embryos of *Funkia*. In any case it has not been found possible to alter the normal orientation of the embryo by the action of gravity and other external stimuli².

The above-mentioned polarity is exhibited when roots or shoots are kept under constant external conditions in air saturated with moisture². The polarity of many shoots is hardly at all affected by hanging them upside down, whereas that of others is somewhat weakened. Furthermore, in horizontal pieces of stem, the stimulus of gravity favours the development of shoots from the upper side of the stem-pole and of roots from the under side of the root-pole⁴.

The region of root-production can naturally be caused to shift towards the stem-pole by diminishing the supply of water or of oxygen at the root-pole, and internal factors may also act against the inherent polarity. Thus owing to the special powers of growth at the nodes, the roots and shoots may at first appear at these points, and further, the strongest buds may develop first even when they are some distance from the shoot-pole⁵.

Special internal factors are also responsible for the fact that on portions of

¹ Leitgeb, Sitzungsber. d. Wien. Akad., 1878, Bd. LXXVII, I, p. 222. Figures in Goebel's Outlines, 1882, p. 259. On the influence of gravity on frogs' eggs cf. O. Hertwig, Zelle u. Gewebe, 1898, II, p. 95. Isolated cells with an excentric centre of gravity naturally assume a position, when in water, in which the centre of gravity lies vertically beneath the centre of gravity of the water they displace.

² Vöchting, Jahrb. f. wiss. Bot., 1885, Bd. XVI, p. 393; Schmid, Bot. Centralbl., 1894, Bd. LVIII, p. 1.

³ Vöchting, Organbildung im Pflanzenreich, 1878, I. Theil; 1884, 2. Theil; Bot. Ztg., 1880, p. 593; Jahrb. f. wiss. Bot., 1885, Bd. XVI, p. 370 (*Marchantia*), and 1899, Bd. XXXIV, p. 36; Transplantation am Pflanzenkörper, 1892; Fr. Darwin, Linn. Soc. Journ., 1880, Vol. XVIII, p. 407 (*Rubus*); Wakker, Bot. Centralbl., 1887, Bd. XXXII, p. 238; N. J. C. Müller, Ber. d. Bot. Ges., 1885, p. 159; Kny, Ber. d. Bot. Ges., 1889, p. 201; Rechinger, Verh. d. Zool.-Bot. Ges. in Wien, 1893, p. 310; Prunet, Rev. gén. d. Bot., 1893, T. v, p. 49 (potato).

⁴ According to Vöchting (l. c., 1878, I, p. 26), Kny (l. c., p. 201), Rechinger (l. c., p. 327), the tendency to formation of callus on the root-pole is due to internal causes, whereas Tittmann (Jahrb. f. wiss. Bot., 1895, Bd. XXVII, p. 193) could detect no such dissimilar polarity as regards callus-formation in *Populus pyramidalis*, but found that a trifling difference of pressure sufficed to determine the end at which callus was formed.

⁵ Vöchting, l. c., I, pp. 15, 242; II, pp. 59, 130.

leaves, and of stems with limited growth, not only roots but also shoots may arise at the basal end¹. The purpose of this is obvious in the first case, for the leaf-tissue could hardly serve as a channel of communication between the stem and root.

The same tendency to root or shoot formation is shown not only when an organ is completely separated, but also when the continuity of the bark and phloem is entirely destroyed².

Reversal experiments. Neither stem nor root can carry on its functions so well when inverted as when in the normal position, and this although water and food-materials can pass in both directions in an intact plant. When an inverted stem has been caused to produce roots at the stem-pole and shoots at the root-pole, it never grows well and ultimately dies³. From the literature given by Vöchting it can be seen that it is extremely doubtful whether a tree planted in the inverted position has ever lived for any length of time. Owing to the inherent polarity, inverted pieces of stem strive to produce new shoots from the shoot-pole buried in earth. By removing these shoots Kny succeeded in growing inverted plants of *Hedera helix* and *Ampelopsis hederacea* for four years, at the end of which time it was found that no reversal of polarity had taken place in the new wood and bark formed in the inverted position⁴.

The polarity of cells. The above reactions are due to the influence exercised by the adult tissues upon the growing meristem cells, which are themselves equi-potential. This is at once shown by the fact that in cutting pieces from stem or root any pair of points may be made the stem-pole and root-pole respectively, and thus any group of meristem cells may be caused to develop into either a root or a shoot according to which end of the segment contains them. Although the meristem cells therefore possess no fixed polarity, it has still to be determined whether they are entirely apolar and radial, or whether they possess a labile polarity readily influenced by external stimuli. In any case, however, the interaction with the differentiated cells induces in them local differences and a corresponding definite polarity. It is even possible that this induced polarity may be retained by the cells with greater or less energy, so as to be apparently inherent to them. For example, each new cell of the asomatophyte *Spirogyra* has its main axis of growth and elongation determined by internal causes.

Nevertheless the polarity is only a labile one, for if the filament is unable to elongate owing to its being imbedded in a plaster-cast, the side walls may bulge out wherever any space is available and form a branch at right angles to the original main axis⁵.

A labile polarity will remain fixed so long as the conditions inducing it persist, without the embryonal cells necessarily acquiring any fixed inherent polarity.

¹ Vöchting, l. c., 1878, p. 92; Bot. Ztg., 1880, p. 603; Transplantation, p. 30; Jahrb. f. wiss. Bot., 1885, Bd. XVI, p. 387 (the inflorescence stalk of *Marchantia*).

² Id., l. c., 1878, I, p. 40, &c.; 1884, p. 119; Czapek, Sitzungsab. d. Wien. Akad., 1897, Bd. CVI, I, p. 161.

³ Vöchting, Organbildung, 1878, I, p. 198.

⁴ Kny, Ber. d. Bot. Ges., 1889, p. 201.

⁵ According to the author's hitherto unpublished observations. Cf. also Pfeffer, Druck- u. Arbeitsleistungen, 1893, pp. 240, 385.

Hence although grafts only unite when the root-pole of the graft is joined to the stem-pole of the stock, this does not prove, as Vöchting supposes, that the growing cells of the two parts themselves possess any fixed inherent polarity preventing fusion unless the proper ends are joined¹.

Although we may agree in ascribing a labile polarity to the meristem cells, we have still to learn by what properties and changes in the protoplast this polarity is produced and modified. It is possible that the polarity of the protoplast itself is unchangeable, and that an external stimulus simply causes it to change its axis of polarity with regard to the fixed cell-wall. The same might, however, be equally well attained by an alteration in the internal structure without any movement of the entire protoplast being required. The latter is apparently the case in the swarm-cells of Myxomycetes in which the cilia may arise at different points, thus showing a variable polarity. Probably also the induced polarity of *Spirogyra* cells and of the meristem cells of Phanerogams primarily involves a change in the internal structure of the protoplast.

The origin of polarity. Sachs² supposed that physiological verticibasality was directly due to the vertical position of the plant, being induced by the action of gravity or light. The drooping branches of weeping willows³ and branches kept in inverted positions retain their original verticibasality in spite of the action of gravity⁴. Nor is it surprising that the positively geotropic rhizomes of *Yucca* and *Cordyline* should have the same verticibasality as roots⁵, and therefore when a rhizome of this kind produces a negatively geotropic shoot, it undergoes the same alteration as when a root-apex is converted into a shoot. Geotropism, heliotropism, and polarity are independent properties and may alter independently of one another. Hence it is impossible to say what part has been played by gravity and by light in the phylogeny of polarity⁶.

¹ Vöchting, Transplantation, 1892, p. 149. The corresponding poles of verticibasal swarm-cells fuse during copulation. Vöchting only worked with meristem cells, which owing to inductive action form xylem only internally, although the cambium can actually produce phloem internally. Cf. Vöchting, l. c., p. 146; Beyerinck, Wurzelknospen u. Nebenwurzeln, 1886, p. 11; Frank, Krankheiten d. Pflanzen, 1894, 2. Aufl., Bd. 1, p. 70. Miede (Flora, 1900, p. 113) finds that centrifugal and wound stimuli may cause the mother-cell of the stoma of Monocotyledons to be cut off from the basal instead of from the apical end of the initial cell.

² Sachs, Arb. d. Bot. Inst. in Würzburg, 1880, Bd. II, pp. 469, 484. Cf. Vöchting, Bot. Ztg., 1880, p. 593; Organbildung, 1884, Heft 2, pp. 95, 188.

³ Vöchting, Bot. Ztg., 1880, pp. 598, 605; Organbildung, 1884, II, pp. 95, 188. The same applies to horizontal rhizomes, potato-tubers, and the like. Cf. Vöchting, l. c., and Bibl. bot., 1887, Heft 4, p. 40.

⁴ Vöchting, 1884, l. c., p. 132; Transplantation, 1892, p. 34.

⁵ Sachs, l. c., 1880, p. 475; Vorlesungen über Pflanzenphysiol., 2. Aufl., 1887, p. 536; Vöchting, Bot. Ztg., 1880, p. 601; Organbildung, 1884, II, p. 188.

⁶ Cf. also Vöchting, Transplantation, 1892, p. 158.

PART II

CORRELATION AND REPRODUCTION

SECTION 45. **General.**

The progress of development of each organ and cell must be so directed by its correlative relationships with other parts as to create and maintain the essential harmonious co-operation of the whole¹. Any disturbance must therefore so act as to induce reactions tending to its removal and to the restoration of equilibrium. These self-regulating actions are in constant operation during the normal life-cycle, and are not merely aroused by external stimuli. The reactions to the latter are, however, of importance in affording some insight into the interactions under normal conditions. By analogy with self-regulating machines we can understand that a perceptible reaction may appear only at one point, although the whole organism may be affected by localized stimuli. Finally, correlative influences may affect not only growth, but also the metabolism of growing and non-growing organs.

The most immediately perceptible formative action due to the influence of correlation is the tendency of pieces of stem and root to replace the missing parts. This tendency is made use of in reproducing plants by cuttings, in which productive activities are awakened in special meristematic cells or groups of cells which under the normal relation of parts are kept at rest by functional interaction. This applies to very many of the buds, for if the opening ones are removed the dormant ones begin to develop, and the same occurs when the development of the larger buds is mechanically prevented by the application of plaster-casts². In this way the plant is able to supply any deficiencies, so that a tree acquires fresh foliage when the young leaves are destroyed in spring by frost or insects³. This replacement involves either the awakening of dormant buds, or the immediate development of buds which were beginning to form; and in the latter case the formation of bud-scales may be suppressed or modified. In

¹ The term correlation is used here in the general sense to include all results, whether occurring in the form of growth or of metabolism. A few pronounced growth-correlations were early noticed. Cf. e. g. de Candolle, *Théorie élémentaire*, 1819, 2^e édit., p. 90; *Pflanzenphysiologie*, 1835, Bd. II, p. 333; Knight, *Phil. Trans.*, 1806, II, p. 293. See also Vöchting, *Bot. Ztg.*, 1895, p. 79; Goebel, *Flora*, Erg.-bd., 1895, p. 194; *Organography*, 1898, I, p. 198; Herbst, *Biol. Centralbl.*, 1895, Bd. xv, p. 721.

² Pfeffer, *Druck- u. Arbeitsleistungen*, 1893, pp. 357, 382; Richter, *Flora*, 1894, p. 416 (*Chara*); Hering, *Jahrb. f. wiss. Bot.*, 1896, Bd. xxix, p. 137.

³ A. P. de Candolle, *Pflanzenphysiol.*, 1833, Bd. I, p. 437; Treviranus, *Physiol.*, 1835, p. 299; Nördlinger, *Forstbotanik*, 1874, Bd. I, p. 156; Askenasy, *Bot. Ztg.*, 1877, p. 828; Potonié, *Sitzungsbd. d. Brandenburg. bot. Vereins*, 1880, Bd. xxii, p. 79; Goebel, *Bot. Ztg.*, 1880, p. 804.

the case of cuttings from roots, buds usually only arise when the correlative influence of an existent shoot has been removed.

In the same way the formation of roots or the growth of root-primordia may be induced at certain points in cuttings; and if this is prevented by mechanical or other means, the development may take place at other suitable regions. It is even possible in this way to cause the aërial shoots of the potato and other plants to produce tubers¹. If only a few shoots or roots are allowed to develop, these usually become stronger. Similarly the removal of the apical growing zone of the main axis causes an accelerated growth in the lateral axes, and at the same time so affects their geotropic sensibility that the lateral branches grow obliquely upwards, the lateral roots obliquely downwards, so tending to replace the main axis.

Correlative actions of this kind take place in other organs. Thus the individual foliage leaves frequently become distinctly larger than usual, when only a few are allowed to develop², and Hering observed that the removal or imbedding in a plaster-cast of the large cotyledon of *Streptocarpus* caused the smaller and usually dormant one to develop into the large foliage leaf formed by this plant³. It has already been mentioned that the foliage leaves of certain plants attain a considerable size in darkness, provided those exposed to light are removed. Similarly the stipules of *Faba* become considerably enlarged if the lamina of the leaf is removed at a sufficiently early stage⁴. Further dwarf shoots may elongate to replace the ordinary branches⁵, shoots may be replaced by the development of primordia which normally would form thorns, the assimilatory surface of a leaf may be increased by the conversion of the primordium of a tendril into a leaflet⁶. Lastly, the primordia of bud-scales may develop into foliage leaves if the winter-buds are brought to immediate development⁷.

Since the process of self-regulation involves mutual interactions, a retardation of growth in the shoot involves a slower growth of the root, and vice versa. The same result occurs when the shoot or root-system is entirely or partially removed, and when growth is rendered impossible by imbedding in a plaster-cast. Similarly the removal of the fertilized ovule or ovules inhibits the further development

¹ Knight, Phil. Trans., 1806, p. 298; Vöchting, Bibl. bot., 1887, Heft 4, p. 25; Jahrb. f. wiss. Bot., 1900, Bd. xxxiv, p. 1.

² Goebel, Organography, 1900, I, p. 210.

³ Hering, l. c., p. 142.

⁴ Goebel, Bot. Ztg., 1880, p. 838; Organography, 1900, I, p. 210; Kronfeld, Bot. Centralbl., 1887, Bd. xxxii, p. 363. Boirivant (Ann. d. sci. nat., 1898, 8^e sér., T. vi, p. 393) obtained similar results by removing portions of the lamina.

⁵ Henry, Verh. d. Leopold. Akad., Bd. xi, I, p. 95; Vöchting, Organbildung, 1884, II, p. 5; Busse, Flora, 1893, p. 164; Raciborski, Flora, 1900, p. 29.

⁶ Vöchting, l. c., p. 35; Mann, Metamorphose, 1894, pp. 28, 33.

⁷ On a similar transformation of bulb-scales cf. F. Hildebrand, Bot. Ztg., 1892, p. 32.

of the carpel, and if the growing zone of a seedling-stem has its growth mechanically prevented, the growth of the free apical portion is also considerably retarded¹ (Fig. 29). These correlative stimuli require some time for their action to be completed, and in some cases a transitory retardation may be followed by an acceleration of growth. A slight reduction in the size of the root-system may naturally produce no perceptible effect upon that of the shoot, while the effect of a transitory retardation may be readjusted by a subsequently increased activity of growth².

Self-regulation is possible only when the functions concerned are not engaged to the maximal possible extent, and when the disturbing influence can be equilibrated by the acceleration of certain functions and the retardation of others. Hence it might be expected that growth should be accelerated when a defect was to be repaired, and that a restricted growth in one part should induce a retardation in the growth of related parts. The same end may be attained in various ways, such as by the excitement, acceleration, or modification of growth in an existent organ, or by the induction of new growths. To the latter class belong the healing of wounds, and the re-formation of the cell-wall around naked protoplasts.

All reactions in the last resort involve either a change in the activity of growth and metabolism or in their character, so that it is possible to distinguish between quantitative and qualitative correlative reactions, although no sharp distinction exists between them³. Under certain circumstances one organ may vicariously assume the function of another, as when the suppression of the root-tubers causes a portion of the stem to swell up and become filled with food-materials⁴. It is, however, not uncommonly the case that morphologically similar organs are specially differentiated for different purposes, and that dissimilar organs acquire a close analogy owing to their similarity of function.

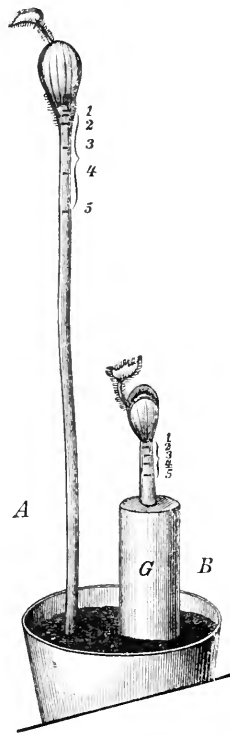

FIG. 20. *Cucurbita pyramidalis*. Of two seedlings of equal size, one (A) grows freely, the other (B) is imbedded in plaster of Paris (G) with the upper 5 mm. of the hypocotyl free. After seven days in darkness the same 5 mm. zone in A has elongated considerably, but in B hardly at all. (After Hering.)

¹ Hering, *Jahrb. f. wiss. Bot.*, 1896, Bd. XXIX, p. 157. [The decreased growth may in part be due to a diminution of the water-supply.]

² Cf. the literature quoted on p. 158.

³ Goebel, *Organography*, 1900, I, p. 207. Goebel applies the term 'compensations' to quantitative reactions, but since we are really dealing with internal phenomena, it is difficult to see any sound basis for Herbst's distinctions between compensations and alterations, terms which apply only to the visible results. (Cf. Herbst, *Biol. Centralbl.*, 1895, Bd. XV, p. 724.)

⁴ Vöchting, *Jahrb. f. wiss. Bot.*, 1899, Bd. XXXIV, p. 77.

Correlative influences play a very important part in the progress of development, and the interactions between the adult and growing parts are such as to result in the maintenance of a certain condition of labile equilibrium. The modification or commencement of any form of activity in one organ may influence other organs as well. This is especially well shown by the influence of the developing embryo upon the ripening carpel and upon the fruit-stalk¹.

Flowering and fruiting involve a certain reduction of vegetative activity, which is therefore favoured by removing the flowers². Conversely, great vegetative activity tends to decrease or suppress the formation of reproductive organs in both higher and lower plants³. Hence in the case of the potato a decreased formation of tubers is accompanied by an increased formation of flowers⁴. It is owing to a reaction directed towards the replacement of missing parts and the performance of a particular function that in *Onoclea struthiopteris* the removal of the foliage leaves results in sterile leaves developing in the place of fertile sporophylls⁵. Similarly such plants as wallflowers can be kept in flower nearly the whole of the year by preventing any formation of fruits.

In the normal progress of development meristematic cells and primordia frequently have their growth temporarily or permanently inhibited, and it is in correlation with the direction of growth to a particular purpose that the sporangiophore of *Phycomyces* almost entirely ceases to elongate during the formation of the sporangium⁶. Correlative repression in many cases goes so far as to cause the death of particular cells and primordia, as for example takes place during the formation of tracheae, and of certain flowers.

SECTION 46. Correlation.

The nature of the reaction affords no criterion as to whether it is directly or indirectly produced in the reacting organ, for a mere change in the tone or activity in the cells abutting upon the reacting organ may produce a pronounced formative effect. A stimulus acting on one cell may affect others, and hence it is impossible always to say whether the

¹ Hofmeister, Allgem. Morph., 1868, p. 634; Reinke, Nachr. d. Ges. d. Wiss. zu Göttingen, 1878, p. 473.

² Mattiolo, Sulla influenza che la estirpazione dei fiori esercita sui bitorzoli radicali, 1900, p. 38.

³ Möbius, Beitr. z. Lehre v. d. Fortpflanzung, 1897, p. 132; Goebel, Organography, 1900, I, p. 182; Müller-Thurgau, Landw. Jahrb., 1898, Bd. XII, p. 57. As regards algae cf. Klebs, Jahrb. f. wiss. Bot., 1900, Bd. XXXV, p. 150.

⁴ Knight, Phil. Trans., 1806, Part II, p. 298; C. Kraus, Forsch. a. d. Gebiete d. Agriculturphysik, 1881, Bd. IV, p. 58; Vöchting, Bibl. bot., 1887, Heft 4, p. 20.

⁵ Goebel, Ber. d. Bot. Ges., 1887, p. 69.

⁶ The growth of *Pilobolus* ceases with the formation of sporangia, and hence continues in darkness, which prevents the production of sporangia.

stimulus acts directly or indirectly upon the organ affected. Whenever a depression of the activity of one organ affects others, we may with some certainty conclude that the influence is exercised indirectly.

Considering the immediate and far-removed actions without regard to the mode in which they are transmitted, but only from the point of view of purpose, it might be expected that remote reactions should be more directed towards the maintenance of a harmonious co-operation between different organs, while reactions in neighbouring parts are of more importance in directing the character and amount of growth. For example, it is the neighbouring tissues which influence the mode of differentiation of the meristems at the apex of root and shoot in Phanerogams and at the growing-point of the thallus of *Marchantia*. It is, however, often the case that a remote correlative effect involves a considerable modification of the shape of the organ affected, as for example when the removal of the primary and secondary axes induces fasciation in *Barkhausia taraxifolia*¹.

Various instances of the complex and often far-reaching reactions and interactions involved in correlation may be given². Thus the stimulus of fertilization causes the development of the embryo, which again causes the carpel to ripen into a fruit, and this may so influence translocation and the processes related to it as to cause changes of metabolism, storage, and growth in far-removed organs such as bulbs and tubers. Similar complex relationships are concerned when a stem is removed whose presence caused certain buds to lie dormant, for influences radiate from the awakened bud, just as they do from the fertilized ovum, tending to produce such changes as are required by the new conditions. As in the above instance, no stimulatory effect can be restricted to the point of application in plants whose protoplasts are in vital continuity, although perceptible results may only appear at the point immediately affected.

Irritability is an essential property of the protoplast, whose vital activity in fact results from the harmonious and self-regulated interaction of its component parts and organs. Observations on plants as well as on the lower animals have shown that irritability and conductivity, and hence also correlation, are not necessarily bound up with the existence of nerves, nerve-centres, and sense-organs. A particular organ, as for example the fertilized ovum, may, however, act as a stimulatory centre, and in general the needs of the organism act as stimuli exciting reactions directed towards their satisfaction. The fact that it is the activity, and not the mere existence of an organ, which is of importance in regulation, is admirably shown by the fact that the same results are produced when the growth

¹ Géneau de Lamarlière, Compt. rend., 1899, T. CXXVIII, p. 160. On fasciation cf. de Vries, Bot. Centralbl., 1899, Bd. LXXVII, p. 289, and the literature there given.

² Pfeffer, Die Reizbarkeit d. Pflanze, 1893, p. 93 (repr. from Verh. d. Ges. deutsch. Naturf. u. Aerzte, 1893).

of a bud is mechanically prevented as when it is removed, if we exclude the effects due in the latter case to the wound-reaction.

Various agencies are employed in correlation, and among these the consumption and distribution of food-materials are included. It is, however, incorrect to suppose that the growth of a dormant bud is prevented by an insufficiency of food¹, for such buds are often stored with food-materials, and begin to shoot when isolated, while, further, a mechanical restriction of growth may induce a retardation of growth in related organs although these have now a greater supply of food at their disposal. Starvation of course ultimately causes a cessation of growth in growing organs, although only when it is far severer than it is ever likely to be in any organ of a well-nourished plant.

Similarly, correlative influences, and not a deficiency of food, determine the early death and emptying of those cells which are converted into tracheae. The same applies to resting buds both in the growing plant and in the seeds, and these may die without ever being awakened. Owing to the non-performance of their functions many petioles die after the removal of the lamina². Further, certain bacteria suppress others, not by devouring all the available food, but by producing special metabolic products which act as poisons to other species.

Functional stimuli. These are concerned in all correlative actions, and not only direct the growth and transformations of cells, organs, and tissues, but may also induce the formation of new organs, such as chloroplastids, which perform a function not hitherto exercised by the young cell or tissue. In this case the function can hardly act as a stimulus to the formation of the organs for its performance, but such a general function as translocation, which is possible in all undifferentiated tissues, may co-operate in inducing the differentiation of vascular bundles which then act as special channels for translocation³. The fact that a realized functional activity may act as a stimulus to further development is a fundamental phenomenon of life, and it is hardly surprising that the effects of such functional activity may spread to other parts and produce in them very varied results.

¹ Vöchting, *Organbildung*, 1878, I, p. 232; 1884, II, p. 113; Th. Hartig, *Bot. Ztg.*, 1862, p. 82; R. Hartig, *Lehrbuch*, 1891, p. 235; Massart, *La cicatrisation chez les végétaux*, 1898, p. 61. The non-development of the terminal buds of *Fagus*, *Ulmus*, &c., is assuredly not directly due to the withdrawal of water from them, as Wiesner supposes (*Bot. Ztg.*, 1889, p. 1). The relative water-supply may, however, exercise a stimulatory effect. Cf. also Goebel, *Organography*, 1900, I, p. 207.

² Jost (*Bot. Ztg.*, 1891, p. 530; 1893, p. 131) and also Busch (*Ber. d. Bot. Ges.*, 1889, *Generalvers.*, p. 29) state that no leaf-trace is formed in the petiole of *Phaseolus* when continuity is broken at a sufficiently early stage. Apparently the translocation between graft and stock determines the differentiation of vascular bundles in the connecting callus-tissue, and so places the vascular systems in direct continuity. The differentiation of the embryo is, however, entirely due to internal causes. For instances of the influence of use upon development cf. Sects. 34, 36, 46.

³ Hertwig (*Zelle u. Gewebe*, 1898, II, pp. 100, 172), Roux (*Gesammelte Abhandl.*, 1895, I, p. 331), and Driesch (*Analyt. Theorie d. organischen Entwicklung*, 1894, p. 62) differ in detail as regards questions of origin.

SECTION 47. **Reproduction and Regeneration.**

During the progress of development the plant not only reproduces the characters of its ancestors, but also needs to replace such temporary organs as leaves, bark, and root-hairs, while the internal life of each protoplast involves perpetual destruction and reconstruction. When missing organs are replaced by new formations, or by the outgrowth of new primordia, we may speak of reproduction, and restrict the term 'regeneration' to cases in which an organ replaces a portion of itself which has been removed¹.

We are not concerned with the details of the remarkable reproductive powers possessed by plants, or the way in which these often lead to various modes of vegetative multiplication². Plant-organs often give rise to dissimilar growths to replace missing parts, and to denote these Loeb has used the term *heteromorphoses*. Thus buds may arise from separated roots, leaves, or even fruits, protonemata from pieces of the leaves or sporogonia of mosses, which under normal conditions would not be the case.

Reproduction is possible only by cells which retain their embryonic character, although a negative result does not always indicate the absence of embryonic cells, for the conditions may be such as to prevent their exercising their powers of growth. Nor will the microscope reveal this property, for many cells which appear to be adult retain their embryonic properties.

Each adult cell of the mycelium of many fungi is capable of reproducing the entire organism³, and to a more limited degree the same power is possessed by the cells of the thallus of *Marchantia* and *Lunularia*⁴. All, or a part, of the leaf-cells of mosses may be capable of producing protonemata, and hence new plants, but usually this only takes place in separated leaves⁵. It is quite possible that the protoplasts of other cells are embryonic, but that their cell-walls are incapable of

¹ Cf. e.g. Frank, *Krankheiten d. Pflanzen*, 2. Aufl., 1895, Bd. 1, p. 90; Hertwig, *Zelle u. Gewebe*, 1898, II, p. 179; Delage, *L'hérédité*, 1895, p. 92. Goebel (*Organography*, 1900, I, p. 42) uses the term 'regeneration' to apply to all cases of repair; Delage distinguishes between regular, normal, or physiological and accidental, abnormal, or pathological regeneration and reproduction.

² Frank, *Krankheiten d. Pflanzen*, 2. Aufl., 1895, Bd. 1; Vöchting, *Organbildung*, 1878, I; 1884, II; *Transplantation*, 1892, p. 145; Wiesner, *Elementarstruktur*, 1892, p. 99; Reehinger, *Verh. d. Zool. Bot. Ges. in Wien*, 1893, p. 310; Tittmann, *Jahrb. f. wiss. Bot.*, 1895, Bd. xxvii, p. 164; Massart, *La cicatrisation chez les végétaux*, 1898; Goebel, *Organography*, 1900, I, p. 41. On adventitious growths cf. Hansen, *Vergl. Unters. über Adventivbildungen*, 1881; Beyerinck, *Ueber Wurzelknospen u. Nebenwurzeln*, 1886; Wakker, *Bot. Centralbl.*, 1887, Bd. xxxii, p. 238; Noll, *Landw. Jahrb.*, 1900, Bd. xxix, p. 395; Heinricher, *Ber. d. Bot. Ges.*, 1900, p. 112; J. Palisa, *ibid.*, 1900, p. 398.

³ Klebs, *Jahrb. f. wiss. Bot.* 1900, Bd. xxxv, p. 180.

⁴ Vöchting, *Jahrb. f. wiss. Bot.*, 1885, Bd. xvi, p. 367; Schostakowitsch, *Flora*, 1894, *Erg.-bd.*, p. 350.

⁵ Heald, *Gametophytic Regeneration*, Leipzig Diss., 1897; Correns, *Ber. d. Bot. Ges.*, 1898, p. 22; *Unters. über Vermehrung d. Laubmoose*, 1899, p. 339.

further growth. Many flowering plants can reproduce themselves from shoots, stems, or roots, and in certain cases a single resting cell may form the starting-point of a bud and hence of an entire new plant. In other plants this power is less highly developed, and hence it is difficult or impossible to reproduce such plants as *Fagus sylvatica* and *Pinus sylvestris* from cuttings.

Fragments below a certain size are incapable of reproducing a new plant, although Rechinger¹ was able to attain this with sections of the root of *Cochlearia armoracia* 1½ mm. thick, and Koch² saw an entire plant produced from a small piece of the suspensor of an *Orobanchæ* embryo. It may even be found possible to obtain an entire flowering plant or moss from a single embryonic vegetative cell, as frequently occurs in Thallophyta. In *Vaucheria*, *Mucor*, and other multinucleate plants a small fragment of cytoplasm, if it contains a nucleus, may reproduce a new plant³. The same power is possessed by nucleated pieces of the zoospores of *Vaucheria*, *Oedogonium*, and other algae⁴, and without doubt the ovum of a flowering plant, like that of certain animals, may be able to develop after the removal of a portion of its cytoplasm. In spite of the minuteness of the ovum, everything necessary for the reconstitution of a new organism must be present in it.

The pronounced power of repair possessed by plants is closely connected with their ability to accommodate their shape to the external conditions. Thus a plant which normally forms a tap-root system may still be able to develop when, owing to the removal of the main root, or to the character of the soil, it is compelled to form a bushy root-system. Similarly the shoot-system may be caused to assume a variety of shapes. In animals with definite shape the power of reproduction is less pronounced, while plants are able to repair damaged organs just as well as are animals.

Thorough regeneration takes place in the root of *Zea Mays*, *Faba*, &c., if the outermost layer of meristem at the apex is removed⁵. If, however, a piece 1 to 3 mm. long is removed from the apex, callus-formation ensues, and one of the lateral roots developed from the callus may replace the primary root so thoroughly that the sympodial character of the new axis is eventually no longer perceptible⁶. If a radicle is severed in half longitudinally, full regeneration occurs

¹ Rechinger, l. c., 1893, p. 321; cf. also Vöchting, l. c., 1878, pp. 37, 73.

² Koch, *Entwicklungsgesch. d. Orobanchen*, 1887, pp. 9, 28, 193. Cf. also Vöchting, *Organbildung*, 1884, II, p. 22, and the literature quoted by Frank, l. c., p. 121, and by G. Haberlandt, *Schutz-richtung d. Keimpflanze*, 1877, p. 79.

³ Pfeffer, *Osmot. Unters.*, 1877, p. 129; Schmitz, *Beobacht. über Siphonocladaceae*, 1879, p. 33 (repr. from *Festschrift d. naturf. Ges. z. Halle*); Hanstein, *Bot. Abhandl.*, 1880, Bd. IV, Heft 2, p. 46; Klemm, *Flora*, 1894, p. 19. On *Mucorineae* see van Tieghem, *Ann. d. sci. nat.*, 1875, 6^e sér., T. I, p. 19.

⁴ Cf. Hofmeister, *Zelle*, 1867, p. 74; Nägeli, *Pflanzenphysiol. Unters.*, 1855, I, p. 174; A. Braun, *Ueber d. Erscheinung d. Verjüngung i. d. Natur*, 1849-50, p. 174.

⁵ Vöchting, *Organbildung*, 1884, II, p. 68.

⁶ Observed by Cisielski, *Beitrag z. Biolog. von Cohn*, 1872, I, Heft 2, p. 21; and studied in detail by Prantl, *Arb. d. Bot. Inst. in Würzburg*, 1874, Bd. I, p. 546.

at the extreme apex, none in the older parts, and partial regeneration in the regions between¹. Similar results were observed by Lopriore on split apices of shoots², which apparently are able to reproduce the extreme growing apex when it has been removed by a transverse section. Beyerinck has in fact observed the regeneration of a bud cut away from *Salix amygdalina*³.

A leaf can apparently develop normally even when a portion of the primordium has been removed, for considerable regeneration occurs when the half of an already enlarging primordium is cut away⁴. Raciborski also observed a regeneration of the forcibly removed apices of the leaves of certain Asclepiadaceae⁵. As in the case of a leaf, when a fern prothallium is sliced in two longitudinally, the symmetry is not restored in the older portions, but only in the new growths formed from the regenerated growing apex⁶. The thallus of *Lunularia* and of *Marchantia* behaves similarly, although the cells at the cut edges of the older parts have actually an inherent power of reproducing the entire thallus⁷.

In certain of the above cases a new epidermis was regenerated, and other instances of this have been observed by Massart (l. c., p. 55), while it takes place normally when the leaves of palms split into segments (Massart, l. c., p. 29). Often, however, and especially in adult organs, no regeneration of the epidermis is possible, but instead it is replaced by cork or similar tissue⁸. A regeneration of the piliferous layer of roots has been observed by Ewart to take place in roots in which the outermost layers had been killed by immersion in a solution of permanganate of potassium, but this occurs only near to the growing apex⁹. Miede has also observed a regeneration of the epidermis on the leaf of *Tradescantia*¹⁰. Living epidermal cells are able to replace the cuticle when it has split off, and a similar replacement may occur in the cells of algae.

The pileus of *Coprinus stercorearius* can be replaced by the growing stipe, if the former has been removed¹¹, and the growing sporophores of various other Hymenomycetes are able to repair small defects or injuries. Similarly a broken filament of *Vaucheria* is able to form a new growing apex at the point of injury,

¹ Lopriore, Nova Acta d. Leopold. Acad., 1896, T. LXVI, p. 211; Ber. d. Bot. Ges., 1892, p. 76.

² Lopriore, Ber. d. Bot. Ges., 1895, p. 410; Schilberszky, Ber. d. Bot. Ges., 1892, p. 424; Kny, Bot. Ztg., 1877, p. 519; Beyerinck, Bot. Centralbl., 1883, Bd. XVI, p. 231.

³ Beyerinck, Wurzelknospen u. Nebenwurzeln, 1886, p. 121.

⁴ Lopriore, Ber. d. Bot. Ges., 1895, p. 411; Beyerinck, Bot. Centralbl., 1883, Bd. XVI, p. 232. Other leaves, including those of mosses, have, according to Massart (La cicatrisation, 1898, p. 23), little tendency to regeneration. K. Müller's statement as to the regeneration of the leaf of *Bryum Billardieri* is to be accepted with caution. According to circumstances, splitting the primordium of a leaf results either in the complete regeneration of each half or in the production of two half-leaves. Half-embryos as observed in animals are less easily produced by the division of a felled plant germ, for the individual cells are so readily capable of separately producing new plants.

⁵ Raciborski, Flora, 1900, p. 10.

⁶ Heim, Flora, 1896, p. 349.

⁷ Cf. Vöchting, Jahrb. f. wiss. Bot., 1885, Bd. XVI, p. 367.

⁸ See also Tittmann, Jahrb. f. wiss. Bot., 1895, Bd. XXVII, p. 150.

⁹ Ewart, Trans. Liverpool Biol. Soc., Vol. VIII, 1894, p. 245.

¹⁰ Miede, Flora, 1901, p. 131.

¹¹ Brefeld, Unters. über Schimmelpilze, 1877, Heft 3, p. 69; Gräntz, Einfluss des Lichtes auf d. Entwicklung einiger Pilze, Diss., 1898, p. 23; Massart, La cicatrisation, 1898, p. 18.

and the outermost segment-cell of *Cladophora* and *Sphacelaria* may take on the functions and character of the apical cell when this has been destroyed or removed¹.

The formation of new xylem on the inner side of a strip of bark and the replacement of a separated strip of the latter are directly due to the activity of the cambium², which is in fact under normal conditions continually producing wood and phloem tissue as the older layers die. No sharp line of distinction can be drawn between regeneration and reproduction, and a particular activity may be regarded as an instance of the one or of the other according to the point of view adopted.

Regeneration seems to be suppressed in certain cases owing to the power of producing new organs possessed by the plant, for it appears to be more economical and preferable in many cases to produce a new organ than to repair an old one. The character of the regeneration depends also upon the nature of the tissue, and it is produced most easily in highly meristematic tissues, and not at all in fully adult ones. In partially embryonic tissues small wounds are readily repaired by secondary callus-formation, which sometimes results in abnormal growths when the wound is very large.

Roux³ applies the term 'post-regeneration' to cases in which a wound begins to heal some time after the injury has been produced, and in which the process of healing often follows an irregular course. The reacting cells here also are embryonic in character, and possibly a certain time is required to awaken them from a labile condition of dormancy induced in them by the previous conditions.

PART III

SYMBIOTIC REACTIONS

SECTION 48. Changes of Shape due to Symbiotic Interaction.

The most varied influences may be exercised by symbiotic organisms on one another, according to the nature of the respective organisms and the character of their relationship⁴. In the case of disjunctive symbionts, the metabolic products of the one may interfere with or suppress the other competing organisms, while in those organisms which survive, pronounced changes of shape may result, such as are produced in fungi and bacteria by the presence of various substances in the nutrient medium.

¹ Cf. Magnus, *Morphol. d. Sphacelarien*, 1873, pp. 13, 18.

² Frank, *Krankheiten d. Pflanzen*, 2. Aufl., 1894, I, p. 70.

³ Roux, *Biol. Centralbl.*, 1893, Bd. XIII, p. 656; *Gesammelte Abhandl.*, 1895, II, p. 894; Driesch, *Analyt. Théorie d. organ. Entwicklung*, 1894, p. 1 seq.

⁴ On various types of symbiosis see Ward, *Annals of Botany*, 1899, Vol. XIII, p. 549.

One of the best instances of the morphological influence of conjunctive symbiosis is afforded by lichens¹, for here two organisms unite to produce another of definite shape. Similarly the parasitic *Accidium euphorbiae* produces peculiarly-shaped stems on the *Euphorbia Cyparissias* attacked by it. This shape is maintained in all new growths reached by the fungal hyphae, so that occasionally an unattacked branch will retain its normal appearance. The witch's broom of the fir due to *Accidium clatinum*, that of *Pteris quadriaurita* due to *Taphrina Laurencia*, and the peculiar growths on the plum due to *Taphrina Pruni*, afford additional instances of the results produced by penetrating fungi². Probably all plants respond more or less to the penetration of fungi, although only an internal change or a slight external one may result³. Localized stimulation results in the formation of various galls, which when produced by animals may be termed zoocecidia, and when by plants phytocecidia, or mycocecidia if due to fungi. These afford good examples of how a special stimulus may result in the production of a definite abnormal shape, or even of metabolic products which are not normally formed. Owing to the action of fungi and of insects upon the primordia of flower-buds, green, doubled, or abnormal flowers may result⁴. Abnormalities of this kind may, however, also occur owing to divergence from the normal course of development, which may be indirectly due to peculiarities in the external conditions.

In some cases of conjunctive symbiosis, the one symbiont lives actually within the protoplast of the other. Thus the galls on *Vaucheria* are produced by a small rotifer which lives inside the cell-filament of this plant⁵. The same applies to the bacteria which live, grow, and divide inside the cells of the root-nodules of Leguminosae. Further, the hyphae of endophytic Mycorrhizae penetrate the living cells of the root, and the small algae which live in the cells of *Hydra viridis*, *Convolvula*, and in certain Radiolaria perform the same function as the chloroplasts in a chlorophyllous plant cell. When such an association is hereditary in character, the peculiarities of shape due to it are permanently retained in the offspring.

¹ Peirce (Proceedings of the Californ. Acad. of Sciences, 1899, I, p. 236; American Naturalist, 1900, Vol. XXXIV, p. 244) regards lichens as an instance of antagonistic symbiosis, but this does not affect our present considerations. The same applies to Mycorrhizae, on which cf. Stahl, Jahrb. f. wiss. Bot., 1900, Bd. XXXIV, p. 618, and also MacDougal, Annals of Botany, 1899, Vol. XIII, p. 41.

² Frank, Krankheiten d. Pflanzen, 2. Aufl., 1894, Bd. I.

³ Wakker, Jahrb. f. wiss. Bot., 1898, Bd. X, p. 87; Molliard, Rev. gén. d. Bot., 1898, T. X, p. 87; Strasburger, Biol. Centralbl., 1900, Bd. XX, p. 657.

⁴ Cf. Goebel, Organography, 1900, I, p. 194; Vöchting, Jahrb. f. wiss. Bot., 1898, Bd. XXXI, p. 470; Peyritsch, Sitzungsber. d. Wien. Acad., 1898, Bd. XCVII, I, p. 597.

⁵ Frank, Krankheiten d. Pflanzen, 2. Aufl., 1895, Bd. III, p. 12; Rothert, Jahrb. f. wiss. Bot., 1896, Bd. XXIX, p. 525.

As in a typical plant, the life and growth of a symbiotic organism result from the interaction of the physiologically and morphologically dissimilar parts with one another and with the external medium. When the symbionts can be cultivated apart, the effects due to their interaction are readily ascertained, and in addition to the general relationships required for maintenance, locally restricted stimulatory actions may be exhibited. The formation of galls is the result of a purely local stimulus, although in the ultimate resort the entire organism is unavoidably affected to a greater or less degree. The development of the egg and larva of the gall-insect is, however, dependent upon the response made by the plant and upon its productive activity. In every case, in fact, reciprocal influences are exercised both here and in cases of disjunctive symbiosis, as when the nutrition and development of a parasitic mycelium is influenced by the character of the tissues of its host. Changes of shape do not, however, always result, and a morphological effect can only be exercised when cells capable of growth or of being awakened to growth are present.

The above instances of symbiosis show that self-regulatory interaction between symbionts involving the maintenance of definite shape is possible without the existence of any interprotoplasmic connexion. Special metabolic products may influence the character and mode of growth to a marked degree, and in fact the shape of certain galls is due to the action of substances excreted by the ovipositor of the gall-insect.

Galls are in some cases produced merely by a local retardation or acceleration of growth, in others by a formation of hairs; they may be closed or open, and frequently are extremely complex in character. A few details may be given here, more especially in regard to the production of galls by the *Cynips* family¹. In this case the gall is produced by the parent insect, which deposits the egg in a particular way upon the surface of the plant or in its tissues. The galls of *Nematus capreae*, which are especially common upon *Salix amygdalina*, are due to the excretion of a drop of slimy liquid into the wound formed by the ovipositor, and this alone is capable of producing a small gall in the absence of the egg. In other cases, however, if the egg is removed or killed, no trace of gall-formation occurs, for the stimulus is here due to the egg, and in part to the developing larva. Since neither the mere wound nor the presence of a dead egg is able to cause the formation of a gall, the stimulus must be due to some metabolic product, temporarily or continuously produced by the egg or by the larva. In the case of *Nematus capreae* this substance is deposited with the egg, and some is

¹ Cf. Frank, *Krankheiten d. Pflanzen*, 2. Aufl., 1894, Bd. III; Eckstein, *Pflanzengallen u. Gallenthiere*, 1891; also Beyerinck, *Beobacht. über Cynipidengallen*, 1882; *Bot. Ztg.*, 1885, p. 304; 1888, p. 1; Ueber Gallenbildung u. Generationswechsel bei *Cynips calicis*, 1896 (repr. from *Verh. d. Koninklijke Akad. d. Wetenschappen te Amsterdam*); Küstenmacher, *Jahrb. f. wiss. Bot.*, 1894, Bd. xxvi, p. 85; Appel, *Ueber Phyto- und Zoomorphosen*, Diss., Königsberg, 1899; Küster, *Flora*, 1900, p. 117; *Biol. Centralbl.*, 1900, Bd. xx, p. 531.

probably also formed by the egg itself, for the gall does not attain its full normal size when the egg is removed.

The enlargement, movements, and gnawing of the larva may also act as stimuli, and these may be of primary importance in certain cases. It is, however, certain that a specific stimulatory substance is not required for each form of growth, for, as we shall see later, dissimilar ends may be attained by the same agency according to its mode of application, the character of the organ affected, and other circumstances. In the case of galls it has not been determined whether different stimulatory substances are produced by the various gall-forming insects.

Since the gall is formed by the plant, it is only natural that those produced by the same insect on different organs or on different plants should exhibit certain dissimilarities¹. Similarly, since different insects exercise unlike stimuli, the galls produced by different insects on the same plant are naturally widely dissimilar. The galls produced by the two life-cycles of such insects as *Cynips calicis* may also differ not only as to their position but also as to their shape and character.

The similar shape of the same kind of gall is an evidence that corresponding conditions existed during development. In the first instance this is due to the deposition of the egg in the same manner, and on similar organs, by a particular insect. Usually this is in young parts, but the galls of *Cynips Reaumuriana* are formed on nearly adult oak leaves, the tissues concerned being awakened to renewed activity. A similar awakening stimulus is necessary to induce the germination of the seeds of *Orobanche* and of the spores of certain parasitic fungi². Moreover the penetration of pollen-tubes may, as in the case of fungal hyphae, act as a stimulus to growth without any fertilizing influence being exercised. This causes the carpels of many plants to enlarge, and Müller-Thurgau³ has in fact found that the penetration of the pollen-tube is required to bring the seedless fruits of certain pears, apples, and grapes to perfection. The same stimulus is required for the formation of the ovules in orchids, and the penetration of pollen-tubes incapable of fertilization suffices for this. Treub indeed found that the same result was produced by the boring of certain larvae into the carpels⁴.

SECTION 49. Grafting and Graft-hybrids.

Many allied plants can be grafted together provided they are capable of maintaining the relationships required for their mutual growth⁵. These relationships must on the whole correspond to those existing between the root and shoot of the intact plant. For example, an insufficient

¹ In regard to gall-mites cf. Frank, l. c., p. 55. On the overlapping of two different galls see Beyerinck, l. c., 1882, p. 173; Küstenmacher, l. c., p. 93.

² According to Bernard (Rev. gén. d. Bot., 1900, T. XII, p. 108) endophytic fungi excite germination in various orchids and lycopods.

³ Müller-Thurgau, Landw. Jahrb., 1898, pp. 25, 61.

⁴ Treub, Ann. d. Jard. Bot. d. Buitenzorg, 1882, T. III, p. 122.

⁵ See Vöchting, Ueber Transplantation am Pflanzenkörper, 1892; Sitzungsber. d. Berliner Akademie, 1894, p. 705. Also Daniel, Rev. gén. d. Bot., 1894, T. VI, p. 5; 1897, T. IX, p. 213; 1900, T. XII, p. 355; Compt. rend., 1897, T. CXXIV, p. 229, and T. CXXV, p. 661; Ann. d. sci. nat., 1898, 8^e sér., T. VIII, p. 1. Cf. also Frank, Krankheiten d. Pflanzen, 2. Aufl., 1894, I, p. 117.

development of the conducting channels at the point of junction would have the same effect as a partial local interruption of these channels in the ungrafted plant. If the graft is only capable of limited growth and development, the root-system of the stock may experience a corresponding decrease in its growth, and vice versa. Thus a pear grafted on a quince stock develops a smaller stem than usual owing to the root-system of a quince being less developed than that of a pear.

The graft and stock mutually influence one another, though usually not to any greater degree than do the corresponding organs of the original plant. The cultivated varieties of apples, gooseberries, and roses preserve their identity as grafts upon different stocks, and this even when several different grafts are transplanted on to the same stock. Similarly potato-tubers develop as usual when shoots of the thorn-apple (*Datura*) are grafted upon the root-stock in place of the potato-shoot.

Nevertheless in some cases changes take place in the colour, taste, or shape of particular organs of one or of both symbionts. For instance, the variegation or albinism of the leaves of a stock of *Abutilon Thompsoni* is often transferred to a graft of this plant having normal leaves. Similarly variegated foliage appeared upon *Althaea officinalis* when a graft was attached to an albinic stock of *Abutilon Thompsoni*. Further, green potatoes become violet when shoots of this colour are grafted upon them¹. In general the results produced are much less prominent than in natural symbiosis. It must, however, be remembered that grafting is only possible in related plants, and for the most part the stimulating interactions need to act across a considerable distance, so that they can only with difficulty overcome the influence exercised upon the growing tissues by those of the same plant immediately abutting upon them. It is, however, possible that in spite of this, reactions may be found to occur in widely removed parts, and this might readily be produced by the agency of some stimulating metabolic product. That metabolic products may pass from one symbiont to another is obvious, and is, for example, shown by the fact that potato-tubers accumulate a certain amount of atropin when the aerial shoot is replaced by a graft of *Datura Stramonium*².

The spot-disease of tobacco leaves seems in fact to be caused by some metabolic product or products, and hence the disease is able to spread from a stock to a graft upon it. Beyerinck³ in fact found that the disease could

¹ Lindemuth, Landw. Jahrb., 1878, Bd. VII, p. 887; Gartenflora, 1897, p. 1; Vöchting, l. c., p. 92.

² Strasburger, Ber. d. Bot. Ges., 1885, p. 39.

³ Beyerinck, Ueber ein Contagium vivum fluidum als Ursache der Fleckenkrankheit der Tabaksblätter, 1898 (repr. from Verh. d. Kon. Akad. d. Wetenschappen te Amsterdam). It is, however, still possible that the disease is due to infection by a micro-organism, for filtration through porcelain under pressure is not an absolutely sure mode of sterilization. Cf. Iwanowski, Centralbl. f. Bact., 1901, 2. Abt., Bd. VII, p. 148.

be produced by injecting the sap of a diseased plant into a healthy one. The same result was produced when the sap was rendered free of germs by filtration through unglazed porcelain, and hence the action is apparently due to some substance of the nature of a ferment, which is destroyed by boiling but not by drying or by alcohol. Beyerinck was, however, unable to produce any variegated foliage upon other healthy plants by injecting them with the sap from albicant varieties. Possibly the mode of exchange or of the application of the stimulating metabolic product may have the same importance as in the production of certain galls.

It is possible that all the observed symbiotic reactions are the result of irritable responses of the symbiont affected, and could be produced in the absence of the exciting symbiont if the required internal and external conditions could be produced by other means. For instance, many plants produce variegated or albino varieties as sports, and since this abnormality is favoured by unusual conditions, it is possible that the abnormal relationship of graft and scion may induce a similar tendency.

Vegetatively and sexually produced variations arise in the absence of any symbiosis, and hence the changes produced by grafting do not necessarily involve the occurrence of any protoplasmic fusion between the graft and stock. This does not even follow when the properties of the one symbiont appear in the other, provided that these peculiarities are ones which the symbiont affected can itself develop under appropriate conditions. All the cases observed hitherto in which the graft and scion have shown a more or less marked tendency to morphological similarity might easily be the direct result of special stimuli which induce the observed changes of shape. If the term hybrid is restricted to the products of protoplasmic fusion, then it is certain that the existence of graft-hybrids, though possible, has not been proved. Only when the meaning of the word is unduly extended to include the transference of such peculiarities as variegation, however such transference may occur, can the existence of graft-hybrids be granted¹.

The differences of opinion as regards the existence or non-existence of graft-hybrids are due mainly to the dissimilar meanings attached to the term and to the varied interpretations given to the facts². Sufficient attention has not been paid to the fact that the power of response may either be very great or extremely limited. It is this limitation which prevents the root-system of *Helianthus annuus* from forming tubers and storing inulin when a shoot of *H. tuberosus* is grafted upon it³. Similarly the root-system of an annual plant cannot be made perennial

¹ Cf. Vöchting, Sitzungsab. d. Berl. Akad., 1894, p. 716.

² Cf. Vöchting, l. c., and Daniell, l. c. (p. 173, note 5). On *Cytisus Adami* Fuchs, Sitzungsab. d. Wiener Akad., 1899, Bd. CVII, I, p. 1273; Beyerinck, Koninklijke Akad. d. Wetenschappen et Amsterdam, 1900, p. 365.

³ Vöchting, l. c., 1894; Daniel, l. c., 1898, p. 147.

by grafting a shoot of a perennial plant upon it¹. On the other hand, the time of flowering of a beet-stem which has not yet flowered may be determined, and hence its duration increased or shortened, according to whether it is transplanted upon an old or young beet-root.

It is owing to the dormant potential powers of the leaf-stalk of *Vitis vinifera* of responding to increased demands that it grows considerably in thickness when a shoot is grafted upon it². The same takes place, according to Carrière, when an orange-shoot is grafted on a leaf-stalk, and the duration of the latter is prolonged³. Such flowering axes as those of *Pelargonium*, which may become converted into a permanent leafy axis capable of growth in thickness⁴, would probably behave in the same manner when a leafy shoot was grafted on them.

Knight, Tschoudy, and Gärtner all showed that in general only closely related plants can be successfully united by grafting. In many cases the shoots, even of the same plant, only unite with difficulty, whereas the potato may have not only various Solanaceae grafted upon it, but even a member of the Scrophulariaceae, *Schizanthus Grahami*⁵. In the case of suitable plants organs of different morphological value may be grafted together, and a piece of root may even be caused to take on the conducting function of the portion of stem it replaces. Vöchting has shown that the union is either incomplete or fails entirely when the graft is attached in an inverted position. This is due to the polarity of the pieces of stem or root employed, for in the inverted position translocatory exchanges are less readily effected. In bud grafting, however, the bundles differentiate in the callus-tissue along a curved path, so that the interpolated piece of bark functions for translocation in the normal direction.

SECTION 50. Details concerning Symbiotic Unions and Interactions.

Lichens, the root-nodules of Leguminosae, the yellow cells of Radiolaria, are all instances of symbiotic association between widely dissimilar organs, whereas in flowering plants grafting succeeds only between closely related organisms. The parasites *Viscum* and *Orobanche*, however, afford instances of symbiotic union between Phanerogams belonging to widely dissimilar families. There is in fact no parallelism between sexual and symbiotic affinity, a principle established by Gärtner long ago for flowering plants⁶.

It can therefore only be determined by experiment whether two

¹ Vöchting, Transplantation, 1892, p. 85. On the union of deciduous and evergreen plants cf. Daniel, Compt. rend., 1897, Bd. cxxv, p. 661.

² Knight, Phil. Trans., 1804, I, p. 189. Cf. Vöchting, l. c., 1892, p. 78.

³ Quoted by de Vries, Jahrb. f. wiss. Bot., 1891, Bd. xxii, p. 49.

⁴ De Vries, l. c., p. 50.

⁵ Noted by Tschoudy in 1819. Cf. also Vöchting, l. c., 1892, pp. 18, 23; Strasburger, Ber. d. Bot. Ges., 1885, p. 34; Lindemuth, Gartenflora, 1897, p. 5; H. Molisch, Bot. Jahrb., 1897, p. 155.

⁶ Gärtner, Vers. u. Beobacht. ü. die Bastarderzeugung im Pflanzenreich, 1849, p. 629; Vöchting, Transplantation, 1892, p. 23.

plants are capable of symbiotic union, and in each case the causes determining the fusion or non-fusion need to be discovered. The same questions apply to the union between plants of the same kind. Thus the hyphae of certain fungi may unite to form a pseudo-parenchyma, whereas those of other fungi and the filaments of most algae remain free even when brought into close contact. These peculiarities are of as great importance in the maintenance of specific shape as are the differentiation and separation of special cells or organs for particular purposes.

In the process of grafting, the formation of wound-callus renders possible the fusion of the cell-walls of the symbionts, but this and also the differentiation and fusion of the vascular bundles take place incompletely in the callus of those plants which are incapable of symbiotic fusion¹.

In nature the symbionts are brought together either accidentally, or by chemical and other orienting stimuli. These play an important part, for example, in the penetration of a plant by the hyphae of parasitic fungi, and possibly also in inducing the fusion of fungal hyphae to form pseudo-parenchyma. Chemical stimuli possibly determine the grouping of the zoospores to form the vegetative network of *Hydrodictyon utriculatum*², or the regularly shaped coenobium of *Pediastrum*³. Furthermore, chemical stimuli are responsible for the attraction of the pollen-tubes and of the antherozoids of certain plants to the ovum.

Attraction does not, however, always result in fusion, for the antherozoids of all ferns are attracted into any ripe fern archegonium, but only those of the same species fuse with the ovum. Further, the maintenance of symbiosis requires the existence of certain affinities between the two organisms, or at least the fulfilment of certain conditions. It must, however, remain uncertain whether these conditions are already represented by the permanent properties of the fusing cells, or whether they are created by functional interaction or by the action of special stimuli. All these factors are variable in character, and hence it is comprehensible that the copulating tubes of *Spirogyra* should fuse, but not the actual filaments, and that in the progress of development particular cells may separate from the rest and be thrown off. A permanent union will naturally be impossible when one organism forms a metabolic product which is poisonous or repellent to the other.

Conjunctive symbiosis may involve either the mere close apposition and growing together of cells, or the penetration of the one symbiont into the protoplasts of the other, or even an actual sexual or asexual fusion between the protoplasts of the two symbionts. Fusion of the cell-walls

¹ On normal fusions cf. Hofmeister, *Allgem. Morph.*, 1868, p. 548; Goebel, *Organography*, 1900, I, p. 51.

² Cf. Klebs, *Bot. Ztg.*, 1891, p. 821.

³ Askenasy, *Ber. d. Bot. Ges.*, 1888, p. 127.

occurs not only in related plants, but also between the algae and fungi of many lichens. Since fungal hyphae and the pseudopodia of Mycetozoa may bore through cell-walls, protoplasmic processes could undoubtedly do the same if endowed with the required solvent or cellulose-softening properties. Even then, however, the two protoplasts would merely come into close contact, and would fuse only when the required affinity existed between them¹. Vöchting assumes that living continuity is attained in all successful grafts, but this is not certain, although it may be required for permanent union². The harmonious co-operation of the two parts does not support this conclusion, for the same is also attained in lichens in which no protoplasmic union of the fungal and algal components appears to take place³. Kuhlmann also states that no protoplasmic connexions exist between *Viscum album* and its host⁴.

A secondary formation of fine protoplasmic connecting threads is as readily possible as the fusion in bulk of protoplasts, which in cell-fusions occurs by the solution and removal of portions of the dividing wall⁵. Even if the protoplasmic connexions persist during cell-division and the formation of the partition-wall, a secondary formation is quite possible, and may occur between graft and stock, or between laticiferous tubes and the cells between which they penetrate. The existence of such connexions, either here or in the case of bast-cells elongating between tissue-cells by sliding growth, has not yet been established. Nor are they theoretically essential, for correlation is possible without them.

Sufficient attention has not been paid to the importance and consequences of the rupture of the protoplasmic connexions, which takes place whenever the cells of a tissue are separated, and hence commonly occurs during the formation of intercellular spaces, for these may appear where pits and protoplasmic threads are present in the walls. A connected question is that as to the existence of extracellular films of protoplasm, which have certainly not as yet been proved to line the intercellular spaces⁶, although extracellular protoplasm is present in ciliated organisms, in Diatoms, and in such Rhizopoda as *Gromia oviformis*⁷.

¹ Noll (Sitzungsber. d. Niederrhein. Ges. zu Bonn, 14. Juli 1897) only observed a conescence of the cell-walls in grafted Siphonaceae.

² Vöchting, Transplantation, 1892, p. 117. The occurrence of hybrids shows that the protoplasts of different species may fuse.

³ Peirce (Proceed. of the California Acad. of Sciences, 1899, 3rd ser., Vol. I, p. 236) states that the fungi send fine processes into the algal cells, like those which *Piptocephalis Freseniana* sends into *Mucor mucedo*. Cf. Brefeld, Bot. Unters. über Schimmelpilze, 1872, I, p. 45.

⁴ Kuhlmann, Bot. Ztg., 1900, p. 51. No protoplasmic connexions exist or are necessary between the endosperm and embryo of a seed.

⁵ On protoplasmic connexions cf. the summary by Zimmermann, Beihefte z. Botan. Centralbl., 1893, Bd. III, p. 328. Also A. Meyer, Bot. Ztg., 1896, p. 187; Ber. d. Bot. Ges., 1897, p. 166; Kohl, Bot. Centralbl., 1897, Bd. LXXII, p. 260; Kuhlmann, l. c.; Kohl, Ber. d. Bot. Ges., 1900, p. 364; Gardiner, Proceed. of the Royal Soc., 1900, Vol. LXXVII, p. 437.

⁶ On extracellular protoplasm cf. Schütt, Jahrb. f. wiss. Bot., 1899, Bd. XXXIII, p. 594; Bot. Ztg., 1900, p. 245; O. Müller, Ber. d. Bot. Ges., 1899, p. 423; 1900, p. 481; Kny, Ber. d. Bot. Ges., 1900, p. 43.

⁷ Hertwig, Die Zelle u. die Gewebe, 1893, I, p. 26.

PART IV

REVIEW OF THE INTERNAL FACTORS DETERMINING SPECIFIC SHAPE

SECTION 51. **General.**

It may at once be admitted that our knowledge in this direction is extremely vague. A point of some importance is, however, that even in a completely homogeneous medium orienting stimuli of internal origin may arise. For example, even in a radially constructed protoplast, lying in water or in air, permanent differences may be maintained between the external surface in contact with the medium and the internal layers. Further, the absorption of oxygen, the evolution of carbon dioxide, and other metabolic processes produce differences of concentration between the interior and exterior, and steady inward and outward streams of nutrient and excrete substances. These differences of concentration may act as internal orienting stimuli just as do those in the external medium which produce chemotropic reactions.

The stimulatory action exercised by the surface-tension film may together with other factors be responsible for the formation of the living and irritable plasmatic membrane. Similarly the cell-wall formed on the exterior of the protoplast is renewed when removed, and since this occurs even when the protoplast is bathed by the cell-sap of the same plant, it is evidently not the quality of the medium, but other factors which are responsible for the non-formation of a cell-wall around the vacuole.

Transpiration and its related processes favour the development of cuticle, and the same factors or contact with air may induce the formation of the conidia or sporangia of certain fungi. We are, however, as ignorant of the connexion between the stimulus and response, as we are of the causes which determine the differentiation of the peripheral layer of meristem into specially shaped epidermal cells, or the reasons for the dissimilar shape of the aërial and aquatic leaves of certain amphibious plants.

Whenever an organism modifies the external conditions locally or generally by growing or moving from one medium to another, we are dealing with an aitiogenic reaction in the results due to the change, just as much as if the changes in the external conditions were produced independently of the organism. In all cases, however, in which, the external conditions remaining constant, a reaction is produced by a change in the properties or irritability of the organism, this reaction is autogenic in character. An instance of the latter is afforded by a curvature of an organ produced owing to a change in its geotropic irritability, and a further one by the movements of naked protoplasts induced by changes of

surface-tension due to the action of the plasmatic membrane or the excretion of metabolic products. Life and growth are in fact only possible when the organism is able to convert the energy and materials derived from without to its own uses. Even in individual cells an inherent polarity or a localized change of whatsoever kind may cause constant external conditions to produce a localized reaction.

The degree to which the external world is used in the manner indicated as a source of orienting stimuli must be separately determined in each case. During ontogenesis such stimuli are apparently often used, although not always in a readily perceptible manner, and it is even possible that in some cases a sense of perception may be active. The directive action of the external world is not, however, a general essential, for the progressive changes involved in development may be automatically produced in regular sequence, and in fact appear mainly or entirely to provide the stimuli to further growth in a definite manner and direction.

Cellular and nuclear division result from internal causes, and it is impossible to say precisely why they occur when a certain definite size has been attained. That a disturbance of the ratio between the bulk of the cell and its absorbing surface is not essential to produce division, is shown by the fact that the cylindrical cells of *Spirogyra*, while retaining the same diameter, divide after they have attained a certain length. It is, however, possible that changes of the ratio between bulk and surface may frequently act as exciting or directive stimuli, and in large organisms the structure and tissue-differentiation is such as to enable the innermost cells to be adequately supplied with oxygen and other food-materials.

Cell-division is a physiological process, and not the direct physical result of surface-tension forces, even although these may be utilized by the protoplast to produce the required results. A living protoplasmic thread of variable thickness, for example, readily resists the surface-tension forces which would cause a free thread of liquid to break up into drops. It is indeed doubtful whether the division even of a naked spherical or ellipsoidal ovum is ever a purely physical process.

The above considerations apply not only to isolated cells, but also to entire plants and their organs. The association of cells, however, produces very complex interactions whose complexity increases with the division of labour and increasing specialization. In the absence of protoplasmic connexions these influences, however complicated, are such as could be maintained by external agencies of suitable character if appropriately applied, whereas the existence of living continuity creates relationships of very special nature. To the first-mentioned class belong more especially the chemical and mechanical effects due to the plant's own activity, and also the influences exercised upon the tissues by the performance of such functions as absorption, translocation, and transpiration. Electric currents of internal origin

may possibly have importance in this respect, whereas the light and heat produced by plants exert a negligible formative influence.

Chemical influences. It has already been mentioned that the distribution of food directly and indirectly affects metabolism and growth, although it is doubtful whether the correlation between shoot and root is maintained in this manner. Specific metabolic products might be employed for this purpose, or the chief part might be played by stimuli transmitted by the interprotoplasmic connexions.

That growth can be influenced by special substances is strikingly evidenced in the formation of galls, and probably tropistic and localized chemical stimuli are frequently employed for the attainment of specific shape. It is, however, incorrect to suppose that a specific stimulatory substance is required for each form of growth, one for a leaf, one for a stem, another for a root, and so on.

Mechanical influences may also act directly or as stimuli, and the internal needs as well as the external demands may contribute towards inducing the development of mechanical tissue. It is further possible that self-regulation involves a power of discrimination between stationary tension and pressure and strains due to movement.

The supply of water affects turgidity, which again exercises mechanical or stimulating influences. Special stimuli may also arise from transpiration, the movements of water, and related factors.

SECTION 52. The Transference of Stimuli.

Symbiotic organisms show that pronounced formative results may be produced without the existence of living continuity, but nevertheless the protoplasmic connexions existing in all vascular plants appear to be of primary importance for the transmission of correlating stimuli, and to be of little or no use for translocation. It can in fact be shown that a naked non-nucleated mass of protoplasm forms a cell-wall around itself if connected with the nucleated portion by a fine protoplasmic thread, whereas the closest contact is insufficient for this purpose when the thread has been broken. The precise importance of living continuity in maintaining correlation during growth and adult life has not yet been determined, but it is at least certain that these cytoplasmic threads may convey stimuli of internal as well as of external origin. The passage of stimuli may be due to either (1) the transference of special stimulating substances, (2) the transference of living particles of protoplasm (pangens), or (3) to the propagation of physical or chemical changes.

A transference of protoplasmic particles is probably of common occurrence, and may take place in the absence of permanent protoplasmic

connexions¹. Possibly special results may be produced in this way by the completion of organs or parts of organs absent from certain protoplasts. It is, however, uncertain to what extent this occurs during normal growth, for the mere awakening of reactions in the protoplast of which it is in itself potentially capable affords no proof.

Further, protoplasmic threads may convey stimulatory or nutrient substance in mass or by diffusion, which could not otherwise pass from cell to cell². It is also possible that the potential differences created by translocation may cause the propagation of chemical or physical actions and reactions which act as stimuli. In all life we are in the last resort dealing with molecular movements, and hence we can in all cases regard stimuli as being transferred by special tonic or molecular vibrations³.

The movement of a cilium after local excitation shows that a stimulus can be rapidly propagated through a thin thread of hyaloplasm. As regards the rapidity of propagation of chemical action, the explosion of nitro-glycerine travels at the rate of 1,300 metres per second, whereas the rapid change of colour produced when yellow iodide of mercury is touched at one point by the red form can be followed with the eye. Similarly when a crystal is placed in a saturated solution, the process of crystallization travels rapidly through the solution, and since this occurs in the finest capillary tube, the reaction can be propagated to a great distance.

A reaction connected with a movement of material would be propagated through a thread of protoplasm or of liquid, if at one end a dissociated ion were continually fixed or removed, and this might be aided by the action of an electric current. A slower diffusion-current would be produced by the continued removal at a given point of any substance generally distributed in solution. In both cases a stimulating effect might be exercised in this way on neighbouring cells, and in fact the metabolism is responsible for numerous regulatory influences.

Probably various modes are adopted for the transference of stimuli even in the same connecting thread. Moreover the properties and conducting power of the threads may vary according to the conditions, and may not be the same in all the threads radiating from a particular cell. Furthermore, the interactions between dissimilar cells and tissues must result in the production of a maze of crossing and fusing messages. It must also be remembered that the result does not depend so much upon the stimulus as upon the properties of the reacting cell or organ, and that even in the individual protoplast the infinite variety of possible combinations of the available means of response may lead to most varied results. We may remind ourselves that different commands may pass through the same

¹ A transference of the nuclei in vegetative cells has been observed by W. Arnoldi, *Flora*, 1900, p. 194. Cf. also Mische, *Flora*, 1901, p. 115; [Farmer, *Nature*, 1903].

² Pfeffer, *Energetik*, 1892, p. 272.

³ Cf. Nägeli, *Theorie d. Abstammungslehre*, 1884, p. 58.

telephone, and that the results they call forth will depend at what point and by whom they are received.

After any irritable response all organisms strive to regain the original condition of equilibrium, and the same is also the case under permanent stimulation, except that a new condition of equilibrium is maintained as long as the stimulus acts. Experiments upon plants have shown that irritable impulses may travel from part to part without the existence of special nerves as in animals. In spite of the fact that nerves, being specialized channels, serve when irritated to call forth definite impulses, it is still unknown by what means a stimulus is propagated in a nerve, for the electrical changes which result from excitation may be merely the result of the chemical changes involved. Even were this known it would be only one special mode of conduction, and the various modes by which stimuli are transmitted through protoplasm would still need to be discovered, for the protoplasmic connexions may be regarded as the first stages in the differentiation of special nerves.

Anatomical investigations give no indication of the function of the interprotoplasmic connexions, but the researches of Townsend carried out at Pfeffer's instigation have shown that certain stimulatory influences are transmitted through the intercellular protoplasmic communications, and through the threads which may connect the pieces of fragmented protoplasts¹. Further researches in this direction would undoubtedly reveal interesting facts as to the rate of propagation, the sphere of influence, and so forth.

The threads above mentioned all consist of ectoplasm, but stimuli emanating from the nucleus or any endoplasmic organ must first traverse the endoplasm, although they are not necessarily conducted equally well in all parts. It is in fact possible that particular stimuli can only traverse special regions of the protoplast or pass more readily in one direction than another. Furthermore, the conductivity can undoubtedly be modified by the external conditions, and is also influenced by the existent arrangement of parts and by functional exercise.

When the nucleus is at one end of the cell, the influences radiating from it will not reach all parts of the cytoplasm at the same time, independently of whether the transference takes place through resting or streaming protoplasm. The velocity and intensity with which a stimulus is transmitted along the long axis of a cell may be favoured by the arrangement of the protoplasmic network, even when the lining layer is also capable of conduction. Further, the absence or deficiency of protoplasmic connexions in the side-walls of cells may cause a tissue to conduct mainly or entirely in the longitudinal direction. Translocation, together with the stimuli due to it, is in fact restricted in a similar manner to particular paths.

Since the protoplasm often develops a fibrillar structure in connexion with other tasks and functions, it is uncertain whether the systems of fibrillae observed by Němec in certain cases are specially adapted for the transmission of stimuli².

¹ Townsend, *Jahrb. f. wiss. Bot.*, 1897, Bd. xxx, p. 484.

² Němec, *Biol. Centralbl.*, 1900, Bd. xx, p. 369; *Die Reizleitung und die reizleitenden Strukturen.*

Since the fibrillae are transitory structures they may favour the transmission of stimuli, and may indeed appear as the result of stimulation, but the best knowledge of the conducting paths will give us no insight into the actual process of conduction.

We are, however, a step in advance when we are able to ascribe the stimulatory effects to the disturbances produced by the metabolism of neighbouring or remote parts, and by the translocation which the metabolism regulates. In this case we know the means by which the potential differences are produced, and it is in the translocatory channels that these differences are propagated. It is often possible that special substances are used to transmit stimuli, and very probably the changes of shape due to symbiosis are largely produced in this manner, by secretions exuded from the cells for particular purposes.

In other cases a chemical or physical change may be propagated in a labile system, and instances of such have already been given. Each such reaction is excited only by one or more definite stimuli. Thus the crystallization of a supersaturated solution may be excited either by contact with a crystalline particle of the same substance or by agitation, a train of gunpowder can be fired by heat, while one of potassium chlorate and sugar can be ignited either by heat or by contact with a drop of sulphuric acid. Hence in a complex living conducting channel, different excitations may excite the propagation of definite stimuli, and so lead to varying results in the end organ.

Stimuli may be transmitted with or without the aid of living continuity, but naturally, whenever the explosive or conducting substances or systems form an inherent part of the protoplasm, they can only pass from cell to cell through the protoplasmic communications. Transmission within the cell is probably for the most part protoplasmic in character, and the effect of a localized orienting stimulus appears to spread over the cell from the part directly affected. The propagation of a stimulus may involve the transmission of living particles, and may also be accompanied by chemical processes, and by electrical changes due to them. Even in the nerves of animals the electrical phenomena occurring on stimulation are probably the result, and not the cause, of the changes involved in the transmission of the stimulus.

Irritability and the conduction of stimuli are closely related phenomena. For example a new condition of equilibrium, reached as the result of stimulation, can only be maintained so long as the stimulus remains constant. Hence when an organ returns to its original condition of equilibrium, we have immediate evidence that the internal or external stimuli concerned have ceased to be transmitted to, or to act upon, the part affected. Owing to the excitement of an opposed reaction, and to the resistance offered to propagation, a stimulus is usually transmitted with decreasing intensity and only to a certain distance, even when propagated by some simple chemical or physical change. The activity of readjustment and repair is such as to maintain the conductivity, even when the conduction of a stimulus involves the consumption of an explosive substance, or the liberation of

potential energy by the conversion of some labile condition of equilibrium into a stable one.

A stimulus which acts in an orienting manner must do so owing to its mode of application and the properties of the organ affected. It is, however, impossible to say how a geotropic excitation or one due to wounding is able to produce a definite curvature in the responding zone, or how correlative stimuli can produce different results at the same point according to their character.

SECTION 53. The Transference of Stimuli (*continued*).

The general importance of irritability and irritable responses has hitherto been hardly sufficiently recognized, largely owing to the fact that undue attention has been paid to the more obvious movements resulting from special stimuli, while the complex and interacting stimuli involved in correlation and co-ordination have been for the most part overlooked¹. Irritable movements usually take place close to the point of application of the stimulus, but in many cases the percipient and responding organs may be some distance apart.

In the sensitive plant (*Mimosa pudica*), for example, a cut made in the stem, or direct stimulation of the main pulvinus of the compound leaf, produces a change of hydrostatic pressure which is propagated to some distance and stimulates successive pulvini. Stimuli are propagated in a similar manner along the staminal filaments of *Cynareae* and *Berberideae* by the tensions exerted by the contracting stimulated cells affecting neighbouring ones, these the next, and so on. In this case, however, the resulting movements of water are insufficient to propagate the stimulus to neighbouring stamens.

Still more important are the stimuli transmitted by vital means from a stimulated root-apex, or from the heliotropically sensitive apex of the first seedling leaf of certain grasses, to the curving zones. Similarly it is by a physiological transmission that stimuli pass from an irritated head of a *Drosera* tentacle to the stalk, where a curvature is produced, and to the other glands, whose secretory activity is excited.

Owing to the variable duration of the latent period of response, it is frequently difficult to exactly determine the velocity of transmission of a stimulus. Transmission by vital means seems, however, to take place but slowly in plants, for geotropic and heliotropic stimuli appear to travel at a rate of not more than one or two millimetres in five minutes in passing from a sensitive apex to the responding region. Ewart has, however, observed that a stimulus exciting streaming had an actual rate of propagation of 1.2 to 0.5 mm. per min. at 18° C., and of 2 to 0.8 mm. per min. at 30° C. through the long axes of leaf-cells of *Vallisneria*, whereas within the long

¹ Cf. Pfeffer, *Die Reizbarkeit der Pflanzen*, 1893 (repr. from *Verh. d. Ges. deutsch. Naturf. u. Aerzte*).

cells of *Chara* and *Nitella* stimuli may be propagated at a rate of 1 to 8 mm. per sec., which is little less than the rates observed in cardiac muscle¹. Correlative stimuli appear to travel with extreme slowness², whereas the mechanical transmission in *Mimosa* may be as rapid as 15 mm. per sec., while in the leaf of *Dionaea* a change of electrical potential may travel at the rate of 200 mm. per sec. Even this is less than the rate of propagation in animal nerves, which may amount to 30 metres per sec., although in certain nerves stimuli travel more slowly. It is evident that no proper co-ordination could be maintained between the various muscles employed in particular movements unless the nerves conducted messages with such rapidity as to bring them all to their destinations at practically the same time. On the other hand, a slow transmission of stimuli is sufficient for the correlation of growth in plants. In a colony of *Volvox*, however, rapid transmission of stimuli is required to ensure the harmonious working of the cilia of the individual cells.

The slow conduction of vital stimuli in most plants is sufficient to show that they are not transmitted by electrical agency, and the fact that a heliotropic stimulus is still able to travel along the seedling leaf of *Avena* when the vascular bundles have been cut across, helps to determine the conducting channels but not the mode of transmission³.

PART V

HYPOTHESES OF ULTIMATE STRUCTURE AND HEREDITY

SECTION 54. Theoretical.

The determination of any factor in the production of specific shape simply reveals an external stimulus to which the plant, organ, or cell responds in a particular manner, and leaves unknown the structure, composition, and properties of the protoplast upon which the power of reaction depends. All attempts to explain the power of reaction of the protoplasm from its structure and properties therefore rest upon a purely hypothetical basis, and it must suffice to give here the essentials of the different theories that have been put forward⁴.

All hypotheses agree in supposing the protoplasm to be composed of minute living particles (Darwin's pangens) which grow and reproduce themselves, and which either directly or after union into larger groups unite to form the protoplasm.

¹ Ewart, *Physics and Physiology of Protoplasmic Streaming in Plants*, 1903, Sect. 47, p. 103.

² Townsend, *Annals of Botany*, Vol. XI, p. 509.

³ The same applies to the conduction of wound-stimuli. Cf. Massart, *La cicatrisation*, 1898, p. 38.

⁴ Details and literature are given by Delage, *La structure du protoplasme et l'hérédité*, 1895; Wiesner, *Elementarstruktur*, 1892; Hertwig, *Zelle u. Gewebe*, 1895, I, p. 267; 1898, II, p. 280.

Apart from details Darwin, de Vries, and Weismann agree in ascribing as many different pangens to the organism (biophores, physiological units, gemmules, determinants) as it has of special organs and properties, whereas Nägeli, Hertwig, and others consider that a smaller number of pangens may be variously grouped and associated together into systems of higher value, and ultimately into protoplasm. In this way as many varied permutations and combinations are possible, as can be formed of words and sentences from the twenty-four letters of the alphabet, or of carbon compounds with oxygen and hydrogen. This view is more in harmony with the facts of development, heredity, and variation, than that of Darwin and Weismann, according to which only such properties and organs can be developed for which an appropriate pangen exists, which when aroused directs and determines the formative result produced. The gap between the two theories is partly bridged over by supposing the specific determinants not to be absolutely stable, or to be an aggregate of pangens formed under the given conditions.

Since the specific determinants can apparently only act as stimuli, the result produced must vary according to the character of the protoplasts affected, and to produce a uniform result they must only be capable of acting when the protoplast is in a specially attuned condition. If, however, the determinants are supposed to be capable of attuning the protoplasts previously to stimulating them, then they have properties possessed by no other living parts, as far as our knowledge goes.

Darwin and Weismann suppose that the stimulating action is due to living particles, specific pangens, which are either awakened from a resting condition in the cell, or wander to it from other cells, whereas Sachs considers that a special stimulating substance produced by metabolism is in each case responsible for the formation of leaf, root, stem, and indeed for every form of growth¹. These leaf-, root-, and stem-forming substances need not, like the specific pangens, be present in the fertilized ovum. Although all vital activity is based upon chemical processes, and although chemical stimuli are of the utmost importance, this theory involves a complete disregard of the mechanism of self-regulation, in which the result is always due to the co-operation of various factors, and in which different combinations including the same factor may lead to widely dissimilar results². Sachs' generalization is based upon a few specially striking instances of response to chemical stimuli, and no evidence has ever been brought forward to prove the existence of the special stimulatory substances postulated by him. Goebel supports Sachs' view, whereas Vöchting and others have shown that none of the instances brought forward by Sachs bear the interpretation attached by him to them³. It is therefore unnecessary to discuss the erroneous supposition that two dissimilar stimulatory substances might be separated by the action of gravity, and so produce the differentiation of stem and root.

¹ This is the later view put forward by Sachs (*Flora*, 1893, p. 236). The earlier view (*Arch. d. Bot. Inst. in Würzburg*, 1880, Bd. II, p. 452; 1882, Bd. II, p. 689) that the formative influence was due to the character of the food requires no discussion.

² Fatigue substances are not necessary for self-regulation.

³ Goebel, *Organography*, 1902, I, p. 202; Vöchting, *Organbildung*, 1884, II, p. 194; *Jahrb. f. wiss. Bot.*, 1885, Bd. XVI, p. 390; 1900, Bd. XXXIV, pp. 83, 107; Reinke, *Jahrb. f. wiss. Bot.*, 1897, Bd. XXXI, p. 262.

The above conclusions are so generalized that, like the gemmule theory of Darwin and the idioplasma theory of Nägeli, they can be at once accommodated to the visible and hypothetical structure of the protoplasm. Weismann and also Hertwig, however, proceed a step further and ascribe primary importance to the nucleus, especially as regards heredity. The protoplast, however, only exists by the union and co-operation of nucleus and cytoplasm, and the latter takes part in all forms of vital activity, and may even predominate in some, such as respiration and absorption. Various authors have recently opposed the predominant value attached to the nucleus by many biologists¹.

Life and growth result from the co-operation of the various parts of the protoplast, some of which are hereditary and always derived from their like, while others may appear as new formations. Hence we may with Driesch say that epigenesis and preformation co-operate in ontogeny, which is in fact an epigenetic evolution². Since, however, we cannot free ourselves from the narrowing tendency attached to such artificial terms, we may disregard them and remember that Nature takes no account of definitions and limitations emanating from the mind of man.

¹ Delage, *L'hérédité*, 1895, p. 743; Driesch, *Archiv f. Entwicklungsmechanik*, 1897, p. 282; 1898, VII, p. 96; Verworn, *Physiologie*, 1897, 2. Aufl., p. 510.

² Driesch, *Analyt. Theorie d. Entwicklung*, 1894, p. 29.

CHAPTER VIII

VARIATION AND HEREDITY ¹

SECTION 55. The Internal Conditions for Hereditary Variation.

EXISTING species are so stabilized that they retain their essential characteristics even under unusual cultural conditions, while the offspring repeat the life-history of the parents when returned to the original conditions. There are, however, exceptions to this rule, for alterations may take place in a particular plant which are handed on to succeeding generations, and may become a fixed hereditary property whether morphological or metabolic in character. The variations observed by us are usually of relatively trifling importance, and do not go so far as to lead to the appearance of an entirely distinct species. Nevertheless the experimental study of variation affords a key to the gradual changes which have peopled the globe with the varied forms of life that now exist or have once existed. We are, however, only concerned with the conditions which favour variation and maintain it when produced, as well as those related facts which have a physiological bearing.

An hereditary variation must arise from some internal change in the protoplast which is transferred by the germinal cells to the offspring, for without these had undergone some permanent change the development would under similar conditions follow the same course as that of the parents. An alteration in any one of the component parts of the protoplast would suffice to produce a recurrent divergence in the ontogeny, but the result affords no evidence as to whether the seat of the alteration lies in the nucleus or in the cytoplasm. Nor need the germinal cells undergo any visible alteration. Indeed the seat and character of the modification in the germinal cells has never been even approximately determined, except in cases where the variation is symbiogenic, that is, produced by the entry and admixture of living material.

The production of hybrids shows that close union may occur between dissimilar living substances to produce a new form ², and possibly hybridiza-

¹ In a recent work by de Vries (*Die Mutationstheorie*, 1901) the subject is discussed in detail. De Vries uses the term 'variability' in a more restricted sense, and distinguishes a sudden variation as a mutation.

² Most hybrids undergo the progressive differentiation towards the parents observed by Mendel in successive generations of fertile hybrids. Cf. *Bot. Ztg.*, 1900, pp. 231, 304; also Correns, *Bot.*

tion plays an important part in the formation of new species. Lichens, however, are organisms which maintain themselves indefinitely by asexual means without any intimate union of the fungus and alga occurring. It is, however, possible that pronounced formative or other changes might result from intracellular symbiosis, such as is shown between certain algae and *Hydra viridis* or Radiolaria. In these cases the algae reproduce themselves, and are transferred to the offspring, so that the symbiosis is permanent. If a bacterium or amoeba entered into symbiotic union with a protoplast, and lost the power of separate existence, it would appear to us to be as much an integral protoplasmic organ as are the chloroplastids which maintain themselves by independent division¹. Further, a new species would probably be produced if a foreign nucleus and cytoplasm could be caused to enter into permanent union.

All variations which are not produced by symbiogenesis must be produced by some change in the organism itself. If this is indirectly due to peculiar external conditions, the variation may be termed aitiogenic, but autogenic if it arises spontaneously. Such changes need not necessarily involve an actual alteration in the germ-plasma, for the appearance of some peculiar stimulating metabolic product which was able to excite its own renewed formation and transference to the offspring, might produce a permanent hereditary variation.

The changes of shape due to symbiogenesis do not necessarily involve any change in the character of the germ-plasm², for on isolation each symbiont follows its original life-cycle. It is often the case that variations may be again slowly deleted by retrogressive modification, whereas others seem to be permanent, although, as in existing species, retrogression or further modification might take place under special conditions.

Many cultural varieties can only be propagated vegetatively, for sexually produced offspring tend to revert to the parent stock. In connexion herewith, it would be of importance to know whether the primary meristems have inherent in them the characters of the cultural variety, or whether these characters are impressed upon the differentiating cells by the preformed ones. To answer this question it would be necessary to develop an entire plant from a single meristem cell, isolated, and hence removed from the influences exercised by adult tissues. Certain facts do, however, seem to indicate that the primary meristem, at least in some cases, has the characters of the race or variety inherent in it. In this case a retrogressive

Centralbl., 1900, Bd. LXXXIV, p. 97; de Vries, Bot. Ztg., 1900, p. 435. [Zenia is the name given when some peculiarity of the pollen-bearing parent makes itself manifest in the seed. Cf. Correns, *Bastarde zwischen Maisrassen mit besonderer Berücksichtigung der Xenien*, Bibl. Bot., 1901.]

¹ Certain diseases are apparently transferred to the offspring by the entry of the parasitic bacteria into the germinal cells.

² Cf., among others, Ortmann, Biol. Centralbl., 1898, Bd. XVIII, p. 142.

modification of the racial peculiarities must take place during the formation of the sexual cells, whereas if the meristem cells merely have impressed upon them the special peculiarities of the adult plant, then the sexual cells and the resultant embryo must be withdrawn from these inducing influences during their growth and development.

It is possible that further differences may exist as regards the propagation of individual peculiarities by different modes of reproduction, and there may be some varieties whose peculiarities are not propagated by all forms of vegetative reproduction. The restriction of the term 'heredity' to sexual propagation is neither possible nor advisable, for by this term we merely indicate that property by which the characters of a plant are repeated in successive generations, and leave entirely undetermined the ways and means by which such repetition is effected. Furthermore, in the case of organisms which reproduce asexually only, we could not speak of hereditary transference at all. In the broad sense, however, an instance of heredity is presented us, when a cultural variety is propagated vegetatively, even though it can also reproduce by sexual means.

The problems of heredity are closely connected with the definitions of species, variety, race, &c.¹, and it has long been recognized that a species has no definite boundaries, but is a conventional expression for a cycle of forms grouped around a type-centre. The explanation of the origin of a plant will not destroy its right to be considered as a distinct species, although it does not follow that a permanent hybrid should be given specific rank, or that the species of lichens have the same value as those of single plants reproducing themselves from single or fused germ-cells.

SECTION 56. Facts concerning Variation.

Disregarding the external or internal mode of origin, we can distinguish between indeterminate, spontaneous, saltatory, or single variations, and gradual, determinate, or adaptive ones. In the second case we may be dealing with the gradual hereditary fixation of some specific reaction, whereas a saltatory variation involves the sudden appearance of some new property in one or a few individuals. Here also, however, the variation is the result of the prevailing conditions, internal and external, and it is readily comprehensible that unusual conditions should excite a tendency to saltatory variation, and hence also to corresponding internal changes. By comparison with machines we can understand that according to the agencies operating, and the organisms affected, the variation may either be restricted to particular individuals, or affect all to much the same degree.

¹ Cf. e.g. Nägeli, *Theorie der Abstammungslehre*, 1884, p. 235; Delage, *L'hérédité*, 1895, p. 627. On 'economic' species cf. Klebahn, *Bot. Ztg.*, 1898, p. 148; Migula, *System d. Bacterien*, 1897, I, p. 222.

The irregular saltatory variations known as sports have long been used as the starting-points in the production of cultural varieties¹, and these may either tend to revert to the ancestral stock, or may become permanent forms capable of vegetative multiplication or even of reproduction by seeds.

That saltatory variations may be inherited is certain, but some authors dispute the heredity of adaptive variations. Too much attention is, however, usually paid to the higher somatic organisms, in which the hereditary transference of acquired somatic characters is rendered more difficult by the fact that they must first be communicated to the embryonic cells. This is not the case in asomatophytes, and in these, by continued cultivation under special conditions, particular variations may regularly appear, and slowly disappear again on returning to normal conditions.

For example, it has been found possible to produce asporogenous races of certain species of bacteria and of Saccharomycetes, while the power of producing poisons or pigments has been permanently eliminated from certain bacteria. In this case a hereditary modification of metabolism has been produced, whereas the loss of the power of spore-formation removes a morphological characteristic of great value in the classification of bacteria.

The variations in question are at first labile, and only gradually acquire a fixed hereditary character, for if after short exposure the organisms are returned to the original conditions, the power of pigment, spore, or poison production either returns at once or in the course of a few generations. In other words, according to the degree of induction, the transitory after-effect requires a longer or shorter time for its removal, and becomes a permanent variation when the labile internal changes are rendered stable. The length of time required for this depends upon the plant, and upon the nature and intensity of the agency producing variation.

Since the colourless and non-poisonous races of bacteria, as well as the asporogenous yeast-forms, retain their peculiarities for years under cultivation, they may be regarded as fixed forms, although a reversion or new variation might occur after a still longer period of cultivation under the same or other unusual conditions. This actually applies to the existent species which have arisen by a series of unknown variations, and in fact it is doubtful whether any species has so fixed a character as to be incapable of variation under all conditions and for all time.

Experiments on asomatophytes can be readily extended over a far greater number of generations than in the case of flowering plants, for

¹ See the works of Darwin, on *Origin of Species*, &c. Also Hofmeister, *Allg. Morph.*, 1867, p. 557; de Vries, *Bot. Centralbl.*, 1899, Bd. LXXVII, p. 327; *Biol. Centralbl.*, 1900, Bd. XX, p. 193; *Compt. rend.*, 1900, T. CXXXI, p. 124; Solms-Laubach, *Bot. Ztg.*, 1900, p. 175; Wettstein, *Ber. d. Bot. Ges.*, 1901, *Generalvers.*, p. 1,184; Beyerinck, *On Different Forms of Hereditary Variation of Microbes*, 1900 (repr. from *Koninklijke Akad. v. Wetenschappen te Amsterdam*).

a bacterium which divides once an hour passes through as many generations in ten days as an annual plant does in 240 years.

Hansen showed that *Saccharomyces cerevisiae*, *S. ellipsoideus*, *S. Pasteurianus*, &c., gradually lost the power of spore-production when cultivated at temperatures at which growth was still possible, but not that of spore-formation. This peculiarity is more readily fixed in some species than in others, and it was not found possible to obtain a hereditarily asporogenous race of *Saccharomyces Pasteurianus*. In other cases, however, the asporogenous character was retained during twelve years' culture¹. It is worthy of note that a power of spore-formation is always latent in fermenting yeast. Hansen has also found that fixed varieties may be obtained differing from the parent form in shape, fermentative power, and so forth. Since pure cultures were used derived from a single cell, it is obvious that the results were not due to the presence of several forms, of which an asporogenous variety gained the upper hand under the special cultural conditions, and finally became the only remaining form². The same applies to results obtained from cultures derived from a single bacterium cell.

Roux³ produced an asporogenous variety of *Bacillus anthracis* by adding a little phenol to the culture medium, while Phisalix obtained the same result by cultivation at 42°C., and under other conditions also⁴. Phisalix found that the power of spore-formation returned at once, or after a few generations, when material cultivated for a long time at 30°C., or for a short time at 42°C., was returned to a lower temperature. The fixed asporogenous variety, however, retained this peculiarity even after its virulence had been restored by passage through the body of an animal. Migula was able to produce an asporogenous variety of *Bacterium ramosum* by continued cultivation in the presence of phenol, but did not succeed with other forms⁵.

In certain bacteria the suppression of the power of pigment or poison-formation is hereditary not only by vegetative, but also by sporogenous reproduction. It is also possible that the power of enzyme production may be eliminated⁶, and conversely Hansen states that varieties of yeast may be raised which have an increased fermentative activity⁷.

Changes of shape may also be rendered permanent in *Saccharomyces* and in

¹ Hansen, Meddelelser fra Carlsberg Laboratoriet, 1896, IV, Heft 2, Résumé, p. 67; Centralbl. f. Bact., 1895, 2. Abth., I, p. 858; 1898, IV, p. 89; 1899, V, p. 5; Compt. rend. d. Laboratoire d. Carlsberg, 1900, T. v, p. 1. Cf. also Klöcker and Schiöningg, Centralbl. f. Bact., 1898, 2. Abth., IV, p. 460, and Klöcker, *ibid.*, 1900, VI, p. 241.

² Beyerinck, Centralbl. f. Bact., 1898, 2. Abth., IV, p. 657; 1897, III, p. 449.

³ Roux, Ann. d. l'Inst. Pasteur, 1890, T. IV, p. 25. See also Behring, Zeitschr. f. Hygiene, 1889, Bd. VI.

⁴ Phisalix, Compt. rend., 1892, T. CXIV, p. 684; T. CXV, p. 253. Cf. also Surmont and Arnould, Ann. d. l'Inst. Pasteur, 1894, T. VIII, p. 817, and the literature quoted by Migula, System der Bacterien, 1897, I, p. 179.

⁵ Migula, l. c.

⁶ Cf. the contradictory statements of Dubourg, Compt. rend., 1899, T. CXXVIII, p. 440, and A. Klöcker, Centralbl. f. Bact., 1900, 2. Abth., VI, p. 241.

⁷ An accommodation and after-effect as regards fermentative activity was observed by Dienert, Ann. d. l'Inst. Pasteur, 1900, T. XIV, p. 139.

cholera bacteria and the pneumonia coccus¹. Villinger obtained a permanently immotile form of the motile *Bacterium coli*², while Wasserzug developed a permanently motile variety of the non-motile *Bacillus prodigiosus*³.

It is uncertain whether an increased power of resistance produced by accommodation to poisons, high temperatures, concentrated solutions, &c., can become hereditarily fixed, for in experiments performed hitherto only a more or less transitory after-effect has been observed. Ray, for instance, observed that in a few successive generations of *Sterigmatocystis alba* certain peculiarities induced by cultivation on a special medium still remained perceptible⁴. Further confirmation is, however, needed for Elfving's statement that a permanent variety of *Eurotium herbariorum* reproducing by yeast-like cells is readily produced⁵.

The embryonic cells of somatophytes are not only influenced by the external conditions, but also by the adult cells and tissues. It is generally agreed that the latter influences may be such as to favour a saltatory variation, but doubt exists as to whether a gradual purposeful change can be directly produced in this way, and whether properties acquired by the somatic parts can become hereditary in the germinal cells⁶. Although botanical evidence points to the possibility of such transference, it must be admitted that the proof is not absolutely certain.

In the growing points of plants, the progress of development is directed by influences radiating from the preformed parts, and hence gradual hereditary fixation is as readily possible here, as it is in asomatophytes by the progressive summation of effects due to unusual but constant external conditions. Somatic properties might also be transferred to the embryonic cells symbiogenetically, that is, by the entry of somatic living particles or determinants. All these considerations apply to the sexual cells which are derived from meristematic apices, although it is possible that the induced conditions might be obliterated during maturation, or that in other cases the germinal cells alone might undergo variation.

The character of the internal changes producing variation are quite unknown, but it may be remarked that the limit between gradual and saltatory variations is an artificial one. For instance, a transitory high temperature may immediately suppress the power of pigment-formation in a bacterium and so produce a sudden variation, which at lower tem-

¹ Cf. Flügge, Mikroorganismen, 3. Aufl., 1896, p. 479.

² Flügge, l. c., p. 489.

³ Wasserzug, Ann. d. l'Inst. Pasteur, 1888, II, p. 82.

⁴ Ray, Rev. gén. d. Bot., 1897, T. IX, p. 283. Errera (Bull. d. l'Acad. royale d. Belgique, 1899, p. 99) observed an after-effect of this kind when *Aspergillus niger* had been grown on concentrated solutions.

⁵ Elfving, Einwirkung d. Lichtes auf Pilze, 1890, p. 134.

⁶ Cf. Hertwig, Die Zelle u. d. Gewebe, 1898, II, p. 237; Delage, L'hérédité, 1895, p. 796; Waldeyer, Verh. d. Ges. deutsch. Naturf. und Aerzte, 1897, p. 81, and the literature there quoted.

peratures is only gradually attained after a long series of generations. Furthermore, an external change may be the outcome of both forms of variation, which alike demand an internal change in the protoplast.

Plants are not all equally capable of variation, whether saltatory or gradual. Nor in asomatophytes can all reactions to changed conditions be permanently fixed by continued culture, and even when this is possible, special conditions may be required. Thus in fermenting yeast the power of spore-formation is never lost, although countless generations may succeed one another without it ever occurring. On the other hand, high temperatures produce an asporogenous variety from non-fermenting yeast. Similarly, if *Mucor* is continually cultivated in yeast-form by growing it in a nutrient medium covered with a thin layer of oil and frequently reinoculating, it never loses the power of forming sporangia and spores when returned to normal conditions.

The fact that a variation capable of hereditary fixation gradually disappears if not sufficiently fixed, does not show that in all cases where an after-effect is shown, it may also be rendered hereditary. Thus the after-effects of accommodation to poisons, high temperatures, and concentrated solutions disappear in the course of a few generations, not only in the case of asomatophytes, but also in that of somatic fungi. Similarly the periodic daily movements of leaves gradually cease in continuous darkness, although generation after generation has repeated the same rhythmic response to daily changes in the illumination. In many cases, however, the yearly periodicity has apparently become hereditary and is impressed upon the seeds, as is instanced by the earlier ripening of corn obtained from northern regions. Seedlings germinated in darkness, however, never show the daily leaf-movements which were performed by the parent with every change from day to night.

The persistence of an after-effect shows that the plant has to overcome a certain internal inertia in accommodating itself to the altered conditions, but in some cases the embryonic cells become rapidly accommodated. A certain plasticity is essential to maintain the inherent character of the species under varying conditions, and is even retained by cells which have undergone considerable specialization but which still remain meristematic. Whenever a new plant is produced by such cells it has the same characters as one produced from typical embryonic cells, but it is difficult to say whether this would be the case if every somatic cell were capable of reproducing a new plant. Supposing a pollen-tube could be caused to grow indefinitely, or even reproduce itself, we should have a plant whose peculiar characters were due to some internal change during the process of maturation. As a matter of fact, however, although pollen-tubes may attain a considerable size on suitable sterile media, death always ultimately supervenes.

Saltatory variations may be more pronounced than the most marked

direct reactions to changed conditions, whereas this is not the case in gradual definite variation, although here also a reaction may possibly be fixed which only takes place under unusual conditions. If a colourless or asporogenous species acquired a power of pigment-production or of spore-formation, a new property would be gained instead of an old one lost, as in the above instances. Further, one slight variation may lead to another, and so on until the plant's life-cycle and power of variation are considerably broadened. This has, however, not yet been attained by experimental means, for the changes due to accommodation are strictly limited by the plant's power of reaction, and this cannot be indefinitely increased even when generation after generation is taxed beyond its limits, as for example by exposure to maximal and supra-maximal temperatures.

Just as a particular demand only awakens certain definite responses, so also does variation usually follow a certain line of development. Thus the asporogenous varieties of yeast do not have their power of growth and of fermentation diminished¹, and the permanent loss of the power of spore-formation by *Bacillus anthracis* does not involve any decrease in its virulence. It is, however, quite possible that a diminished activity of growth may accompany the loss of the power of producing pigments or poisons, and a particular line of variation, disadvantageous to the plant, may lead to an organism becoming incapable of withstanding the struggle for existence in nature. For example, the loss of the power of producing spores is certainly a disadvantage.

¹ Hansen, Centralbl. f. Bact., 1895, 2. Abth., 1, p. 859.

CHAPTER IX

PERIODICITY OF GROWTH

SECTION 57. General.

ALL life is rhythmic in character, each life-cycle being a repetition of a preceding one, and during the progress of the grand period¹ of each individual various periodic movements occur in growing and adult organs. Further, all metabolism consists of rhythmically recurrent processes of anabolism and katabolism. In addition to this autogenic rhythm, regularly repeated external factors may induce a secondary or aitiogenic rhythm, and the phenomena observed in nature are the result of the co-operation of these two forms of rhythm.

Climatic conditions, as well as all external influences due to the organism's own activity², come under the category of external factors. An instance is afforded when a fungus or bacterium, by consuming all the available food or by producing certain metabolic products, ultimately restricts its own development. An autogenic reaction, however, lies before us when some internal change in the organism itself causes a constant external factor to act as a stimulus.

A periodic change in any external factor may not only rhythmically accelerate or retard any vital activity, but may also induce formative changes, as in the case of amphibious plants and of those plants which do not flower in darkness. A periodic movement of the leaves of *Mimosa pudica* is at once produced by stimulation at regular intervals, and in other plants temporary periods of illumination may produce heliotropic curvatures which, during the intervals of darkness, are again neutralized by the action of gravity or by the plant itself. It is also comprehensible that different plants, and different functions on the same plant, should exhibit dissimilar responses to the same agency. Thus darkness accelerates growth, causes photosynthesis to cease, and may, according to circumstances, either leave streaming unaffected or bring about its cessation. Lastly, many algae and fungi are only able to complete their life-cycles when stimulated thereto by changes in the external conditions³.

¹ On the prolongation of life cf. Kerner, *Pflanzenleben*, I. Aufl., Bd. II, p. 448; Hildebrand, *Bot. Jahrb. f. System., &c.*, 1882, Bd. II, pp. 63, 91, 116.

² As also when hyphae or shoots grow from one medium to another and so change their external conditions.

³ Cf. Klebs, *Biol. Centralbl.*, 1899, Bd. XIX, p. 209; *Jahrb. f. wiss. Bot.*, 1900, Bd. XXXV, p. 80; *Ber. d. Bot. Ges., Generalvers.*, 1900, p. 201.

In FUNGI a deficiency of food often excites the formation of reproductive organs, and the same also applies to the spore-formation of bacteria and yeast and to the production of sporangia by Myxomycetes. A similar stimulus is required for the development of the zoospores and oogonia of *Saprolegnia*, of the zygotes of *Basidiobolus ranarum*, and of the fructification of *Coprinus stercorearius*. The utility of this phenomenon is obvious, but a different kind of action must be exercised when certain modes of reproduction are excited in the presence of an abundance of food.

In *Penicillium* and *Mucor* it is the passage of certain hyphae into the air which excites the formation of sporangia, which may be suppressed by keeping the mycelium submerged in a nutrient solution. Similar relationships probably exist in the case of parasitic fungi, and it might be possible under appropriate conditions to grow such fungi entirely vegetatively, or to reverse the normal order of appearance of sexual and asexual reproductive organs¹. This is especially applicable to those metoxenous fungi which complete their life-cycle on different hosts².

ALGAE. Klebs³ has shown that the alternation of generations in *Vaucheria*, *Spirogyra*, *Hydrodictyon*, *Protosiphon*, and other algae is entirely dependent upon the external conditions, which determine whether growth shall be entirely vegetative, or whether sexual or asexual reproductive organs shall be produced. The conditions required differ in different cases, and often involve more than one factor. Stronger illumination is, however, required for sexual reproduction than for the formation of zoospores in *Vaucheria*, or for the vegetative growth of *Spirogyra*. On the contrary, darkness excites the production of sexual organs in *Protosiphon*, and frequently a mere change of conditions often acts as a formative stimulus. *Vaucheria*, for instance, produces zoospores when transferred from moist earth to water. The existent conditions are of great importance, and thus *Spirogyra*, *Oedogonium*, &c., form no sexual organs in a 0.2 per cent. nutrient solution, but do so in water when all the required conditions are satisfied. A similar suppression takes place so long as the water is kept in active movement, and although in this case vegetation is especially vigorous, it does not follow that a retardation of growth will induce the development of sexual organs.

In *ferns* and *mosses* the formation of reproductive organs is influenced by various external factors.

In *flowering plants* the formation of flowers may be suppressed by darkness, high temperatures, and other agencies. In fact the general rule is that vegetative growth is possible within wider limits than is the formation of reproductive organs.

In nature, therefore, the reproduction of algae and fungi is always induced by appropriate changes in the external conditions. In fungi the change is mainly the result of the plant's own activity, as for example when

¹ Cf. Klebs, Biol. Centralbl., 1899, Bd. XIX, p. 214.

² See also Klebahn, Bot. Ztg., 1898, Ref., p. 156.

³ Klebs, Biol. Centralbl., 1899, Bd. XIX, p. 209; Bedingungen d. Fortpflanzung, 1896; Ueber einige Probleme d. Physiol. d. Fortpflanzung, 1895.

the consumption of food or the penetration of hyphae into another medium affords the required stimulus. In algae, however, the stimulation is usually due to such factors as light, water, or temperature, and a regular alternation of generations would be maintained by a constant periodicity of the climatic factors.

In the case of flowering plants, ferns, and mosses, however, even under constant external conditions, the progress of development would ultimately lead to reproduction by sexual or asexual means, or by both. Here the altered conditions which cause the equipotential meristem cells to develop in a special direction are of internal origin, whereas in the algae and fungi mentioned changes in the external conditions are required for this purpose. Here also rhythmical alternation of generations may be possible without any change in the external conditions, especially in the case of the more highly organized Thallophyta. The fact that under certain conditions such organisms as *Vaucheria* only grow vegetatively affords no evidence to the contrary, for the same would apply to those flowering plants which produce no flowers under certain conditions, and in which therefore the change to normal conditions excites the formation of flowers.

The potential powers of a plant are never exercised to their full extent, except by some change in the external conditions, but it is not always the case that, as in fungi, algae, and bacteria, only vegetative growth and only vegetative reproduction take place under constant optimal conditions. Yeast, however, multiplies rapidly during fermentation without ever forming spores, and Klebs¹ was able to cultivate *Saprolegnia* for 2½ years by purely vegetative means. Many mosses and flowering plants have propagated themselves for long periods of time by purely vegetative means, both in nature and under cultivation².

Vegetative reproduction has therefore no weakening effect, and possibly all plants could reproduce themselves for an indefinite length of time without the formation of special reproductive organs³, although these are none the less of importance to secure distribution and maintenance under natural conditions⁴. Vegetative reproduction involves a constant repetition

¹ Klebs, Jahrb. f. wiss. Bot., 1900, Bd. XXXV, pp. 151, 158. Although an organism may grow indefinitely under constant conditions, a change may be of advantage, and may be necessary for the attainment of optimal development.

² Cf. Möbius, Beiträge z. Lehre v. d. Fortpflanzung, 1897, p. 23.

³ Cf. Klebs, l. c., p. 179. Klebs (l. c., p. 161) has also shown that Maupas' experiments do not prove the necessity of conjugation in infusoria.

⁴ Klebs, l. c., p. 179; Möbius, Beiträge z. Lehre v. d. Fortpflanzung, 1897. A plant which under special conditions forms only male or only female flowers does so because certain potential activities are suppressed and others excited or allowed to find expression. In unisexual plants, however, the sex is already determined in the seed and cannot be altered, for it is not certain whether particular conditions induce a predominant formation of one sex (Heyer, Ber. a. d. physiol. Laborat. u. der Versuchsanstalt des landw. Inst. zu Halle, 1884, Bd. 1, p. 43; Fisch, Ber. d. Bot. Ges., 1887, p. 136; Molliard, Rev. gén. d. Bot., 1898, T. X, p. 324; Strasburger, Biol. Centralbl., 1900, Bd. XX, p. 722).

of the division and rejuvenescence of embryonic cells, and these would probably ultimately die if their growth was mechanically prevented.

A preliminary explanation of the phenomena of rhythm is obtained when we can ascribe them to definite powers of reaction possessed by the organism, although such explanation gives us no deeper insight into the vital mechanism. Nor do we exhaust all the possible combinations when we are able to explain certain phenomena as being the result of direct stimulation, or as being due to a change of tone, and others again to correlative reactions. It must further be remembered that an exclusive formation of vegetative organs may result from a deficiency as well as from a superfluity of food, and that restricted vegetative growth need not necessarily induce a formation of reproductive organs.

SECTION 58. The Daily Periodicity of Growth.

The daily changes of illumination induce a periodicity in all functional activities influenced by light. Growth is accelerated by darkness and retarded by light, so that if the opposite sides of a growing shoot respond differently, photonastic movements of nutation are produced daily, whereas the daily movements of adult pulvini are due to the fact that a decrease of illumination produces unequal tendencies to expansion in the upper and lower halves of the pulvinus. The rigidity and tissue-strains in the pulvini of *Phaseolus* and *Mimosa* increase during the night, and G. Kraus¹ has shown that the tissue-strains attain a maximum in growing organs at sunrise, and fall to a minimum at sunset. Further, transpiration, the exudation of water, the opening and closing of the stomata², the movements of leaves and of chloroplastids, all exhibit a daily periodicity. Owing to the dependence of photosynthesis on light, green plants only produce organic food during the daytime, whereas metabolism, to judge from the increased rate of growth and respiration, is usually slightly more active at night than during the day. There is, however, no general tendency to restrict growth and formative activity to the night-time, and in fact the cell-division of *Spirogyra*, the formation of the sporangia of *Pilobolus*, and the elongation of the stipe of *Coprinus* tend to cease at night. In nature other factors modify more or less the periodicity induced by the alternation of light and darkness. In most cases the fall of temperature in the evening retards growth, whereas the increased transpiration during the daytime may cause so pronounced a fall of turgor as to diminish the activity of growth, or even cause it to completely cease. According to the combined effect, growth will either be more active at night or during the day. The former seems to be the case during fine summer days in our climate, for the influence of the rise of turgidity and of darkness on growth then surpasses the retarding

¹ G. Kraus, Bot. Ztg., 1867, p. 122; 1871, p. 371.

² Fr. Darwin, Phil. Trans., 1898, Vol. cxc, pp. 587, 619.

effect of the lower temperature. During cold, clear nights, however, the reverse may be the case.

Duchartre¹ found that the growth in length of various shoots was greater during the night than during an equal period of daylight, and was in some cases two or three times as rapid. An increased rate of growth in thickness of trees was observed by Friedrich² at night-time and by Kraus³ in fruits and fungi.

Rauwenhoff⁴, however, found that from June to October, about one-third more growth took place during the twelve hours between 6 a.m. and 6 p.m., than during the following twelve night hours. Similarly in alpine regions the nights are so cold that growth is much retarded. On the contrary, submerged plants, and also subterranean organs, are subject to a lesser fall of temperature at night-time. Hence the different organs of the same plant may exhibit dissimilar periodicities, while reference to Fig. 30 will show that a slight fall of temperature at evening is insufficient to counteract the accelerating action on growth of the increased turgidity and diminished illumination.

The course of the periodic curve not only shows variations due to the external factors, but may also be modified by the reactive power of the plant, by the after-effect of the previous conditions, and also by autonomic oscillations. The latter may still occur when all the external factors excepting the illumination are kept constant, and hence although the curves obtained by Sachs⁵ and by Baranetzky⁶ show a general resemblance they differ in detail. In many plants, such as *Dahlia variabilis*, the maximum elongation occurs in the early morning hours, the minimum in the evening, whereas in other plants these cardinal points are displaced until in extreme cases the maximum occurs at midday, the minimum after midnight.

The secondary maxima and minima due to autonomic oscillations are never entirely absent, although in some plants Baranetzky found they were more conspicuous than in *Dahlia variabilis*, in others less so⁷. In the curve given, however, the oscillations were partly due to variations in the external conditions, which were not kept as constant in Sachs' experiments as in those by Baranetzky. In the curve constructed from the averages for every three hours, the secondary oscillations are less pronounced.

The daily periodicity of growth is apparently produced in the same

¹ Duchartre, *Compt. rend.*, 1866, 6 avril, p. 815. G. Kraus (*Ann. d. Jard. Bot. d. Buitenzorg*, 1895, T. XII, p. 203) observed the same on plants of *Dendrocalamus* growing in Java. Cf. also Kirchner, *Bot. Ztg.*, 1878, p. 28.

² Friedrich, *Bot. Ztg.*, 1897, p. 369.

³ G. Kraus, *Sitzungsb. d. naturf. Ges. z. Halle*, 1880, p. 94; Schmitz, *Linnaea*, 1843, Bd. XVII, p. 464.

⁴ Cf. Sachs, *Arb. d. Bot. Inst. in Würzburg*, 1872, Bd. I, p. 190.

⁵ Sachs, *Arb. d. Bot. Inst. in Würzburg*, 1872, Bd. I, p. 99.

⁶ Baranetzky, *Die tägl. Periodicität im Längenwachsthum*, 1879 (repr. from *Mém. d. l'Acad. d. St.-Pétersbourg*, 7^e sér., Bd. XXI).

⁷ Cf. also G. Kraus, *Ann. d. Jard. Bot. d. Buitenzorg*, 1895, T. XII, p. 203.

manner as are nyctitropic movements. These are partly the result of corresponding accelerations and retardations of growth, and are partly due to variations of turgor, but do not involve an inherited tendency to periodicity. They cease gradually in fact under continuous illumination, whereas autonomic movements having a periodic rhythm of from one to a few hours are exhibited to a marked extent by some plants, but to a less degree by others. If such a plant is now placed in darkness, a nyctitropic

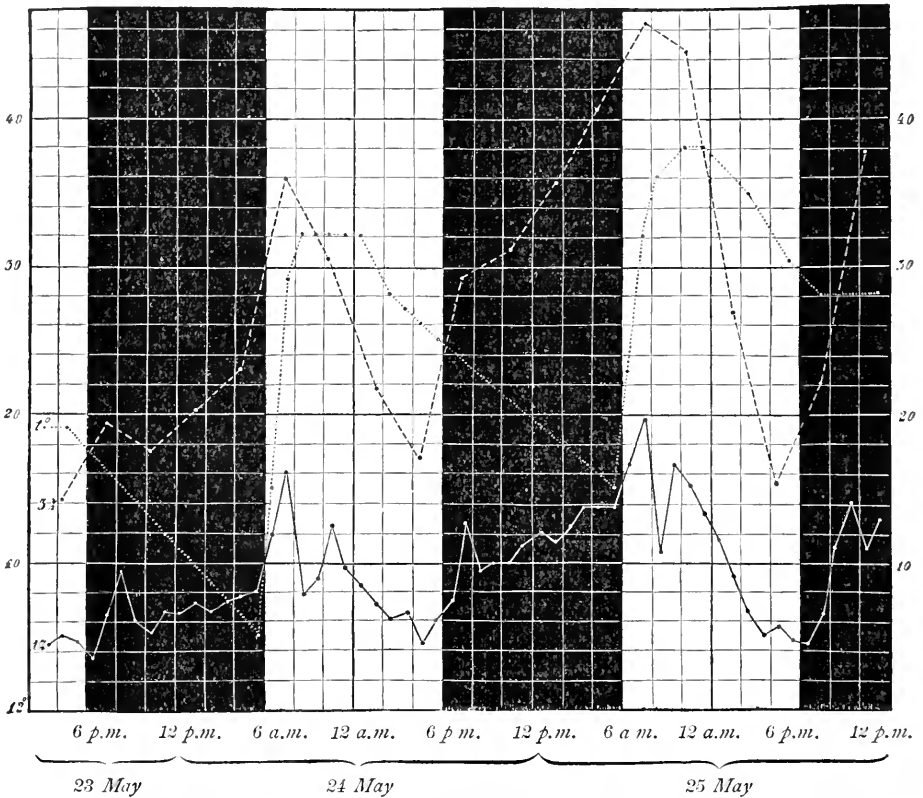

FIG. 30. Daily curve of growth of a stem of *Dahlia variabilis* (after Sachs). The growth was registered by a lever magnifying twelve times, and each mm. growth in length is represented by a 2 mm. ordinate. The curve $l'z$ is constructed from hourly, that marked lz from tri-hourly observations. The curve $l'z$ gives the temperatures, which begin at 13.0° R. Each square has a side of 4 mm.; each Réaumur degree covers 2 cm. (5 squares). The dark areas represent the night periods.

movement ensues which is repeated a few times with gradually decreasing intensity. Under normal conditions this after-effect, together with the repeated daily stimulation, gradually brings the periodic daily movements into play with their full amplitude. In darkness, however, the cumulatively induced daily periodicity gradually disappears in from a few days to a fortnight according to the plant examined.

Similar relationships probably apply to the induced periodicity of

growth, for Sachs¹ and especially Baranetzky found that it persisted for a time in darkness. Baranetzky observed that the after-effect disappeared in a few days in shoots of *Gesneria tubiflora*, whereas in those of *Helianthus tuberosus* a daily periodicity was still perceptible after 14 days in darkness. The same author could detect no daily periodicity in shoots of *Helianthus* grown from the tubers in darkness, and Godlewski² made similar observations on seedlings. Autonomic variations are shown, however, and when these have a long period, they are not easy to distinguish from the daily variations in the growth-curve. Baranetzky in fact observed that certain, though not all, of the shoots produced in darkness from a tuber of *Brassica Rapa* exhibited a periodicity of growth resembling the daily one, an observation which seemed to point, in the absence of the above explanation, to a transference of a daily periodicity from the tuber to the shoots.

Neither the daily periodicity of growth in length nor that of nyctitropic movement is therefore hereditary in character, but simply due to the cumulative effect of regularly repeated stimuli upon organisms capable of response. The periodicity induced by this cumulative after-effect probably extends itself to a certain extent to all processes related to growth, including the tissue-strains and the opening and closing of the stomata. Many questions in regard to the origin of daily periodicity still require solution by experiment. It is, for example, uncertain whether rhythmic changes of temperature or of turgor under constant illumination could produce by their after-effect a periodicity similar to that induced by the alternation of night and day, and also whether the progress of the after-effect is determined by the variations of growth actually attained, or by a combination of factors. In the latter case the curve in Fig. 30 would show, as an after-effect of the previous exposure, a minimum growth at night-time instead of during the day. Only direct experiment can answer this question, and determine whether the after-effect follows the same course as the original curve, or whether the after-effect of the changes of illumination predominates.

Historical. The daily periodicity of growth as shown in darkness and under constant external conditions was first closely studied by Sachs³, who also criticized the earlier observations of Meyer, Mulder, Harting, Caspary, and Rauwenhoff, in which few or no precautions were taken to maintain constant conditions as regards temperature, moisture, &c. Baranetzky⁴, like Sachs, employed a self-registering

¹ Sachs (Arb. d. Bot. Inst. in Würzburg, 1872, Bd. 1, p. 167) inclined to regard the after-effect as being due to the entry of light, whereas Baranetzky found that it is still shown when a little light is admitted so as to act against the periodic acceleration.

² Godlewski, Anzeiger d. Akad. d. Wiss. zu Krakau, 6. Juni 1889.

³ Sachs, l. c., p. 99.

⁴ Baranetzky, Die tägl. Periodicität im Längenwachsthum, 1879 (repr. from Mém. d. l'Acad. d. St.-Pétersbourg, Bd. xxvii); Vorläuf. Mittheil., Bot. Ztg., 1877, p. 639. Drude (Die Biologie von Monotropa, 1873, p. 58) made some observations on *Monotropa*.

auxanometer and still further extended our knowledge as regards the periodicity of the growth in length of stems. Reinke¹ and Friedrich² obtained similar results as regards growth in thickness, while Prantl³ and Stebler⁴ have extended these observations to the leaves of various plants. Strehl⁵ found that the root of *Lupinus albus*, and Macmillan⁶ and Golden⁷ that the tuber of the potato, also exhibit a daily periodicity of growth, which, when these are kept in equally moist soil at constant temperature and in darkness, must be due to interaction with the aerial organs. Fungi appear also to show a daily periodicity of growth, but the after-effect has not yet been determined.

The detailed course of the daily period of growth differs according to the plant examined, even when all factors, excepting the daily illumination, are kept constant. The growth of many plants is only slightly increased by the absence of light, whereas that of others is considerably increased. Furthermore, the latent period of stimulation may either be short or of considerable length. In slowly reacting plants the maximum growth may occur at midday, the minimum after midnight, since the retarding effect of light and the accelerating action of darkness take some time to act. The after-effect follows a similar course to the primary one, although, under continuous illumination or darkness, the curves not only diminish in amplitude, but may also be somewhat modified. Darkness, however, produces a greater effect when applied during the period of increasing growth, than when it is decreasing, for in the former case the direct effect co-operates with the induced rhythm, but in the latter case antagonizes it. A similar antagonism takes place when the periods of darkness and illumination are reversed, and ultimately the rhythmic periods are transposed by twelve hours. As regards the confusing effect of other factors, it should be remembered that growth responds very rapidly to changes of temperature. As regards the internal processes involved nothing can be said, for we are entirely ignorant as to the mode of action of light, as to how its after-effect is produced.

SECTION 59. The Yearly Periodicity.

In temperate climates plants exhibit a pronounced yearly periodicity due to the alternation of a period of activity in summer with a resting one in winter. This is in the first instance due to the low temperature during winter causing a complete or partial cessation of growth, although many plants so regulate themselves that an interval of rest follows each period of activity. The latter is of use in preventing such plants from unfolding their leaves

¹ Reinke, Bot. Ztg., 1876, p. 148.

² Friedrich, Bot. Ztg., 1897, p. 369.

³ Prantl, Arb. d. Bot. Inst. in Würzburg, 1873, Bd. I, p. 371.

⁴ Stebler, Jahrb. f. wiss. Bot., 1878, Bd. XI, p. 47. Cf. Vines, Arb. d. Bot. Inst. in Würzburg, 1878, Bd. I, p. 128. For observations on the leaf of *Victoria regia* see Caspary (Sachs, l. c., p. 187) and Drude, Nova Acta d. Leopoldin. Academ., 1881, T. XLIII, p. 247.

⁵ Strehl, Unters. ü. d. Längenwachstum d. Wurzel u. d. hypocotylen Gliedes, 1874, p. 19.

⁶ Macmillan, American Naturalist, 1891, p. 462.

⁷ Golden, Bot. Centralbl., 1894, Bd. LIX, p. 169.

too early in the year, when a few warm days occur in winter. The details concerning the relationships between climate and periodicity belong more especially to the geography of plants, so that in the following general discussion of automatic periodicity we can confine ourselves to the plants of temperate regions, and may neglect the periodicity induced in warm climates by the alternation of wet and dry seasons.

In many plants a partial or complete arrest of growth occurs at a certain phase of the grand period, and this is repeated annually at regular intervals in all those plants which prepare for a period of winter rest during their activity in summer. A yearly periodicity is not, however, exhibited by all plants, and naturally not by those whose duration is short, such as bacteria, many fungi, and certain ephemeral flowering plants. Many tropical plants have also no resting period, and even in our hothouses continue to grow during winter, and such plants as *Senecio vulgaris* and *Stellaria media*, whose seeds can germinate as soon as they are ripe, may be found during mild winters in all stages of development. All such plants have a resting period forced upon them in severe winters merely owing to the low temperature preventing their growth.

Both the deciduous and evergreen trees of our climate, however, enter into a winter resting period even when placed in a warm greenhouse and well illuminated. Similarly the oak, beech, and fruit-trees throw off their leaves and rest during the winter period even in such climates as that of Madeira, where the average temperature during January, the coldest month, is 15.4° C., and many of the indigenous plants of this moist island climate grow all the year round¹. The perennating subterranean parts have in our climate an autonomic winter resting period, so that most rhizomes, tubers, and bulbs will not form shoots in autumn, while potatoes rest during winter in a cellar or clamp, but begin to sprout during spring even although the temperature has slightly fallen².

The duration of the dormant period may be extended by unfavourable conditions, and also varies in different plants. Thus a rise of temperature awakens some plants before the end of the year, but others not till spring. Askenasy³ was, for example, able to cause *Forsythia viridissima* and *Cornus Mas* to flower in December, and *Prunus avium* in January. Similarly *Salix*, *Corylus*, and *Syringa* flower unusually early during mild winters, whereas the buds of *Fagus sylvatica*, *Quercus pedunculata*, *Tilia*

¹ Heer, Bot. Ztg., 1852, p. 209; Schacht, Madeira u. Teneriffa, 1859. Cf. also Askenasy, Bot. Ztg., 1877, p. 832.

² For other instances see Askenasy, Bot. Ztg., 1877, p. 819; Grisebach, Die Vegetation d. Erde, 1872, Bd. II, p. 399; Ernst, Bot. Ztg., 1876, p. 38; Krasan, Beiträge z. Kenntniss d. Wachstums d. Pflanzen, 1873 (repr. from Sitzungsber. d. Wiener Akad., Bd. LXXVII, I. Abth.).

³ Askenasy, Bot. Ztg., 1877, p. 793. Cf. also Duchartre (Askenasy, l. c., p. 826); Krasan, l. c. (*Salix nigricans*, *Euonymus europaeus*, *Prunus Padus*).

europæa, and *Castanea vesca* will not expand before March or April. In these plants the resting phases form a considerable part of the grand period of growth, and this is also the case when they grow in warm houses, whereas the buds of *Prunus avium* and *Cornus Mas* begin to expand in December or January under such conditions¹. In these latter cases it is, however, possible that growth does not entirely cease under favourable conditions when the plants are freely exposed.

The result depends in nature as well as in experiments not only upon the changes in the external conditions, but also upon alterations in the power of growth. Hence when prolonged periods of cold delay the renewal of vegetative activity, favourable conditions produce a more rapid response than if they were applied earlier. In this way arises the sudden outburst of foliage when a cold spring is succeeded by warm days at the end of April or in May. Similarly foliation and flowering occur earlier after a warm winter and spring, although the development cannot be indefinitely hastened. The buds of *Salix* and *Cornus Mas* may, for example, expand during a warm winter in January, but not those of the oak and beech, which even in South Italy and Madeira do not open until March or April². The resting period of the beech at Madeira averages 149 days, which is 15 days less than in Switzerland³. As compared with Lesina, on the Adriatic Sea, vegetation begins on the average 43 days later at Paris and 100 days later at Pultowa⁴. Plants from southern climates strive to repeat their normal periodicity, and if the external conditions permit it, develop leaves and flowers at unusual times. In the progress of a few years, however, the plant may accommodate itself to the new conditions, and by lengthening its resting period assumes a yearly periodicity corresponding to the changed climate⁵.

In many cultivated varieties the resting period is considerably shortened or lengthened⁶. The resting period may take place at different stages of development,

¹ Askenasy (l. c., p. 824) kept branches of *Prunus avium* at 15 to 20° C. with their lower ends in water, and found by weighing and measurement that the buds developed but little between December 4 and 20, but enlarged considerably between December 23 and January 10, and flowered soon after this. Cf. also Geleznoff, Bull. d. l. Soc. Imp. d. Natur. d. Moscou, 1851, Bd. XXIV, p. 134; Busse, Flora, 1893, p. 171; Küster, Beiträge z. wiss. Botanik von Fünfstick, 1898, Bd. II, pp. 404-413. On the metabolic changes in buds cf. Fischer, Jahrb. f. wiss. Bot., 1891, Bd. XXII, p. 160. On the time of formation of buds see Mohl, Bot. Ztg., 1844, p. 90; Faist, Bot. Centralbl., 1888, Bd. XXXVI, p. 43; Albert, Beiträge z. Entwicklungsgesch. d. Knospen., Rostock Diss., 1894; Jahn, Bot. Centralbl., 1894, Bd. LIX, p. 263.

² Cf. Grisebach, Die Vegetation der Erde, 1872, Bd. I, p. 274.

³ Heer, Bot. Ztg., 1853, p. 210.

⁴ Cf. Kerner, Pflanzenleben, 1. Aufl., 1887, Bd. 1, p. 528; Drude, Pflanzengeographic, 1890, p. 36; Ludwig, Lehrb. d. Biologie, 1895, p. 146.

⁵ A. de Candolle, Mém. présentés p. divers savants, 1866, T. 1, p. 349.

⁶ Volkens (Gartenflora, 1896, p. 2) states that certain potato-tubers need no period of rest. Cf. also de Vries, Landw. Jahrb., 1878, Bd. VII, p. 244; Schmid, Ber. d. Bot. Ges., 1901, p. 67.

and does not occur in the same way and at the same time in all organs. Usually the resting period comes after the ripening of the seeds, but in *Colchicum autumnale* it occurs between the fertilization and fruit-formation¹. The seeds and other reproductive organs of many plants require a period of rest, although the vegetative parts show no such inherent periodicity, while in other plants the converse is true. Furthermore, the secondary growth of the xylem in trees begins and ends sooner than that of the phloem, while only a portion of the buds formed are capable of further development.

Subterranean organs. The different organs of a plant are commonly exposed to different conditions during the progress of the year, and that a localized effect is readily produced is shown by the fact that a branch led into a greenhouse during winter may become covered with foliage, while the branches outside remain quite bare². Since the subterranean organs are subject to less wide ranges of temperature than the aerial ones, and since other conditions may also differ, it is not yet certain whether the dissimilarities in the periodicity of the parts above and below ground are autonomic in origin or are due to the direct influence of the external conditions. It is, however, an obvious advantage that the roots of seeds, rhizomes, and tubers should at first develop more rapidly than the stem, although in adult perennial plants this is not actually necessary. The secondary growth of the root continues much longer than that of the stem, and may be still active in winter or even spring. Since it begins at the same time or only a little later than that of the stem, the resting period of the root is evidently very considerably shortened. This is probably the result of the lesser fall of temperature in the soil, and it is apparently owing to especially favourable circumstances that in some cases no complete cessation of growth could be detected in the root. A similar periodicity is noticeable as regards growth in length of the main root and the formation of lateral roots, which are usually most pronounced in spring, but frequently exhibit a secondary maximum in August according to Resa and Petersen³. Since Wieler was unable to detect any secondary maximum it probably, like the opening of buds in August, does not occur in every year. That differences should be shown is not surprising when we consider that hitherto all observations have been made under natural conditions, in which the periodicity is not only influenced by external variations, but also by interaction with the aerial organs. Moreover the different roots of the same tuber, bulb, or rhizome may in some cases exhibit dissimilar periodicities⁴.

Seeds and spores. Certain seeds are capable of immediate germination, whereas others must first rest for a few weeks, months, or even years, even when they are not dry, but are kept under conditions favourable for germination. Thus the seeds of *Tropa natans*, and probably of most aquatic plants, which sink to the bottom when

¹ Cf. Krasan, Beiträge z. Kenntniss d. Wachstums d. Pflanzen, 1873 (repr. from Sitzungsab. d. Wien. Akad., Bd. LXXVII, I. Abth.).

² Duhamel, Naturgesch. der Bäume, 1765, Bd. II, p. 209; Mustel, Traité d. l. végétation, 1781, T. II, p. 326; Göppert, Wärmewicklung, 1830, p. 220.

³ Mohl, Bot. Ztg., 1846, p. 314; 1862, p. 313; Resa, Ueber die Periode d. Wurzelbildung, 1877, p. 36; Wieler, Cohn's Beiträge z. Biologie, 1893, Bd. VI, p. 101; Petersen, Bot. Centralbl., 1898, Bd. LXXV, p. 272; Hämmerle, Fünfstück's Beitr. z. wiss. Bot., 1901, Bd. IV, p. 149.

⁴ Cl. Kimbaca, Ber. d. Bot. Ges., 1899, p. 30; Goebel, Organography, 1900, II, p. 490.

ripe, germinate next spring. Wiesner¹ found that the seeds of the mistletoe, and Kienitz² that those of the white fir, pine, beech, hornbeam, and ash, germinate in the following year, and only very exceptionally in the same year. Of sowings of ripe seeds of *Cuscuta*, *Euphorbia Cyparissias*, *E. exigua*, &c., a number germinate very soon, but others not until the following year, as in the case of *Euphorbia exigua*, some not until after nine years³.

The delay of germination is only in part due to the relative impermeability of the seed-coat⁴, for in those which swell up but do not germinate, some internal cause is evidently operating. During this dormant phase growth may either be entirely or only partially arrested, as in the seeds of *Eranthis hiemalis*, *Ranunculus Ficaria*, and other plants in which the seeds possess only a small embryo when shed, and this gradually enlarges at the expense of the endosperm⁵. The previous cultural conditions may apparently modify the length of the dormant period, but the conditions which lead to certain seeds resting under the soil for as long as fifty years, and germinating when dug up, have not yet been determined⁶.

In *fungi*⁷ and *algae*⁸, spores, zoospores, and conidia which are developed for rapid multiplication, usually germinate at once under favourable conditions, whereas zygotes, resting-spores, and sclerotia first pass through a resting period. The duration of this period appears to be capable of considerable modification by the prevailing and previous conditions, so that different authors disagree to a certain extent. De Bary gives a resting period of 45 to 145 days for the spores of *Saprolegnia*, whereas Klebs saw them germinate after 8 to 10 days. Hansen found that the sclerotia of *Coprinus stercorarius* and *C. niveus* were in some cases capable of immediate development, but in others not until after a resting period of two or three years.

Periodicity due to drought and light. In the dry seasons of many tropical climates, plants lose their leaves and rest, partly owing to the direct action of the deficiency of water, and partly owing to an autonomic periodicity induced by its regular recurrence⁹. The variable amount of daily illumination is also of impor-

¹ Wiesner, Ber. d. Bot. Ges., 1897, p. 514.

² Kienitz, Bot. Centralbl., 1880, p. 52.

³ Winkler, Ber. d. Bot. Ges., 1883, p. 452; Bot. Centralbl., 1889, Bd. xxxviii, p. 830; Wiesner, Biologie der Pflanzen, 1890, p. 41. Also Nobbe, Samenkunde, 1876, p. 352; Detmer, Physiol. d. Keimungsprocesses, 1880, p. 325; de Candolle, Pflanzenphysiologie, 1833, Bd. II, pp. 302, 306. On the germination of unripe seeds cf. Nobbe, l. c., p. 339; Wiesner, l. c., p. 40; Arthur, American Naturalist, 1895, p. 804; Kinzel, Versuchsstat., 1900, Bd. LIV, p. 125.

⁴ Cf. Wiesner, l. c., p. 41 seq.

⁵ Cf. G. Haberlandt, Die Schutzvorrichtungen der Keimpflanze, 1877, p. 50; Goebel, l. c., p. 454.

⁶ Peter, Nachrichten d. Göttinger Ges. d. Wiss., 1894, p. 373; Fr. Müller, Biol. Centralbl., 1886, Bd. vi, p. 513 (rhizome).

⁷ De Bary, Verh. Morph. u. Biol. der Pilze, &c., 1884, pp. 356, 370; Hansen, Bot. Ztg., 1897, p. 121; Eriksson, Centralbl. f. Bact., 1898, 2. Abth., Bd. IV, p. 431; Klebs, Jahrb. f. wiss. Bot., 1899, Bd. xxxviii, p. 571.

⁸ Cohn, Ann. d. sci. nat., 1856, 4^e sér., T. v, p. 191; Falkenberg in Schenk's Handbuch, 1882, Bd. II, p. 237; Götz, Flora, 1897, p. 99.

⁹ Cf. Schimper, Pflanzengeographie, 1898, pp. 286, 370; Huber, Bot. Centralbl., 1898, Bd. LXXVI, p. 259.

tance, and in fact seems to induce a certain periodicity in the algae of the Mediterranean and North Sea. Although complete rest does not actually take place, many algae vegetate during summer, and produce reproductive organs in winter¹.

SECTION 60. The Influence of the External Conditions upon the Yearly Periodicity.

Metabolism and respiration, though they never entirely cease, appear to be considerably depressed during the resting period², even when the plant is under favourable conditions. A wound may cause an increased respiration and a formation of callus and cork during an autogenic resting period³, although the wound-reaction takes place more slowly than when the plant is in full activity, and does not seem able to awaken the plant permanently from its dormant condition. Similarly cuttings taken from a plant during its resting phase develop roots slowly and with difficulty, while the buds may often be unable to expand.

A low temperature during winter or a diminution of turgor decreases the activity of respiration and also increases the length of the resting period. Furthermore the removal of the spring foliage causes in many trees an immediate development of buds which would have gradually enlarged during summer into resting winter-buds. In this case the slow development of summer and the resting period of winter are omitted. This is also the case when a tree under unusual conditions flowers a second time in autumn, owing to the direct development of some of the resting buds⁴. The resting period may be shortened in many plants by treatment with anaesthetics, by changes of temperature, or by transitory desiccation. Other agencies may produce similar effects, and may even cause an entire omission of the resting period without changing any of the plant's hereditary properties or its inherent periodicity.

Johannsen⁵ found that treatment with ether or chloroform for twelve to twenty-four hours caused the buds of such plants as *Syringa vulgaris* and *Prunus triloba* to open from three to six weeks earlier than untreated plants, whereas in other cases the resting period was shortened but little or not at all. Not only growth but

¹ Berthold, Mittheil. a. d. Zool. Station zu Neapel, 1882, Bd. III, p. 429; Oltmanns, Jahrb. f. wiss. Bot., 1892, Bd. xxiii, p. 413; Kuckuck, Ber. d. Bot. Ges., 1897, p. 446; Schimper, Pflanzengeographie, 1898, p. 446.

² Müller-Thurgau, Landw. Jahrb., 1885, Bd. xiv, p. 861; N. J. C. Müller, Beitr. z. wiss. Bot. von Fünfstück, 1898, II, p. 247.

³ Rechinger, Verh. d. Zool.-Bot. Ges. in Wien, 1893, p. 317; Jost, Bot. Ztg., 1893, p. 100; Wakker, Bot. Centralbl., 1887, Bd. xxxii, p. 239.

⁴ See Möbius, Beiträge zur Lehre von der Fortpflanzung, 1897, p. 105. Injuries may cause potatoes to sprout earlier than usual. Cf. Jost, l. c., p. 101.

⁵ Johannsen, Bot. Centralbl., 1898, Bd. lxxviii, p. 337; Das Aetherverfahren beim Frühreiben, 1900.

also respiration and metabolism are affected, and since submaximal doses of poisons may produce an increased respiration and production of heat, it may also be possible to shorten the resting period by means of them.

Since the result depends upon the condition of the plant, it is not surprising that little or no effect can be produced in summer or early autumn, when the growth and activity of the buds is at a minimum¹. The fact that the buds may be brought to immediate development in spring by removing the foliage shows that their power of response does not trace a curve parallel to that of the grand period.

Temperature. Knight observed in 1801 that a vine exposed to transitory cold sprouted sooner than those kept permanently in a greenhouse. Pfeffer obtained the same result with *Ampelopsis*, *Syringa*, and *Lycium*, Müller-Thurgau with potato-tubers². The resting period may be shortened in this way to a variable degree under natural conditions, but it has not yet been determined whether a single prolonged exposure to cold or repeated changes are more effective, or whether the stimulus is stronger with or without freezing. Metabolism is actually altered in the potato and other plants by temperatures even above 0°C. Possibly in some plants the resting period may be shortened by temporary exposure to high temperatures³.

Desiccation awakens the resting stages of *Chlamidomonas*⁴, and considerably hastens the germination of the zygotes of *Chlorogonium*⁵ and of the seeds of *Eichhornia* and *Heteranthera*⁶. Transitory drying seems to accelerate the sprouting of the bulbs of *Hyacinthus* and *Tulipa*, and of the corms of *Crocus*. The degree and duration of desiccation required to produce the maximal effect have not, however, been accurately determined⁷, nor is it certain whether Braun and Müller are correct in assuming that previous drying is essential for the further development of *Chlamidomonas*, or for the germination of the seeds mentioned.

A precise determination of the factors concerned in these alterations of periodicity is rendered more difficult because of the influence of the previous conditions upon the tone of the plant and hence upon its response. Such inductive action may persist for a long time and may only gradually disappear in the course of several generations. Thus the ripening of the seeds of cereals and of other plants is hastened in northern regions, and when such seeds are grown in warmer climates the life-cycle is at first shorter than usual, but as the plant adapts itself, the life-cycle lengthens to the normal

¹ Cf. also Jost, Bot. Ztg., 1891, p. 605; Lutz, Beitr. z. wiss. Bot. von Fünfstück, 1895, Bd. 1, p. 78.

² Müller-Thurgau, Landw. Jahrb., 1882, Bd. XI, p. 816; 1885, Bd. XIV, p. 903. Eriksson (Centralbl. f. Bact., 1895, 2. Abth., Bd. 1, p. 557) finds that transitory exposure to low temperatures favours the germination of the spores of certain Acidomycetes.

³ Cf. Wiesner, Biol. d. Pflanzen, 1889, p. 47.

⁴ Braun, Betracht. über die Erscheinung d. Verjüngung in der Natur, 1850, p. 228.

⁵ Klebs, Unters. a. d. Bot. Inst. zu Tübingen, 1883, Bd. 1, p. 340. Cf. Schröder, *ibid.*, 1886, Bd. II, p. 24.

⁶ Fr. Müller, Biol. Centralbl., 1886, Bd. VI, p. 299. Cf. also Batalin, Bot. Centralbl., 1889, Bd. XXVIII, p. 706.

⁷ Schröder, l. c.

amount for such regions in the course of from two to four years. It also takes some time for seeds developed in the South to acquire the periodicity peculiar to the North ¹.

Cieslar ² observed that seedlings of the pine and larch produced by seeds grown in a cool locality developed less rapidly than those from seeds grown in warmer regions. This may be the effect of an induced after-effect, although further research is required in this direction. Kienitz ³ in fact finds the contrary to be the case with some seeds.

It is not yet certain whether the shorter time of ripening of grain in the North is due to the longer daily illumination or to other factors, and the same applies to such plants as *Gentiana campestris*, *Parnassia palustris*, and *Calluna vulgaris*, which flower earlier in alpine localities than in the valleys beneath ⁴. This result can hardly be due to the slight differences in the amount of illumination, and it has not even been ascertained whether the conditions for the shorter summer period are induced during the long winter resting period, or whether the shortening of the summer period is due to the direct action of the external conditions at this time. In some cases correlative actions come into play, as when a retardation of the vegetative activity hastens the formation of reproductive organs. [In a deep valley whose sides slope at an angle of 30° light is received from an arc of 120° instead of from one of 180° as on the neighbouring summits. Further, at a height of 6,000 feet the oxygen-pressure is about one-sixth less than at sea level, whereas under similar conditions of temperature, transpiration will tend to be more active owing to the lowering of the vapour-pressure. Again the percentage of carbon dioxide is usually *higher* on lofty mountains, averaging .06 per cent. at Chamounix and Mont Blanc instead of .03 per cent. as in the valleys beneath. Lastly, air is imperfectly transparent, especially when laden with water-vapour, and if actual clouds are interposed the loss of illumination is enormously increased. In such a tropical country as Java the average height of the clouds is about 5,000 feet, at 10 or 12,000 feet the sky is usually clear, and the total daily illumination is very greatly increased on this account alone. In European countries the cloud-distribution is less regular, but the average height is much lower, and a lofty alpine summit will never have more cloud above it and will usually have less than the valley beneath. All these factors (illumination, transpiration, percentage of oxygen and of carbon dioxide) affect growth both directly and indirectly.—ED.]

¹ Linsser, *Unters. ü. die period. Erscheinungen der Pflanzen*, Mém. d. l'Acad. d. St.-Pétersbourg, 1867, 7^e sér., T. XI, and 1869, 7^e sér., T. XIII; Schübler, *Die Pflanzenwelt Norwegens*, 1873-5; Bot. Centralbl., 1886, Bd. xxviii, p. 205; Nobbe, *Samenkunde*, 1876, p. 238; Wittmack, *Landw. Jahrb.*, 1876, Bd. v, p. 613; 1877, Bd. vi, p. 599; Schimper, *Pflanzengeographie*, 1898, p. 55.

² Cieslar, *Bot. Jahresb.*, 1895, p. 32.

³ Kienitz, *Bot. Unters. von N. J. C. Müller*, 1879, Bd. II, p. 11.

⁴ Cf. Sendtner, *Flora*, 1851, p. 256. An after-effect may apparently be shown after a change of locality. A change of climate by transposing the annual period may hasten or delay flowering without shortening the time of development. Similarly plants which have been caused to flower early in one year may show a tendency to do the same in the following year. Cf. Bouche, *Bot. Ztg.*, 1873, p. 613.

The optimum growth is frequently only attained under a definite succession of changing conditions, and in the raising of early crops, for example, the best results are obtained when the temperature gradually rises as development progresses¹. Those plants which have a low maximum temperature must enter into a resting condition during summer. It is probable, but not yet certain, that the summer resting period of *Ranunculus Ficaria* is the result of an autogenic periodicity, while that of *Ulothrix zonata* and *Hydrurus* is due to the direct action of the high temperature.

Mean temperatures. Even when all other factors are constant, the relationship between growth and temperature cannot be expressed in the form of a simple equation (by a straight line), and this is still less the case when the plant's activity and power of response are influenced by simultaneous changes in other conditions, such as always occur in nature. Hence there is no constant relation between the mean temperature and the time of development, although a general correspondence will be shown when the climate maintains the same annual rhythm. A long period of drought would, however, by retarding vegetation temporarily alter the mean temperature for growth, which also differs for the same plant under dissimilar climatic conditions. Another instance of variation is shown by the fact that many of our flowers do not always bloom in the same order².

SECTION 61. The Origin of Yearly Periodicity.

The first question to determine is whether the autogenic resting period is a fixed hereditary property, or whether it is merely an induced characteristic which can be shortened or removed under constant external conditions. That it is capable of a certain modification has already been seen, for not only may it be shortened by previous stimulation, but cultural varieties are readily produced in which the resting period differs in length from that of the parent stock. Volkens in fact states that in potato-tubers grown at Kilimanjaro the resting period has disappeared, and probably the same may be found to occur in numerous lower organisms under appropriate conditions.

The autogenic resting period seems also to shorten or disappear when deciduous trees are grown under as uniformly favourable conditions as possible. Thus at Tjibodas (5,000 feet) on the flanks of the volcano of Gedeh, where the climate is temperate and constantly humid, *Quercus pedunculata*, *Pyrus Malus* and *P. communis*, *Liriodendron tulipifera*, *Amygdalus communis*, and other deciduous trees grow like evergreens. The buds expand not simultaneously but successively, so that an individual plant

¹ Cf. Schimper, *Pflanzengeographie*, 1898, p. 469; Kerner, *Pflanzenleben*, 1887, 1. Aufl., Bd. 1, p. 525; Müller-Thurgau, *Landw. Jahrb.*, 1885, Bd. XIV, p. 903.

² See Drude, *Handb. der Pflanzengeographie*, 1890, p. 39; Grisebach, *Vegetation d. Erde*, 1872, Bd. 1, p. 227; Köppen, *Wärme u. Pflanzenwachsthum*, 1870, p. 54; Sachs, *Jahrb. f. wiss. Bot.*, 1860, Bd. 11, p. 370.

bears at the same time spring, summer, autumn, and winter shoots¹. Each bud shows the usual periodicity, but that of the plant as a whole has gone, and it disappears at Tjibodas in the course of a few years.

The same probably applies to the root also, which must in fact be continually active, and which even in our climate has only a short resting period. Direct experiment is, however, required to make this certain, and also whether the periodicity as regards growth in thickness is lost. This is probably the case in the main stem at least, for the secondary growth of the stem in spring and autumn stands in close relation to the activity and development of the branches and leaves.

In the same way the vine at Cucumana in Venezuela², and at Khartoum³ in Central Africa, bears flowers and fruit all the year round, while the cherry grows as an evergreen in Ceylon⁴. It has not, however, been determined in any one of these cases whether the resting period of each bud remains the same, is shortened, or disappears. Even the formation of bud-scales may possibly be suppressed, direct development into a leafy branch occurring, and this can in fact be induced by removing the spring foliage.

While the observations made in Java show that the resting period may entirely disappear under sufficiently constant conditions, those made at Madeira show that an annual fall of temperature is sufficient to maintain a yearly periodicity, although in the coldest month growth still remains possible. Reiche observed the same in the sub-tropical climate of Chili, and also found that a periodicity is more readily produced or maintained in some plants than in others⁵. Thus in both Brazil and Madeira the peach is almost an evergreen⁶, whereas the oak, beech, and apple still pass through a long resting period. A similar yearly rhythm might be induced by periodic drought, or by other periodic changes, under constant conditions as regards temperature⁷.

Grisebach considers that the yearly periodicity in plants of temperate regions is entirely an hereditary property, whereas Askenasy considers it to

¹ Schimper, *Pflanzengeographie*, 1898, p. 266.

² Quoted after von Humboldt by de Candolle, *Géographie botanique*, 1855, T. I, p. 392.

³ According to Hamier. Cf. Linsser, *Ueber d. period. Lebenserscheinungen*, 1867, 2. Abth., p. 81; Askenasy, *Bot. Ztg.*, 1877, p. 841.

⁴ De Candolle, l. c., p. 391. Jungbuhn observed that the peach and strawberry bore blossoms and fruit all the year round. On the behaviour of the strawberry and some other plants in Brazil cf. Müller, *Bot. Jahrb. f. Systemat. u. Pflanzengeographie*, 1882, Bd. II, p. 394. The absence of fruit from the cherry in Ceylon, and from most of the European fruit-trees grown in British Guiana (R. Schomburgh, *Reisen in British Guiana*, 1847, Bd. I, p. 45), is probably the result of the high temperature. A plant may become evergreen owing to the lengthened duration of the leaves without the time of flowering altering. Cf. Kraus, *Bot. Centralbl.*, 1882, Bd. IX, p. 75.

⁵ Reiche, *Jahrb. f. wiss. Bot.*, 1896, Bd. XXX, p. 98.

⁶ Harting (cf. Askenasy, *Bot. Ztg.*, 1877, p. 834) states that peach-trees may in part blossom in November at Madeira.

⁷ Cf. Schimper, l. c., p. 267.

be directly due to the external conditions¹. There can, however, be no doubt that it is due to the co-operation of an hereditary tendency to rhythm with the after-effect of the periodic repetition of aitiogenic reactions induced by the external conditions. Buds appear to have an inherent hereditary rhythm, which may, however, be shortened or lengthened by appropriate external conditions.

Owing to the persistent after-effect it takes some years before a deciduous tree becomes evergreen at Tjibodas in Java², and if the tree were brought back to Europe it would presumably gradually revert to its original periodicity. Similarly a tree transplanted from the Southern hemisphere keeps at first its original periodicity, and often after a time accommodates itself to the altered seasons.

The origin of the rhythm which persists under constant conditions is quite unknown, and several facts contradict the assumption that it is due to the hereditary fixation of a retardation of growth produced by external conditions recurring regularly for countless generations. Many plants of temperate regions have, for example, no autogenic resting period, and instances have been given of the gradual disappearance under constant conditions of a periodicity induced by an annual climatic rhythm repeated for thousands or millions of years. Many of the plants of Java and of other regions throw off their leaves at stated intervals and then become again clothed with foliage³. This rhythm is independent of the external conditions, and is carried out at different times by plants growing close together. In this case each tree keeps its own rhythm, whereas in oaks and pears which have become evergreen, each bud has its own individual rhythm and the tree as a whole has none.

Internal factors. With regard to the internal mode of origin of resting periods, it can only be said that the same end may be attained in a variety of ways, that chemical influences due to the production or removal of metabolic products may be of great importance, and that in general metabolism may in a variety of ways directly or indirectly accelerate or retard growth.

Owing to internal stimuli, growth may temporarily or permanently cease or be retarded although optimal nutritive conditions are ensured. It is in this way, and not by a deficiency of food, that an autogenic resting period is produced and regulated. That the resting cells have a sufficiency of food is shown not only by their appearance, but also by their power of responding to injuries by callus-formation and increased respiration. The effects produced by low and high temperatures show that buds and rhizomes have the power of forming sugar from starch and starch from sugar during the entire resting period. Müller-Thurgau and Sachs are hence

¹ Grisebach, *Die Vegetation d. Erde*, 1872, Bd. 1, pp. 273, 279; Askenasy, *Bot. Ztg.*, 1877, p. 840. Cf. Pfeffer, *Periodische Bewegungen*, 1875, p. 42, footnote.

² Schimper, *Pflanzengeographie*, 1898, p. 266.

³ *Id.*, l. c., p. 264.

incorrect in assuming that the resting period is the direct result of a deficiency of food capable of use¹. Sachs² suggested that the cessation of the resting period was due to the gradual production of solvent enzymes rendering food-materials available, while Müller-Thurgau supposed that the sprouting of a potato-tuber was induced in it owing to the conversion of some of the starch into sugar. The commencement of growth naturally involves an increased metabolism, but the latter may also occur as the result of injury without the plant being awakened from its resting period. It is in fact not at present possible to say what part is played in the production of periodicity by stimulating or nutrient substances.

Annual rings. Nothing definite is known as to the causes which determine the anatomical differences between spring, summer, and autumn wood³. These differences, like the periodicity of growth in thickness, stand in the closest relationship to the various functional activities at the different stages of development. This is admirably shown by the fact that removal of the leaves in spring, by inducing a new formation of foliage, also produces a more or less distinct renewed formation of spring wood⁴. Hence the annual series of changes in the structure of the wood is the result of a complex correlative reaction, which we are not at present able to resolve into simpler factors. Indeed to do this we must first know the causes which determine the differentiation of equipotential meristem cells, some into tracheides, others into tracheae, and others again into wood-parenchyma, according to their position and the needs of the plant.

It is evident that no theory can be correct which ascribes a phenomenon of complex origin to the action of a single factor, and hence a brief notice of the numerous existent theories will suffice⁵. It is moreover often forgotten, in interpreting the results of experiments, that similar structural changes may be produced by different means, so that the decreased size of cells due to a deficiency of water, food, or of room for expansion does not indicate the combination of factors which determines the decreased diameter of the cells of the autumn wood.

Sachs⁶ and de Vries⁷ assumed that the smaller diameter of the autumn wood

¹ Müller-Thurgau, Landw. Jahrb., 1885, Bd. XIV, p. 881.

² Sachs, Vorlesungen über Pflanzenphysiologie, 1887, 2. Aufl., p. 347.

³ For anatomical details see de Bary, Comp. Anat., 1877, pp. 475, 504; Haberlandt, Physiol. Anatom., 1896, 2. Aufl., p. 513.

⁴ De Bary, l. c., p. 529; Kny, Verh. d. Bot. Vereins der Provinz Brandenburg, 1879; Jost, Bot. Ztg., 1893, p. 115; Büsgen, Waldbäume, 1897, p. 93. Similar rings occur in the wood of tropical trees subject to a resting period, and also in the stems of certain Rhodophyceae (Jönsson, Beiträge z. Kenntniss d. Dickenwachstums der Rhodophyceen, 1891, p. 31 (repr. from Lunds Univ. Årsskr., Vol. XXVII)).

⁵ A summary is given by Schwarz, Physiol. Unters. über Dickenwachstum und Holzqualität von *Pinus sylvestris*, 1899, p. 235; Montemartini, Accrescimento delle piante, 1897, p. 17 (repr. from Atti d'Istituto Botanico d. Pavia). On excentric annual rings cf. Schwarz, l. c., p. 161; Hartig, Centralbl. f. d. gesammte Forstwesen, 1899, Heft 7.

⁶ Sachs, Lehrb. d. Botanik, 1868, 1. Aufl., p. 409.

⁷ De Vries, Flora, 1872, p. 241; 1875, p. 97; 1876, p. 2; De l'influence d. l. pression s. l. structure d. couches ligneuses, 1876.

elements was the mechanical result of the increasing pressure of the bark upon them, whereas Krabbe¹ has shown that the required pressure does not exist. Indeed a very high pressure would be required to produce a noticeable effect. Schwarz² has suggested that a slight increase of pressure might act as a stimulus determining the transition from spring to autumn wood, but since the pressure does not seem to follow a constant rhythm, Schwarz calls a second hypothesis to the aid of the first one by assuming that the plant's power of reaction alters during the summer.

Hartig³ and also Wieler⁴ consider the change from spring to autumn wood to be the result of altered conditions of nutrition. The former, however, considers the autumn wood, the latter the spring wood, to be the result of better nutrition, while both authors ascribe some importance to the changes in the percentage of water in the stem, which Lutz⁵ considers to be of decisive importance. Russow⁶ sought to explain the greater diameter of the cells of the spring wood as being due to their higher turgidity during development, whereas Wieler⁷ has shown that the turgidity is no higher in spring than in autumn.

Haberlandt⁸, Strasburger⁹, and Hartig¹⁰ consider the anatomical differences between the spring and autumn wood to be induced and regulated by the transpiration-current, but have brought forward no satisfactory arguments in support of this conclusion. This factor has apparently an accessory importance, for although it can hardly cause the formation and differentiation of the vascular tissue, it may aid in their full development by the influence of use and demand upon growth and supply.

SECTION 62. **Abscission and Leaf-fall.**

In the progress of development many living or dead parts may be thrown off. To the former class belong seeds, spores, and reproductive bodies in general, including pollen and antherozoids¹¹. In *Vallisneria* the entire male flower is thrown off and ascends to the surface, so as to render possible the pollination of the floating female flowers. Organs which have fulfilled their function are also frequently thrown off while living or before

¹ Krabbe, Sitzungsber. d. Berl. Akad., 1882, p. 1125; *Wachstum d. Verdickungsringes u. der jungen Holzzellen*, 1884, pp. 57, 69 (repr. from *Abhandl. der Berl. Akad.*).

² Schwarz, *Physiol. Unters. über Dickenswachstum und Holzqualität von Pinus sylvestris*, 1899, p. 365.

³ Hartig, *Unters. a. d. Forstbot. Inst. zu München*, 1880, I, p. 148; *Holz d. Nadelbäume*, 1885, pp. 34, 103.

⁴ Wieler, *Jahrb. f. wiss. Bot.*, 1887, Bd. xviii, p. 129; *Tharandter Forstl. Jahrb.*, 1892, Bd. xlii, p. 216; 1897, Bd. xlvii, p. 172.

⁵ Lutz, *Beitr. z. wiss. Bot. von Fünfstück*, 1895, Bd. 1, p. 80. Cf. Jost, *Bot. Ztg.*, 1893, p. 118.

⁶ Russow, *Sitzungsber. d. Dorpater naturf. Ges.*, 1881, p. 41.

⁷ Wieler, *Jahrb. f. wiss. Bot.*, 1887, Bd. xviii, p. 80.

⁸ Haberlandt, *Physiol. Anat.*, 1. Aufl., 1884, p. 371; *Ber. d. Bot. Ges.*, 1895, p. 337.

⁹ Strasburger, *Bau u. Verrichtung d. Leitungsbahnen*, 1891, p. 949.

¹⁰ Hartig, *Forstl. naturw. Zeitschrift*, 1894, III, p. 174.

¹¹ Another instance is afforded by the division and separation of the cells of bacteria and other somatophytes.

they are quite dead. This applies to the leaves of many deciduous and evergreen trees, and petals, stamens, and unfertilized flowers often separate from the parent plant while still turgid¹.

The plant itself prepares for the abscission of such organs, and does so in various ways. A young leaf or an unripe apple can support a considerable load, but can withstand less and less stress as they grow older. Owing to the loosening of the tissues, the internal strains gradually disappear, and in the capsule of *Impatiens* this occurs suddenly at the moment of dehiscence. This does not happen when an unripe fruit is killed; nor do the young leaves fall when a branch is cut and rapidly dried. Leaves which die before they are ready to fall are, however, gradually removed by the wind and other mechanical agencies. Dead branches may be removed by the same means, but in some cases the tree is kept clean and its foliage open by an active abscission of twigs or even buds².

The dry stems and withered leaves of many herbaceous plants show that active abscission does not occur in all cases. Similarly the older parts of rhizomes simply die and decay away. Hollow trees are produced by the decay of the duramen, which under normal conditions persists owing to its supporting function.

The partial or total separation of contiguous cells is produced by the softening or swelling of the middle lamella, and the abscission of leaves, fruits, and conidia is produced by similar means, although special changes are in many cases involved in the process. Thus Mohl showed that in leaves and many fruits, separation is provided for by a resumption of growth in certain resting cells which produce the abscission layer. Even after this had separated Mohl³ found that the vascular bundles in the petiole of *Catalpa* were still unbroken, whereas Wiesner⁴ has found that the energy of growth is sufficient to cause the vascular bundles to snap at the line of abscission. This is not always the case, for the dead leaves of beeches and oaks wither on the tree and are gradually torn off by wind and rain. Frost is also of importance, and the first cold night of autumn may cause all the remaining leaves of *Robinia*, *Aesculus*, and *Fraxinus* to fall simultaneously.

Abscission is not primarily due to the formation of a layer of cork, which in fact usually occurs after the organ has fallen⁵. In some cases,

¹ Mohl, Bot. Ztg., 1860, pp. 1, 273; Hofmeister, Allg. Morph., 1868, p. 551; Wiesner, Sitzungsber. d. Wien. Akad., 1871, 1. Abth., Bd. LXIV, p. 465; Biologie, 1889, p. 67; R. v. Hohnel, Ueber d. Ablösungsvorgänge d. Zweige einiger Holzgewächse, 1878; Bretfeld, Jahrb. f. wiss. Bot., 1880, Bd. XII, p. 133; Reiche, *ibid.*, 1885, Bd. XVI, p. 684 (flowers); Molisch, Sitzungsber. d. Wien. Akad., 1886, Bd. xcvi, 1, p. 148; Dahmen, Jahrb. f. wiss. Bot., 1892, Bd. xxiii, p. 476 (seeds); M. Büsgen, Bau und Leben unserer Waldbäume, 1897, pp. 19, 148; Fougilloy, Rev. gén. d. Bot., 1899, T. xi, p. 304 (leaves). On the fall of members in algae cf. Schimper, Pflanzengeographie, 1898, p. 835.

² Büsgen, l. c., p. 19.

³ Mohl, l. c., p. 5.

⁴ Wiesner, l. c., p. 505.

⁵ Cf. Mohl, Bretfeld, l. c.; Staby, Flora, 1886, p. 113.

however, cork layers may be used to cut off the supply of food to particular tissues and organs, and so bring about their death and separation.

The time of abscission is always dependent upon external circumstances, and can be hastened or delayed by unusual conditions. It is hastened by feeble illumination¹, an insufficiency of water, and by high temperatures. Sudden changes may have the same effect, especially upon the older leaves. For example, it is mainly owing to the altered transpiration that *Colens*, *Impatiens Sultani*, *Goldfussia anisophylla*, and many other plants throw off a portion of their leaves when brought from the moist air of a greenhouse to the drier air of a room². A sudden change of temperature or illumination may produce similar results, and various factors may induce the abscission of the roots of *Azolla*³. If, however, the change is gradually made no stimulating shock-effect is exercised, and the leaves are not thrown off.

Both permanent and transitory functional disturbances due to altered demands may therefore induce the active abscission of organs. Hence leaves fall and die in the absence of carbon dioxide, or when they are prevented from exercising their normal functions. Similar factors, combined with correlative influences, determine the fall of unfertilized flowers, of fruits in which the ovules have been devoured by grubs, and of petioles deprived of their laminae.

The process of abscission may be induced in various ways, although the mechanical separation is produced by the same means that are adopted for the partial or total separation of individual cells. We do not, however, know what part enzymes may play in the process, or whether the formation of organic acids at the end of summer is of importance, which Wiesner in fact supposes to be directly responsible for the fall of the leaves.

¹ Vöchting, *Organbildung im Pflanzenreich*, 1878, p. 232; Molisch, *Sitzungsb. d. Wien. Akad.*, 1886, Bd. xcvi, I, p. 161.

² Watering with salt water acts similarly according to Schimper (*Indomalayische Strandflora*, 1891, p. 22).

³ Pfeffer, *Unters. a. d. Bot. Inst. z. Tübingen*, 1886, Bd. II, p. 213.

CHAPTER X

THE POWER OF RESISTANCE TO EXTREMES

PART I

THE CAUSES OF DEATH

SECTION 63. Death and Dormancy.

THE duration of life is in all cases dependent upon the external conditions, which, when unfavourable, may produce rapid or gradual death. The duration may, however, be lengthened when a plant develops at a lower temperature than usual, or when seeds are kept for a long time in a dried condition. All influences which retard or inhibit single functional activities without stopping all, ultimately produce injury or death if they are sufficiently intense and act for a long enough time.

Injury or death always ensues when one or more of the formal conditions for growth surpasses the minimal or maximal limits, or when other agencies act with sufficient intensity. Thus plants ultimately die when their turgor is insufficiently maintained, or when they are kept at subminimal or supra-maximal temperatures. An insufficiency or excess of oxygen, a deficiency or over-concentration of food produce the same effect, and in the absence of light autotrophic plants ultimately die. Many food-materials, such as acids and salts of iron, act as poisons even when very dilute.

A certain intensity of action is always necessary to produce death, which does not for example occur when a plant grows feebly owing to the lowness of the temperature or to partial starvation. When a plant is subjected to a temperature a little above the permanent maximum, growth and assimilation gradually cease, and finally symptoms of injury or death are shown on particular organs or over the entire plant. If the injury has not gone too far, a gradual recovery is made on returning to the original conditions, and growth is slowly resumed. Similar results are produced by starvation and by the action of poisons and other injurious agencies, and death may be sudden or gradual according to the intensity of the action.

The resistant power of different plants varies within wide limits. Thus some grow at temperatures at which others are immediately killed, a trifling percentage of oxygen is sufficient to kill many anaerobes, whereas most aerobes only die when the partial pressure of oxygen is much higher than in the atmosphere, and certain plants can grow in concentrated nutrient solutions which kill others. Furthermore, many plants are very sensitive to low temperatures or to an excessive loss of water, whereas others can withstand complete desiccation and the severest cold. In the case of many

mosses and lichens the entire plant can withstand desiccation, whereas among Phanerogams and fungi only the seeds or spores possess this power. The power of resistance may change during development, for the winter buds of our forest trees survive frosts which may readily kill the young foliage and expanding buds. It may also be modified by the previous conditions, and is dependent upon the duration and rapidity of application of the injurious agency. The effect of an intermittent application is, moreover, not the same as that of a constant one. The resistance of seeds, spores, and mosses against cold, heat, and poisons is greatly increased by drying, and the action of one poison may be neutralized by that of another.

A striking instance of the effect of sudden change is afforded by the bursting of fungi when a concentrated solution in which they are growing is suddenly diluted, whereas gradual dilution to the same extent does not injure them. Similarly a plant may slowly accommodate itself to strains, concentrations, doses of poison, and temperatures which would injure or kill it when suddenly applied. A repeated change may produce a cumulative effect, as when a plant which can withstand a single frost is killed by successively freezing and thawing a few times. This is possibly due to a gradual weakening of the organism and a consequent decrease in its power of resistance.

The intensity of any agency required to produce a fatal effect depends not only upon its duration, but also upon many variable circumstances. Hence the position of the ultra-maximum¹, as well as of the maximum and minimum points, can only be approximately and conditionally determined. The same applies to the ultra-minimum, which is non-existent as regards water or heat when a plant is uninjured by low temperatures or by desiccation, or when we are dealing with a non-essential agency.

In turgid plants a complete cessation of all forms of vital activity involves irremediable death, for even when growth, movement, and photosynthesis have ceased, respiration still continues so long as the plant is living and ceases only on its death. In fact, the plant is usually no longer capable of recovery when its respiratory activity has been brought to a minimum or even much reduced by the action of an injurious agency².

Even when a plant is frozen, respiration is merely strongly reduced, and probably ceases only when all the free and imbibed water passes into the solid condition, which may require temperatures of -12° C. and even lower³. Perfectly dry seeds, mosses, and lichens do not respire, and neither

¹ This term was introduced by Engelmann, *Handbuch d. Physiol. von Hermann*, 1879, Bd. 1, p. 358.

² In starved fungi respiration may be reduced to a very low ebb, whereas at supra-maximal temperatures a slight diminution of the original respiratory activity indicates a permanent injury.

³ Koch, *Biol. Centralbl.*, 1890, Bd. x, p. 682; de Candolle, *Archives d. sci. phys. et nat. d. Genève*, 1895, T. XXXIII, p. 506. Cf. also van Tieghem and Bonnier, *Bull. d. l. Soc. Bot. d. France*, 1882, T. XXIX.

absorb oxygen nor exhale carbon dioxide. This dormant condition has been termed anabiosis by Preyer, and it is impossible to tell by its appearance whether a dry seed or spore has life latent in it, or whether its vitality has been lost, so that on moistening it decomposes instead of germinating. In spite of their dormant condition, however, certain changes do occur in dry seeds, for when they are kept the power of germination is lost after a longer or shorter time.

SECTION 64. Death and Senile Decay.

It can easily be understood that any agency, such as sudden heat or violent pressure, which destroys the structure of the protoplasm, produces immediate death. Furthermore, any functional disturbance which prevents the harmonious co-operation necessary for continued existence ultimately produces unavoidable injury and death. It is in this manner that death is induced by internal causes during the normal progress of development, for although each protoplast strives to maintain its own existence, a vascular plant provides that certain ones, such as tracheae and sclerenchyma fibres, shall die for the common good. The conditions for ultimate death are in fact assured whenever a somatic organ of limited duration commences to undergo its special differentiation.

Whether death is gradually induced by the external conditions or not, it still remains the final act of life, and is the direct result of the interaction between the properties of the protoplast and the prevailing internal and external conditions. Hence all pathological phenomena are vital reactions, which may, however, go so far as to lead to death. The same methods apply therefore to the study of such phenomena as to vital phenomena in general, and although we may determine the internal or external factors which produce death, their mode of action remains unknown. This is even the case when a single factor, such as the removal of the nucleus, is responsible for the death of the remaining part of the cell. It is, however, rarely the case that the reaction is restricted to a single organ of the protoplast, for in most cases the same agency may affect all of them to varying degrees, and so produce complex internal disturbances.

We are therefore unable to say whether the fatal disturbances produced at temperatures a little above the maximal point are due to the increased activity of respiration or to a variety of reactions. Furthermore, since the causal origin of respiration is quite unknown, we are equally unable to trace the changes produced by the absence of oxygen which lead ultimately to the death of an aerobe. Nor can we say why the intramolecular respiration of the latter does not suffice to maintain life, when anaerobic organisms can exist in the entire absence of free oxygen. It is easy to understand that an organism should die when starved, or even when

deprived of a single essential element, but the changes and reactions which render the continued existence of the protoplast impossible in the absence of potassium, magnesium, or iron are quite unknown. We can, however, easily see that owing to the increased metabolic activity death naturally occurs in such cases sooner at high temperatures than at low ones.

Certain injurious agencies produce a vacuolation or deformation of the protoplast, but others cause no perceptible change previously to death, and this is even the case in living non-nucleated fragments of cytoplasm, although the absence of the nucleus must induce profound disturbances in them. In spite of this, however, they may remain living for a considerable time, although the disturbances due to high temperatures and the absence of oxygen produce rapid death in the intact protoplast. If the processes leading to death have not gone too far, recovery may take place on the restoration of normal conditions, and under such circumstances the vacuolation or deformation of the protoplast also disappears. The same occurs when the disturbance is due to a change of conditions to which the plant is able to gradually accommodate itself. The removal of the nucleus acts as an irremediable injury to the protoplast, whereas the effect of the removal of a certain portion of the cytoplasm, and probably also of the nucleoplasm, can be successfully overcome.

Every somatic cell, and hence every adult organ, appears as far as we know to have a limited duration, and hence leaves die under the most favourable conditions after one or a few years, while the old parts of apically growing rhizomes and mosses continually die away. The long life of a tree is only attained by the continual formation of new wood and bark by the cambium, and these tissues may either die in a few years or in many species may remain living for a hundred years. This ultimate death would probably also occur in the absence of correlative influences, for the duration of the somatic parts of an annual can be somewhat, but not indefinitely, increased when flowering and fruiting is prevented.

Automatic death may probably be produced in various ways. In addition to those cells in which the final stages of development lead directly to death, others may exist which would be capable of unlimited life, were it not that the vital activity of the cell causes it to slowly wear out and die. In such cases death would not ensue if the wear and tear could be completely repaired, but such a perfect power of repair does not seem to be possessed by the somatic cells even of the simplest vascular plants¹.

In asomatophytes, in which all the cells remain permanently embryonic and capable of growth and division, death from internal causes is avoided. Thus bacteria and yeast-cells continue to grow and divide so

¹ Frank (*Krankheiten d. Pflanzen*, 1895, 2. Aufl., Bd. 1, p. 6) erroneously supposed that death never arose from internal causes.

long as the conditions are favourable, without any weakening or death of individual cells occurring. This is, however, only possible for a short time, since the consumption of the food and the accumulation of excrete products create external conditions which soon retard growth and ultimately produce death.

It is very probable that the embryonic cells of an asomatophyte would ultimately die under otherwise optimal conditions, if growth was mechanically prevented, so that division and rejuvenescence no longer occurred. No certain proof has, however, yet been attained, and the fact that cells of *Spirogyra*, *Saccharomyces*, and also the growing apices and cambium of somatophytes remain living in plaster-casts says nothing, for these experiments extended only over a few weeks, months, or years, whereas the somatic cells in many trees with soft wood may live for as long as a hundred years¹.

Evidence of the limited life of embryonic cells in the absence of growth and division is afforded by the fact that the dormant buds and resting cambium of trees ultimately die, though often only after a long period of time², and that seeds and spores lose the power of germination in from a few to many weeks, months, or years. When yeast-cells and bacteria slowly die in nutrient solutions which permit a certain amount of metabolism but no growth³, it is possible that this result is due to the direct action of the external conditions, which when unfavourable may produce death in embryonic as well as in somatic cells.

The maintenance of the species is only possible by the growth and rejuvenescence of embryonic cells. In asomatophytes death is produced only by external conditions, which may be due either to the organism itself, or to some other agency. A portion of the embryonic cells of somatophytes, however, always follow a line of development and differentiation leading automatically to death, and hence it arises that the differentiated organs of such plants always have a limited duration. Under natural conditions only a limited number of the progeny of an asomatophyte survive, so that in this case also the species is maintained by a portion of the embryonic cells⁴.

¹ Pfeffer, Druck- u. Arbeitsleistungen, 1893, pp. 240, 355; Newcombe, Botanical Gazette, 1894, Vol. XIX, p. 232.

² Hartig (Lehrb. d. Anatom. u. Physiol., 1891, p. 272) states that non-growing cambium may remain living for dozens of years.

³ Hansen (Meddelelser fra Carlsberg Laboratoriet, 1899, Bd. IV, p. 109) finds that some species of yeast may live for seventeen years in a solution of saccharose which permits slow growth, while vinegar bacteria may live for one to six years in beer (Hansen, l. c., 1894, Bd. III, p. 210). Cf. also Bolley, Centralbl. f. Bact., 1900, 2. Abth., Bd. VI, p. 33.

⁴ The continuity of the germ-plasma is a primary condition for the maintenance of the species, and hence it is immaterial whether one terms the species immortal, or applies the term only to asomatophytes (Weismann, Leben und Tod, 1884). A species can only maintain itself under

The power of resistance varies considerably according to the plant examined, and hence the conditions for existence are not in all cases alike. Palms and other tropical plants cannot be grown in the open in our climate, whereas our indigenous trees can withstand cold during their winter resting condition, although frost kills the expanded leaves and flowers. The aerial parts of many plants with perennating rhizomes are killed by frost, as are also many annuals whose seeds perennate over winter. Similarly plants which are sensitive to desiccation maintain themselves over periods of drought by seeds, spores, rhizomes, bulbs, tubers, and the like. If the entire plant is to survive it must either possess xerophytic adaptations to guard against an excessive loss of water, as in the case of cactuses and many Euphorbias, or it must be able to withstand desiccation, as in mosses and lichens.

The injurious actions of cold, heat, light, and desiccation are constantly met with in nature, but the influence of poisons also requires discussion, since this is a subject which is acquiring increasing physiological importance. Indeed it is possible by the use of anaesthetics and other poisons to retard or inhibit certain functions, while others are affected but little or not at all. We are not, however, concerned with plant pathology¹, and indeed diseases are not always accompanied with visible formative changes, which naturally can hardly occur when death is instantaneous. Signs of death are, the drooping, discolouration, shrivelling of herbaceous parts², the changed appearance of the protoplasm, its non-plasmolysability, its absorption of stains, and its permeability to soluble pigments present in the cell-sap³. The appearance of the protoplasm differs, however, according to the mode of death, and by means of picric or osmic acids, or of absolute alcohol, it may be fixed in its original condition⁴. Otherwise the structure is more or less effaced after death, but such post-mortem changes have no physiological importance, and the same applies to the changes which may be produced in the cell-wall by the energetic action of certain reagents.

PART II

RESISTANCE TO HEAT AND COLD

SECTION 65. *Supra-maximal Temperatures.*

The position of the ultra-maximal temperature beyond which death ensues varies not only in different plants, but also according to the stage of development and the external conditions. Thus seeds and plants which

suitable conditions, and hence is only conditionally immortal. Cf. Verworn, *Allg. Physiol.*, 1897, 2. Aufl., p. 345.

¹ Frank, *Krankheiten d. Pflanzen*, 1895, 2. Aufl.; Hartig, *Lehrb. d. Baumkrankheiten*, 1899, 2. Aufl.; Sorauer, *Handb. d. Pflanzenkrankheiten*, 1886, 2. Aufl.

² Cf. Sachs, *Flora*, 1864, p. 37; Hofmeister, *Pflanzenzelle*, 1867, p. 10; de Vries, *Sur l. mort. d. cellul. végétales*, 1871 (repr. from *Archives Néerlandaises*, T. VI).

³ The protoplasm may be killed without the diosmotic properties of the plasmatic membrane being at first lost.

⁴ Fischer, *Fixirung, Färbung u. Bau d. Protoplasmas*, 1899.

can withstand desiccation are extremely resistant to heat when dry, and may indeed be uninjured by heating to 90 or to 100° C. for several hours, although when moist a temperature of 45 to 50° C. may soon prove fatal¹. The moist spores of certain bacteria are even able to withstand from a half to several hours' immersion in boiling water, which kills most plants almost instantaneously. Death usually, indeed rapidly, ensues at 70° C., which temperature permits active growth in the case of certain bacteria, while a few organisms may even grow at 85° C.

All turgid plants ultimately die when the temperature surpasses the maximum by one or two degrees, although growth may at first still continue. Hilbrig² found that the radicle of *Vicia Faba* ceased to grow after sixty to ninety minutes' immersion in water at 35° C., and died in another fifteen minutes, whereas under favourable conditions growth was resumed after five or six hours when the heat-rigor had lasted half an hour, and after about a day when the exposure lasted an hour. In such fungi as *Penicillium glaucum*, *Mucor stolonifer*, and *Cladosporium herbarum*, the heat-rigor may last a long time before death ensues. Thus when *Penicillium*, whose maximum temperature for growth lies at 34° C., was kept in a nutrient solution at 35° C., the mycelium died only after thirty-one days and the spores after fifty-four. Previously to this recovery is possible, and the longer the exposure, the longer will be the time of recovery. Thus after exposure to 35° C. for fifty-one days, the spores of *Penicillium glaucum* took eleven days to germinate at 22° C., whereas after two days' exposure, only two days were required for germination.

Certain micro-organisms may be capable of enduring heat-rigor for a still greater length of time, whereas others may be rapidly killed. Thermo-bacteria appear to be rapidly killed when the temperature rises above their maximum, but it does not follow that a plant with a low maximum will be able to withstand prolonged heat-rigor. Hilbrig found, for instance, that a water-bacterium whose maximum lay between 34 to 35° C. was killed by five days' exposure to 35° C.

When the temperature lies much above the maximum death is naturally more rapid. Thus the mycelium of *Penicillium* is killed in two days by a temperature 6° C. above the maximum. All flowering plants, and most others as well, seem to be rapidly killed by a temperature 10° C. above the maximum. Sachs and de Vries found, for example, that ten to thirty minutes' immersion in water at 51 to 52° C. killed most flowering plants whose maxima in air lay between 40 to 45° C.³ Indeed prolonged

¹ For instances of this in mosses and lichens cf. Ewart, Journ. of Linn. Soc., 1896, pp. 369, 374, 378, 388.

² Hilbrig, Ueber d. Einfluss supramaximaler Temperatur a. d. Wachstum d. Pflanzen, Leipziger Diss., 1900, p. 15. Similar results were obtained with the aerial parts of seedlings.

³ Sachs, Flora, 1864, p. 33; de Vries, Matériaux p. l. connaissance d. l'influence d. l. température s. l. plantes, 1870, p. 2 (repr. from Archives Néerlandaises, T. v).

exposure to a temperature of from 45 to 46° C. kills most Phanerogams, and a still lower temperature must ultimately cause the death of all those autotrophic plants in which photosynthesis becomes less active than respiration at temperatures of 37 to 39° C.¹ After short exposure to fatally high temperatures plants often appear at first fresh and living, but die as an after-effect of the exposure even under the best external conditions².

The best instance of the different resistances at various stages of development is afforded by bacteria, for in many cases the spores are not killed by boiling for from thirty minutes to several hours, without the organisms being especially resistant in the vegetative condition, although in the case of thermophile forms both stages are unusually resistant to high temperatures. The spores of *Bacillus subtilis*, for instance, can stand half an hour's boiling, although the maximum temperature for growth lies at 50° C., and although in the vegetative condition death soon ensues at 55° C.³

The degree of maturity and the cultural conditions seem to influence the resistant powers of spores, which naturally also differ according to the organism which forms the spores. All degrees of resistance are in fact shown, from spores which withstand several hours' boiling, to those of *Bacillus anthracis*, which are killed in two minutes, and to those which cannot stand boiling at all⁴. The spores of fungi and of yeast are also more resistant than the vegetative cells, although they are readily killed by temperatures lying well beneath 100° C.⁵ The fact that certain seeds when moist are hardly more resistant than the seedlings they produce⁶ shows that the power of resisting moist heat is not connected with the accumulation of reserve materials, or with the power of withstanding desiccation. The same applies to mosses and lichens, for *Bryum caespiticium* and *Cladonia rangiferina* when moist are killed by less than a day's exposure to 45° C., although they can withstand severe desiccation, and in this condition require six hours' exposure to 90° C., or a day's exposure to 70° C., to kill them⁷. That the passage into a resting condition does not always involve an increased resistance to heat is shown by the readiness with which winter buds and resting cambium are killed by high temperatures.

No organism, whether in the spore condition or not, is able to withstand prolonged boiling, and if the water is heated under pressure to from 110

¹ Ewart, Journ. of Linn. Soc., 1896, p. 385.

² Cf. Sachs, Flora, 1864, p. 24.

³ Cohn, Beitr. z. Biol. d. Pflanzen, 1877, Bd. II, p. 271. On *Bacillus carotarum* see Koch, Bot. Ztg., 1888, p. 297.

⁴ Cf. Flüge, Die Mikroorganismen, 1896, 3. Aufl., Bd. I, p. 438.

⁵ Cf. Jörgensen, Mikroorganismen der Gährungsindustrie, 1898, 4. Aufl., p. 180; Kayser, Ann. d. l'Inst. Pasteur, 1889, T. III, p. 513.

⁶ Just, Cohn's Beitr. z. Biol., 1877, Bd. II, p. 346.

⁷ Ewart, l. c., pp. 369, 376, 388.

to 130° C. the most resistant spores are soon killed. Cohn¹ observed that the spores of *Bacillus subtilis*, which are killed by thirty to sixty minutes' boiling, may be kept for three or four days in water at 70 to 80° C. before they are fatally affected. If, however, a spore germinates, its resistance decreases, so that sterilization may be ensured by heating to 100° C. for a short time during several successive days.

Pasteur² recognized that many bacteria were only killed by prolonged boiling, which Cohn³ and Brefeld⁴ showed to be due to the high resistance of the spores. Thermo-bacteria are, however, also resistant to heat in the vegetative condition. The problem of disinfection has given rise to many researches in this direction⁵, and these have shown that death ensues sooner in boiling water than in steam at atmospheric pressure.

The spores of various hay and potato bacteria, those of *Bacillus mesentericus vulgaris*⁶, of *Bacillus butylicus*⁷, and of various thermo-bacteria⁸, require from a half to several hours' boiling to kill them. [It is possible that the high resistance of spores is due to the relative impermeability of the spore-wall, and to the spore-contents passing into a partially desiccated condition during ripening, even when permanently immersed under water. That water is excreted during spore-formation is evident when the entire contents of the vegetative cell contract considerably to form a single spore, but this occurs also in *Bacillus anthracis*, whose spores are only slightly resistant to boiling. If the resistance of the spore were in part due to the desiccated condition of its living contents, the ultimately fatal action of boiling water might be due to its causing the spore-wall to swell or become permeable, the entry of water lowering the power of resistance to heat. There can, however, be little doubt that the increased resistance of the spore is, in part at least, due to some change in the inherent properties of its living contents apart from the influence of mere desiccation.—ED.]

In very many cases the power of resistance varies at different stages of development. Thus Sachs⁹ and also de Vries¹⁰ have shown that

¹ Just, Cohn's Beitr. z. Biol., 1877, Bd. II, p. 346; Cohn, *ibid.*, p. 271. Cf. also Gruber, Centralbl. f. Bact., 1888, Bd. III, p. 576.

² Pasteur, Ann. d. Chim. et d. Physique, 1862, 3^e sér., T. LXIV, p. 58; Étude s. l. bière, 1876, p. 34; Pasteur and Joubert, Compt. rend., 1877, T. LXXXIV, p. 206. Pasteur gives the older literature, including that dealing with spontaneous generation.

³ Cohn, l. c., p. 250.

⁴ Brefeld, Unters. ü. d. Spaltpilze, 1878, p. 10 (repr. from Sitzungsber. d. naturf. Freunde in Berlin); Bot. Unters. ü. Schimmelpilze, 1881, Heft 4, p. 51.

⁵ Cf. Flügge, Die Mikroorganismen, 1896, 3. Aufl., Bd. I, p. 438; de Bary, Verh. Morphol. u. Biol. d. Pilze, 1884, p. 515.

⁶ Strub, Centralbl. f. Bact., 1890, Bd. VII, p. 728.

⁷ Cf. de Bary, l. c.; also Schattenfroh and Grassberger, Centralbl. f. Bact., 1900, 2. Abth., Bd. VI, p. 411.

⁸ Rabinowitsch, Zeitschr. f. Hygiene, 1895, Bd. XX, p. 154.

⁹ Sachs, Flora, 1864, p. 4.

¹⁰ de Vries, Matériaux pour l. connaissance d. l'influence d. l. température s. l. plantes, 1870, p. 4; Sur la mort d. cellules végétales, 1871, p. 25 (repr. from Archives Néerlandaises, T. VI).

developing stems, leaves, and roots are more readily killed than when they are adult. Spores, however, afford instances in which the cell is most resistant when young. Presumably resting buds are less readily killed by heat than expanding ones, and that all the cells of a plant are not equally resistant is shown by the fact that moderately high temperatures cause some cells to die but not others¹.

Plants endowed with sufficient plasticity may gradually accustom themselves to temperatures which prove fatal when suddenly applied. It may also be expected that the resistance to heat decreases when the plant is weakened, or the external conditions are unfavourable. In any case a high temperature shortens life when the supply of food is limited, owing to the more active metabolism. Furthermore, seedlings of *Zea Mays* die in the absence of oxygen after twelve hours at 40° C., after twenty-four hours at 18° C., and after a few days at low temperatures. Hence Just² found that seeds submerged in water are injured by high temperatures sooner when the supply of oxygen is deficient than when it is abundant. When seedlings are placed under warm water more oxygen is required for the increased respiration, but the absorption of this gas is rendered more difficult owing to the decreased solubility of oxygen in warm water. Hence Mazé found that the seedling respired in part anaerobically and produced alcohol³. Sachs found that plants suspended in moist air were more resistant to heat than when submerged in water. Possibly the objects transpired slightly in the moist air and so were cooled, while in water, since the plants assume the same temperature almost instantly, they are exposed to the higher temperature for a longer time even when the measured times of exposure are the same.

It is not quite certain to what extent the action of poisons is increased by a rise of temperature⁴. The result obtained probably depends upon the poison used and upon whether it undergoes dissociation or not, for in the former case the number of free ions in the solution increases with rising temperature, and it is upon these free ions that the poisonous action of a dissociating substance largely depends. Nägeli found that bacteria were either killed at 30 or at 110° C. according to the character of the nutrient medium, but he seems to have worked with impure cultures and hence the observations have little value⁵. Pasteur⁶, however, found that bacteria were more resistant to heat in alkaline than in sour milk, although Cohn

¹ De Vries, Sur la mort de cellules végétales, 1871, p. 25. On the higher resistance of the guard-cells of stomata cf. Leitgeb, Mittheil. a. d. Bot. Inst. zu Graz, 1886, I, p. 133.

² Just, Cohn's Beitr. z. Biol., 1877, Bd. II, p. 346.

³ Mazé, Compt. rend., 1899, T. CXXXVIII, p. 1,603.

⁴ Cf. Ewart, Protoplasmic Streaming, 1903, p. 88.

⁵ Nägeli, Die niederen Pilze, 1877, pp. 30, 200.

⁶ Pasteur, Compt. rend., 1877, T. LXXXIV, p. 206; Brefeld, Unters. ü. d. Spaltpilze, 1878, p. 10. Cf. also Cohn, Beitr. z. Biol., 1877, Bd. II, pp. 25, 259.

and Brefeld, on the contrary, observed no such increased resistance in alkaline solutions.

In the case of organisms which can withstand desiccation, the power of resistance to heat is greatly increased by complete drying. Thus many thoroughly dried seeds, mosses, lichens, fungus spores, and bacteria are not killed by exposure to temperatures of 100 to as much as 110 or even 120° C. for one or more hours. The presence of a very small amount of water considerably lowers the resistance, so that air-dried seeds are soon killed at 100° C., or even at 60 to 80° C., if they have been previously kept in moist air for some time. In many experiments no precautions were taken to ensure perfect dryness, so that the deaths observed at temperatures of 60° C. may have been due to the presence of water¹. There may of course be plants which, even when perfectly dry, are soon killed by temperatures at all approaching 100° C. Indeed in all cases the vitality of desiccated plants is ultimately lost, and at high temperatures more rapidly than at normal ones. Especially good instances of graduated resistance are afforded by mosses and lichens². Furthermore, many plants killed at 40 to 50° C. when turgid are highly resistant when dried³.

The resistance of dried plants to heat was first established by Spallanzani⁴, and subsequently confirmed by various investigators in the case of seeds⁵, mosses and lichens⁶, fungus spores⁷, yeast-cells⁸, and bacteria⁹. Krasan, Just, and Höhnel worked with completely dried seeds and found that many oily and starchy seeds could withstand long heating to 110° C., or short exposure to 120° C. The first indication of commencing injury is shown by the delay in germination. Since the resistant spores of certain bacteria can withstand a temperature of 130° C. for a few hours, and one of 140° C. for a short time, rapid perfect sterilization can only be assured in the case of dry objects by heating to temperatures of from 150 to 170° C.

¹ As regards animals cf. Artari, Abhandl. der naturf. Ges. in Halle, Bd. XXXI, p. 120.

² Thus, using desiccated plants, and with an exposure of six hours, *Grimmia conferta* and *Orthotrichum affine* were only killed at 95° C., *Ceratodon purpureum* and *Bryum caespiticium* at 90° C., *Barbula muralis* at 85° C., and *Dicranum scoparium* at 80° C. Cf. Ewart, Journ. Linn. Soc., Vol. XXXI, 1896, p. 369.

³ For instances cf. Ewart, l. c., pp. 369, 374, 378, 388.

⁴ Opuscles d. physique animale et végétale, translated by Senebier, 1777, T. I, pp. 58, 62.

⁵ See Nobbe, Samenkunde, 1876, p. 227; v. Höhnel, Wiss.-pract. Unters. a. d. Gebiete d. Pflanzenlaubes, 1877, II, p. 77; Just, Cohn's Beitr. z. Biol., 1877, Bd. II, p. 311, and the literature there quoted. Rittinghaus (Verh. d. naturh. Vereins d. Rheinlande, Jahrg. XLIII, 5. Folge, Bd. III) states that pollen-grains are in part killed by heating to 100° C. for fifteen minutes. See also Konno, Bot. Jahresb., 1898, 1. Abth., p. 609.

⁶ Ewart, l. c., pp. 369-88.

⁷ For the literature see de Bary, Morphol. u. Biologie d. Pilze, 1884, p. 372.

⁸ Manassein, Wiesner's mikros. Untersuchungen, 1872, p. 122; Artari, l. c.; Kayser, Ann. d. l'Inst. Pasteur, 1889, T. III, p. 520.

⁹ Pasteur, Ann. d. chim. et d. physique, 1862, 3^e sér., T. LXIV, p. 90; Nägeli, Die niederen Pilze, 1877, p. 202. See also the literature given by Flügge, Mikroorganismen, 1896, 3. Aufl., Bd. I, p. 437.

The causes which determine the varying resistances of different plants to heat are quite unknown. The fact that a temperature of from 20 to 40° C. kills certain plants shows that in this case death is not the result of the coagulation of the plant albumin. Further, some plants grow at 75° C., i. e. above the temperature at which egg-albumin coagulates. Coagulation need not always occur, for we must remember that the acid and alkali albumins are not coagulated by heat, and that the presence of silver¹, iron², or various organic substances³ may retard coagulation. Hence it is not surprising that the spores of many bacteria are only killed by prolonged boiling. Since spores taken fresh from a culture solution, and therefore saturated with water, are equally resistant, this special power is not the result of desiccation, as Cohn⁴ and certain other authors have supposed⁵. Perfect desiccation not only decreases or inhibits many chemical reactions, but also renders the seed incapable of any vital response⁶. The presence of very little water considerably reduces the resistance of a dry seed to heat, and hence the accumulation of soluble reserve materials in a turgid cell is unable to produce a sufficient decrease in the percentage of water to influence the power of resistance to heat.

The observations upon the growth of organisms in very hot springs need to be accepted with some caution, since it is not certain that the plant was actually at the temperature given by immersing a thermometer in the surrounding water. Neither transpiration nor the existence of protective sheaths are of any avail in the case of submerged microscopic organisms, although in large plants partly exposed to air both factors may aid in keeping down the internal temperature of the plant. It is not certain whether roots develop abundantly in those layers of tropical soils which may acquire a temperature of from 60 to 75° C. during the day, and if they do, whether the roots have a high specific resistance, or avoid injury by special means⁷. The roots of our indigenous cereals die in a few days if the temperature of the soil is kept at 50° C.⁸, but other plants may behave

¹ Van der Does, *Zeitsch. f. physiol. Chem.*, 1897, Bd. xxiv, p. 351.

² Clautriau, *La digestion d. l. urnes de Nepenthes*, 1900, p. 25 (repr. from *Mém. couronnés*, etc., publiés p. l'Acad. royale de Belgique, 1900).

³ Spiro, *Zeitschr. f. physiol. Chem.*, 1900, Bd. xxx, p. 182. Cf. also Cohnheim, *Chemie d. Eiweisskörper*, 1900, p. 9.

⁴ Cohn, *Beitr. z. Biol.*, 1877, Bd. 11, p. 266.

⁵ Cramer, *Centralbl. f. Bact.*, 1892, Bd. XI, p. 453. The resistance may be aided by the non-absorption of water, and hence Pouchet found (*Compt. rend.*, 1866, T. LXIII, p. 939) that the seeds of *Medicago* were still capable of germination after being in boiling water for four hours. Similarly the seeds of stone fruits that have been made into jam have been known to germinate. Cf. also Nobbe, *Samenkunde*, 1876, p. 228.

⁶ Certain combustions (viz. phosphorus in oxygen) only take place in the presence of a trace of moisture. As regards the influence of the percentage of water upon the temperature of coagulation of egg-albumin cf. Lewith, *Centralbl. f. Physiol.*, 1890, Bd. iv, p. 382.

⁷ For the literature see Nobbe, *Samenkunde*, 1876, p. 229; Kerner and Oliver, *Natural History of Plants*, Vol. 1, p. 554.

⁸ Bialoblocki, *Einfluss der Bodenwärme auf die Entwicklung einiger Culturpflanzen*, 1872.

differently. Humboldt¹ states that the roots of various plants grow in the hot springs of Trincherá (Caracas) at temperatures reaching 85°C., but this requires further proof. Fleshy leaves exposed to sunlight may reach a temperature of 52°C., which is fatal to them if unduly prolonged. The fact that plants grow when exposed to full sunlight shows that these temperatures can be withstood for a short time, though not always without injury². Drops of water may also concentrate the sun's rays sufficiently to produce local injury³. Dried mosses and lichens are able to maintain themselves on dark exposed rocks which grow very hot during prolonged insolation⁴.

De Vries exposed plants for fifteen minutes to various temperatures, the roots being in water or soil, the shoots in air, or in water when cuttings were used⁵. Mosses and algae were placed under water. In this way the following table was constructed, in which the columns marked *A* give the highest temperatures at which the plants were uninjured, and those marked *B*, the temperatures which caused death.

	In water.		The roots in soil, the rest in air.	
	A	B	A	B
	Deg. C.	Deg. C.	Deg. C.	Deg. C.
<i>Zea Mays</i> , root	45·5	47·0	50·1	52·2
<i>Phaseolus vulgaris</i> , root	45·5	47·0	50·0	51·5
<i>Iris florentina</i> {	tip of leaf	49·0	49·7	53·2
	base of leaf	49·7	51·5	55·0
<i>Vinca minor</i> {	young leaf	46·2	47·8	51·0
	old leaf	47·8	50·1	53·0
<i>Funaria hygrometrica</i>	40·2	43·4		
<i>Marchantia polymorpha</i>	44·9	46·4		
<i>Oedogonium</i> sp.	42·2	44·2		
<i>Oscillaria Fröhlichii</i>	43·4	45·1		
<i>O. anguina</i>				
<i>O. chlorina</i>				

¹ Cf. Bot. Ztg., 1876, p. 783.

² Cf. Ewart, The Effects of Tropical Insolation, Annals of Botany, Vol. XI, 1897, p. 439; Vol. XII, 1898, pp. 384-9.

³ Frank, Krankheiten d. Pflanzen, 1895, 2. Aufl., Bd. I, p. 175.

⁴ Kerner and Oliver, Natural History of Plants, Vol. I, p. 554.

⁵ De Vries, Matériaux p. l. connaissance d. l'influence d. l. température s. l. plantes, 1870, p. 3 (repr. from Archives Néerlandaises, T. III). For further details see Meyen, Physiologie, 1838, Bd. II, p. 313; Edwards and Colin, Ann. d. sci. nat., 1834, 2^e sér., T. I, p. 263; Heinrich, Versuchsstat., 1870, Bd. XIII, p. 148 (*Holtonia*); Velten, Flora, 1876, p. 212 (*Vallisneria*); Scheltinga, Bot. Jahrb., 1876, p. 719 (water-plants); Schultze, Protoplasma d. Rhizopoden und Pflanzenzellen, 1863, p. 48; Strasburger, Wirkung des Lichtes u. der Wärme auf Schwärmosporen, 1878, p. 61; Ewart, On Protoplasmic Streaming, 1903, pp. 59-66 (streaming cells). Kühne (Unters. über d. Protoplasma, 1864, p. 87) states that the plasmodia of *Aethalium septicum* die after two minutes' warming to 43°C., and those of *Didymium serpula* after short heating to 35°C.

SECTION 66. Freezing and Cold-rigor.

A sufficient rise of temperature always produces death, whereas dried seeds and spores and certain bacteria, even when moist, can withstand temperatures as low as -200°C . Most plants are, however, killed by a sufficient degree of cold, the intensity of which varies considerably in different cases. Thus the aerial parts of *Cucumis sativus*, *Cucurbita Pepo*, *Ricinus communis*, *Impatiens balsamina*, *Phaseolus nanus*, and *Solanum tuberosum* are partly or entirely killed by a single night's exposure to a temperature of from -2 to -4°C . Such plants as *Stellaria media*, *Senecio vulgaris*, *Lamium amplexicaule*, *Urtica urens*, and *Bellis perennis* are only killed after prolonged exposure to temperatures lying between -6 and -9°C ., while *Helleborus foetidus* can even withstand -17°C .¹ Similar and even lower temperatures must be withstood by the trees of north Europe during winter. Indeed *Larix sibirica*, as well as a few other Phanerogams and certain mosses and lichens, grow in the arctic regions where the temperature during winter lies between -30 and -50°C ., and the plants are often frozen stiff for six months in the year².

Since plants are poikilothermic organisms in which the small amount of heat produced by metabolism is rapidly lost by radiation and transpiration, they assume approximately the same temperature as that of the surrounding medium. Hence trees, and those mosses and lichens which grow on rocks to which the snow does not adhere, follow the changes of temperature of the air more or less rapidly, according to their mass, specific heat, and conductivity, and according to the presence or absence of wind and of moisture. Hence when the external temperature is low, a formation of ice takes place in the plant, and the ice usually suddenly appears after the plant has been cooled a few degrees below the freezing-point of its sap. As a natural physical result, herbaceous plants such as *Stellaria media* and *Ranunculus glacialis* become stiff and brittle when frozen, while the frozen trunk of a tree offers great resistance to the penetration of an axe. In the above and other resistant plants, the formation of ice is not followed by death³, as it is in most plants, and also in potatoes, beetroots, and apples. That death is in many cases the direct result of the formation of ice is shown by the fact that in its absence the same temperature may no longer be fatal. Thus a peeled potato in which ice

¹ Göppert, Wärmeentwicklung i. d. Pflanze, 1830, p. 94; Bot. Ztg., 1875, p. 613; Ueber d. Gefrieren u. Erfrieren d. Pflanze, 1883; Frank, Krankheiten d. Pflanzen, 1894, 2. Aufl., Bd. 1, p. 197; Büsgen, Waldbäume, 1897, p. 43.

² See Göppert, l. c., p. 59; Drude, Handb. der Pflanzengeographie, 1890, p. 24; Schimper, Pflanzengeographie, 1898, p. 45.

³ This fact has long been known. Cf. Duhamel, Naturgesch. der Bäume, 1765, Bd. II, p. 298; Göppert, l. c., pp. 11, 228.

forms at -1°C . is killed at this temperature, whereas an unpeeled one, in which ice-formation takes place only after sub-cooling to -3 or -4°C ., can be kept for a few days at a temperature of -2°C . without injury¹. Many plants behave similarly, and when a formation of ice occurs only at localized points in a leaf sensitive to frost, these areas alone are killed².

Since an organism could hardly maintain itself indefinitely at a temperature below the minimum for growth, it is to be expected that plants, and especially those from warm regions, should ultimately die at low temperatures not falling below zero. Molisch³ found in fact that the leaves of *Episcia bicolor* and of *Sciadocalyx Warszewiczii* were injured in eighteen to twenty-four hours and killed in five days by a temperature fluctuating between 1.4 and 3.7°C . Under similar conditions the leaves of *Tradescantia discolor* and of *Tournefortia hirsutissima* were injured in eight days and killed in twenty-seven. *Aspidium violascens* is still more sensitive, while *Epidendrum floribundum*, which ceases to assimilate carbon dioxide at 5°C ., and *Mimosa pudica*, which loses the power of photosynthesis at 8°C ., cannot exist for any length of time at these temperatures⁴. Göppert⁵ also mentions that various plants which survive transitory exposure to -2 or -3°C ., die when kept for one or two days at -1°C ., a temperature at which no ice-formation presumably occurs. Furthermore, the radicles of *Cucurbita Pepo* and of *Phaseolus vulgaris* die in parts after remaining for four weeks at from 0 to 1°C . It is easy to understand that, owing to the depressant effect of low temperatures upon metabolism, they should take longer to produce a fatal effect than high ones, which steadily accelerate respiration. Indeed all perennial plants whose growth is in nature interrupted by cold seasons must be able to survive these periods of cold-rigor if they are to maintain themselves.

Death from cold-rigor may take place with or without a formation of ice, and the latter does not always cause death. Frozen plants are by no means unchangeable or non-sensitive, for in the first place they die in time, and a further fall of temperature may bring about this result immediately. For instance, fruit and other trees are killed by unusually cold winters, although they bear the cold of most winters without injury⁶.

¹ Müller-Thurgau, Landw. Jahrb., 1886, Bd. xv, pp. 488, 505. See also Müller, Landw. Jahrb., 1880, Bd. ix, p. 133.

² Müller-Thurgau, l. c., p. 505.

³ Molisch, Unters. ü. d. Erfrieren d. Pflanzen, 1897, p. 61. Göppert, Hardy, and Kunisch (cf. Molisch, l. c., p. 56) also observed death above zero, but sufficient precautions were not taken to ensure that the temperature did not fall below that indicated by the thermometer.

⁴ Ewart, Journ. of Linn. Soc., 1896, Vol. xxi, p. 399.

⁵ Göppert, Wärmeentwicklung i. d. Pflanze, 1830, p. 63; Ueber d. Gefrieren u. Erfrieren d. Pflanze, 1883, p. 50.

⁶ For observations on animals cf. Welter, Die tiefen Temperaturen, 1895, p. 75; Bachmetjew, Zeitschr. f. wiss. Zool., 1899, Bd. lxxvi, p. 524; Labbé, La Cytologie, 1898, p. 37.

The death of plants unable to withstand desiccation is directly due to the withdrawal of water consequent upon the formation of ice, and this must be nearly complete at -30°C . Pictet¹ observed that rotifers capable of withstanding desiccation were entirely killed by a day's exposure to from -150 to -160°C ., but only in part when kept for the same time at -80 to -90°C ., while at -60°C . all remained living. It is indeed possible that some bacteria are only killed by temperatures of from -100 to -200°C . Whether this is due to the withdrawal of the water of imbibition or not, it is certain that a further fall of temperature may produce death after the whole of the cell-sap has frozen. Bearing in mind also that perfectly dry seeds and spores ultimately die, it may safely be assumed that vitality is not preserved indefinitely long at very low temperatures whether the plant was previously dried or left saturated with water. The experiments with rotifers show indeed that at very low temperatures life may be shortened, and de Candolle found that dry seeds of *Lobelia Erinus* lost their vitality sooner at very low temperatures than at ordinary ones².

The fact that many chemical actions cease at very low temperatures³ does not afford any general explanation of the death produced by cold in organisms capable of withstanding desiccation, nor are physiological experiments altogether satisfactory in which the period of exposure is relatively short. Vitality may be maintained for a long time in various conditions of rigor, and that this also applies to cold-rigor is shown by the fact that arctic plants may remain living although frozen for half the year⁴.

These effects are produced by slow as well as by rapid cooling, and it is the low temperature and not the thawing which produces death. A non-resistant plant is killed by the actual freezing and cannot be saved by the most careful thawing, whereas resistant plants remain living however rapidly they may be thawed. Thus plants of *Stellaria media* frozen at -6°C . remain living when suddenly brought into a warm room, or when thawed by immersion in water at 25°C . Frisch⁵ observed that motile bacteria frozen at -59°C . immediately began to move when thawed in less than a minute.

The power of withstanding these rapid changes is of great importance in nature, for the sun's rays may rapidly thaw frozen plants, especially in

¹ Pictet, Archives d. sci. phys. et nat. d. Genève, 1893, 3^e sér., T. XXX, p. 311.

² Nägeli (Sitzungsab. d. Münchener Akad. 1861, I, p. 271) erroneously supposed that a further fall of temperature was without effect when the plant was once frozen stiff.

³ Pictet, Zeitschr. f. physikal. Chem., 1895, Bd. XVI, p. 417.

⁴ According to Charpentier (Bot. Ztg., 1843, p. 13) *Trifolium alpinum*, *T. caespitosum*, *Geum montanum*, and *Cerastium latifolium* continued to grow after being buried for four years under a glacier. They were not, however, frozen the whole of this time, since during summer the temperature beneath the ice might rise up to or even above zero.

⁵ Frisch, Sitzungsab. d. Wiener Akad., 1877, 3. Abth., Bd. LXXV, p. 257.

alpine regions. Neither Müller-Thurgau¹ nor Molisch² could as a rule detect any injurious effect due to sudden thawing. Molisch found, however, that apples and pears, and also the leaf of *Agave americana*, after moderate freezing remained living if very gradually thawed, but died when the thawing was rapid.

Resistant plants withstand rapid and slow cooling equally well, and it is doubtful whether a rapid fall of temperature is more injurious to plants killed by freezing than is gradual cooling. That the injury is not due to the sudden formation of ice after sub-cooling is shown by the fact that a peeled potato is killed by freezing, although no sub-cooling occurs and the ice forms gradually at -1°C ., the freezing-point of the sap³.

No demand is entirely without effect, and hence it is not surprising that repeated freezing and thawing should prove injurious. Thus Göppert⁴ found that *Lamium purpureum*, *Stellaria media*, and *Helleborus niger* were killed when frozen at -4 to -5°C . and thawed at room-temperature for more than six times in succession. In the open without these changes the plants withstood temperatures of -11 to -12°C .

Göppert⁵ concluded that death by cold was the direct effect of freezing, whereas Sachs⁶ was of the opinion that death occurred during thawing, and could be avoided by making this process take place slowly. Müller-Thurgau's investigations have, however, revealed the true state of affairs.

Usually it can only be told on thawing whether the plant is alive or dead, but in some cases reactions occur which indicate the death of a frozen plant. Thus Göppert⁷ showed that the blue colouration due to the separation of indigo in the perianth leaves of *Phajus*, *Calanthe*, and other orchids was a sign of death, whether produced by cold or other agencies. Detmer⁸ used the change of colour in *Begonia manicata*, Molisch⁹ that in the red alga *Nitophyllum peltatum*, and also the odour due to the liberation of cumarin, as signs of death.

Not only does the resistance of different plants vary, but also that of

¹ Müller-Thurgau, Landw. Jahrb., 1886, Bd. xv, p. 506.

² Molisch, Das Erfrieren d. Pflanzen, 1897, p. 34. Any water left in the intercellular spaces on thawing is rapidly reabsorbed.

³ Müller-Thurgau, Schweiz. Zeitschr. für Obst- u. Weinbau, 1894.

⁴ Göppert, Wärmeentwicklung in der Pflanze, 1830, p. 62; Ueber das Gefrieren und Erfrieren d. Pflanze, 1883, p. 49.

⁵ Göppert, l. c., p. 232; Bot. Ztg., 1871, p. 73. Cf. Kunisch, Ueber die tödtliche Einwirkung niederer Temperaturen, Diss., 1880, p. 42.

⁶ Sachs, Sitzungsber. der Sächs. Ges. der Wiss. zu Leipzig, 1860, Bd. xii, p. 27; Versuchsst., 1860, Bd. 11, p. 175. Duhamel (Naturgeschichte der Bäume, 1765, Bd. 11, p. 277) made a similar assumption. Cf. the literature quoted by Müller-Thurgau, l. c., 1886, p. 506. Müller-Thurgau also explains how Sachs was misled.

⁷ Göppert, Bot. Ztg., 1871, p. 339; Müller-Thurgau, Landw. Jahrb., 1880, Bd. ix, pp. 162, 166; 1886, p. 515; Molisch, l. c., p. 35. That the blue colouration was due to a formation of indigo was recognized by Marquart in 1830. Kunisch (l. c., pp. 37, 50) states that it also occurs in the absence of oxygen.

⁸ Detmer, Bot. Ztg., 1886, p. 521.

⁹ Molisch, l. c., pp. 38, 41.

different organs on the same plant, according to their specific character¹ and stage of development. A good instance of the latter is afforded by the winter buds of trees, which are highly resistant, although the expanding leaves and flowers are readily killed by frost. Soaked seeds are somewhat more resistant than the seedlings². Seeds exposed on the surface will be dry and hence fully resistant, while moist ones will be partially protected by the layers of soil covering them.

As the result of adaptation, most tropical plants are readily killed by cold, although some are actually more resistant than certain temperate plants or than particular organs adapted only for growth during summer³. Plants with a low minimum for growth are not always especially resistant to cold, for the swarm spores of *Ulothrix zonata* are killed by freezing at -1°C .⁴, although the minimum temperature for growth and for their movement lies at 0°C . It has yet to be determined whether those marine algae are especially resistant which grow at -1.8°C . but are not naturally cooled appreciably below this.

The resistance to cold depends to a certain extent upon the present and previous external conditions. Thus Haberlandt⁵ found that seedlings grown at 18 to 20°C . froze more readily than those grown at 8°C . Göppert⁶ observed that *Senecio vulgaris*, *Poa annua*, and *Fumaria officinalis*, which had been exposed to temperatures as low as -11°C . during November and December, were killed by freezing at -9°C . after they had been in a warm house for a fortnight. In etiolated plants the power of resistance seems also to be decreased. It is probably in adaptation with their habitat that plants grown in alpine regions are somewhat more resistant to cold than individuals of the same species grown in the plains beneath.

Unfavourable conditions appear in general to reduce the power of resistance to cold, and a deficiency or excess of water or of a food-material acts in this way⁷. A variety of other factors may also enter into play, and hence it arises that Coniferae with a north exposure are usually more, but occasionally less, resistant than those facing south.

The influence of the withdrawal of water. It appears as though objects

¹ The roots are usually less resistant than stems (Mohl, Bot. Ztg., 1848, p. 6; 1862, p. 324; Göppert, Ueber das Gefrieren und Erfrieren d. Pflanze, 1883, p. 56).

² Göppert, Die Wärmeentwicklung in der Pflanze, 1830, p. 43; G. Haberlandt, Die Schutzeinrichtungen d. Keimpflanze, 1877, p. 48.

³ Cf. Karsten, Bot. Ztg., 1861, p. 289; Göppert, Bot. Jahresb., 1873, p. 263; Naudin, Ann. d. sci. nat., 1877, 6^e sér., T. v, p. 323.

⁴ Strasburger, Wirkung d. Lichtes u. d. Wärme auf Schwärmosporen, 1878, p. 62.

⁵ G. Haberlandt, Die Schutzeinrichtungen d. Keimpflanze, 1877, p. 48; Bot. Jahresb., 1879, p. 259.

⁶ Göppert, l. c., 1830, p. 63.

⁷ Cf. Müller-Thurgau, Landw. Jahrb., 1886, Bd. xv, p. 543. Also Duhamel, Naturgesch. d. Bäume, 1765, Bd. II, p. 270.

capable of withstanding desiccation cannot be killed by any attainable cold¹. The exposures were, however, only of short duration, and even Brown and Escombe only used temperatures of -183 to -192°C . lasting for 110 hours. Longer exposures might produce death, and in fact de Candolle² found that after 118 days' exposure to a temperature lying between -37 and -57°C ., and occasionally rising above -37°C ., the seeds of *Lobelia Erinus* had lost their vitality, whereas those of *Avena*, *Triticum*, and others were unaffected. The addition of successive amounts of water produces a gradual decrease of resistance until that of the turgid object is reached. In some cases the plant, or its aerial parts, is killed by cold owing to the fact that it is unable to obtain sufficient water from the frozen soil to cover the loss by transpiration³. In arctic climates, where the ground is frozen for long periods, it is of importance that woody plants should possess xerophilous characters to protect them from excessive transpiration⁴.

Protection against cold. Although plants always ultimately assume the temperature of the surrounding medium, nevertheless any means of hindering cooling may afford a temporary protection against low temperatures of short duration⁵. The covering of the plant with earth, snow, or straw is, however, of far greater importance in this respect, especially in preventing the loss of heat by radiation, which may cause the temperature of the plant to fall to 8°C . below that of the surrounding air. Under such circumstances plants may be frozen stiff although the thermometer indicates one or two degrees above zero. The older observations upon the death of plants above zero were probably due to this cause.

Fog, smoke, and dust all hinder radiation, and the use of smoky fires as a preventive against frost on clear nights was known to Pliny and to the Peruvians before the discovery of America⁶. Obviously the fire should be kindled early in the night, since the insulating value of the smoke lies in the fact that it acts as a check to radiation, and is not due to its hindering the absorption of heat and consequent rapid thawing in the morning⁷. Indeed the slowest thawing is usually of no avail, and the useful effects of watering the frozen plants are probably due to the more ready restoration of turgidity on thawing.

¹ Pictet (Archives d. sci. phys. et nat. d. Genève, 1893, 3^e sér., T. XXX, p. 311) attained -200°C . with liquid air (cf. Brown and Escombe, Proceed. of the Royal Society, 1897, Vol. LXII, p. 160), and Thiselton-Dyer (ibid., 1899, Vol. LXV, p. 362) attained -250°C . by means of liquid hydrogen. In the earlier researches by Pictet, de Candolle, Edwards and Collin, Göppert, the temperatures were not so low.

² C. de Candolle, Archives d. sci. phys. et nat. de Genève, 1895, 3^e sér., T. XXXIII, p. 504.

³ Cf. the works of Kihlmann (quoted in Vol. I, p. 213) and Stenström; also Göppert, Die Wärmeentwicklung in der Pflanze, 1830, p. 58; Molisch, Das Erfrieren der Pflanzen, 1897, p. 50; Schimper, Pflanzengeographie, 1898, pp. 45, 717. On transpiration at low temperatures cf. Prillieux, Compt. rend., 1872, T. LXXIV, p. 1344.

⁴ Kihlmann, Stenström, l. c. The bud-scales form no protection against cold, but solely against transpiration and other injurious external agencies. Cf. Grüss, Jahrb. f. wiss. Bot., 1892, Bd. XXIII, p. 669.

⁵ For details see Müller-Thurgau, Landw. Jahrb., 1886, Bd. xv, p. 538; Göppert, Ueber das Gefrieren und Erfrieren d. Pflanze, 1883, p. 67; Frank, Krankheiten d. Pflanzen, 1895, 2. Aufl., Bd. I, p. 214.

⁶ Cf. Göppert, l. c., 1830, p. 230; Boussingault, Agronom., chim. agricole et physiol., 1862, T. II, p. 384.

⁷ Müller-Thurgau, l. c., p. 555.

Instances of specific resistance have already been given in the case of flowering plants¹. Very many lichens are extremely resistant to cold, and the same applies to many algae. Thus Göppert² found that the red snow organism *Sphaerella nivalis* was not affected by a temperature of -36°C . Schumann³ found that diatoms remained living at -20°C ., and Pictet⁴ even at -200°C . All diatoms do not behave similarly, and the resistance is least when growth is most active. Thus Ewart⁵ found that the actively vegetating forms of various diatoms were killed by freezing at -8 to -10°C . Our indigenous species of *Spirogyra*, *Cladophora*, and *Vaucheria* are relatively sensitive to cold when actively vegetating, and usually only the oospores or zygotes can resist actual freezing⁶. Many algae with a low minimum for growth are readily killed by frost, and indeed some of the algae from warm seas may possibly die at temperatures above zero.

Fungi. Many species of *Polyporus* can withstand the severest winter cold, whereas various Agaricineae are readily killed by frost⁷. In all cases the spores appear to be highly resistant, and according to Chodat⁸ the spores of *Mucor mucedo* are not killed by exposure to a temperature of -110°C . Chodat's statement that the vegetative mycelium of *Mucor* is equally resistant requires further proof, since it is readily killed by the withdrawal of water, although encysted portions ('endospores') may remain living. Further, Hoffmann⁹ has shown that the mycelia of *Penicillium* and *Botrytis* are readily killed by freezing. The plasmodia of *Aethalium* and other Myxomycetes are unable to withstand severe cold¹⁰, and small Amoebae appear always to be killed when ice forms in them¹¹.

Bacteria are so resistant, even in the vegetative condition, that they are probably hardly ever killed by natural cold. Only a few species were killed by prolonged exposure¹², and neither the spores nor the vegetative cells of a variety of forms were killed by an exposure of several hours to -200°C .¹³ Pictet and Yung¹⁴, however, found that *Micrococcus luteus* and the vegetative cells of *Bacillus anthracis* were killed by an exposure of 108 hours at -70°C ., and then twenty hours at -130°C ., whereas the spores of *Bacillus anthracis*, *B. subtilis*, *B. ulna* were unaffected.

¹ On varieties resistant to frost cf. Noll, Landw. Jahrb., 1885, p. 708. On pollen-grains cf. Rittinghaus, Verh. d. naturw. Vereins d. Rheinlande, Jahrg. 43, 5. Folge, Bd. III, p. 164.

² Göppert, Bot. Ztg., 1875, p. 615.

³ Quoted by Göppert, l. c.

⁴ Pictet, Archives d. sci. phys. et nat. d. Genève, 1893, 3^e sér., T. XXX, p. 311.

⁵ Ewart, Annals of Botany, 1898, Vol. XII, p. 366.

⁶ Id., l. c.; W. Went and G. S. Went, Annals of Botany, 1898, Vol. XII, p. 33; Molisch, Das Erfrieren d. Pflanzen, 1897, p. 21.

⁷ Cf. Schmitz, Linnaea, 1843, Bd. XVII, p. 445; Fries, Ann. d. sci. nat., 1859, 4^e sér., T. XI, p. 304; Göppert, l. c., p. 614; Ueber das Gefrieren und Erfrieren d. Pflanze, 1883, p. 57.

⁸ Chodat, Bull. d. l'Herbier Boissier, 1896, T. IV, p. 894.

⁹ Hoffmann, Jahrb. f. wiss. Bot., 1860, Bd. II, p. 321. Cf. also Molisch, l. c., 1897, p. 18.

¹⁰ Kühne, Unters. ü. d. Protoplasma, 1864, p. 88.

¹¹ Molisch, l. c., p. 47.

¹² Cf. Flüge, Mikroorganismen, 1896, 3 Aufl., Bd. I, p. 440.

¹³ Schuhmacher, Sitzungsber. der Wiener Akad., 1874, 1. Abth., Bd. LXX, p. 177 (-113°C . with ether and solid carbon dioxide); Frisch, ibid., 1880, Bd. LXXX, III, p. 77; Pictet, l. c. (up to -200°C .); Dewar and McKendrick, Royal Soc. Proc., 1892, Vol. XIII, p. 699 (-182°C .); Meyer, Centralbl. f. Bact., 1900, 1. Abth., Bd. XXVIII, p. 594.

¹⁴ Pictet and Yung, Compt. rend., 1884, T. XCVIII, p. 747.

Yeast-cells were observed by Schumacher to be in part killed at -114°C . Melsens¹ found that prolonged exposure to -91°C . greatly decreased the fermentative activity, and this power was entirely destroyed by an exposure of 108 hours to -70°C ., followed by one of twenty hours to -130°C .² Pictet also states that not only the enzyme of yeast but also the toxins of poisonous bacteria are destroyed at extremely low temperatures.

SECTION 67. The Formation of Ice in Plants.

Ice is always formed when the temperature falls low enough³, and it can not only be seen, but also renders the plant brittle and causes the internal temperature-curve to show a stationary period corresponding to its freezing (or melting) point. This is lower than that of pure water owing to the influence of the salts dissolved in the cell-sap, and usually a certain amount of sub-cooling occurs before freezing begins.

The ice is usually formed outside the cells, and either fills up intercellular spaces, or forms gaps or fissures in the tissues. In some plants the ice-formation when complete may cause the peripheral tissues to rupture, forming cracks from which masses of ice project⁴. Crystals or masses of ice form on the cut surfaces of succulent parts at low temperatures, as is well shown when slices of a beet-root or cucumber are frozen in a moist chamber.

The ice-formation has been chiefly studied by Sachs, Prillieux, Müller-Thurgau, and Molisch⁵. The two last-named authors observed the progress of events under the microscope, which was enclosed in a double-walled metal cylinder containing a freezing mixture⁶.

Ice usually appears first in the intercellular spaces of parenchymatous tissue, but in the case of wood, within the cavities of the tracheae and tracheides⁷. The ice formed in an intercellular space acts like a wedge, pushing apart the cells and tissues in a manner determined largely by their anatomical arrangement⁸. In plants which can withstand freezing, the structure is probably such as to avoid any

¹ Melsens, *Compt. rend.*, 1870, T. LXX, p. 631.

² Pictet and Yung, *Compt. rend.*, 1884, T. XCVIII, p. 748; Pictet, *Archiv. d. sci. phys. et nat. d. Genève*, 1893, 3^e sér., T. XXX, p. 312.

³ This was shown by Schübler and his pupils in 1823-6 in spite of the contradictions of Hunter and others. Cf. Göppert, *Wärmeentwicklung in d. Pflanze*, 1830, pp. 138, 160.

⁴ Prillieux, *Ann. d. sci. nat.*, 1869, 5^e ser., T. XII, p. 129. In many cases comb-like masses of ice, 1 cm. in height, may project. Cf. Caspary, *Bot. Ztg.*, 1854, p. 665; Sachs, *Ber. d. Sächs. Ges. d. Wiss. z. Leipzig*, 1860, Bd. XII, p. 10; Bay, *Botanical Gazette*, 1894, Vol. XIX, p. 321.

⁵ Müller-Thurgau, *Landw. Jahrb.*, 1880, Bd. IX, p. 134, and 1886, Bd. XV, p. 453; H. Molisch, *Das Erfrieren d. Pflanzen*, 1897.

⁶ The apparatus used by Molisch is the best. Cf. also Klemm, *Jahrb. f. wiss. Bot.*, 1895, Bd. XXVIII, p. 642.

⁷ Müller-Thurgau, l. c., 1886, p. 481.

⁸ Cf. Prillieux, &c. Also Frauk, *Krankheiten der Pflanzen*, 1894, 2. Aufl., Bd. 1, p. 178; Dalmer, *Flora*, 1895, p. 437; Ludwig, *Bot. Centralbl.*, 1899, Bd. LXXX, p. 405.

fatal ruptures being produced by the ice. Prillieux observed that in the stems of Labiatae four masses of ice are commonly formed, each separated from the rest by the harder collenchymatous tissue at the angles of the stem. In the stem of *Senecio crassifolius* five separate ice-masses usually appear beneath the epidermis, whereas in the stems of many Scrophulariaceae a continuous ring of ice is formed in the outer cortex. Masses of ice also form beneath the epidermis of the petiole of *Cynara scolymus* and ice-needles radiate from the parenchyma surrounding each vascular bundle into the dark air spaces (Fig. 31).

Since the cracks and fissures will tend to follow the path of least resistance, they will naturally usually appear between the radial walls of cells arranged in radiating rows. It is also easy to understand why frost should hasten the fall of deciduous leaves. The cracks produced or enlarged by the ice-formation partly or entirely disappear on thawing, but persist when the plant is placed in cold alcohol and then thawed. The ice usually appears in the form of needles or columns, which grow out at right angles to the point of origin, and may frequently unite to form large masses.

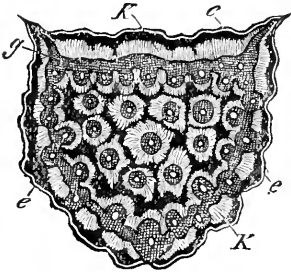

FIG. 31. Transverse section of a slowly frozen petiole of *Cynara scolymus*. (After Sachs.) *e*, epidermis; *g*, parenchyma, within which lie vascular bundles surrounded by radiating ice-crystals. These are also formed on the parenchyma at *X*, and project into the dark cavities.

The mode of freezing is due to the fact that the thin film of water which covers the outer walls of the cells lining the intercellular spaces freezes first. This causes more water to be withdrawn, and this again freezes. The continuance of this process on moist soil or on a column of plaster of Paris with its base in water results, as in the plant, in the formation and growth of needles or masses of ice¹. As water is withdrawn from the cell, the cell-sap concentrates, for the salts are kept back by the protoplasm so that the ice formed in the intercellular spaces is nearly pure².

The same applies when a cell freezes under water, and hence arises the collapse of frozen cells of *Spirogyra*³. The same shrinkage occurs in air, and indeed under all circumstances so long as the cell-wall is not too rigid. It is owing to their different internal structure that some multicellular organs increase in volume, length, or diameter on freezing, whereas others decrease⁴. Localized ice-formation may produce bending or curvature, and may also

¹ Cf. Lehmann, *Molecularphysik*, 1888, Bd. I, p. 347. An analogy used by Le Conte, Mohl, and Sachs, *Ber. d. Sächs. Ges. d. Wiss. z. Leipzig*, 1860, Bd. XII, p. 6.

² Sachs (*Lehrb.*, 4. Aufl., p. 703) states that the ice collected from a cut surface of an artichoke petiole contained about 0.1 per cent. of solids, and Müller observed the same in the case of the beet-root. These were merely included matter, since the ice crystallizes from a salt solution as pure water, the salt being deposited separately and at low temperatures often in a hydrated form ($\text{NaCl} \cdot 2\text{H}_2\text{O}$, &c.).

³ Molisch, *Das Erfrieren d. Pflanzen*, 1897, p. 22.

⁴ Sachs, *Ber. d. Sächs. Ges. d. Wiss. z. Leipzig*, 1860, Bd. XII, p. 21; Müller-Thurgau, *Landw. Jahrb.*, 1880, Bd. IX, p. 188.

bring about the same result by influencing antagonistic tissue-strains unequally.

As in the case of a partially frozen saline solution, a condition of equilibrium corresponding to the temperature is reached in a partly frozen plant. A further fall of water causes more water to be frozen, a rise of temperature causes the amount of ice to decrease. This was observed by Müller-Thurgau on transferring frozen plants from a temperature of -10 to -2°C . Since, however, the percentage of salts in the cell-sap is only sufficient to produce a slight lowering of the freezing-point¹, usually more than half the water in a plant is converted into ice at -3 to -8°C . Müller-Thurgau² found that an apple frozen at -4.5°C . contained 53 per cent. by weight of ice, so that 63.8 per cent. of the water normally present was frozen at this temperature, and 79.3 at -15.2°C . At very low temperatures therefore of from -50 to -100°C . the cell no longer contains any perceptible fluid contents, although the more firmly retained portions of the water of imbibition may still remain unfrozen.

The same general considerations apply when the ice is formed inside the cell³. Molisch observed that the wholly internal ice-formation in the sporangiophore of *Phycomyces nitens* takes place at -17°C ., but at -4°C . in epidermal cells of *Tradescantia* lying in water. An internal formation of ice must always ultimately occur if the temperature is lowered sufficiently, unless the withdrawal of water by the external ice-formation keeps increasing the concentration of the cell-sap so rapidly as to prevent freezing until the cell is dry internally, and freezing is therefore no longer possible. Since both the external ice-formation and the degree of sub-cooling are factors of importance, it is not surprising that an intracellular formation of ice is not observed in all cases and under all circumstances. It is probably favoured by rapid cooling, although even here the water may be very rapidly withdrawn from the cells during the extracellular formation of ice.

The plasmodia of Myxomycetes⁴ and also of Amoebae⁵ are killed by freezing, but it does not follow that all protoplasm is killed when ice-crystals are formed in it. Whether all plants resistant to freezing are also indifferent to an intracellular formation of ice has still to be determined, for the protoplasm and cell-contents might gradually dry up as extracellular freezing occurred. For this reason it is uncertain whether any ice is formed within bacterium cells when they are frozen in a turgid condition.

¹ A 1.01 per cent. solution of KNO_3 freezes at -0.308°C ., a 10.1 per cent. solution at -3.08°C ., and the same applies to solutions of equivalent osmotic concentration.

² Müller-Thurgau, Landw. Jahrb., 1886, Bd. xv, p. 472. In the case of the potato 77.2 per cent. of its water is frozen at -5°C . This is determined by calorimetric comparison of equal weights of frozen and unfrozen potatoes.

³ Göppert, Wärmeentwicklung i. d. Pflanze, 1830, p. 26; Regel's Gartenflora, 1879, p. 260; Müller-Thurgau, l. c., 1880, Bd. ix, p. 184; Molisch, Das Erfrieren d. Pflanzen, 1897, p. 16.

⁴ Kühne, Unters. ü. d. Protoplasma, 1864, p. 88.

⁵ Molisch, l. c., p. 17.

Plants usually have a lower freezing-point than that of the sap they contain, as can be seen from the following figures given by Müller¹ :—

	Real freezing-point.	Lowest sub-cooling point without freezing.
Potato	−1.0 to −1.6° C.	−2.8 to −5.6° C.
Apple and Pear	−1.4 to −1.9° C.	−2.1 to −5.2° C.
Grape	−3.1° C.	−6.8 to −7.8° C.
<i>Phajus grandifolius</i> , labellum of flower	−0.58° C.	−6.0° C.
<i>Phaseolus vulgaris</i> , foliage leaf		
<i>Sempervivum tabulaeforme</i>	−0.55° C.	−6.48° C.

Hence it follows that many plants that are killed by the formation of ice within them can be lowered well below zero without being fatally affected. The possible amount of sub-cooling is slightly or not at all altered by death, and it varies in different cases independently of the concentration of the cell-sap. The latter is of course of primary importance in determining the true freezing-point, but nevertheless other factors enter into play, for the expressed sap and also a dead plant have a slightly higher freezing-point than living objects². Any increase in the concentration of the cell-sap will naturally lower the freezing-point, which is therefore changeable. In the herbaceous plants investigated by Müller it lay, however, between −0.15 and −8° C., and in most highly succulent plants between −1 and −2° C.

When a sub-cooled plant freezes, the formation of ice liberates heat, and if sufficient in quantity this may raise the temperature to the real freezing-point. This actually occurs in plants, and thermometers inserted at different depths in a large potato may show approximately similar readings during freezing, when this takes place rapidly.

Any localized formation of ice prevents sub-cooling, and it is probably owing to the escape of readily freezing sap that a peeled potato freezes at −1° C. without any previous sub-cooling. By rapidly lowering the temperature, the periphery of a thick organ may be frozen before the temperature at the centre has fallen to the freezing-point. Hence in the centre of a beet-root, ice is usually formed without any sub-cooling, but the latter does occur when the temperature is very gradually lowered³.

Methods. Müller-Thurgau⁴ wrapped leaves around the bulb of a sensitive

¹ Müller-Thurgau, Landw. Jahrb., 1886, Bd. xv, p. 490. Molisch (Das Erfrieren d. Pflanzen, 1897, p. 18) states that ice-formation begins in the sporangiophore of *Phycomyces nitens* at −17°, but not at −12° C. In the tracheides of *Taxus* ice appears, according to Dixon and Joly (Annals of Botany, 1895, Vol. ix, p. 403), at −10 to −11° C.

² Müller, l. c., p. 478. The freezing-point of a living potato was −0.98° C., after death it became −0.55° C.

³ Müller-Thurgau, l. c., 1880, Bd. ix, p. 176; 1886, Bd. xv, p. 488.

⁴ Müller-Thurgau, l. c., 1880, pp. 156, 168; 1886, p. 470. Bachmetjew (Zeitschr. f. wiss. Zool., 1899, Bd. LXVI, p. 521) appears to be unaware of the long-known and clearly established

thermometer, or inserted the latter into holes bored in potatoes, beet-roots, and the like. The objects were then placed in freezing chambers, with the thermometer scale projecting outside. In an experiment performed with a potato the air in the chamber was at -4.0 to -4.5°C. , and the temperature of the tuber sank from 15°C. to -0.1°C. in one hour, and to -3.2°C. in the next fifty minutes. Then ice-formation began and in twenty minutes the temperature rose to -0.8°C. , the true freezing-point, at which it remained for an hour, and then gradually fell again. In an ivy leaf, the formation of ice is not active enough to cause a rise to the true freezing-point, which lies at -1.5°C. , whereas sub-cooling may progress as far as -3.4°C. The method of melting is not a well-adapted one to give the true freezing-point of a plant¹.

The temperature-curve indicates the progress of the formation of ice, and it rises to the freezing-point after the maximal degree of sub-cooling has been reached. After remaining at the first freezing-point for some time it slowly sinks as the sap is more and more concentrated and the freezing-point lowered. At the same time the formation of ice takes place more and more slowly. The following data obtained with a kohlrabi leaf may serve as an illustration:—

Critical point (of sub-cooling)	-4.4°C.
Temperature four and a half minutes later	-1.2°C.
Amount of ice formed	6.69 per cent.
„ „ „ three minutes later	2.25 per cent.
Temperature then fell, reaching in fifty-six minutes		-4.3°C.
Total amount of ice formed	41.3 per cent.

The formation of ice does not take place so suddenly in a sub-cooled plant as in a sub-cooled solution, and in many leaves the formation of ice begins at particular points, and thence spreads slowly over the leaf. Whether the ice formed outside the cells excites the solidification of the sub-cooled cell-sap is as uncertain, as is the analogous question whether a crystal can excite crystallization in a supersaturated solution through a membrane permeable by water but not by the crystalline substance.

The lowering of the freezing-point is directly proportional to the osmotic concentration, and can therefore be calculated for any solution from the table of osmotic values, having given that a decinormal solution of potassium nitrate (1.01 per cent.) freezes at 0.308°C. ² Hence the freezing-point of concentrated solutions of colloids is only slightly lowered, so that crystals of ice form in a 10 per cent. solution of gelatine just below 0°C. ³

Hence when the cell-sap is isosmotic with 1 or with 3 per cent. solutions of KNO_3 , its freezing-point will be -0.3 or -0.9°C. respectively. The fact that the actual freezing-point of the cell is lower than this is due to surface-tension

relationships between freezing, sub-cooling, and cold-rigor, and his observations on insects yield nothing new of importance.

¹ Müller-Thurgau, Landw. Jahrb., 1880, p. 177.

² Ostwald, Lehrb. d. allgem. Chem., 1891, 2. Aufl., Bd. I, p. 752. A 1.01 per cent. solution of KNO_3 develops a pressure of 1 atmosphere, so that an osmotic pressure of 1 atmosphere represents a lowering of the freezing-point by 0.088°C.

³ Guthrie, Philosoph. Magazine, 1876, 5th ser., Vol. II, p. 211; Sabanejew and Alexandrow, Zeitschr. f. physikal. Chem., 1892, Bd. IX, p. 88.

forces such as capillarity and imbibition. A pressure of 1 atmosphere only lowers the freezing-point of water 0.0075°C .¹, so that the hydrostatic pressure due to an osmotic concentration of the sap of 3.5 or of 10 atmospheres² lowers the freezing-point by 0.025 or 0.075°C . respectively. Mousson³ found that in a capillary of 0.4 mm. diameter the freezing-point of water was lowered by 0.1 to 0.2°C ., while Müller-Thurgau found that wet filter-paper froze at -0.1°C . Hence even when the cell-wall is saturated with pure water, the latter will not begin to freeze until the temperature is below zero. In dead plants, owing to the escape of the sap, the freezing-point is usually about the same as that of the expressed sap.

Sub-cooling is possible in both water and saline solutions when contact with ice is avoided, and it is especially easy to observe in capillary tubes. Thus Mousson found that in a capillary tube of 0.4 mm. diameter the water remained unfrozen at -7 to -10°C ., while Dufour⁴ observed that drops of water a few millimetres in diameter, floating in a mixture of almond oil and chloroform of like specific gravity, remained liquid at -8 to -12°C ., but immediately turned solid on touching a piece of ice. The sub-cooling in most plants is not greater than is represented by a temperature of -3 to -4°C ., the temperature then rising to -0.1°C ., owing to the commencing formation of ice, in a particular case in which a living leaf was used. The same sub-cooling is shown by dead plants, so that we are here dealing with a physical phenomenon⁵, which is not appreciably influenced by the life of the cell. The small size of bacterium-cells may appreciably lower their freezing-point, but an experimental answer to this and similar questions is still required.

SECTION 68. How Cold causes Death.

The erroneous supposition of Duhamel and Senebier⁶ that freezing causes death by bursting the cells was disproved by Göppert, Sachs, and Nägeli⁷, who showed that all plants are not killed by freezing, while as a matter of fact the ice is usually formed outside and not inside the cells. Even when the latter is the case the cell-wall is able to stretch sufficiently to

¹ Clausius, *Mechanische Wärmetheorie*, 1876, p. 174; Lehmann, *Molecularphysik*, 1888, Bd. 1, p. 820.

² These pressures are produced by solutions isosmotic with 1.01 or 3.03 per cent. solutions of potassium nitrate. In most plants the turgor is equivalent to from 1.5 to 3 per cent. solutions of KNO_3 .

³ Mousson, *Die Physik auf Grundlage d. Erfahrung*, 1. Aufl., 2. Abth., p. 73, and *Annal. d. Physik u. Chemie*, 1858, Bd. cv, p. 161.

⁴ Dufour, *Annal. d. Physik u. Chemie*, 1861, Bd. cxiv, p. 530.

⁵ Cf. Ostwald, *Lehrbuch*, 1891, Bd. 1, p. 993; Wüllner, *Physik*, 1885, 4. Aufl., Bd. 111, p. 607; Tammann, *Zeitschr. f. physikal. Chem.*, 1898, Bd. xxv, p. 441; Bachmetjew, *Zeitschr. f. wiss. Zoologie*, 1900, Bd. Lxvii, p. 529.

⁶ See Göppert, *Die Wärmeentwicklung in der Pflanze*, 1830, p. 8; Molisch, *Das Erfrieren d. Pflanzen*, 1897, p. 66.

⁷ Göppert, 1. c., p. 25; Sachs, *Versuchsst.*, 1860, Bd. 11, p. 179; Flora, 1862, p. 20; Nägeli, *Sitzungsb. d. Bayerisch. Akad.*, 1861, I, p. 267; Nägeli and Schwendener, *Das Mikroskop*, 1877, 2. Aufl., p. 455.

allow for any expansion during gelation¹. Even when the intracellular formation of ice produces fissures in the tissues or ruptures in individual cells, this only has the same effect as a localized injury.

The injury or death is therefore due to changes or disturbances produced in the protoplasm by the low temperature, and owing to the dissimilar specific characters of different plants death need not always be produced in exactly the same way. This is shown by the fact that some plants are killed at temperatures above zero, while others are killed by the formation of ice at temperatures which they can withstand if the formation of ice is prevented. Other plants, again, are not injured if the formation of ice does not progress too far, while some are resistant to all degrees of cold.

Owing to the progressive withdrawal of water with decreasing temperature all plants which cannot withstand desiccation must ultimately be killed by cold. In the case of most plants more than half the water is frozen at -3 to -8°C ., and hence it remains to be explained why certain plants incapable of withstanding desiccation can resist temperatures of from -20°C . to -30 or even -50°C . If at these temperatures the whole of the free water is frozen, it is evident that the local withdrawal of water by freezing acts differently to its total removal by desiccation. It has, further, still to be determined whether bacteria killed by drying are resistant to extremely low temperatures.

Without doubt all plants kept permanently frozen would ultimately die, so that death can hardly be due in all cases to the withdrawal of water, as Müller and Molisch suppose², although frequently this may be the primary cause of death. Many seeds capable of withstanding desiccation are in fact killed when frozen after soaking in water, and the high resistance to cold shown by desiccated objects is simply a special case of a general phenomenon. Since we are here dealing with biological adaptations, it is possible that tropical plants subject to desiccation but not to low temperatures may be found to afford instances of plants killed by slight cold, but nevertheless resistant to desiccation.

Müller and Molisch consider the behaviour of the above-mentioned seeds to be due to the sudden withdrawal of water when freezing follows sub-cooling. Under certain circumstances rapid changes are actually injurious, but it appears that rapid thawing and freezing exercise little or no special injurious effect. Furthermore, seeds seem to be unaffected by the most rapid drying, or absorption of water. Müller has indeed himself shown that the potato and beet-root are also killed when sub-cooling is avoided and the formation of ice takes place gradually. It is uncertain

¹ A rise of pressure in the cell will drive out water through the permeable cell-wall until equilibrium is restored.

² Müller-Thurgau, *Landw. Jahrb.*, 1886, Bd. xv, p. 534; Molisch, *Das Erfrieren der Pflanzen*, 1897, p. 534. This conclusion is as one-sided as that ascribing all death by heat to proteid-coagulation.

whether in such cases death follows the least formation of ice, although death occurs when ice is formed at the primary freezing-point, in which case the total quantity is insufficient to cause a seriously injurious withdrawal of water. If the foregoing is actually true, then it needs to be explained why the potato and beet-root are not killed by temperatures below their freezing-point so long as no ice is actually formed. Possibly more than one factor may enter into play, and the actual cooling may even render the plant especially sensitive to gelation and its attendant consequences. Among plants which can withstand severe cold, involving the conversion of most of their water into ice, some are included which are readily killed by drying.

The formation of ice-crystals in the protoplasm may possibly exercise a special influence, and in fact causes the death of Amoebae and of the plasmodia of Myxomycetes. Other protoplasts may, however, be more resistant. The fact that starch-paste after freezing forms a coarsely porous mass from which water can be pressed as from a sponge¹ is probably the result of a change of molecular or micellar structure. Since dried starch-paste does not take up the original percentage of water, whereas resistant protoplasts assume their original condition when moistened, it follows that the observations on starch-paste cannot be directly applied to all living protoplasts.

Death by cold is in many cases, though not in all, due to the withdrawal of water by freezing, but this says nothing as to the protoplasmic peculiarities which determine whether a particular plant shall survive or not. The same applies when death occurs above the freezing-point, and indeed the functional disturbances leading to death may have various modes of origin and action.

The visible changes and deformations produced in the protoplasm have been proved by Klemm² to be mainly the result of sudden change, and hence are not shown when cells are gradually warmed or cooled. This reaction is, however, of interest since sudden changes of temperature exercise for the most part no permanent injurious effect.

Death produced by the depressant effect of low temperatures usually requires long exposure, but may also take place rapidly, while an increased degree of cold may hasten death, but does not necessarily always do so. The sudden formation of ice in a sub-cooled plant may induce such disturbances as to cause rapid death even when this is not directly due to the withdrawal of water.

We do not know the nature of the peculiarities which determine the different powers of resistance of individual plants, and of the same plant

¹ Vogel, Gilbert's Annalen, 1820, Bd. LXIV, p. 167. Coagulated egg-albumin and solid gelatine show similar changes on freezing. Cf. Sachs, Versuchsstat., 1860, Bd. II, p. 192; Müller, Landw. Jahrb., 1880, Bd. IX, p. 140; Molisch, l. c., p. 7.

² Klemm, Jahrb. f. wiss. Bot., 1895, Bd. XXVIII, p. 641.

at different stages of development. The resistance can be increased to a certain extent by raising the concentration of the cell-sap and of the imbibed water, so that the fact that cold acts as a stimulus inducing an increased production of sugar in many plants is of great biological importance. In this way the freezing-point of the plant is appreciably lowered, but whether those trees which form oil in winter are more resistant to cold on this account is uncertain¹.

PART III

THE POWER OF RESISTANCE TO LIGHT

SECTION 69. The Injurious Action of Light.

There is a definite maximal and ultra-maximal intensity of light for each plant, and the maximum is high in the case of plants which grow in fully exposed situations, but is lower in the case of typical shade-plants. Many chlorophyllous Phanerogams and Cryptogams, including numerous algae, cannot withstand exposure to the full intensity of direct sunlight². Among fungi all grades of resistance are shown, from plants which grow in sunlight to others which are soon killed by diffuse daylight. Thus Elfving³ found that the spores of *Aspergillus glaucus*, and Laurent⁴ that those of *Ustilago carbo*, were killed only by prolonged insolation, whereas the plasmodia of various Myxomycetes soon die in direct sunlight⁵. Some bacteria are unable to grow in diffuse light, but others are only killed by longer or shorter insolation⁶. Curiously enough the spores are often not more resistant than the vegetative cells, and Arloing even found that the spores of *Bacillus anthracis* were killed by two hours' insolation, but the vegetative cells only after from twenty-six to thirty hours'. This action of sunlight is therefore of the utmost importance in nature, and it appears that all pathogenic bacteria can be killed by sufficiently prolonged insolation. No organism is, however, known which is so sensitive to light that it can only grow in complete darkness.

Even plants which grow in sunlight can be killed more or less rapidly when the illumination is sufficiently increased. This was first shown by

¹ Fischer, Jahrb. f. wiss. Bot., 1891, Bd. XXII, p. 155. Brittle frozen branches are more readily damaged by storms. Cf. Frank, Krankheiten d. Pflanzen, 1894, 2. Aufl., p. 177.

² This applies more especially to many Florideae, but also to such plants as *Spirogyra* and *Nitella*.

³ Elfving, Einwirkungen d. Lichtes auf d. Pilze, 1890, p. 105.

⁴ Laurent, Bull. d. l. Soc. Bot. d. Belgique, 1889, T. XXVIII, p. 162.

⁵ Pfeffer, Jahrb. f. wiss. Bot., 1900, Bd. XXXV, p. 723.

⁶ Flügge, Die Mikroorganismen, 1896, 3. Aufl., Bd. I, p. 441; Migula, System d. Bact., 1897, Bd. I, p. 361; Lafar, Technische Mykologie, 1897, Bd. I, p. 72; Dieudonné, Biol. Centralbl., 1895, Bd. XV, p. 103; Tammes, Landw. Jahrb., 1900, Bd. XXI, p. 468.

Pringsheim¹, who traced the effects of exposure to concentrated sunlight under the microscope. The action is restricted to the part illuminated, and may result in changes or disturbances which are not necessarily immediately fatal, and which may be capable of removal. Protoplasmic streaming is stopped, and deformatory changes may occur in the protoplasm². The chloroplastids appear to be more sensitive than the rest of the protoplasm, and may permanently or temporarily lose their power of photosynthesis, in the former case usually being more or less completely bleached. The pigment dissolved in the cell-sap of the staminal hairs of *Tradescantia* is readily destroyed, as is also that in the yellow chromatophores of the ray florets of *Calendula officinalis*. The pigments of other plants are, however, more resistant, and concentrated sunlight exercises no direct effect upon drops of tannin or fat, or upon starch-grains.

The decomposition of the pigments and the destructive action of light occur only, or at least in the first instance, in the presence of oxygen, and are therefore delayed or arrested in indifferent gases³. This at once shows that we are dealing with a photochemical action, and not with the result of any heating action. The more refrangible rays are in fact more effective than the less refrangible ones. Hence Pringsheim found that the action of sunlight was only slightly weakened when passed through a solution of cuprammonia, whereas the interposition of a solution of potassium bichromate weakened the action considerably. The light became almost innocuous after passing through a solution of iodine in carbon bisulphide, although the rays which pass through this medium have the greatest heating power. Bacteria react similarly, including those which are injured by diffuse daylight⁴.

In general the most intense action appears to be exercised by those rays which exercise most influence upon growth and movement, but it is not certain whether the curves of action correspond exactly, and whether in those cases where the less refrangible rays influence the process of growth most, the same rays also exercise the most pronounced injurious effect when concentrated. It is also uncertain whether the isolated green rays exercise any special injurious action, either directly or by producing functional disturbances leading to injury.

The action is presumably not always the same, and the death of

¹ Pringsheim, *Jahrb. f. wiss. Bot.*, 1879, Bd. XII, p. 288. Pringsheim used sunlight thrown by a heliostat on a specially large microscope mirror and brought by a convex lens to a spot of light of about 0.35 mm. diameter. Less than this is usually sufficient, and in sunlight increased 6 or 8 times in photochemical intensity by an Abbé condenser, cells of *Chara*, *Nitella*, *Elodea*, &c., are bleached in a few minutes. Cf. Ewart, *Annals of Botany*, 1898, Vol. XII, p. 384; Klemm, *Jahrb. f. wiss. Bot.*, 1895, Bd. XXVIII, p. 644; Pfeffer, *ibid.*, 1900, Bd. XXXV, p. 711.

² Klemm, l. c.

³ Pringsheim, l. c., pp. 351, 358. On bacteria cf. Flüge, *Die Mikroorganismen*, 1896, Bd. I, p. 443.

⁴ Cf. Beck and Schultz, *Zeitschr. f. Hygiene u. Infektionskrankheiten*, 1897, Bd. XXIII, p. 490. [See also *Phil. Trans.*, 1894, p. 961.]

anaerobic organisms in strong light leads to the assumption that aerobic organisms will also be killed, in the absence of oxygen, by light of sufficient intensity. Whether the presence of oxygen unduly accelerates respiration, or leads to the production of poisonous oxidatory products, has still to be determined. The fact that moderate illumination does not appreciably affect respiration affords no sure criterion as to the action exercised when the light is intense. In the latter case indeed the pigment in the cell-sap of the staminal hairs of *Tradescantia* is decolorized, although no such action is exercised by ordinary light. This is shown by the absence of any power of regeneration such as would be required to neutralize the effect of the daily exposure to light¹. The fact that the pigment may be oxidized and bleached by means of hydroxyl without killing the cell suggests that the intense light excites a production of ozone or hydroxyl, and that this carries out the bleaching. Light is capable of inducing a variety of chemical changes, involving analysis and synthesis as well as oxidation, so that a direct photochemical action might well be exercised upon the protoplasm.

In such media as light and air the fatal action is exercised within the cells, but in certain media decomposed by light poisonous products of external origin may act upon the living cells². It is worthy of note that dry bacteria, and fungal spores such as those of *Ustilago carbo*, are killed by sunlight³. On the other hand, mosses and lichens which grow on rocks are, when dry, uninjured by the strongest sunlight, nor is the vitality of dry seeds affected by exposure to light⁴.

PART IV

THE EFFECTS OF THE WITHDRAWAL OF WATER

SECTION 70. Desiccation.

In adaptation to their surroundings different plants and organs have acquired varied powers of withstanding the loss of water. The vegetative organs of most flowering plants are killed by desiccation, which does not affect the vitality of most seeds, but simply causes them to assume a dormant

¹ Cf. Pfeffer, *Oxydationsvorgänge in lebenden Zellen*, 1889, p. 383. [A power of regenerating the pigment might be present under normal conditions, but be destroyed by treatment drastic enough to destroy all the pigment present in the cell. For instance, chloroplastids can be partially bleached and yet remain capable of reproducing chlorophyll, but when completely bleached this power is always lost.]

² Cf. Richardson, *Bot. Ztg.*, 1894, p. 304; Dieudonné, *Arbeit. a. d. Kaiserl. Gesundheitsamte*, 1894, Bd. IX, p. 537; Flügge, l. c., p. 443.

³ Cf. Flügge, l. c., p. 444.

⁴ Tammes, *Landw. Jahrb.*, 1900, Bd. XXIX, p. 467. [The tips of the moss-leaves are often browned or injured by the prolonged exposure. The special resistance is due (1) to the opacity of the dry plants, (2) to the rolling up of the leaves, (3) to the fact that the dry walls of living cells are practically impermeable to oxygen, (4) chlorophyll is less readily decomposed when dry. It is in fact rather a question of resistance to dry heat than to light.]

condition. The vegetative organs of a few vascular Cryptogams are able, however, to withstand desiccation, and the same power is possessed by those mosses and lichens which are often subjected to severe drought in their natural habitats. Lichens afford instances of both algae and fungi resistant to desiccation, to which, however, the vegetative parts of most algae which grow submerged in water succumb. It is worthy of note that the combination of alga with fungus seems to increase the resistant power of the former to desiccation and dry heat as well as to insolation¹. The vegetative parts of most fungi are readily killed by desiccation, which, however, most of the spores and perennating organs can withstand. The same applies to bacteria, and here, as in a few fungi, the vegetative parts are resistant to desiccation.

All turgid plants can withstand a certain loss of water, and all grades of resistance are shown in different plants. Even those which are most sensitive may survive a loss of from 40 to 50 per cent. of water, and the vegetative organs of some flowering plants are not killed by a loss of from 80 to 90 per cent.² The latter is usually the case in plants naturally subject to temporary drought, independently of the amount of water they normally contain. Schröder³ found that the succulent *Sedum elegans* with 16 per cent. of dry substance could withstand the loss of 90 but not 95 per cent. of its water, whereas the more sensitive leaves of *Parietaria arborea* were partly killed by a loss of 50, and entirely by a loss of 70 to 76 per cent. of their water. Only approximate estimations are, however, possible, since a loss of water which is not at first fatal may prove so after a time, and further the cells and organs which absorb water with the greatest energy draw upon the other parts and cause these to shrivel and die prematurely.

Many Cryptogams can withstand air-drying but not desiccation over sulphuric acid or phosphorus pentoxide⁴. The aquatic moss *Fontinalis antipyretica* is killed by air-drying, whereas *Mnium hornum*, which grows in fairly moist localities, resists several weeks' air-drying. This moss and also the somewhat more resistant *Funaria hygrometrica* soon die in a desiccator, in which *Barbula muralis*, *Bryum caespiticium*, and other mosses which grow in dry habitats may remain living for more than twenty weeks. Similar grades of resistance⁵ are shown by various species of *Oscillaria*, and by bacteria. The mosses and lichens which grow on rocks

¹ Ewart, Journ. of Linn. Soc., 1896, Vol. xxxi, pp. 375, 376, 383.

² In the case of a turgid plant containing 80 per cent. of water, a loss of weight of 32 to 40 per cent. represents 40 to 50 per cent. of water; one of 72 per cent., a loss of 80 to 90 per cent. of water.

³ Schröder, Unters. a. d. Bot. Inst. in Tübingen, 1886, Bd. II, p. 5; Dutrochet, Mém. p. servir à l'histoire d. végétaux et des animaux, 1837, p. 204; de Candolle, Pflanzenphysiol., trans. by Röper, 1835, Bd. II, p. 872; Fleischer, Bot. Centralbl., 1885, Bd. xxii, p. 356.

⁴ Schröder, l. c.; Ewart, Trans. Liverpool Biol. Soc., 1897, Vol. XI, p. 151; Koch's Biol. Centralbl., 1892, Bd. XII, p. 336.

⁵ Schröder, l. c., pp. 15, 32.

must often become completely dry, whereas plants rooted in soil rarely lose all their water, except in the case of a few desert plants exposed to long periods of intense drought and heat. Under ordinary circumstances, however, the fall of dew at night enables the shrivelling plants to absorb a certain amount of water.

In ordinary air, dried plants retain from 8 to 14 per cent. of water, which is not fully removed even in a desiccator¹. Thus seeds may retain from 1 to 3 per cent. and *Sticta pulmonacea* as much as 4.8 per cent. of water, which is gradually lost when the objects are heated to 100 or 110° C. in dry air. Independently of whether this water is chemically bound or is merely water of imbibition, it is not surprising that complete drying kills organisms which are able to withstand drying over sulphuric acid². The death of various seeds, spores, and mosses at 100° C. may in fact be partly due to the removal of the last traces of absorbed or combined water. This is, however, not always fatal, for some organisms can withstand heating to a temperature of from 100 to 110° C. for several hours, and although thick seeds might still not have lost all their water, this could hardly be the case when spores, mosses, bacteria, and other small objects are used. Many spores, bacteria, and a few seeds such as cress and linseed remain living after several weeks' or even months' immersion in absolute alcohol, which must certainly remove nearly all the water they contain.

Dry plants ultimately die, although since they do not respire no external change affords evidence of death. Many dry seeds, spores, and mosses die in a short time, whereas others may live for many years, and possibly for more than a century. The part played by the external conditions in determining the preservation of vitality has not yet been precisely determined, but the degree of desiccation is doubtless of importance. Such plants as *Mnium hornum*, *Funaria*, and *Cladonia* die more rapidly in a desiccator than in ordinary air. Some plants may, however, remain living longest when completely dried, and Schröder in fact found (l. c., p. 34) that the spores of *Phycomyces nitens* retained their vitality as long in a desiccator, and in the absence of oxygen, as in ordinary air. Ficker³ has also shown that certain bacteria (*Vibrio cholerae*, *Bacillus typhi*) live longer in a desiccator than when alternately exposed to moist air and to the dry air of a desiccator.

The dry spores of *Aspergillus niger*, *Phycomyces nitens*, of yeast, and of bacteria are injured but little or not at all by prolonged immersion in absolute alcohol, ether, benzol, and carbon bisulphide, and possibly may in

¹ Schröder, Unters. a. d. Bot. Inst. in Tübingen, 1886, Bd. II, p. 5; Ewart, Trans. Liverpool Biol. Soc., 1897, Vol. XI, p. 151.

² The death of living frozen plants on a further lowering of the temperature is probably wholly or in part due to the increased withdrawal of water.

³ Ficker, Ueber Lebensdauer u. Absterben von pathogenen Keimen, Habilitationsschrift, 1898, p. 25.

many cases not die more rapidly in such a medium than they do in air. The same applies to seeds¹, although they are injured if placed in these media when moist, or if the media contain sufficient water to allow of a certain degree of swelling. Absolute alcohol penetrates many resistant dry seeds and spores with the utmost difficulty or not at all, as can be shown by adding soluble pigments or chemical substances to the alcohol, and examining the seeds after prolonged immersion. Some dry seeds (hemp, peas, wheat) are penetrated more easily and are readily killed². It is possibly owing to their non-penetration that poisons dissolved in absolute alcohol have little or no action on perfectly dry seeds³, and, similarly, dry seeds are comparatively unaffected by exposure to poisonous gases⁴. As the alcohol penetrates an oily seed, the oil is slowly dissolved out; but this takes a long time, even when the seed-coat is removed, and the seed is killed long before. In the case of spores and bacteria it seems probable that all the oil can be removed without vitality being destroyed.

It is a fact of great biological importance that resistant seeds can withstand rapid drying and sudden moistening. Just as in the case of freezing and thawing, so also is it possible that gradual moistening may favour revival⁵, and on the other hand a diminution in the supply of water excites the production of resistant spores in many plants. Here it is of importance that the gradual drying should give sufficient time for the production of the resistant organs.

Seeds may become capable of withstanding desiccation while still unripe, and even when they have not gained one-half their dry weight when adult⁶. The seedling is, however, killed by drying, and the resistance gradually decreases during germination. De Saussure⁷ showed that

¹ Pasteur (Compt. rend., 1877, T. LXXXV, p. 99) found that the spores of *Bacillus anthracis* remained living after twenty-one days in alcohol, and Bernard (Leçons s. l. phénomènes d. l. vie, 1878, p. 54) found yeast-cells living after three to four days in the same medium. Concerning seeds cf. Nobbe, Samenkunde, 1876, p. 283. Hoffmann's remarks (Jahrb. f. wiss. Bot., 1860, Bd. 11, p. 331) are without value. Cf. Flügge, Mikroorganismen, 1896, 3. Aufl., Bd. 1, p. 450.

² Ewart, Vitality and Germination of Seeds, Trans. Liverpool Biol. Soc., Vol. VIII, 1894, pp. 222-229.

³ Cf. Krönig and Paul, Zeitschr. f. Hygiene u. Infektionskrankheiten, 1897, Bd. XXV, p. 91.

⁴ Romanes quoted by Brown and Escombe, Proceedings of the Royal Society, 1897, Vol. LXII, p. 160.

⁵ Schröder, Unters. a. d. Bot. Inst. in Tübingen, 1886, Bd. II, pp. 45-7. In regard to seeds cf. also Just, Cohn's Beitr. z. Biol., 1877, Bd. II, p. 338. De Saussure (Ann. d. sci. nat., 1827, T. X, p. 92) states that the dried radicles only remain living when gradually moistened, but this needs confirmation. Cf. Schröder, l. c.

⁶ Schröder, l. c., p. 10. On the germination of unripe seeds cf. Cohn, Symbola ad seminis physiologiam, 1847, p. 39; Nobbe, l. c., p. 339; Kinzel, Landw. Versuchsstat., 1901, Bd. LV, p. 255. The cells of unripe seeds shrink so that the reserve materials fill the remaining space (Pfeffer, Jahrb. f. wiss. Bot., 1872, Bd. VIII, p. 510).

⁷ De Saussure, Ann. d. sci. nat., 1827, T. X, p. 68; Schröder, l. c., p. 12, and the literature there given; Will, Versuchsstat., 1883, Bd. XXVIII, p. 52; Bonnier, Rev. gén. d. Bot., 1892, T. IV, p. 193; Frank, Krankheiten der Pflanzen, 1895, 2. Aufl., p. 263.

radicles which had just escaped could still withstand air-drying, but not in all cases drying over sulphuric acid. When the radicle becomes as long or longer than the seed, its resistance to desiccation is lost, but the seedling may replace it by adventitious roots if it is destroyed. It is worthy of note, however, that a sowing of grass is injured more by drought just after germination than when the roots have penetrated more deeply into the soil. As in the case of seeds, the germ-tubes formed by the resistant spores of *Penicillium*, *Phycomyces*, *Mucor*¹, and *Uredo*² are killed by drying.

The means by which the power of resistance to drying is gained, and the changes which cause its loss, are quite unknown. There is no direct connexion between the storage of food-materials and the resistance to desiccation, for all cells filled with food-materials cannot resist drying, and the leaves of mosses remain resistant even when starved³.

The germination of unripe seeds also shows that resistance to desiccation does not involve the complete filling of the cells with food-materials. The latter has, however, a certain advantage, since it prevents the shrivelling and crumpling of the cells which those in the leaves of mosses undergo on drying. The protoplasm in the leaf-cells of mosses is shown to be rich in water by its contraction on drying, so that a high percentage of water is compatible with a power of resistance to desiccation. Nor need the protoplasm be impregnated with fat or oil⁴. Since full turgor is restored in mosses and other plants immediately after moistening them, it is evident that the osmotic materials remain as solids in the central vacuole. Evidently therefore the protoplasm is not injured by the concentrated cell-sap. If, however, the latter is responsible for the death of certain plants on drying, we have revealed to us in such cases the immediate cause of the fatal action of desiccation. It is, however, hardly likely that the death of plants killed by the removal of more or less of the imbibed water, as well as that of those only killed by the removal of the last traces of absorbed or even combined water, are alike produced in the same way.

The high resistance of dried plants to heat and cold, to alcohol and other poisons, can easily be understood as the result of their diminished powers of reaction, but the changes have still to be discovered which produce their ultimate death. This is not due to the turning rancid of stored fats, for although many oily seeds soon lose the power of germination, others, and also oily spores, may retain their vitality for a long time, while many starchy

¹ Schröder, Unters. a. d. Bot. Inst. in Tübingen, 1886, Bd. II, p. 34; Nordhausen, Jahrb. f. wiss. Bot., 1899, Bd. XXXIII, p. 29; Duggar, Botanical Gazette, 1901, Vol. XXXI, p. 65.

² Hoffmann, Jahrb. f. wiss. Bot., 1860, Bd. II, p. 329.

³ Schröder, l. c., p. 45.

⁴ On the fats of mosses cf. Jönsson and Olin, Lunds Univ. Årsskr., 1898, Bd. XXXIV, Afd. 2, Nr. 1.

seeds soon die when kept. Moreover dry mosses are not injured by immersal in rancid fat or in oleic acid. The vitality of the dried plant appears to depend not only upon its stage of development and whether it is ripe or not, but also upon the cultural conditions and other circumstances. It is only in this way that we can explain the unequal duration of vitality in the seeds or spores of the same individual, as when some of the spores of *Phycomyces nitens* die after a few weeks, but others not till after two or three years¹.

Many, but not all, seeds can withstand desiccation. For example, the seeds of *Oxalis rubella*, *O. lancifolia*², *Coffea arabica*, *Dictamnus fraxinella*, *Angelica archangelica*, and of many Myrtaceae and Lauraceae, lose the power of germination when thoroughly dried³. The seeds of willows commonly lose their vitality in a few days, and hence Wichura⁴ and Winkler⁵ considered them to be incapable of resisting desiccation. Wiesner⁶ and Woloszczak⁷ have, however, shown that those willow seeds which remain living for more than three months can withstand drying.

The air-dried seeds of willows lose their vitality in a few months, but other seeds not until after the lapse of some years. After ten years in dry air many seeds are dead⁸, and but few are living after twenty-five years⁹. Nevertheless the seeds of *Nelumbium* were found to be still capable of germination after 100 years¹⁰. Other seeds may live still longer, but the accounts of the germination of wheat found in mummies are based on error, the wheat having been subsequently introduced¹¹. Burgerstein found that the carefully preserved seeds of barley, oats, and wheat were mostly still capable of germination after ten years, although the seeds of rye had lost their vitality in this time.

The life of a pollen-grain is usually short, but in certain cases vitality may be preserved for some length of time¹².

Vascular Cryptogams. Of these, *Isoetes hystrix*¹³, *Polypodium vulgare*, and *Ceterach*¹⁴ withstand drying, and Wittrock found *Selaginella lepidophylla* to be still living after it had lain in a herbarium for eleven years. Most of the spores are also resistant to desiccation, and retain their vitality for a long time. The spores

¹ Schröder, Unters. a. d. Bot. Inst. in Tübingen, 1886, Bd. II, p. 34.

² Hildebrand, Bot. Ztg., 1884, p. 110.

³ De Candolle, Pflanzenphysiol., trans. by Röper, 1835, Bd. II, p. 260; Schröder, l. c., p. 8; U. Dammer, Bot. Jahresb., 1897, p. 154.

⁴ Wichura, Jahrb. d. schles. Ges. f. vaterl. Cultur, 1856, p. 56.

⁵ Winkler, Bot. Jahresb., 1877, p. 352.

⁶ Wiesner, Biol. d. Pflanzen, 1889, p. 43.

⁷ Woloszczak, Bot. Centralbl., 1889, Bd. XXXIX, p. 150.

⁸ Cf. Nobbe, Samenkunde, 1876, pp. 37, 370.

⁹ De Candolle, Ann. d. sci. nat., 1846, 3^e sér., T. VI, p. 373.

¹⁰ Cf. de Candolle, Géographie botanique, 1855, p. 542.

¹¹ Burgerstein, Beobachtungen ü. d. Keimkraftdauer, &c. (repr. from Verh. d. Zool.-Bot. Ges. in Wien, 1895).

¹² Cf. Mangin, Bull. d. l. Soc. Bot. d. France, 23 juillet 1886; Rittinghaus, Verh. d. naturw. Vereins d. Rheinlande, 1886, Bd. XLIII, p. 139.

¹³ Braun, Verjüngungen, 1851, p. 213, footnote.

¹⁴ E. Bureau, Compt. rend., 1890, T. CX, p. 318; Wittrock, Bot. Centralbl., 1892, Bd. XLIX,

of many Osmundaceae, Hymenophyllaceae¹, and of *Equisetum*², however, rapidly die when kept.

Mosses. Schröder found that the most resistant mosses died in the course of a few years³, and the power of dead mosses of becoming apparently fresh when moistened, has led some authors to conclude that they were still living after remaining for a hundred years in a herbarium. The perennating parts of the protonema seem to live for a longer time, and the spores have in part retained their vitality for as long as fifty years⁴. Most Hepaticae⁵, in correspondence with their moister habitats, are less resistant than mosses, but those forms which live in dry places remain living for a longer or shorter time in the dried condition. For example, *Corsinia marchantioides* was found to be still living after remaining for nine months in a herbarium.

*Algae*⁶. The zygotes and other resting spores of fresh-water algae can usually withstand desiccation, and the vegetative cells of such forms as *Cystococcus humicola*, *Pleurococcus*, and *Scenedesmus*, which grow on moist soil, possess the same power. Some species of *Nostoc* and *Oscillaria* can withstand a short period of desiccation, others a long period. Diatoms are killed by complete but not by partial drying in air. Many lichens are resistant to a high degree⁷, and it is interesting to notice that the algal components appear to be more resistant in the form of a lichen than when free⁸.

*Fungi*⁹. The mycelia of most fungi, including mould fungi, are killed by drying, whereas the spores, sclerotia, and other perennating organs are usually highly resistant. All grades of transition are, however, shown between organs resisting drying for a few days, and those which remain living for years. The spores (conidia) of *Aspergillus fumigatus* may remain living for as long as ten years, whereas the spores of moulds usually do not germinate after one to three years, and those of the more resistant Ustilagineae after eight to nine years. The spores and sclerotia of *Myxomycetes*¹⁰ also withstand drying, but appear usually to die after from six to twelve months. The vegetative cells of species of *Saccharomyces* can withstand drying over sulphuric acid¹¹, and Will found them still living after being kept dry in air for thirteen years.

*Bacteria*¹². The vegetative cells show all grades of resistance, whereas the

p. 132; Schimper, Bot. Mittheil. a. d. Tropen, 1888, Heft 2, p. 36; Heinricher, Ber. d. Bot. Ges., 1896, p. 234 (the adventitious buds of *Cystopteris bulbifera*).

¹ Sadebeck, Schenk's Handbuch d. Bot., 179, Bd. I, p. 156.

² Buchtien, Bibl. bot., 1887, Heft 8, p. 15.

³ Cf. Schröder, Unters. a. d. Bot. Inst. zu Tübingen, 1886, Bd. II, p. 15.

⁴ Schimper, Rech. anatom. et morphol. s. l. mousses, 1848, p. 22.

⁵ Cf. Schröder, l. c., p. 14. See also Goebel, Pflanzenbiol. Schilderungen, 1889, I, p. 174.

⁶ Cf. Schröder, l. c., p. 21.

⁷ Schröder, l. c., p. 38.

⁸ Ewart, Linn. Soc. Trans., 1896, Vol. XXXI, pp. 382, 383.

⁹ Schröder, l. c., p. 34; de Bary, Morphol. u. Biol. d. Pilze, 1884, p. 368; Zopf, Pilze, 1890, p. 317; Wehmer, Centralbl. f. Bact., 1895, 2. Abth., Bd. I, p. 217; Eriksson, *ibid.*, 1894, 2. Abth., Bd. IV, p. 431.

¹⁰ Schröder, l. c., p. 36; de Bary, l. c., p. 483.

¹¹ Schröder, l. c., p. 37; Will, Centralbl. f. Bact., 1900, 2. Abth., Bd. VI, p. 226.

¹² De Bary, Pilze, 1884, p. 515; Flüge, Mikroorganismen, 1896, 3. Aufl., Bd. I, p. 415; Ficker, Ueber Lebensdauer u. Absterben von pathogenen Keimen, 1898.

spores have typically great resistant powers, although it is not known whether they retain their vitality as long as some seeds do. The properties of bacteria are largely influenced by the cultural conditions and by the stage of development, so that the dissimilar results obtained by different authors with regard to the duration of vitality are readily comprehensible.

Various species of *Spirillum*, including *Spirillum undula*, are at once killed by drying. The same applies to *Bacillus carotarum*, whose spores, however, resist desiccation¹. Kurth² found that the rod-like forms of *Bacterium Zopfii* were killed after two to five days' drying, and the coccus forms after seventeen to twenty-six days. When dried *Spirillum cholerae asiaticae* dies in from fifteen minutes to a few hours, whereas the typhus, tubercle, and diphtheria bacilli withstand desiccation for weeks or even months. Naturally only those bacteria which are resistant to desiccation at some stage of development can be spread by the air.

SECTION 71. Osmotic Agencies.

Every plant will ultimately die if its percentage of water is kept so low as to prevent growth, either by transpiration or by immersion in saline solutions. The specific resistance of different plants varies greatly, however, for many plants are unable to grow in solutions isosmotic with from 1 to 2 per cent. sodium chloride solutions, whereas growth only ceases in others when the concentration is equivalent to from 17 to 20 per cent. of sodium chloride.

Even when the salts themselves are injurious, the action of a saline solution is not necessarily the same as when a corresponding diminution of turgor is produced by transpiration. In the latter case no plasmolysis is produced with its attendant consequences, and further the sudden change to a saline solution may act injuriously or even fatally upon plants which can withstand air-drying.

Various algae and fungi can withstand gradual transference from concentrated to dilute solutions, whereas sudden dilution causes the cells to burst owing to their high osmotic pressure. A sudden rise of concentration appears to produce the same effect upon bacteria and infusoria, owing to an excessive and disproportionate rise in their internal osmotic pressure. Thus Fischer³ has shown that *Bacillus anthracis*, *B. coli*, *B. cholerae* die in ten minutes to an hour when suddenly transferred from 0.75 per cent. solutions to 2 per cent. solutions of sodium chloride, although they are able to grow in solutions of 5 to 7 per cent. concentration. To produce this result no plasmolysis need be caused, but the origin of the internal rise of pressure is unknown.

¹ Koch, Bot. Ztg., 1888, p. 298.

² Kurth, Bot. Ztg., 1883, p. 409.

³ Fischer, Zeitschr. f. Hygiene u. Infektionskrankheiten, 1900, Bd. XXXV, p. 10. Massart (Archives d. Biol., 1889, T. IX, p. 547) states that bacteria may be killed when chemotactically attracted to a solution to which they can be gradually accommodated.

Many plants are killed by a sudden change without any bursting or plasmolysis. A slight change of concentration may injure or kill some fresh-water algae¹, and Stahl found that the plasmodium of *Aethalium septicum* was partly or entirely killed when suddenly transferred to a 2 per cent. solution of grape-sugar, or from this to a dilute nutrient solution². Many algae grow in estuaries, however, where twice daily they change from fresh to salt water. Similarly the growth of mould-fungi is only temporarily retarded by transference to nutrient solutions in which the increase of concentration is equivalent to 4 per cent. sodium chloride.

The cells of certain fungi, algae, and bacteria, as well as those of many flowering plants, can withstand plasmolysis and resume their growth when it is removed. Otherwise a new cell-wall may be formed around the plasmolysed protoplast, which may remain living a few days or even a few weeks, especially in a solution of sugar. The cells of other plants, such as those of many species of *Spirogyra*, die in a few hours when plasmolysed, and all those cells are killed in which the most careful application of sugar solutions produces either only partial plasmolysis, as in the cells of *Chara* and *Nitella*³, or no plasmolysis at all, as in some primary meristems, and in the hyphae of fungi⁴.

All these results are produced by gradual increases of concentration and when non-injurious substances are employed, so that they are due to the purely physical osmotic action of the dissolved substance. The injurious and fatal action is naturally accelerated by the use of poisonous substances, and a feeble poisonous action is exercised by potassium nitrate, sodium chloride, and other neutral salts of the alkalies, so that the plasmolysed cells of mosses, algae, and flowering plants die in solutions of these salts in a few days, although in isosmotic solutions of sugar they may remain living for weeks⁵. Fungi and bacteria cease to grow in solutions of potassium nitrate, sodium chloride, sugar, and glycerine of approximately equivalent osmotic value⁶, although it has still to be deter-

¹ Richter, *Flora*, 1892, p. 54. Karsten (*Die Diatomeen der Kieler Bucht*, 1899, p. 152) finds that many diatoms are rather sensitive. [It is only rarely that the change from fresh to fully salt water is completed, and even then the change is gradual, extending over a period of two to six hours.]

² Stahl, *Bot. Ztg.*, 1884, p. 166. ³ Pfeffer, *Jahrb. f. wiss. Bot.*, 1900, Bd. xxxv, p. 724.

⁴ *Id.*, *Druck- u. Arbeitsleistungen*, 1893, p. 307; Reinhardt, *Festschrift für Schwendener*, 1899, p. 425.

⁵ Klebs, *Unters. a. d. Bot. Inst. zu Tübingen*, 1886, Bd. II, pp. 504, 548; de Vries, *Mechanische Ursachen d. Zellstreckung*, 1877, p. 67; Pfeffer, *Osmot. Unters.*, 1877, p. 134; True, *Botanical Gazette*, 1898, Vol. xxvi, p. 413; Coupin, *Rev. gén. d. Bot.*, 1898, T. x, p. 187; Ewart, *Protoplasmic Streaming*, *Clar. Press*, 1903, p. 15.

⁶ Cf. Eschenhagen, *Einfluss von Lösungen verschiedener Concentration auf Schimmelpilze*, 1889, p. 55; Klebs, *Bedingungen d. Fortpflanzung*, 1896, p. 460; Mæssart, *Arch. d. Biol.*, 1889, T. ix, p. 547. Fischer (*Jahrb. f. wiss. Bot.*, 1895, Bd. xxvii, pp. 64, 153) finds that ammonium chloride exerts a poisonous action on bacteria in comparison with sodium chloride and potassium nitrate.

mined whether the neutral salts do not exercise a poisonous action when in still greater concentration.

Since bacteria plasmolysed in a concentrated solution soon re-expand, the injury produced in a strong solution of an innocuous substance can only be due to the direct osmotic action of the latter. In this case, however, solutions of high osmotic concentration are present both inside and outside the protoplast, so that the conditions differ from those in a cell whose turgor has been decreased or removed by transpiration. It is, however, unknown whether different species always exhibit similar differences of resistance in the two cases, although it is certain that no exact parallelism exists between resistance to drying and resistance to plasmolytic solutions. The injurious action of the latter in general increases as the concentration rises, and although as usual the spores are most resistant, the vegetative cells of many micro-organisms remain living in concentrated solutions without growing for a few weeks or even months, whereas others die in a few hours. De Freytag¹ found that anthrax bacilli died in two hours in a nearly saturated solution of salt, but the spores not until six months, the growth limit lying at a concentration of 7 to 10 per cent. Cholera bacilli with a similar growth limit died in six to eight hours, but typhus bacilli only after five months.

Permanent plasmolysis always produces death sooner or later, and this is accelerated by a rise of concentration in the case of cells resistant to drying as well as in that of non-resistant ones. Different seeds, like other organs, are unequally resistant, and thus some soon die in sea-water², whereas others are distributed by ocean currents³, and are either comparatively resistant to the action of sea-water or possess relatively impermeable coats.

PART V

CHEMICAL AGENCIES

SECTION 72. The General Properties of Poisons.

Every substance which in larger or smaller doses produces, in virtue of its chemical properties, functional disturbances ending ultimately in permanent injury or death can be classed as a poison⁴. Many organic and

¹ De Freytag, *Archiv f. Hygiene*, 1890, Bd. XI, p. 81. Cf. also Pettersen, *ibid.*, 1900, Bd. XXXVII, p. 3; Wehmer, *Centralbl. f. Bact.*, 1897, 2. Abth., Bd. III, p. 209; Lafar, *Technische Mykologie*, 1897, p. 193; Schmidt-Nielsen, *Biol. Centralbl.*, 1901, Bd. XXI, p. 68.

² Cf. Thuret, *Arch. d. sci. phys. et nat. d. Genève*, 1873, T. XLVII, p. 177.

³ Schimper, *Pflanzengeographie*, 1898, p. 32.

⁴ On the term 'poison' cf. Kobert, *Lehrbuch d. Intoxicationen*, 1893, p. 9; Kunkel, *Handb.*

inorganic nutrient substances act as poisons when concentrated. In the case of the neutral salts of sodium and potassium a fairly high concentration is usually necessary, but salts of iron as well as free acids and free alkalies act as poisons when very dilute. Many other substances, including those which the plant does not encounter in nature, exert a weaker or stronger poisonous action. It is only natural that the minimal concentration required to produce a poisonous effect should vary according to the plant examined, and that the plant should be able to recover from weak or transitory doses of poison, which when permanently applied may produce a gradual loss of vitality, and when concentrated may produce immediate death.

As an instance of adaptation to special conditions of life, it may be mentioned that many obligate anaerobes are killed by a very low partial pressure of oxygen, whereas most aerobes grow well when the percentage of oxygen is much higher than it is in ordinary air. Further, many bacteria are extremely sensitive to free acids, which do not affect fungi and acetic or lactic bacteria even when moderately concentrated¹. Hence when in open competition, one organism by producing acid may kill its sensitive rivals. The same occurs when a nutrient fluid contains yeast-cells which can withstand up to 14 per cent. of alcohol, and other plants which are killed by from 2 to 10 per cent. of alcohol². The sulphur bacteria again can exist in the presence of large quantities of sulphuretted hydrogen³, while yeast-cells and certain bacteria can live in solutions containing carbon dioxide under pressure, in which most bacteria are unable to develop. Most terrestrial plants indeed ultimately die in air containing between 4 and 20 per cent. of carbon dioxide⁴. The development of nitrate and nitrite bacteria is restricted by the presence of small quantities of peptone, sugar, and other substances, which form most suitable foods for other bacteria and for fungi; but in this case death only ensues after prolonged functional depression, a fact of considerable importance in nature.

Plants, as well as animals, seem to have acquired an increased power of resistance to poisonous products produced by themselves, although the immunity is not always perfect⁵. Whether the protoplasm of plants is unaffected by alkaloids and other vegetable poisons has not yet been

d. Toxicologie, 1899, p. 1. Injuries due to physical osmotic actions are not included under this heading.

¹ Clark, Botanical Gazette, 1899, Vol. XXVIII, p. 318.

² On alcohol as a poison cf. Bokorny, Pflüger's Archiv, 1896, Bd. LXIV, p. 284; Clark, l. c., p. 384; Stevens, *ibid.*, 1898, Vol. XXVI, p. 385.

³ Kühne (Zeitschr. f. Biol., 1898, N. F., Bd. XVIII, p. 67) finds that sulphuretted hydrogen is only feebly poisonous to *Chara*.

⁴ Frank, Krankheiten d. Pflanzen, 1894, 2. Aufl., Bd. I, p. 307; Lopriore, Jahrb. f. wiss. Bot., 1895, Bd. XXVIII, p. 531; Fränkel, Zeitschr. f. Hygiene, 1889, Bd. v, p. 322; Freudenreich, Beiheft z. Botan. Centralbl., 1894, Bd. IV, p. 457.

⁵ Lewin, Lehrb. d. Toxicologie, 1897, 2. Aufl., p. 423.

satisfactorily determined¹, for large quantities of poisons can be passively secreted in an insoluble form in the cell-sap, and such poisons as prussic acid are only formed after the death of the cell. Digitaline, and such alkaloids as morphine, atropine, eserine, muscarine, and veratrine, seem to exert little or no poisonous action on most plants, whereas strychnine seems often to act as a strong poison². The resistance to copper salts varies greatly in different plants, for *Spirogyra* and other algae die in water containing 1 part of copper in 1,000,000,000 parts of water³, whereas *Penicillium glaucum* is still able to grow in solutions containing 1 gramme-molecule in 0.75 litre (21 per cent.)⁴. This solution retards growth more than would be expected from its concentration, but the poisonous action is very slight, and the conidia may remain living for a long time in a saturated solution containing, at 20° C., 25.5 per cent. of copper sulphate. Other fungi are less resistant, for Pulst has shown that *Aspergillus niger*, *Botrytis cinerea*, and *Mucor mucedo* grow little or not at all in solutions containing 0.016 per cent. of copper sulphate (1 gramme-molecule in 1,000 litres). The spores (or germ-tubes) of Ustilagineae⁵ are still more sensitive, and are killed by the superficial impregnation of infected corn with copper sulphate. Other fungi again are not more resistant than are flowering plants, and although small percentages of copper salts kill most bacteria, the spores of *Bacillus anthracis* are highly resistant⁶.

¹ Schübler, Flora, 1827, p. 757; Cornevin, Compt. rend., 1891, T. CXIII, p. 274; H. de Varigny, Rev. gén. d. Bot., 1892, T. IV, p. 407.

² Bokorny, Pflüger's Archiv, 1896, Bd. LXIV, p. 299; Schwarz, Wirkungen von Alkaloiden auf Pflanzen, Erlanger Dissertation, 1897; Overton, Vierteljahrsschrift der Naturf. Ges. in Zürich, 1896, Bd. XLI, p. 401; 1899, Bd. XLIV, p. 108; Clark, Botanical Gazette, 1899, Vol. XXVIII, p. 394; Flügge, Mikroorganismen, 1896, 3. Aufl., Bd. I, p. 472; Sigmund, Versuchsstat., 1896, Bd. XLVII, p. 1; Ewart, Protoplasmic Streaming, Clar. Press, 1903, p. 81.

³ Hence water distilled from a copper vessel is usually poisonous to *Spirogyra* and similar algae. Cf. also Copeland and Kahlenberg, Trans. of the Wisconsin Acad. of Sciences, 1899, Vol. XII, p. 454. Pure distilled water is not poisonous. See Loew and Schulze, Landw. Jahrb., 1891, Bd. XX, p. 235; Deherain and Demoussy, Compt. rend., 1901, T. CXXXII, p. 532. It may, however, injure organisms which require a certain osmotic concentration in the surrounding medium. Ficker (Lebensdauer und Absterben von pathogenen Keimen, 1898, p. 71) finds that this is the case with certain bacteria.

⁴ That sulphate of copper is not especially poisonous to *Penicillium glaucum* has long been known. Cf. Jäger, Flora, 1843, p. 486; Chatin, *ibid.*, 1845, p. 214; Preuss, Bot. Ztg., 1848, p. 409; de Seynes, Bull. d. l. Soc. Bot. d. France, 1895, pp. 451, 482. Pulst (quoted by Pfeffer) has recently obtained the above values. Apparently some varieties are less resistant and may cease to grow in 1 to 3 per cent. solutions. Cf. Clark, l. c., p. 393. Copper nitrate acts like copper sulphate.

⁵ Wüthrich, Zeitschr. f. Pflanzenkrankheiten, 1892, Bd. II, p. 93; Tschirch, Das Kupfer, 1893, p. 44; Clark, l. c.; Stevens, *ibid.*, 1898, Vol. XXVI, p. 385 (fungi); Kahlenberg and True, *ibid.*, 1896, Vol. XXII, p. 96; Heald, *ibid.*, p. 139 (Phanerogams); Coupin, Compt. rend., 1900, T. CXXVII, p. 400; Frank, Arbeiten a. d. Biol. Abth. f. Land- u. Forstwirtschaft, 1900, I, Heft 2, p. 127; Devaux, Compt. rend., 1901, T. CXXXII, p. 717.

⁶ Krönig and Paul, Zeitschr. f. Hygiene u. Infektionskrankheiten, 1897, Bd. XXV, p. 63. See also Tschirch, l. c., p. 46.

Sulphate of zinc is almost as innocuous to *Penicillium glaucum* as sulphate of copper, and the plant can also withstand large quantities of dissolved arsenic. On the other hand, it is hardly if at all more resistant to the salts of cobalt, mercury, and thallium than is *Aspergillus* and other mould-fungi, and Clark even states (l. c., p. 399) that it is less resistant to free acids than are the latter.

In general the salts of the heavy metals are very poisonous, and especially those of silver and mercury. Manganese salts appear to be feebly poisonous, although all plants are not so unaffected as is *Penicillium*, which only ceases growing when the concentration reaches 37.7 per cent. (1 gramme-molecule of $MnSO_4$ in 0.4 litres), whereas in ferric sulphate the limit of growth is reached at a concentration of 8 per cent. (1 gramme-molecule in 5 litres). Sulphate of zinc is a moderately strong poison for most mould-fungi, and is a very strong one for Phanerogams.

It is usually the case that animal-poisons are plant-poisons also, although it is hardly surprising that ricin, abrin, and probably other toxalbumins which are deadly poisons to higher animals, are only feebly poisonous to certain algae¹. Since carbon monoxide acts as a poison only by forming a non-oxidizable compound with haemoglobin, it is only natural that it should not be poisonous to plants and to lower animals². This also applies to those pigmented bacteria which are able to absorb and accumulate oxygen in the same way that haemoglobin does. There may possibly be exceptions, however, and it has even been stated that hydrogen exerts an injurious action on *Pelomyxa palustris*³.

In adult organs the development of the cuticle hinders the absorption of poisons, to which at the same time the protoplasm may become more resistant. It is probably owing to internal changes that the spores of bacteria become more resistant⁴, but those of certain fungi less resistant than the vegetative parts⁵.

The external conditions also exercise some influence, and dry organisms are almost unaffected by poisonous gases, alcohol, and carbon bisulphide, as

¹ Bokorny, Pflüger's Archiv f. Physiol., 1896, Bd. LXIV, p. 305.

² Kunkel (Centralbl. f. Physiol., 1900, Bd. XIII, p. 565) finds that CO is not poisonous to poikilothermic Vertebrata. Cf. also Mosso, Compt. rend., 1900, T. CXXXI, p. 483.

³ Čelakovsky, Bull. international d. l'Acad. d. Sci. d. Bohême, 1898, p. 23. Perfectly pure hydrogen seems to exercise no poisonous action whatever apart from the effects due to its displacing oxygen. Cf. Ewart, Journ. of Linn. Soc., Vol. XXXIII, 1896, pp. 403-5, and Protoplasmic Streaming, 1903, pp. 39-41. To obtain absolutely pure hydrogen in large quantity is by no means easy. Positive results are always due to the presence of poisonous impurities such as SO_2 , AsH_3 , HCl, H_2S , &c., in the hydrogen employed. The same remarks apply to Samassa's statement (Einwirkung von Gasen auf d. Protoplasmaströmung, &c., 1898, p. 12) that hydrogen acts as a poison on frogs' eggs.

⁴ Brefeld, Unters. ii. d. Spaltpilze, 1878, p. 11 (repr. from Sitzungsber. der naturf. Freunde zu Berlin); Tschirch, Das Kupfer, 1893, p. 45; Flügge, Mikroorganismen, 1896, 3. Aufl., p. 451; Krönig and Paul, Zeitschr. f. Hygiene, 1897, Bd. xxv, p. 1.

⁵ Clark, Botanical Gazette, 1899, Vol. xxviii, p. 400.

well as by poisons dissolved in these media. On the other hand, the action of poisons appears in many cases to be increased in turgid plants by a rise of temperature¹. Furthermore, the presence of other substances may cause a soluble poison to be precipitated, or converted into an innocuous compound. Solutions of sodium and calcium chloride exert a poisonous action upon pollen-grains which is absent when they are grown in inorganic nutrient solutions or in water². This is possibly the result of mass-action, the displacement of potassium or calcium fatally affecting the constitution of the protoplast³. Bacteria and fungi can, however, withstand concentrated solutions of salt, although large amounts penetrate the protoplasts. The injurious action might also be due to the production of functional disharmony, but it has not been determined to what degree particular substances may so alter the properties and condition of tone of the organism as to render it more or less resistant to poisons⁴.

As in the case of man and other animals⁵, plants can also be gradually accustomed to doses of poisons which would have previously proved fatal. Certain anaerobic bacteria can in this way accommodate themselves to the presence of oxygen. Sorel⁶ has found that the presence of 170 milligrammes of hydrofluoric acid per litre stops the growth of beer-yeast, whereas after gradual accommodation it may continue to grow in solutions containing 1 gramme of acid per litre. Various authors⁷ have shown that bacteria can be accustomed to strong doses of metallic poisons. Trambusti, for instance, found that Friedländer's pneumonia bacillus could be brought to grow in the presence of 1 part of bichloride of mercury per 2,000 of water, although previously solutions of 1 in 15,000 proved fatal. Further, bacteria grown in an acid solution are more resistant to acids than when grown in alkaline ones⁸.

Pulst was able to accustom *Penicillium glaucum* to large doses of

¹ Cf. Flügge, Mikroorganismen, 1896, 3. Aufl., p. 450; Loew, System d. Giftwirkungen, 1893, p. 8; Heider, Centralbl. f. Bact., 1891, Bd. IX, p. 321; Chudiakow, Centralbl. f. Bact., 1898, 2. Abth., Bd. IV, p. 391. Schwarz's statement (Wirkung von Alkaloiden auf Pflanzen, 1897, p. 48), that light acts more injuriously in the presence of alkaloids, requires further proof.

² Lidfors, Jahrb. f. wiss. Bot., 1896, Bd. XXIX, p. 36; 1899, Bd. XXXIII, p. 232. Correns (Bot. Ztg. Orig., 1896, p. 26) states that calcium salts act injuriously on *Drosera*.

³ Cf. Loeb, American Journal of Physiology, 1900, Vol. III, p. 327.

⁴ On antagonistic poisons cf. Kunkel, Toxicologie, 1899, p. 36. On atropine and muscarine cf. Ewart, On the Physics and Physiology of Protoplasmic Streaming in Plants, Clar. Press, 1903, pp. 82, 83. The problems of immunity are of similar nature. Cf. Flügge, l. c., p. 341.

⁵ Kobert, Lehrb. der Intoxicationen, 1893, p. 151; Loew, l. c., p. 80; Davenport, Experimental Morphology, 1897, Vol. I, p. 30 (infusoria, &c.).

⁶ Sorel, Compt. rend., 1894, T. CXVIII, p. 253.

⁷ Kossiakoff, Ann. d. l'Inst. Pasteur, 1887, T. I, p. 465 (boric acid, chloride of mercury); Trambusti, Centralbl. f. Bact., 1893, Bd. XIII, p. 673. Cf. also Dieudonné, Biol. Centralbl., 1895, Bd. XV, p. 109.

⁸ Flügge, l. c., p. 457. On the accommodation of Flagellatae to strychnine cf. Klebs, Unters. a. d. Bot. Inst. zu Tübingen, 1883, Bd. I, p. 289.

nickel, cobalt, cadmium, and mercury, whereas the plant can withstand sulphate of copper in high concentrations without previous accommodation. Germination and growth are, however, slower on solutions of copper when normal spores are used than when the latter are taken from plants grown in the presence of large amounts of copper.

In all these cases we are dealing with a physiological response to increased demands, which result here in an increased resistant power. This special power is gradually lost in the course of a few generations, as the after-effect of the previous treatment dies away. It might, however, be possible to raise varieties in which the special resistant power became a permanent hereditary character¹.

A plant resistant to one poison is not necessarily resistant to all, and hence the accommodation to a particular poison presumably takes place in regard to that poison only. It is, however, uncertain whether this acquired immunity extends to groups of allied substances. In the case of fungi it appears that a plant can accommodate itself to one metallic poison without the poisonous action of others being diminished. Similarly the accommodation of animals by breeding to ricin does not affect the poisonous action of abrin upon them².

Owing to the influence of the present and previous conditions, the maximal and ultra-maximal concentrations for different poisons cannot be precisely fixed even in a particular species. Further, the maximum concentration will depend upon whether the cessation of growth or actual death is taken as an indication of fatal action.

Poisonous action plays an important part in the competition between micro-organisms, and also in the injury of host-plants by parasites. Green plants, however, are usually able to avoid the action of poisons, owing to the absorbent properties of the soil, to the continued removal of the carbon dioxide they produce, and to the precipitation and deposition of poisonous substances in dying tissues, or in living ones in an innocuous form³. The gases from volcanoes, factories, and gas-burners or gas-works, and the liquids from chemical sewage and dye works, as well as salt water and the like, may injure severely or kill plants reached by them⁴.

Apart from its physiological aspect we are not concerned with Toxicology, the older literature of which is given by de Candolle⁵, Treviranus⁶, and

¹ Possibly some of the varieties of yeast have acquired an enhanced resistance to alcohol.

² Kobert, *Lehrb. der Intoxicationen*, 1893, p. 151; Loew, *System d. Giftwirkungen*, 1893, p. 80.

³ Vol. I, Sect. 28; Tschirch, *Das Kupfer*, 1893, p. 13; Otto, *Landw. Jahrb.*, 1896, Bd. xxv, p. 1,007.

⁴ Frank, *Krankheiten d. Pflanzen*, 1895, 2. Aufl., Bd. I, p. 313; Sorauer, *Bot. Centralbl.*, 1899, Bd. LXXX, p. 50. On the resistance of seeds and spores to digestion cf. Ludwig, *Biol. d. Pflanzen*, 1895, p. 365; Huth, *Bot. Jahresb.*, 1888, Bd. I, p. 566.

⁵ De Candolle, *Physiologie végétale*, 1832, T. III, p. 1,324.

⁶ Treviranus, *Pflanzenphysiol.*, 1838, Bd. II, p. 721.

Göppert¹, the newer in part by Frank². The further literature is given in the previous pages.

Zopf³ gives a summary of the works on fungi, and most of the literature on bacteria is given by Flüggé⁴. As regards disinfection it must be remembered that a stoppage of growth is more readily produced than is complete death. Thus Koch⁵ has shown that the growth of the anthrax bacillus is retarded by carbolic acid in a concentration of 1:1,250, and stopped when the concentration reaches 1:850, whereas death is only produced in 0.25 to 0.5 per cent. solutions, and the spores may even remain living a few days in 5 per cent. carbolic acid solutions.

SECTION 73. The Detailed Action of Poisons.

Every poisonous action involves an interaction between a chemical substance and the protoplasm. When sufficiently attenuated a poison may induce reactions which are either innocuous or even of use to the protoplast. This stimulatory action of poisons is of equal importance to their fatally injurious effect when sufficiently concentrated. Many food-materials act as poisons when concentrated, and the same may indeed apply to most substances which when dilute act as exciting or directive stimuli.

Poisons may produce an acceleration as well as a retardation of single functions or of the general activity. Thus small doses of the most varied poisons increase growth, respiration, and the production of heat⁶.

Similarly chloroform and other chemical agencies may awaken or accelerate growth, and under special circumstances may quicken the movements of organs or protoplasmic streaming⁷. In increased concentration a poisonous effect is exercised in all cases, and no preliminary excitation may be shown when sensitive plants are used, even when the poison is applied in attenuated form. Sugar, for instance, retards the growth of nitrate and nitrite bacteria even when a very small amount of it is present.

Particular poisons may affect various functions to different degrees, and some may inhibit growth, movement, or photosynthesis without causing a cessation of respiration and metabolism. Whether these latter may even be accelerated under such circumstances is not certain, but is

¹ Göppert, *De acidi hydrocyanici vi in plantas commentatio*, 1827.

² Frank, *Krankheiten d. Pflanzen*, 2. Aufl., 1894, Bd. I, p. 310.

³ Pilze, 1890, p. 219.

⁴ *Mikroorganismen*, 1896, 2. Aufl., Bd. I, p. 446.

⁵ Flüggé, l. c., p. 466.

⁶ On the acceleration of respiration by poisons see the recent works by Jacobi, *Flora*, 1899, p. 289; Morkowine, *Rev. gén. d. Bot.*, 1899, T. XI, p. 289.

⁷ [Best shown by treating slowly streaming or nearly quiescent cells with dilute ether, alcohol, or glycerine.]

quite possible. High temperatures do in fact cause a cessation of growth and movement in spite of the increased activity of respiration. It is evident that we have in this differential action an important aid to research, and in fact ether, chloroform, and other substances are often used for such purposes.

Poisons may also influence the mode of growth and hence the resultant shape of the plant. Any such change is at once an evidence of an alteration in the activity of the protoplast, which in etherized plants of *Spirogyra* is shown by the replacement of mitotic by amitotic nuclear division. In addition various reversible deformatory changes may be induced in the protoplasm by the action of poisons.

In their responses to poisons plants resemble the lower animals, while in Vertebrata, owing to the complexity of organization, reactions such as the changes in the beat of the heart or in the respiratory mechanism occur, which are absent from the lower organisms.

The visible effects produced in the plant and in the protoplast by a poison are the result of the primary reactions between the protoplasm and the poison, but we are profoundly ignorant as to the precise nature of these primary reactions. Nevertheless the behaviour of the protoplasm to different chemical substances may afford important indications as to its structure, composition, and properties. It is the nature of the protoplasm which determines whether a substance shall act as a poison or not, and we can therefore mainly restrict ourselves to the individual cell. In vascular plants problems of translocation and of correlation also come into play, for a poison can naturally exercise no influence upon a particular internal cell if it is absorbed and retained by the intervening tissues, while the action of a poison upon one organ may result in related organs being also affected. Even in an isolated cell the poison must first pass through the cell-wall. Hence the presence of a relatively impermeable cuticle may render a cell capable of withstanding immersion in a highly poisonous solution, owing to the fact that fewer molecules of the poison bombard the protoplast in a unit of time than when a cell with permeable walls is immersed in a solution of nearly non-poisonous dilution. Cuticularized hair-cells behave in this way, and it can easily be seen that poisonous aniline dyes or ammonia only penetrate their protoplasts very slowly¹.

A poisonous action can only be exercised when the poison penetrates the protoplasm. In this case methyl blue acts as a poison in extreme dilution (1 : 1,000,000), whereas as much as 1 per cent. can be accumulated in the form of non-diosmosing compounds in the cell-sap without the cell being injured². Similarly the non-diosmosing tannate of methyl blue is

¹ Pfeffer, *Unters. a. d. Bot. Inst. zu Tübingen*, 1886, Bd. II, p. 201 seq.

² *Id.*, l. c., p. 184. Methyl violet behaves similarly, its diosmosing salts being even more poisonous than those of methyl blue. Overton (*Vierteljahrsschrift d. Naturf. Ges. zu Zürich*,

innocuous. A poison may be converted into a harmless compound during its absorption by the protoplasm, or during its passage through the cell-wall. Hence it arises that many flowering plants can accumulate large quantities of zinc, although the diosmosing salts of this metal are highly poisonous. The accumulation of a large quantity of a poisonous substance in a plant does not in fact necessarily show that the protoplasts are indifferent to this poison. Furthermore, as in the case of the cuticle, a relatively impermeable plasmatic membrane may hinder the absorption and injurious action of a soluble poison.

The influence of a particular poison is not merely a question of absorption or non-absorption, but is probably mainly determined by the specific nature of the protoplasm. Thus different species are unequally resistant to free acids, although these readily penetrate the protoplasm. The same applies to alcohol, ether, chloroform, and other substances which are unequally poisonous to different plants¹.

On the other hand, the resistance of *Penicillium glaucum* to copper salts is due to their non-penetration of the protoplasm. Pulst found so little copper in mycelia grown on strong cupric solutions, that the small amount was probably due to mere adherence, or to the absorption of copper by the cell-walls and dead protoplasts. In any case the amount was less than if the copper had penetrated to the cell-sap, for the slowest penetration would result on prolonged cultivation in the equalization of the internal and external percentages, even in the absence of any passive secretion.

The ectoplasmic membrane of *Penicillium* is therefore so constituted as to be able to retain its living properties when in contact with a solution of copper, for if it were killed the poison would at once penetrate to the protoplasm. This occurs in the case of most poisonous metallic salts, and it is uncertain whether the materials of the plasmatic membrane in *Penicillium* do not react to copper salts, or whether they become covered by a precipitation membrane impermeable to salts of copper².

1896, Bd. XLI, p. 403; 1899, Bd. XLIV, p. 108) states that the salts of alkaloids penetrate more slowly than the free bases, and hence are less poisonous. [This might also be the effect of neutralization. Thus a solution of veratrine is alkaline; its nitrate is neutral and hence less poisonous. Cf. Ewart, On the Physics and Physiology of Protoplasmic Streaming in Plants, Clar. Press, 1903, pp. 83, 84.]

¹ Overton (Vierteljahrsschrift d. Naturf. Ges. zu Zürich, 1899, Bd. XLIV, p. 106) has recently shown that various substances, including carbon monoxide, rapidly penetrate the protoplast.

² Overton (l. c. ; Jahrb. f. wiss. Bot., 1900, Bd. XXXIV, p. 670) concludes that only those bodies are absorbed which are soluble in oil or fatty substances, such as cholesterolin and lecithin, which impregnate the plasmatic membrane. Such impregnation may play an important part in regulating absorption, but nevertheless the proteid components of the plasmatic membrane are also of importance, and their existence is shown by the rigor induced by dilute acids and by mercuric chloride. Further research will undoubtedly show that many substances will readily penetrate which are insoluble or nearly so in fats and oils. Indeed some of the salts of copper

It remains therefore to be determined whether the protoplasm of *Penicillium* is as sensitive to salts of copper as that of other plants. It is worthy of note that various poisonous heavy metals are not absorbed by the intact lining epithelium of the alimentary canal¹.

SECTION 74. The Detailed Action of Poisons (*continued*).

The different parts of the protoplast have not all the same power of resistance to poisons. Thus in the case of *Penicillium* the plasmatic membrane is presumably more resistant than the rest of the protoplasm, and it often happens that a poison kills the nucleus before the cytoplasm is fatally affected². Probably also poisonous aniline dyes will exert most influence upon those organs which absorb and accumulate them to the greatest extent³. This may be in some cases the nucleus, in others the cytoplasm, but owing to the general similarity of composition it is only natural that all poisons which kill the nucleus should ultimately kill the cytoplasm as well. Similarly the fact that chloroform and ether produce a cessation of protoplasmic streaming both in the presence and absence of the nucleus, shows that they act directly upon the cytoplasm and not upon the nucleus alone⁴.

Without doubt the power of resistance varies in the different cells and organs of a plant. When, however, a single organ such as a leaf is killed by poison, the plant as a whole will not be more affected than by the direct removal of the leaf, whereas in the case of a vertebrate animal any poison which acts injuriously upon the heart, lungs, or nervous mechanism will ultimately produce death.

It is easy to understand that acids and alkalis should act as poisons in virtue of their pronounced chemical activity, and that the same should be the case with all substances which combine with the proteid or other constituents of protoplasm. It is also possible that loose chemical union, or physical absorption, or catalytic action may produce death. Indeed the poisonous action of aniline dyes, chloroform, ether, and alkaloids seems to be due to their loose chemical union with the protoplasm.

are soluble in fats, although neither the nitrate, sulphate, nor alkaline solutions of copper can penetrate *Penicillium*.

¹ Kunkel, Toxicologie, 1899, p. 119.

² Pfeffer, Unters. a. d. Bot. Inst. zu Tübingen, 1886, Bd. II, pp. 206, 276; Klemm, Jahrb. f. wiss. Bot., 1895, Bd. XXVIII, p. 687.

³ Pfeffer, l. c., p. 273; D. H. Campbell, *ibid.*, 1888, Bd. II, p. 569.

⁴ By appropriate treatment the ectoplasm can be killed before the streaming endoplasm is fatally affected, and the chloroplastids can be killed without the rest of the cell being seriously injured. The order of death in the different parts of the cell varies according to the agency used and its mode of application. Cf. Ewart, Journ. of Linn. Soc., 1896, Vol. XXXI, pp. 406, 574; On the Physics and Physiology of Protoplasmic Streaming, Clar. Press, 1903, p. 98.

Nencki¹ suggests that tox-albumins act catalytically like enzymes, and it is certain that a protoplast must die if some of its essential constituents are decomposed by the penetration of a proteolytic enzyme. It is also possible that the catalytic acceleration or retardation of one or more partial functions might produce disturbances leading to death. In fact a substance may act in some such way as a powerful poison, without combining with the protoplasm or entering into metabolism. The poisonous aniline dyes are not assimilated, and the same probably applies to most poisonous alkaloids² and to chloroform.

The action of acids is mainly due to the fact that they form salts with substances connected in some way or other with the living protoplasm³. An active acid produces a granular precipitate of proteids, and destroys the plasticity of the protoplasm even when in great dilution⁴. The known properties of proteids lend support to the view that alkalies produce swelling and solution in the protoplasmic constituents.

The poisonous heavy metals probably act by entering into combination with constituent proteids⁵. In addition formic aldehyde and other substances which react energetically with proteids act as strong poisons, provided that they are able to penetrate the protoplast.

Chloroform, ether, alkaloids, and aniline dyes do not form fixed compounds, since they are rapidly removed on immersion in water. This can be repeated several times by using very dilute solutions of methyl violet or of cyanin⁶. The fact that the dye accumulates especially rapidly in certain regions of the cytoplasm affords no clue as to its mode of action. It is even uncertain whether the fixation is physical or chemical in nature, for by means of dissociation and mass-action combined pigments and other substances may be soaked out of the cell⁷. Many of these substances may enter into loose combinations like that of carbon monoxide with haemoglobin, and gradually accumulating may affect some essential material normally present⁸. If in a particular species the conditions for such a reaction do not exist, then the poison in question would be innocuous in this case. The fact that enzymes may leave the negative and positive varieties of a fermentable substance untouched, shows that a trifling dissimilarity of structure or composition may enable closely related protoplasts to react dissimilarly to particular poisons.

¹ Cf. Loew, System d. Giftwirkungen, 1893, p. 68.

² [Admirably shown by immersing *Elodea* in dilute veratrine nitrate, when the nitric acid is slowly absorbed and the veratrine precipitated. *Penicillium* can assimilate various alkaloids. Cf. Ewart, On the Physics and Physiology of Protoplasmic Streaming, Clar. Press, 1903, pp. 84, 85.]

³ The protoplasm need not always be alkaline.

⁴ Klemm, Jahrb. f. wiss. Bot., 1895, Bd. XXVIII, p. 658. The destructive action of concentrated acids and alkalies does not concern us.

⁵ Kunkel, Handbuch d. Toxicologie, 1890, p. 118.

⁶ Pfeffer, Unters. a. d. Bot. Inst. zu Tübingen, 1886, Bd. II, p. 252.

⁷ The theory that chloroform combines with the lecithin constituents of the protoplasm is based upon the solubility of chloroform in this and other oily substances. Cf. Kunkel, l. c., p. 386; Overton, Studien über Narkose, 1901.

⁸ Potassium may in certain cases be displaced by sodium.

The peculiar behaviour of *Penicillium* shows that generalizations as to the universal poisonous action of a particular substance need to be made with extreme caution. Nor is it permissible to draw conclusions from the actions of poisons on dead proteids, as to their action upon the living organism which, owing to its complexity, offers various points of attack. The suggestion, for instance, that a high oxygen-pressure acts fatally by unduly increasing the respiratory activity is incorrect, for as a matter of fact the reverse is the case.

Various theories have been put forward to explain the primary action of poisons, but these do not give any further insight into the structure and composition of the protoplasm, and hence do not require discussion¹.

The power of an organism to withstand a certain amount of poison is a special instance of the property of accommodation. A plant may grow in the constant presence of an infra-minimal percentage of poison just as it may at temperatures below the optimum, although certain functional disturbances are shown. Similarly recovery may be possible from supra-maximal concentrations of poisons, provided the action has not been too prolonged and the poison is rapidly removed again or rendered innocuous.

In the case of substances such as ether, chloroform, alkaloids, and aniline dyes, which are held loosely by the protoplasm in the form of dissociating compounds, it is sufficient to place the plant in a large quantity of pure water, or of air when ether and similar volatile poisons are present. The protoplasm may, however, play an active part in the removal of a poison by converting the poison into a diosmosing substance. This occurs when the tannate of methyl blue is slowly removed from a cell in the presence of a trace of acid. Similarly after transitory immersion in comparatively strong solutions of methyl violet and of cyanin, it can easily be seen how the colouration and deformation of the cytoplasm gradually disappear again. The same happens when the cell-sap accumulates the poison and withdraws it from the cytoplasm². This affords a good instance of the fact that a poison may remain in a cell and yet be so deposited as to be harmless.

In the root-hairs of *Trianea bogotensis* penetrating particles of Bismarck brown combine with fragments of the cytoplasm which are then ejected into the cell-sap³. This probably often occurs, the poison combining with some substance already present in the cell. If no renewed formation of this substance is induced then only a limited quantity of poison can be disposed of. There can, however, be little doubt that in particular cases reactions may be excited which tend to the removal or destruction of the poison. The protoplasm is able to restore its original alkalinity after it has been made feebly acid. If this were continuous then the poisonous action of slowly penetrating dilute acid might be neutralized,

¹ Cf. Loew, System d. Giftwirkungen, 1893.

² Pfeffer, Unters. a. d. Bot. Inst. zu Tübingen, 1886, Bd. II, pp. 248, 259, 274.

³ Id., l. c., p. 262.

and a salt produced which could readily diosmose away. Phenols and other poisons are presumably often converted into exosmosing innocuous compounds¹. Similarly the physiological combustion of alcohol results in the production of products which are either innocuous (water) or can readily diosmose away (carbon dioxide).

Although a plant may avoid the effects due to the presence of an acid by a corresponding production of alkali, it does not always follow that a poison will be overcome by the formation of an antagonistic one. Nor is accommodation necessarily the result of an increased production of an antitoxin², of which in fact there can be no question when a plant becomes accommodated to high temperatures, or to concentrated solutions of an indifferent substance. The actual origin of these alterations is as little known as that of the changes which occur during the normal progress of development.

In addition to the means of withstanding poisons already mentioned, a few free-swimming forms have a power of perception and response which enables them to flee from particular poisonous substances such as acids and alkalies³. Non-motile organisms, however, absorb almost all poisons when presented in suitable form, although *Penicillium* behaves exceptionally in this respect towards copper salts.

Single submaximal doses of poison usually exert an effect which slowly increases to a maximum and then dies away again. If the plant is, however, in permanent contact with a submaximal concentration of poison, a state of equilibrium is ultimately reached, which persists as long as the conditions are unaltered. The protoplast then contains a constant percentage of poison, independently of whether the poison is accumulated within the cell or not. This constancy is the result of the interaction of various affinities and other factors, and is indeed only maintained by perpetual change, when the protoplast continually removes or destroys the poison as it penetrates. If the activity of repair is slight, and if the poisonous action is increased by the accumulation of the poison, then in time extremely dilute solutions of poison may prove fatal, as for example when plants of *Spirogyra* are submerged in large quantities of water containing the merest trace of copper. The maximum and ultra-maximum for a poison are determined by observing the concentration in which the plant or cell can continue to exist, and that in which it ultimately dies. In this way the relative intensities of two poisons can be compared, and also the relative resistance of two different cells. Such determinations have more scientific value than estimations of the smallest dose of poison required to kill a

¹ As regards animals cf. Kunkel, Toxicologie, 1899, pp. 10, 391.

² On toxins and protective substances see the summary by Oppenheim, Biol. Centralbl., 1899, Bd. XIX, p. 799.

³ Pfeffer, Unters. a. d. Bot. Inst. zu Tübingen, 1886, Bd. II, p. 627.

particular animal, for this leaves uncertain the concentration needed to act upon the responding cells and cell-elements in order to produce the effect observed ¹.

In supra-maximal concentrations of poison an organism may be injured and die either rapidly or after a very long time, according to the nature of the poison and its degree of concentration. This latter behaviour, which Overton ² terms a progressive action, is not peculiar to the action of poisons. Transitory exposure to high temperatures or to the action of poisons may alike cause gradual death on the subsequent restoration to optimal conditions. This may even occur when no poison remains in the cells, although the retention of a portion of the poison may naturally cause the injurious action to continue for some time.

SECTION 75. The Influence of Chemical Constitution on Poisonous Action.

It is easy to understand why acids and alkalies should act as poisons to all plants, although owing to our ignorance of the physical and chemical constitution of the protoplasm we are in most cases unable to predict whether a substance of known chemical composition will act as a poison. Hence actual experiment is usually necessary to determine whether any material is poisonous, nutritious, or indifferent. The fact that different protoplasts respond dissimilarly is sufficient to show that the protoplasm varies more or less in its physical character and chemical composition. Experiment has shown that the nutrient value and also the poisonous action of allied chemical substances may differ widely, while dissimilar substances may be physiologically equivalent in the above respects ³.

Hence the physiological value of a substance may be considerably modified by a slight change of molecular structure, whereas similar changes involving substitution, rearrangement, or polymerization in two different compounds do not always result in corresponding alterations of their physiological action. For instance, the poisonous character of organic compounds is usually but not always increased by the addition of chlorine atoms or nitro groups. Further, the substitution of hydroxyl, ethyl, or methyl for hydrogen, or the introduction of amido groups, increases the poisonous action in some cases, but decreases it in others. The members of the alcohol series become more poisonous as the molecular weight increases, but this is not always the case in such series. The poisonous action is also increased when the introduction of a carboxyl group renders a substance acid or increases its

¹ Cf. Overton, *Vierteljahrsschrift d. Naturf. Ges. in Zürich*, 1899, Bd. XLIV, p. 128; Kunkel, *Toxicologie*, 1899, p. 4.

² Overton, *l. c.*, p. 128.

³ For details see Loew, *System d. Giftwirkungen*, 1893, pp. 44, 92, 129; Kunkel, *l. c.*, pp. 391, 402 seq.; Overton, *l. c.*, p. 124; True and Hunkel, *Bot. Centralbl.*, 1898, Bd. LXXVI, p. 398 (phenol); Wehmer, *Chemiker-Zeitung*, 1897 (benzoic acid).

acid character. Such reactions as these acquire their chief importance from the insight of the protoplasmic constitution which they may render possible.

The facts observed in the case of organic compounds suffice to show that the physiological action is determined by the grouping of the component atoms and atom-complexes, and is not the direct result of the properties of the individual atoms. When a compound is split up, the physiological action is the resultant of the sum of the properties of the simpler materials¹. The same applies when a substance undergoes dissociation, so that the electrolytic salts of a poisonous metal may all exercise the same physiological and chemical action when the acid ions are indifferent². When the dissociation is incomplete, the undissociated portion may exercise a physiological action of its own apart from that due to the dissociated ions.

When a dissociating compound is innocuous, its ions must also be non-poisonous. Experiments with the chlorides, sulphates, and nitrates of potassium, sodium, and calcium have shown that both the metallic ions (kations) and the acid ions (anions) are either quite innocuous or only very feebly poisonous. Hence the poisonous character of potassium cyanide is due to the anion cyanogen, and that of the chlorides, nitrates, and sulphates of mercury and copper to the metallic ions, for all these salts are entirely or nearly entirely dissociated when in considerable but still poisonous dilution. The same principles apply to free acids in which hydrogen plays the part of a metal, and to free alkalies in which hydroxyl replaces the acid ester (anion). Since the anions and kations of the neutral salts of the above-mentioned alkalies and alkaline earths are non-poisonous, it follows that the injurious action of free acids is due to the hydrogen ions and that of alkalies to the anion hydroxyl.

In acids with innocuous anions the poisonous action is dependent upon the degree of dissociation. Thus hydrochloric, nitric, and sulphuric acids which undergo complete dissociation when largely diluted are extremely poisonous, whereas the slightly dissociating acetic and propionic acids are only feeble poisons. The combining avidity of such acids is also slight as compared with those which readily dissociate. When the anion of an acid is highly poisonous, as in the case of the cyanogen radicle of prussic acid, only a small portion of its poisonous action is due to its properties as a weak acid.

Similar relationships are shown by alkalies such as sodium and potassium hydrate, which dissociate very largely in dilute solutions. Clark found that the hydroxyl ion was more poisonous to fungi than that of hydrogen, whereas the reverse was found to be the case by Krönig and Paul in bacteria, and by Kahlenberg and True in Phanerogams. It remains to be seen whether this is due to differences in the specific resistance of the groups

¹ Special results may be produced by such conjoint action.

² Cf. Ostwald, *Wiss. Grundlagen der analytischen Chemie*, 1897, p. 44.

named, or to the fact that dilute solutions of alkalies are rapidly converted into carbonates by respiring plants. The ions of mercury, silver, and cyanogen are, however, certainly much more poisonous than those of either hydrogen or hydroxyl.

After Wüthrich had compared the poisonous action of equivalent solutions, various authors worked with equimolecular concentrations¹. The ratio 1 : 16 or the fraction $\frac{1}{16}$ indicates a solution containing one gramme-molecule in 16 litres. In the case of mercuric chloride, whose molecular weight is 271, the 16 litres would contain 271 grammes of solid. Therefore 1 cubic centimetre contains $271 \div 16,000 = .0169$ of a gramme, which is a 1.69 per cent. solution. It is only when equimolecular solutions are used that the influence of dissociation and of combination with different radicles can be determined.

The differences in the detailed results obtained by the above authors are due partly to the specific peculiarities of the plants examined, and partly to the fact that Krönig and Paul observed the concentration required to produce rapid death, whereas the other authors noted that required to stop growth. In the latter case, when the maxima and minima for growth are noted, the rapidity of penetration as well as the degree of dissociation become of less importance, for during a prolonged experiment a condition of equilibrium will be reached after a time. A large quantity of a slightly dissociated substance can, in time, accumulate within the cell, even when only the ions diosmose, provided that they enter into combination within the cell, so that a continuous inward stream is kept up².

It is possible that the relation between the poisonous action and the degree of dissociation shows best in the case of acids and alkalies, because these substances readily penetrate the protoplast. Whether the rapidity of absorption is of importance or not, the degree of dissociation is certainly decisive as regards poisonous action. Thus Kahlenberg and True found that the dissociating chloride of iron is as poisonous in a concentration of 1 : 22,400, as is colloidal iron in a strength of 1 : 1,174. Further, sulphate of copper after the addition of cane sugar and potassium hydrate only exerts the same action in a strength of 1 : 400 as it does

¹ Wüthrich, Zeitschr. f. Pflanzenkrankheiten, 1892, Bd. II, p. 16; Kahlenberg and True, Botanical Gazette, 1896, Vol. XXII, p. 81; Zeitschr. f. physikal. Chemie, 1897, Bd. XXII, p. 474; Heald, Botanical Gazette, 1896, Vol. XXII, p. 125; Krönig and Paul, Zeitschr. f. Hygiene und Infektionskrankheiten, 1897, Bd. XXV, p. 1; True and Hankel, Bot. Centralbl., 1898, Bd. LXXVI, p. 289; Stevens, Botanical Gazette, 1898, Vol. XXVI, p. 377; Clark, *ibid.*, 1899, Vol. XXVIII, p. 289. [Equivalent solutions are not always equimolecular. Thus equivalent solutions of sodium carbonate (Na_2CO_3) and sodium bicarbonate (NaHCO_3) will contain 1 gramme-molecule of Na_2CO_3 (106 grammes) to 2 gramme-molecules of NaHCO_3 (168 grammes). Similarly equivalent solutions of acids will contain equal numbers of atoms of displaceable H, so that normal or decinormal solutions of HCl contain twice as many molecules as similar solutions of H_2SO_4 . When diluted these solutions will contain equal numbers of free sodium and hydrogen ions respectively.]

² [A good instance of this is afforded when a cell of *Elodea* is immersed in a solution of veratrine nitrate, for as the nitric acid ions are absorbed and assimilated the insoluble veratrine is precipitated inside and outside the cell. *Penicillium*, however, can assimilate veratrine, so that if it is grown on an inorganic nutrient solution to which potassium and veratrine nitrates have been added, the solution becomes acid instead of alkaline, some of the nitric ions being set free.]

without these additions when one gramme-molecule is dissolved in 51,200 litres of water. Similarly a solution of silver nitrate containing one gramme-molecule in 204,800 litres exercises the same effect as a solution of one gramme-molecule of $\text{AgNO}_3 + 3\text{KCN}$ in 25,600 litres. The poisonous action is therefore decreased, owing to the formation of the feebly dissociating cyanide of silver, in spite of the addition of potassium cyanide, which is a strong poison, though not as strong as is silver nitrate. Krönig and Paul have, however, found that the presence of a little alcohol increases the poisonous action of mercuric chloride and of silver nitrate, but not of phenol, either because of its action on metabolism, or because it increases the rapidity of absorption. Strong alcohol, on the other hand, greatly decreases the poisonous action in plants able to withstand the consequent withdrawal of water.

It follows from the above that the disinfecting power of a poison depends upon a variety of factors, and is not the direct measure of the quantity of the poisonous base or acid present, as has been frequently incorrectly assumed¹.

Non-electrolytes are also poisonous, and by chemical decomposition the poisonous properties may be altered in the same way as when an electrolyte undergoes dissociation. The form in which a compound is presented is of great importance even in a dissociating electrolyte. Thus in the form of ferrocyanogen iron has a dissimilar action to that exerted by it as a base combined with an acid. Complex metallic ions appear to be less poisonous than simple ones, and hence in general the poisonous action of metallic salts appears to be increased by dissociation. It is, however, possible that with some substances the reverse may be the case, just as the products of the decomposition of a non-electrolyte may be more or less poisonous than the original substance. Further, an innocuous compound of a poisonous metal, which does not dissociate in water, will act as a poison if the protoplast withdraws the poisonous metallic ions from the compound.

¹ Cf. Flügge, *Mikroorganismen*, 1896, 3. Aufl., Bd. I, p. 453.

INDEX

- Abies*, rapidity of growth in, 15.
 Abrin, action of, on algae, 261.
 Abscission, 216.
 — layer, 44.
Abutilon, grafting of, 174.
 Accommodation, influence of, on cardinal points, 70; non-heredity of, 195; to extremes of temperature, 80; to poisons, 262, 263.
Acer platanoides, temperature limits for growth of, 76.
 Acetic acid, poisonous action of, 272.
 — bacteria, temperature limits for growth of, 76.
 Acids, influence of, on *Mucor*, 117; mode of action of, 267, 268; use of, in competition, 259.
Actinosphaerium Eichhorni, centrosomes in, 43.
 Adaptation to cold, 236.
Adoxa, influence of light on, 89; — light on runners of, 93.
Aecidium, galls due to, 171.
 Aerenchyma, 122.
 Aesculin, influence of, on zoospore formation, 118.
Aesculus, influence of light on hypocotyl of, 87; leaf-fall in, 217.
Aethalium, influence of cold on, 238; *A. septicum*, influence of change of concentration on, 257.
Agave, strains in epidermis of, 65; *A. americana*, contractile roots of, 14; elasticity of fibres of, 55; influence of slow thawing on, 235.
 Ahlfvengren, 106.
 Air-pressure, influence of, on formation of sexual organs, 118; — on growth of trees, 125.
 Aitiomorphosis, 72, 137.
 Aitionomic, 137.
 Aitionomy, 149.
 Aitiotropism, 137.
 Albert, 206.
Albicia moluccana, rapidity of growth of, 16.
 Albinism, transference of, by grafting, 174.
 Alcohol, influence of, on poisonous action, 274; maximal percentage of, for yeast, 259; resistance of seeds and spores to, 252; vitality of seeds in, 251.
 Algae, growth of, at low temperatures, 77; — in saturated KNO_3 solutions, 119; influence of changes of concentration on, 119; — chemical stimuli on, 118; — external conditions on life-cycles of, 198; — light on, 90; — temperature on, 84; — water-pressure on distribution of, 126, 127; periodicity in, 209; reproduction of, 168; resistance of, to desiccation, 255.
 Alkalies, mode of action of, 267, 268.
 Alkaloids, action of, 260, 268.
Allium, intercalary growth in leaf of, 9.
 Alpine plants, causes of peculiar shape of, 100; early flowering of, 211.
 Alternation of generations, influence of external conditions on, 198, 199.
Amaryllis formosissima, dorsiventrality of, 153.
 Ambrohn, on limit of elasticity, 56.
 Amelung, 39, 89, 91.
 Amitosis, 148; production of, 43.
 Ammonia, influence of, on nitrate bacteria, 112.
 Amoebae, influence of freezing on, 241.
Ampelopsis, influence of contact on tendrils of, 129; — transitory cold on, 210; *A. hederacea*, influence of light on, 89; inversion of, 159.
 Amphibious plants, shapes of leaves of, 120.
 Amygdalin, influence of, on zoospore formation, 118.
Amygdalus communis, growth of, as evergreen, 212.
 Anaebiosis, 221.
 Anaerobes, accommodation of, to oxygen, 114; action of oxygen on, 259.
 Anaerobic bacteria, influence of oxygen on, 117.
Ancylistes closterii, 17.
Angelica archangelica, influence of desiccation on seeds of, 254.
 Aniline dyes, mode of action of, 268.
 Animals, comparison of, with plants, 4.
 Anisophylly, 154; influence of gravity on, 109.
 Anisotropic, definition of, 73.
 Anisotropy, influence of gravity on, 109.
Anixiopsis stercorarius, limits of temperature for growth and formation of perithecia in, 80.
 Annual rings, causes of, 215, 216.
 Antagonistic action, 269, 270.
 Anthrax bacilli, action of carbolic acid on, 264; influence of salt solution on, 258.

- Anthurium longifolium*, conversion of root-apex into shoot, 140.
- Anticlinals, 48.
- Antithamnion cruciatum*, contractile rhizoids of, 14.
- Antitoxins, use of, 270.
- Apical cell, regeneration of, 170.
- Apiocystis*, growth of cell-wall of, 30.
- Apples, freezing of, 241; freezing-point of, 242.
- Apposition, 25, 29, 30; in starch-grains, 35.
- Archegonium, influence of, on planes of division, 158.
- Arnoldi, 10, 144, 182.
- Arnould, 193.
- Artari, 229.
- Arthur, 208.
- Arum maculatum*, contraction of roots of, 14.
- Asci, influence of starvation on production of, 116.
- Ascobalus*, stretching of membranes of, 57.
- Ascoidea rubescens*, influence of food on formation of conidia by, 116.
- Ascophanus carneus*, influence of starvation on formation of asci in, 116.
- Ascophyllum nodosum*, polarity of, 157.
- Askenasy, 5-12, 16, 29, 46, 79, 81, 84, 91, 120, 161, 177, 206, 214; on early flowering, 205; on periodicity, 213; on rate of growth of staminal filaments, 17.
- Asomatophytes, growth in size of embryonic cells in, 5.
- Asparagin, influence of, on nitrifying bacteria, 112.
- Aspergillus*, apical growth of hypha of, 5; conditions for germination of spores of, 113; influence of food on cardinal temperatures for, 80; — moisture on formation of spores by, 123; *A. fumigatus*, resistance of, to desiccation, 255; temperature limits for growth of, 76; — importance of, 78; *A. glaucus*, influence of light on, 247; *A. niger*, accommodation of, to concentrated solutions, 119; action of CuSO_4 on, 260; non-formation of conidia under water, 121; temperature limits for growth of, 76.
- Aspidium villoscens*, minimum temperature for, 233.
- Atkinson, 103.
- Atropa Belladonna*, shortening of hypocotyl of, 14.
- Atropin, accumulation of, in grafted potatoes, 174.
- Attachment, influence of contact on organs of, 129, 130.
- Automorphosis, 137.
- Autonasty, definition of, 73.
- Autonomic, 137.
- Autoplasmy, 137.
- Autotropism, 137.
- Auxanometer, 21, Fig. 8, 22.
- Auxesis, definition of, 73, 74.
- Avena*, 19; conducting paths in, 186; *A. sativa*, influence of injury on growth of, 134.
- Azolla*, influence of soil on growth of roots of, 122; root abscission in, 218.
- Bachmann, 80, 90, 117, 121, 123.
- Bachmetjew, 242, 244.
- Bacillus*, influence of changes of concentration on, 256; *B. anthracis*, accommodation of, to low temperatures, 80; action of CuSO_4 on, 260; asporogeny in, 193; influence of cold on, 238; — light on, 247; — temperature on growth of, 81; — change of temperature on, 82; resistance of spores of, to heat, 226, 227; temperature limits for growth of, 76; *B. butylicus*, resistance of, to heat, 227; *B. carotarum*, influence of desiccation on, 256; *B. cyaneo-fuscus*, temperature limits for growth of, 76; *B. fluorescens*, accommodation of, to high temperatures, 80; *B. mesentericus vulgaris*, resistance of, to heat, 227; *B. prodigiosus*, motile variety of, 194; *B. subtilis*, accommodation of, to high temperatures, 80; influence of cold on, 238; — temperature on growth of, 81; resistance of, to heat, 226; temperature limits for growth of, 76; *B. tuberculosis*, temperature limits for growth of, 76; *B. tumescens*, influence of temperature on, 81; *B. typhi*, influence of desiccation on, 251.
- Bacteria, accommodation of, to poisons, 262; action of hydrogen ions on, 272; — light on, 248, 249; diameter of, 39; dividing size of, 38; freezing of, 241, 244; influence of desiccation on, 251; — mechanical vibrations on, 131; — temperature on, 84; life of, in plasmolytic solutions, 257, 258; rapidity of growth of, 15, 16; resistance of, to boiling, 226, 227; — to cold, 238; — to desiccation, 255, 256; temperature limits for growth of, 76.
- Bacterium coli*, immotile varieties of, 194; *B. photometricum*, rapid response of, 96; *B. ramosum*, asporogeny of, 193; *B. Zoffi*, influence of desiccation on, 256.
- Bactridium butyricum*, optimum percentage of oxygen for, 114.
- Bambusa gigantea*, growth-coefficient of, 16, 17.
- Baranetsky, 22, 96, 128; on periodicity, 201-3.
- Barbula muralis*, resistance of, to desiccation, 250; — to heat, 229.
- Barkhausia taraxifolia*, fasciation of, 165.
- Barth, 111.

- Bary, de, 6, 13, 34, 44, 53, 84, 92, 113, 114, 121, 130, 215, 227, 229, 255; on resting period of spores, 208.
- Barymorphosis, 2.
- Basidiobolus ranarum*, influence of food on reproduction of, 116, 198.
- Bast fibres, elasticity of, 55.
- Batalin, 88, 99, 210.
- Bateson, 66.
- Batrachospermum*, influence of light on, 90.
- Bauhinia*, changes of shape in attached tendril of, 127.
- Bauke, 151.
- Bay, 239.
- Beauverie, 123.
- Beck and Schultz, 105, 248.
- Becquerel rays, action of, on plants, 106.
- Beech, leaf-fall in, 217; rate of growth of, 16; resting period of, 206.
- Beer, 140.
- Beet-root, contraction of radicle of, 14; freezing of, 242; influence of grafting on flowering of, 176.
- Begonia*, early flowering of, 152; *B. manicata*, signs of death in, 235.
- Behrens, 83, 140, 153, 157.
- Behring, 193.
- Beissner, 152.
- Bellis perennis*, resistance of, to cold, 232.
- Benecke, 18, 113.
- Bennet, 9.
- Bernard, 173, 252; on physiology of development, 3.
- Bert, 114; on action of green rays, 103.
- Berthold, 5, 34, 41, 42, 85, 90, 91, 94, 126, 154, 209; on contractile rhizoids, 14; on surface-tension theory of cell-division, 41.
- Beta vulgaris*, size of etiolated leaves of, 86.
- Bex, organisms in hot springs of, 77.
- Beyerinck, 81, 116, 152, 160, 167, 172, 173, 174, 175, 192, 193; on cardinal points for growth, 76; on conversion of root-primordia into shoots, 140; on regeneration, 169.
- Bialoblocki, 81, 230.
- Biophores, 187.
- Biota orientalis*, induction of dorsiventrality in, 151.
- Bismarck brown, union of, with cytoplasm, 269.
- Bitter, 15, 46, 130.
- Blue rays, action of, 248.
- Boirivant, 162.
- Bokorny, 259, 260, 261.
- Bolley, 223.
- Bonnet, 88.
- Bonnier, 88, 98, 100, 101, 118, 122, 252.
- Borge, 130.
- Borodin, 92, 102.
- Botrydium*, influence of concentration on, 121.
- Botrytis*, apical growth of hypha of, 5; influence of cold on, 238; *B. cinerea*, action of CuSO_4 on, 260; formation of attaching organs of, 130; growth-coefficient of, 16; influence of coloured light on spore-formation of, 102; *B. vulgaris*, germination of, on water, 113.
- Bouche, 211.
- Boussingault, 237.
- Boveri, on cell-division in absence of nucleus, 43.
- Branches, shearing stresses in, 50.
- Brand, 10, 120.
- Brassica Rapa*, periodicity in, 203.
- Braun, 42, 168, 210, 254.
- Brefeld, 15, 79, 81, 90, 92, 97, 101, 102, 104, 169, 178, 228, 261; on conditions for formation of sporophore of *Coprinus*, 79; on growth of fungi, 17; on resistance of spores to heat, 227.
- Brenner, 100.
- Bretfeld, 217.
- Brewer, on thermophile algae, 77.
- Brown and Escombe, 252; on influence of low temperature, 237.
- Bruhns, 119.
- Bryonia dioica*, influence of darkness on, 87.
- Bryophyta*, influence of light on, 90; — germination of spores of, 92.
- Bryopsis*, bursting of, in fresh water, 119; *B. muscosa*, inversion of, 156, Fig. 27.
- Bryum caespiticium*, resistance of, to desiccation, 250; — to heat, 226, 229.
- Buchner, 15, 116, 131.
- Buchtien, 42, 157, 255.
- Buds, abscission of, 217; causes of non-development of, 166; influence of gravity on formation of, 109; — removal of, 161; resistance of, to cold, 236; — to heat, 228.
- Büsgen, 7, 93, 109, 128, 130, 152, 215, 217, 232.
- Bütschli, 25, 35, 36, 37.
- Bulbs, regulation of depth of, 14.
- Bureau, 254.
- Burgerstein, 254.
- Busch, 166.
- Busse, 162, 206.
- Cactaceae, influence of darkness on formation of roots by, 92.
- Cactus, change of phyllotaxis in, 145.
- Calanthe*, signs of death of, 235.
- Calcium chloride, action of, on pollen, 252.
- Calendula officinalis*, action of light on, 248.
- Calla*, production of air-spaces in, 45.
- Callithamnion*, formation of branches in, 5; size of apical cells of, 38.
- Calluna vulgaris*, early flowering of, 211.
- Callus, conditions for formation of, 132; development of, 133.
- Cambium, general characters of, 146.

- Cambium cells, divisions in, 42; size of, 39.
- Campanula rotundifolia*, influence of light on, 91.
- Campbell, 267.
- Candolle, de, 77, 78, 91, 93, 103, 106, 107, 109, 161, 206, 208, 213, 220, 250, 254, 263; on influence of cold on seeds, 234; — low temperature, 237; on temperature for germination, 82; on etiolation, 88.
- Canna*, leaves of, 13; *C. indica*, intercalary growing zones in, 9.
- Capillarity, influence of, on freezing-point, 241.
- Carbolic acid, concentration of, for disinfection, 264.
- Carbon dioxide, influence of absence of, on flower formation, 100; maximal percentages of, 259; percentage of, on lofty mountains, 211.
- monoxide, action of, 261.
- Cardinal points for growth, 69; influence of external conditions on, 70, 79.
- Carlsbad, organisms in hot springs of, 77.
- Carrière, on petiole grafts, 176.
- Caryota urens*, elasticity of fibres of, 55.
- Caspary, 239; on growth of *Victoria regia*, 17.
- Castanea vesca*, periodicity in, 206.
- Catalpa*, leaf-fall in, 217.
- Catasetum tridentatum*, conversion of root-apex of, into shoot, 140.
- Caulerpa*, apical growth of, 5; cellulose bars in, 53; diameter of, 39; growth of cell-wall of, 30; influence of light on development of, 94; localized growth in, 33.
- Celakovsky, 121, 123, 261.
- Cell-division, 38; causes of, 180; in absence of nucleus, 43; influence of external conditions on, 43; leaves of, 42; order of, 46.
- Cells, causes of shapes of, 45; cylindrical elongation of, by osmotic pressure, 59; differentiation of, 138; number of, in a tree, 39.
- Cellulose, origin of, 32.
- Cell-wall, elasticity and cohesion of, 54; growth of, 27 *seq.*; influence of thickness of, on growth, 33; strains in, 65, 66.
- Centradenia*, anisophylly of, 154.
- Centrifugal force, influence of, on formation of stomata, 160; — on growth, 108.
- Centrosomes, 43.
- Cerastium latifolium*, resistance of, to cold, 234.
- Ceralodon purpureum*, resistance of, to heat, 229.
- Ceratophyllum*, elongation of, in darkness, 93.
- Cereals, early ripening of, 210, 211.
- Certés, 126.
- Ceterach*, resistance of, to desiccation, 254.
- Chamaecyparis*, on dorsiventrality of, 151.
- Chantransia*, 91.
- Chara*, cell and nuclear division in, 40; influence of centrifugal force on, 108; — plasmolysis on, 257; — strains on strength of, 127; mitosis and amitosis in, 148; transmission of stimuli in, 186; unequal growth of segment-cells of, 7.
- Charpentier, 234.
- Chatin, 260.
- Chemical constitution, influence of, on poisonous action, 271.
- stimuli, influence of, on growth, 181; — on growth and germination, 112, 113; — on shape, 115; — — and reproduction, 116-8.
- Chemomorphosis, 2, 72, 137.
- Cherry, growth of, as evergreen, 213.
- Chlamidomonas*, influence of desiccation on, 210; verticibasality of, 155.
- Chloroform, action of, 267, 268.
- Chlorogonium*, influence of desiccation on, 210.
- Chloroplasts, action of light on, 248, 249.
- Chodat, 106; on resistance of fungi to cold, 238.
- Cholera bacilli, influence of salt solution on, 258.
- Christson, 13.
- Chudiakow, 262; on accommodation of anaerobes to oxygen, 114.
- Church, 145; theory of phyllotaxis, 47, 144.
- Cienkowski, 121.
- Cieslar, 93, 211.
- Circaea*, influence of light on, 89.
- Cisielski, 7, 168; influence of magnetism on growth, 107.
- Citrus*, endocarpal hairs of, 45; growth of cell-walls of, 30.
- Cladonia*, influence of desiccation on, 251; *C. rangiferina*, resistance of, to heat, 226.
- Cladophora*, continued nuclear division in, 40; influence of cold on, 238; localized growth in, 33.
- Cladosporium herbarum*, heat-rigor in, 225.
- Clark, 259, 260, 261, 273; on action of poisons, 272.
- Clarkia pulchella*, dorsiventrality of, 153.
- Clausius, 26, 244.
- Clautriau, 230.
- Claviceps microcephala*, action of coloured light on, 102.
- Climate, influence of, on periodicity, 212-4.
- Climbing plants, influence of gravity on, 110.
- Clover, contraction of radicle of, 14.
- Coagulation, influence of salts on, 230.
- Cobaea scandens*, influence of injury on peduncle of, 135.
- Cochlearia armoracia*, reproduction of, 168.

- Cocos nucifera*, elasticity of fibres in, 55.
 Coenobia, formation of, 177.
Coffea arabica, influence of desiccation on seeds of, 254.
 Cohesion, 50 *seq.*; of cell-wall, 54; relation of, to micellar structure, 57; of tissues, 57 *seq.*; and elasticity, relationship between, 56.
 Cohn, 16, 22, 56, 84, 122, 130, 134, 168, 208, 226, 229, 252; on cardinal temperatures for growth, 76; on resistance of spores, 230; — to heat, 227; on thermophile organisms, 77.
 — and Mendelssohn, 106.
 Cohnheim, 230.
Colchicum autumnale, resting period of, 207.
 Cold-rigor, 69, 232.
Coleochaete, influence of light on growth of, 94.
Coleus, leaf-fall in, 218; *C. Blumei*, curvatures in split stem of, 61, Fig. 14.
 Colin, on maximum and minimum temperatures for growth, 82.
 Collenchyma, limit of elasticity of, 56; plastic stretching of, 35; use of, 52.
 Colta, 21.
 Compensations, 163.
 Concentration, effects of changes of, 120, 121, 256, 257.
Conferva, influence of chemical stimuli on, 118.
 Congo-red, influence of, on growth, 33.
 Conidia, influence of light on formation of, 90.
 Conjugatae, origin of mucilaginous sheaths of, 32.
 Contact-stimulus, influence of, on growth, 129.
Convolvula, green cells of, 171.
 Copeland, 101.
 — and Kahlenberg, 260.
 Copper, poisonous action of, 260.
Coprinus, resting period of sclerotia of, 208; *C. ephemerus*, influence of light on formation of sporophores of, 90; — starvation on production of sporophore of, 116; *C. nyctemerus*, *C. plicatilis*, influence of light on formation of sporophores of, 90; *C. stercorarius*, conditions for formation of sporophore of, 79; growth of, 17; influence of food on reproduction of, 198; — of light on formation of sporophores of, 90; — development of sporophore of, 97; regeneration of pileus of, 169.
Cordyline, effects of inversion of, 109; verticibasality of, 160.
 Cork, elasticity of, 55; formation of, from callus, 133; influence of, on leaf-fall, 217, 218; internal formation of, 134.
 Comevin, 260.
Cornus Mas, early flowering of, 205.
 Correlation, 161, 164; influence of, on etiolation, 89.
 Correns, 29, 92, 145, 154, 167, 189, 190, 262; on intussusception, 30.
Corsinia marhantioides, resistance of, to desiccation, 255.
Corylus, early flowering of, 205.
 Coupin, 257, 260.
 Cramer, 29, 230; on intussusception, 30.
 Cress, vitality of, in absolute alcohol, 251.
Crocus, early flowering of, 79; influence of desiccation on, 210.
 Crops, causes of laying of, 88.
 Cucumbers, influence of warming on germination of, 81; rate of growth of, 18.
Cucumis sativus, minimum temperature for, 232; temperature limits for growth of, 76.
Cucurbita, development of flowers in darkness, 91; rapidity of growth of, 15; *C. Pepo*, influence of cold on, 233; subminimal temperature for, 232; temperature limits for growth of, 76; *C. pyriformis*, correlation of growth of, 163, Fig. 29.
 Culture, influence of, on resistance to cold, 236.
 — media, influence of, on shape, 117.
 Curie, 106.
 Curtel, 91, 100.
Cuscuta, influence of contact on, 129; resting period of seeds of, 208.
 Cuticle, detachment of, 31, 35; elasticity of, 55; influence of, on absorption of poisons, 261, 265; power of growth of, 32; strains in, 65, 66.
 Cuttings, retention of primitive characters by, 152.
 Cyanogen, poisonous action of ions of, 272.
Cynara scolymus, ice-formation in, 240, Fig. 31.
 Cynareae, elasticity of staminal filaments of, 55, 57.
Cynips galls, 172; *C. calicio*, galls of, 173.
Cystococcus humicola, resistance of, to desiccation, 255.
Cytisus Adami, 175.
 Cytoplasm, influence of, on cell-segmentation, 40.
 Czapek, 69, 73, 93, 134, 151-4, 159; on dorsiventrality, 150.

Dahlia variabilis, periodicity of growth in, 201, 202, Fig. 30.
 Dahmen, 217.
 Dalmer, 239.
 Dammer, 254.
 Dandelion, curvature of split peduncle of, 66.
 Daniel, 173, 175, 176.
 Darwin, 13, 66, 130, 158, 192, 200; on growth of cucumber, 18; on heredity, 187, 188.

- Darwin, Fr., 96; influence of light on growth of roots, 96.
 — and Bateson, 20.
 Dasonville, 118, 123.
 Davenport, 77.
 Davy, 112.
 Death, causes of, 219, 224-43; production of, by cold, 244; signs of, 224, 235.
 Debski, 148.
 Deherain and Demoussy, 260.
 Delage, 40, 167, 186, 188, 191, 194.
 Demoor, 41; on nuclear division, 40.
Dendrocalamus, rapidity of growth in, 15.
 Denksch, 95.
Derbesia, 57; bursting of cells of, in fresh water, 119.
 Desiccation, 249; causes of fatal action of, 253; influence of, on action of poisons, 261, 262; — on resistance to cold, 234; — — to heat, 70, 229; — on resting periods, 210; relation of, to death by cold, 245.
 Desiccator, vitality of spores in, 251.
 Desmids, nuclear fragmentation in, 41.
 Determinants, 187.
 Detlefsen, 54, 63, 109.
 Detmer, 84, 113, 208, 235.
 Devaux, 122, 260.
 Dewar and M^cKendrick, 238.
 Diaphragms, importance of, 53.
 Diatoms, influence of cold on, 238.
Dicranum scoparium, resistance of, to heat, 229.
Dictamnus fraxinella, influence of desiccation on seeds of, 254.
Dictiophora phalloidea, rate of growth of, 17.
 Diels, 123.
 Dienert, 193.
 Dieudonné, 247, 249, 262; on accommodation to cold, 80.
 Differentiation, mechanical aids to, in tissues, 44.
 Dingler, 15.
Dionaea, transmission of stimuli in, 186.
Dioscorea Batatas, influence of darkness on, 87.
 Disinfecting power, 274.
 Disks, attaching, influence of contact on formation of, 129.
 Dissociation, influence of, on poisonous action, 272-4.
 Division at right angles, law of, 42.
 Dixon, 134.
 — and Joly, 242.
 Dormancy, 219.
 Dorsiventrality, induction of, 149.
Dracaena, strains in branches of, 63.
 Driesch, 3, 40, 148, 166, 170, 188.
Drosera, transmission of stimuli in, 185.
 Drought, periodicity due to, 208.
 Drude, 18, 203, 204, 206, 212, 232.
 Dry-rigor, 69.
 Dubourg, 193.
 Duchartre, 201, 205; on periodicity of growth, 201.
 Dufour, 88; on sub-cooling, 244.
 Duggar, 112, 253.
 Duhamel, 21, 66, 67, 109, 207, 232, 235, 236; on strains and curvatures, 64.
 Dutrochet, 60, 250; on origin of internal stresses, 64; on stimuli, 75.
Duvallia, induction of dorsiventrality in, 150.
 Eberdt, 122.
 Eberhardt, 123.
 Ebermayer, 16.
 Eckstein, 172.
 Edelweiss, causes of shape of, 100, 101.
 Edwards, on temperature for growth, 82.
 — and Colin, 82, 231, 237.
 Ehrenberg, 77.
 Eichholz, 57.
Eichhornia, influence of desiccation on seeds of, 210.
 Eidam, 5.
 Elasticity, of cell-wall, 54; in plants, 50 *seq.*; relation of, to micellar structure, 57; of tissues, 57 *seq.*
 Elastic limit in wood and collenchyma, 56.
 Electrical radiations, influence of, on plants, 105.
 Electric currents, influence of, on transmission of stimuli, 182.
 Electricity, influence of, on growth, 106.
 Electrons, 25.
 Elfvig, 90, 102, 103, 111, 113, 128, 194, 247; on influence of electricity on growth, 106, 107; — inversion on growth, 110.
 Elm, sympodia of, 149.
Elodea, elongation of, in darkness, 93; position of leaf-primordia of, 143.
 Embryonic cells, 146, 148; growth in size of, 5; influence of cessation of growth on, 223; plasmolysis of, 32.
 — plasma, 4.
 — tissues, distribution of, 4.
 — and somatic cells, distinction between, 6.
Endocarpon, influence of light on shape of, 154.
 Endodermis, elasticity of, 55.
 Energy of growth, 16.
 Engelmann, 230.
 Ensch, 117.
 Enzymes, destruction of, by cold, 239.
Epidendrum floribundum, minimum temperature for, 233.
 Epidermis, regeneration of, 169; strains in, 65; tensions in, 61.
 Epigenesis, 188.
Epilobium angustifolium, dorsiventrality of, 153.
 Epinasty, definition of, 73.
Episcia bicolor, influence of cold on, 233.
 Epitrophy, induction of, 110.

- Equisetum*, cell-divisions in germinating spores of, 42; influence of light on germination of spores of, 92; polarity of, 157, Fig. 28; strains in spores of, 66.
- Eranthis hiemalis*, changes in seed of, 208.
- Eriksson, 208, 210.
- Ernst, 205.
- Errera, 11, 12, 41, 69, 107, 120, 132, 194; on accommodation to concentrated solutions, 119; on growth of *Phycomyces nitens*, 11; on haptomorphism, 132.
- Eschenhagen, 119, 257.
- Escombe, on influence of low temperatures, 237.
- Ether, action of, 267, 268; influence of, on cell-division, 43.
- Etherization, influence of, on resting periods, 209.
- Etiolation, 86; apparatus for, 89, Fig. 20; causes of, 99, 100; influence of correlation on, 99; history of knowledge of, 88; influence of starvation and correlation on, 89.
- Etiology, insufficiency of, 54.
- Euler, 106.
- Euphorbia*, form of starch-grains in, 36; growth of laticiferous tubes of, 45; resting period of seeds of, 208; suppression of cell-segmentation in, 38; *E. cyparissias*, galls of, 171.
- Eurotium herbariorum*, yeast variety of, 194; *E. repens*, temperature limits for growth of, 76.
- Ewart, 21, 68, 78, 83, 100, 119, 257; on action of alkaloids, 260; — electricity and magnetism, 106, 107; — poisons, 261; on breaking strains, 51; on influence of contact on growth, 129, 130; — strains on growth, 54, 127, 128; on injurious action of light, 94-6, 101, 248; on length of growing zone, 8; on minimal temperatures, 233; on propagation of stimuli, 183-6; on regeneration, 169; on resistance to cold of tropical plants, 33; — — of diatoms, 238; — to desiccation, 250-5; — to heat, 225-31.
- Extracellular protoplasm, 32.
- Faba*, influence of defoliation on stipules of, 162; *F. vulgaris*, osmotic pressure in imbedded root of, 124; pressure exerted by, 125.
- Fagus sylvatica*, influence of light on leaf of, 87, Fig. 19; non-reproduction of, by cuttings, 168; periodicity in, 205.
- Faist, 206.
- Falkenberg, 208.
- Famintzin, 87, 98, 123.
- Farmer and Williams, 157.
- Fasciation, 165.
- Ferns, planes of division in ova of, 157.
- Ficaria ranunculoides*, resting period of, 79.
- Ficker, 255, 260; on influence of desiccation on bacteria, 251.
- Figdor, 154.
- Fisch, 199.
- Fischer, 126, 206, 224, 247, 257; on bursting of bacteria in concentrated solutions, 119; on plasmoptyse, 256.
- Fitting, 30.
- Fleischer, 250.
- Flexibility, importance of, in plants, 51.
- Flower, influence of removal of, on growth of peduncle, 135.
- Flower-buds, formation of, under water, 123.
- Flowering, early, causes of, 211; influence of temperature on, 81.
- plants, accommodation of, to extremes of temperature, 80; ultra-maximal temperature for, 225.
- Flowers, abscission of, 216, 217; causes inducing formation of, 164; influence of light on development of, 91, 92; — moisture on formation of, 121; — nutrition on formation of, 116; — ultra-violet rays on formation of, 103.
- Flügge, 15, 81, 84, 94, 107, 112, 117, 194, 226, 227, 229, 238, 247, 248, 249, 252, 255, 260, 261, 262, 264, 274.
- Fontinalis antipyretica*, influence of desiccation on, 250.
- Forests, annual growth of, 16.
- Formative induction, 141.
- reactions, 71.
- Formic aldehyde, mode of action of, 268.
- Forsythia viridissima*, early flowering of, 205.
- Fränkel, 259.
- Frank, 7, 67, 111, 115, 118, 120, 121, 122, 133, 134, 151, 152, 154, 160, 167, 168, 170, 171, 172, 173, 222, 224, 231, 232, 237, 239, 247, 252, 259, 260, 263, 264.
- Fraxinus*, leaf-fall in, 217.
- Freezing, effect of, on plants, 232-6; mode of, 240; protection against, 237; resistance to, 238.
- Freezing-point of plants, 242, 243.
- Freudenreich, 259.
- Freytag, de, 258.
- Friedrich, 66, 125; on periodicity, 201, 204.
- Fries, 238.
- Frisch, 238; influence of cold on motile bacteria, 234.
- Frost, 21, 22; modes of avoiding, 237; influence of, on leaf-fall, 217.
- Fruits, diurnal changes of volume of, 66; seedless, influence of pollen-tube on development of, 173.
- Fruit-trees, influence of cold on, 233.
- Fuchs, 175.
- Fucus*, polarity of ova of, 157.
- Fünfstück, 15.
- Fumaria officinalis*, influence of cold on,

- 236; *F. hygrometrica*, influence of desiccation on, 250, 251; ultra-maximal temperature for, 231.
- Fungal hyphae, penetration of, 45.
- Fungi, growth-coefficient of, 16; influence of chemical stimuli on, 116; — cold on, 238; — light on, 90; — submersion on formation of spores by, 123; literature on influence of temperature on, 84; regeneration in, 169; reproduction of, 167; resistance of, to desiccation, 255.
- Funkia*, polarity of vegetative embryos of, 158.
- Gärtner, on grafting, 176.
- Galls, 171; causes of formation of, 172.
- Gardiner, 178.
- Gastric juice, influence of, on germination, 113.
- Gelatine, freezing-point of, 243.
- Geleznov, 67, 206.
- Gemmules, 187.
- Géneau de Lamarlière, 88, 165.
- Gentiana campestris*, early flowering of, 211.
- Geonasty, definition of, 73.
- Geotropism, definition of, 73.
- Gerasimoff, 41, 145.
- Gerland, 103.
- Germinal tracts, 149.
- Germination, influence of light on, 92, 93; — magnetic forces on, 107; — stimuli on, 146, 147; — temperature on, 81; of spores, influence of acids, alkalis, and food on, 113; of seeds and pollen-grains, 114.
- Germ-plasma, 146, 223.
- Germ-tubes, influence of desiccation on, 253.
- Gesneria tubiflora*, periodicity in, 203.
- Gum montanum*, resistance of, to cold, 234.
- Geyler, 5.
- Giesel, 106.
- Giesenhagen, 29.
- Giltay, 16.
- Glaeocapsa*, mode of growth of, 30.
- Glechoma hederacea*, influence of light on, 89.
- Glucose, influence of, on nitrifying bacteria, 122.
- Glyceria fluitans*, causes of elongation of, 128.
- Godlewski, 81, 82, 86, 87, 96, 100, 101, 120; on correlation of growth, 89; on etiolation, 99; on periodicity in seedlings, 203.
- Goebel, 3, 4, 9, 10, 47, 71, 73, 78, 87, 89, 90, 91, 92, 113, 120, 121, 122, 123, 128, 130, 140, 141, 142, 143, 144, 149, 150, 152, 153, 154, 155, 158, 161, 162, 163, 164, 166, 167, 171, 177, 187, 207.
- Göppert, 67, 206, 232, 233, 236, 237, 238, 239, 241, 244, 264; on influence of thawing and freezing, 235.
- Golden, 21, 22; on periodicity, 204.
- Goldfussia*, anisophylly of, 154; *G. anisophylla*, leaf-fall in, 218.
- Gottschery, 118.
- Grantz, 11, 79, 80, 90, 97, 101, 102, 103, 104, 121, 123, 169.
- Graft-hybrids, 174 6.
- Grafting, 173.
- Gramineae, origin of hollow stems of, 34.
- Grape, freezing-point of, 242.
- Grasses, importance of solid nodes in, 53.
- Grass-haulms, influence of gravity on, 110, 111; strength of, 50.
- Gravity, influence of, on dorsiventrality, 153; 154; — on formation of roots, 158; — on growth, 108; — on planes of segmentation, 157; stimulating action of, 73.
- Green rays, action of, 248.
- Grimaldia*, induction of dorsiventrality in, 150.
- Grimmia conferta*, resistance of, to heat, 229.
- Grisebach, 21, 205, 206, 212, 214; on periodicity, 213.
- Growing zones, length of, 8, 9; intercalary, 9, 10, 12.
- Growth, action of poisons on, 264; apparatus to show influence of temperature on, 83, Fig. 17; by plastic stretching, 31; of cell-wall, 31 *seq.*; correlation of, 163; daily periodicity in, 201; formal conditions for, 68; general account of, 1; grand period of, 6, 11, Fig. 4; influence of chemical agencies on, 111; — chemical stimuli on, 71; — external conditions on, 68; — light on, 84; — mechanical agencies upon, 124; — tension on, 127; — oxygen on, 114; — air-pressure on, 115; — temperature on, 75 *seq.*, 81; — temperature on curve of, 82; — water-pressure on, 126; — water percentage and of turgidity on, 118; in thickness, 13; — periodicity in, 204; measurement of, 7-9, Figs. 1-3, 19; — methods of, 20, Figs. 6, 7; — by automatic registration, 21, 22, Figs. 8, 9; mechanics of, 24 *seq.*; minimal and maximal temperatures for, 76, 77; periodicity of, 197; under constant external conditions, 3; rapidity of, 15; region of most active, 5; relation of, to tension in cell-wall, 30; of starch-grains, 35; variations in rapidity of, 18, 19.
- Growth-coefficients, 16.
- Growth-contraction, 13.
- Growth-curve, 8, Fig. 2.
- Gruber, 227.
- Grüss, 237.
- Guthrie, 243.

- Haberlandt, 5, 9, 13, 47, 54, 55, 56, 57, 78, 80, 84, 88, 101, 109, 168, 208, 215, 236; on annual rings, 216; on cardinal temperatures for growth, 76; on influence of position of nucleus, 33; on mechanical tissues, 54.
- Häcker, 43.
- Hämmerle, 207.
- Haen, de, 106.
- Hakea brachyrhyncha*, arrangement of sclerenchyma in, 53.
- Hales, 7, 21, 66, 88; method of measuring growth, 20.
- Hansen, 36, 80, 81, 116, 117, 131, 167, 168, 196, 223; on cardinal temperatures for growth, 76; on suppression of spore-formation, 193; on resting period of sclerotia, 208.
- Haptera, 129.
- Haptomorphism, 132.
- Haptotropism, 132.
- Hardy, 233.
- Harnier, 213.
- Hartig, 7, 9, 13, 16, 67, 90, 93, 113, 166, 215, 223, 224; on causes of annual rings, 216.
- Harting, 6, 34.
- Hartung, 213.
- Harvest, amount of, per acre, 16.
- Heald, 92, 99, 102, 167, 260, 273; on germination of fern-spores in darkness, 80.
- Heat, moist, resistance of plants to, 228; dry, 229; influence of poisons on production of, 264.
- Heat-rigor, 69, 225.
- Heckel, 113.
- Hedera helix*, dorsiventrality of, 154; influence of light on root-formation of, 93; inversion of, 159.
- Heer, 204, 206.
- Hegler, 148; on influence of tension on growth, 127.
- Heider, 262.
- Heim, 91, 169.
- Heinrich, 231.
- Heinricher, 93, 114, 157, 167, 255.
- Helianthus*, grafting of, 175; influence of tension on strength of, 127; on force of expansion in pith of, 64; strains in stem of, 61; *H. annuus*, rate of growth of, 16; *H. tuberosus*, longitudinal strains in, 62; periodicity in, 203.
- Heliotropism, definition of, 73.
- Helleborus foetidus*, resistance of, to cold, 232; *H. niger*, early flowering of, 79; influence of frequent thawing on, 235; — tension on breaking strain of, 127; — — on mechanical tissues of, 54; *H. viridis*, sclerenchyma in, 128.
- Hemerocallis fulva*, dorsiventrality of, 153.
- Henneberg, 117; on cardinal temperatures for growth, 76.
- Henry, 162.
- Hepaticae, embryonic character of, 167; growth of spore membranes of, 30; induction of dorsiventrality in, 150; regeneration of, 169.
- Heracleum giganteum*, rate of growth of, 16.
- Herbst, 74, 132, 163.
- Heredity, 189; definition of, 191.
- Hering, 161, 163; on correlation, 162.
- Hermann, 107, 220.
- Hertwig, 40, 41, 42, 43, 72, 81, 86, 116, 127, 148, 155, 158, 166, 167, 178, 194.
- Heteranthera*, influence of desiccation on seeds of, 210.
- Heterauxesis, 74.
- Heterocentron diversifolium*, influence of gravity on, 109.
- Heteromorphosis, 72, 167.
- Heyer, 199.
- Hieracium*, influence of light on, 89.
- Hilbrig, 79; on maximal temperatures, 225.
- Hildebrand, 67, 153, 162, 197, 254.
- Hirsch, 10.
- Höhnel, 229.
- Hörmann, 184.
- Hoffmann, 40, 92, 238, 252, 253.
- Hofmeister, 3, 4, 7, 9, 10, 12, 18, 32, 46, 58, 63, 65, 67, 164, 168, 177, 192, 219, 224; on growth of *Spirogyra*, 19; on influence of gravity, 109; — pressure in bud, 144; on mechanics of tissues, 59; on planes of division, 42; on tissue-strains, 64.
- Hohnel, 217.
- Holl, 73.
- Holtermann, 90, 94.
- Hoppe-Seyler, 77; on surface temperature in streamlets, 78.
- Hop-stems, influence of darkness on, 87.
- Hordcum*, 19.
- Horizontal microscope, 20, Fig. 6.
- Horvath, 131.
- Hot stages, 83.
- Huber, 208.
- Hülscher, 13.
- Huie, on karyokinesis in *Drosera*, 43.
- Humboldt, von, 107, 213.
- Humulus*, elongation of internode of, 5; growth-coefficient of, 16; rapidity of growth of, 15.
- Hunter, 239.
- Huth, 263.
- Hyacinthus*, influence of desiccation on, 210; strains in epidermis of, 65.
- Hybrid, definition of, 175.
- Hybrids, reversion of, 189.
- Hydra viridis*, green cells of, 171.
- Hydrocharis*, influence of soil on growth of roots of, 122.
- Hydrodictyon*, condition for zoospore formation in, 118; grouping of zoospores of, 177.
- Hydrogen, action of, 261.

- Hydrogen ions, poisonous action of, 272.
 Hydrostatic pressure, influence of stretching of cell on, 59.
 Hydroxyl, poisonous action of, 272.
Hydrurus, cause of resting period of, 212 ;
H. foetidus, temperature limits for growth of, 76 ; maximum temperature for growth of, 78.
 Hymenium, influence of light on development of, 94.
 Hymenomyces, influence of light on, 90.
 Hypocotyl, shortening of, 14.
 Hypocotyls, influence of darkness on, 86.
 Hyponasty, definition of, 73.
 Hypotrophy, induction of, 110.
- Ice, formation of, in plants, 239.
 Ice-formation, influence of, 244-6.
 Idioplasm, 146.
 Imbibition, importance of, in growth, 25, 26 ; influence of, on freezing-point, 243, 244 ; — pressure on, 26.
 Immortality, 223, 224.
Impatiens, cell-divisions in, 42 ; on stretching of cell-walls in fruit of, 57 ; *I. Balsamina*, minimal temperature for, 232 ; *I. Sultani*, leaf-fall in, 218.
 Induction, labile, instances of, 140.
 Ingenhousz, 107.
 Injuries, influence of, on periodicity, 209.
 Intercalary growing zones, 9, 10, 12, Fig. 5 ; protection of, 12.
 Internodes, origin of unequal length of, 7.
 Intussusception, 25, 29, 30 ; energy of growth by, 27 ; in starch-grains, 35, 36.
 Inulin, influence of, on zoospore formation, 118.
 Ions, poisonous action of, 272-4 ; transmission of stimuli by, 182.
Iris florentina, resistance of, to heat, 231.
 Irmisch, 140.
 Iron, dissociation and poisonous action of, 273.
 Irritability, changes of, during development, 137.
 Ischia, bacteria in hot springs of, 77.
Isoetes hystrix, resistance of, to desiccation, 254.
 Isotropic, definition of, 73.
 Ivy, dorsiventrality of radial cuttings of, 152.
 Iwanowski, 174.
- Jaccard, 114 ; on influence of oxygen pressure on growth, 115.
 Jacobi, 264.
 Jäger, 260.
 Jahn, 123, 206.
 Janczewski, 87.
 Janse, 10, 156.
 Java, periodicity of plants in, 212, 214 ; rapidity of growth in, 16.
- Jensen, 113.
 Jentys, 114.
- Jönsson, 93, 215, 253.
 Jörgensen, 80, 84, 116, 117, 226.
 Johannsen, on shortening of resting period, 209.
 Johnson, 64.
 Johow, 67.
 Jost, 13, 14, 83, 86, 93, 99, 100, 144, 166, 209, 210, 215, 216 ; on etiolation, 89.
 Junger, 122.
 Jungbuhn, 213.
 Jungner, 128.
 Just, 84, 226, 227, 229, 252 ; on resistance of submerged seeds to heat, 228.
- Kahlenberg and True, 260 ; on dissociation and poisonous action, 272-4.
 Kaiser, 66.
 Kammerling, 88.
 Karsten, 119, 122, 140, 236, 257.
 Karyokinesis, 148 ; induction of, by stimulation, 43.
 Kayser, 226, 229.
 Kedzier, 84.
 Keller, 122.
 Kerner, 58, 81, 100, 128, 197, 206, 212, 230.
 — and Oliver, 230, 231.
 Kienitz, 211 ; on resting periods of seeds, 208.
 Kihlmann, 237.
 Kinzel, 81, 208, 252.
 Kirchner, 79, 84, 201 ; on cardinal temperatures for growth, 76.
 Kitao, 67.
 Kjellmann, 77.
 Klebahn, 41, 191, 198.
 Klebs, 10, 29, 32, 33, 34, 39, 43, 80, 82, 84, 90, 91, 98, 100, 102, 103, 104, 113, 116, 118, 119, 121, 123, 147, 164, 167, 177, 197, 208, 210, 257, 262 ; on apposition, 30 ; on cardinal temperatures for growth, 76 ; on culture of *Saprolegnia*, 199 ; on influence of oxygen on reproduction of fungi, 117 ; on life-cycles of algae, 198 ; on resting period of spores, 208.
 Klein, 90, 97 ; on influence of coloured light on spore-formation, 102.
 Klemm, 53, 90, 94, 151, 156, 168, 239, 246, 248, 267, 268.
 Klöcker and Schönning, 193.
 Knight, 88, 161, 162, 164, 210 ; on grafting, 176 ; on influence of strains on growth in thickness, 128.
 Knop's nutrient solution, influence of, on zoospore formation, 118.
 Kny, 31, 94, 96, 109, 134, 135, 145, 150, 153, 157, 158, 169, 178, 215 ; on planes of cell-division, 42 ; reversal experiments of, 159.
 Kobert, 258, 262, 263.
 Koch, 15, 168, 220, 226, 250, 256.
 Köppen, 81, 212 ; on growth at varying temperatures, 76, 77.

- Kohl, 33, 46, 88, 122, 178.
 Kohlrabi, freezing of, 243.
 Kolkwitz, 31, 64, 98.
 Koorders, on rapidity of growth, 16.
 Kossiakoff, 262.
 Krabbe, 15, 25, 29, 46, 49, 66, 67, 90, 125 ;
 on pressures on autumn wood, 216 ;
 on relation of stretching to turgor, 60 ;
 on shortening of isolated bark, 62 ;
 on tensions in bark, 63.
 Krasan, 205, 207.
 Kraus, 15, 18, 20, 29, 58, 63, 64, 67, 83, 86,
 95, 164, 200, 213 ; on action of coloured
 light, 102 ; — green rays, 103 ; on
 auto-assimilation, 99 ; on diurnal
 changes of volume, 66 ; on periodicity
 of growth, 201 ; on relation between
 growth and tissue-strains, 65 ; on
 strains in tissues, 62.
 Krönig, 252.
 — and Paul, 260, 261 ; on dissociation and
 poisonous action, 272, 273.
 Kronfeld, 162.
 Kuckuck, 209.
 Kühne, 231, 238, 241, 259.
 Küstenmacher, 172.
 Küster, 57, 63, 128, 133, 172, 206.
 Kuhla, 178.
 Kunisch, 233, 235.
 Kunkel, 258, 261, 262, 267, 268, 270, 271.
 Kurth, 256.
 Labbé, 233.
 Labiatae, ice-formation in, 240.
 Lafar, 81, 84, 247, 258.
Lagenidium, 41.
 Lagerheim, 78.
 Lamarck, on intussusception, 25.
 Lamellation in starch-grains, origin of, 36.
Lamium amplexicaule, resistance of, to
 cold, 232 ; *L. purpureum*, influence of
 frequent thawing on, 235.
 Landolt and Börnstein, 56.
 Lange, 32.
 Langendorff, 22, 23.
Larix europaea, rapidity of growth of, 16 ;
L. sibirica, resistance of, to cold, 232.
 Larva, influence of, on gall-formation, 172,
 173.
 Latent period, 204.
Lathraea, conditions for germination of, 114.
 Laticiferous tubes, mode of growth of, 45,
 46.
 Lauder Lindsay, 77.
 Laurent, 60, 247.
 Laxa, 84.
 Lazniewski, 123.
 Leaf-fall, 216 ; modes of, 217.
 Leaf, regeneration of, 169.
 Leaves, influence of light on, 86, 87, Fig.
 19 ; floating, elongation of petioles of,
 122.
 Le Bon, 106.
 Le Conte, 240.
 Lefebvre, on temperature for germination,
 82.
 Lehmann, 26, 36, 56, 240, 244.
 Leitzgeb, 29, 91, 109, 150, 151, 158, 228 ; on
 dorsiventrality, 150 ; on growth of
 spore-membranes, 30 ; on influence of
 gravity on segmentation, 157.
Lemna, influence of soil on growth of roots
 of, 122.
 Lendner, 102, 103 ; on influence of light
 and food on sporangium formation, 90.
 Leod, 106.
Lepidium sativum, influence of light on
 growth of, 97.
Lepismium radicans, influence of light on
 root-formation of, 93.
 Lesage, 122.
 Lewin, 259.
 Lewith, 230, 231.
 Lichens, resistance of, 250 ; symbiosis of,
 171.
 Lidforss, 17, 114, 119, 262.
 Liesegang, 26.
 Life-cycle, influence of external condition
 on, 198.
 Light, action of rays of different wave-
 length, 101 ; — ultra-violet, 103 ; for-
 mative action of, 72 ; influence of, on
 cell-wall, 101 ; — on distribution, 85 ;
 — on dorsiventrality, 149-51, 154 ; —
 on flowers, 91, 92 ; — on formation of
 roots and rhizoids, 93, 94 ; — on ger-
 mination, 92 ; — on germination of
 fern-spores, 80 ; — on growth, 84, 97 ;
 — on leaf-fall, 218 ; — on periodicity,
 200-4 ; — on polarity, 156, 157 ; —
 on protoplasmic micellae, 101 ; — on
 reproduction, 90, 91, 198 ; injurious
 action of, 247 ; mode of action of, 98 ;
 optimal intensity of, 95 ; periodicity
 due to, 208 ; rapidity of response to,
 96 ; reaction to changes of, 94 ; stimu-
 lating action of, 74.
 Lignification, influence of, on elasticity, 55 ;
 — on growth, 32.
 Lignified fibres, elasticity of, 55.
 Liliaceae, influence of darkness on leaves
 of, 86.
 Lime, rate of growth of, 18 ; number of
 cells in, 39.
Linaria vulgaris, 47.
 Lindau, 46.
 Lindemuth, 174, 176.
 Lindsay, on strains and curvature, 64.
 Linseed, vitality of, in absolute alcohol, 251.
 Linsser, 211, 213.
Liriodendron Tulipifera, growth of, as
 evergreen, 212.
 Livingstone, 118, 121.
Lobelia Erinus, influence of cold on seeds
 of, 234 ; — ultra-violet rays on, 103.
 Loeb, 72, 132 ; on fertilization, 147.

- Loew, 262, 263, 268, 269, 271.
 — and Schulze, 260.
 Logarithmic spirals, 47.
 Lohmann, 94.
 Lopriore, 105, 113, 259; on regeneration, 169.
Loranthus europaeus, influence of light on germination of, 92.
 Lotze, 136.
 Ludwig, 206, 239, 263.
 Lunds, 215.
Lunularia, dorsiventrality of, 150.
Lupinus albus, influence of temperature on growth of, 77; periodicity in, 204; *L. luteus*, influence of centrifugal force on, 108.
 Lutz, on causes of annual rings, 216.
Lycium, influence of transitory cold on, 210.
Lycopodium, dorsiventrality of, 154.
Lycodium, dorsiventrality of, 153.
- Macaire, 129.
 MacDougal, 100, 171.
 Mackendrick, 56.
 Macmillan, 13, 21, 22; on periodicity, 204.
 Madeira, climate of, 205.
 Mäule, 133, 134.
 Magnetic properties of cell-constituents, 107.
 Magnetism, influence of, on growth, 107.
 Magnus, 170.
 Manassein, 229.
 Manganese, poisonous action of, 261.
 Mangin, 96, 254.
 Mann, 162.
Marchantia, fixed dorsiventrality of, 140; induction of dorsiventrality in, 149, 150, Fig. 24; influence of gravity on gemmae of, 109; — light on development of rhizoids of, 93, 94; — — on growth of rhizoids of, 96; *M. polymorpha*, ultra-maximal temperature for, 231.
 Marey, 22, 23.
 Marriotte, on influence of root-pressure on growth, 30.
Marsilea, germination of spores of, in darkness, 92; influence of gravity on division of ovum of, 157; — — on prothallus of, 109; parthenogenesis in, 147; *M. quadrifolia*, elongation of petioles of, 122.
 Massart, 119, 133, 166, 167, 186, 256, 257; on regeneration, 169.
 Matruchot, 117.
 — and Molliard, 121.
 Mattiolo, 164.
 Maxwell, 18.
 Mayer, 84, 120.
 Mazé, on anaerobic respiration of seedlings, 228.
 Mechanical stimuli, 132; influence of, on growth, 181.
 Mechanical tissues, 51; arrangement of, 52-4; influence of pressure on, 128.
 — vibrations, influence of, on growth, 130, 131.
 Mechanomorphosis, 132.
 Mechanotropism, 132.
Medicago, resistance of seeds of, 230.
 Meischke, 50.
 Meissner, 10, 153.
 Mellink, 28, 45.
Melobesia Lejolisii, 47, Fig. 11.
 Melsens, on influence of cold on enzymes, 239; — pressure on yeast, 126.
 Meltzer, 131.
 Mendel, 189.
 Mer, 99.
 Meristematic cells, characters of, 6; size of, 39.
 Meristems, general characters of, 146; physiological characters of, 139.
 Merkel and Bonnet, 148.
Merulius lacrymans, condition for germination of, 113.
 Metallic ions, poisonous and non-poisonous, 272.
 Methyl blue, poisonous concentration of, 265.
 Meyer, 2, 15, 36, 178, 231, 238; on growth and structure of starch-grains, 35.
 Michaelis, 84.
Micrococcus luteus, influence of cold on, 238.
 Miede, 33, 160, 182; on regeneration, 169.
 Migula, 39, 84, 94, 117, 191, 247; on asporogony, 193.
 Millardet, 62.
Mimosa, duration of tissue-strains in pulvinus of, 65; influence of correlation on etiolation of, 99; strains of pulvinus of, 62, 63; *M. pudica*, etiolation of, 89; injurious action of green rays on, 103; minimum temperature for, 233; transmission of stimuli in, 185, 186.
Mimulus luteus, development of, in weak light, 92.
 Mirbel, 150.
 Mitosis, 148; suppression of, 43.
 Miyake, 18.
 Miyoshi, 84.
Mnium hornum, influence of desiccation on, 250, 251.
 Modulus of elasticity in plants, 56.
 Möbius, 7, 81, 91, 93, 164, 199, 209.
 Möller, 6, 107; on growth of fungi, 17.
 Mohl, 53, 151, 206, 207, 236, 240; on leaf-fall, 217.
 Moisture, influence of, on formation of spore and zygotes, 123; — on length of internodes, 100.
Molinia caerulea, intercalary growing zones in, 9.
 Molisch, 114, 176, 217, 218, 238, 239, 240, 241, 242, 244, 245; on action of cold,

- 245; on death of plants above zero, 233; on influence of thawing, 235.
- Moll, 7.
- Molliard, 171.
- Monas Okenii*, rapid response of, to light, 96.
- Montemartini, 7, 12, 215.
- Morgen, on influence of light on growth, 97.
- Morkowinc, 264.
- Mortierella*, influence of moisture on formation of sporangia by, 123.
- Mosaic work in tissues, 149.
- Mosses, 92; resistance of, to desiccation, 255; — to light, 249.
- Mosso, 261.
- Mottier, 40, 108; on influence of centrifugal force on growth, 110.
- Moulds, influence of light on, 90.
- Mousson, on influence of capillarity on freezing, 244.
- Mucor*, apical growth of hypha of, 5; cell-segmentation in, 39; decrease in size of cells of, 38; heredity in, 195; influence of air on reproduction of, 198; intermediate character of, 6; non-formation of sporangia under water, 121; *M. flavidus*, influence of light on formation of sporangia in, 90; *M. mucedo*, action of CuSO_4 on, 260; growth of sporangial stalk of, 11; influence of cold on, 238; *M. racemosus*, influence of light on spore-formation in, 90; temperature limits for growth of, 76; *M. stolonifer*, formation of attaching organs of, 130; heat-rigor in, 225.
- Mucor-yeast, condition for formation of, 117.
- Müller (C.), 56; on growth of cell-walls, 30.
- (Fr.), 208, 210, 213.
- (H.), 233; on influence of light on growth of roots, 96.
- (H. C.), 30.
- (K.), 169.
- (N. J. C.), 7, 64, 66, 80, 84, 93, 158, 209, 211; on compression of pith, 64.
- (O.), 32, 178.
- Müller-Hetlingen, on influence of electricity on growth, 106.
- Müller-Thurgau, 67, 164, 173, 209, 210, 212, 233, 235, 236, 237, 239, 240, 242, 243, 245; on freezing of apples, 241; on freezing-point of plants, 242; on influence of cold, 245; on resting periods, 215.
- Münter, 9.
- Musa*, 18.
- Mustel, 206.
- Mycocecidia, 171.
- Myriophyllum*, influence of light on growth of, 93.
- Myxomycetes, influence of concentration on, 121; — freezing on, 241.
- Nägeli, 3, 5, 9, 30, 32, 33, 35, 39, 58, 64, 66, 86, 89, 131, 168, 182, 191, 229, 234, 244; on growth, 29; on idioplasma, 188; on mechanics of tissues, 59; on resistance of bacteria to heat, 228.
- and Schwendener, 63, 66, 244.
- Nathansohn, 9, 13, 32, 35, 46; on amitosis, 43; on parthenogenesis in *Marsilea*, 147.
- Nectria cinnabarina*, influence of food on conidial formation of, 116.
- Nelumbium*, 18; vitality of seeds of, 254.
- Nematus capreae*, galls of, 172.
- Némec, 43; on nerve fibrillae, 183.
- Nencki, on action of tox-albumins, 268.
- Neomeris Kelleri*, growth of cell-wall of, 30.
- Neottia Nidus-avis*, conversion of root-apex into shoot-apex, 140.
- Nepenthes*, influence of contact on formation of pitchers of, 130.
- Nerve fibrillae in plants, 183.
- Newcombe, 32, 34, 44, 125, 128, 223.
- Nicotiana*, influence of light on germination of seeds of, 92.
- Nicotra, 57.
- Nitella*, fate of segment-cells in, 9; influence of plasmolysis on, 257; strains in cell-wall of, 65; transmission of stimuli in, 186; unequal growth of segment-cells of, 7.
- Nitophyllum peltatum*, signs of death in, 235.
- Nitrifying organisms, influence of peptone, &c., on, 112.
- Nobbe, 84, 87, 93, 107, 114, 211, 229, 230, 252, 254.
- Nördlinger, 109, 161.
- Noll, 9, 25, 29, 33, 78, 94, 154, 167, 178, 238; on growth by apposition, 31; — of cell-walls of *Caulerpa*, 30; on influence of pressure on development of root-primordia, 132; on inversion, 156.
- Nordhausen, 10, 13, 134, 253.
- Novos*, resistance of, to desiccation, 255.
- Nuclear division, persistence of, in non-dividing cells, 39; relation of, to cell-division, 40.
- Nucleus, importance of, in heredity, 188; influence of, on growth of cell-wall, 33; — poisons on, 267; size of, 40.
- Nuphar luteum*, dorsiventrality of rhizome of, 154.
- Nutrient medium, influence of, on resistance to heat, 228, 229.
- Nutrition, influence of, on development of reproductive organs, 198.
- Nymphaea*, production of air-spaces in, 45.
- Oak, galls of, 173; leaf-fall in, 217; resting period of, 206.
- Oedogonium*, 19, 28; growth of, 31; influence of change of temperature on, 82;

- influence of external conditions on reproduction of, 198; intercalary growth in, 10; nuclear fragmentation in, 41; ultra-maximal temperature for, 231; *O. diplandrum*, influence of light on reproduction of, 91.
- Ohlert, 7.
- Oil, influence of, on resistance to cold, 247.
- Olin, 253.
- Oltmanns, 78, 83, 84, 85, 119, 209; on continuance of growth in electric light, 94.
- Ono, 111.
- Onoclea struthiopteris*, sporophyll formation in, 164.
- Oxygena equina*, condition for germination of, 113.
- Oppenheim, 270.
- Opuntia*, influence of darkness on, 87; *O. Ficus indica*, influence of gravity on, 109.
- Orchids, influence of boring larvae on formation of ovules in, 173.
- Organic acids, importance of, in leaf-fall, 218.
- Orobanche*, condition for germination of, 114; development of ovule from suspensor of, 142, 168.
- Orthogonal trajectories, 47, 48.
- Orthostichies, 47.
- Orthotrichum affine*, resistance of, to heat, 229.
- Ortmann, 190.
- Oscillaria*, embryonic character of, 4; growth of, at high temperatures, 77; resistance of, to desiccation, 250, 255; ultra-maximal temperature for, 231.
- Osmotic agencies, injurious action of, 256.
- concentration, influence of, on freezing-point, 241, 243.
- pressure, calculation of, from stretching of cell-wall, 59; influence of enforced cessation of growth on, 124; — on growth, 26, 27; — on growth contractions, 15; — on segmentation of ovum, 147.
- Ostwald, 26, 37, 243, 244, 272.
- Ott, 55.
- Otto, 123, 263.
- Overton, 260, 265, 266, 268; on progressive action, 271.
- Oxalis*, influence of desiccation on seeds of, 254; strains in curving pulvini of, 58; *O. elegans*, contraction of roots of, 14.
- Oxygen, influence of absorption of, on resistance to heat, 228; — on action of light, 248, 249; — on growth, 114.
- Oxygen-pressure, action of, 269.
- Palisa, 167.
- Palisade parenchyma, influence of light on formation of, 87, Fig. 19, 88.
- Palladin, on influence of transpiration on etiolation, 100.
- Pandanus*, growth of cell-walls of, 30.
- Pangens, 186, 187.
- Paraboloids of revolution, 48.
- Paranasty, definition of, 73.
- Paratonic, definition of, 75.
- Parietaria arborea*, resistance of, to desiccation, 250.
- Parnassia palustris*, early flowering of, 211.
- Parthenogenesis, 147.
- Pasteur, 229, 252; on influence of medium on resistance to heat, 228; on resistance of bacteria to heat, 227.
- and Joubert, 227.
- Pear, freezing-point of, 242.
- Pedersen, 81, 84; on cardinal temperatures for growth, 76.
- Pediastrum*, coenobium of, 177.
- Peirce, 171, 178.
- Pelargonium*, grafting of, 176.
- Pellia epiphylla*, elongation of sporogonial stalk in, 10.
- Pellionia Daveauana*, chloroplastids of, 36.
- Pelomyxa palustris*, action of hydrogen on, 261.
- Pelvetia canaliculata*, polarity of, 157.
- Penicillium*, influence of air on reproduction of, 198; — cold on, 238; — moisture on formation of spores by, 123; resistance of, to poisons, 260-2; *P. glaucum*, accommodation of, to poisons, 262, 263; action of CuSO_4 on, 261; — of ZnSO_4 , 262; heat-rigor in, 225; influence of food on cardinal points for, 80; non-absorption of CuSO_4 by, 266; non-germination of, on water, 113; temperature limits for growth of, 76.
- Peptone, influence of, on germination, 113; — on nitrifying bacteria, 112.
- Perennating organs, causes inducing formation of, 72.
- Perennation, 205.
- Periclinals, 48.
- Pericyclic sclerenchyma, value of, 54.
- Periodicity, heredity of, 195, 213, 214; influence of external conditions on, 209; — food on, 215; internal factors in, 214; of growth, 197; — daily, 200; — yearly, 204; origin of, 212.
- Perithecia, limits of temperature for formation of, 80.
- Peters, 133, 208.
- Petersen, 207.
- Pethybridge, 118.
- Petiole, influence of grafting on, 176.
- Pettersen, 119, 258.
- Petunia*, development of flower of, in darkness, 91.
- Peyritsch, 171.
- Pfeffer, 9, 12, 16, 19, 21-5, 28, 29, 31-4 (growth), 41-3 (cell-division), 50, 55-60 (elasticity and cohesion), 62-4 (tissue-strains), 73, 83, 92, 93, 101, 109, 110, 119

- (influence of external condition on growth), 140, 144, 150, 154, 159, 161, 165, 168 (induction and polarity), 182, 185, 214, 218 (periodicity), 223, 247, 249, 252, 257, 265-70 (resistance to extremes); on nature of irritability, 75; on pressures exerted by growing organs, 123-32.
- Pfizer, 10, 18, 30; on growth of fungi, 17.
- Pflüger, 105, 106, 107, 131.
- Phajus*, formation of indigo in, 235; *P. grandifolius*, freezing-point of, 242.
- Phaseolus*, development of flower of, in darkness, 91; duration of tissue-strains in pulvinus of, 65; elongation of internode of, 5; influence of correlation on etiolation of, 99; strains in pulvinus of, 62, 63; *P. multiflorus*, growth of shoot of, 60; influence of etiolation on, 89; temperature limits for growth of, 76; *P. nanus*, minimal temperature for, 232; *P. vulgaris*, freezing-point of, 242; influence of cold on, 233; resistance of, to heat, 231.
- Phellogen, influence of pressure on, 44.
- Phenols, removal of, 270.
- Philippi, 140.
- Phisalix, on asporogeny, 193.
- Phloem, grand period of growth of, 13.
- Phormium tenax*, shape of leaves of, 54.
- Photoepinasty, 73.
- Photomorphic actions, 85.
- Photomorphosis, 2, 72, 137.
- Photonasty, 137; definition of, 73.
- Phototonus, 69; definition of, 85.
- Phycomyces*, correlation of growth in, 164; influence of contact on, 129; — light on growth of, 96, Fig. 21; *P. nitens*, freezing of, 241; growth-coefficient of, 17; growth of sporangiophore of, 10, 11, Fig. 4; influence of injury on growth of, 135; — inversion on growth of, 110; non-germination of, on water, 113; resistance of, to desiccation, 251; vitality of spores of, 254.
- Phyllocactus*, influence of darkness on, 87; — light on apical growth of, 93.
- Phyllotaxis, causes of, 144, 145.
- Phytoecidia, 171.
- Pick, 151.
- Pictet, 237; on influence of low temperatures, 234; — of cold on bacteria, 238; — — on toxins, 239.
- and Yung, 238, 239.
- Pigments, action of light on, 248.
- Piliferous layer, regeneration of, 169.
- Pilobulus*, influence of darkness on growth of, 164; non-formation of sporangia under water, 121; *P. crystallinus*, growth of sporangiophore of, 11; influence of orange rays on, 104; *P. microsporus*, influence of light on formation of sporangium of, 97; — — on formation of sporophore of, 90; *P. torridus*, temperature for germination of, 81.
- Pilularia*, germination of spores of, in darkness, 92.
- Pinus*, symmetry in tissues of, 48; *P. sylvestris*, growth in thickness of, 13; non-reproduction of, by cuttings, 168; rapidity of growth of, 16; temperature limits for growth of, 76.
- Pisum*, influence of light on hypocotyl of, 87; *P. sativum*, influence of light on growth of, 97; — temperature on growth of, 77.
- Pith, compression of, 61; elongation of, 66.
- Planchon, 117.
- Plasmatic membrane, influence of, on poisonous action, 266.
- Plasmodia, influence of oxygen on, 117; — mechanical vibrations on, 131.
- Plasmolysis, influence of temperature on, 67; shortening produced by, 60.
- Plasmolytic solutions, vitality of cells in, 257.
- Plasmoptyse, 119.
- Plasticity of tissues, 58; influence of, on curvature, 58, 59.
- Plectenchyma, 46.
- Pleurococcus*, resistance of, to desiccation, 255.
- Poa annua*, influence of cold on, 236.
- Podostemonaceae, haptera of, 129.
- Poisonous actions, avoidance of, 263.
- Poisons, detailed action, 264; general properties of, 258; influence of chemical constitution, 271; — desiccation on action of, 252; — temperature on action of, 228; mode of action of, 267; non-assimilation of, 268; removal of, 269, 270.
- Polarity, induction of, 154; influence of, on grafting, 176; influence of gravity on, 156; — light on, 157; of cells, 159; origin of, 160; of *Salix*, 155, Fig. 26.
- Pollen-grains, action of salt on, 262; condition for germination of, 114; extrusion of solid particles by, 119; growth of coats of, 30; resistance of, to heat, 229; strains in wall of, 65; vitality of, 254.
- Pollen-tube, influence of, on fruit formation, 173; limited growth of, 145, 195; penetration of, 45.
- Polygonum*, intercalary growing zones in, 9; strains in stem of, 61.
- Polypodium vulgare*, resistance of, to desiccation, 254.
- Polyporus*, influence of light on development of, 94; resistance of, to cold, 238.
- Popovici, 12, 81.
- Populus*, callus-formation in, 132; influence

- of light on buds of, 94; *P. pyramidalis*, polarity of, 158.
- Post-regeneration, 170.
- Potamogeton nutans*, causes of elongation of, 128.
- Potassium, influence of, on germination of spores, 113.
- Potato, disappearance of resting period in, 212; freezing-point of, 242; grafting of, 174, 176; influence of cold on, 232, 233; — light on formation of tubers of, 93; — transitory cold on, 210; — tubers of, on formation of flowers, 164.
- Potato-plants grown in light and darkness, 86, Fig. 18.
- Potonié, 161.
- Pouchet, 230.
- Prantl, 88, 91, 92, 95, 96, 118, 151, 168; on periodicity, 204.
- Pressure, influence of, on cell-division, 42; — on freezing, 26, 244; — on leaf-primordia, 144.
- Preuss, 260.
- Prillieux, 58, 140, 239; on ice-formation in Labiatae, 240.
- Primordia, influence of correlation on development of, 162; — light on development of, 89; — pressure on, 144; modification of development of, 141; position of, 143, 144; types of, 142, 143.
- Pringsheim, 5, 156; on destructive action of light, 248.
- Projection lantern, use of, 19.
- Propionic acid, poisonous action of, 272.
- Prothall, influence of starvation on, 118.
- Prothallium, induction of dorsiventrality in, 150, 151; influence of, on planes of division of ovum, 158; regeneration of, 169.
- Protonema, formation of, in mosses, 167; influence of light on, 91; resistance of, to desiccation, 255.
- Protoplasm, extracellular, 178.
- Protoplasmic connexions, importance of, 178, 182-4.
- Protoplasts, fusion of, 177, 178; influence of, on contiguous wall, 35.
- Prunet, 158.
- Prunus*, elasticity of endodermis of, 55; *P. avium*, early flowering of, 205; *P. triloba*, shortening of resting period of, 209.
- Prussic acid, poisonous action of, 272.
- Pseudoparenchyma, 46.
- Pteris quadriaurita*, galls of, 171.
- Pterothamnion*, formation of branches in, 5.
- Pulst, on accommodation, 262; on non-absorption of CuSO_4 , 266; on resistance to poisons, 260, 262.
- Pulvini, influence of temperature on motility of, 67; periodicity in, 200; strains in, 62, 63, Fig. 16, 66.
- Putrefactive bacteria, temperature limits for growth of, 76.
- Pyrus malus*, growth of, as evergreen, 212.
- Quercus*, rapidity of growth in, 15; *Q. pedunculata*, growth of, as evergreen, 212, 213; periodicity in, 205.
- Rabinowitsch, 84, 227; on influence of oxygen on cardinal temperatures, 80.
- Raciborski, 92, 116, 117, 130, 154, 162, 169; on influence of inversion on growth, 110.
- Radius of curvature, influence of, on stretching of wall, 59.
- Ranunculus Ficaria*, causes of resting period of, 212; changes in seeds of, 208; *R. fluitans*, causes of elongation of, 128; *R. sceleratus*, elongation of petioles of, 122.
- Raphanus*, 82, 168; *R. sativus*, correlation of growth in, 89.
- Rapp, 131.
- Rauwenhoff, 86, 88, 102; on periodicity of growth, 201.
- Ray, 88, 110, 121, 129, 131, 194.
- Rechinger, 133, 158, 167, 209; on reproduction of horse-radish, 168.
- Regel, 241.
- Regeneration, 167.
- Reiche, 213, 217.
- Reinhardt, 5, 9, 17, 18, 32, 33, 34, 111, 118, 119, 257.
- Reinke, 5, 18, 20, 53, 55, 56, 96, 154, 164, 187; on influence of magnetism on growth, 107; — sound-waves on bacteria, 131; on periodicity, 204.
- Reproduction, 161, 167.
- Reproductive organs, influence of water on formation of, 121; limits of temperature for production of, 80; sexual and asexual, influence of oxygen-pressure on formation of, 117.
- Resa, 207.
- Reserve-materials, influence of, on resistance to desiccation, 253, 254.
- Resistance to extremes, 220, 224.
- Respiration, action of poisons on, 264.
- Resting periods, length of, 206; shortening of, 209, 210.
- Retinispora*, nature of, 152.
- Reuss, 13, 22, 66; on growth of lime trunk, 18.
- Reversal experiments, 159.
- Reversion, 189, 190.
- Rheum*, strains in stem of, 61.
- Rhizoids, influence of contact on formation of, 130; — gravity on formation of, 109; — light on development of, 93, 94.
- Rhizomes, regulation of depth of, 14.
- Rhythm in plants, 214.
- Richardson, 249.

- Richter, 93, 110, 119, 127, 148, 161, 257.
 Ricin, accommodation to, 263; action of, on algae, 261.
Ricinus communis, minimal temperature for, 232.
 Ricôme, 86, 154.
 Rieder, 105.
 Rigidity, 50 *seq.*; influence of, on tension, 59.
 Rigor-mortis, 69.
 Rimbach, 207; on contractile roots, 14.
 Rimpan, 17.
 Rittinghaus, 229, 238, 254.
Rivularia, 46.
Robinia, leaf-fall in, 217.
 Rodewald and Kattein, 36.
 Röntgen rays, action of, on plants, 105, 106.
 Roger, 126.
 Romanes, 252.
 Root, contraction of, 13; — amount of, 14; — causes of, 14, 15; growing zones in, 5, 8; influence of gravity on formation of, 109; — light on, 87; — — on formation of, 93; — — on rate of growth of, 96; — medium on growth of, 122; — moist air on growth of, 122; — pressure on formation of, 132; periodicity in, 204, 207; pressures exerted by, 125, 126, Figs. 22, 23; regeneration of, 168; resistance of, to heat, 230, 231.
 Root-apex, conversion of, into shoot-apex, 140; diagram of, 48.
 Root-hairs, influence of contact on, 129; — moisture on formation of, 130; — oxygen on development of, 115.
 Rosenberg, 43.
 Rosenvinge, 154; on polarity, 157.
 Rostafinski and Woronin, 121.
 Rothert, 9, 10, 12, 36, 134, 171.
 Rotifers, influence of cold on, 234.
 Roux, 2, 148, 157, 166; on asporogenous races, 193; on mechanics of development, 3; on post-regeneration, 170.
Rumex acetosella, conversion of root-pri-mordia into shoots, 140.
 Ruptures due to growth, 34.
 Russow, on causes of annual rings, 216.
 Rye-haulm, strength of, 50.
 Ryselberghe, 67.
 Rzentowsky, 99.
 Sabanejew and Alexandrow, 243.
Saccharomyces, literature on influence of temperature on, 84; suppression of spore-formation in, 193; temperature limits for growth of, 76; vitality of, 255; *S. cerevisiae*, limits of temperature for growth and spore-formation in, 80.
 Sachs, 3, 7, 8, 9, 12, 16, 22, 39, 47, 49, 62, 63, 64, 69, 78, 81, 83, 86, 87, 89, 91, 93, 94, 96, 97, 98, 102, 109, 122, 132, 143, 154, 201, 212, 224, 226, 227, 235, 244, 246; on anisotropy, 73; apparatus for measuring growth, 20; on autonomic variations of growth, 18; on cardinal temperatures for growth, 76; on causes of annual rings, 215; — etiolation, 99; on division at right angles, 42; on elongation of pith, 66; on freezing of plants, 239, 240; on growth-substances, 187; on influence of contact, 130; — medium on resistance to heat, 228; — ultra-violet rays, 103; on maximal and minimal temperatures for growth, 82; on nature of stimuli, 75; on origin of verticibasality, 160; on periodicity of growth, 203; on physics of growth, 30; on plasticity, 58; on resting periods, 215; on stages in growth, 6; on symmetry in tissues, 48; on ultra-maximal temperature, 225; on zones of growth, 5.
 Sadebeck, 92, 255.
 Saline solutions, influence of, on growth, 118.
Salix, early flowering of, 205; influence of light on buds of, 94; inversion of, 155; *S. amygdalina*, cause of galls on, 172; regeneration of bud of, 169; *S. capraea*, contraction of bark of, 61, Fig. 15.
 Saltatory variations, 193-6.
 Salter, 36.
 Samassa, 41, 261.
 Sames, 84.
 Sandsten, 113.
 Sanio, 7.
 Sap, freezing-point of, 241, 242.
Saprolegnia, 39, 41; decrease in dividing size of, 38; influence of food on formation of reproductive organs, 116; — — on growth and reproduction of, 117; — — on reproduction of, 198; resting periods of spores of, 208.
 Saussure, resistance of seedlings to desiccation, 252, 253.
Scenedesmus, resistance of, to desiccation, 255.
 Schacht, 205.
 Schaible, 114; influence of air-pressure on growth, 115.
 Schattentfroh and Grassberger, 227.
 Schaudinn, 105.
 Schellenberg, 28, 32, 45; influence of lignification on elasticity, 55.
 Schenck, 120, 121, 122.
 Schibata, 15.
 Schiebeler, 80.
 Schieberszky, 169.
 Schimper, 36, 70, 73, 81, 85, 95, 100, 109, 120, 123, 208, 209, 211, 212, 213, 214, 217, 218, 232, 255, 258; on growth of starch-grains, 35.

- Schizanthus Grahami*, grafting of, on potato, 176.
- Schmid, 123, 131, 158, 206.
- Schmidt-Nielsen, 258.
- Schmitz, 29, 32, 129, 168, 201, 238.
- Schober, 88, 105.
- Scholtz, 128, 134.
- Schomburgh, 213.
- Schostakowitsch, 84, 91, 117, 167.
- Schrieber, 81, 82, 116.
- Schröder, 210, 252, 253; on resistance to desiccation, 250, 251, 255.
- Schröter, 90.
- Schübler, 211, 239.
- Schütt, 32, 178.
- Schultze, 231.
- Schulzer v. Müggenburg, 90, 94.
- Schumacher, 238.
- Schumann, 71, 144.
- Schwarz, 13, 16, 40, 108, 129, 215, 260, 262; on causes of annual rings, 216; on influence of centrifugal force on growth, 110; — contact on root-hairs, 129.
- Schwendener, 28, 30, 46, 47, 49, 55; on mechanical tissues, 53, 54; on mechanics of tissues, 59; on phyllotaxis, 144; on relation of stretching to growth, 60.
- and Krabbe, 9, 64, 66.
- Sciadocalyx Warszewiczii*, minimal temperature for, 233.
- Sclerenchyma, influence of strains on development of, 54, 127.
- Secale*, growth of filaments of, 17; *S. cereale*, intercalary growing zone of, 12, Fig. 5.
- Secondary growth, influence of strains on, 128.
- thickening, influence of contact on, 129.
- Sedum elegans*, resistance of, to desiccation, 250.
- Seedlings, growth of, at varying temperatures, 77; influence of cold on, 236; periodicity in, 203; resistance of, to desiccation, 252, 253.
- Seeds, germination of, under water, 122; — when unripe, 252, 253; influence of desiccation on, 210, 254; — light on germination of, 92, 93; residual water of, 251; resistance of, to heat, 229; — to low temperature, 237; resting periods of, 207; soaked, resistance of, to cold, 245.
- Selaginella*, anisophylly of, 154; changes of symmetry in, 149; *S. lepidophylla*, resistance of, to desiccation, 254.
- Sempervivum*, influence of moisture on length of internodes in, 100; *S. tabulaeforme*, freezing-point of, 242.
- Sendtner, 211.
- Senebier, 91, 102, 229; on etiolation, 88.
- Senecio crassifolius*, ice-formation in, 240; *S. vulgaris*, influence of cold on, 236; resistance of, to cold, 232.
- Senile decay, 221.
- Senn, 118.
- Sensitizer, action of, 105.
- Serres, on thermophiles, 77.
- Sexual and symbiotic affinity, 176.
- Seynes, de, 260.
- Shape, causes of, 136; internal factors concerned in, 179.
- Shearing stress, 61.
- stresses, 50; magnitude of, 63.
- Shoots, regeneration of, 169.
- Sigmund, 114, 260.
- Silica, influence of, on growth of cell-wall, 33; — on tensile strength, 55.
- Silver salts, influence of dissociation on poisonous action of, 273.
- Sinapis alba*, influence of light on growth of roots of, 96; temperature limits for growth of, 76.
- Sirodot, 91.
- Skeletal framework, character of, 51; arrangement of, 52-4.
- Sliding growth, 45, 46.
- Sodium chloride, poisonous action of, 257, 262.
- Sokolowa, 5, 33, 34, 111, 129.
- Solanum tuberosum*, minimal temperature for, 232.
- Soldanella*, early flowering of, 79.
- Solms-Laubach, 192.
- Solvay, 106.
- Somatophytes, definition of, 4; transition forms to, 6.
- Sonntag, 10; on influence of lignification on elasticity, 55.
- Sorauer, 110, 120, 133, 224, 263.
- Sorel, on accommodation, 262.
- Sorokin, 102.
- Sound-waves, influence of, on growth, 131.
- Species, definition of, 191.
- Spencer, 136.
- Sphacelaria*, growth of, 5; size of apical cells of, 38.
- Sphaerella nivalis*, growth of, at low temperatures, 79; resistance of, to cold, 238.
- Sphaerobolus stellatus*, influence of light on, 90.
- Sphaerocrystals, solution of, 36.
- Spiraea filipendula*, growth of cell-walls of, 30.
- Spirillum*, influence of desiccation on, 256.
- Spiro, 230.
- Spirogyra*, 40; action of copper on, 270; dividing size of cells of, 38; embryonic character of, 4; growth of cells of, 33; influence of cold on, 238; — external conditions on reproduction of, 198; — light on cell-division in, 98; — — on conjugation of, 91; — plasmolysis on, 257; nuclear fragmentation in, 41; planes of division in, 42;

- polarity of, 159; shortening of, on plasmolysis, 60; verticibasality of, 156; *S. orbicularis*, amitosis in, 43; *S. princeps*, growth of, 19.
- Spores, germination of, on water and on nutrient solutions, 113; influence of coloured light on growth and germination of, 102; — food on production of, 116; — light on, 247; — — on formation of, 90; — — on germination of, 92; limits of temperature for formation and germination of, 80; resistance of, to heat, 226, 227; resting periods of, 207; vitality of, 254, 255.
- Sporodinia*, influence of moisture on formation of spores in, 123; *S. grandis*, influence of oxygen on reproduction of, 117.
- Sporophores, influence of light on development of, 90; strains in, 63.
- Sporophylls, influence of contact on formation of, 130.
- Sports, 192.
- Spot-disease, 174.
- Staby, 217.
- Stahl, 11, 42, 87, 92, 93, 94, 119, 121, 171; on influence of changes of concentration, 257; — light on lichens, 154; on polarity, 157; on protective adaptations, 54.
- Staminal filaments, elongation of cells of, 59; rate of growth of, 17; transmission of stimuli in, 185.
- Stammeroff, 17; on influence of light on growth of roots, 96.
- Standfuss, 81.
- Stange, 101, 118, 119.
- Starch-grains, growth of, 35; solution of, 36.
- Starvation, influence of, on resistance to desiccation, 253.
- Stebler, 10, 96; on periodicity, 204.
- Stellaria media*, influence of cold and thawing on, 234; — frequent thawing on, 235; resistance of, to cold, 232.
- Stems, influence of light on, 86, Fig. 18.
- Stenström, 100, 237.
- Stephanidis, 116.
- Sterigmatocystis*, influence of tension on attachment of, 129; *S. alba*, influence of inversion on, 110; induced variation of, 194.
- Stevens, 259, 260, 273.
- Sticta pulmonacea*, residual water of, 251.
- Stigeoclonium*, influence of saline solutions on, 118.
- Stimuli, classification of, 74, 75; correlative, 165; functional, 166; rapidity of transmission of, 185, 186; transference of, 181-5.
- Strains, in cuticle and cell-wall, 65, 66; in starch-grains, 37; in tissues, 61 *seq.*; — origin of, 34; longitudinal, 62; transverse, 62.
- Strasburger, 13, 31, 33, 39, 40, 43, 96, 98, 148, 171, 174, 176, 231, 236; on annual rings, 216; on growth by apposition, 29; — of wall of pollen-grains, 30.
- Streaming, action of poisons on, 264; influence of magnetism on, 107.
- Strehl, 12, 87, 96, 204.
- Streptocarpus*, influence of removal of cotyledon of, 162.
- Stresses in tissues, 61 *seq.*
- Stretching, relation of, to elasticity and osmotic pressure, 59.
- Strub, 227.
- Strychnine, poisonous action of, 260.
- Strychnos laurina*, strength of tendril of, 50.
- Sub-cooling, 239, 244; in plants, 242, 243.
- Suberization, influence of, on elasticity, 55.
- Substitution, influence of, on poisonous action, 210.
- Sugar, influence of, on germination, 113; — on resistance to cold, 247; vitality of plasmolysed cells in, 257.
- Sulphate of copper, dissociation and poisonous action of, 273.
- Sulphur-bacteria, optimal percentage of oxygen for, 114.
- Surface-tension, influence of, 179, 180; — on cell-division, 41.
- Surmont, 193.
- Swarm-spores, influence of change of temperature on production of, 82.
- Symbiogenesis, 189, 190.
- Symbiosis, changes of shape due to, 170; conditions for, 177.
- Symbiotic action, details of, 176.
- Symmetry in cell-division, 47.
- Syringa*, early flowering of, 205; influence of transitory cold on, 210; *S. vulgaris*, shortening of resting period of, 209.
- Taeniophyllum Zollingeri*, influence of light on aerial roots of, 87.
- Tammann, 244.
- Tammes, 247, 249.
- Taphrina*, galls due to, 171.
- Taraxacum*, contraction of hypocotyl of, 14; influence of moisture on length of internodes in, 100; *T. Dens-Leonis*, curvatures in split peduncle of, 61.
- Tassi, 113.
- Taxus*, dorsiventrality of leaves of, 153.
- Temperature, cardinal points for, 76; formative changes due to, 81; influence of, on action of poisons, 262; — on growth, 75; — on leaf-fall, 217, 218; — on length of internodes, 100; — on motility of pulvini, 67; — on parthenogenesis, 147; — on periodicity, 210; — on tissue-strains, 67; — on variation, 194, 195; low, effects of, on plants, 232-8; — production of death by, 244; supra-maximal, influence of, 224; ultra-maximal, 225.

- Tendrils, influence of strains on thickening of, 54; sense of touch of, 129.
- Tension, action of, on growth, 127; of cell-wall, influence of, on rigidity, 59; influence of, on growth, 30, 31.
- Teodoresco, 87, 88, 89, 100, 102, 103, 105, 118.
- Ternetz, 90, 116, 121, 123.
- Tharantder, 216.
- Thawing, influence of, 234, 235.
- Thermophile bacteria, influence of oxygen on minimal temperatures for, 80; temperature limits for growth of, 76.
- organisms, 76, 77; distribution of, 79; importance of, 78.
- Thermotonus, 69.
- Thiele, 84; on cardinal temperatures for growth, 76; on influence of food on cardinal temperatures, 80.
- Thigmomorphic, 132.
- Thigmotropic, 132.
- Thiselton Dyer, 237.
- Thomas, 88.
- Thuja*, induction of dorsiventrality in, 151.
- Thuret, 258.
- Tietz, 80, 84; on cardinal temperatures for growth, 76.
- Tilia europea*, periodicity in, 206.
- Tissue-strains, 61; development and alterations of, 65; history of, 64; influence of etiolation on, 88; — external conditions on, 66, 67.
- Tissues, embryonic, distribution of, 4; growth of, when isolated, 66; symmetry of, 47, 48.
- Tittmann, 14, 158, 167, 169; on callus-formation, 132.
- Tjibodas, growth of trees at, 212-4.
- Tladiantha dubia*, influence of gravity on, 109.
- Tobacco, spot-disease of, 174.
- Tolomei, on influence of magnetism on germination, 107.
- Tone, importance of, 69.
- Touch, sense of, in plants, 121.
- Tournefortia hirsutissima*, minimal temperature for, 233.
- Townsend, 40, 113, 145, 146, 186; on conduction of stimuli, 183; on influence of injuries on growth, 134, 135; on protoplasmic threads, 33.
- Tox-albumins, action of, on algae, 261; mode of action of, 268.
- Toxins, destruction of, by cold, 239.
- Tradescantia*, action of light on, 248, 249; freezing of, 241; regeneration of epidermis of, 169; *T. discolor*, minimal temperature for, 233.
- Trambusti, on accommodation, 262.
- Transpiration, influence of, on annual rings, 216; — on etiolation, 100; — on leaf-fall, 218; — on spore-formation, 123.
- Transversals, 48.
- Tropa natans*, resting period of seeds of, 207.
- Traumatic effects on growth, 133; on shape, 134.
- Trees, diurnal changes of volume of, 66.
- Treib, 173.
- Treviranus, 107, 129, 161, 263.
- Trianea bogotensis*, position of nucleus in root-hairs of, 33.
- Trichites, 35.
- Trifolium alpinum*, resistance of, to cold, 234.
- Triticum*, elongation of filaments of, 17; *T. vulgare*, influence of temperature on growth of, 77; temperature limits for growth of, 76.
- Tropaeolum*, development of flower of, in darkness, 91; influence of light on hypocotyl of, 87; *T. majus*, influence of ultra-violet rays on, 103.
- Trophic, definition of, 73, 74.
- True, 79, 118, 257.
- and Hunkel, 271, 273.
- Tschirch, 260, 261, 253.
- Tschoudy, on grafting, 176.
- Tsilinsky, 84; on accommodation to high temperatures, 80; on bacteria in hot springs, 77.
- Tubers, effect of suppression of, 163; influence of, on formation of flowers, 164; periodicity of growth of, 204; production of, on aerial shoots, 162; regulation of depth of, 14.
- Tulipa*, influence of desiccation on, 210; intercalary growth in leaf of, 9; leaves of, 13.
- Turgidity, influence of, on growth, 29, 118; — on rigidity, 51, 58.
- Turgor, influence of air-pressure on, 115; — on elasticity and cohesion, 57; stretching of cell-wall by, 60.
- Tussilago Farfara*, early flowering of, 79.
- Twigs, abscission of, 217.
- Tyloses, 28, 45; formation of, 134.
- Typhus bacilli, influence of salt solution on, 258.
- Uhlitzsch, 10.
- Uloth, 83; on cardinal temperatures for growth, 76.
- Ulothrix zonata*, cause of resting period of, 212; resistance of, to cold, 236; temperature limits for growth of, 76.
- Ultra-maximum, 220.
- Umbelliferae, origin of hollow stems of, 34.
- Uncaria*, tensile strength of stem of, 50.
- Urtica urens*, resistance of, to cold, 232.
- Usnea barbata*, stretching of hyphae of, 57.
- Ustilagineae, vitality of spores of, 255.
- Ustilago carbo*, influence of light on, 247, 249.

- Vallisneria*, abscission of male flowers of, 216; rate of propagation of stimuli in, 185.
- Vallot, 15.
- Van der Does, 230.
- Vanilla aromatica*, contraction in roots of, 14; growing zone in root of, 8.
- Van Tieghem, 168.
- and Bonnier, 220.
- Variation, 189.
- Variation, 174, 175.
- Varieties, propagation of, 196.
- Varigny, de, 260.
- Vaucheria*, 41; apical growth of, 5; cell-segmentation in, 39; galls of, 171; growth of, 33; healing of wounds of, 133; influence of air-pressure on, 118; — change of temperature on, 82; — cold on, 238; — coloured light on spore-formation in, 102; — concentration on, 121; — external conditions on reproduction of, 198; — light on reproduction of, 91; — water on formation of zoospores of, 123; intermediate character of, 6; suppression of sexual organs in absence of CO₂, 100; *V. repens*, limits of temperature for growth and zoospore formation of, 81; temperature limits for growth of, 76.
- Vegetative reproduction, sufficiency of, 199.
- Velten, 231.
- Veratrine nitrate, dissociation of, 273.
- Verticibasality, inherent, 155; induced, 156, 157; origin of, 160.
- Verworn, 188, 224; on thigmomorphic reactions, 132.
- Vibrio cholerae*, influence of desiccation on, 251.
- Vicia*, growth of root of, 17; *V. Faba*, growing seedling of, 8, Fig. 1; heat-rigor in, 225; influence of temperature on growth of, 77.
- Victoria regia*, rate of growth of, 17.
- Villari, 67.
- Villinger, on immotile varieties, 194.
- Vinca minor*, ultra-maximal temperature for, 231.
- Vine, growth of, as evergreen, 213; influence of transitory cold on, 210.
- Vines, 74, 101, 102, 204; on influence of light on growth, 96.
- Viscum album*, connexion of, to host, 178; influence of light on germination of, 92.
- Vitis vinifera*, grafting on petiole of, 176.
- Vöchting, 3, 7, 47, 67, 81, 87, 91, 93, 99, 100, 104, 109, 122, 123, 127, 132, 139, 142, 144, 145, 150, 152, 158, 160-4, 166-9, 171, 173-5, 187, 218; on continuity in grafts, 178; on dorsiventrality, 153; on influence of oxygen on formation of root-hairs, 115; on inverted grafting, 176; on retarding action of gravity on growth, 110; on reversal experiments, 159; on verticibasality, 155.
- Vogel, 246.
- Volkens, 206.
- Volume elasticity, 50.
- Von Tubeuf, 122.
- Von Webstein, 192.
- Vries, de, 28, 58, 63, 73, 83, 99, 101, 118, 120, 152, 165, 176, 189, 190, 192, 206, 257; on cardinal temperatures for growth, 76; on causes of annual rings, 215; on contractile cells in roots, 14; on resistance to heat, 224-31; on stretching due to turgor, 60.
- Wächter, 128.
- Wakker, 122, 125, 158, 167, 171, 209.
- Waldeger, 194.
- Walz, 86, 87, 91.
- Warburg, 32, 134.
- Ward, 113, 130, 170.
- Wasserzug, on motile varieties, 194.
- Water, influence of, on cohesion and elasticity, 55; — on form and structure, 120 *seq.*; — on growth, 118; — on leaf-fall, 218; — withdrawal of, 249; partial, 250; complete, 251; — — by freezing, 245.
- Water-lily, tension in petiole of submerged leaf of, 122.
- Water-percentage, influence of, on tissue-strains, 66.
- Water-vapour, influence of, on elongation of pith-cylinder, 66.
- Weed, on thermophiles, 77.
- Weeping willow, influence of gravity on, 110.
- Wehmer, 258, 271.
- Weinzierl, 55, 56.
- Weismann, 223; on heredity, 187, 188; on reproductive and somatic plasma, 148.
- Weisse, 73, 144, 145, 154.
- Welter, 233.
- Welwitschia*, intercalary growth in leaf of, 9.
- Weng, 101.
- Went, 8, 14.
- Werner, 117, 121.
- West, 94, 238.
- Westermaier, apical growth of vascular cryptograms, 5.
- Wettstein, 7, 12.
- Wheat, mummy, 254.
- Wichura, 154; on vitality of willow seeds, 254.
- Wieler, 114, 118, 122, 207; on causes of annual rings, 216; on influence of oxygen and air-pressure on growth, 115; on periodicity, 208.
- Wiesner, 2, 6, 7, 20, 21, 22, 25, 29, 73, 81, 86, 87, 88, 91, 92, 95, 100, 102, 109, 130, 154, 166, 167, 186, 210; on cessation of growth in intense light, 94; on influ-

- ence of light on growth of roots, 96; on leaf-fall, 217, 218; on protective adaptations, 54; on resistance to desiccation, 254; on resting periods of seeds, 208.
- Wigand, 7.
- Wildemann, de, 41, 42.
- Will, 252, 255.
- Wille, 29, 67; on growth of walls of pollen-grains, 30.
- Willows, influence of desiccation on seeds of, 254.
- Winkler, 144, 147, 156, 157, 208; on vitality of willow seeds, 254.
- Winogradsky, on influence of peptone, &c., on nitrifying bacteria, 112.
- Witch's broom, 171.
- Wittlin, 105.
- Wittmack, 211.
- Wittrock, 254.
- Wolkoff, on influence of light on growth, 97.
- Wollenweber, 122.
- Wollny, 70, 106, 120.
- Woloszczak, on vitality of willow seeds, 254.
- Wood, contraction of, on drying, 67; limit of elasticity of, 56.
- Wood-cylinder, diagram of, 48.
- Wortmann, 29, 101; on relation between growth and stretching, 30; on stretching due to turgor, 60.
- Wound-reactions, 133, 135.
- Wüllner, 244.
- Wüthrich, 260; on equivalent solutions, 273.
- Xenomorphosis, 72.
- Xylem, grand period of growth of, 13.
- Yasuda, 119.
- Yeast, accommodation of, to poisons, 262; growth of, at high pressures, 126, 127; influence of cold on, 239; life of, in absence of growth, 223.
- Yellowstone Park, organisms in hot springs of, 77.
- Young, 56.
- Yucca*, effects of inversion of, 109; strains in branches of, 63; verticibasality of, 160.
- Zacharias, 33, 40.
- Zea Mays*, influence of absence of oxygen on resistance to heat, 228; — temperature on growth of, 77; resistance of, to heat, 231; temperature limits for growth of, 76.
- Ziegler, 43; on cell-division in absence of nucleus, 43.
- Zimmermann, 31, 40, 41, 42, 43, 45, 54, 83, 93, 178.
- Zinc, accumulation of, 266.
— sulphate, poisonous action of, 261.
- Zones of growth, relation between, 11; length of, 12.
- Zooecidia, 171.
- Zoospores, influence of light on formation of, 91; limits of temperature for formation of, 80.
- Zopf, 84, 90, 92, 117.
- Zumstein, 112.

ERRATA

- Page 128, note 2, for Scholz read Scholtz
 „ 145, note 1, for Weise read Weiss

