

UNIVERSITY OF B.C. LIBRARY



3 9424 04545 364 1

STORAGE ITEM
PROCESSING-ONE
UNIVERSITY OF B.C.

THE LIBRARY

THE UNIVERSITY OF BRITISH COLUMBIA



Born 1871 in Wales, served in the Himalayas with the British Transport Corps and in the Boxer Rebellion, helped construct the C.P.R., fought with the Canadian Expeditionary Force 1914-17, a resident of Vancouver for forty years, still a reader at 94, donated his collection of 4,000 books in 1965.

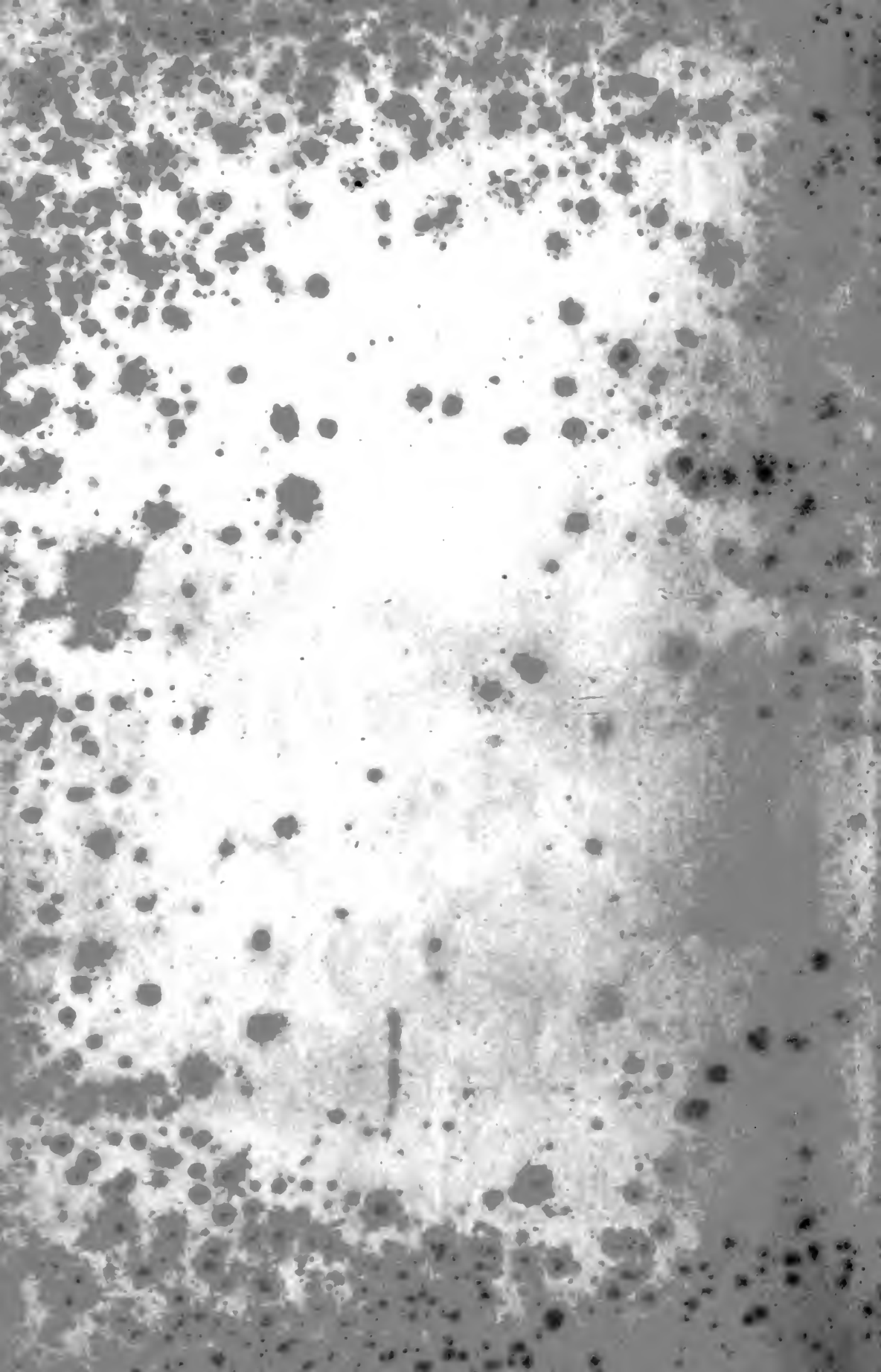





L. GILSON, BROW

THE NEW YORK PUBLIC LIBRARY

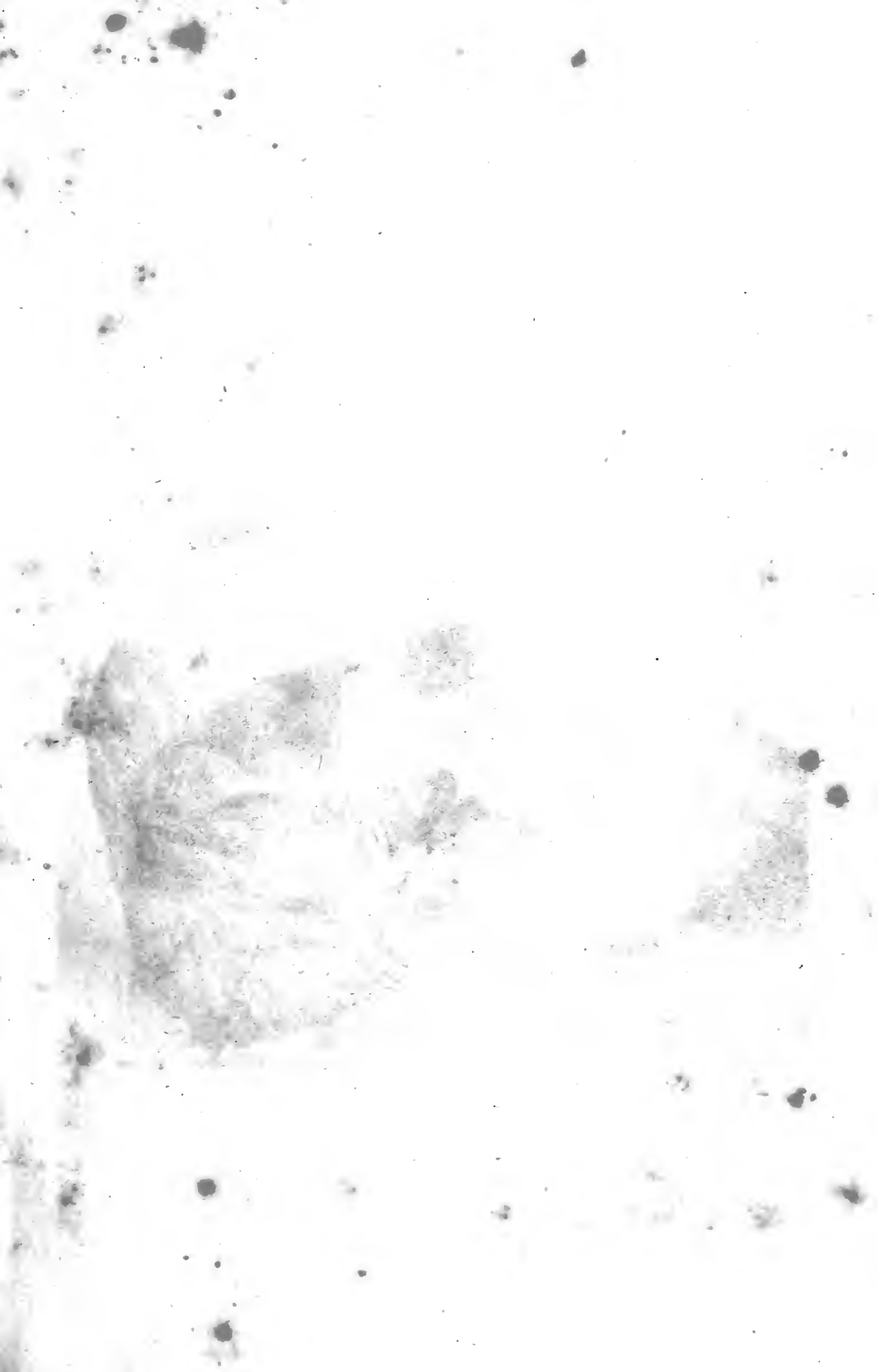



THE
POULTRY BOOK

BY

W. B. TEGETMEIER, F.Z.S.

WITH

PICTURES BY HARRISON WEIR.

PRINTED IN COLOURS BY LEIGHTON, BROTHERS.



LONDON:

GEORGE ROUTLEDGE AND SONS,

THE BROADWAY, LUDGATE.

NEW YORK: 418, BROOME STREET.



THE
POULTRY BOOK:

COMPRISING THE

BREEDING AND MANAGEMENT.

OF

PROFITABLE AND ORNAMENTAL POULTRY,

THEIR

QUALITIES AND CHARACTERISTICS;

TO WHICH IS ADDED

“THE STANDARD OF EXCELLENCE IN EXHIBITION BIRDS,”

AUTHORIZED BY THE POULTRY CLUB.

BY

W. B. TEGETMEIER, F.Z.S.,

EDITOR OF “THE STANDARD OF EXCELLENCE,” AND OF THE POULTRY DEPARTMENT OF “THE FIELD;”

AUTHOR OF “PROFITABLE POULTRY,” “POULTRY AS AGRICULTURAL STOCK,” ETC.

WITH

COLOURED ILLUSTRATIONS BY HARRISON WEIR,

AND NUMEROUS ENGRAVINGS ON WOOD.

LONDON:

GEORGE ROUTLEDGE AND SONS, THE BROADWAY, LUDGATE.

NEW YORK: 416, BROOME STREET.

1867.

LONDON :
PRINTED BY WOODFALL AND KINDER,
MILFORD LANE, STRAND, W.C.

PREFACE.

IN compiling the present work, the Editor has aimed at producing a treatise that, in the fulness of its details, and the practical character of the information imparted, should be in advance of any of its predecessors. In order to secure this object, he has had recourse to the most eminent authorities on each particular variety; so that every breed of Poultry is described by its most successful cultivators.

The original articles thus contributed form by far the most valuable portions of the following pages, and the Editor need but to mention the names of those friends to whom he is indebted, to secure for their contributions the attentive perusal of all interested in the subject. Mr. Edward Hewitt, so widely known as one of the most practised judges at the various Poultry exhibitions, has supplied many most valuable articles, both on profitable and exhibition birds. Mr. R. Teebay has given a detailed account of the methods of breeding the different varieties of Mooneys, Pheasant Fowls, and Brahmas, that has never before been made public. Mr. Douglas, of the Clumber Aviaries, has described his most successful methods of rearing the large-framed Dorkings, which he has so successfully exhibited. Mr. Zurhorst, the Honorary Secretary of the Poultry Club, has treated largely on the economical merits of the recently introduced French breeds, of which he has been so successful a cultivator. Mr. P. Jones has given his experience in rearing the Polish varieties. The late Dr. F. Horner furnished the first account ever printed of the origin of the singular hen-feathered breed known as Sebright Bantams. Mr. Ballance, and the Rev. A. G. Brook, have written on Malays. Some of the more interesting changes that take place in the plumage of fowls have been described by the Editor, who has also furnished the chapter on the diseases of Poultry; and other authorities will be found to have given their experience in the several chapters.

Not only have the more ornamental breeds been described with increased accuracy, but great attention has been paid to the more practical details of

profitable Poultry keeping. The most approved modes of fattening as followed in England, are given in the chapter on Dorkings; and the methods that are adopted in France to produce the splendid fat capons and poulardes of the Paris fat poultry Shows, are described at length in the chapter on French Fowls.

The illustrations, which are from the pencil of Mr. Harrison Weir, speak for themselves. No work so fully and profusely illustrated has previously been published on the subject.

The Publisher and Editor have to acknowledge their obligations to the Proprietors of the *Illustrated London News* and the *Field* for the permission kindly accorded them to reproduce many of the woodcuts which are dispersed throughout the volume.

LIST OF ILLUSTRATIONS.

COLOURED ENGRAVINGS.

	FRONTISPIC
CREVECŒURS	" "
COLOURED TITLE	" "
BUFF COCHIN HEN	<i>to face page</i> 39
BUFF COCHIN COCK	" 41
CINNAMON COCHIN HEN.	" 43
PARTRIDGE COCHINS	" 45
WHITE COCHIN COCK	" 47
LIGHT BRAHMAS (GREY SHANGHAI)	" 63
DARK BRAHMAS	" 73
MALAY COCK	" 79
COLOURED DORKINGS	" 87
WHITE DORKING COCK	" 99
SPANISH	" 105
BLACK-RED GAME	" 125
DUCKWING GAME	" 141
PENCILLED HAMBURGHES	" 147
SPANGLED HAMBURGHES	" 157
BLACK POLISH	" 177
SILVER-SPANGLED POLISH	" 181
GOLD-SPANGLED POLISH	" 185
HOUDANS	" 201
LA FLECHE	" 213
GOLD AND SILVER-LACED BANTAMS	" 241
WHITE AND GAME BANTAMS	" 249
TURKEY	" 273
PEACOCK	" 285
GUINEA FOWL	" 293
ROUEN AND BUENOS AYRES DUCKS	" 297
AYLESBURY DUCKS	" 305
TOULOUSE GEESE	" 313

ENGRAVINGS ON WOOD.

	PAGE
HER MAJESTY'S POULTRY HOUSE	1
OCTAGONAL POULTRY HOUSE	4
PLAN FOR POULTRY YARD	5

	PAGE
PERCHES	6, 7
NATIONAL POULTRY COMPANY'S POULTRY HOUSE	8
FEEDEE FOR GRAIN	12
POULTRY FOUNTAIN	15
MINASI'S INCUBATOR	23
HER MAJESTY'S COCHINS, IMPORTED 1843	36
HER MAJESTY'S BRAHMAS, IMPORTED 1852	54
DARK BRAHMAS, IMPORTED 1853	59
LIGHT BRAHMA COCKEREL	68
LIGHT BRAHMA PULLET	69
DORKING FOWLS	92
COLUMBIAN FOWLS	116
BLACK AND WHITE SPANISH FOWLS	117
DUCKWING GAME FOWLS	129
HEN-FEATHERED GAME BANTAM COCK	133
FEATHERS OF DIFFERENT BREEDS OF SPANGLED HAMBURGHIS	159
PADUAN FOWLS	170
SKULLS OF POLISH FOWLS	174
SULTAN FOWLS	188
HOUDAN FOWLS	206
CREVECCURS AND COCHINS	207
FEATHER OF SILKY COCHINS	224
FRIZZLED FOWLS	227
BEGUM PILLY GAGUZES	239
BANTAMS	240
PEKIN OR COCHIN BANTAMS	251
TURKEYS	264
HONDURAS TURKEY	272
GUINEA FOWL	288
DUCKS	296
GREY CALL DUCKS	310
SEBASTOPOL GEESE	312
SCLEROSTOMA SYNGAMUS	328

C O N T E N T S.

CHAPTER	PAGE
I. POULTRY HOUSE AND YARD.	1
II. FEEDING AND THE COMPARATIVE VALUE OF THE DIFFERENT FOODS.	11
III. THE SITTING HEN	17
IV. STRUCTURE AND DEVELOPMENT OF THE EGG.	25
V. THE MANAGEMENT OF CHICKENS	32
VI. COCHINS	37
VII. BRAHMAS	55
VIII. MALAYS	75
IX. THE COLOURED DORKING FOWL	82
X. THE WHITE DORKING FOWL.	99
XI. THE SPANISH FOWL	102
XII. THE GAME FOWL.	123
XIII. PENCILLED HAMBURGHS.	146
XIV. SPANGLED HAMBURGHS	154
XV. WHITE-CRESTED BLACK POLISH FOWLS.	171
XVI. SPANGLED AND WHITE POLISH FOWLS	179
XVII. SULTAN FOWLS	188
XVIII. FRENCH BREEDS :—HOUDANS, CREVECEURS, LA FLECHE, LA BRESSE, ETC.	193
XIX. THE SILK FOWL	221
XX. THE FRIZZLED FOWL	226
XXI. THE RUMPLESS FOWL	230
XXII. DUMPIES, REDCAPS, BARNDOR FOWLS, DOMESTIC FOWLS OF INDIA.	233
XXIII. BANTAMS	240
XXIV. THE ORIGIN OF THE DOMESTICATED VARIETIES :—THE JUNGLE FOWLS	255
XXV. THE TURKEY	265
XXVI. THE PEA-FOWL	279
XXVII. THE GUINEA FOWL	288

CHAPTER	PAGE
XXVIII. DUCKS	296
XXIX. GEESE	312
XXX. DISEASES OF POULTRY	322

 APPENDIX.

THE STANDARD OF EXCELLENCE IN EXHIBITION BIRDS.

COCHINS	337
BRAHMAS	339
MALAYS	340
DORKINGS	341
SPANISH	342
GAME	343
HAMBURGHES	345
POLISH	347
SULTANS	349
HOUDANS	349
CREVECŒURS	349
LA FLECHE	350
BANTAMS	350
TURKEYS	351
DUCKS	351
GEESE	352



HER MAJESTY'S POULTRY-HOUSE AT THE HOME FARM, WINDSOR.

THE POULTRY BOOK.

CHAPTER I.

POULTRY HOUSE AND YARD.

THE first, and by no means the least important, consideration of every prospective poultry keeper is the situation and construction of the houses and yards. It is true that poultry may be kept almost anywhere; first-rate specimens of Cochins have been reared in an attic, and many very fine ones have never known there was any world beyond a small back yard in the street of a country town. These, however, are extreme cases; and success under such disadvantageous conditions can only be achieved by constant attention and great judgment in supplying artificially those requirements of the birds which the place of confinement does not afford.

The best of all soils on which to establish a poultry yard is gravel, or sand resting on chalk or a substratum of gravel. If the soil is clayey, or from other causes retentive of wet, the whole should be well drained, and a good breadth of it raised artificially by carting on to it a foot depth of chalk or gravel, to be covered over with a few inches depth of sand. This is more than desirable—it is almost essential to success—stagnant wet in the soil being more inducive than any other circumstance of cramp, roup, and some other diseases.

The best of all aspects is south or south-east ; and the side of a gently rising hill, if sheltered from the north and east by plantations, leaves little to be desired on this point. If the birds can have access to those plantations and to a grass field, and the soil is such as we have described, then, so far as the ground and situation are concerned, nothing remains to be desired.

The houses and yards must be constructed according to the purposes of the proprietor. Those who keep a cock and three or four hens merely for home supply will require a very simple building ; but the proprietor who breeds for sale and profit must have a more elaborate arrangement.

The most essential requisites in a fowl-house may be briefly stated. They are, warm, dry shelter ; pure air, which is dependent on a capability in the house of being readily cleansed ; a supply of the requisite perches ; and a proper arrangement of nests for the laying and hatching hens.

These four requirements do not demand any distinct building or architectural outlay. Almost any shed, even an ordinary lean-to, can at a trifling expense be converted into a fowl-house. Warmth, particularly in winter, is essential ; as not only is a greater amount of food required if the fowls roost in an exposed situation, but the production of eggs is remarkably lessened. Even young pullets can scarcely be induced to lay in severe weather, if compelled to roost in a very cold situation. It is desirable, therefore, that the shed should open to the south ; northern or easterly aspects being particularly unfavourable during the colder seasons of the year. The roof should not consist simply of loose open tiles, which permit the escape of the warmth ; but should either be ceiled or constructed of thatch, or some other warm material.

Dryness is one of the most essential requirements in a fowl-house. Exposure to damp, particularly at night, frequently produces attacks of that most fatal and, in its severest stages, contagious disease termed roup.

Pure air is ensured by such a construction of the house as admits of a frequent removal of the dung. The house, therefore, should be sufficiently well lighted to allow of its state of cleanliness being observed, and the floor should be formed of some hard material which admits of ready cleaning. A very easy method of keeping a fowl-house clean consists in laying a loose board below each perch, so as to receive the dung as it falls. This board, being perfectly loose, is readily lifted up and cleaned. The value of the manure will amply pay for the trouble employed in collecting it. It is a strong, stimulating, nitrogenous fertilizer, possessing great power of forcing the growth of vegetables, particularly those of the cabbage tribe. As an example of its value, we may state that we have had a bed of Brussels sprouts upwards of six feet in height, that were manured solely with the scrapings of the fowl-house.

The form and arrangement of the perches, particularly where heavy fowls, such as Dorkings, are kept, is a matter of considerable importance. If they are small in circumference, the weight of a heavy growing fowl is very apt to produce crookedness of the breastbone, which detracts very much from the appearance of the bird

when plucked, and consequently lessens its market value. The perches, therefore, for heavy fowls should be at least three inches in diameter; nothing will be found to answer better than a fir or larch pole about nine inches round, split down the middle, and each half placed with the flat side downwards. The position of the perches is even a matter of greater importance than their size. From seeing that fowls, when at large, frequently ascend to a great height in the trees in which they roost, many persons imagine that high perches in a fowl-house cannot be disadvantageous: they forget that, in descending from a tree, the bird flies a considerable distance, and alights without violence on the ground; whereas in a confined fowl-house this is impracticable, and the bird flutters down almost perpendicularly, coming into contact with the floor with great force. The keel of the breast-bone of Dorkings is often broken by these falls; and corns, and that slow chronic inflammation termed bumble-foot, are the inevitable result of this error in the position of the perches.

A very convenient arrangement of the nests and perches, where one shed or house alone is devoted to roosting, laying, and hatching, is for the perches to occupy the centre, and the slanting supports on which they rest to be so slightly inclined that the fowls can readily walk down them instead of flying off the upper perches. A footway at each end will give ready access to the laying-boxes, and this without rendering it necessary for the dirt to be trodden upon,—a point of considerable importance where there is a due regard for cleanliness. The laying-boxes should be placed against the sides of the shed, and covered with a sloping board, so as to prevent any birds from roosting upon them. If they are raised about two feet from the ground, an additional row of baskets or loose boxes can be placed on the floor underneath.

Where such economy of space is not absolutely necessary as to require the nests to be placed in a row, the employment of loose baskets will be found preferable, as they enable the whole nest to be removed and thoroughly cleaned after the hens have hatched, and from their not being so closely crowded together they do not afford such a harbour for fleas and other vermin.

We have always found that the eggs hatch much better if the nests are made by placing a cut turf, and a shovel of mould, sand, or ashes, in the box or basket, and on this a little short straw. In this way a convenient hollow nest is obtained, that prevents the eggs rolling out from under the sitting hen. In cold weather the eggs are thus kept of a much more equable temperature than in nests made simply of loose straw.

In a recent number of the *Canada Farmer* a design for a poultry-house is given, which offers a difference of arrangement from those usually constructed in this country, and which, with some slight alterations believed to be improvements, is reproduced in the accompanying cuts, representing the external and sectional elevations, and the plan of the structure.

The house is octagonal, that form being chosen as offering a greater internal space for the same extent of wall than the square form. The door A occupies one

of the sides, the windows B B those immediately adjacent. The roof is supported by a central pillar F, and, if desired, may have a lantern light at the top, with louvre boards or other openings for ventilation. The centre pillar is by far the best plan of supporting the roof, for if horizontal tie-beams are used the fowls will

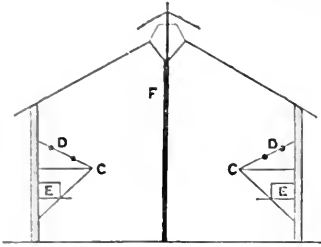

SECTION OF POULTRY HOUSE.

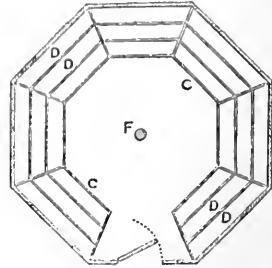

PLAN OF POULTRY HOUSE.



OCTAGONAL POULTRY HOUSE.

unquestionably perch on them. Around seven sides of the interior runs a broad stout shelf, c c, over which the two lines of perches, d d, are supported on inclined rests. Underneath c c is a narrower shelf for the nest boxes, e e. If desired, moveable baskets or boxes can be placed on this shelf.

The advantages of this arrangement are obvious. The fowls, following the natural instinct which leads them to select the highest perches, roost over the shelf, and the nest-boxes are undefiled. The dung on the shelf is in a position in which it can be easily scraped away with a flat hoe or scraper, and the shelf sanded daily. The floor is kept free from filth, and the house consequently always preserved clean and wholesome. The space under the nest-boxes will serve for the cooping of the hens with chickens, if no better situation offers.

If extreme cheapness of construction be an object, the house may be built by driving eight poles into the ground at equal distances, and closing in the spaces between them with weather boarding. The form admits of easy ornamentation, and may be adapted to harmonise with almost any style of buildings.

The following plan for a poultry yard is suitable for a confined situation—for

example, the end of a garden in a town. It is arranged for keeping Cochins or Brahmas, but it would answer for any other varieties, by having the nests smaller, and perches instead of a barred floor for the roost.

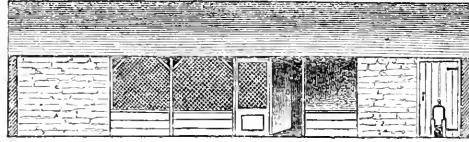

ELEVATION

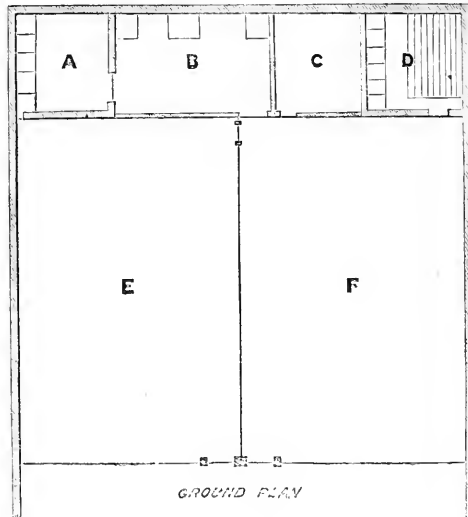
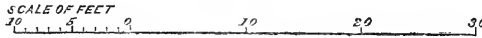

GROUND PLAN

The arrangement shown in the engravings is chiefly suitable to the breeding season. Afterwards the yards and houses may be used, if desired, for keeping the sexes separate until the next season. The front of the shed for chickens should be of wire, and the fences to the yard should be of the same material.

The amateur of limited means may construct a poultry-house for a very small sum. A lean-to may be erected with weather boarding, against the west or south side of any wall, the roof being formed with inch deal boards, laid close together up and down the slope, and projecting in front, and even over the sides, so as to protect the walls from the drip. In order to render this shed waterproof, some waste calico or old sheeting may be tightly stretched over it. Some tar may be boiled with a little lime, and the mixture while still hot may be applied with a brush; this, soaking through the calico, cements it to the roof, and the whole is rendered impervious to the weather. The perches may be arranged on an incline, which should rise from the front of the house towards the back. They

should also be considerably shorter than the house is long, in order to leave a space at each end for the nests, which may be advantageously arranged on the floor. If preferred, a moveable frame or roost, such as is shown in the accompanying engraving, may be used.

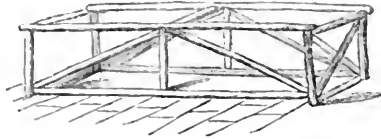

FRAME FOR ROOST.

It is not essential to success that the nests should be upon the ground, though many persons always so construct them for the use of their hens, in conformity with the general observation that fowls, when left to themselves, usually do so. But, whether on the ground or raised somewhat above it, they should be warm and somewhat secluded. For a soft material to place within them we like straw, cut into short lengths by a chaff-cutting machine, as well as anything; though some breeders prefer heath similarly treated. In cold weather, a thick bed of ashes under the straw will be found to retain the heat of the hen more completely, and to yield more satisfactory results. We shall, however, enter more fully into this part of the subject in our chapter upon the management of the hen whilst sitting.

Perches, although essential to the lighter varieties, are not necessary for Cochins and Brahmas, who do better on a floor littered down warmly with straw, the same as for a horse, the straw being gathered up in the morning as is done by the groom. Some breeders of Cochins have a latticed floor without even straw. Other breeders have latticed benches raised about six inches from the floor; and some give the birds nothing but a bed of sand to rest upon. All practical authorities agree in the opinion that for heavy birds to roost on narrow perches is productive of crooked breast-bones—a result that might be anticipated, as the pressure is unavoidably in one place during the whole roosting time. This deformity is a most serious defect in any specimens of poultry, but more particularly in those intended for the table.

If perches are adopted for Cochins, they should not be more than one or two feet from the ground; for, if higher, these weighty birds, with defective wings, are very liable to be lamed in descending. Wherever perches are employed, their oblique arrangement, one above and behind the other, has merits as regards the comfort of the birds, the economical arrangement of space, and facility for cleaning the house. Each perch thus forms a step to the one above; and if the floor beneath be well sanded, a common road-scraper, or similar implement, removes the dirt with the least possible labour. In the annexed sketch the highest of the perches is three feet from the ground, and they are so arranged as to drop into niches formed by nailing pieces of wood on the bar that carries them; these niches should be placed two feet apart.

Latticed floors do not seem comfortable to poultry; and as the manure that falls

through is not always visible, it is often permitted to remain much longer than is desirable; while a portion constantly adheres to the upper surface, and hinders

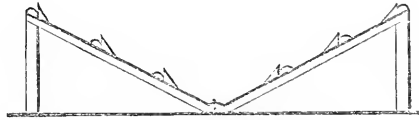

DOUBLE INCLINE OF PERCHES.

that perfect cleanliness which is so desirable in a fowl-house, whether it be the abode of half a dozen or a hundred.

Every fowl-house should possess the means of admitting sufficient light. This may either be admitted through an ordinary window or through a pane or two of thick glass in the sides, or a few glass tiles or slates in the roof. In wet weather the birds will be the more ready to take shelter within if light be there, and the master's inspection of the state of their domicile is the more readily performed.

A rough application of the Venetian shutter, or louvre boarding, fitted to the highest part of the interior of the fowl-house, excludes the rain and direct draughts of wind, and allows the egress of the heated air from within, for carpenters are seldom so accurate in the door and fittings of such edifices as not to leave sufficient apertures for admitting what is required to take its place.

Neglect of ventilation is a sure forerunner of disease, and if every poultry keeper was compelled himself to unlock the doors of the house every morning for a week, there would be fewer complaints on this head; but the unfortunate cocks and hens are too often either condemned to shiver in an open out-house, or are else imprisoned in an atmosphere like the hold of a slaver. However easy the remedy and evident its necessity, not one fowl-house in a dozen, even of those of most pretension, are properly arranged in this respect.

For enclosing the yard, netting formed of galvanized iron wire is usually employed, as it has the great advantage of neither rusting nor requiring any kind of paint for a considerable length of time. An enclosure of this wire work, three feet high, is amply sufficient for the confinement of Cochins; whereas seven feet in height is not too much for the lighter varieties, such as Game and Hamburgs. It should be stretched to oak posts eight feet apart, and fastened by means of small staples of the same galvanized metal. Care must be taken not to have a bar or rail along the top of the wire-work, for, although when secured in this manner it has a more finished appearance, yet it offers a resting place which often tempts the fowls to perch upon it, and thence to descend into the grounds from which we wish them to be excluded.

The most elegant and durable wire fencing that has come under our notice is that made by Greening and Co., Manchester. Below it is sufficiently close to be proof alike against the ingress of rats or the egress of chickens, and, being spiked above, it affords no resting-place for the fowls, who consequently rarely attempt to fly over it.

Chickens are often unwilling, in the mild weather of summer and early autumn, to retire to their homes as evening approaches; on these occasions, thinking no great harm can happen to them, or disliking the trouble of driving them in, they are constantly allowed to remain on the branches of the laurels or other shrubs that have induced them to play truant. Once indulged with this license of selecting their sleeping-places according to their own pleasure, they are afterwards most difficult to be restrained. Although fowls roosting in shrubs and low trees are exposed to the severity of the weather, it is astonishing to see how little they appear generally to suffer. The peacock and the Guinea fowl, for instance, natives of a much warmer climate than our own, rarely seek the shelter of a roof; and young fowls of different varieties, in the highest possible condition, are often found who have, even up to as late a period as Christmas, never been within a building of any kind.

We cannot conclude this chapter without directing attention to the arrangement of poultry houses and yards adopted by the National Poultry Company, at their establishment at Bromley, Kent.

This company has been formed for the purpose of carrying on the business of breeding and fattening poultry on a large scale, in buildings specially erected for that purpose, and so constructed as to secure a tolerably even temperature throughout the year, conjoined with protection from the weather and perfect ventilation.

These buildings consist at present of a poultry establishment, 360 feet in length, with a corridor down the middle, the "homes" or runs for the birds being on either side. Each of the different breeds of fowls being placed in distinct compartments or homes, with an enclosed and an open run to each.

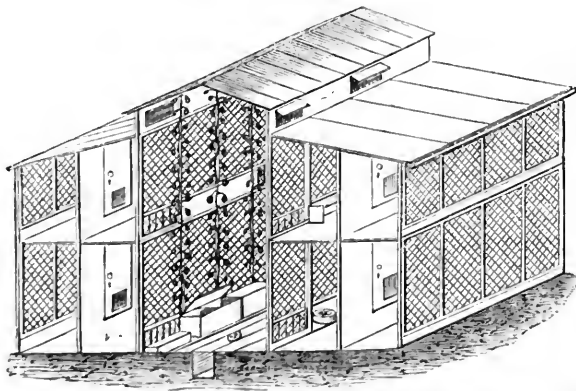

TRANSVERSE SECTIONAL VIEW OF NATIONAL POULTRY COMPANY'S FOWL-HOUSE.

The engraving shows a cross section of the building, and explains the arrangement and construction of the homes or runs. On both sides of the central corridor are the enclosed runs, each one being twelve feet in length, three feet in depth (from front to back), and six feet six inches in height. These runs contain perches

and ladders for the ascent of the birds. The floor is deeply covered with a thick layer of dry pulverized earth, on which the manure falls, and which acts as a most efficient deodorizer. The manure falling below the perches during the night is removed early in the morning, but that deposited during the day mingles with the dry earth covering the floor of the run, which consequently requires to be renewed at stated intervals. At the back of each closed run is an open run of similar size; this is covered with a layer of ordinary farm-yard straw manure, so as to afford the fowls exercise in scratching for food. The fountains are placed in the inner runs, and are raised on a shelf, so as to prevent the fowls scratching the loose dirt of the run into the water. The feeding-troughs are on either side of the long central corridor, and, with the laying-boxes, occupy the entire front of each run. Over the runs for the large fowls are situated others for the young chickens: these are of the same length and depth, differing merely in being less in height. The entire length of the building is constituted by a repetition of exactly similar compartments (two only being shown in the engraving), making up a total length of 360 feet, or 120 yards.

The interior of the corridor is used as a vinery, the vines being trained under the glass roof. At one end of the building is an excavation containing a furnace; from this an air-flue proceeds under the floor of the central corridor along the entire length of the building. In winter this will furnish a constant supply of warm, pure air, which will ensure the efficient ventilation of the house.

Each of the homes or runs is intended to accommodate six or seven fowls—a cock and five or six hens; it having been found by experience that if a larger number of fowls are placed in a run the dry earth becomes moist and ceases to deodorize the manure. The specimens of Houdan, Crevecœur, and La Fleche fowls are of very high excellence. At the present time the birds have been in confinement about six months, and are still in admirable condition—a state of things that may be attributed partly to the judicious system of feeding, but more particularly to the employment of dry earth in the runs. This has the effect of entirely absorbing all odour, and renders the air of the building purer than that of any ordinary poultry-house.

The ground on which the building stands is about six acres in extent, and it is proposed to cover it with ranges of houses placed sixty feet apart, each range being precisely similar to the one at present erected.

In order to render the whole concern as self-supporting as possible, the intervening spaces between the houses is to be cultivated as a market-garden, the fowls supplying the requisite manure to the gardens, and receiving in return the trimmings of the green crops, which will be minced up with their food. Animal food will be supplied in requisite quantity, and grain and meal in due proportion.

The experiment differs from many that have been previously tried; as instead of aiming at keeping a large number of fowls at large in a moderate space, it perfectly secludes each set from the others. As far as the experiment has been tested, it appears to have been successful. The building is sweet and wholesome, the air pure, the fowls in good condition, and laying very freely when the time of year is

taken into consideration. Whether they will continue in health for an indefinite period remains to be proved ; and the success of the scheme, as far as regards the number and fertility of the eggs, and above all the rearing of the chickens, are points that cannot be regarded as being definitely settled until after the experience of several breeding seasons. Whether the scheme be eventually successful or otherwise, it possesses considerable interest for the poultry-keeper : few persons would have supposed it possible to have carried off a first prize at Birmingham, as was done by the Poultry Company in 1865, with a pen of birds that had for six months previously been with four others the joint occupants of a space only twelve feet by six ; and yet these birds were shown in good condition and in perfect plumage.

To the great power of the pulverized dry loose earth in deodorizing the droppings, and so preserving the atmosphere of the poultry-house pure and free from any taint of decaying organic matter, must be almost exclusively attributed the success of this method of keeping fowls in health in a very limited space. We need hardly point out the importance of the suggestion to every intelligent poultry-keeper.

CHAPTER II.

FEEDING, AND THE COMPARATIVE VALUE OF THE DIFFERENT FOODS.

IN rearing fowls with any prospect of profit, a correct system of feeding is of the first importance, and it is most desirable to enter thus early on the subject, especially as the scientific principles of feeding are so frequently ignored.

The purposes served by food when taken into the body are of several distinct kinds: there is the production of animal warmth; the provision for the growth and waste of the body; the supply of mineral materials for the bones, and saline substances for the blood; and, lastly, the supply of fat.

The warmth natural to living animals depends upon the consumption of a certain portion of the food in the process of breathing. The substances consumed in this manner are chiefly those which contain a large quantity of carbon, which passes off in the breath, in the form of carbonic acid.

The most important warmth-giving foods are starch, sugar, gum, the softer fibres of plants, and oily or fatty substances. As the natural warmth of an animal in health remains the same at all times, it necessarily follows that a larger supply of warmth-giving food is required in cold situations than in those which are warm.

To supply the materials required for the growth of young animals and for the formation of eggs, as well as those required to repair the waste arising from the movements of the living body, a second variety of food is required; for the starch and other substances before enumerated have been proved, by direct experiment, to have not the slightest action in supplying these wants. Substances possessing this power are termed flesh-forming foods. The most important are the gluten, and similar substances, existing in variable quantities in different grains; in large proportion in the varieties of pulse, as beans, peas, &c.; and in the materials which form the solid parts of the flesh of animals, of eggs, of milk, &c. In consequence of these substances containing the element nitrogen, which is wanting in the other varieties of food, they are frequently termed nitrogenous foods; whilst the fat-forming and warmth-giving are called carbonaceous foods.

The minerals and the saline substances contained in the bones, and in other parts of the bodies of animals, occur in larger proportion in the bran than in the inner part of the grain. A due supply of bone-making and saline materials is absolutely requisite to the growth of a healthy animal; as, if wanting in the food, the bones become soft, and the general health speedily fails.

With regard to those substances which supply the materials for replacing the

waste or the increase of fat ; it is now well known that the starchy materials before spoken of as warmth-giving food are capable of being converted, by the living forces of the body, into fat ; nevertheless it is unquestioned that where it is desired to fatten animals rapidly (or to supply fat to be consumed in generating warmth, as is necessary in all cold regions) it is the absolute requisite that the food eaten should contain oily and fatty matters, which can be readily absorbed by the digestive organs, and either stored up or applied to the immediate wants of the body.

If we apply these principles to the examination of the various substances employed in feeding poultry, we shall arrive at a far more satisfactory knowledge of their real value for the purposes required than by acting on any empirical opinion as to this or that variety of food being more valuable.

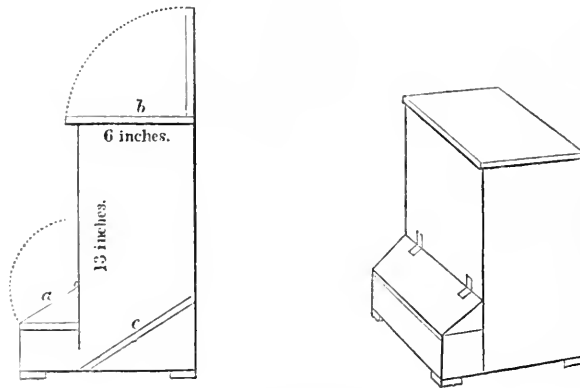

FEEDER FOR GRAIN.

a. A flap to be opened or shut at pleasure.—*b.* Hinged cover, through which the feeder is supplied.—*c.* An incline, throwing the corn, as wanted, into the feeding trough.

Grain of various kinds forms the chief article in the poultry dietary, and, of the different varieties of corn, barley is unquestionably more used than any other. This is evidently dependent on the fact that its cost by weight is less than that of either wheat or oats. Barley possesses a very fair proportion of flesh-forming substances—about eleven per cent.—but is remarkable as containing a less amount of fatty matters than the other varieties of corn. Barley-meal is identical in composition with the whole grain, as the latter is ground without the removal of the husk ; but it should be remembered that it is the inferior and cheaper samples which are so used.

Wheat is dearer both by measure and weight than barley, and in a sound state is seldom employed. Its capability of putting on flesh is not so much greater than that of barley as is usually imagined, and hence its employment is not so advantageous as is generally supposed ; the amount of flesh-forming food in wheat averages about twelve per cent. It fortunately happens for the poultry keeper that the small wheat usually purchased for fowls is in every respect the more desirable. To quote from the late Professor Johnston's *Chemistry of Common Life*,—"It is a point of some interest that the small or tail corn which the farmer separates before

bringing his grain to market is richer in gluten (flesh-forming food) than the plump full-grown grain, and is therefore more nutritious."

Oats are not so frequently used as barley, which they exceed in cost by weight. In purchasing oats it is exceedingly desirable to procure the heaviest samples, as they contain very little more husk than the lightest, and are consequently much cheaper, if the proportion of meal is taken into consideration; for example, a bushel of oats weighing thirty pounds consists of sixteen pounds of meal and fourteen of husk, whereas one of thirty-six pounds contains upwards of twenty pounds of meal and less than sixteen of husk. The lighter oats are frequently refused by fowls, and hence the low estimation in which the grain is sometimes held; but if soaked in water over night, so as to swell the kernel, none are refused. The amount of flesh-forming food is greater in oats and oatmeal than in any other grain, being about fifteen to eighteen per cent., and the amount of fatty substances is double that contained in wheat.

Indian corn is chiefly remarkable for the quantity of oil it contains, whereas rice consists almost entirely of starch, the amount of flesh-forming food being only seven per cent. As rice swells enormously when boiled, it is often erroneously imagined to be a cheap food. Granting that one pound of rice will, in boiling, absorb five pounds of water, it does not follow that there are six pounds of food; there is really but one pound, and that of inferior value, especially for growing chickens, as containing but little flesh-forming material.

Buck-wheat, which is very largely employed on the Continent as poultry food, is about equal to barley in the amount of gluten it contains.

All the varieties of pulse, as peas, beans, and tares, are remarkable for the extraordinary quantity of flesh-forming food and the small per centage of fat they contain. They may be regarded as too stimulating for general use. If fowls were required to undergo a great amount of bodily exertion, it would be desirable to treat them as the mining proprietors of South America treat their labourers, and make them, even if against their inclination, devour a feed of beans daily; but the result would be a hardening of the muscular fibres, and a firmness of flesh incompatible with a good table fowl.

Wheat meal and barley meal scarcely differ from the grain from which they are prepared; but between oats and oatmeal there is a wide distinction. The rejection of so large a portion of the husk, and the expulsion of moisture by kiln-drying, increases greatly the price of oatmeal, and, extremely advantageous as its employment undoubtedly is, it can only be used economically for fattening fowls and for the nourishment of the youngest chickens, for which it is the best possible food. Fine middlings, which are also known as thirds, or in London as coarse country flour, are very similar in their composition to oatmeal, and, employed with boiled or steamed roots, they are most advantageously and economically used. For this purpose small potatoes boiled or steamed may be used. We have found great advantage in employing mangold-wurtzel, boiled with a very small quantity of water until perfectly soft, and then thickened with middlings or meal.

When soft food is used, it is desirable to place it in a trough railed across at the top, to prevent it being trodden upon by the fowls. The feeders made by Crooks & Co., Carnaby Street, with loose, removable tops, so constructed that the fowls cannot stand upon them, are exceedingly well adapted for this purpose.

Animal food is sometimes given to poultry, and a little chopped raw meat is in many cases of sickness an admirable restorative; but when at large the insects and worms naturally obtained are far superior to any more artificial substitute. London tallow-melters are constantly advertising greaves as a food for prize poultry: we merely mention the fact to warn our readers against the use of this substance, as it rapidly throws fowls out of condition, and renders them unfit for human food.

The following tabular view of the composition of the various grains may be advantageously consulted, inasmuch as it may perhaps lead to an easier understanding of the relative value of the different kinds of food, it being borne in mind that all such statements are merely approximations to the truth, as the composition of grain varies considerably with the character of the season and the soil.

TABLE SHOWING THE COMPOSITION OF THE SUBSTANCES EMPLOYED IN FEEDING POULTRY.

Every 100 lbs. of	Fat or Oil.	Flesh-forming Food (Gluten, &c.)	Warmth-giving Food (Starch, &c.)	Mineral or Bone-making Substances.	Husk or Fibre.	Water.
Oats contains	6	15	47	2	20	9
Oatmeal	6	18	63	2	2	9
Wheat	3	12	70	2	1	12
Middlings	6	18	53	5	4	14
Barley	2	11	60	2	14	11
Indian Corn	8	11	65	1	5	10
Rice	A trace.	7	80	A trace.	...	10
Beans and Peas	2	25	48	2	8	5
Milk	8	4½	5	¾	...	87

If there is any one fact more decidedly ascertained respecting poultry keeping than another, it is that half-fed fowls cannot be made to pay. The old Latin proverb, "Ex nihilo nihil fit,"—"Out of nothing, nothing comes,"—is as true of fowl keeping as of all other things.

Fowls are either kept for the table or for eggs. In the former case, the object is to prepare the young birds so as to be fit for the market at the earliest possible period. It is evident that they are not only better in quality, but that they realize a larger sum, if they are well fed; and as young birds have consumed a smaller amount of food, on account of their shorter lives, they must of necessity return a larger profit than older ones. Eggs, again, can only be produced by the hens out of the materials furnished by their food. A scanty supply of the former is therefore the inevitable result of a short supply of the latter. In winter, when eggs are most valuable, this is particularly shown; for as there is then no insect or

other food to be obtained by scratching, the production of eggs diminishes remarkably unless the fowls are very well fed.

As regards the number of times the stock fowls should be fed, we believe the most economical mode is to feed twice a day. The fowls should be let out early in the morning; in fact, if there is no fear of foxes or other thieves, the hen-house had better be left open, so that the birds can come out at will. This they will do at daybreak, and, by wandering over the fields, secure a large amount of worms and insect food. They should receive their morning meal at a fixed hour; immediately after breakfast is usually a convenient time. It may be asked, How much corn should be given per head? We believe it is quite impossible to give to that question an answer that would be of any practical value; so much depends on the size of the birds; it is obvious that a Dorking of nine pounds weight, and a game fowl of five pounds, would require very different quantities of food. Again, the quantity must vary with the season of the year, much more being required to keep up the due amount of animal heat in winter than in summer. The work going on in the farm-yard, and the number of birds that are laying, will also influence the amount required to be given; for when a hen is producing eggs, she will eat nearly twice the amount of food that she requires at another time. The best rule, both as to quantity and time, is to give the fowls a full meal in the morning, and a second shortly before going to roost. Many persons feed their fowls only once a day, usually in the morning; the consequence is that they go to roost with empty crops, and as the nutriment they have obtained during the day is required to keep up the animal warmth, particularly during the long cold nights of winter, it cannot be employed in the production of eggs, and thus feeding hens once a day is not favourable to their fertility. It is necessary, therefore, to feed liberally twice a day, if any large amount of profit be desired from fowls. There is one great advantage dependent on having fixed hours of feeding; namely, that the birds soon become accustomed to them, and do not hang about the house-door all day long, as they do if irregularly and frequently fed. They consequently obtain a greater amount of food for themselves, and are less troublesome than they otherwise would be.

In addition to wholesome and abundant food, a supply of clean water is indispensable. Some kind of fountain is better than an open vessel, in which the water is apt to become dirtied by the fowls. A very cheap and convenient contrivance of this kind may be made out of an earthenware jar, and an ordinary glazed flower-pot saucer, by boring a small hole in the jar an inch and a half from the edge. When required for use the jar is to be filled with water, and the saucer placed bottom upwards on the top. Both together are then to be turned quickly over, when the water will be found to flow into the saucer to the same height as the hole in the side of the jar, as shown in the cut.

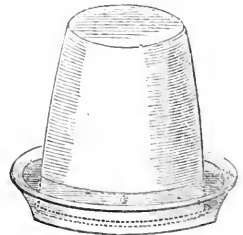

For those who desire a more elaborate contrivance of the same kind, the fountains of Messrs. Crook are to be strongly recommended. These pneumatic fountains are

far superior to those made in one piece, as they admit of being cleaned readily inside, which is not the case with those of the ordinary pattern.

Many of the most intelligent and successful rearers of chickens and pheasants are in the habit of administering to the young birds a chalybeate tonic in the water given them to drink; and they speak very highly of its good effects in those cases where broods are weakly, or where the young fowls are inclined to outgrow their strength. For this purpose an ounce of sulphate of iron (green vitriol), may be dissolved in a quart bottle of water, and two or three spoonfuls of this solution added to the water in the drinking-fountain, sufficient being supplied to give it a slight inky taste.

The effect of this chalybeate on the health and vigour of the birds is very marked; their combs brighten in colour, their appetite increases, and their general stamina is much improved.

CHAPTER III.

THE SITTING HEN.

THE cause of a hen's desiring to sit, or, to use the technical phrase, "becoming broody," is involved in the same mystery as other similar operations of Nature. The desire for incubation, from whatever cause proceeding, is frequently a great annoyance to the poultry keeper, who is often far more desirous of eggs than of chickens. Consequently many plans have been suggested to check this inclination. Some of them are cruel and absurd in the extreme—such as plunging the hen into a bucket of cold water, and keeping her there till half drowned; but the cruelty that can tolerate such practices is generally disappointed of its object; for the immersion of her warm body in the cold bath usually leaves the seeds of disease, which, in due time, bear their certain fruit, and justly punish the unfeeling owner.

If, from any cause, it is desired to prevent a hen sitting, the most effectual means we have yet discovered is to allow her to sit steadily on some nest eggs for a week. At the expiration of that time, she may be cooped for a few days; and if, on being liberated, she finds the nest that she was accustomed to destroyed, and the eggs removed, she seldom takes to another. But we do not believe that this provision of nature can be constantly set aside without injury to the bird. Her due batch of eggs having been completed, a period of rest to the whole system, and its productive powers in particular, is now required. This we disregard when we refuse to allow the hen to sit; and as she will again commence laying long before the period she would have done had she been allowed to hatch and rear her chickens, she is unduly stimulated, and a drain is caused on her constitution, which evidently must affect her at last. Occasionally, when we either want her eggs, or it happens at an improper time of the year, such as at the end of autumn or winter, we should not, of course, allow her to gratify her inclination; but with such fowls as manifest this desire, we should consider that one brood of chickens at least in each year is desirable to keep them in health and vigour. We have, indeed, often seen Cochin hens in apparent health, to whom this license has been again and again refused, and the immediate ill effect obviated by a judicious system of feeding. Yet we must still think that our birds would remain longer in a productive state, and be in better health, if they were permitted to enjoy an occasional relaxation from the egg-producing process.

If the hen about to be entrusted with eggs be of our own flock, she has probably made her own selection of a nest; and where this is not incon-

veniently situated, we should do well in allowing her to retain possession; for, if we move her, she may be rendered restless, and, in endeavouring to regain the place of her own choosing, may afterwards desert the eggs. Where, however, she is a stranger, brought to us for the purpose of hatching out a brood, it is generally a matter of uncertainty how far she will approve the change and steadily discharge her duty. We have had hens that took immediately to their nests when first brought to us; and some, on the other hand, that no arrangement for their comfort could induce to continue the occupation that they had commenced elsewhere. There is another inconvenience attached to hens thus brought to us from other places—and that is, when their chickens are hatched, they, as strangers to their companions, are liable to attack, or be attacked by, every hen about the place, and manifold evil consequences to themselves and their progeny are the result.

In large fowl-houses, where hundreds of poultry are kept together, a separate sitting house should be provided. If this could be so arranged as to be merely separated by wire or lattice-work from their usual abode, and the hens were placed in it so soon as they showed a tendency to sit, the neighbourhood of their companions would reconcile them more quickly to the change, and there would be less difficulty in getting them to sit closely. It is absolutely necessary, however, to secure them from the incursions of the other fowls; and this the intervention of the lattice or wire-work would effect. Where three or four hens and a cock are the sole tenants of the house and yard, there are usually spare nests, where the eggs can be placed without risk of injury. To make them the more secure, however, it would be well to keep the hen shut in for a day or so, when any other fowls that might have been in the habit of laying there would have chosen another place.

It is the practice of many persons who have numbers of sitting hens to remove them from the nests at a stated hour daily, the morning being the preferable time; they should then be supplied with barley, *ad libitum*, and clean water; if practicable, they should be permitted to have access to a grass run, and, under all circumstances, allowed to avail themselves of a dusting place. Where there are many hens sitting this plan is advantageous, as it ensures each being fed, and prevents the eggs being cooled by the lengthened absence of the hen at times when no food is being given. Many persons also confine their sitting hens either by shades in front of the nests, or by placing coops over them if on the ground, the object being to prevent their being disturbed by the intrusion of fowls that are desirous of laying in the same nests.

As to the exact description of nest which would be most suitable for the sitting hens, almost every poultry keeper has some favourite arrangement of his own; and, provided some two or three requisites are complied with, no great harm is likely to result from his indulging in it.

The recess in the unused manger, and the concealed nook in the cart-shed, have great attractions to many hens; and, but for the chance of accident from the

exposed situation, a better clutch may perhaps be expected than the more artificially constructed nest will always ensure.

Many of the most successful breeders prefer having the nests formed on the ground, by placing a little soft straw in a slight hollow; whereas others give a preference to nests raised some few inches from the ground, solely on account of the greater facility for the house being kept perfectly clean, by allowing the broom to reach beneath.

But after all it cannot be denied, when we look at the secret places sometimes selected by the hen herself for incubation, and observe that, at the expiration of the allotted time, the number of young led forth tallies pretty nearly with that of the eggs deposited, that fewer eggs are to be found in an addled state in such circumstances than when they are selected and placed under the intended mother. We have reason to believe, indeed, that whatever care may be taken in keeping eggs, their vitality is better preserved when they are allowed to remain in the nest. Perhaps the periodical visits of the hen while adding to her store of eggs has a stimulating influence. The warmth communicated in the half hour during which she occupies the nest may have a tendency to preserve the embryo in a vigorous state.

The Cochins possess one great recommendation as sitters, in the soft and abundant supply of downy feathers that so specially distinguish their race; for under no other hens do the eggs appear to maintain a higher or more constant temperature.

From the shortness of their legs and the density of their fluff, the best breeds of Cochins are especially suited for sitting. They will thoroughly cover thirteen of their own eggs; and though the larger varieties might be equal to a greater number, thirteen would, in all cases, probably be a wise limitation, and result in the best and healthiest broods. An egg imperfectly covered by the hen while sitting becomes chilled, and, as all in turn are likely to be thus more or less exposed, the whole brood often suffers from the unwise desire to get an extra chick.

When very early broods are required, either for exhibition in the chicken classes at the summer poultry shows, or for table use, every precaution should be taken to keep up an adequate temperature. The nest should be based on a deep foundation of ashes or earth, or a thick freshly-cut turf may be placed beneath the straw; by these means the escape of the heat is greatly prevented, and consequently a more uniform and higher temperature secured. The number of eggs also should be much reduced, seven or eight being an ample number during January and February, as, even supposing a larger number of chickens to be produced, they suffer greatly when about a month old, from being inadequately covered by the hen at night.

For the purpose of securing early broods, it is necessary to retain a sufficient number of early hatched pullets of the previous year. These generally begin to lay, if well fed, about November or December, and become broody in January or

February. The prejudice against setting young hens is not founded on observation, for we have invariably found that they sit equally well with older birds.

When hens lay away, and escape discovery in so doing, the number of eggs laid before they sit is usually found to vary from nine to eighteen. If there are more, it is almost always a partnership business. Where it is desirable to induce a hen to sit early, her eggs should be left with her; and so soon as the number, be it more or less, appears satisfactory to her, she is generally eager to commence her task; but this requires the bird to be kept by herself, or at least where others are not in the habit of laying in the same nest. When the hen takes to her nest, it is best to let her remain there, giving her three or four new eggs to sit on to test her steadiness for a day or two; for at times they commence somewhat irregularly, coming off two or three times during the first day or so, and often going to perch the first night, though they had occupied the nest during the whole day. At the end of this period—or earlier if she manifests continued steadiness—the nest being duly prepared, the eggs may be given her, and this is most quietly accomplished by lifting her off at night, when the eggs may be placed in the nest, and the hen replaced, without any risk of their being broken by her struggles.

Good sitters seldom or never leave their nests more than once a day, provided they are well fed when they come off; and they seldom remain away longer than from a quarter to half an hour, rarely exceeding the latter period, unless food has not been supplied and they have to forage for themselves.

The time a sitting hen may remain absent from the nest without injury to the eggs depends on so many contingent causes, such as the season of the year, and the particular stage of development at which the embryo has arrived, that it would be impossible to give a decided statement. An absence of from twenty minutes to half an hour is as much as should be encouraged; but this may often be prolonged to several hours without the inevitable destruction of the brood. It is well known to comparative anatomists that, during development, the embryo passes through all the phases of animal life, beginning with the simplest, and gradually becoming more and more complex in its organization; so that if it were possible to arrest its growth at any intermediate day and sustain its life, an animal of lower class would be produced—a circumstance that yearly occurs before our eyes in the case of the common frog, the eggs of which hatch, not into air-breathing reptiles, with lungs, but into lungless fish, familiarly known to us as tadpoles, and respiring by means of perfect gills. In the simplest forms of animal existence life can be maintained at a much lower temperature than in the higher; and, therefore, at the earlier periods of sitting the hen may be absent for a prolonged time without injury, whereas a much shorter neglect of her duties would be fatal nearer the day of hatching. But where we found a hen careless of her charge, and requiring to be frequently driven towards her nest, we would avoid employing her again as a sitter. We have had hens, however, in our possession whom we have, day by day, been obliged to take off, as no inducement was sufficient to lead them to do so of their own accord. Doubtless the main object in this periodical excursion is to obtain the necessary

sustenance for supporting life in the bird herself. But another object is also served; for by the contraction of the air in the air vesicle, when the hen leaves the nest, and the eggs are cooled, a fresh supply of air enters, which we may suppose advantageous to the enclosed chick; and it has been found desirable, by those who have employed artificial incubators, to remove the eggs from the machine during half an hour daily, so as to imitate, as far as possible, the natural cooling.

It is desirable daily to examine each nest when the hen is off. An egg may be broken, and the fragments of the shell may dry on the others in places where the first efforts of the young chicks to free themselves may be attempted; and this double casing proving too much for their beaks, they may eventually die in the shell. Whenever the nest is found in a dirty state, from this or any other cause, take a bowl of tepid water, and with a piece of flannel wash the eggs, gently removing any substance that may be found adhering to them, replacing them again in the nest, having previously furnished it with clean straw. Do not let the temperature of the water exceed that of new milk, and, when perfectly dry, get the eggs under the hen at once, so that no chill may happen. It is unnecessary to add that, where this is neglected, the fetid atmosphere produced by the decay of the contents of the broken eggs is as injurious to the prospective chickens as offensive to the proprietor. In this daily inspection, count the eggs over, so that if by accident another hen may have gained entrance, her egg may be at once removed,—the originals having been duly marked in the first instance by making a ring with ink or pencil around their circumference, which is visible in every position of the egg. If from any cause the egg of a valuable fowl has been slightly cracked within a few days of hatching, it may be worth while to plaster up the fracture with a piece of paper and gum, or the edge of a postage stamp, as numerous instances are on record where such eggs have hatched in due time, and the progeny flourished.

Our own practice is to examine the eggs at the end of a week, and remove those not fertile; this is readily accomplished by taking a candle into the sitting house at night, and on holding the eggs near the flame, sheltering the eye at the same time from the direct action of the light, the sterile eggs are readily distinguished, being correctly described by the adjective *clear*, which is usually applied to them; those which are fertile are at that time perfectly opaque. A little practice renders the distinction easy. The clear eggs being removed, more room remains for those that are fertile, and they receive a greater share of warmth. Those who follow this plan will find it advantageous to sit two hens on the same day, and if, on examining both nests at the expiration of a week, many sterile eggs are discovered, the whole of the remainder may be given to one hen, and a fresh setting placed under the other.

In Cornwall, it is usual to test the eggs on the eighteenth or nineteenth day, by placing them in a bowl of tepid water; those containing living chickens are in immediate motion, bobbing and reeling on the smooth surface,—for the vessel must be kept perfectly still. These are wiped, and returned to the hen, the others being

rejected; but when the clear eggs are removed on the eighth day, the proceeding is not required, and from the hazard of chilling the eggs by too low, or injuring them by too high a temperature, the plan is, in our opinion, decidedly objectionable.

Hens' eggs are said to hatch on the completion of the twenty-first day; but where the eggs are fresh, the sitter attentive, and the weather warm, this period is frequently reduced by several hours. We should think the brood likely to turn out an indifferent one if, when the eggs were placed under the hen at roosting time, it did not present many chipped eggs at least on the evening of the twentieth day; and the next morning the majority should be out and strong. The chickens are constantly heard chirruping within their prison some hours before the least sign of their beaks is visible, during which time they are at work upon their covering. Where the young bird is vigorous and healthy, it works round the top of the shell till it has cut out a sort of flap or cover, dividing the shell into two unequal parts; the smaller one is pushed back, though on one side it is attached by the interior membrane to the larger; in this manner exit is effected. In the morning the two parts are constantly found packed away, one within the other, occupying the smallest possible amount of room, if the hen has not already ejected them.

“Let well alone” is here a wise maxim; but our rule is to examine how matters stand when the period of twenty-one days has passed; and if eggs are found billed, but the chickens within in a weak state, assistance should be given by widening the breach. If eggs are found without any indication of life within, but apparently not addled, break the shell cautiously and as near the usual position of the bill as possible; but we are commonly presented with a dead chick, or one where from weakness the yolk has not been properly absorbed. Its chances for life, therefore, are but slight. Strong, full-grown chickens are at times found lifeless, from inability to break the inner film, which in many cases would seem to present more difficulty than the shell itself.

It is convenient to have two hens hatching at the same time; for not only if accidents happen may the two broods be united, but on the hatching day it constantly occurs that, to prevent the newly born chicks being crushed by eggs that are behind time, we wish to give all that are hatched to one hen, while the other takes charge of the eggs alone. Not only does this give security to the chicks, who run great hazard of being crushed by the eggs if they are kept for any prolonged space under their mother, but the unhatched eggs also stand a far better chance; for when a hen finds chickens under her, she sits higher from the eggs, and less warmth is afforded them at the time they require most.

Having spoken at length of the sitting hen, it may be thought desirable to enter into the consideration of the various incubators designed for the purpose of hatching eggs by artificial heat.

A very compact apparatus of this kind, for those who desire to experiment on a small scale, has been designed by Messrs. Crook, of Carnaby Street; and other large incubators acting on the same principle have also been designed.

We have recently been requested to examine the construction and mode of action

of one which is the subject of a new patent by Mr. Minasi, and which appears in its present state to be as complete and as successful in its working as it is possible for any instrument of the kind to be.

The heat necessary for the incubation of the eggs and rearing of the young chickens in the earlier stages of their growth is derived from gas, or from the combustion of naphtha in a lamp so constructed as not to require attention for many days. The heat so generated warms a reservoir of water, the under side of which is corrugated in a very ingenious manner, so as to support, by the aid of wires, a series of small narrow sandbags, against which the eggs are pressed. The close contact of the whole of the eggs (whatever may be their variation in size) with the warm sand is insured by their resting on cushions of spiral springs; these are contained in drawers or sliding trays, which can be easily drawn out from under the incubator

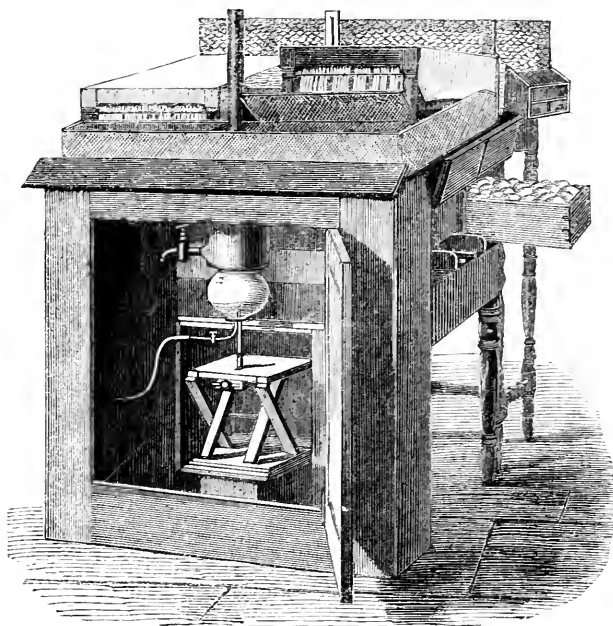

MINASI'S PATENT INCUBATOR.

for the purpose of examination. As the eggs hatch they are removed to a part of the apparatus above the reservoir. This is most ingeniously constructed: there is a small tray for the chickens until such time as they are thoroughly dried and strong, when they are passed under a kind of artificial mother, which is peculiarly constructed in imitation of the plumage of the hen. It consists of a number of woollen wicks, each about four inches in length; these hang down loosely between the legs of low stools placed over the warm reservoir. The chickens nestle between the pendant locks of wool, which thus form an admirable imitation of the warm feathery plumage of the parent hen. Connected with this part of the apparatus is a large feeding cage, into which the chickens run for food, water, and exercise.

Our readers may form an accurate idea of its general character and structure from the engraving, representing a 200 egg machine, with four drawers, each capable of containing fifty hens' or seventy pheasants' eggs. In the woodcut one of the drawers is shown partly pulled out, and under the nearer drawer the ingenious but simple lifts by which it is raised to the required height are shown. In front are the two artificial mothers, one of which is raised up to show the depending locks of wool. These are both covered with flannel. In front is the hatching tray, and the feeding cage is shown at the back. The stool by which the gas or lamp is raised to the required height is seen through the open door; the chimney to carry off the products of combustion from the lamp, and the thermometer by which the temperature is regulated, require no further description.

We have recently seen one of these machines in active operation, and examined and handled many of the chickens hatched by it, some of which had been reared by the machine itself, and others under hens. The chickens were of all ages, and were strong, healthy, and vigorous. The same may be said of the ducks, guinea-fowls, and pheasants which had been hatched in the machine. We did not see one sickly or diseased chicken of any age in the large poultry yard attached to the establishment, and can therefore recommend the apparatus as well adapted for hatching, where numbers of fowls or pheasants are required.

Mr. Upham, of 5, Houghton-place, Harrington Square, is the proprietor of the patent.

CHAPTER IV.

STRUCTURE AND DEVELOPMENT OF THE EGG.

BYOND the fact that an egg consists of yolk, white, and shell, little is popularly known respecting its structure ; and even a less amount of knowledge prevails regarding the changes that occur in it during the development of the embryo. In these, as in all other cases, ignorance leads to serious errors in management, and consequently to severe losses in practice. We have therefore deemed it desirable to enter somewhat more fully than is usually done in popular works into the consideration of this interesting subject.

The first part that claims our notice is the shell. This, which usually weighs about one-tenth of the entire egg, is formed of carbonate of lime, the same substance that, in a different state of aggregation, constitutes marble, chalk, and old mortar. The materials of the egg-shell do not, however, form a uniform layer, but are arranged in such a manner as to leave pores, or minute apertures, through which the moisture of the egg can evaporate, and the external air gain entrance to support the breathing of the unhatched chick. The particles of carbonate of lime are arranged in somewhat the same manner that the bricks are placed in a dome or arch ; by this means enormous strength is given to the shell. It may, perhaps, surprise many persons to be told that the strongest man cannot crush an egg if his strength be fairly and uniformly applied. This experiment is soon tried by placing an egg endways between the palms of the hands ; it will be found that the greatest exertion fails to crush it when it is fairly placed and evenly pressed from end to end. As this strength, however, would render the exit of the young chick a matter of great difficulty, an exquisitely beautiful provision of Nature is arranged in order to permit it to find its way out of

“ that antenatal tomb,
Where the young bird dreams of the life to come.”

The structure of the shell that gives its great strength to the fabric is entirely disarranged during the process of incubation ; at the period of hatching the particles of carbonate of lime are confused together, and have lost all their regularity of arrangement ; hence the egg-shells at this time become very brittle, and the exit of the young bird is easily accomplished. So different is the arrangement of the particles in the shells of hatched and unhatched eggs that they can readily be distinguished by microscopic examination. It is this peculiar change of structure

that causes the cracked sound that is given out on moving together the eggs in a nest when they are nearly hatched.

Inside the shell is the membrane or skin. This, which is formed of delicate interlaced fibres, appears single, but is in reality double. The two skins separate at the larger end of the egg, forming an air-chamber, the size of which is a very good criterion of the freshness of the egg. When first laid, this air-chamber is not larger in extent than a threepenny piece; but as the egg is kept the moisture evaporates through the pores of the shell, and as the fluids diminish, air necessarily enters to supply their place; hence the air-chamber gets larger and larger, so that on breaking the large end of a stale egg we sometimes see a cavity that seems to occupy a quarter of the shell. In the dispute between the Big-endians and the Little-endians, immortalized by Swift, the Big-endians most certainly had the best of the argument, for by opening the egg at the large end we can see its degree of freshness, an advantage which could not be claimed for the method advocated by the Little-endians.

Inside the skin or membrane is the substance known as the white of the egg; this is a thick glairy liquid, forming, usually, more than half of the entire weight. Most persons imagine that the white is uniform throughout, but in reality it possesses a peculiar structure, being arranged in layers like those constituting the coats of an onion; these layers, which are firmer and more dense towards the centre, can be readily seen, and separated from one another in the white of a hard-boiled egg. The difficulty of mixing white of egg with water or other liquids depends on the existence of these layers, which must be broken down or "beaten up" before it can be dissolved.

The white is formed of a peculiar animal substance, termed by chemists *albumen*, and water. This albumen possesses remarkable properties, rendering it of great value, not only in cookery, but in many of the chemical arts. It forms a very large proportion of many parts of the bodies of all living animals, and is eminently nutritious. Beaten up with water it dissolves, and hence it is termed soluble albumen, but when heated to a temperature of about 180° Fah., that is to say, thirty-two degrees below the boiling point, it alters its character, becomes opaque, white, solid, and is no longer soluble. Even a weak solution cannot be heated to the boiling point without the albumen it contains coagulating and forming flocks, which separate from the liquid in a solid form and rise to the surface as a scum. On the other hand, if the white of egg be dried at a moderate temperature, it forms a pale yellowish substance, remains unaltered in its properties, and can be dissolved in water again without change.

The remaining portion of the egg is known as the yolk, or yelk. This consists of albumen and water, mingled with a very large proportion of yellow oil; the whole being so intimately mixed as to be eminently digestible. The yolk, in fact, is designed by Nature to form the first food of the chick at the period of hatching, and is one of the most nutritive of all known articles of food. The yolk is enclosed in an exceedingly delicate membrane, which prevents its admixture with the

white. In breaking a number of eggs into a basin there may be observed a small circular speck on each yolk. This speck is the rudiment of the young chick, and the construction of the egg is such that on whichever side it is turned the rudimentary germ is always uppermost, so as to receive the heat from the breast of the sitting hen. The mechanism by which this is managed is very simple: the lower side of the yolk is weighted or ballasted by two twisted heavy masses of very firm albumen, termed the chalazæ, which, hanging down, keep the germ constantly uppermost, on whichever side the egg may be laid. Contrary to general belief, these ballasting weights are found in all eggs, whether laid by pullets or old hens.

If an egg has been sat on, even for a few hours, the size of the germ is increased, and if left in the nest of a sitting hen for twenty-four hours, small blood-vessels may be seen, forming a beautiful zone around it. It should not be imagined that the yolk is a mere unorganized liquid; it is composed, like the white, of concentric layers, which may be seen when it is boiled hard; and from the germ a tube runs to a central hollow cavity—that is also often to be noticed when an egg boiled hard for salad is cut across.

When a fecundated egg is placed under a hen, or deposited in an incubator and subjected to a temperature somewhat above 100° Fahrenheit, the germ undergoes a remarkable series of alterations, being gradually developed into the perfect chick. During the period required for the complete development, various chemical and physical changes occur, the most important of which may be briefly alluded to. The air-vesicle at the end gradually becomes larger in proportion as the water of the albumen evaporates through the pores of the shell. During the development of the chicken, its nourishment is derived chiefly from the yolk; and shortly before birth the remainder of the yolk is drawn into the abdomen, and passing into the digestive canal, constitutes the first food of the newly-hatched animal. During incubation, the blood of the chick is aerated by passing through a series of vessels in a temporary respiratory membrane which lines the porous shell; this makes its appearance on the third day, and gradually extending, gives rise to that opacity of the fertile egg which has been already alluded to. It is not until the nineteenth day of incubation that the beak of the chick ruptures the enlarged air-vesicle, and it then first commences to breathe by means of its lungs. This is accompanied by a peculiar sound; and we feel much indebted to the late Dr. F. R. Horner, of Hull, for the following abstract of a paper on this subject, which was read by him before the British Association for the Advancement of Science:—

“I think the POULTRY BOOK the fittest medium for the promulgation of a fact, or rather discovery, on a subject concerning which views altogether erroneous prevail; I mean the manner in which the chick first breaks, and liberates itself from, the shell.

“It is universally believed that the continued ‘tapping’-like sound, so perceptible within the egg, is produced by the bill of the bird constantly striking or coming in contact with the shell in its efforts to break it. Indeed, philosophers

and naturalists, both of this and other countries,—even those who have most recently written on the development, &c., of the chick,—have stated that such is the case; whilst the latest authors on Poultry continue the same error. ‘The tapping which is heard,’ writes the author of ‘Domestic Poultry,’ ‘and which opens the prison doors, is caused by the bill of the enclosed chick;’ similar language being employed by all others.

“Though opposed to the many great authorities who have written on this subject, and opposed, also, to the adopted views of all, I do not hesitate to assert, in contravention, the facts as observed by myself, especially as such facts can be so simply and so readily tested and substantiated by every one.

“Whilst recently engaged in some investigations concerning the young chick at various periods of its growth in the egg, I was led to doubt the correctness of the common explanation of the (so-called) tapping-like sound, from observing, first, that it was so continuous, or prolonged, it being heard for about forty-eight hours before a fracture in the egg was made, thus involving an amount of labour and effort on the part of the young tenant not commensurate with the small effect produced—a small fracture, when the whole remaining circle of the egg could be seen to be broken often in from two to six hours; and, secondly, as the slightest scratch or tap with the nail, or similar hard substance, on an egg, produces, when the ear is applied, a very much louder sound than that made by the chick, I considered that the tapping, if really produced by strokes of the bill breaking the shell, ought to be threefold more distinct and louder than they really are.

“The facts are simply these:—The so-called repeated ‘tapping’ is not caused by the stroke, nor by any other mode of contact of the chick’s bill with the shell—it is simply respiratory, and produced during the expiration of the breath. Perhaps the more homely words, ‘clicking,’ or ‘smacking,’ would more accurately define the sound; it exactly resembles that which may be made by puffing small quantities of air through the closed lips, as in the act of smoking; and, indeed, from my own observation, I conclude that it is produced in a manner analogous, by the air passing, at each expiration, through the lungs of the tender chick.

“It is further observable that the so-called ‘tapping’ sound begins to be heard, though indistinctly at first, at that very period of incubation at which physiologists state that air first enters the lungs, viz. on the nineteenth day, or two days before hatching. I also remarked that the sound in question was sometimes heard, not as a single, but as a double sound; the latter of the two being louder than the former, and thus corresponding to the expiration and inspiration of the breath.

“I perceived that the egg was really broken (at first with a star-like fracture) by occasional smart blows with the horny tip of the bill, and which impinged, with no inconsiderable power, against the shell, as any one may satisfy himself by placing the ear close to the opening just made. At the period of hatching the chick obtains great additional space in the egg, by which it is enabled to make enlarged efforts. Thus, by the nineteenth day (by which I mean two days before it liberates itself), it is seen to occupy the smallest space in the egg; nearly one-third, at the larger

end, is at this time filled with air only ; but now, by its frequent struggling efforts, the chick gradually works itself up till it fills the whole space ; and by this partial unpacking, as it were, of itself, acquiring more liberty for action.

On pressing the egg against the ear it will be found that the young chick breathes, when first heard, about eighty times in a minute, as denoted by the 'tapping,' or respiratory sound ; but afterwards generally not more than sixty. It makes the struggling efforts five or six times per minute, while the sharp strokes with the bill, by which it breaks the shell, are repeated at unequal intervals of from one to five minutes : I perceived that sometimes these strokes were repeated in immediate succession. The action of the heart is so rapid that it cannot be counted with accuracy.

“ The chick gradually works itself round in the shell during its struggles, breaking it in its progress, till at length the lid-shaped upper portion of the shell is detached. In this process the 'tapping,' or breath sound, generally, though not always, continues ; and any one may, at this stage, satisfy himself by observation that it is only by the occasional blows with the bill, suddenly and forcibly made, and generally at the commencement or at the termination of the struggle, that the shell is broken.

“ I shall now detail the simple expedients by which I proved that the 'tapping' was not caused 'by the contact of the chick's bill with the shell.'

“ I broke a small hole in the round end of the egg, when the 'tapping' was distinctly audible. M. Reaumur, unluckily, attempted to satisfy himself as to the cause of this sound by holding the egg before the light of a candle ; had he broken a hole in the shell, when he examined it, he would have avoided his error. By this means I saw the bill *in situ*, and plainly perceived that, though the sound continued, the bill itself did not come in contact with the shell. Nay, in some early instances, the sound was heard before the bill was visible, or had protruded through the enveloping membrane. To satisfy myself again I watched in other examples, till a small fracture had been made in the shell by the chick ; this breach I then enlarged considerably, breaking away the shell so as to bring the bill of the chick into open view—to isolate it, indeed, and to prevent the possibility of its coming in contact with the shell—still the same 'tapping' sound continued as before, and, as I now clearly saw, was produced solely by the breathing of the chick. Further remark would be wholly superfluous.

“ It appears to me probable that the reduction in the frequency of the tapping or noisy respiration, soon after I had made an enlarged opening in the shell, was dependent upon the free admission of the pure atmospheric air, by the vivifying influence of which the respiratory organs speedily gained a more perfect and normal action. In some cases the sound ceased for a while, when a free aperture had thus been made ; and the chick gaped widely and repeatedly, as if expanding its lungs with air. In the weakest chickens I generally found that the respiratory sound was most continuous ; indicative, I conceive, of less power in the respiratory organs to gain a more perfect action.

“As a still stronger proof that this sound is respiratory, I found that by placing the ear or the stethoscope against the breast or back of the chick the day after it was hatched, precisely the same sound was heard, proving incontestably that it is caused by the transmission of air through the lungs. It is, indeed, nothing more than the natural respiratory sound in the lungs of the young chick.”

Having devoted so much space to the consideration of the structure of the egg, it may be desirable to make a practical application of the knowledge, and describe the best method of keeping eggs, both for culinary and hatching purposes. When exposed to the air an egg soon loses its original freshness, in consequence of the escape of part of its moisture, and the consequent entrance of air. This evil may be prevented in several modes. One of the least troublesome is to grease the surface of fresh eggs intended for cooking, and so close the pores. It is not very material what grease is employed, provided it is fresh and sweet. Butter is, perhaps, the least desirable, as it contains curdy matter, which becomes tainted after long exposure to the air. Lard, or melted suet, is better, and in France melted bees'-wax and olive oil is sometimes employed, and answers remarkably well. Another mode of preventing the access of air is to plunge the eggs into a thin creamy mixture of freshly slaked lime and water, in which they will keep good, for pastry purposes, for many months.

Eggs intended for hatching should be kept in a situation where the evaporation of moisture through the pores of the shell is prevented as much as possible. Placing them with the larger end upwards in a box, with bran, is a very common mode of keeping choice eggs intended for hatching. If the eggs are to be kept any length of time the position is a good one, as the presence of the air-vesicle and chalazæ prevents the germ rising to the top and adhering to the membrane of the shell. The extreme care sometimes bestowed on eggs intended for incubation, however, is quite unnecessary. The yolk is so perfectly suspended that no injury can occur to it by any violence likely to be suffered by the egg, short of actual breakage. Eggs have been hatched in England that were laid in America, the vibration and shaking to which they have been submitted on the voyage not having injured the vitality of the delicate germ. Nor can a uniformity of temperature be considered requisite: no other eggs hatch so well as those laid by the hen in a nest hidden in some hedge or coppice; these are necessarily exposed to great alternations of temperature prior to the hen's becoming broody,—alternations arising from the differences of the heat of day and night, and from the hen warming up the whole batch on laying every additional egg.

We believe that by keeping the eggs covered so as to prevent the loss of the internal moisture by evaporation we have done all that is requisite in ordinary cases. Should we be desirous of keeping eggs an unusual time, we think that the employment of air-tight jars perhaps offers the best mode of proceeding. Those with patent air-tight stoppers, sold by Messrs. Crook, of Carnaby Street, are eminently adapted for this purpose.

With regard to the transport of eggs intended for hatching, there is no plan so

desirable as packing them in hay, in a basket or small hamper. The hay by its elasticity prevents any of the eggs being broken, and they may be conveyed hundreds or thousands of miles without injury. If packed in a box with bran, sawdust, chaff, or oats, as frequently adopted, the continued vibration to which they are subjected on the journey shakes the packing into smaller compass, and the eggs are liable to come in contact and be broken.

CHAPTER V.

THE MANAGEMENT OF CHICKENS.

IN rearing chickens, as in all other operations of the poultry yard, the nearer we can imitate nature the better. A hen that has "stolen" a nest invariably brings out a strong and healthy brood, although there is no poultry maid to remove the first hatched chicks, and place them in a basket by the side of the kitchen fire. We believe that all interference with fowls at the period of hatching is especially undesirable. Many hens resist any examination of the eggs, especially when their maternal instincts are excited to the utmost by the chirping of the chicken beneath them. Cochins, perhaps, may submit to have egg after egg pulled out and examined, but few other varieties will allow of any interference at this period.

We are quite certain that more chickens are destroyed by the struggles of the hen, and by untimely assistance, than are saved by any aid that can be rendered at the period of hatching by the hand of man or woman either.

Chickens require neither food nor drink on the day on which they are hatched; in fact, both are injurious, as they interfere with the natural digestion of the yolk, which is absorbed into the bowels at the period of hatching, and constitutes the first food. If grits, oatmeal, &c., are spread before the hen on the twenty-first day, she is induced to leave the nest, and the last-hatched chickens are unable to follow, and, being weakly, perish. Whereas, if undisturbed, the hen seldom leaves the nest on the twenty-first day, and on the twenty-second day the chicken will be found strong enough to follow her.

The plan of cramming peppercorns or grains of barley down the throats of newly-hatched chickens is exceedingly injurious. The best food for newly-hatched chickens is two-thirds sweet coarse oatmeal and one-third barley meal, mixed into a crumbly paste with milk or water; the chickens make surprising progress upon it; they are also very fond of a little cold oatmeal porridge, and, by way of variety, they may sometimes have a few grits given to them.

Milk is frequently used to mix the barley or oatmeal, but it soon becomes sour in summer, and is decidedly injurious if employed in that state; no more food, therefore, should be mixed with milk than can be eaten in a few hours. Sopped bread is by no means desirable: it does not appear to afford the necessary resistance to the natural grinding action of the gizzard, and consequently the chickens soon become weakly and affected with diarrhœa from its use.

In order to satisfy the hunger of the hen, which is usually very great when she

leaves the nest, it is very desirable to give her as much corn as she can consume, when, having satiated her own appetite, and quenched her thirst, which at this time is considerable, she will brood over her callow young and keep them at rest whilst they are digesting the yolk that has been absorbed just before hatching. After the first few days some whole corn, such as small-tail wheat, or some barley, may be given to the young brood; and disproportioned as the size of the grains may appear, it will be found that they will be greatly relished, and doubtless afford a wholesome exercise for the extraordinary grinding power of the gizzard.

It is scarcely necessary to state that it is requisite that chicken should either have a constant supply of food or be fed at very short intervals. The first food should be given at daybreak, and if the birds are hatched in the very early part of the year they must be fed in the after part of the day, by candle light, if rapid progress be desired.

With regard to animal food, there is none equal to the natural supply of worms and insects obtained by the hen; small worms, or a barrow full of mould containing an ants' nest, may be given if the chicken are in a confined situation, and will be found far superior to boiled egg, chopped meat, or any more artificial substitute. Chopped curd, frequently used, doubtless furnishes the very best substitute for the natural insect food.

The plan frequently adopted by gamekeepers who are rearing pheasants, of hanging up a large piece of horse-flesh, in order that the young birds may have a plentiful supply of maggots, is by far too offensive to be employed near a dwelling. But it may be so far modified as to be employed in an innoxious manner, and with great advantage. If any dead animal be exposed for a few days during spring or summer, it will soon become a nidus for the eggs of the common blow-fly. In this state it may be buried about a foot deep in some dry corner of the poultry yard. Under these conditions the eggs of the fly hatch, the maggots grow to their full size, and then, preparatory to changing into pupæ or chrysalises, work their way to the surface; in this condition they are soon devoured by the fowls, and furnish an admirable supply of animal food for a clutch of chickens.

Cooping, which is so frequently employed to restrain the wandering of hens with chicken, is not desirable. In many cases it is a necessary evil, but not the less an evil; a hen, when cooped, has no power of scratching for insects and worms, which are the best of all possible food; the chicken are therefore confined strictly to the artificial diet with which they are supplied. Another objection to the employment of coops is that the hen does not so soon recover the effects of her confinement in sitting as when she is allowed her liberty and obtains green food to peck at.

It is frequently said that when hens are not cooped they roam so far that the chickens become fagged, and that oftentimes they are left behind by the hen. If the hen and chicken are well fed, and at short intervals, this will not occur; but should giving them their entire liberty be objectionable, the plan of enclosing a

small run with laths, wire-work, or net may be had recourse to. These wire-runs may be easily made so as to be movable, and the hens prevented flying over by stripping the ten flight-feathers of one wing, which will be found far more effective than cutting those of both wings. These small runs may advantageously be furnished with a common boarded coop, for shelter against sudden storms and rain.

The remark is often made, that chickens reared in the country by cottagers are more vigorous and healthy than those bred in the most expensive poultry houses; this is entirely owing to the more natural circumstances under which they are brought up. Fresh air, fresh grass, and fresh ground for the hens to scratch in, far more than counterbalance the advantage of expensive diet and superior lodging, if these latter are unaccompanied with the more necessary circumstances just described.

At the same time, when very early chicks are required artificial aids must necessarily be had recourse to. The hens in winter or early spring require housing; a dry sanded floor in a sheltered out-house, or, still better, a corner of the poultry-woman's kitchen, are conditions which must be had recourse to if early chickens are required for exhibition at the summer or autumn chicken shows, or for an early supply of table-fowl.

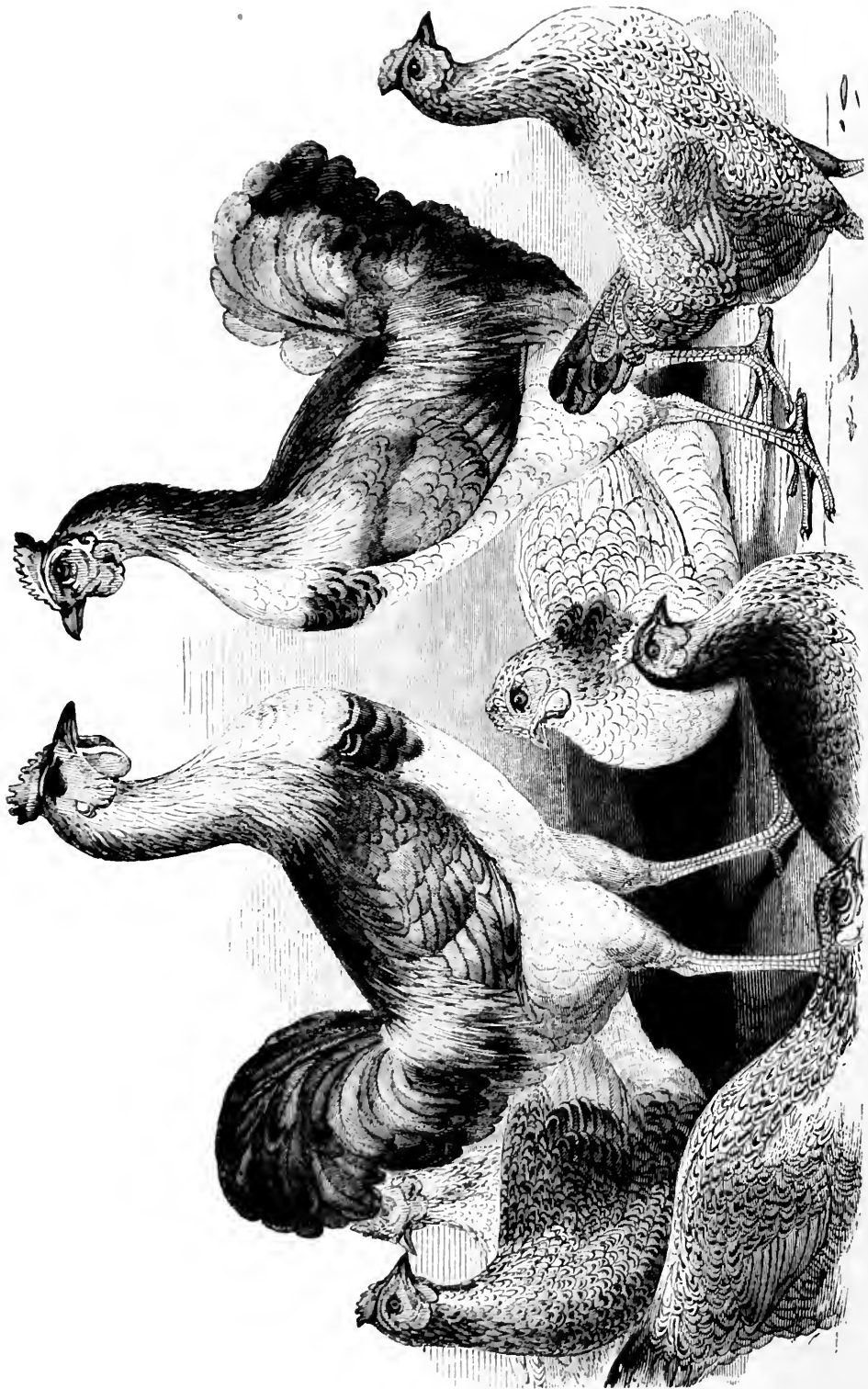

HER MAJESTY'S COCHINS, IMPORTED IN 1843.

CHAPTER VI.

COCHINS.

THE conclusion of the Chinese war in 1843, when the northern ports, including Shanghai, were thrown open to European vessels, may be stated as being the period of the first introduction of these remarkable fowls into this country. The date usually assigned to their importation is frequently some few years later, and there are several claimants to be regarded as the first holders of this variety; but the fact that a group of them belonging to her Majesty were, under the name of Cochin-China fowls, represented in the accompanying engraving from the *Illustrated London News* for December 23, 1843, carries the period of their existence in this country back to, at least, some months antecedent to that date.

These, then recently imported, birds were described in the following paragraph:—

“Her Majesty’s collection of fowls is very considerable, occupying half-a-dozen very extensive yards, several small fields, and numerous feeding-houses, laying-sheds, hospitals, winter courts, &c. It is, however, in the new fowl-house that the more and curious birds are kept, and to these—as the common sorts are well known—we shall confine our attention. The Cochin-China fowls claim the first consideration. These extraordinary birds are of gigantic size, and in their proportions very nearly allied to the family of bustards, to which, in all probability, they are proximately related—in fact, they have already acquired the name of the ‘ostrich fowl.’ In general colour they are of a rich glossy brown, tail black, and on the breast a horse-shoe marking of black; the comb cleanly and neatly formed, with shallow serrations; the wattles double. Two characters appear to be peculiar to them—one, the arrangement of the feathers on the back of the cock’s neck, which are turned upwards; and the other, the form of the wing, which is jointed, to fold together, so that, on occasion, the bird may double up its posterior half and bring it forward between the anterior half and the body. The eggs are of a deep mahogany colour, and of a delicious flavour. These birds are very healthy, quiet, attached to home, and in every respect suited to the English climate. They are fed, like most of the other fowls, on a mixture of boiled rice, potatoes, and milk.”

There may be traced perhaps to the author of this, the earliest account of these birds, many of the ridiculous errors respecting them that gained a ready credence with the public in the early days of what was then known as the Cochin mania. The suggestion that they were allied to the bustards, we need scarcely say, was entirely without foundation. The statement that the wattle was double evidently

took its rise from the largely developed ear-lobes of the birds, and the description of the power of doubling the wing obviously took its rise from the observation of specimens with twisted primary quill feathers—a defect, it is hardly necessary to inform the Cochin breeder, much more frequently found in that variety than in any other. The birds figured by the artist, and described in the paragraph quoted, were what would now be regarded as very bad, stilty, clean-legged partridge Cochins, the hens having well-pencilled plumage, and the cocks having brown breasts, with a horse-shoe or crescentic mark of black.

Notwithstanding the introduction of these birds, however, Cochins remained comparatively unknown for some years.

At the poultry show held at the Gardens of the Royal Zoological Society, Regent's Park, in May, 1845, there were prizes especially offered for "Malays and other Asiatic breeds;" but these brought to the exhibition no other Eastern variety than Malays; and the celebrated stocks of Mr. Moody and Mr. Sturgeon were not obtained by them until the year 1847. Respecting the latter, Mr. Sturgeon gives the following details:—

"The history of my Cochins is a very absurd tale, and full of ill-luck, or perhaps carelessness—a term for which ill-luck is often substituted. I got them in 1847 from a ship in the West India Docks. A clerk we employed at that time happened to go on board, and, struck by the appearance of the birds, bought them on his own responsibility, and at what I, when I came to hear of it, denounced as a most extravagant price—some 6s. or 8s. each! Judge of my terror, after my extravagance, when I found a younger brother had, immediately on their arrival, killed two out of the five, leaving me a cockerel and two pullets; nor was my annoyance diminished on hearing him quietly remark that they were very young, fat, and heavy, and would never have got any better! The cock shortly after died, and, beyond inquiring for another, which I succeeded in obtaining shortly after the original died, together with a number of hens which reached this country under peculiar circumstances, I personally took but little interest in them till the eve before their departure for Birmingham, 1850. Neither my brother nor myself, before we obtained these birds, had taken any particular interest in poultry, and why we came to prefer the light-coloured birds still remains a mystery to me: but so it was. I have often laughed at the dreadful passes my now famous breed has been reduced to, and the very narrow escapes it has had of utter extinction,—first the attack of my brother, already narrated; then the death of the cock; and, in the third year, the incursions of some mischievous greyhound puppies, who killed, one morning, five young birds, just as they were getting feathered, besides many more on different occasions. Our birds all came from Shanghai, and were feather-legged. It is to the cock of the second lot that I attribute our great success. I have had fifty others since, in four or five lots, but not a bird worthy of comparison with my old ones."

As in the case of many other varieties of fowls, Cochins are known popularly by a name to which they have no claim. Mr. Robert Fortune, who has passed many





LEIGHTON, BROS.

BUFF COCHON HEN.

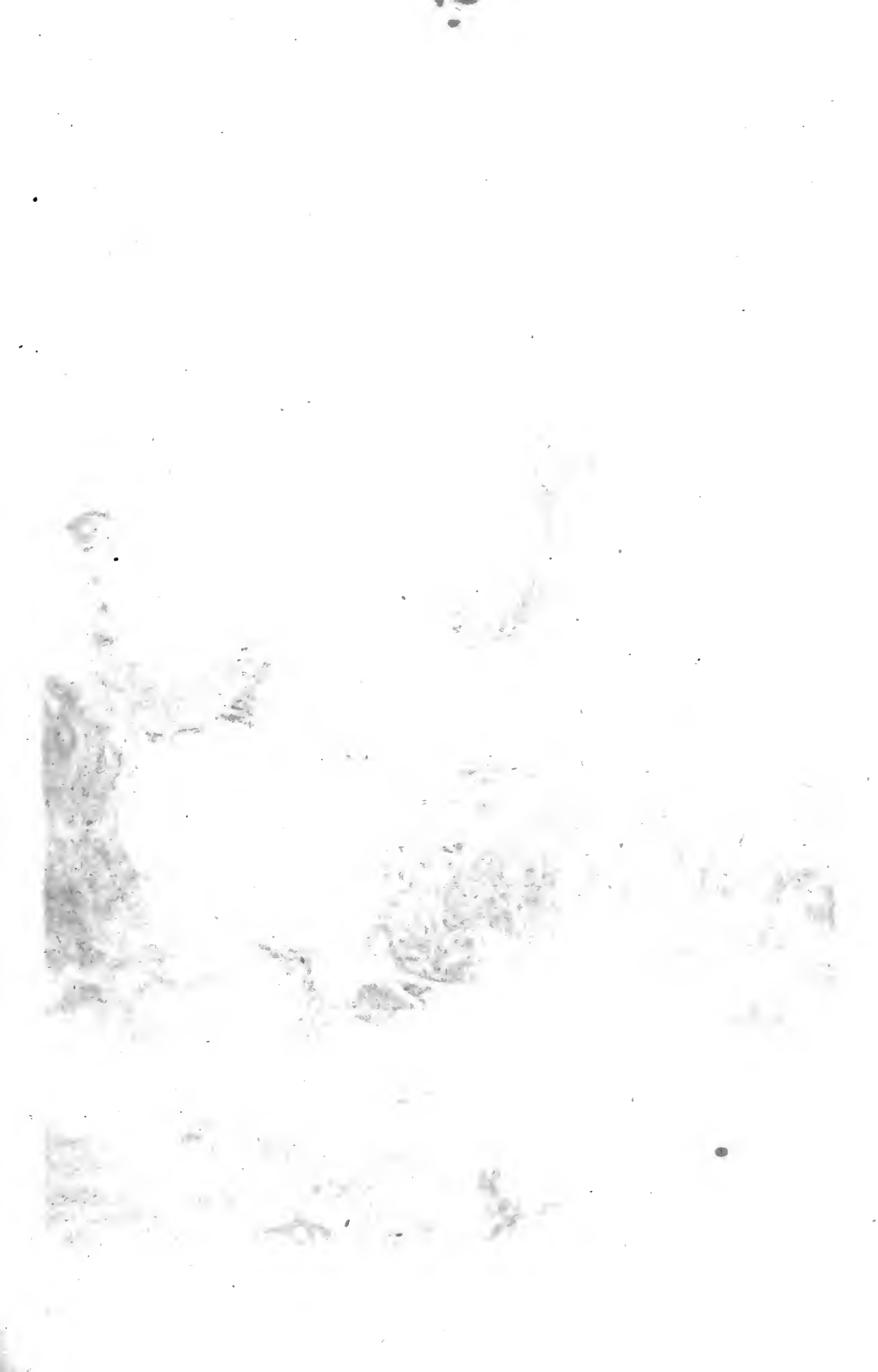



years in various parts of China, says :—"The man who first gave these fowls the name of 'Cochin-Chinas' has much to answer for. I firmly believe that what are called 'Cochin-Chinas' and 'Shanghaes' are one and the same. One thing is certain,—the breed you have in this country as Cochin-Chinas are plentiful about Shanghae. They were discovered there after the war, and were frequently brought to this country, and taken to India, by captains of trading vessels. Was not this the date of their introduction to England? And what grounds has any one for supposing the fowls ever saw Cochin-China?" It may be thought that this variety might have been earlier known, owing to our long-established commerce with Macao and Canton, but Mr. Fortune says that it is a breed but little known in those warmer parts of China, and that, "in fact, the southern Chinese were as much struck with the size of the breed as we were." He adds, "The Shanghae breed seems to be more common about Shanghae than anywhere else in the north; but I found it over all the low country of that part of China. The southern breeds have been long well known to ship-captains and English residents; but there is nothing very marked in their character."

Having stated the date of introduction and the place from whence they were derived, Mr. Fortune informs us as follows respecting the characteristics and treatment of the birds as they occur at Shanghae itself. In the letter already quoted, he says, "The Shanghae breed occurs both with feathered and unfeathered legs, but more frequently unfeathered. The most admired kinds there are the game-coloured ones. However, I am safe in saying that the Chinese do not attach so much importance as we do to purity of colour: large size and large eggs are what they most admire and prize. The young birds are most extraordinary-looking creatures. They may be frequently seen half-clad with feathers, and oftentimes have long tufts on their feet, making them seem to have several extra toes, when they are wet. The old gentlemen have, in Shanghae, as in this country, most abortive-looking tails, and they may be readily known all over the world by their 'sweet voice.'

"The Chinese are not particularly careful in managing their poultry. They feed them in the same way as our cottagers do in the country; that is, the birds are allowed to get as much as they can for themselves, and I need scarcely tell you they are not very particular. When the Chinese housewife feeds them, she generally gives them *padly*; that is, unhusked rice."

Although it is certain that the Shanghae fowl is frequently met with in its native district with unfeathered legs, even more frequently than with feathered or *booted* legs, nevertheless, in our own country fashion has decided most imperatively in favour of the feather-legged birds, to which alone prizes are now awarded at our poultry shows.

In accordance with the facts that these birds were imported from Shanghae, and comparatively unknown in Cochin-China, it has been thought by some writers desirable to endeavour to correct the popular but erroneous name of Cochins, and to substitute that of the port from whence they were originally obtained; but the

effort has not been crowned with success, and to the large majority of poultry breeders they are known only as Cochins. In the United States both names are employed; those birds that are feather-legged being termed Shanghaes, whilst the clean-legged specimens are known as Cochins.

Mr. Sturgeon, who was the first extensive breeder of Cochins in the form in which they are at present known, furnished the following account for the original edition of the Poultry Book. Although in some parts not in accordance with the taste of the present day, these opinions possess a historical value, and therefore we have thought it desirable to reproduce them. Perhaps the most decided objection that could be taken to Mr. Sturgeon's opinion would be respecting the length of the back; all Cochin breeders of the present time regard a short back as an essential requisite in first-class birds.

"A Cochin, to please me," writes Mr. Sturgeon, "must have a stout curved and yellow beak, with plenty of substance at the base, and the shorter the better. The outline of the head should seem to be round in the hens when looked at from the side, and when the eye catches the comb and wattles; and I like just so much comb of a fine quality as will stand up, and give that appearance of roundness. In the cock the comb will be larger; but the most careless observer will easily note the great difference of quality—some races showing a close and smooth texture, delicate as a lady's hand, and others a considerable roughness. The eye should be red and full—it gives a nice brisk look to a sufficiently quiet bird, harmonizes better with the general colour, denotes more constitution, and is less liable to disease. In all cases of contracted pupil and blindness, the pearl or broken-eyed birds have been the sufferers. The neck cannot be too short, nor the body too long, deep, and broad; nor the shank and tail too short. But why need I take up time here on points that are obvious to all, beyond observing on what I believe to be the true form and carriage of the body, which, both in the cock and hen, I like drooping forward, and with the hinder parts consequently raised? A great depth from the base of the neck above, to the point of the breast-bone, with its weight of flesh, tends to produce this form, and to show to advantage the fluff and feathers peculiar to the Cochin. The length of the breast-bone is to be desired and looked to. With this form all will appreciate the neat head, short neck, and the broadness of the back, continued from across the wings to the tail; and that redundant supply of feathers immediately before the tail which gives the broad, square look that distinguishes the high-cast birds, and which makes their tails apparently so short. The small compact wing will accompany these qualities. On the back, before the tail, will be found a profusion of feathers, and that fluffiness about the thighs and the tail and hinder parts of the body that forms with the feathered legs one of the chief characteristics of the race. Too much importance cannot be attached to straight, well-boned, short shanks; and if you want appearance, weight, and constitution, they *must* be wide apart. To my mind, this is a capital requisite. For colour, I prefer the light buff; but I do not place colour first. It stands with me thus—form, size, colour; and for these reasons:—No bird can be





LEIGHTON, BROS.

BUFF COCHON COCK.





perfect if exception can be taken to its form (and our standard here is arbitrary); but unless a bird (I speak of matured specimens) has attained a certain weight, I should say it ought not to be eligible for a *first* prize. I do not mean that birds are to be judged by the scales, but that they ought to show the size and form that would ensure those weights in fair condition. Now, in colour there must be more latitude, and different persons *will* prefer other shades, do what you will.

“As to dark hackle, although I prefer to have but little, I do not dislike that little, provided it be not of a dead black, or painted on, if I may so express myself; but if merely a tinge or stain of a darker hue, I would nearly as soon have it as not. I dislike very much a broken, mealy appearance, either in cock or hen, but more especially in the former, which I prefer of a light red, deepening on the saddle. The comb should be indented, but not too deeply; and in both sexes the appearance of sprigs is very objectionable.

“In forming a standard for Cochins, we ought to insist on those points that are peculiarly theirs, and to discountenance those that in any way imply the possibility of an admixture with another breed. Take a stubby spriggy comb, a lengthy beak and head, a long neck, a long or clean shank, or a closely feathered body, and you see qualities that distinguish or are at least found in the Malay, and which should be condemned accordingly in the Cochins; and more especially as all the *opposites* are found distinguishing the best specimens of that race.

“In neither cock nor hen do I like to see the tail sticking up; it should form a nice agreeable line with the back, or be very slightly elevated, and terminate in nice soft drooping feathers in the cock; the tail in the hen wearing a much shorter appearance from the dense mass of feathers around it. I object to a white ear-lobe, but I like a tinge of red on the back of the yellow legs, which should be stout, short, and well-feathered.”

In preparing the present work for the press, the Editor has sought to avail himself of the experience of the most successful rearers of all the different varieties of poultry who have kindly responded to his request and placed their experience at his disposal.

To Edward Hewitt, Esq., of Sparkbrook, Birmingham, so well known as one of the most experienced and able judges of the day, we are indebted for the following Characteristics of Buff Cochins:—

“In size and weight the larger the better, if without coarseness. Sometimes the cocks attain the weight of thirteen pounds and a half; but from eleven to twelve pounds are good average birds. The hens weigh from eight to ten pounds; if they continue healthy and are well fed, they generally increase in weight until their third year.

“The carriage and form of the cock should be fine, noble, and very majestic; the breast very broad, forming a straight line from the crop to the thighs; the back short and wide; the tail only very slightly raised, compared with that of other fowls; the wings exceedingly short, and held tightly to the sides; the legs, thighs, and saddle unusually large in proportion to the rest of the body. The head small,

and carried well up. The carriage of the hen similar to that of the cock in general character, but the head is carried much lower, and the neatness and fine expression of face is extremely pleasing in really high-bred specimens.

“The plumage in the cock is very soft, owl-like, and exceedingly downy, giving a peculiar softness to the general appearance. Cochins possess a great bulk of feathers, each one being wider across than in other fowls. In the hen the peculiar softness of the plumage is more marked even than in the cock, especially on the thighs and saddle.

“The neck-hackle of the cock is extremely full, and of a rich but light bay colour, spreading over the base of the wings. It is desirable that there should not be any markings whatever on the hackles. The hackle in the hen should be a distinct clear buff, without any markings whatever; but a slightly pencilled hackle is far less objectionable than a clouded one.

“The saddle of the cock should be very full, and free from pencillings of any kind. Cockerels of the year will sometimes moult out perfectly clear at two years old, though imperfect as chickens. The saddle of the hen should be without any markings whatever; the colour being a clear buff from the roots to the tips of the feathers.

“The tail of the cock is very short and compact, soft, and free from hard stiff feathers; if the principal feathers are bronzed in colour, it adds much to the appearance of the bird, but a black tail is also admissible. The tail-coverts are peculiarly brilliant, flexible, and fine. The hen’s tail is much less conspicuous than that of the male; buff tails the most approved, although the colour generally approaches to black in the larger feathers. Wry tails, in either sex, are an abomination.

“The breast in both cock and hen should be clear buff, well furnished with feathers, each one of which is prone to run somewhat lighter in colour towards the tip; but the more pure the self-colour throughout, the better.

“The upper wing-coverts and shoulder in the cock should be clear, but a little darker than the body generally; in the hen, the same colour as the body. The lower wing-coverts of the cock approach to a clear deep-coloured bay. If the wings are light in their first year, the birds are apt to become grizzled with white after a few moultings, which is a great imperfection. A clear dark-winged cock always produces the best-coloured chickens. The lower wing-coverts in the hen are of the same colour as the body.

“Both primary and secondary quills should be clear buff, without admixture of other colours.

“The thighs of the cock are stronger than those of any other variety; exceedingly heavy in the feathering; all the feathers sit very loosely, and are peculiarly downy, forming in part what is commonly called the fluff. The shafts of these feathers should be weak and flexible, contrasting with the firm stiff feathers producing the “Falcon-hock,” which is to be regarded as a defect. In the hen the fluffiness of the thighs is far more conspicuous than in the cocks.





LEIGHTON, BROS.

CUNNINGHAM'S BOONING REEL.





“The legs and feet of both sexes should be perfectly yellow, well-feathered down the outside of the legs and on the outer and middle toes; the feathers should be the same self-colour as the body, without any admixture of black or grey whatever. In very highly-conditioned birds, the inside of the legs and webs of the feet assume a decidedly pinky hue. If short upon the legs, the stronger in the bone the better.

“The comb in both cock and hen should be flat, evenly serrated, and stand perfectly erect on the head, without any inclination to either side; any curvature whatever is a serious defect. The wattles of the cock should be thin, fine, without coarseness, and perfectly florid in colour. Those of the hen should be thin, fine, and delicate.

“The ear-lobes of both cock and hen must be exceedingly well developed, very long, thin, and fine; they frequently hang as low or even lower than the wattles; any disposition to white is a decided defect, as they should be entirely florid in colour, and perfectly devoid of coarseness. In the hens the same traits of character exist, but on a smaller scale.

“The eye of the cock should be yellow-ochre coloured; the bill also perfectly yellow. In the hen, the eyes are often a little darker than those of the cock, and are exceedingly expressive, mild, and docile in appearance.”

It should be remarked that depth and shade of colour in Buff Cochins varies from rich deep buff to pale lemon; all shades are admissible as exhibition birds, but it is imperatively necessary that they should match in the show pen. The variety termed Silver Buffs are of a very pale light silvery tint, almost approaching to that of the breed known as Silver Cinnamons, but wanting the well-defined coloured hackle and tail of that variety.

The other varieties of Cochins will not require at our hands so lengthened a notice, inasmuch as their general characters are, or should be, precisely identical with those of the Buffs, differing only in the markings of the plumage.

The Cinnamon Cochins, which are now always classed with the Buffs at the poultry shows, are characterized by the rich dark reddish cinnamon colour of the hackle and saddle feathers of the cock, the colours extending over the back and wings. The tail should be rich bronzy black, the side feathers edged with cinnamon, and the breast, thighs, and fluff the colour of wetted or dark cinnamon. In the hens the same wetted cinnamon colour prevails throughout the entire plumage.

The Silver Cinnamons, if well marked, constitute an exceedingly beautiful variety. In the cocks the hackle and saddle and tail feathers are cinnamon, varying from a light to a rich bright tint, and slightly striped with white; the thighs, breast, and fluff being a pale buff. In the hens the hackle is of a deep cinnamon, and the rest of the plumage of a very pale buff, which in many specimens is so light as to appear almost creamy white. The contrast of the light body with the dark hackle is exceedingly pleasing.

The darker varieties of Cochins are distinguished and known as Partridge and Grouse Cochins. In these birds the cocks should have bright red hackles and saddles, with a well-defined black stripe down the middle of each feather; the

back and wing bow of a dark rich red, with a wide lustrous greenish black bar across the wings. The quills should be rich bay on the outer webs, the secondaries ending in black tips. The tail should be glossy black; not unfrequently, however, some white appears at the base of the feathers; this is always to be regarded as objectionable when found in a show pen, although not a positive disqualification to prize-taking. Fashion demands imperatively a black breast in a Partridge Cochin cock, mottled-breasted birds being disqualified, according to the Poultry Club "Standard of Excellence," in exhibition birds. The Partridge Cochins originally imported had brown breasts, resembling those of brown-red game cocks, and the hens much more closely resemble brown-red than black-red hens. The judges, however, demanded black breasts in the cocks; consequently, such birds were bred by crossing a partridge-feathered cock with a pure black Cochin. Nevertheless, a reversion to the more natural colour occasionally takes place, and some of the best partridge cocks show the brown feather not unfrequently.

In the Partridge hens the neck hackle feathers should be bright gold, each having a broad black stripe down the centre. The remainder of the plumage should be light brown, well and distinctly pencilled with dark brown. It is an important point that the pencilling should be well marked on the upper part of the breast. The shafts of the feathers should be creamy white, contrasting pleasingly with the darker colour of the webs of the feathers.

In the grouse hens the ground colour is darker, and the shafts of the feathers do not offer that contrast to the other parts of the feathers.

Black Cochins were largely exhibited some few years since, but seem almost to have disappeared from our poultry shows. They should possess all the characteristics of the other varieties as to form and size, and the plumage should be perfectly black throughout; but most of the birds formerly shown were coppery red or "brassy" on the hackle and wings; consequently, this variety did not find any great favour with amateurs, especially as they did not generally breed true to colour.

White Cochins are very beautiful birds, and are making steady progress in general estimation. For the following admirable description of the characteristics of this variety we are indebted to F. W. Zurhorst, Esq., of Donnybrook, one of the most successful breeders and exhibitors of these birds:—

"Let us look round the yard: there is my favourite hen. Notice her great depth, bringing her straight and pointed breastbone apparently close to the ground, sunk between two very short and widely-set shanks, covered to the end of the outer and middle toes with thickly-placed, laterally-spreading feathers! My favourite has some sign of vulture-hock; I know well that she ought not, but I also know that rare shank-feathering cannot be had without it; and if I do not see it so accompanied in the show pen I have my own idea as to what has become of it. Look at her fine broad back, where, two inches from the fall of the thick and ample neck-feathers, the rightly-named cushion begins to rise, softening, thickening, and



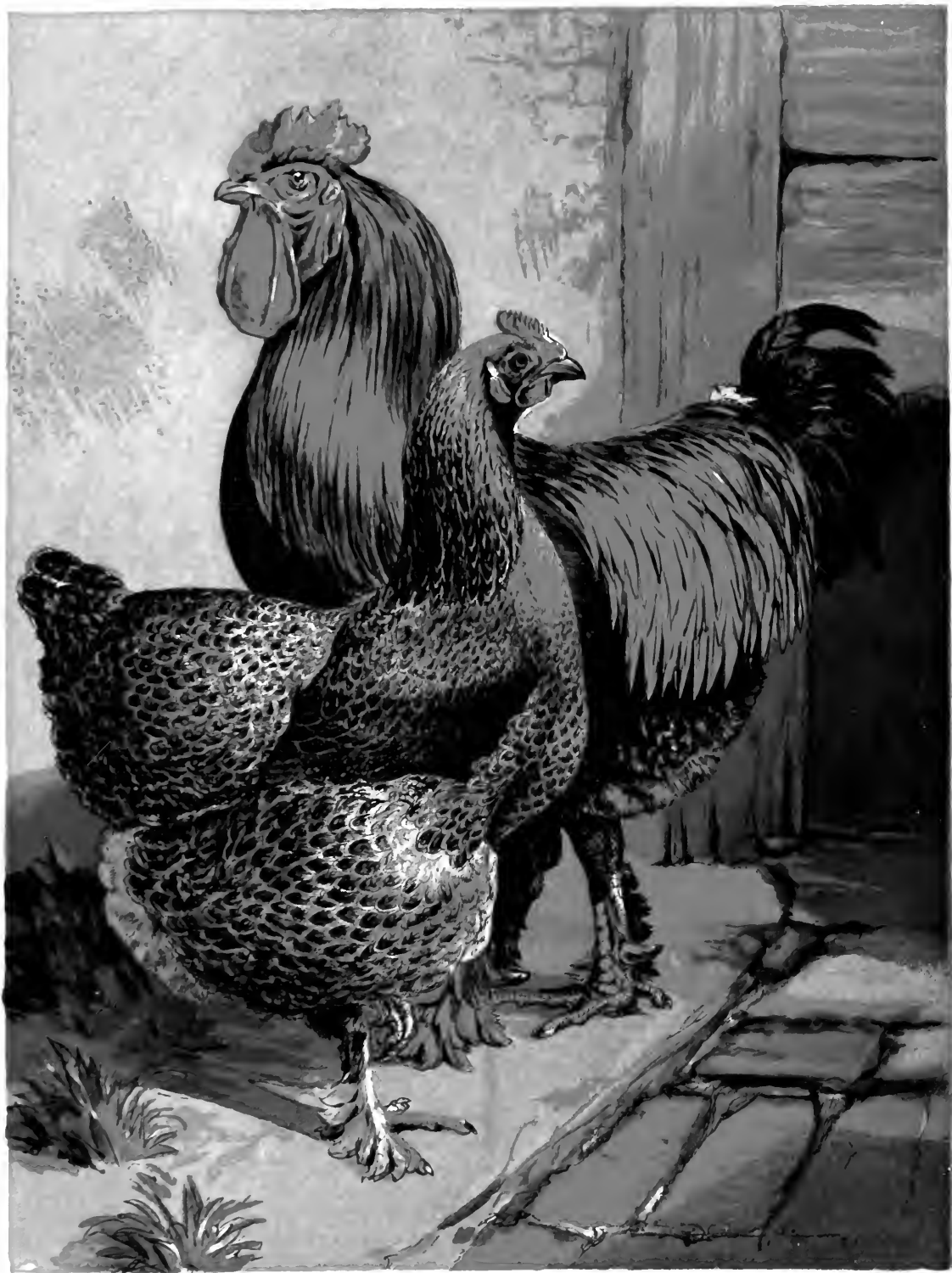

LIGHTON, BROS.

GAME POUTER COCHINS.





widening till it reaches the short, round, blunt tail-feathers. Notice that short and well-set neck, with its rich soft feathering; the small head; the bright hazel eye; clear yellow bill, surmounted by the straight, fine-grained, and evenly-serrated comb, not high or thick, but just enough to set off, with her orange legs, that soft and pure white plumage which makes this hen the most attractive feature in my yard.

“See, she has turned; and now you see her thick and ample fluff, soft and white as swan’s down, and wider than herself, as she canters before us up the yard, thickly clothing her wide stern, and bulging out in heavy masses beyond her tightly clipped-up wings. If, as Mr. Weller asserted, ‘width and wisdom’ go together, she must be sage indeed! How genial her temper, how easily controlled her wanderings—a yard-high fence keeps your white Cochin at home. And what glorious large pink eggs she keeps on laying! Talk of Cochin eggs being small, why one of this hen’s eggs will make two of those of her coloured relatives—ay, and cheaper eating, too, for your white Cochin is a nice feeder, and will eat much less than her buff neighbour.

“So much for our favourite who lives; now for her departed mate, who lives only in his two sons. Short of leg, too, was he; well-feathered were his shanks, straight and well-covered were his toes; he, too, should have had no sign of vulture-hock, but soft and nicely rounded into the top of the yellow shank. Wide was his breast, and well filled out withal in its lower parts, making him look, as the sailors say, ‘a bit down by the head;’ his neck clothed with rich-falling hackle; a strong curved yellow bill; wide, firm, upright comb, springing from the nostrils and going from front to back almost in a semicircle, evenly serrated and finished with a plain round piece, which, though nearly touching the neck, was rounded under and just tucked nicely in to finish on the crown. His back was short, and rising to the glossy and straight-falling saddle hackle which covered the tips of his short and tightly clipped-up wings. For his tail—well, he ought not to have had any hard feathers in it, but nice soft, rolling plumes, making him look almost tailless. I know the winning pens at Birmingham never have tails or vulture-hocks either; but my old friend had, though a compulsory moult might have made him also look soft-hocked and tailless. In back, loins, and fluff he was matched only by his sultana. His wattles were long, very red, and pendulous; and his deaf ears might be similarly described. His glorious white colour was a thing to be remembered, though the summer sun made sad havoc with its purity.

“White Cochins will not suit a city; but when a garden has to be protected and a bit of green can be given, commend me to my whites. They are handsome and massive to look at; where they have a fair chance they will be snow white. For the table, killed under six months old, they carry plenty of meat, with a slight and most palatable gamey flavour. Both as old birds and chickens I have ever found them exceedingly hardy. They have not had as much written about them as the Brahmas, but I believe the strength in which they have of late appeared will get justice done them in the prize-lists.”

Cuckoo Cochins are occasionally exhibited: they are of a grey colour, each feather with transverse markings resembling those on the breast of the bird from which they derive their name. They are inferior in character to the other varieties, and are not likely to come into general estimation.

The singular variety known as Silky Cochins, or sometimes as Emu fowls, is simply an accidental variation of plumage which occasionally occurs, and which may be perpetuated by careful breeding. The cause of the coarse fluffy appearance of these remarkable fowls is to be discovered in the fact that the barbs of the feathers, instead of being held together by a series of hooked barbules (so as to constitute a plane surface, as occurs in all ordinary feathers), are perfectly distinct; and this occasions the loose, fibrous, silky appearance from which the fowl obtains its name. Silk Cochins are usually inferior in size to the ordinary varieties; they are good layers and sitters, not differing in these respects from the other specimens of the breed from which they have evidently been derived.

Having spoken at some length on the characters of Cochins, we have now to consider their general habits and value as a profitable fowl. To E. Hewitt, Esq., we are indebted for the following notes on this breed:—

“ These fowls are of an extremely quiet and domestic disposition. A very low fence, of three or four feet high, quite prohibits their straying: hence their advantage where the range appropriated to them is scanty and confined. They are extraordinarily hardy, if not over-fed; the chickens are raised without any difficulty, and they are undoubtedly the very best layers of eggs in winter-time of any varieties with which I am as yet acquainted. If properly managed, this propensity may be so arranged as to yield very remunerative returns. The most lucrative plan I have yet tried is to obtain some strong and well-grown pullets that will commence laying about November: let these be comfortably housed at night, where they will be but little exposed to the vicissitudes of the weather, and be allowed to have access at pleasure into the same building during the daytime, of which they will avail themselves for protection in case of sudden storms. They should be liberally supplied with food, and have the advantage of a field-run, for they consume a far greater quantity of grass than any other kind of fowls,—a circumstance which lessens the expense of keeping them very considerably,—when they will then continue laying very freely until about the middle or end of the following March: if profit alone be the consideration of the owner, they should all then be disposed of, for, if retained any longer, their keep will most undoubtedly lessen very considerably the profits that have already arisen. The cause of this is very easily explained. Every succeeding year of their lives their laying commences later in spring, being retarded by, and altogether dependent upon, the completion of their annual moult: indeed, I have known some of my old favourite hens that have not had their new feathering altogether restored until after the winter-laying pullets I have just described had ceased laying.

“ It is well known how much more valuable eggs are during mid-winter than



LEIGHTON, BROS.

THE "TOY" COCKER



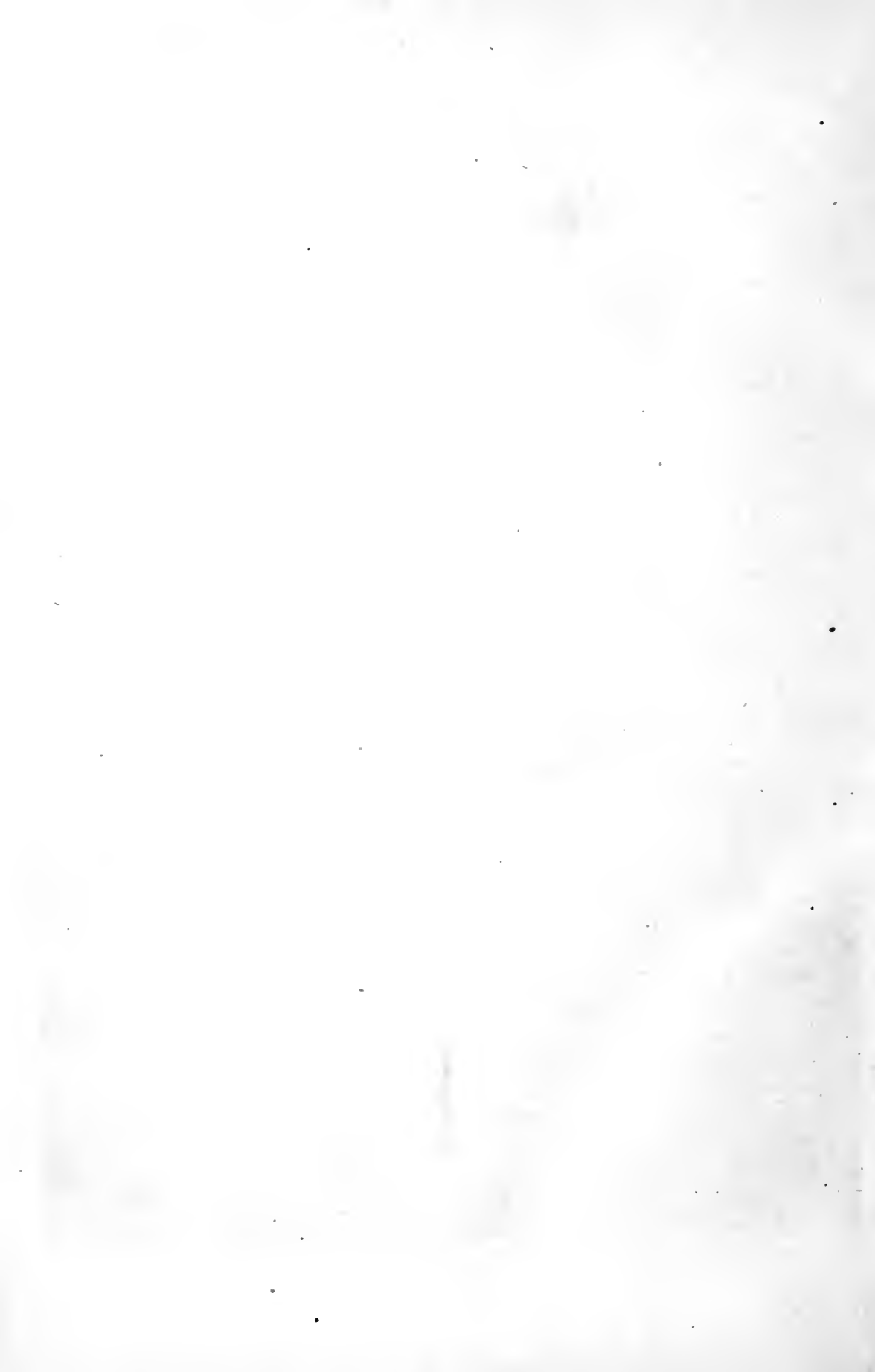

in the height of summer, whether we view them as matters for sale in general market or simply for home consumption; therefore, the advantages to be attained by production of eggs in winter will be easily acknowledged, and need not be further insisted on. I am convinced there is very little even if any difference respecting the productiveness of the different varieties of Cochins as to their colours; my own impression being that prolificacy depends more upon the quantity and quality of their plumage, and the consequent general warmth of their bodies during inclement seasons, than on the colour of the plumage. The reason why some Cochins lay so much better than others is, that those that most abound with 'fluff,' as it is termed, or downy covering towards the roots of the feathers, are comparatively less influenced by sudden changes in the atmosphere, and consequently their laying is unimpeded. I have noted, as a rule without exception, that diminution of plumage, and a scanty, 'weedy' build, is always accompanied with proportionate decrease in the number of eggs produced.

"I am confirmed in this opinion from the fact that the best layers of Cochin fowls I ever yet met with were white—a colour generally reputed by those who keep any kind of livestock as being the most weakly in constitution. They were the fowls with which I obtained the first prize, or silver medal, for Cochins, at the Birmingham Poultry Exhibition in December, 1853. They were most extraordinary fowls as to the superabundance of 'fluff.'

"As with all other poultry, Cochins will not lay freely if excessively over-fed. Extreme fatness in all domestic animals always counteracts productiveness; and Cochin hens have a tendency to increase greatly in weight, from internal fatness, as long as they live. There is still another and far more cogent reason why Cochin fowls should not be unwarrantably forced by over-feeding. They are peculiarly prone to apoplexy; and, although I attribute many of the complaints that we hear of so constantly under this head to the folly of endeavouring to force nature beyond endurance, purposely to increase size only, it is equally certain that, in many instances, this has occurred where it could not have resulted from other than natural tendencies.

"Although the largest variety of domestic fowls, they endure the privations attendant on really close confinement better than any others; but, in all cases, they must be supplied with full abundance of green food, or they soon become ragged in their feathers, and their general constitution suffers proportionably. Whilst I unhesitatingly admit the superior advantages of the largest-sized birds in the exhibition pen, providing all other points are equal, long and carefully-managed trials prove, most decidedly, that birds of moderate size are the most prolific, whether we consider the number of eggs laid or their subsequent fertility. It is best to breed from fowls a little darker in colour—more particularly the cock bird—than the chickens you are anxious to procure, as they generally 'breed lighter.' From my own experience, I am of opinion that the male bird has most influence on the colour of the chickens, and that in form and general characteristics they usually follow the female parent. To do well, the young growing

chickens, especially the cockerels, require high feeding and considerable scope for exercise, or they very rarely become superior specimens.

“As exhibition fowls, no doubt the most opportune moment for their owner to hope for success in prize-taking is the period when the pullets are just about to commence laying their first eggs. If they have been well attended, kept studiously from intercourse with the male bird, and all means used to prevent them laying early, they will then be as perfect in appearance as possible. The countenance of a Cochin pullet at this time of her existence possesses much beauty that is rarely present in after-life; for at two years old many Cochin hens appear really careworn and aged; besides which, in very many instances, the comb becomes irregular, not standing in a straight line, but forming what is technically termed a ‘waved’ or crooked comb. Cockerels for exhibition should, if possible, be two or three months older than their companions, or they will certainly appear comparatively immature. As a general rule, young Cochins show to much greater advantage than old ones. But in breeding chickens, it should be remembered that those produced from the eggs of old hens not only acquire their feathers much more rapidly than those hatched from the eggs of pullets, but mostly possess more bone, and consequently make larger birds. Old hens, and a one-year-old cock, are therefore the most useful stock birds. Cochin fowls are very attentive and indomitable sitters, and usually bring out any chickens that are confided to them very strong; they are apt, however, to lay again too speedily, and desert their offspring before they are sufficiently advanced to be left to themselves.”

These valuable remarks of Mr. Hewitt so nearly exhaust the subject that little more remains for the present Editor than to record his own opinion on some points not noticed by that gentleman;—namely, the cost of the keep of Cochins, and their value as table and market fowls.

The cost of keeping Cochins has been estimated by some authorities as upwards of fourpence per week each, others regarding the entire expenditure required as little more than a penny per head per week. As usual, the truth lies between the two extremes. At the average prices of corn, when Cochins are entirely hand-fed, and have not the advantage of the stray grains of the farm and rick-yard, it will be found that they cost each about twopence per week, provided they are confined to a not very extensive run. If, however, they have a free range, they supply themselves with a very considerable quantity of food, as they graze, if the term may be allowed, to a much greater extent than any of the other varieties, the quantity of clover consumed by them in this way being very large. But, with these advantages, they still consume much more than smaller breeds would do in the same situation. It is contrary to all experience to imagine that a bird weighing from ten to twelve pounds should not require a greater amount of nourishment than would suffice for the support of another of half the weight; it would not be more erroneous to assert that a cart-horse could be kept on the same amount of provender as a Shetland pony, as to state that a gigantic Cochin could be maintained at the same cost as a spangled or pencilled Hamburgh.

The value of Cochins as profitable fowls has already been insisted on by Mr. Hewitt; their strongest point is their unrivalled excellence as winter layers. As supplying chickens for sale in the London and other first-class markets they hold a very inferior position in the scale of merit. They have, in fact, many drawbacks to their value: instead of the smaller bone of the Dorking, they possess coarse spongy bones of a large size, and of a much greater weight. It is evident that all the food which has been required to form the extra quantity of bone, in a profitable point of view, has been uselessly employed. The Dorking, Game or Polish fowl is as superior to the Cochin as is the short-horn steer to the coarse, unimproved varieties of domestic cattle.

The yellowness of the skin and fat is a serious drawback to the saleable value of Cochins, yellow-skinned fowls not being appreciated in the markets. Again, they accumulate large quantities of fat internally, where it is useless; but on the breast they scarcely fatten at all. From their terrestrial habits, the pectoral muscles are very slightly developed; consequently, there is less meat on the breast than might be expected from the size: hence, when dressed, the keel of the bone is prominent, and requires, like that of a turkey, to be broken down. It is frequently remarked that Cochins make up in size of leg what is wanted on the breast. This is true: but it is no recommendation to a table-fowl to develop largely the inferior portions at the expense of the finer parts. In the improved breeds of cattle the best joints are developed, and the inferior lessened in size; there is small bone and very little offal. The same peculiarities should distinguish a table-fowl: it should be as nearly as possible all breast, with short limbs and thin bones.

It should be recollected, that unless a fowl has naturally a full chest, it is impossible to put flesh or muscle on it by fattening; for there is this distinction between the flesh of quadrupeds and that of birds, that in the former, the flesh can be increased in size by the intermixture of fat between the fibres, which gives rise to the marbled appearance seen in prime beef. This, however, cannot be done in the case of birds, their muscles being always destitute of fat, which is deposited under the skin, or in the interior of the body only.

The great value of Cochins, as furnishing poultry for home consumption, is not to be denied. They grow rapidly when chickens; they are so exceedingly hardy that they can be reared at all seasons, and in winter with an amount of accommodation under which Dorkings would inevitably perish. Broody Cochin hens are always to be obtained; and eggs for sitting are not wanting even in the coldest weather. Their flesh, though inferior in shortness to that of the Dorking, and of a more game-like flavour, is juicy to a high degree. For family use they are certainly not to be surpassed, although as furnishing first-class fowls for the market they are valueless. It is frequently said by their partisans, that the pullets are at least equal to other fowls (a tacit acknowledgment that their cockerels are unequal); but it must be borne in mind that there is a tendency in Cochins to produce an extraordinary number of cocks in nearly every brood.

Another recommendation they sometimes receive is, that the feathers are quite or nearly as valuable as those of the duck and goose. If old birds are killed, or chickens after they have perfectly completed their autumnal moult, and become full-plumaged birds, this statement may have some weight; but at this period of their lives they are valueless, or nearly so, as market-fowls; and if killed at the age when they are in the highest condition, it will be found that the feathers are mixed with *stubs*, containing so much blood, that their value is very small; whereas in a duckling of from eight to ten weeks, the feathers of the breast are perfectly formed, and consequently valuable.

To sum up, it may be stated that the Cochins are chiefly valuable from their hardihood, from the ease with which they can be kept in a small space, and the manner in which they bear confinement; from their great prolificacy, in winter especially; from their docility and the readiness with which they sit in any place, and at any time of the year; also from the quickness of their growth and size as a family fowl; but as a first-class table and market fowl, it will be found that any attempt to breed them for this purpose will terminate in disappointment.

In treating of each variety of fowl, it may be regarded as desirable to speak of a few of the more useful cross-bred birds, which, although generally of no value for exhibition, are frequently extremely useful for table and economical purposes. When Cochins were first introduced, many persons turned down a cock into their poultry-yards with a view to the improvement of the ordinary farm-yard stock. Never was there a more fallacious idea: fowls that are bred between Cochins and the common barn-door breeds are about the least useful variety of poultry that can be imagined; gaunt, weedy, stilty, big-boned, angular, yellow-legged birds are the produce of such a cross; and it is only requisite to ask the opinion of the poultry salesmen at Leadenhall, and of the higglers who collect the fowls for them from the country, to know the estimation in which such birds are held.

Many persons who keep as their principal stock non-sitting varieties of fowls, such as Spanish, Polish, and Hamburgs, employ Cochin hens to act as sitters and foster-mothers, and frequently rear half-bred birds for home consumption. In favour of the first of these crosses little can be said,—the Spanish is a long-legged bird, and this is a character which it is not desirable to engraft upon a Cochin stock. The offspring of Cochin hens running in a yard where Polands and Hamburgs are kept, are compact and short-legged, and are useful as sitters, although the sires are of non-incubating varieties. The cockerels serve to supply the kitchen; but they are of course useless for stock birds.

Of the other crosses, that with the Dorking is one which calls for special attention. There is no doubt whatever that many of our prize Dorkings have had their size increased by the breed being crossed with Cochins, and then bred back again for two or three generations from the Dorking; in fact, birds with the apertures in their legs from whence the feathers have been extracted, have before now graced the first prize-pens at some of our poultry shows.

If it be considered necessary to cross the Dorkings for the purpose of producing a hardier fowl, such a plan as the following offers the greatest probability of success. It is based upon the fact that, in cross-breeding, the pullets usually are like the mother, and the cockerels like the father. To obtain a brood in May it will be necessary, in the beginning of the year, to put two or three large Dorking hens with a short-legged, compact Cochin cock, either of the common buff or of the Partridge variety. Of the chickens, choose those pullets which possess in the highest degree the Dorking character,—viz. fine bone, short white legs, and compact body, square on the limbs; and, in the following season, mate these with a good Dorking cock. The result will be a breed three-fourths Dorking, which if care has been taken in the selection, will show very little trace of Cochin descent; whilst the size and constitutional vigour of the birds will have been much improved by the infusion of new blood from the hardiest of races. One caution, however, is needed;—if these birds are permitted to breed amongst themselves, they will sometimes revert to the Cochin type; it will be, therefore, necessary to mate the pullets again with a Dorking cock. As in all cases of rearing for size and strength, great care must be taken to avoid breeding closely, viz. from birds related to each other.

The cross-bred birds produced by mating Cochins with the large French table-fowls known as the *Creve Cœur*, *La Flèche* and *Houdan* varieties, are very remarkable for their rapid growth and for the great size they eventually attain. We have reared chickens early in March from Cochin hens running with a *Creve Cœur* cock, that were never housed, being in a lean-to shed open to the west; the hens being cooped on wet days, whilst the chickens had the run of a grass field at all times and seasons. Some of the cockerels were killed in May, when less than twelve weeks old, weighing four pounds six ounces each as caught up out of the field, and when trussed ready for the spit they weighed precisely three pounds each, the birds being then five months old. In the first week in August the weight of the cock chicken was seven pounds, that of each of the pullets rather over four pounds; although they had not been put up to fatten, or even fed on soft food, or any attempt made to restrain their wanderings in the fields. To those who wish to breed large hardy birds for the table, a better cross than Cochin hens with a *Creve Cœur* or *La Flèche* cock cannot be recommended. The chickens produced will be of rapid growth, large size, and great constitutional vigour, and, when cooked, will be found plump, and with skin and fat much whiter than that of the Cochins. There is, it must be confessed, one great disadvantage attending the rearing of cross-bred fowls—they are quite useless for the purposes of exhibition, and unsaleable as stock birds. This itself is really a very serious drawback, as, after giving a high price for good fowls, the breeder not unfrequently looks forward to the sale of some of the chickens as a remuneration for the outlay.

The general consideration of the diseases to which fowls are subject, and the best method of treating each complaint, will form the subject of a separate chapter, by which arrangement much needless repetition will be avoided; nevertheless, our

account of each variety must be regarded as incomplete, unless some mention is made of the diseases to which the fowls belonging to it are most prone, and the readiest mode by which these may be obviated.

Cochins, as already stated, have a great and unusual inclination to accumulate internal fat; this hinders the action of the respiratory and circulating systems, and the result is that, in highly-fed birds, apoplexy not unfrequently supervenes. The mode of preventing this sudden and usually fatal illness is self-evident: it is simply to diminish the amount of food, and to avoid the use of those kinds which, like Indian corn, are of a very fattening character. When internal fat accumulates very largely in the hens, the abdomen becomes quite pendant, nearly touching the ground, and the animal assumes the perpendicular attitude of the Penguin. It is needless to say that such hens are useless for stock purposes.

When heavy Cochins are allowed to roost in houses where the perches are either high, or small and angular, they are very subject to an inflammatory affection of the feet, which often ends in suppuration; this disease is also apparently not unfrequently caused by the runs which are paved with loose sharp-edged stones.

White comb—a skin disease of an obstinate chronic character, the first symptom of which is a scurfy whiteness of the comb—is another result of over-feeding, and of employing food of an unduly stimulating or unwholesome character. Cochins are remarkably free from liability to that pest of the poultry yard known as roup; and, as chickens, are as hardy and as little—perhaps it would be more correct to say less—liable to disease than any other variety whatever.

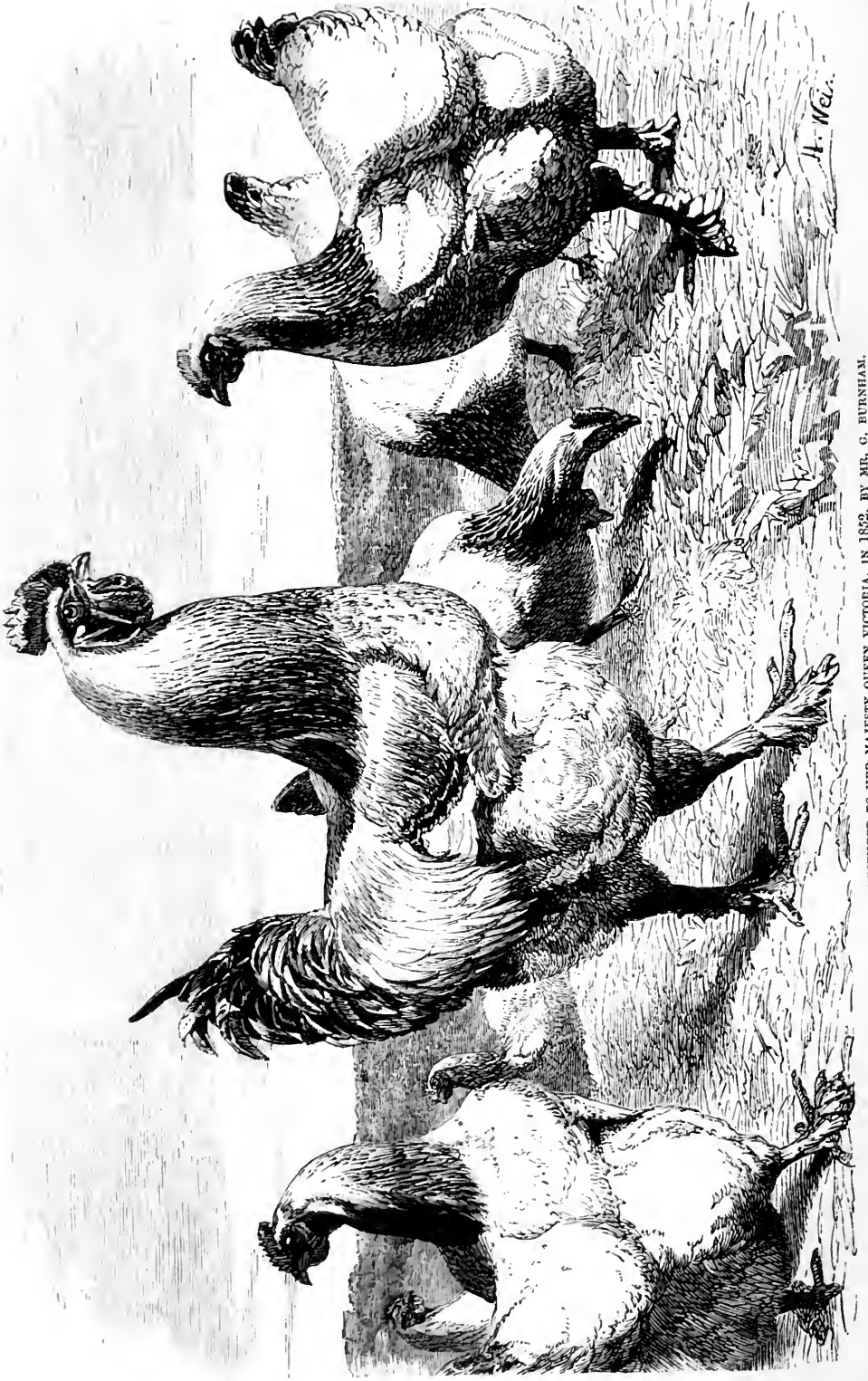

H. WEA.

LIGHT BRAHMAS PRESENTED TO HER MAJESTY QUEEN VICTORIA, IN 1852, BY MR. G. BURNHAM.

CHAPTER VII.

BRAHMAS.

ALTHOUGH Brahmas are amongst the latest introductions into our poultry yards, there is perhaps no other variety of fowl over which more angry discussion has taken place regarding its history and origin: according to one party the breed took its rise on the banks of the Brahmapootra or Burrampooter river, in India, from which supposed origin it derived its name; according to the opposite view Brahmas, as they are now generally termed, are either grey Cochins, or a breed originating in a cross between the Cochin and the grey Chittagong, a large variety of Malay formerly common in the United States of America.

Without attempting in the slightest degree to depreciate the merits of this very magnificent breed of fowls, which is now firmly established in public favour, and which possesses characters as fixed and as capable of being transmitted as those of any other variety whatever, candour, nevertheless, compels us to dissent altogether from the statement that these fowls originally came from the region from whence they derived their name. There is not a particle of evidence to show that they came from India. The banks of the Brahmapootra have long been in the possession of the British—at least the lower part of the course of the river—and no such fowls were ever seen in the locality.

In fact, Brahmas originated not in India, but in America; and the two varieties of the breed, now known as light and dark Brahmas, had unquestionably very distinct origins.

The light Brahmas undoubtedly originated in, or were identical with, those grey birds that from the very first importation came over from Shanghae with the buff and partridge birds now universally known as Cochins. But public attention was first called to them in consequence of an acute American fancier, Mr. George P. Burnham, presenting a consignment to Her Majesty; and these birds were subsequently exhibited by His Royal Highness the late Prince Consort at the Metropolitan and other shows as Brahmas. Of the origin of these birds it will be best to let Mr. Burnham tell his own tale. In his amusing and unscrupulous work, entitled "A History of the Hen Fever," published at Boston in 1855, he says:—

"An ambitious sea-captain arrived at New York from Shanghae, bringing with him about a hundred China fowls, of all colours, grades, and proportions. Out of this lot I selected a few grey birds, that were very large, and consequently very fine. I bred these, with other grey stock I had, at once, and soon had a fine lot

of birds to dispose of—to which I gave what I have always deemed their only true and appropriate title (as they came from Shanghae), to wit, *Grey Shanghaes*.

“ In 1851 and '52 I had a most excellent run of luck with these birds. I distributed them all over the country, and obtained very fair prices for them; and, finally, the idea occurred to me that a present of a few of the choicest of these birds to the Queen of England wouldn't prove a very bad advertisement for me in this line. I had already reaped the full benefit accruing from this sort of 'disinterested generosity' on my part towards certain American notables, and I put my newly-conceived plan into execution forthwith.

“ I then had on hand a fine lot of fowls, bred from my imported stock, which had been so much admired, and I selected from my best 'Grey Shanghae' chickens nine beautiful birds. They were placed in a very handsome black walnut-framed cage, and after having been duly lauded by several first-rate notices in the Boston and New York papers, they were duly shipped across the big pond, addressed in purple and gold as follows: .

TO H. M. G. MAJESTY, VICTORIA,

QUEEN OF GREAT BRITAIN.

To be Delivered at Zoological Gardens,

LONDON, ENG.

FROM GEO. P. BURNHAM, BOSTON, MASS. U. S. A.

“ The fowls left me in December, 1852. The *Illustrated London News* of January 22nd, 1853, contained the following article in reference to this consignment:—

“ ‘ By the last steamer from the United States, a cage of very choice domestic fowls was brought to her Majesty Queen Victoria, a present from George P. Burnham, Esq., of Boston, Mass. The consignment embraced nine beautiful birds—two males and seven pullets, bred from stock imported by Mr. Burnham direct from China. The fowls are seven and eight months old, but are of mammoth proportions and exquisite plumage—light silvery-grey bodies, approaching white, delicately traced and pencilled with black upon the neck-hackles and tips of the wings and tails. The parent stock of these extraordinary fowls weigh at maturity upwards of twenty-three pounds per pair; while their form, notwithstanding this great weight, is unexceptionable. They possess all the rotundity and beauty of the Dorking fowl; and, at the same age, nearly double the weight of the latter. They are denominated Grey Shanghaes (in contradistinction to the Red or Yellow Shanghaes), and are considered in America the finest of all the great Chinese varieties. That they are a distinct race, is evident from the accuracy with which they breed, and the very close similarity that is shown amongst them; the whole of these birds being almost precisely alike, in form, plumage and general characteristics. They are said to be the most prolific of all the Chinese fowls. At the time of their shipment these birds weighed about twenty pounds the pair.’

“ This was a very good beginning. A few weeks afterwards, the *Illustrated*

London News contained a spirited original picture of seven of the nine Grey Shanghae fowls which I had the honour to forward to Queen Victoria. The drawing was made by permission of the Queen, at the royal poultry-house, from life, by the celebrated artist *Harrison Weir*, and the engraving was admirably executed by *Smythe*, of London. The effect in the picture was capital, and the likenesses very truthful. In reference to these birds, the *Illustrated London News* has the following:—

“ ‘ GREY SHANGHAE FOWLS FOR HER MAJESTY.—In the *Illustrated London News* for January 22nd, we described a cage of very choice domestic fowls, bred from stock imported by Mr. George P. Burnham, of Boston, Mass., direct from China, and presented by him to Her Majesty. We now engrave, by permission, these beautiful birds. They very closely resemble the breed of Cochins already introduced into this country, the head and neck being the same; the legs are yellow and feathered; the carriage very similar, but the tail being more upright than in the generality of Cochins. The colour is creamy white, slightly splashed with light straw-colour, with the exception of the tail, which is black, and the hackles, which are pencilled with black. The egg is the same colour and form as that of the Cochins hitherto naturalized in this country. These fowls are very good layers, and have been supplying the royal table since their reception at the poultry-house, at Windsor.”

We have to express our obligation to the proprietors of the *Illustrated London News* for the permission to reproduce this engraving.

The receipt of these birds was graciously acknowledged by the following letter:—

“ Buckingham Palace, March 15, 1853.

“ Dear Sir: I have received the commands of Her Majesty the Queen, to assure you of Her Majesty’s high appreciation for the kind motives which prompted you to forward for her acceptance the magnificent ‘ Grey Shanghae ’ fowls which have been so much admired at Her Majesty’s aviary at Windsor.

“ Her Majesty has accepted, with great pleasure, such a mark of respect and regard, from a citizen of the United States.

“ I have, by Her Majesty’s command, shipped in the ‘ George Carl,’ to your address, a case containing a portrait of Her Majesty, of which the Queen has directed me to request your acceptance.

“ I have the honour to be,

“ Sir, your ob’t and humble servant,

“ C. B. PHIPPS.

“ To Geo. P. Burnham, Esq.,

“ Boston, U. S. A.”

The portrait thus sent was that of Her Majesty in the robes of the Order of the Garter, and it was reproduced by Mr. George Burnham as the frontispiece to his book, in a style that was especially creditable to the Transatlantic wood engravers.

When these birds first came over and were in demand, those who had grey Cochins immediately proceeded to utilize them, and numerous birds were bred from grey imported hens that had previously been regarded as valueless. The light Brahmas with pure white or cream coloured bodies and elegantly pencilled hackles were in great favour; they were universally admired for their beauty and esteemed for their good qualities, when suddenly a new variety sprang upon the scene. A pair of birds were shown at Birmingham which were said to have been sold for 100 guineas; these were dark in colour, and very different in general character; they were the first dark Brahmas seen in this country. For their history let us turn again to Mr. Burnham, who states:—

“By one of the British steamers, in the summer of 1853, the express of Edwards, Sanford & Co., took out to Europe from my stock, for Messrs. Baker, of Chelsea, Baily, of London, Floyd, of Huddersfield, Deming, of Brighton, Simons, of Birmingham, and Miss Watts, Hampstead, six cages of these extraordinary birds. The best of the hens weighed nine to nine and a half pounds each, and three of the cocks drew over twelve pounds each! There were forty-two birds in all, which, together, could not be equalled, probably, at that time, in America or England, for size, beauty and uniformity of colour. The sum paid me for this lot of Greys was eight hundred and seventy dollars.

“Of the three fowls sent to Mr. John Baily (above mentioned), and which he exhibited in the fall of that year in England, the following account reached me, subsequently:—

“Mr. Geo. P. Burnham, of Melrose, sent out to England, last fall, to Mr. John Baily, of London, a cage of his fine ‘Grey Shanghaes,’ which were exhibited at the late Birmingham Show. The London *Field* of Dec. 24th, says that ‘one pair of these fowls, from Mr. Burnham, of the United States, the property of Mr. Baily, of Mount-street, were shown among the extra stock, and were purchased from him, during the exhibition, by Mr. Taylor, of Shepherd’s Bush, at one hundred guineas.’

“This was the biggest figure ever paid for two fowls, I imagine! Mr. Baily paid me twenty pounds sterling for the trio, and I thought that fair pay, I remember.”

These birds were subsequently figured in the *Field*, having been drawn by Mr. Harrison Weir, and we have also to express our thanks to the proprietors of that paper for their kind permission to reproduce the portraits.

On comparing these two plates of the birds sent over by Mr. Burnham, it will be seen that the fowls are essentially distinct in their characteristics. The origin of the light birds has already been given; of the dark breeds Mr. Burnham states that they were grey Chittagongs crossed with Cochins. Of this, he says, “no one now entertains a doubt; they were the identical fowls all over—size, plumage and characteristics.”

If further proof were wanting respecting the close approximation of Brahmas and Cochins it may be discovered in their osteological characters and anatomical



PARK BANTAMS, IMPORTED IN 1833.



peculiarities. It has been remarked that it is a fact universally recognized by comparative anatomists, that the distinguishing characters of nearly allied varieties are more strongly marked in the bones of the skull than in any other part of the body. Now, the skull of the Cochin is vaulted and arched, both from before backwards, and from side to side, and possesses a peculiarly marked groove, extending from before backwards on the frontal bone; and, what every anatomist will regard as a character of great value, the long axis of the aperture through which the spinal cord issues from the skull, is the perpendicular one. Now, in these characters the skull of the Brahma is identical; whereas, in all our ordinary breeds of fowl the long axis of the occipital foramen is placed transversely, the skull wants the distinguishing frontal peculiarities; and the remarkable arched or vaulted character formed both these breeds.

Having allowed to those who maintain one view of the question as to the origin of the Brahmas, space to advocate their opinions, it will be but fair that we should afford a like opportunity to their opponents. We have therefore much pleasure in transcribing the following from the "Poultry Yard," as it is unquestionably the ablest defence of the opposite view that has appeared in print:—

"In many instances the Brahmapostras have been most unfairly judged, because birds of unquestionable impurity of race have been taken as a standard, and an opinion thereon has not only been formed, but published. This has not been wilfully done, but the conclusion has been arrived at, without due preliminary inquiry, that they are simply Cochin-China fowls of another colour than those we have hitherto possessed.

"To form a just opinion, it is necessary to study their habits, and to breed them. We see enough in their shape to justify us in holding them distinct from the Cochin-Chinese; but still more do we find it in their habits and produce.

"In the shape of Cochin-China fowls no one can fail to remark the absence of breast, which is indeed one characteristic, as the lack of it enables the fluffy thigh to become more apparent; and the wedge-like shape of the bird, while wide behind and tapering to the breast, favours the development of those points which constitute the chief beauties in that breed. Now, in the Brahmapoetra, this lack is materially supplied, inasmuch as there is a breast amply developed, and possessing a rotundity approaching, when in hand, to what game-fowl breeders and amateurs call cleverness; which is, that a well-proportioned fowl, placed breast downwards on the palm of the hand, should balance. This cannot be where the breast is wanting.

"A main merit of the Cochin-China fowl is its domesticity, and its happy, contented disposition; satisfied with a small run, and never seeking to roam. This is the admitted character of the bird, and it never deviates from it. We have known instances where seventy of these birds were kept in a small yard, with a grass-run of three-quarters of an acre, and where it has been necessary to drive them forcibly out of the yard to the grass; and the owner assured us he thought there were

many parts of the field where the birds had never been. The Brahmapootras wander over acres, and, except to bask in hot weather, never keep at home.

“The Cochin-China fowl, although a great eater, must have his food provided for him, while the Brahmapootra will go abroad to seek it. A lady lately imported some of these birds, and after they had been in charge of the man (who had looked after Cochins for years) some days, asked his opinion. ‘Madam,’ said he, ‘these will get fat where the Cochins will starve.’ The Cochin-China fowl seeks its roost early, and besets the hen-house door; the Brahmapootra always roams far from home till almost dark. We have seen them following a man at plough, and picking in the newly-turned furrows, three fields from home. We believe a similar thing was never witnessed in the others.

“It is an old axiom in breeding, that if like produces like, it is a proof of purity; because where there is a cross, however remote it may be, the parents will throw back. We have bred a great many, and everything indicates distinctness of breed. The chickens are all hatched either black or yellow; at the age of six weeks a change takes place,—the black get gradually grey, and look as if their feathers were covered with a cobweb; while the yellow become white, and then speckled like a silver-pencilled Hamburg chicken. At a more mature age they all become grey, some more pencilled than others. There is no doubt they are even hardier than Cochins. In November, often during the hard frosts and little snow we then have, chickens will do very well in an open field, without any other cover than that afforded by the rip in which the hen is placed. At daybreak they may be seen, in spite of the cold, running about in perfect health; and an amazing small number die. They are less expensive to keep, and are quite as prolific in eggs as the Cochins.

“The only difficult point is the variety of comb—viz. the pea-comb and the single: while we give the preference to the former, therein following the judgment of the best of the recognized judges in America, we do not see why both may not be pure, as in Dorkings. But there are other points in which these cocks differ from their Cochin brethren: the head, the prominent breast (almost protuberant), the carriage, and shape of the tail. Close observers will notice that not only is it more upright than in Cochins, but the feathers that would be sickles in another breed more resemble those in the tail of the black-cock, and, like them, spread outwards from the centre.

“As in the early days of the Cochins, these birds have been mated with those of other breeds, and the produce has been exhibited as pure specimens. We know many instances of it, where it has been openly admitted that they have been bred between Brahma cocks and buff hens. Such will lead to disappointment; and no opinion can be a just one based on such an exhibition.

“It may safely be left in the hands of amateurs to decide whether they are or are not a valuable addition to our poultry stock. Seeing, as we do, the vast difference in many essential points between them and the Cochins, we believe them to be distinct from them.





LEIGHTON, BROTHERS.

GREY SHANGHAI.

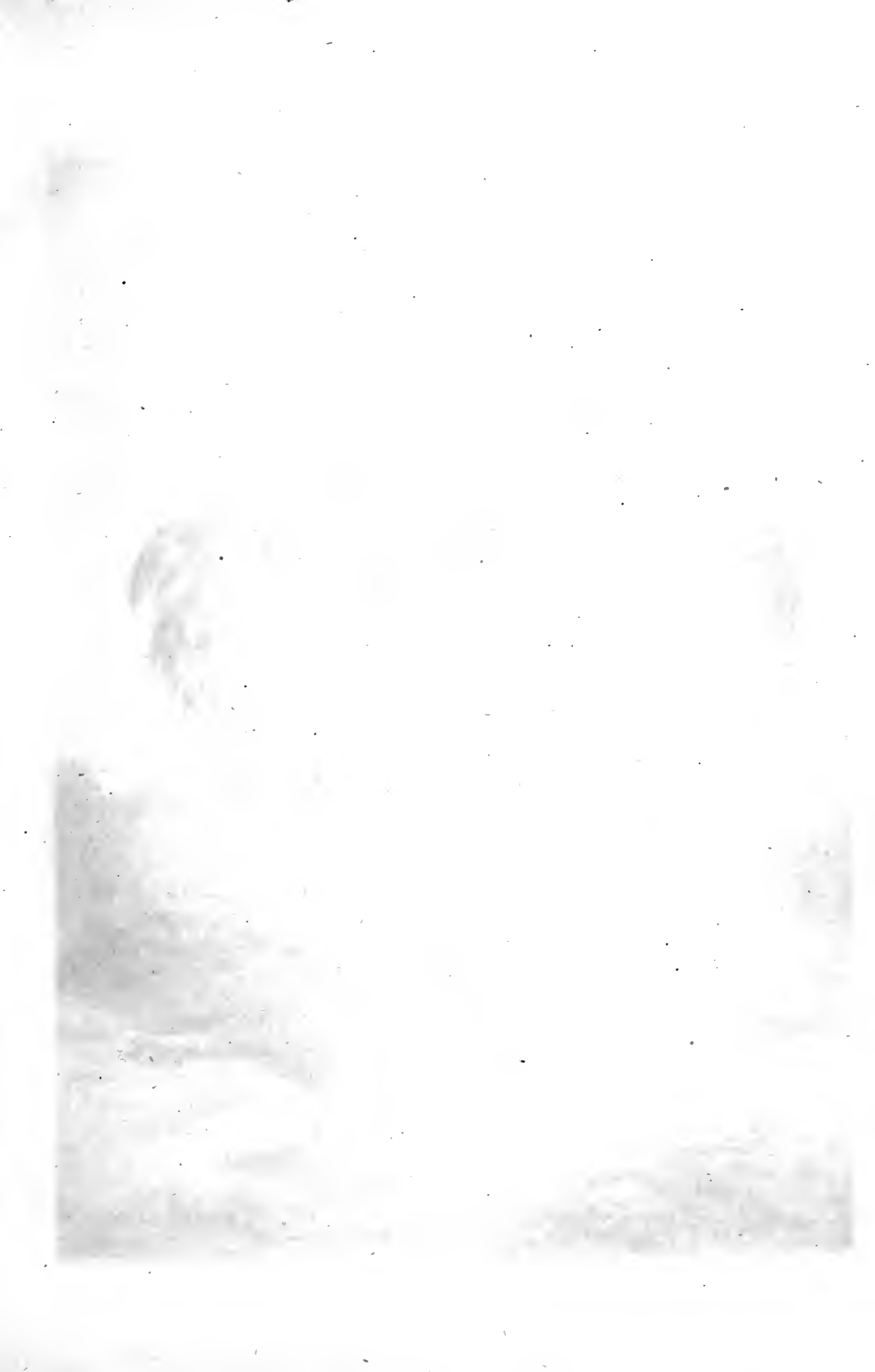



“Among the Americans, Mr. Burnham says they are Shanghaes. Dr. Bennett contends they come from India. Why should they not? During the mania, many thousands of birds were imported from China. How was it that among them there were no Brahmas; and why, then, should it be so strongly asserted they are only Cochins? It would seem that the hold of these latter birds on their admirers is so strong, that rather than admit a new actor on the scene, they vow he is the same in a new costume. Cochins will ever be memorable in the history of poultry as the birds that were the general favourites when a love for the feathered tribe sprang up. They will also bear the palm of having made larger prices, and maintained them longer than any other will probably do. Let their lovers and admirers be content with this, and with the good qualities which, by universal consent, are awarded to them. It is useless for them to ask more, as the public has already decided the value of them, and they have passed from ridiculous to rational prices. They have also suffered the fate of all favourites and fashions; they have had their day, as ‘stars.’ Let, then, the Brahmas have their turn, and reign, if they deserve it; they will never attain the height of their predecessors, nor will any other: but do not seek to take from them ‘their local habitation and their name.’

“If they are Cochins, will the advocates of this opinion tell me if they ever bred their buffs, cinnamons, and grouse with pea-combs. I refer to this, first, because it is a disputed point among writers. One says the pea-comb is decidedly preferable; the others say it should be single, upright, and well serrated. The pea-comb is a novelty with us; it is unlike any other; it is not in any part like the single one of the Cochin, the double one of the Hamburg, or the flattened one of the Malay. It rises little from the head; it is very thick at the base. It has the appearance of three combs pressed into one; the middle and highest part has blunt serrations; the sides, only half as high, have the same, looking like two small combs joined to a larger one. Now, in all our varied crosses we have never seen anything like this. If we put a Malay hen to a Cochin cock, as was done in the early days, we had no pea-comb. The effect was, the Malay comb became thinner and longer, and in some instances fell over the face, like that of a Spanish hen. In all my experience among thousands of Cochins, I never saw one with a double comb. I have seen crosses, with much of Cochin in them, with double combs, but of course they ceased to be types of the breed.

“I assert, then, the pea-combed Brahma cannot be a Cochin. If it be a cross, then I repeat what another writer on poultry said some time since: ‘If brother Jonathan made these, I wish he would make us something more.’

“I would fain meet objections on their own grounds. One of them says all these birds sprang from one pair. There has, then, been no introduction of fresh blood; and marvellous birds they are to go on with so little appearance of degeneracy; and it speaks much for the purity of the breed, for were they made up of a cross, they would certainly throw back. The attempt would hardly succeed of crossing between the Malay and Dorking, because it is known how the fifth claw

appears in every cross; witness the early days of Cochins: the legs would often be robbed of their feathers. I have bred above a hundred Brahmas, and never had one without feathered legs, nor did I ever have one without orange legs; no green, as in white Cochins, nor white as in Buffs.

“Nor is it a less mistake to say the American birds are crossed with the Malay. No mixture is so easy to detect as this; there is a character in Malay fowls which belongs to no other, and the slightest cross of it is immediately visible to a practised eye. The feather, carriage, tail, and head of Malays are different from any others: and so different, that the veriest tyro will recognize them when grafted on any other stock.

“I do not want to become too lengthy, and will therefore conclude. If they were Cochins, they would not have pea-combs nor deep breasts. If they were crossed with Malays, they would have drooping tails, small bodies, hard plumage, and cruel faces. If they were crossed with Dorkings, they would have ample tails, five claws, and clean legs.

“These are the accusations, and the birds in question have no points to bear them out.

“What are they, then? They are Brahmepootras; large, heavy birds, symmetrical, prolific, and hardy; living where Cochins would starve; growing in frost and snow, when hatched in the winter months; and, without seeking to christen a mania, they are standing on their own merits, with the conviction they will deserve well of the public.”

As much misapprehension prevails on the subject of the origin of new varieties, we reproduce from the *Field* the following article from the pen of the present editor:—

“A considerable amount of uncertainty finds its way into type respecting what may be termed pure breeds of domestic animals. Such questions as the following are constantly asked, ‘Are Brahmas a pure breed?’ ‘Are Black Hamburgs a pure breed?’ &c. &c. These queries obviously owe their origin to a confusion of the distinction that exists between different animals, and between different varieties of the same animal. Let us illustrate our meaning by an example or two.

“A hare is a pure-bred animal, because it is totally distinct from all other animals, or, as naturalists say, it constitutes a distinct species. It does not breed with other animals, for the so-called leporines are only large rabbits; and if it did, the offspring would be a hybrid or mule, and almost certainly sterile or incapable of breeding. In the same manner the common wild rabbit is a pure breed. This animal possesses the capability of being domesticated, and, under the new circumstances in which it is placed, it varies in size, form, and colour, from the original stock. By careful selection of these variations, and by breeding from those individuals which show most strongly the points or qualities desired, certain varieties, or, as they are termed, ‘breeds’ of rabbits, are produced and perpetuated. Thus we have the lop-eared breed, the Angora breed, the Chinchilla breed, &c., &c., characterized by alterations in the length of the ears, in the colour of the fur, in the size of the animals, and so on. It is obvious that, by care, more new

varieties may be produced and perpetuated. Thus, by mating Silver-greys of different depths of colour, white animals with black extremities are often produced, and these have been perpetuated by mating them together. The breed so produced is known as the Himalayan variety, and, as it reproduces its like, is as pure and distinct a breed as any other that can be named. But, in the strictest scientific sense of the word, no particular variety of rabbit can be said to be a pure breed, as, like all the others, it is descended from the wild original. In the same manner, we may deny the applicability of the term pure breed to the varieties of any domesticated animal, even if, as in the case of the dog or sheep, we do not know the original from which they descended.

“All that can be asserted of the so-called purest-bred variety is that it has been reared for a number of years or generations without a cross with any other variety. But it should be remembered that every variety has been reared by careful artificial selection, either from the original stock or from other varieties.

“In the strict sense of the word, then, there is no such thing as an absolutely pure breed—the term is only comparatively true. We may term the Spanish fowl a pure breed, because it has existed a long period, and obviously could not be improved by crossing with any other known variety; in fact, its origin as a variety is not known. But many of our domesticated birds have a much more recent origin. Where were Game Bantams fifty years ago? the variety did not exist. They have been made by two modes: breeding Game to reduce the size, and then crossing the small Game fowl so obtained with Bantams. Yet Game Bantams, as at present shown, have quite as good a claim to the title of a pure breed as any other variety. In fact, every variety may be called a pure breed that reproduces its own likeness true to form and colour.

“The statement that Brahmas, Black Hamburgs, Dorkings, &c., are pure breeds is meaningless, if it is intended to imply anything more than that they will reproduce their like, which a mongrel cross between two distinct varieties cannot be depended on doing. There is no doubt but that many of our varieties have been improved by crossing with others. The cross of the bulldog, thrown in and bred out again, has given stamina to the greyhound; and although generally denied, there is no doubt but that the Cochin has in many cases been employed to give size to the Dorking. In the same manner new permanent varieties of pigeons are often produced, generally coming to us from Germany, in which country the fanciers are much more experimental than in England, where they adhere to the old breeds with a true John Bull, or bulldog like, tenacity.”

If we apply this reasoning to the fowls at present under discussion, there can be no doubt whatever that Brahmas have as good a title to the designation of a pure breed as any other variety whatever, inasmuch as they breed perfectly true to form, general characteristics and colour; no more than this can be said of any variety, even the oldest of which we have any record; and it is comparatively immaterial whether they originated ten or ten hundred years since.

Having given, as far as practicable, the history of the origin of Brahmas, it is

now necessary to enter into a consideration of their characteristics and general value as useful poultry.

In giving the characters of this breed we shall do so in accordance with the rules laid down in "Standard of Excellence in Exhibition Poultry," published for the Poultry Club by Messrs. Groombridge and Sons. This we do the more readily as the characteristics of the Brahmas, as given in that work, were most carefully compiled by Mr. R. Teebay, of Fullwood, near Preston, who was for many years pre-eminently the most successful rearer and exhibitor of this magnificent variety.

Brahmas are doubtless the largest of all the varieties of domestic fowls; it is within our own knowledge that cocks have been shown weighing the almost incredible weight of seventeen pounds, which considerably exceeds that of any other breed. Of course such a weight is above the average, but there is no doubt that no other fowls, Cochins not even excepted, are equal in bulk to well-bred Brahmas.

The form of the body corresponds with the great size. The breast in both sexes is very full, broad, round and prominent. The back is short, very broad between the shoulders and across the hips, the saddle feathers being particularly abundant, and forming in the hen a soft cushion rising towards the tail. The neck should be neatly curved, slender near the head, but very full below, the neck hackle feathers reaching well over the shoulders, so as to contrast strongly with the short hackle feathers and snaky neck of the Malay. The wings should be but small, held tightly by the body, and with the tips of the quills well covered by the saddle feathers; the cock's tail, though small, should be carried erect, the sickle feathers often spreading out laterally, as in the black-cock, the base of the tail being well covered by the abundant tail coverts, which in the hens almost entirely conceal the short upright quills. The fluff should be exceedingly abundant in both cocks and hens, well covering the hinder parts of the body, and standing out from the thighs, so as to give the birds the appearance of being very broad and deep when viewed from behind.

The thighs are large and muscular, well covered with soft feathers, which should curve round the hocks so as to hide that joint. Projecting vulture or falcon hocks are decidedly objectionable, though not to be regarded as an absolute disqualification when found in a show-pen. The shanks should be rather short, stout, placed wide apart, and abundantly feathered down to the outside of the outer and middle toes.

The head in the Brahma should be moderate in size, compared with the bulk of the bird, and surmounted with a triple comb, known as a pea-comb; this should be small, low in front and firmly set on the head, without falling over on either side, distinctly divided, so as to have the appearance of three small combs joined together in the lower part and back, the largest being in the middle, and each part slightly and evenly serrated.

This description of the comb is applicable to that of both sexes, due allowance being made for its smaller size in the hen. When first introduced, many of the Brahmas had single combs, closely corresponding in shape and size with those of



LIGHT BRAHMA COCKEREL.

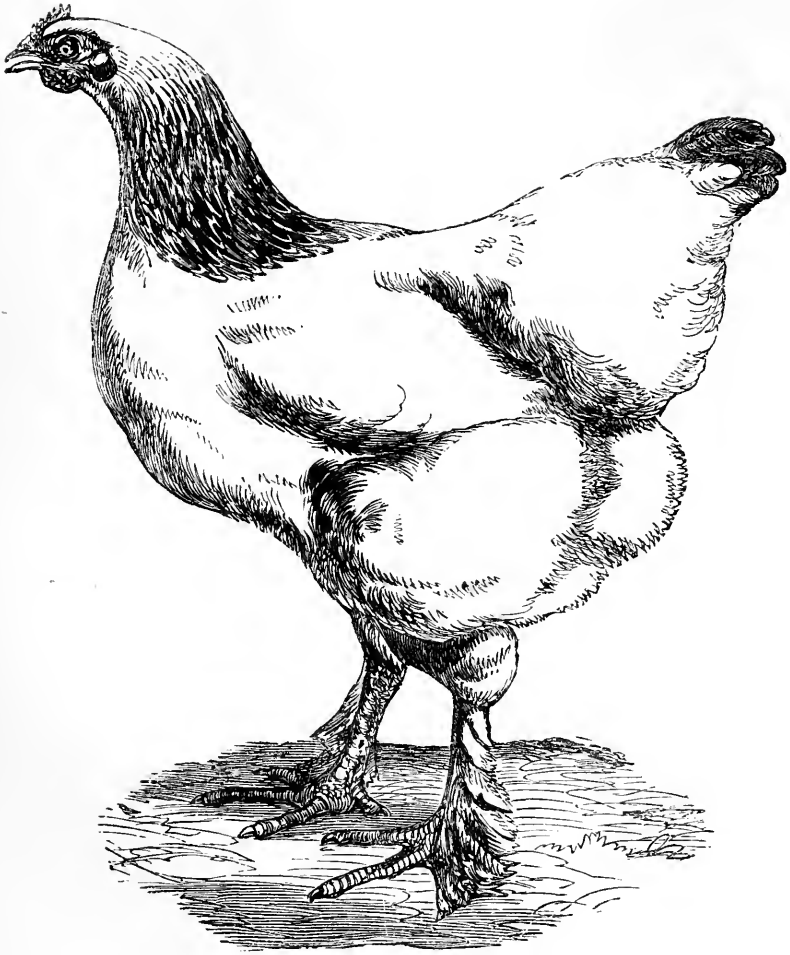

LIGHT BRAHMA PULLET.



the Cochins: at the present time, those possessing pea or flat triple combs are held in much higher estimation. The deaf-ear or ear-lobe is large and pendant in both sexes, the wattles comparatively small and well rounded.

The characters of the breed, as above given, apply to both the lighter variety first introduced, and now universally known at our poultry shows, as Light Brahmas, and also to the darker, or, as they are frequently termed, the Pencilled birds; but the colour of these varieties is so distinct that they will require a separate description at our hands.

The Light Brahmas are characterized by the general white colour of the body, breast, and thighs. The neck hackle should be marked with a distinct black stripe down the centre of each feather; there is a tendency in the cocks to come light in the hackle—a defect which very greatly detracts from the beauty of the birds. The saddle feathers in the cock are also striped with black, those of the hen being white. The first ten flight feathers, or primaries as they are termed, are black; but as the secondary quills, which alone are visible when the wing is closed, are white on the outer web, consequently the dark colour of the wing is not visible when folded. In the cock the tail is black, the tail coverts being beautifully glossed with green, the lower ones being margined with silver, as are the two highest tail feathers in the hen. The shanks in this variety should be brilliantly yellow, well clothed with white feathers slightly mottled with black.

The contrast of colour afforded by the white plumage, delicately picked out with black, and the brilliant red of the face, comb, ear-lobes, and wattles, render these birds particularly attractive; hence they are never without their admirers, and the Light Brahma class is always a striking one at the poultry exhibitions. The accompanying engravings represent very accurately the arrangement of the colours and markings on a light cockerel and pullet of the single-combed variety.

The Dark or Pencilled Brahmas are very distinct in colour from the light variety. We will take the description of the cock in the first instance. The upper part of the body, including the neck hackle, back, and saddle, is silvery white striped with black; the breast, under part of body, and thighs black, slightly mottled with white. The feathers that cover the bases of the quill feathers of the wings are of a metallic green black, and form a broad well-marked bar across the wings. The quill feathers of the wings, or flight feathers, are white on the outer and black on the inner webs. The secondary quills, those visible when the wing is closed, have a broad dark green black spot at the end of each feather. The tail is black, the coverts on either side being of a beautiful lustrous green black, the lesser feathers being edged with white. The shanks should be of a yellow colour, which sometimes partakes of a dusky shade, and they should be well clothed with dark feathers slightly mottled with white.

The colour of the hens may be briefly described. The head is grey, the neck hackle silvery white, striped with black. The remainder of the plumage, says Mr. Teebay, should be dull white, minutely and distinctly pencilled throughout with

dark pencilling, so closely as almost to cover the ground colour; the pencilling reaching well up the front of the breast.

The dark or pencilled birds have steadily progressed in public favour since the date of their first introduction; their gigantic size, great weight, hardihood, and prolificacy, and the ease with which they can be kept in confined ranges, all tend to render them esteemed by the public at large; whilst the nobleness of their appearance and the truthfulness to which they breed to feather, cause them to be highly valued as the favourites of a vast number of the most enthusiastic of our poultry fanciers.

Respecting the value of Brahmas as profitable fowls, Mr. Teebay has favoured us with the following communication:—"There is no variety so suitable for a wet, cold situation as this; they even appear to enjoy being out in a drizzling rain, searching for insect food round the edge of any small piece of water they meet with; if they have an unlimited range they are great ramblers, remaining out later at night than any other variety that may be in the same run; they are good layers, especially during the cold winter months; they, however, do not want to sit so often as the Cochins, and are far more easily cured of their broodiness. When allowed to hatch, they cannot be surpassed as mothers, no fowls being more careful not to step on their chickens, brooding them better, or searching more diligently for insects for their food.

"Brahmas are good table-fowls, the pullets being remarkably full of white meat on the breast, and they lay on flesh very quickly when put up to fatten. The chickens grow with great rapidity, and are very easily reared. I have weighed a cockerel at seven months and two weeks old that weighed 10lbs. 4 oz., and have seen several cocks under two years old that weighed 15lbs. each. At four or five years old these large cocks become so heavy that they are generally to be seen resting on their hocks or lying sideways on the ground, although at the same time in the best possible health; if in this state they are supplied liberally with soft food, they will gain weight very fast and make enormous birds. The average weight of the pullets at five months old is about 7lbs. I may remark that weight is not a good criterion as to the size of Brahmas, for if taken from an open run and confined in a very small place and liberally fed, they lay on flesh so fast that they will occasionally add from one-fourth to one-third of their weight in three weeks, depending on the state of the fowl when put up. There is no variety of domestic fowls that breed more true to colour than the two kinds of Brahmas, if they are kept distinct, but should there be the slightest intermixture of the two varieties, in the birds that are bred from, few of the pullets will be fit for exhibition, and there will be but seldom two alike in colour or markings in the same brood.

"The pencilled birds that have the slightest mixture of the blood of the light variety will breed pullets light on the breast, with sandy coloured patches on the shoulders; and even should they occasionally produce a pullet well pencilled during

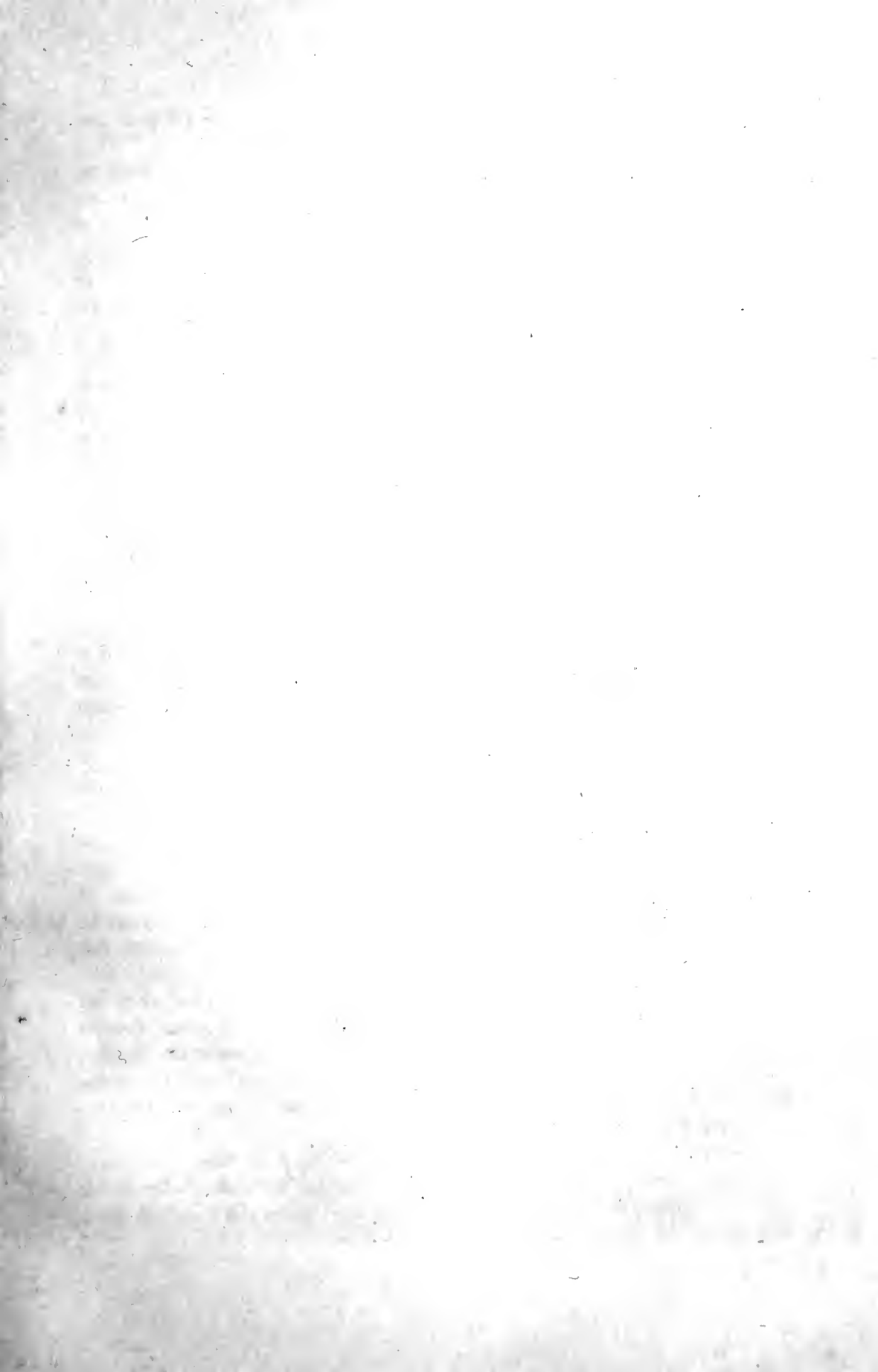



LEIGHTON, BRO.

DARK BRAHMAS.



the first year, she will most likely moult brown on the shoulders, and become quite unlike her original colours in her second season. A few of the cockerels so bred are pretty fair in colour, but they are always far more spotted with white on the breast than the true-bred pencilled birds; hence by some persons they are preferred, as they look gayer in colour to the eye, but if the fancier that admires these cocks once breeds from them he will never again choose another male bird for the beauty of his breast.

“Light Brahmas that have the least mixture of the pencilled breed in them breed pullets with sandy buff-coloured backs and wings, some darker and some lighter, but seldom produce pullets clear white on the back. These pullets also moult much worse in colour in the second year; they are very frequently much marked on the lower part of the back, many of the cockerels have cream-coloured hackles like those that are bred from a light Brahma hen and a buff Cochin cock: the birds from this latter cross, however, are so different in shape from the true Brahmas that they are easily known by any one who has tried the experiment, though occasionally a cockerel is produced without creamy hackles and much like a true Light Brahma in colour.”

Mr. P. Jones, one of the earliest admirers of Brahmas, thus sums up the value of Brahmas as profitable poultry:—

“The chief points of merit in both varieties of Brahmas consist, first of all, in their hardihood and rapid growth as chickens, cockerels at four months old frequently weighing over 5 lb., and early pullets sometimes laying at the same age. If required for culinary purposes, they will be found at this age to possess whiter, more tender, and juicier flesh than Cochins,—will also stand confinement in a small space equally well; but if they have the advantage and opportunity of a run, will forage for themselves much better. In common with their first-cousins, they are most excellent winter layers, and do not *age* so soon; some hens at four and five years old looking, after moulting, and in a good run, as fresh as two-year-olds.”

In concluding our account of these birds we cannot do better than quote the following very fair description of their merits from the pen of one of their oldest admirers:—“Brahmas,” writes Miss E. Watts, “as good useful hardy fowls, are unsurpassed. They are good layers of good-sized eggs, good foragers (when they can have their liberty), and good sitters and mothers. The chickens fledge more kindly than the Cochins, grow fast, and are exceedingly hardy; old and young take good care of themselves, and often recover from ailments which would carry off any of a less hardy sort. We know no other chickens which are so hardy as they, and reared with so little trouble and loss.

“We have no hesitation in pronouncing these the most useful fowls we have kept. They are very good for the table, putting on flesh readily, and being much more juicy and much better in form for this purpose than the generality of Cochins. They are decidedly smaller eaters than Cochins, and greater lovers of an extensive range, which they turn to account in foraging for themselves. Notwithstanding,

however, their love of liberty, they bear confinement as well as any fowls. In a dingy, dirty, or smoky locality, Brahmas keep clean better than any other fowls which have white in the plumage. The hens sit less frequently than Cochins, and a week's change of place will generally make them give up the fancy.

“Whether Brahmas form a distinct variety, or whether they are a made kind, commenced with a cross and established by careful breeding, is a question of little importance. The accusation has been brought against them that no one for a certainty knows their origin; and may we not say the same of all our best varieties of fowls, with only the difference of going a few years further back? Whatever may have been their origin, they are now distinct and true to their characteristics.”

CHAPTER VIII.

MALAYS.

THE precise origin of the Malay fowl, like that of all other varieties of our domesticated animals, is lost in the obscurity of the past. Whether, as generally suggested, it is a descendant of a supposed wild breed, the so-called *Gallus giganteus* of Temminck; or whether, as is rendered far more probable by the researches of Mr. C. Darwin, it, like all the other domesticated Gallinaceous birds, is derived from a single wild species, the *Gallus Bankiva*, is a point more fitted for discussion in a strictly scientific treatise than in a practical Poultry Book; and we must, therefore, refer those who wish to enter more fully into this matter, to the forthcoming work of Mr. Darwin on variation in animals.

The Malay has been for many years the type of bird most frequently kept in a domesticated state in many parts of the East. The cocks employed in the cock-fights in India and the adjacent islands are not English game, but a breed of Malays that are sometimes shown at our poultry exhibitions under the title of "Indian game fowls."

For many years the stewards of the vessels trading to and from India have been in the habit of bringing home Malay fowls, and consequently good specimens may not unfrequently be purchased at the dealers' in the neighbourhood of the Docks at the east of London.

Although never constituting large classes at our poultry shows, Malays have always had their admirers; and previous to the introduction of Cochins and Brahmas, were of necessity had recourse to in all cases where it was required to throw size and weight into the ordinary poultry of the farm-yards by means of cross breeding.

The imported birds are somewhat various in their markings, but by the careful selection of breeding stock the colours of our show-pens are rendered as fixed and definite as those of any other variety.

The following account of their characteristics is mainly compiled from information with which we have been favoured by Mr. Hewitt, and by Mr. Charles Ballance, of Stanley House, Lower Clapton, formerly of Taunton, Somerset, well known as a most successful breeder and exhibitor of this variety.

As regards size, Malays may be regarded as worthy of their supposed descent from the Kulm fowl, or *Gallus giganteus*. The cocks should not weigh less than from nine to eleven and a half pounds, and, when full grown, should stand from two feet nine inches to three feet high, and be able to peck off an ordinary table

with ease. The weight of the hens should not be less than seven and a half pounds, good specimens being even as heavy as ten pounds.

In carriage and form, Malays are strikingly distinguished from all other varieties of domestic poultry. The cocks are exceedingly long in the neck and legs; their carriage is particularly upright, the back being almost always at an angle of 45° , except when they are eating: the wings are carried very high, and firmly closed. Malays are very bulky across the shoulders, and, from the closeness of the plumage, the fore part of the wing stands away from the body, as it does in the carrier pigeon. The body narrows very rapidly indeed towards the tail, which is very small, and droops in the cock so as nearly to form a straight line with the back; the thighs are long, strong, and well developed. The longer and stronger the legs the better, if length be combined with an easy gait in walking. The head is carried very high; and from the short and very scanty nature of the hackle-feathers, the neck looks much longer than in any other variety of fowl. The form and carriage of the hen are generally similar to those of the cock; but from the hackles being still shorter, the extreme prominency of the wings is even more visible.

The plumage in Malays is short and close, but exceedingly brilliant and glossy. Every feather, observes Mr. Hewitt, is peculiarly narrow, and possesses far less down towards the root than do the feathers of any other known variety; the plumage therefore, lies as closely as do scales upon each other; and, consequently, should the bird be taken in hand, it always proves much more weighty than is anticipated. The extraordinary lustre of the entire plumage in well-bred and high-conditioned birds is remarkable.

The head in the Malay is long and snaky, the brow projecting over the eye so as to give a peculiarly hard expression to the face. The eyes should be bright fiery red, as according best with the restless and vindictive expression of the face; but pearl eyes are found in good specimens. The beak is very strong and hooked. The comb is very small, low, and flat, and is attached closely to the head, without any tendency to fall over to either side. It should be covered over with small warty prominences, and end abruptly over the eye, not projecting in a peak.

Malays are remarkably characterized by the very slight development of wattles and ear-lobes; but the skin of the face and upper part of the throat is red, and, from the scanty nature of the plumage, this redness becomes a marked feature of the breed. The countenance has been justly described as very skinny.

In colour Malays vary considerably. The varieties generally exhibited partake of the colour of black and brown breasted red game. In these, the hackle and saddle in the cock should be dark glossy red; the breast black, or black slightly mottled with brown. The back and shoulder coverts are deep rich maroon; the bar across the wings wide, and well marked with a bright metallic or purplish green black tint.

The flight-feathers or quills should be dark red, and the tail-feathers small, black, and glossy to an extreme degree, being resplendent with purple and green metallic reflections, as the light plays upon them in the movement of the bird.

The legs in both sexes should be characterized by strength and size; in colour they should be brilliant yellow, and without a vestige of feathers appearing on the sides.

The general colour of the plumage of the hens in this variety is reddish brown, verging into that of wetted cinnamon in the darker breeds.

In the Pile Malays, now so seldom seen, the hackles in the cock are red and white; the breasts white or mottled, and the general plumage of the hens white, mottled with chestnut red.

The plumage of the White Malays is soon described: the face, comb, and naked skin of the throat should be bright red, the feet and legs bright yellow, and the feathers purely white.

With regard to the general habits of Malays, Mr. Hewitt states:—"I am not aware of any variety of fowls so cruel, oppressive, and vindictive as Malays; they are literally, when kept with other varieties, the tyrants of a poultry-yard. From their great strength, they are able to inflict severe injury on their opponents, frequently treading them down, and then actually tearing them to pieces. They, however, appear rather to rely on their superior physical strength than on their real courage and activity, for I have frequently known an agile, sharp-fighting Game-cock (not, perhaps, one-third their own weight) make them cower almost immediately, and run into the first corner that offered itself for temporary protection;—but, on the contrary, any want of self-possession manifested by their opponents is certain to be taken advantage of; and with an irresolute cock they will continue fighting with the most pertinacious obstinacy.

"In confined premises they very frequently contract a most injurious habit of eating away each other's plumage, which they continue to so great an extent as eventually to seriously affect the constitution of the fowls thus attacked; constantly plucking away the half-grown feathers, and sometimes eating large portions of the skin, occasioning serious inflammatory disease. The upper part of the neck, throat, second joint of wings, and the thighs, seem to be the points in their victims most alluring to birds that have contracted this truly depraved habit. I have proved that a more extended range, plenty of green food, and a little very fine bone-dust (mixed with their soft meat) will speedily correct this evil; indeed, my own impression is that the habit is often acquired, when Malays are too closely confined, from a spirit of pure idleness, arising from listless inactivity. The birds at the onset eat feathers that, having been accidentally shed, were lying about in places where they were accustomed to stand to sun themselves. Sometimes when the evil practice has been too long persisted in, the plumage, when restored, is quite altered in colour (becoming a dirty grey, or even actually white), giving the bird a piebald appearance, which even several moults will not rectify; for in such cases I have known this party-coloured feathering to continue for many years, even until the fowls died of natural decay. For this reason, the more expeditious the means used for prevention the better; as fowls such as those just described, or those in a state of semi-nudity, are certain of non-success in the exhibition pen, however

perfect in all other traits of character. Malays are especially prone to quarrel among themselves if closely confined, for which reason they not unfrequently prove most troublesome when penned for purposes of exhibition; indeed, there are but few among our poultry-show committees who cannot look back with feelings of horror to the torn and mangled state of some pens thus entrusted to their care, although previously to their confinement the fowls were the best of friends, and sent in the first instance quite uninjured. From this peculiarity, and the fact that few entries are generally made in the Malay classes, some poultry exhibitions have been held where they have been altogether excluded from competition. But it is greatly to be regretted that prizes should be withheld from a variety of fowls that, despite some failings, are certainly not without many truly good qualities, besides being a perfectly distinct variety.

“When full grown, Malays are unusually hardy fowls; and the quality of their eggs is very superior; they are, however, small in comparison to the size of the bird itself, and the extreme strength of the shell is remarkable. True-bred Malay chickens are very long in attaining their first feathers, from which cause they are somewhat easily chilled, and consequently are apt to become stunted and deformed, more particularly in the feet and legs. Although extremely long in the legs and thighs, these birds possess breasts, wings, and merry thoughts that surpass those of most fowls in the amount of flesh on them, and when the birds are killed at an early age the meat is of good flavour. But the chief advantage of the Malays is to be obtained by using them for cross-breeding with any other of our large varieties. The produce of the Malay and Grey Dorking is a most extraordinary table-fowl, carrying incredible quantities of flesh, principally in those parts most esteemed. The pullets of this cross lay far more freely than Malays, but the chickens (to maintain their gigantic proportions) must be confined strictly to the first cross. Chickens thus obtained feather quickly, are hardy, and very easily reared. The best cross is for the female parent to be the Dorking, as the body of the fowl thus bred is far larger, better covered with flesh, the colour of the skin is whiter, and the flavour superior.

“The cross-bred birds between the Malay and Cochin are not by any means so good for the table; but excel the pure-bred Malays in the quantity of eggs they produce.

“There are many varieties of Malays, among which one of the most beautiful I have yet met with is the purely white. They possess all the characteristics of their darker-coloured associates; but the striking contrast between their clear unsullied plumage, and intensely yellow beak and legs, brings them into very advantageous notice. I am told—although it is contrary to the general rule—that they are more easily reared than the dark-coloured ones. A most beautiful breed of Red Piles is obtained by crossing the black-breasted red and the white: their plumage is extraordinarily good, and by some amateurs they are highly esteemed. The bird called the Kulm fowl is simply a grey variety of Malay; whilst the fowls that have frequently appeared of late at our poultry shows under the title of ‘Indian





MAHAY DOCK.





Game,' evidently possess all the principal characteristics of this class of poultry. Unless frequently crossed to obtain fresh blood, closely bred Malays quickly lose size so materially that, in a few generations only, they become but very little larger than common fowls. Even when thus degenerate, however, a couple of years of well planned and careful cross-breeding (with fowls of their *own* class) at once will raise the progeny to the original gigantic standard. They should be renewed frequently, for this reason, at farthest once in three years."

The subject of "in and in breeding" has always been one of great dispute between different rearers of live stock of all descriptions; one party, like Mr. Hewitt, maintaining that it is fatal to hope for large size and constitutional vigour if it is persisted in; their opponents, on the other hand, asserting that when you have obtained perfection, in and in breeding must be partially followed in order to preserve it. Mr. Ballance, one of the highest authorities on all points concerning Malays, has favoured us with his views on the matter. He states—"There is one remark I should like to make for the benefit of amateurs, now that my opportunities for exhibiting are likely to be few and far between. It has reference to what I believe has been the secret of the success I have experienced with Malays, both coloured and white, for a period of nearly thirty years. During the whole of this period I have never allowed the introduction of any fresh blood by crossing with any other strain of Malays, but have kept entirely to my own breed; and as I have succeeded in winning more prizes with Malays than any other fancier of these much-abused but most valuable birds, in all parts of the kingdom, I think my experience is not to be despised, as testifying to the fact that breeding in and in does not necessarily deteriorate the birds who may be subjected to this operation; but then all depends upon how the breeding in and in is managed. If a person has one yard only, and allows the produce to continue cross-breeding without any discrimination, then the worst effects will follow, and the birds get small and weedy; but my plan has been to keep about five or six distinct runs, and to rear about two to three hundred chickens each year, and select the best birds from each run for crossing to make up my yards the next season. I thus secure sufficient crossing to prevent deterioration, and by judiciously selecting about two dozen birds, the pick and choice of nearly three hundred, I have been able to produce each year specimens for exhibition superior to their parents of the year preceding, and leaving all other competitors far in the distance. I believe the same management would apply and be found to answer with any other breed."

The Rev. A. G. Brooke, of Ruyton-Eleven-Towns, a well-known and most successful exhibitor of this variety, has furnished us with the following valuable notes on the rearing and general management of these birds in ranges of limited extent. He writes:—"About eight years ago I purchased a pen of light Malays; with these I won the silver cup at the Bath and West of England Show, held at Barnstaple in 1859, and with the same birds the silver cup at Dorchester in 1860. The chickens bred from these birds were all light; and finding that the judges at various shows passed them by in favour of dark ones, I disposed of them, and

afterwards fortunately obtained some imported birds (a cock and two hens) in the neighbourhood of the London Docks. With these and their chickens I had great success, and still continue to have the same strain. I have now for some years bred in and in, having been unable to procure another imported cock, nor have I found that by so doing they have very much decreased in size. Chickens hatched in March and April generally thrive remarkably well; but they require, perhaps, rather more care than other sorts, if the season be damp or cold, as they have a most noticeable paucity of feathers. Malays will bear confinement—mine have generally done so, and looked healthy and well. They certainly are disposed to be savage and irritable if kept long without food; but for some time past I have managed to keep the peace by letting them have food and water constantly by them, in their houses. When thus treated, neither do they eat half so much. Malays are the only variety of poultry I have had for years, and experience has taught me that it is best not to keep more than a cock and two hens in one run, especially when intended for exhibition, as by this means they are thoroughly used to each other before being penned at shows. It is a great thing to keep them from excitement. My runs are so arranged that the birds cannot possibly see their neighbours. The runs should be kept sweet and clean, the soil frequently removed, and fresh earth substituted; it is also necessary to let the birds have a heap of ashes in a corner protected from the rain. Their houses should be cleansed and lime-washed oftentimes during the year; their perches should be very broad, and thickly bound round with carpet to keep their breasts from getting bare. The perch should not be very high, just room enough left to allow the cock to walk under it, and straw should be thickly laid for them to alight upon, as they fly to the ground with great force. I think they might easily be kept within bounds. My runs are all enclosed with the exception of one, where the birds are every day let out on a grass plot, the boundary being merely galvanized wire, a yard high; and they never attempt to fly over, though one great inducement to stay at home is no doubt their having corn, green meat, and water constantly by them. The food I find they like best is Indian corn and potatoes mashed up with meal. Meat, or bones to pick, should always be avoided. They require a plentiful supply of green food; I have hundreds of cabbages and lettuces planted yearly for them, and it is astonishing how soon they disappear. The lop comb I always look upon as a great mistake, having never seen it in imported birds. The eggs they lay are dark and rich; and the chickens are plump and very good eating: the legs, on account of their length, are rather unsightly for table. A friend of mine last year crossed some Dorking hens with a Malay cock, and the chickens were remarkably fine and heavy. During the past season I have had far more applications for pens of Malays than I have been able to supply; and I sincerely hope not only to see the Malay classes at poultry shows better filled than they hitherto have been, but that those who have up to this time condemned them may be induced to give them a trial."

The remarks of these eminent authorities on this particular breed so nearly

exhaust the subject that little remains to be added respecting it. With regard to the breeding stock, Mr. Ballance states that his experience goes to prove that the male bird has the greatest influence over the colour of the chickens, and the female over the size—this latter character, however, being much dependent on the system of management and feeding adopted whilst the birds are in their earliest stages of chickenhood.

Malays lay moderate-sized eggs, averaging about two and a half ounces each in weight. The shells usually are coloured—a pale chocolate. The size and colour, however, vary; for pullets under a year old sometimes lay eggs equal in size to those of any description of duck, and some hens two and three years old lay eggs very little larger than those of a good-sized bantam. Some eggs are as white as a Spanish hen's egg, and others vary from a light cream to a deep rich buff, and even to a brown. As a general rule, the light-brown birds are produced from the darkest eggs, and the dark-brown birds from the cream-coloured or paler eggs.

Malay hens are moderately good layers, and exceedingly good sitters and mothers; but from their irascible character they do not admit of being handled and shifted about during the period of hatching in the same manner as Cochins.

Of the cross breeds of Malays, several have already been described. There remains, however, a breed known as the Pheasant Malay, which occasionally makes its appearance in the "any other variety" class at the poultry shows. These birds are small spangled-breasted fowls, probably obtained by crossing the Malays with a spangled breed like the Hamburgs. In their plumage they are sometimes especially beautiful; but they want the definite characteristics of a very distinct variety, and consequently do not appear likely ever to attain to the honour of having a separate class at our shows. In the United States of America, a large variety of Malay was formerly held in much estimation, being known as the Chittagong—a name which, according to Mowbray's Treatise, was formerly used in this country as synonymous with that of Malay.

CHAPTER IX.

THE COLOURED DORKING FOWL.

HAVING treated of those breeds that, from their recent Oriental origin, may perhaps be appropriately termed Asiatic, we now come to the consideration of that breed of fowl which is pre-eminently one of the most marked of English varieties, namely, the Dorking. But we are met at the threshold of our subject with the question of its origin. In most of the books on poultry it is generally stated that the coloured Dorking is descended from the fowls brought here by the followers of Cæsar and his legions, and described by the Latin author Columella, who, when treating of the poultry kept by the Romans, states—"It is not advisable to buy any but such as are very prolific. They should be of a plumage very red or tawny, with black wings. Let the whole be of the same colour, or of a near approach to it. But if of any other colour, let white fowls be avoided, for they are tender and less robust; neither is it easy to find specimens of them that are prolific. Let the breeding hens be of a choice colour, of robust body, square framed, large and broad breasted, large-headed, with small, erect, bright-red comb, and white ears; and of those thus characterized let the largest be procured, and not with an equal number of claws. Those hens are reckoned of the purest breed which are five-clawed, but so placed that no cross spurs arise from the legs; for she that has this male-like appendage is rarely fruitful; and when she does sit she breaks the eggs with her sharp claws.

"The cocks should be lustful, coloured like the hens, with the same number of claws, but taller; proud of carriage; combs erect and blood-red; eyes brown or black; beak short and hooked; ears very large and very white; wattles looking whiter from their shining, and hanging down like a beard; the feathers of the neck or mane varying, but preferably from yellow to golden, and spreading down over the shoulders; the breast broad and muscular; the wings brawny, like arms; the tail lofty, and composed of a double row of arching feathers, alike on each side; the thighs ample, and usually thickly clothed with coarse feathers; legs sturdy, not long, but armed as it were with dangerous spears. Even when neither prepared for fighting nor for the triumph of victory, their temper should be shown to be highly generous, haughty, active, watchful, and given to crow often; also not easily alarmed; for sometimes it will be needful for them to repel attacks, and to protect their conjugal flock."

There are, however, many difficulties in the way of the supposition that our Dorkings are descended from the Roman fowls. By far the most probable supposition is that the grey-coloured Dorkings are composite fowls, deriving, in all probability,

their size and aptitude to fatten from the large Surrey or Sussex fowl; their fifth toe and rose-comb, when present, from the old white Dorking, which has been crossed with the four-toed Sussex or Surrey fowl, and has produced a breed superior in size and quality to almost any other as a table-fowl. This composite character of the breed is perhaps the reason why so much care is required to produce them true to colour, or even in many cases to comb. It is singular that the English table-fowl, the Dorking, and the French table-fowl, the *Crève-cœur*, should both be, as they evidently are, composite breeds, produced in a long series of years, during which time the object of the rearers has certainly been to obtain a first-class table-fowl by breeding from any bird whose size or form was likely to improve the original stock.

Leaving the determination of the vexed question of the origin of the coloured Dorking to the consideration of poultry archæologists, we enter at once on the consideration of the characters of this breed. In all varieties of Dorkings size is a most important consideration, and in the coloured breed unquestionably the most important. The body in both sexes should be large, deep, and plump; in the cock it should almost form a square when viewed from the side. The back and the breast should be very broad. The legs in all the varieties should be white in colour, stout in form, and perfectly free from feathers, and the cock should be spurred on the inside of the leg—not, as is occasionally seen, on the outer side. The feet must be five-toed, and the extra toe should be well separated from the others and turned upwards. The head should be proportionate to the size of the bird; the wattles well developed. The comb in the Dorking varies considerably; it may be either single or rose. Single-combed cocks should have the comb erect and free from side sprigs; but there is a great tendency in many good birds to have the combs lopping over to one side. In the rose-combed birds, the combs should be square in front, and ending in a raised peak behind, without any depression in the centre. The appearance of the Dorking cock is greatly improved by his possessing a large, well-formed tail, which should not droop, but be carried well over the back. In the classes for coloured Dorkings at the poultry shows, the exact marking as to colour is not regarded as a matter of moment, provided always the birds match in the pen. But of late years the breed known as Silver Greys have come into high estimation, as they conjoin many of the good qualities of the coloured breed with the beauty of plumage possessed by those birds that are regarded more especially as ornamental poultry. In this latter variety the colour of the plumage is important, as a single white feather in the breast or tail of the cock is held as a disqualification in a show-pen. It is necessary, therefore, to give the characteristics of this breed as distinct from those of the ordinary coloured or grey birds.

In size, the Silver Greys rarely equal the coloured breeds. The form of the body, however, should be identically the same; and the like remark also applies to the comb, wattles, feet, &c.

The distinguishing colours of the Silver Grey Dorking cock are, a perfectly black breast, tail, and larger tail coverts; the head, neck, hackle, back, saddle, and wing bow a clear silvery white. Across the wings there should be a well-marked black bar, contrasting in a very striking and beautiful manner with the white outer web of the quill-feathers and the silvery white hackle and saddle.

In the hens of this beautiful variety the breast is salmon-red, passing into grey towards the thighs. The neck is silvery white, striped with black; the back silvery grey, with the white of the shafts of the feathers distinctly marked. The wings should also be of a silvery or slaty grey, and as free as possible from any tendency to redness. The tail should be dark grey, the inside being very nearly black.

Having given the general description of the two chief varieties of the Dorking fowl, in accordance with the dicta laid down in that recognized authority, the "Standard of Excellence," we now pass on to the consideration of the general management and profitable characteristics of the breed. On these points we have again to express our obligations to Mr. Hewitt, who has furnished the following valuable remarks:—

"There is not a doubt that coloured Dorkings are decidedly the most useful of all fowls for general table purposes; as not only is the flesh of extremely good quality, but it is produced in far greater abundance than in most varieties. Another very important point in the consideration of the Grey Dorkings is, that the greater proportion of the flesh will be found on those particular parts most generally esteemed—viz. the breast, wings, and merrythoughts; hence they carve to especial advantage. They also grow rapidly, and are in good condition at almost any age, if at all freely supplied with food. As layers, many other fowls are better than Dorkings; they do not thrive well without a good and extensive grass-run. The chicks are delicate youngsters to rear, particularly if the subsoil is not remarkably dry and warm: this will at once account for their unvarying success on chalky soil. In consequence of their great weight, they frequently, when aged, become quite lame and distorted in the feet and toes, from injuries producing eventually corns and even abscesses: these are most difficult to cure, if of long standing; but as a preventive, low perches are absolutely essential: they should never exceed two or three feet from the ground. Dorkings degenerate most rapidly in size and character from interbreeding; and from this cause, fresh blood should be frequently introduced, or the most speedy and vexatious disappointments will certainly ensue.

"In the selection of birds for showing, pains should be taken to ensure uniformity of colour throughout the pen; and monstrosities of conformation in the legs or feet must be scrupulously avoided. As these are frequent in otherwise good Dorking fowls, I will briefly point out a few I have met with. I have seen a pen faultless in other respects, in which a cock was placed with three hind toes on each foot; on another occasion, a male with the spurs growing directly outside the legs; whilst in a third I have known competing at various public exhibitions, the two back toes

were both situate midway up the leg (between the knee and foot), although the toes themselves were perfect. Grossly enlarged toes or feet are decided imperfections, and should be avoided in competition, although sometimes present in particularly good stock-birds. The dark greys are generally the most weighty hens in the hand, but from being more closely feathered deceive the eye; my own conviction respecting them is that they are naturally the most hardy in constitution. Abundant plumage tells favourably on Dorkings for exhibition, adding greatly to their 'squareness' of appearance and size at first sight; but, to be fairly judged, Dorkings must be handled. These fowls should not have heavy clumsy heads, but neat compact combs, moderate in size, whether rose or single; wattles neither coarse—loose, nor flabby; the combs should stand well on the top of the head—a lounging heavy comb looking very unsightly, although too often (by far) seen among our first-class competitors. Condition is really all-important with Grey Dorkings for exhibition; unless that is tolerably good, few fowls look so very disadvantageously as they do, nor do any, more generally disappoint the anticipations of their owners. If frequently competing, they mostly lose both health and weight very rapidly, as they endure close confinement but indifferently. In the present day, when weight is considered a great desideratum, many Dorkings have been irretrievably spoiled from over-feeding, so as to be quite unserviceable afterwards for general and useful brood stock.

“In this state of undue obesity they cannot breed well. It should not, therefore, be encouraged by parties who wish rather to increase their stock than to make idle boast of the attainment of great weights in isolated individuals. Mention is often carefully withheld of the comparatively numerous instances in which apoplexy has been induced by over-feeding, and the folly of the owners has been repaid by the sudden death of highly valued specimens. No doubt the extreme delicacy of constitution now so universally complained of among Dorking chickens whilst young, is mainly attributable to the weakened stamina of their progenitors; and in support of this opinion I have invariably found that the less artificially they are reared, and the more generally the parent fowls are allowed to take their own course, the more rude health has been displayed by the offspring, and the quantity surviving has been increased in due proportion.

“Much controversy has been maintained respecting the most approved conformation of the combs in Grey Dorkings as exhibition fowls; nor have either the rose or single combed specimens lacked strenuous supporters. Being essentially, beyond all others, the fowl for the table, I willingly acknowledge I have not any prejudice whatever in favour of either variety as regards this particular feature; and will confine myself altogether to my own individual experience as to a striking difference, at once perceivable, in the generality of cases that have been placed before me at our various public poultry shows.

“The rose-combed fowls almost invariably maintain a superiority for strength of build and massive proportions; but unfortunately this has, in the generality of

cases, been combined with a uniform coarseness of character, that told fearfully against them on the prize-lists. Still, this serious drawback is not universally prevalent; the rose-combed birds readily produce single ones, and *vice versâ*; but the desired character may be pretty closely perpetuated by carefully breeding for successive generations from either one of these varieties exclusively. For the reason before assigned, the rose-combed Grey Dorkings show to most advantage during their first year, compared with their condition when advanced in age. For the guidance of any inexperienced exhibitor, it is well to mention that the rule is strictly imperative that all the fowls in the same pen must be alike as to combs; for unless this be so, however good in other respects, their defeat is certain and inevitable."

Some few years since, the exhibitors of coloured Dorkings were startled by the remarkable size and character of the birds of this variety bred by Mr. Douglas, at the Wolseley Aviaries. At the present time Mr. Douglas is in charge of the aviaries of the Duke of Newcastle at Clumber; and we have lately visited that establishment in order to ascertain the method of management which formerly resulted in so great a measure of success. Mr. Douglas, who is universally recognized as one of the highest authorities on this breed, has kindly favoured us with the following notes on the characters and general management of this variety:—

"In selecting my brood stock, I look for massiveness in all quarters rather than for a neat head or short beak, choosing birds with strong backs, and long straight deep breast-bones; considering Dorkings entirely as table-fowl, I think it is more important that they should have straight breasts than any other variety shown. Looking at Dorkings from this point, there ought to be as much difference in point of shape between them and game-fowl, as there is between a cart-horse, with his large head, deep loins, and capacious chest, and a race-horse, with fine neat frame and slender limbs. The colour in Dorkings, except in the silver grey variety, is not material; but I have found the dark colour the most hardy and heaviest fleshed, having once had a cock of that colour weighing 14½ lb. at two years, and several hens 11 lb. each. With regard to the general characters of the brood stock, I will describe those of the two sexes separately, beginning with the male. The cocks may be either single or rose combed. The single comb should be erect; but a slight lop at the upper part is not so great a drawback as in a Spanish; therefore, if all other points are well developed, I consider it but a slight defect. The rose-combed cocks should have their combs well and firmly set on their heads, square in front, level in the spikes, and forming a peak or point at the back of the head. The head in the Dorking, though not coarse, should be large, to correspond with the size of the body. The wattles should be broad and fine, and neatly rounded on the lower side. The neck should be long, stout, and profusely hackled with long feathers, but there should not be any thickness commencing a few inches from the head and forming a sort of shoulder in about the middle of the hackle. The breast should be very

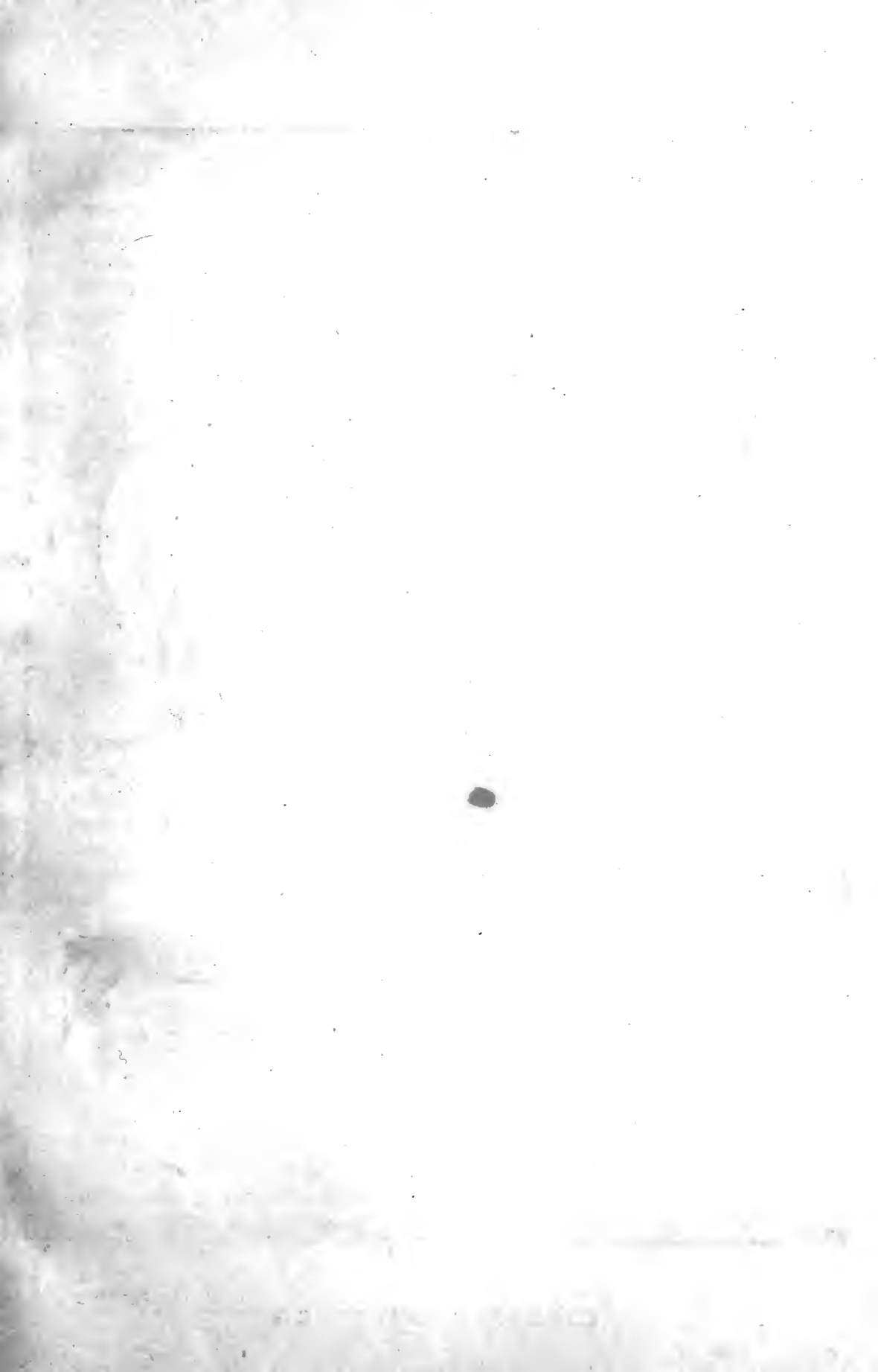

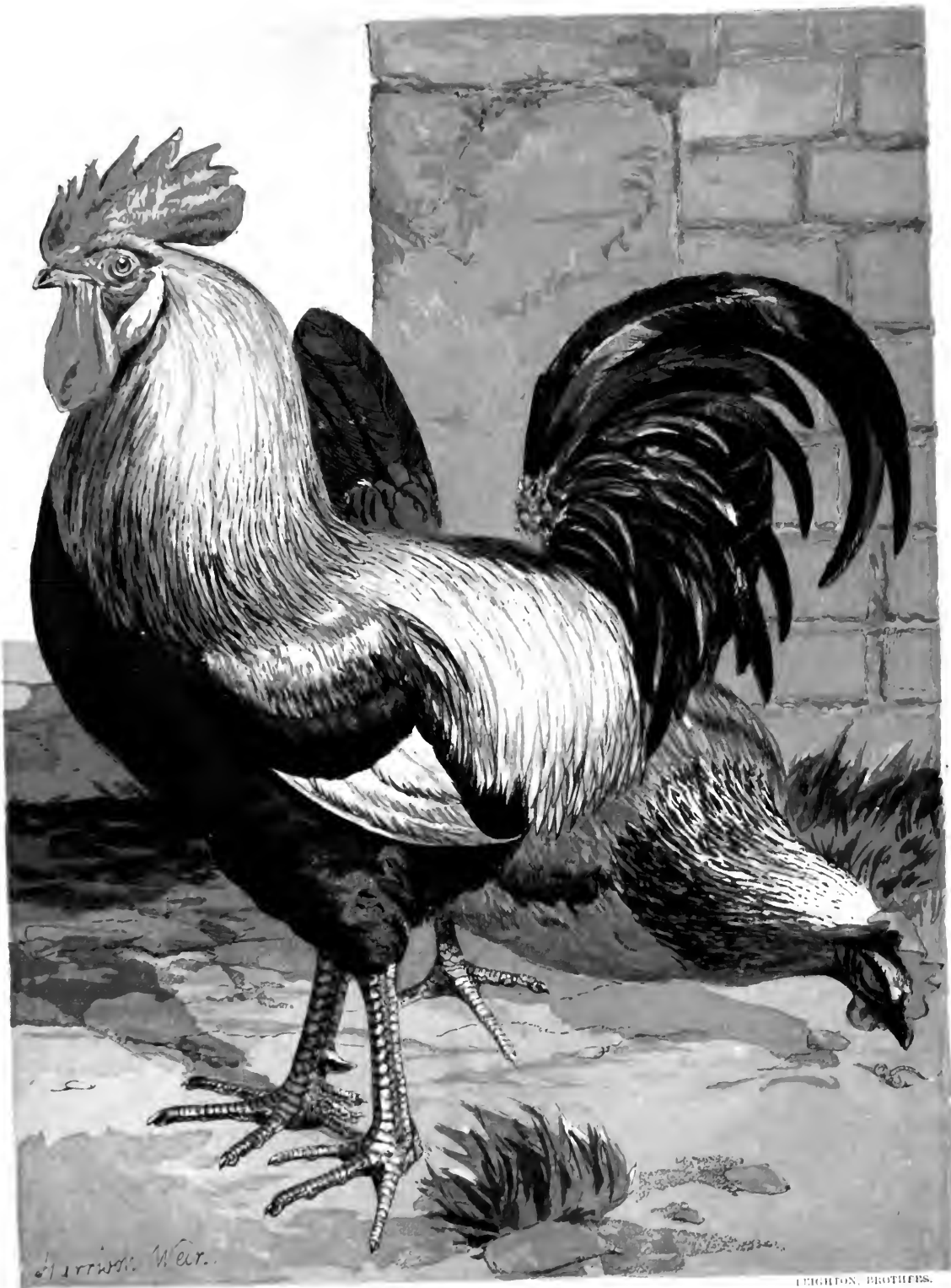

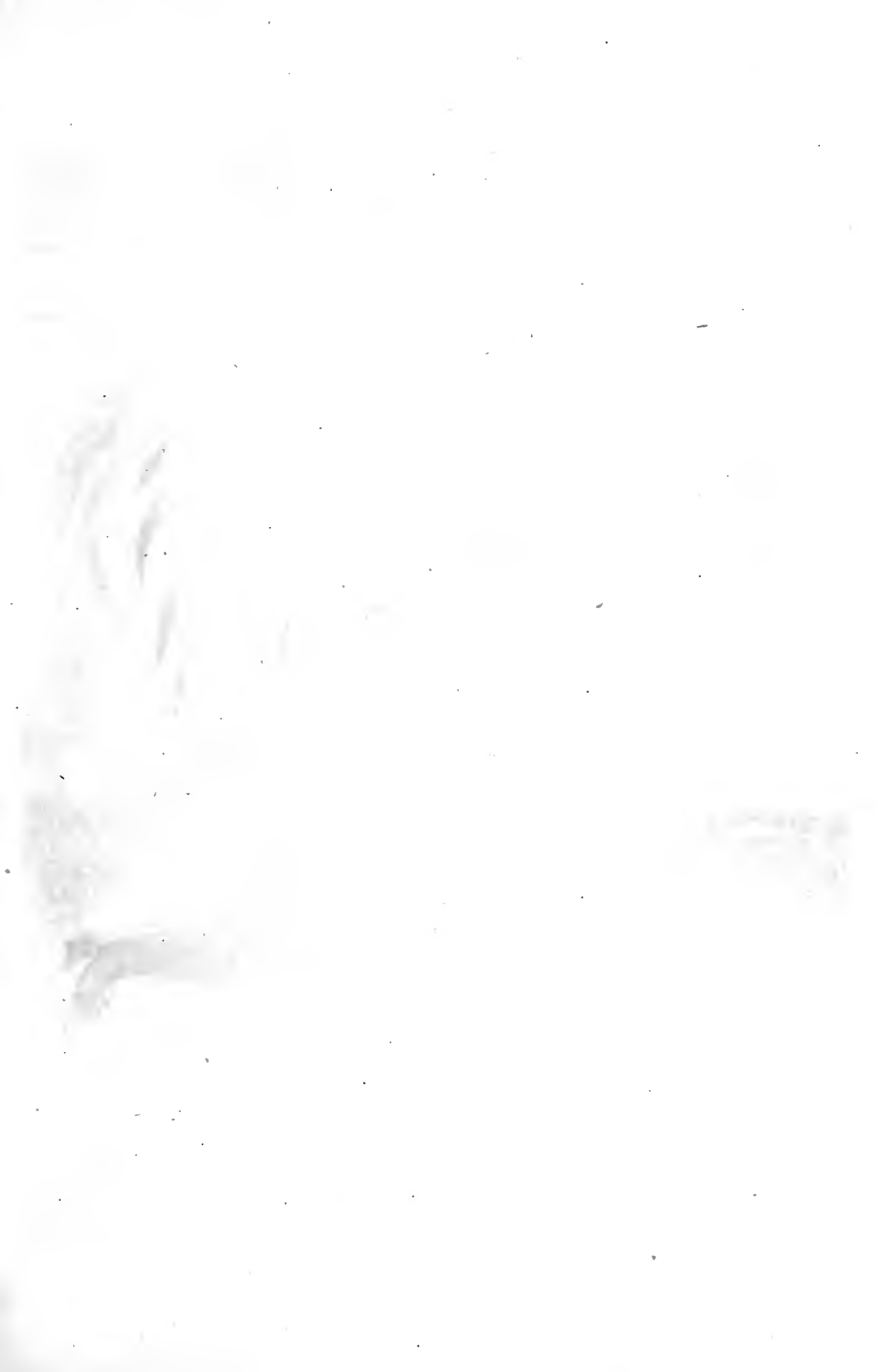

broad and full, with a long bone exceedingly deep in the keel, and extending well from the front towards the tail, so as to give space for development of flesh on the breast. The body cannot be too large and massive, with great length, depth, and width. The back should be broad, and the wings largely developed. I much prefer the thighs to be well developed, so that they may carry plenty of meat. The legs must be straight, stout, and free from feathers. The feet should be five-toed, the extra toe distinctly separated from the others; the toes long, and well spread out; tail large, well expanded, and carried uprightly; the sickle-feathers and tail coverts long, broad, well arched; carriage and appearance massive and grand.

“In the hen the beak should be stout—the comb, if single, well developed and falling over on one side; if double or rose, firmly set on the head, not too large, square in front, inclining to a peak at the back of the head. The wattles should be fine, and rounded neatly at the lower edge; head long and deep; neck stout, and well set on the back; the chest broad, with great depth from the top of the shoulder down to the point of the keel of the breast-bone, which should be straight and deep. The body ought to be large, almost forming a square when viewed from the side; back broad and long. The wings should be large, but not so large, in comparison to the greater weight of body, as in many other breeds. The thighs may be long and well laid along side of body—consequently the birds do not stand in a stilty manner. This is a point in which I conceive many breeders make a mistake. A Dorking, in my opinion, should have a well-developed thigh; but from its being set nearly straight with the body, it is not evident. The legs should be short, and of a length in proportion to the size and weight of the bird. The feet must be five-toed, the extra toe well developed and distinctly separated from the others. The carriage and appearance of Dorking hens should be matronly and dignified.

“Respecting the management of breeding-stock, I think it very important not to move them away from their runs until after May, as the same Dorkings cannot be used for both breeding and showing at the same time. If such a plan is followed, the result is that poor weakly chickens only are produced, and not more than half the eggs hatch. Many persons think that Dorkings will not stand confinement in a small place; but I have bred some of my very largest and best birds in yards 30 feet long by 10 feet broad. When confined to runs of these dimensions, they certainly require to be kept in a state of great cleanliness, to have a turf daily, and above all, plenty of clean water. They should also be fed chiefly on soft food, which should be mixed stiff, and not watery. When thus confined, it will be found very advantageous to give them some swede turnips cut in two, when they will eat out the whole inside from the skin. In the early spring, swedes or mangolds, boiled and mixed quite dry with barley or oatmeal, form a capital food. In fact, Dorkings in a confined space must have some fresh vegetable food of this sort, and when they are running loose it makes a capital food for once a day all the winter through. In general I give this food

as the first meal in the morning, having had it boiled over night, and mashed in a pail with meal. By covering the pail with a sack, it keeps warm, and is a nice food for the fowls on a cold winter morning. They should have a small feed of barley-meal mixed into a crumbly paste with water, or a light feed of boiled Indian corn, at mid-day; some days soaked barley or wheat, or bruised oats, for a change; but they should always have a feed of dry corn for the evening meal—either wheat, oats, or barley. Soft food soon passes out of the crop, and during a long winter's night the fowls get cold and hungry, and are exceedingly liable to take cold, which is a sure forerunner of roup. But with care in housing and feeding, no one need fear roup. I have not had roup or gapes amongst my Dorkings for many years. By attending to these matters Dorkings may be kept in health on any soil.

“Early hatched Dorking pullets will lay all the winter, although not quite so freely as some other breeds. Dorkings make good mothers in general, and lay from 35 to 50 eggs before wanting to sit. As mothers, they are very docile; you may handle them as you please, and give them the chickens from other hens, which they will take to at once. As Dorking chickens are extremely rapid in their growth, it is desirable to coop the mother for the first seven or eight weeks. During the first week I always coop the hen under a dry dusty shed; by the end of that time the chickens get strong, and if dry weather sets in, they are fit to be cooped on the grass under the shelter of a hedge, or by the side of a plantation, where there are plenty of nice dry, dusty banks, and where they can get enough of morning sun; but they should not be exposed to the mid-day sun in places where they can get no shelter. When I have had many chickens at one time, I have always been in the habit of making shelters for them by propping up some old hurdles on pegs about nine inches high, and then covering them with spruce or any other branches. On a sunny morning you may see these shelters covered with the chickens sunning themselves, but if a dog or hawk approaches they dart under the hen in a moment. A number of these hurdles placed about where chickens are being reared will afford them great protection from the cold winds as well as from the power of the sun. The coop with the hen should be moved daily about mid-day, and the chickens fed most liberally, if you wish to rear any fowls that are very good, and out of the common—such fowls as will sometimes sell at nine months old for the price of a cow—a fact I have often proved. My readers may ask how I raise them so as to become as valuable as I state. When young, I give my chickens good eggs and new milk made into a custard, which is given with every meal. The best oatmeal is used for their stock food; sheep's head and pluck, boiled and chopped up, are given three times a week until the chicks are three weeks old. Bruised oats are thrown down just in the rough for them to peck at, and they are fed every hour from 5 o'clock in the morning to 7 o'clock at night. A nice warm dusty place is selected for the coops, and in the morning, before feeding, water is given them with a little sulphate of iron in it. It is wonderful what frames they make when fed in this way. When seven weeks old, I begin to give coarser food,

such as split wheat and barley, leaving off the custard by degrees, adding more barley-meal and oatmeal; being careful not to let the chickens out of the coops, if a strong dew is on the grass, until the sun is well up. This is easily managed by opening the coops and letting the chickens out to drink the very first thing in the morning, when they will rush to the water; then by putting a little food in the coops you get them all in again; then shut them up for a time till the grass is dry. When large-framed birds are desired, the frame must be produced whilst the chicks are with the hen; size is only to be obtained by liberal feeding and great attention. In general I set from nine to eleven Dorking eggs under a hen, but never more than the larger number. My largest and best fowls have always been those hatched about the end of April and first fortnight in May. I once showed a pen of chickens, hatched on the 7th of June, at the Birmingham Show, held the last day of November, and took the fourth prize with them. Even for show stock I always continue breeding until the middle of June, as, even at that time of the season, you may hatch cockerels that will weigh 9 lbs. and pullets of $7\frac{1}{2}$ lbs. by the new year—weights that are not to be despised, as birds weighing considerably less have taken many prizes at the recent shows. Breeding for any particular colour in Dorkings cannot be taught by any hints: it must be learned in the breeder's own yards, and he must know the strain of his birds before it can be done, and even then it takes years to breed to any particular colour. Weight may be got much easier than colour.

“In sending Dorkings to shows, it is most important not to over-feed them beforehand, or they will suffer much from being exhibited. They should be shown in their natural condition, taking care that their heads and combs are nicely washed with a sponge, and wiped dry, and their legs and feet well washed with soap and warm water. I am surprised at White Dorking breeders remaining so stationary. No improvement has been effected for years in this breed, when it could be so easily managed by crossing with the heavy rose-combed Grey Dorking, and then breeding back to the white to regain the colour. Many breeders will say that to cross in fowl-breeding is to get impure breeds; but I know that most breeds are all the better for a cross, although I do not say the first produce of the cross, but the second and third, being bred back again with the breed it is desired to improve.”

The chapter on coloured Dorkings would be incomplete without specific details respecting the best methods of fattening fowls for the table. The following practical directions on this subject are taken from a “Treatise on Poultry Regarded as Agricultural Stock,” published by the Editor of this work in the *Journal of the Bath and West of England Agricultural Society*:—

The chickens designed for being fattened should be well and liberally fed from the earliest period. It is a mistake to imagine that they can be kept low when young, and got up to a great size by liberal feeding when put up to fatten. The fowls so treated are stunted in their growth, the bony framework becomes set or fixed, and they never afterwards attain a large size; whereas with liberal feeding

they become fit for the fattening-coop at the age of about four months in summer, and from five or six in winter. It cannot be too strongly impressed upon those who are desirous of obtaining chickens of first-rate quality, that fowls are only in perfection for the table before they have attained their complete development. The male birds should be put up when "their tails begin to turn," namely, just when the two long sickle-feathers or streamers begin to top the straight feathers of the tail; and the pullets before they have laid.

The house in which poultry are fattened should be free from draughts of cold air, and kept at a moderately warm and uniform temperature; the roof, therefore, if of tiles, should be thickly lined with straw. Quietude being especially desirable, the house should be so situated as not to be accessible to the fowls at liberty; and it should be partially darkened, if possible. It is also important, in the highest degree, that it should be perfectly dry, as it is scarcely necessary to add, that a fowl suffering from cold and inflammation is not likely to fatten.

The fattening coops should be two feet six or eight inches high in front, and about two feet deep, with a boarded roof sloping backwards; the back and ends should be closed, and the bottom made of flat bars with rounded edges, two inches wide at the top and narrower beneath, so as to prevent the dung sticking to the sides. These bars should run from end to end of the coop (not from back to front), and they should be two inches apart on the upper sides: The front of the coop should consist of rounded bars, three inches apart; and two rods connected together below, and sliding through holes made in the roof, will be found more secure than a door. Before the front should run a ledge to support the feeding-troughs, which are best made by joining two pieces of wood at a right angle, and securing the ends by letting them into grooves in stout end-pieces.

The fattening-coops should stand on legs to raise them a convenient height from the ground, so that the dung may be removed daily; or each may have a shallow drawer underneath, which is daily filled with fresh earth—an admirable plan, which we first saw used at the Clumber aviaries. The most scrupulous cleanliness must be observed, otherwise disease will be produced. The coops, therefore, should be lime-washed (with freshly slaked lime and water), and then thoroughly dried before a fresh batch of fowls is introduced.

In cold weather, the front should be covered up with matting, or some other warm material, at night.

The length of the coop must depend on the number of fowls that it is required to contain; but it is never advisable to place more than ten or a dozen together; and if strange fowls are put up, care must be taken that they agree well together, as otherwise the constant excitement would prevent their fattening.

It occasionally happens, that fowls are infested with lice to such a degree that they become irritable, and refuse to fatten; in these cases, a little of the flowers of brimstone dusted under the feathers, before cooping them, immediately expels the vermin.

The fowls when first cooped had better be left some hours without food. By

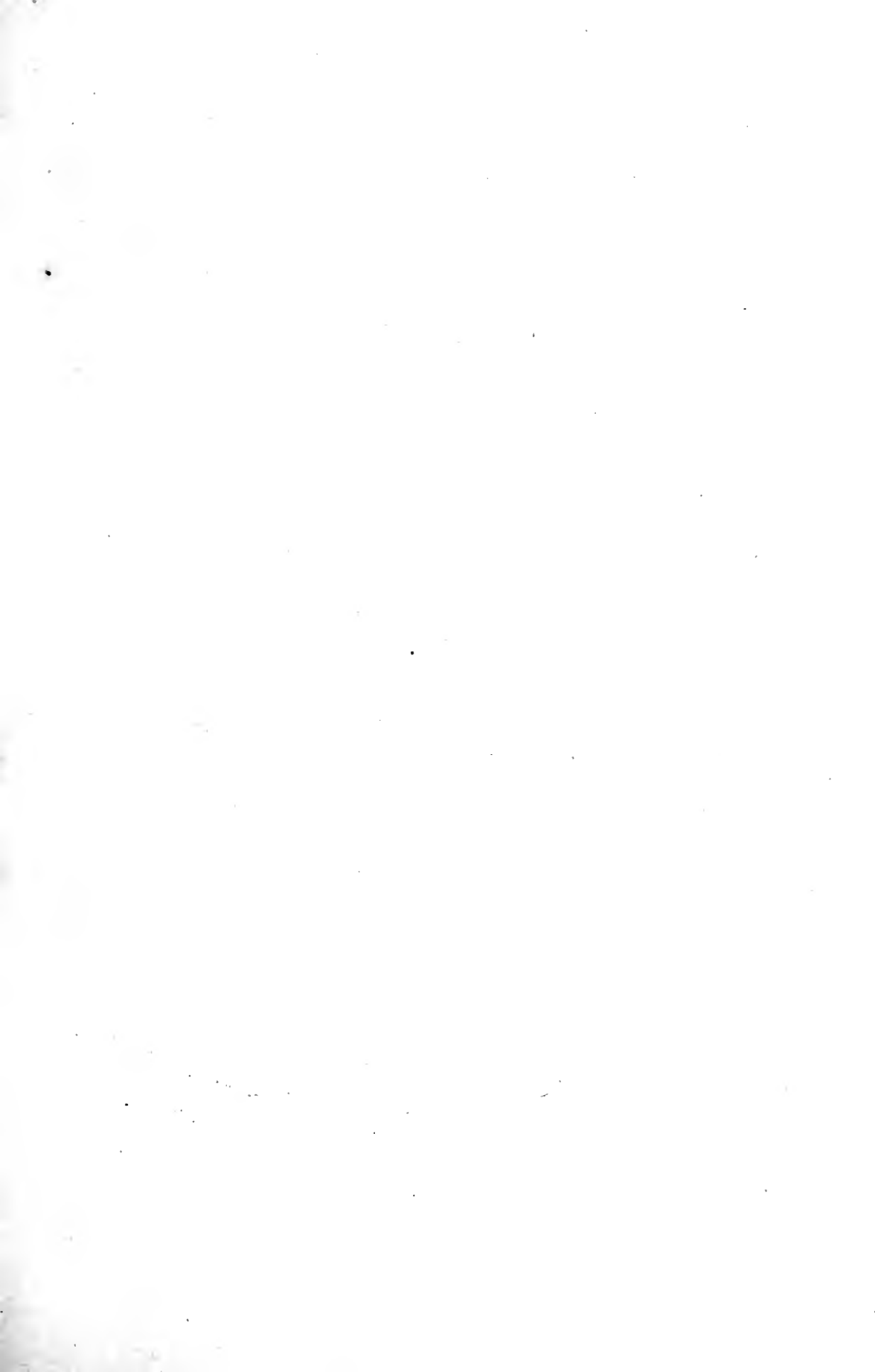



H. W. G. 2000

DORKING FOWLS.

this time they will have become very hungry, and will eat with avidity ; whereas, if food is placed before them on their first imprisonment, they often refuse it for some time. The best food for them is coarse oatmeal mixed with scalding milk or water : barley-meal is good, but not equal in its fattening properties to oatmeal ; this is evident from the fact that the latter contains 6 lbs. of fat in every hundred, the former only 2 lbs. The birds should be fed at regular intervals. The first meal should be given very early—at 5 o'clock in summer, at daybreak in winter ; the second at noon ; the last just before dusk. Discretion should be exercised in the quantity given. It should be fully as much as the fowls can eat, and no more. Should any be left from one meal to another, it should be thrown out to the other fowls, the trough scalded out, and fresh food given. Great care should be taken to prevent the troughs becoming sour. In order to do this they should frequently be scalded, and dried in the sun. As a variation in diet causes an increase of appetite, many feeders have a spare trough with a little barley in it placed before the coops. If it is considered desirable to use any animal fat, the hard trimmings of loins of mutton will be found most desirable. They should be chopped up and mixed with the meal before the scalding liquor is poured on ; or, still better, may be boiled in the liquor before it is poured over the meal. A supply of clean water and some coarse sand or fine gravel are necessary. Many persons omit the latter ; but as the due grinding action of the gizzard cannot go on without it, it is absolutely necessary to the proper digestion of the food. In places where the millers prepare the finest flour, usually known as “pastry whites,” they have a very superior kind of fine middlings or thirds. This is not unfrequently sold, in London at least, under the name of coarse country flour. It is cheaper than the best oatmeal, and may be in part advantageously substituted for it. The most convenient mode of using it is to bake it until it becomes quite hot, when, if cold water is poured on it, it becomes a crumbly mass. The common sharps or coarser middlings will not answer, as it contains too small a portion of nutriment, and purges the fowls.

On this system of feeding, a fowl will become perfectly fatted in from a fortnight to three weeks at the outside. When fatted it should be immediately killed ; for, not only is it unprofitable to keep it any longer, but it deteriorates very rapidly, losing weight and becoming hard and coarse in the flesh. Before being killed, the fowls should be kept for fifteen or sixteen hours without food or water. If this precaution is not taken (and it is unfortunately often neglected), the food in the crop and intestines ferments. When this is the case in summer, the fowl in a few hours turns green, and the value is much lessened. After being killed, the fowls should be allowed to become quite cold before they are packed for the market ; and they should be sent without being drawn, as a fowl killed when empty of food and water keeps better untouched. The absurd plan of drawing the birds by cutting a long slit in the side, as is the custom in some parts of England, detracts considerably from the value of the bird in other places.

If it be thought fit to follow the practice of cramming, which, however, we have

never found necessary, the oatmeal should be mixed rather stiff, and then rolled into crams about two inches long and as thick as a man's little finger. Six or seven of these are then taken, dipped in milk or water, and placed in the back of the mouth of the fowl, which is held in the lap, the mouth being opened with the aid of the left hand. In this manner the birds should be fed three times a day, care being always taken to ascertain that the last meal has completely passed out of the crop before the next is given. Sometimes, in cramming, the food will become hardened in the crop. In this case some lukewarm water should be poured down the throat, and the mass loosened by gentle pressure with the fingers.

We have not recommended the operation of making capons: by far the greater number of the fowls which are sold in London under that name, are not really birds that have undergone the operation of caponizing, but simply young cocks that have been fattened as recommended. The operation, moreover, as performed in England, is of the most barbarous and consequently frequently fatal character. The plan adopted is to cut across the belly between the end of the breast-bone and the vent; the intestines and gizzard are then pushed aside, and by that means the testicles, which in birds lie in close contact with the back-bone in the immediate neighbourhood of the kidneys, are reached; they are then pulled away from their attachments by the finger, and removed through the wound. It is needless to say that an operation so severe in its character is necessarily often fatal.

In France the operation is performed in a much more skilful and scientific manner, and with so little pain and inconvenience to the birds, that they will feed immediately after its performance. The details of this operation were published in the "Oiseaux de Basse Cour," par Mlle. Millet Robinet, a treatise issued with the concurrence of the Minister of Agriculture. As the plan of proceeding is so much superior to that followed in our own country, we do not hesitate to insert a free translation of the chapter on Caponizing, although we must state that we do not recommend the operation, and have never performed it, except in the course of some physiological experiments; but when we have done so, we have found that it is attended with little or almost no risk to the animal.

"The name of capon is given to young cocks which have been deprived of the faculty of reproduction. In this state they grow to a very large size, and fatten more readily: their flesh also is more delicate.

"It is desirable to submit the cocks to the operation when they are about four months old, and it is very important to choose a time when the weather is somewhat cool, rather moist than dry, and especially to avoid performing the operation during the great heats of summer.

"The instrument employed in the operation should be very sharp; a surgeon's small operating-knife, termed a curved-pointed bistoury, is far better than an ordinary knife, as it makes a much neater wound, and so increases greatly the chances of healing; or a curved-pointed penknife may be used. A stout needle

and waxed thread are also requisite; a small curved surgical needle will be found much more convenient in use than a common straight one.

“It is necessary that there should be two persons to perform the operation. The assistant places the bird on its right side on the knees of the person who is about to operate, and who is seated in a chair of such a height as to make his thighs horizontal. The back of the bird is turned towards the operator, and the right leg and thigh held firmly along the body, the left being drawn back towards the tail, thus exposing the left flank, where the incision has to be made. After removing the feathers the skin is raised up, just behind the last rib, with the point of the needle, so as to avoid wounding the intestines, and an incision along the edge of the last rib is made into the cavity of the body sufficiently large to admit of the introduction of the finger. If any portion of the bowels escape from the wound it must be carefully returned. The forefinger is then introduced into the cavity, and directed behind the intestines towards the back, somewhat to the left side of the middle line of the body.

“If the proper position is gained (which is somewhat difficult to an inexperienced operator, especially if the cock is of full size), the finger comes into contact with the left testicle, which in a young bird of four months is rather larger than a full-sized horse-bean. It is movable, and apt to slip under the finger, although adhering to the spine; when felt it is to be gently pulled away from its attachments with the finger and removed through the wound—an operation which requires considerable practice and facility to perform properly, as the testicle sometimes slips from under the finger before it is got out, and, gliding amongst the intestines, cannot be found again readily; it may, however, remain in the body of the animal without much inconvenience, although it is better removed, as its presence is apt to excite inflammation.

“After removing the left testicle, the finger is again introduced, and the right one sought for and removed in a similar manner. It is readily discovered, as its situation is alongside of the former, a little to the right side of the body. Afterwards the lips of the wound are brought together and kept in contact with two or three stitches with the waxed thread. No attempt should be made to sew up the wound with a continuous seam, but each stitch should be perfectly separate, and tied distinctly from the others.

“In making the stitches great care should be taken; the skin should be raised up so as to avoid wounding the intestines with the needle, or including even the slightest portion of them in the thread—an accident that would almost inevitably be followed by the death of the animal.

“After the operation the bird had better be placed under a coop in a quiet situation, and supplied with drink and soft food, such as sopped bread. After a few hours it is best to give him his liberty, if he can be turned out in some quiet place removed from the poultry-yard, as, if attacked by the other cocks, the healing of the wound would be endangered.

“After the operation the bird should not be permitted to roost on a perch, as

the exertion of leaping up would unquestionably injure the wound; it should, therefore, at night be turned into a room where it is obliged to rest on the floor previously covered with some clean straw. For three or four days after the operation the bird should be fed on soft food; after that time it may be set at liberty for a short period, until it has recovered entirely from the operation, when it should be put up to fatten.

“In France it is customary to cut off the combs of the capons. This is regarded as a distinguishing mark of the operation having been performed, and consequently the birds do not sell so freely if they are allowed to remain.

“If the animal mopes about on the day following the operation, it is desirable to look at the wound, and, should it be inflamed, to bathe it with a little tepid water. If, however, the intestine has been wounded, there is no chance of recovering. Some persons place oil and other applications on the wound; but there is no doubt that they retard the healing process. As a general rule, it may be stated that if the operation has been skilfully performed it rarely fails of success.”

It is a very singular fact that after giving the above specific and very correct details of the operation of caponizing, the author of the treatise denies the possibility of making what are termed “poulardes,” that is, pullets deprived of their power of reproduction in order to induce them to fatten rapidly; and states that the birds which are sold under that title are simply pullets fattened before they have commenced to lay. The operation is, however, much easier than the corresponding one on the cocks. The pullet is to be placed in the same position on the lap of the operator, the left leg being drawn forwards so as to expose the left flank, in which a longitudinal incision is to be made close to the side bone; this will bring to view the lower bowel, and alongside of it will be found the egg-passage or egg-pipe. If this is drawn to the orifice of the wound by a small hooked wire, and cut across—or, what is perhaps better, a very short piece of it removed—the development of the ovary or egg-producing organ is entirely prevented, and the birds fatten rapidly, attaining also a very large size. It is most important to perform the operation before the pullets have begun to lay. We would beg to impress most strongly the desirability of practising these operations in the first instance on dead birds of the same age, so that the operator may become acquainted with the situation and appearance of the parts concerned. By this means a greater amount of success will be attained in the first instance, and much unnecessary suffering saved to the animals.

The operation of making capons and poulardes is, as we have shown, attended with considerable danger. The advantages gained are slight in comparison with the risk of losing the bird, and with the positive amount of unnecessary pain inflicted on the animal. We would, therefore, by no means recommend its adoption, though, in accordance with our desire to make this work as perfect as possible as a poultry book, we have placed before our readers the most approved and scientific method of effecting it, as practised by the most intelligent and successful rearers of poultry for the great markets of Paris and other large cities in France.

This chapter would not be complete without a description of a variety of Coloured Dorkings that was formerly deservedly celebrated for its good qualities in an economical point of view: we allude to the Cuckoo or Blue-mottled Dorking, so called from the resemblance of the bluish grey markings on its feathers to the transverse bars on the breast of the cuckoo. These birds are remarkable from having nearly similar markings in both sexes, allowance being made for the difference in the texture and form of the feathers. To Mr. Elgar, of Reigate, one of the most ardent admirers of this variety, we are indebted for the following account of their merits:—

“There is also another variety of the Dorking which has of late years become scarce—the Blue-mottled, or, as called by some, Blue Shell, and by the fanciers Cuckoo Dorking, although this last name is not much known in this neighbourhood. These are larger than the White, and, in my opinion, can challenge any variety of table fowl for quality of flesh. I have heard it remarked by many old countrywomen, who have fattened fowls many years for market, both farmers’ wives and cottagers’, that the Blue pullets are the best and earliest to fatten of all the coop. Some may object to this variety on account of the birds not reaching the great weights attained by those of the Dark Grey breed; but in my opinion they quite compensate for this by their superior quality and beauty. These birds I consider to be one of the oldest breeds; with care and moderate feeding they prove one of the most profitable varieties of the Dorking fowl, as they are not delicate in constitution, nor liable to disease, like the Dark Grey variety, when very large. The Blue-mottled or Cuckoo Dorkings are both double and single combed; the single are rather the largest. There are a few double-combed Blues kept in the neighbourhood of Dorking; but they are small, not any larger than the White variety, and are very frequently imperfect in the claws, either four on one foot and five on the other, or only four on each foot. Some of the Blue variety have yellow hackles, especially the cocks when old birds; but I do not consider a good cock, even if old, should have any other than bluish grey hackle and wing feathers. Most of the Dorkings being reared for market, but few persons have hitherto paid much regard to colour, as they frequently have a black-breasted cock with grey hens, and, indeed, with every variety of colour.”

Of the cross breeds of Dorkings, those with the Cochin and Malay have already been described; it remains only to notice those produced by union with other varieties. Of these the Brahma cross is perhaps the most important. Many persons who desire to keep Dorkings for supplying their own table with first-class poultry object to the breed on account of the delicacy of the chicken and the difficulty of rearing them in large numbers. On such occasions it will be found very advisable to cross the Dorkings with the Brahmas. If a few heavy short-legged dark Brahma hens are allowed to run with the Dorkings, and their eggs hatched, they will be found to produce very hardy quick-growing chickens of great weight and unexceptionable quality as table fowl. It is hardly necessary to say that the cockerels should be killed off as soon as ready, but we should recommend a few of the

pullets to be kept—those showing the nearest approach to the Dorking shape ; and if these are matched up with a heavy cock, they will produce chickens that will be three-fourths Dorking, and show very little trace of the Brahma origin, at least as far as their character as table fowl is concerned. This cross with one of the hardiest of all races gives great increase of stamina to the Dorking fowl, and, where pure Dorkings are far too tender to be reared with advantage, may be depended on for affording a good supply of large-sized full-fleshed short-legged table fowl. At the same time, the colour of the two breeds harmonizes very well, and the critical eye of the owner and his friends is not annoyed by a particoloured collection of poultry, each bird looking unlike all the others.

The only additional cross calling for any special notice, is that between the Dorking and the ordinary mongrels that constitute what are usually termed Barn-door fowls. These may be vastly improved, and rendered much more valuable as market poultry, by the introduction of a good Dorking cock into the farm-yard ; in the following year (all the young cross-bred cocks having been fattened for the market), the most serviceable pullets of compact shape, and short on the legs, should alone be retained for stock, the old Dorking cock being exchanged for a fresh bird not related to the first. By following this plan for a third year, the chickens produced will be seven-eighths Dorkings ; and thus, at a very small expense and trouble, a farm-yard full of comparatively worthless unsaleable stock may be converted into really valuable marketable birds.

The diseases to which Dorkings are peculiarly subject, as might be expected from the presence of the additional toe, are—the chronic inflammation of the foot known as bumble-foot, which is most readily prevented by broad low perches, and the absence of rough stones from the run ; and a tendency to lay soft eggs, arising from unnatural food or excitement. The treatment of both will be duly described in the chapter on the diseases of fowls.



LEIGHTON, BRO.

WHITE DORKING.





CHAPTER X.

THE WHITE DORKING FOWL.

THE White Dorking appears to be a distinct variety from the Grey or Coloured, and therefore demands a separate chapter. The grounds for this opinion may be briefly stated. The size of the White Dorking is much less than that of the Coloured, the cocks rarely reaching ten pounds, or the hens as much as seven or eight pounds, and the general form and carriage being distinct. The White Dorking is in all probability the original breed, and the Coloured a composite fowl produced by crossing it with the large Surrey or Sussex fowls.

For the following account of this variety we are indebted to one of its greatest admirers, Mr. Clift, of Dorking, who writes :—

“ My individual reason for preferring the White to the Coloured Dorking, is, that though the white is certainly a somewhat smaller bird, it has the great advantage of a handsome plumage, a desideratum not to be overlooked by those who rear poultry as a source of pleasure, and not for a livelihood.

“ The colour should be pure white, without any shade of yellow, or dark coloured feather of any description, about the body. When attention is directed to this single feature, few specimens, especially of the cocks, will pass muster; but still it is an essential point; for as beauty is the only point in which the White Dorking is superior to the Grey or Speckled, so much more is it necessary that the feature which gives them this pre-eminence should be distinct and perfect.

“ Both single and double combed birds may be pure bred, but it is now, I think, almost decided that this beautiful appendage should be double; indeed, any person of taste, who has no knowledge whatever of poultry, would immediately pronounce for the double as being more graceful, and more in harmony with the general appearance of the bird, than the single comb in the cock. The rose comb should be broad at the front near the beak, gradually passing over the back of the head in the form of a triangle, the point of which should be slightly curved upwards; the whole of the surface should be evenly serrated, and not ragged and unequal; the colour should be a bright red, indicating a healthy state and good condition of the bird. The same remarks will apply to the comb of the hen, only that it will always be found very much smaller than that of the male bird.

“ The back should be broad, and should be almost straight from the neck to the root of the tail, which should be large and with a full round sweep of sickle-feathers in the cock; the breast should be broad, full, and gracefully rounded—

whenever a large bird is found with a concave back, a straight instead of a full breast, with large yellow legs, and a short instead of a flowing tail, you may strongly suspect a trace of Cochin blood; the legs should be white, of proportionate length, and a fair distance apart, to allow of a good broad breast; each foot should have five claws, the fifth being as distinct as any of the rest. The attitude should be erect and bold, the bird lively in its motion and appearing full of spirit.

“ In breeding white Dorkings, one thing is essential to success, namely, a dry soil; if this is present, and they receive an ordinary amount of care, they will be found very prolific, fast growers, and easy to rear; they are small eaters, good layers, and, though not laying to the same extent as the Cochins, their eggs are finer and more delicate; as mothers they are excellent, taking great care of the young chickens, and not forsaking them at so early an age as the Cochins. Their superiority for the table is so well known, that it will be unnecessary to enlarge on that point.”

With reference to the White Dorking as an exhibition bird, Mr. Hewitt remarks:—“ It is quite indispensable that the whole of the plumage throughout should be perfectly white, without any admixture whatever. The cocks often show a light lemon-coloured tinge on the neck-hackles, shoulders, and saddle-feathers; but it is decidedly objectionable in an exhibition bird. They ought not to compete with Grey Dorkings in one class for premiums at our poultry shows, as they are generally far inferior in size to the darker varieties; nor can I call to mind a single instance in which (both varieties being good) the supremacy was ever yet awarded to the White ones. Separate classes to each kind are therefore advisable.

“ As to the combs of White Dorkings, I am myself a decided advocate for the so-called rosy or double comb, as being the only correct one; although I am perfectly aware I differ from some few highly respected poultry judges in this particular. I have taken much trouble to ascertain the descent of two different lots of the flat or single combed ones that have come under my observation; and in both instances found them obtained by an intermixture with the White Game, although still retaining the additional posterior toe. I do not for a moment say this is always their derivation; but the decreased size of the so-called ‘Dorking toe’ in most of our White Dorkings, as exhibited in the present day, combined with the general change in character and conformation to that of a much more sparsely built fowl than the coloured variety, favours strongly the conclusion. This cross improves the constitution of the offspring, but quite destroys their general character as White Dorkings.”

The other crosses of the White Dorking do not call for any particular remark: the delicacy during chickenhood which is usually alleged against them might perhaps be equally well obviated by crossing with the White Cochin, and then carefully breeding back again to the Dorking for several generations, avoiding all blood relationship. This cross breeding, which has been extensively carried out in the case of the Coloured Dorking, would increase the size and hardihood; but

the peculiar carriage and the full chest would necessarily be altered; it is possible, also, that the colour of chickens so produced would be very uncertain, as it in general happens that two White varieties when crossed throw slaty grey or other colours. The experiment, however, might readily be tried by a breeder of White Dorkings placing a White Cochin hen in his run, and then preserving year after year those pullets in which the desired characteristics were most distinctly shown, mating the successive generations with White Dorking cocks, not related to their progenitors; or the size of the White Dorking might be increased by adopting the mode suggested in the paper of Mr. Douglas, which forms part of the last chapter.

CHAPTER XI.

THE SPANISH FOWL.

THE geographical names by which the majority of the different breeds of our domestic poultry are at present known to us are unquestionably erroneous. Cochins were unknown in Cochin China until introduced into that country from Shanghae by the English. The so-called Polands are unknown in Poland. Spangled Hamburgs are certainly of English origin; and the breed known as Brahmas are unknown on the banks of the river Brahmapootra. But with Spanish the case appears somewhat different; all along the Mediterranean, from Gibraltar to Syria, the countries that border on that vast inland sea, with its numerous islands, abound with fowls that bear so close a degree of resemblance to the Spanish race as may warrant our assigning them to one common stock. The employment of the names used to indicate some of the varieties of this breed tend to point their common origin: thus we have Andalusians, Aneonas, and Minoreas, the names of which point to a Mediterranean origin.

The quantity of poultry kept in these countries greatly exceeds anything we witness in England, even since public attention has been more generally given to this branch of agricultural economy. Purity of breed, however, is but little esteemed, and the miscellaneous collection of mongrels described by every Mediterranean traveller who has touched on this subject will probably long remain in the same heterogeneous state as it is at present. Nevertheless, with those who have examined with any care the natural history of this section of gallinaeous birds, little hesitation would be felt as to the extreme probability of a common descent.

These breeds certainly are not likely to have had their origin in the more northern parts of the European Continent; since those who now keep them know to their cost how apt they are to suffer in their combs and the fleshy excrescence on the face in weather which other poultry braves with impunity. Their prolonged and excessive moult is also indicative of their original habitation having been under the mild temperature of those southern lands.

The Spanish fowl throughout the wide range of the Mediterranean coasts is always found in a state more or less degenerate, in comparison with the beautiful birds that are now seen at our exhibitions. So little attention, indeed, has been given to preserve the breed pure in any part of what we may term its native districts, that the specimens recently imported from Spain and the adjacent countries have always been of a very indifferent description. On the

other hand, great attention has been paid to this breed in Holland, and many of the best birds recently imported have been introduced from thence. There can be little doubt that the Dutch originally obtained the breed from Spain during the Spanish occupation of the Low Countries, and that they have carefully bred them since in a state of purity, and increased the beauty of the breed by the process of very careful "artificial selection."

In England they have long been favourites with poultry-keepers of all grades. Mr. Bond, of Leeds, well known as one of the most experienced poultry-fanciers, informs us that he has kept them for thirty years; and his recollection carries him back to as good specimens in those days as any that are now seen. The vicinities of London, Islington and Spitalfields, were then their principal localities.

Mr. Bond gives the following account of their characters as they were formerly bred by the London fanciers:—

Male.—Head large; beak of moderate size; eyes very bright; comb single, upright, very large, red as coral, and slightly serrated; face and cheeks perfectly white, the white extending round the eye; wattles long and pendulous; neck of moderate length, but strong; body broad and close-feathered; wings of medium size; rather long in the leg, which is of a bluish white colour; tail a good plume; plumage a glossy black, having a greenish shade in the sun.

Female.—Head and beak neat, and of moderate size; eyes bright; comb single, very large, and pendulous; face entirely white, the white extending round the eye; neck of moderate length, neatly set on; body broad; wings of middle size; legs almost white; tail long and well squared; plumage as in the male, but less brilliant.

The most important general characteristics being the uniformly fine black plumage; immense comb in both sexes; and the white face and ear-lobes, which increase with age, especially in the female.

This description of Mr. Bond has been objected to on the score of slaty blue legs being now regarded as indispensable to success in the exhibition pen; but it certainly appears that the London fanciers, some years since, required pale legs for their Spanish birds; and a good story has been handed down of an enthusiastic amateur, whose bird was detected with its legs in poultices the day previous to its being exhibited, in order to effect the production of that much desired tint.

In reference to the size of the skull, we find the extreme length of the cranium of a Spanish cock, that had taken many prizes, to be three inches and a half, the same as that of the skull of a Dorking cock that weighed ten pounds, and one quarter of an inch less than that of a Brahma cock, the largest skull that we ever saw.

In general size, also, the skull of the Spanish almost equals that of the Dorking; but in form there is a very remarkable distinction, as the Spanish skull has a large well-defined flat surface, from the top of which the enormous comb distinguishing the variety takes its rise, and which strongly contrasts with the rounded forehead of both Brahma and Dorking.

The following characteristics of Spanish fowl are in accordance with those drawn up for the Poultry Club "Standard of Excellence," by Mr. Teebay, to whom belongs the credit of breeding some of the very best Spanish that have been shown for many years, and also with the description with which we have been specially favoured by Mr. Hewitt.

The size of Spanish places them amongst the larger breeds. The weight of the cock should not be less than seven pounds when in full condition; but it is rarely found to exceed that weight, if it approaches perfection in other respects. A full-sized hen when about laying should not weigh less than six pounds.

The carriage and form of the cock is very stately and upright; the head well drawn back; the breast round, full, and protuberant, and legs and thighs long and high in the bone for the size of the fowl; the back sloping towards the tail. The hens are rather high on the legs, which gives them a somewhat slightly built appearance; still they possess good breasts, and when taken in the hand should be weightier than they appear to the eye.

The general characters of the plumage may be very briefly disposed of. In both sexes it must be purely black, with bright metallic green-black reflections, which are most evident on the saddle and tail plumes of the cock, and the more vivid in their lustre the higher the condition of the bird. The plumage of the hen precisely resembles that of the cock, except that the metallic lustre is more sober.

The neck in both sexes is long; that of the cock should be very well covered with lustrous hackle feathers, the ends of which come down over the shoulders.

The cock's tail should be very well developed, with large well-curved sickle-feathers. It must be held well up, neither drooping, like that of the Malay, nor carried over the back so as to give rise to the exceedingly objectionable appearance termed "squirrel-tailed," and it should be black to the very roots of the feathers.

In the hen the tail is large; it should be carried upright, but not over the back; the two highest feathers are often slightly curved at the ends; the tail is closed more tightly than in most fowls, and must be uniformly black.

The legs should be blue, or dark leaden blue, the more unbroken in colour the better; but not unfrequently the whitest-faced Spanish have a tendency to whiteness in the legs, which is now regarded as a disqualification in a show-pen.

The comb is a most important feature in the Spanish fowl. Mr. Hewitt writes:—The comb of cock is very large; the serrations should be regular and perfect throughout, not coarse in general appearance, distorted, or overgrown; without any twisting or wrinkle, or tendency to fall over; if thin towards the edge, it is preferable, being less likely to lop as the bird gets old; when the points of the comb are dark, the bird is either in bad condition or frostbitten. In Spanish hens, the combs, says the same authority, should lap in front, and fall over sideways; and in fine healthy birds the comb, from its peculiar position, will entirely cover one side of the face. In the "Standard of Excellence" the comb of the cock is described as bright red, large, single, stiff, erect, straight, free from twists in front and not falling over to either side at the back, deeply serrated, rising from the beak

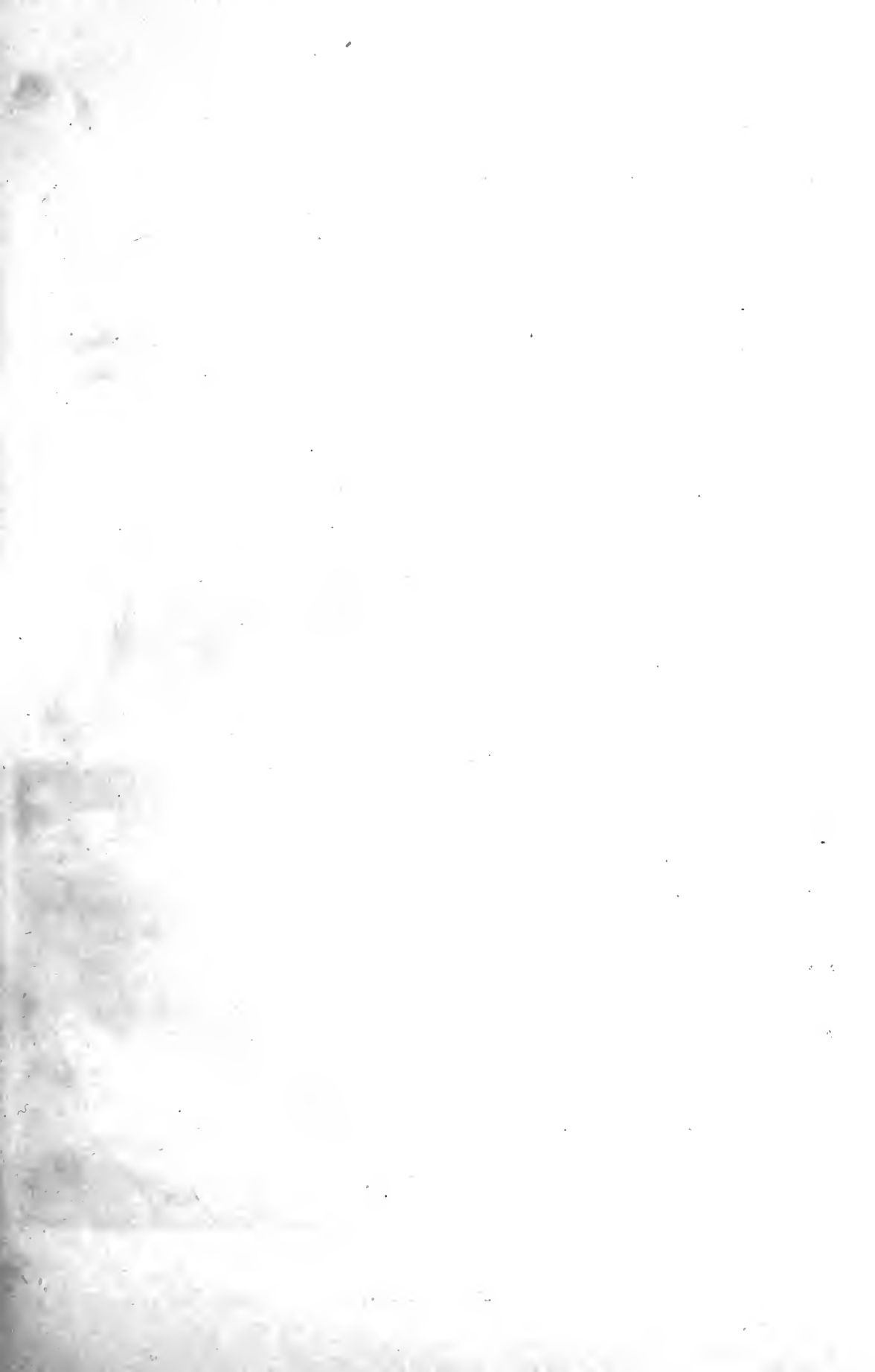



17 ANCK.





betwixt the fore part of the nostrils, and extending in an arched form over the back of the head, free from excrescences or side sprigs, and not of too great a thickness at the outside edges. That of the hen is described as being glossy, bright red, large, single, serrated, drooping over one side of the face, and free from side sprigs or duplications.

The face of the cock, writes Mr. Teebay in the "Standard," must be pure opaque white, long and deep, the greater breadth of surface the better, providing it is smooth, free from wrinkles, and the sight not obstructed; rising well over the eye towards the comb in an arched form, extending towards the back of the head, and also to the base of the beak, covering the cheeks and joining the ear-lobes and wattles. The ear-lobes pure opaque white, very large and pendant, rather thin, smooth, well expanded, and free from folds or wrinkles, extending well on each side of the neck, hanging down very low, not pointed, but regularly rounded in the lower part, and meeting in front, behind the wattles.

In the hen the face must be of the same character, white, smooth, free from wrinkles, with great breadth of surface; it should rise well over the eye in an arched form, extend to the back of the head, forwards to the beak, cover the entire cheek and join the ear-lobe, which must be large, white, pendant, as smooth as possible, and well rounded on the lower edge.

The eye in both sexes should be large and full, and the sight totally unobstructed by the growth of the white skin of the face, an evil to which the heaviest faced birds are very prone as they advance in age.

The points that are regarded as disqualifications in a Spanish cock as an exhibition bird are—the comb falling over to one side, or twisted in front over the nostrils; the face so developed as to obstruct the sight, or possessing a decided red mark above the eye; the presence of any other colour in the plumage except black, or metallic green-black; and the legs being of any other colour except dark leaden blue, or blue.

The chief disqualifications in the hen are—the presence of a double comb, or of the small and erect comb known as the prick comb; a decided red mark over the eye; plumage of any other colour except black, or metallic black; and legs of any other colour except dark leaden blue, or blue;—and in both sexes trimming or plucking in any part whatever.

The distinction between two very distinct strains of Spanish has been long recognized by the older metropolitan amateurs, but has been rarely, if ever, described in books. We have been favoured with the following notes on this subject, by one of the most experienced London breeders, Mr. C. H. Brown, who, in describing the birds imported from Holland, states—"The Dutch birds are small and short-legged, although purer in face than the old English strain; they are, in fact, so different in size, shape, comb, and general characteristics, that I almost consider them a different kind. Crossed with our breed, they have tended very greatly to the improvement in the face. In those birds termed by fanciers 'paper-faced' birds, the face is quite smooth: they are generally the smallest specimens, and are

derived, I think, from the Dutch breed. The larger, coarser strain of Spanish are the finer built birds, larger framed and longer limbed; they lay very fine eggs, much larger than those of the Dutch variety, and are known amongst the London fanciers as 'Warty-faced,' 'Cauliflower-faced,' and 'Rough-faced' birds. In these the carunculated white excrescences break out in clusters beyond the surface of the face; in old age, and often before, preventing the bird from seeing in front or behind, the eye being nearly buried, and the white above often falling over, so as almost to obscure the sight altogether.

"The Dutch-bred Spanish are much earlier than ours in showing the white face, and arrive at maturity much quicker. Young cocks of this sort will be quite white perhaps at eight months, and never improve afterwards; while our own English breed would at that age be very inferior, but continue to improve each month up to two years old and upwards: the pullets are also subject to the same remark."

In his remarks on Spanish in general, Mr. Brown states, regarding the plumage, that "the white tips occasionally seen on some of the feathers are no indication of impure blood, as the purest bred birds, and those hatched from raven-black parents, often have a few, and sometimes a large number, of speckled feathers. In old age, Spanish sometimes become pied, and, the following moult, change to pure white, the legs also changing colour. In Spanish cockerels of the first year the tail is scanty, but in the second season it assumes its very ample and beautifully arched form. The cock's comb should be thick and self-supporting at the base, thinner towards the edges, and perfectly erect; when the bird is in motion, the wavy tremulous action of the extremity of a thin comb gives rise to a much more graceful appearance than when it is too short, thick, and stunted to sway with the movements of the head.

"In breeding Spanish, the chickens bred from the same parents differ much in quality; but that the rose-combed, red-backed, and brassy-winged birds that have been produced from settings of eggs sold for extraordinarily high prices, ever came from pure-bred birds, is an entire fabrication."

Mr. Hewitt furnishes the following notes on this breed:—"Spanish fowls for exhibition must imperatively be quite free from any sprinklings of white or any other colour whatever throughout their entire plumage. They are rather prone to this defect (as is usual in all fowls whose feathers are naturally black). The white feathers are generally most apparent upon the head and upper part of the neck of the hens, and on the hinder portions of the thighs. Feathers that have been accidentally pulled out are sometimes reproduced thus sprinkled, or marked with white, yet at the natural moult return to their proper hue. The cocks are most apt to be faulty in the shoulders, and longer neck hackle feathers.

"All Spanish are good layers; but the more perfect the general external character of the hen, as a rule, the finer eggs she produces. The chickens feather very slowly, especially if closely bred, sometimes as they grow up being all but destitute of plumage or even down; in this stage they are most easily affected by sudden

changes of weather, and frequently droop away in a day or two, especially about the time of shooting their first tail-feathers: hence one great difficulty of rearing them. They require (in the northern and midland counties of the United Kingdom more especially) very high feeding whilst young, complete exclusion from all damp, and much general attention, if even tolerable success is hoped for and the stock is of high descent. The old fowls are much afflicted by being frostbitten in the combs and feet if the winter happens to be severe. The serrations on the edge of the combs are sometimes altogether destroyed from this cause alone, and the fowls spoiled for exhibition. Heavy weather tries their constitutions severely, and soon stops their productiveness. They are also long in recovering from their annual moulting.

“ Still, of all fowls, they appear the most truly aristocratic, and on a good walk always look a most respectable addition to the live stock; they very much like to steal their nests in out-of-the-way places; but it is most unusual for them to sit afterwards, although isolated cases have taken place of their so doing, and both hatching successfully and proving good mothers; still, it is decidedly the exception to their natural propensities.

“ When plucked for the table, though very good in point of the colour of the skin, they always appear high in the bone, the bridge of the breast being very deep (more particularly in the cockerels); hence they seem to the eye to carry much less flesh than they really possess. For this reason they do not stand high in favour with poulterers, who have to resell them ready for the spit. The flavour of the Spanish fowls is good, but not of extreme excellence; the economical value chiefly arises from their great production of eggs, although this is mostly confined to the summer months only.”

Mr. Crook, of Forest Hill, well known as an ardent admirer and successful exhibitor of this beautiful variety, has furnished us with the following very practical remarks on the breed:—

“ Amongst all the different varieties of fowls there is not one more characteristic than the true Black Spanish; the remarkable contrasts of colour in their plumage, face, and wattles, together with their perfect symmetry and stateliness of carriage, make this variety generally regarded as the aristocracy of the poultry yard. There is, however, one point in the modern breed in which they have greatly degenerated from their former standard, namely, in their size.

“ The Spanish of thirty years ago were considered as the giants of the poultry yard, the cock at two years old frequently weighing from nine to ten pounds, and standing nearly as high as the tallest Malay fowl. In our present prize pens we have birds of very different weight, some of them being extremely small, and looking more like Spanish Bantams, whose proper place would be in the ‘New or any other Variety’ class; this deterioration has, no doubt, arisen from too close breeding in and in, and from the increase in size and purity of the face and ear-lobe being the main objects of the breeder, the bird being much more frequently regarded as a

fancy toy than as a profitable fowl, valuable as a prolific layer of large fine-flavoured eggs, or a good producer of abundant white meat for the table.

“The weight of a good-sized Spanish cock should not be below seven pounds, nor should its height, when standing erect, be less than twenty-two inches. The plumage must be glossy black, with metallic blue and greenish hues when seen in the sun; the breast, belly, and thighs, raven black if possible, or decided jet.

“The comb, which in the cock is one of the most important points, should be of a bright-red coral colour, perfectly firm and erect, not too large or tall, although larger than in any other variety, thick at the base, with crescent-shaped outline at top if possible, commencing in front close to the nostrils, gracefully extending to the back and almost touching the head or top of the neck. The front of the comb should be without twist, or thumb-mark as it is generally termed, the margin evenly serrated, and it should be smooth and fine in texture, and free from excrescences in any part. The wattles should be equally red and fine in texture of long oval, pendulous form, neatly folding, and both of the same length.

“The face is now regarded as the most important point; it should be of pure whiteness, closely resembling finely dressed white kid, extending over the eye up to the base of the comb, showing as great a width at this point as possible, passing round behind the ear, and so producing a great width from this point to the commencement of the white in front of the eye; continuing downwards as the ear-lobe, hanging as low as possible upon the neck, and meeting the red wattles in front. The space between the wattles on the throat should also be white.

“As the white face and ear-lobe are the most attractive features in the Spanish as show birds, there cannot be too great a quantity in superficial extent, nor can too great a degree of attention be given to produce it as smooth and free from ridges or folds as possible, more particularly over and under the eyes; for if the birds are of the heavy warty-faced strain, the white, at two years old, will cause the cocks to become blind from the folds or ridges of white meeting and closing the eyes; the trouble attending these blind birds is very great, the white having to be cut away, as otherwise the birds die of starvation, and long before that occurs they are perfectly useless as stock birds.

“The eyes should be clear and bright, of dark brown colour, and as full and prominent as possible consistent with a good extent of white.

“The neck in the Spanish is inclined to be long, but it should be strong towards the base, tapering very gracefully from the head down to the body. The breast and front of the neck should be full and protuberant, no other fowl having so prominent a breastbone. The back should be a good width, the body somewhat tapering towards the tail; the wings full, but not as ample as those of Game or Dorking. Thighs neat and firm, inclined to be long; in fact, many fine birds are almost what may be termed leggy, but an excess of shank must be avoided. The legs, firm and strong, vary in colour from leaden to blue-black, either being admissible, but the latter preferred. Tread of foot, dingy flesh-colour.

Tail erect and full, but not, as in some strains, tilting forward towards the head ; in all cases the tail should be well balanced, with bright metallic hues.

“ The graceful carriage of the Spanish cock gives him a decided firmness of character, and it impresses the spectator with the idea that he is entitled to the appellation of The Don or Aristocrat of the poultry yard.

“ The hen should average at least five and a half pounds in weight, and should stand about eighteen inches high. Her comb, when in condition, must be coral red, fine in texture, but not too thin ; a slight arching over the eye before it begins to droop over the face allows the bird to see on both sides, but if it be unusually thin it droops too closely to the face, and causes the hen to stoop awkwardly, as she can then only see with one eye, except when looking on the ground. Hens whose combs have this slight arching form breed cockerels with combs much less likely to fall over than those with the comb of a very thin drooping character. The wattles of the hen should be coral red, fine in texture, and neat in form. The face, as smooth as possible and purely white, should extend in a distinctly arched form up to the base of the comb, round behind the ear, and downwards, producing a neat lobe which cannot be too long. Neither cock nor hen having the slightest signs of redness in the face should ever be used for breeding. Breast full and prominent, body tapering towards the tail, legs blue-black or leaden, plumage as black as that of the cock, but possessing less metallic lustre ; tail full and square, carried with grace. Any signs of coloured feathers in either sex is a serious defect.

“ Spanish fowls are active and graceful in all their movements, and appear with equal grace in the park, the lawn, the meadow, or in the enclosed aviary, and they are alike profitable in either position, provided a dry, warm, and sheltered situation is chosen ; when adult they are as hardy as any other variety, and will repay their keeper if properly cared for, kept perfectly dry, supplied with plenty of dry dusty earth and old lime rubbish, and an unlimited supply of green food : they appear to moult slowly and show signs of delicacy, but if generously fed they soon recover again, and begin to lay as early as most other fowls of the same age and in the same position. They are non-sitters, and lay larger eggs than any other kind. The chickens are slow in feathering, and from this cause alone they are generally more delicate than others when very young, consequently they require to be kept on dry ground and free from draughts.

“ In showing these birds for competition some unprincipled persons are in the habit of trimming and dressing them in various ways ; if the white over the eyes is intercepted by feathers, they pull them out in order to produce the required arched appearance. Very frequently fine birds are slightly tinged with redness over the eye : this is frequently painted or whitewashed over. Some birds, if very late hatched, make small birds, and moult off early in the spring ; these birds if hatched about August or September, will have a full extent of face about July of the following year ; consequently the spring-hatched chickens stand but little chance in competition with them until later in the season. The tail of these late-hatched birds is pulled and the spur shortened, to make them look like spring chickens. These

attempts result from the establishment of very early chicken-shows, the advantage of which is open to much discussion. Sufficient attention is not always given by judges at shows as to the truth of the ages of young birds, as stated by the owners; consequently the honest chickens are frequently beaten by late-hatched, trimmed up birds.

“The only thing necessary to be done before sending Spanish to shows is, first, give them as much soft food as they can eat, then clean the legs and feet, and carefully and smoothly wash the white face and comb, drying them afterwards with a very soft cloth; if the operation causes the face to become red, placing them in a warm dark apartment for a short time will soon restore it to the original whiteness. Abundance of clean dry straw should be placed at the bottom of the basket, which, if of open wickerwork, should be lined with canvas, which has the manifold advantage of preventing the birds being exposed to draught and becoming rousy on their journey, of precluding the probability of their tails being pulled by some inconsiderate spectator, and of lessening the chances of the white face being injured by contact with the rough wickerwork of the basket.”

With regard to the economical value of Spanish as productive fowls, Admiral Hornby states:—“As for eggs, I reckoned last year that my Spanish hens laid six eggs a week from early in February to late in August (they moulted early). Between November and February they averaged perhaps three a week. Their eggs are large and handsome, broad, but slightly rounded at each end; one end, however, is not so much more pointed than the other as in some fowls. As for weight—I am cautious in speaking—I know that last year, from February to August, I considered their average weight to be above $3\frac{1}{2}$ oz. but under 4 oz. The largest eggs were in May (when we had rain after a long drought), many of them weighing $4\frac{1}{4}$ oz.; but the average of those laid in December and January I should place at $2\frac{3}{4}$ oz. The eggs are, to my mind, very milky and good. I may add, however, that of the eggs of the best white-faced, I had frequent complaints of the tenderness of their shells, in spite of lime, calcined oyster-shells, soft food, &c. I attribute this to high feeding.”

The colour of the Spanish egg is always clear white, with a smooth polished surface. Spanish pullets are commonly found to commence laying from five and a half to six months old, and they certainly may be described as good layers, except during their autumnal moult and during the severer winter months. Spanish hens rarely show any inclination to hatch their eggs; even if they become broody, the desire to sit usually passes off in a few days, so that it is not desirable to sit them. Sometimes a hen steals a nest and hatches out a brood, in which case she generally proves a good mother; but no practical poultry-keeper ever thinks of designedly employing them as sitters.

In the selection of eggs for sitting, it was said by Columella, and has been repeated in recent publications, amongst others in Mr. Trotter's treatise, in the twenty-seventh number of the Royal Agricultural Society's Journal, that the sex of eggs is capable of being distinguished by their form and the internal position

of the air-cell at the larger end. If this assertion be founded on fact it would enable us to make such a selection of eggs for hatching as would present us with chickens of either sex according to our will. The instructions given by Columella direct us to "select the round eggs, for they contain female birds, and reject the oblong-shaped, for they contain birds of the opposite sex." Again: "By the position of the air-cell at the butt end of the egg, those may be selected which will produce the male sex; in these the air-cell is in the centre of the end. If the cell be a little on one side, the egg will produce a female chick. The position of the air-cell is easily discovered by holding the egg between the eye and the light." But, if the round egg, which, according to the first theory, should produce a pullet, have the air-cell in the centre of the end, it ought, according to the second, to produce a male chick; while, on the other hand, the oblong-shaped egg may have the air-cell on one side, and therefore the inmate should be of the feminine gender. It is obvious that these tests are contradictory, and we have only to remember that as little, if any, variation is ever found in the shape of the eggs of any one hen, it ought to follow that the produce should invariably be of one sex, which is never the case; we are, therefore, not inclined to believe in the opinion advocated by Columella and his followers.

Respecting these erroneous ideas that have been thus placed before the public, with regard to the possibility of judging beforehand of the sex of eggs, from their shape or the position of the air-vesicle, a slight acquaintance with the anatomy and physiology of the fowl would disprove the truth of the statement. The germ of the future bird is formed with the yolk in the ovary; and as the latter passes along the egg-passage—a tube upwards of two feet in length—it merely receives in its progress the white, the two layers of membrane which enclose the air-cell between them, and lastly the shell, these being formed or secreted by different parts of the canal. It is evident that the air-cell is not formed until after the white and the inner of the two membranes is completed, and can therefore have no influence upon the germ. The shape of the egg, moreover, entirely depends on the shell, which is the last part formed; and as the germ in the yolk is already completed it is exceedingly improbable that the one can have any connection whatever with the other. Perhaps the best reply to this absurd theory is that it has been repeatedly disproved by the most careful experiments.

It will not be found desirable to hatch Spanish chickens at a very early period of the year, unless they are designed for exhibition at the Autumn Chicken Shows. The end of April is quite soon enough for them to make their appearance, and those birds that are not hatched till May will eventually be found to make the finest specimens. If produced too early in the year the young birds suffer from cold, as they are much longer in fledging than most other breeds. The young when first hatched are clothed in black down, marked with a certain proportion of white on the fore part of the body; this, however, is followed by the same black plumage as the darker portion. During the growth of the feathers it is exceedingly important that the birds should be well fed, for not only has the growth

of the body to be provided for, but the materials for the production of the feathers must also be supplied; we should therefore strongly recommend the system of feeding found so advantageous in promoting the rapid growth of Dorkings, and described in the communication of Mr. Douglas in the chapter on that variety.

With regard to the time of year that our earliest Spanish broods should make their appearance, we cannot do better than give the opinion of Mr. Lawrence, of Penzance, who has bred them largely and successfully:—

“ I think the chicks hatch readily, and are easily reared, with proper attention to the season of the year selected for that purpose. I do not recommend Spanish eggs being put under hens earlier than the first week in April, on account of the unfeathered state of the chickens, for it is nearly ten weeks before they can be called perfectly fledged. They require more care for the fortnight following hatching than Cochins; but after that time, I have found them to be as hardy and as easily reared as any other fowls at this season of the year. They call for no precautions as to subsequent management, beyond what falls to the lot of fowls in general.”

These recommendations we find confirmed by the practice at Knowsley, where, when desiring to have early chickens, Admiral Hornby never places more than seven, or, at the most, nine eggs, under a hen during the months of February and March. He justly observes:—“ She cannot then properly cover more, nor generate sufficient heat at that chilly season; and when, as happens thus early in the year, ‘scrattle’ is not plentiful, what will keep five chickens is but a bare mouthful for ten.”

Soft blue-black down, more or less marked with white on the face, throat, and breast, forms their early garb; and when feathering begins, there is usually a longer interval than we wish between the casting off of the one covering and the assumption of the other. However immaterial this may be found in the warm sunshine of a Mediterranean climate, it is apt to prove a serious matter in the chilling blasts of our own island, and calls for nutritive food and warm housing. But with these precautions, which indeed would pay well for all poultry hatched very early in the season, the Spanish fowl is as likely to thrive, and answer our several purposes, as any other race—so far, we mean, as regards its vigour of constitution and endurance of our seasons when thus cared for.

In the case of very early chickens, hatched during the winter months, it will be found necessary to feed them after they have retired to rest; young chickens cannot be expected to thrive if constrained to go without food from four or five o'clock in the afternoon until seven o'clock the following morning; if so long an interval as twelve to fifteen hours elapses between the last evening and the first morning meal, the crop is perfectly empty for several hours, and the young birds are hungry and exhausted for want of food.

Spanish chickens grow rapidly—feathers usually begin to appear at about five weeks on the centre of the back and on each side of the breast; if healthy, the fifth month should see them in full plumage. The cockerels acquire the white

face before the pullets, the latter rarely getting it in full perfection during the first year. But there is considerable uncertainty with regard to the time when this much-coveted point of excellence makes its appearance. Some chickens, which give little or no promise at first, afterwards display this feature in perfection, while others originally more promising disappoint us at maturity. A red fleshy faced pullet never, under any circumstances, makes a good-faced hen. The blue-faced birds, on the contrary, always show the white face, more or less perfect, as they arrive at their full growth.

Admiral Hornby, formerly a very extensive breeder of this variety, writes as follows respecting their general management:—

“I am not aware that the Spanish fowl is liable to any particular disease: it is hardy, and but little subject to the roup, that curse of the poultry-yard. I may add that I consider the Spanish fowl inferior to Cochins in the number of eggs they lay, but superior in the weight laid; they are smaller consumers, they bear confinement as well; are inferior as nurses and mothers, but superior as table fowl, their flesh being white and delicate, although cooks and poultry-dealers dislike their dark legs. Like other fowl, they require frequent change of food, which is conducive to health in all fowls. If fed too high, I have found them subject to an eruption on the white ear-lobe, which is difficult to cure. As regards food and feeding, I prefer soft to hard food; but it is my practice to scatter a portion of the latter daily among straw, a practice which compels the fowls to scratch and look about for it, and prevents gobbling and repletion of the crop. Gravel or any coarse sand—the former in preference—is indispensable, and the range of a grass field is highly conducive to health; raw meat is, in my opinion, objectionable, although many breeders give it. In winter, when worms and slugs are not to be had, and animal food is required, I prefer a little cooked meat or a bone for them to peck. Potatoes or meal, with milk, is capital food. I may add, that more chickens die from drinking dirty water than from any other cause. Old birds (hens much more so than cocks) sometimes suffer severely in the moult, and if cold weather should then come are a long while in getting over it; but soft and hot food, as bread and milk, porridge, a little chopped meat, bread, and ale, with warm lodging, will pull them through.”

Spanish are not so liable to fasciolæ or gapes as many other varieties of fowl. In common, however, with other slow-feathering breeds, they occasionally suffer from cold and wet; they seldom show any inclination to sit; and this, combined with the circumstance of their being bad incubators, renders them unprofitable as a farmer's breed; otherwise their numerous large eggs would justly recommend them for that purpose.

Although these birds have many points of merit beyond mere appearance, nevertheless, considering the manner in which the rural homestead is generally managed, they can hardly be strongly recommended to the farmer. All persons agree in declaring the old birds to be hardy and vigorous in constitution; and with the precautions of warm and dry housing and good food they generally get well through

their prolonged moult. These requisites, however, are by no means so generally afforded to the poultry in the farmer's yard as they ought to be; and unless these valuable birds receive more attention than is usually bestowed on Barn-door fowls we could not recommend their being purchased.

On the other hand, when the poultry are properly housed and fed as they ought to be, we have no doubt of Spanish being kept with profit, especially in localities where large eggs are in demand. In such a case they will be a valuable addition to the poultry-yard. They submit readily to confinement, and with care they thrive within narrow limits. Very fair specimens are constantly seen in our London mews, which do well and furnish a very good supply of new-laid eggs.

Mr. E. Bond, of Leeds, states—"I have myself kept Spanish for many years, and though on the whole inclined to assign the palm to the Cochins, I have, nevertheless, no intention of giving up my Spanish. The latter are not so easily reared in this locality as the former, but I consider them less tender in bringing up than the Dorkings; and when they have reached maturity I perceive no difference. They have done well with me here, and there is undoubtedly no variety, taken altogether, that presents a more striking appearance. Individually they are handsome, both males and females; and the lustrous black of their plumage, so strongly contrasting with the white cheek and coral comb, and the uniformity of the whole flock, render a good collection of these birds as agreeable a sight as the poultry-yard can well produce.

"As to their utility, that must depend upon the requirements of their owner. If he seeks for eggs, they are as good, if not better, than any other fowl he can keep. True, they do not lay so well in winter as the Cochins, but then their eggs are larger, and the desire of incubation does not occupy their time. Believing that they will lay as great a weight of eggs in the year as hens of any other breed, I should say that no other fowl is better suited to the wants of such farmers or cottagers as possess a good sale for eggs. If they live, as I do, near a large town, they have this additional advantage, that their flocks never look dirty or soiled.

"They are certainly good table fowls; by some, indeed, they are considered as very superior for this purpose. With regard to their consumption of food, I do not think that Spanish are at all extravagant in this respect: for anything that will keep ordinary fowls will keep them when once they reach maturity.

"In their habits there is nothing peculiar requiring notice; they are not, it is true, so quiet or so disinclined to roam as the Cochins; but if well fed at home, they will not be found to stray far from their walk. Nor are they quarrelsome among themselves to a degree that is at all troublesome. As regards management, I need only say that what other good birds require will suffice for them. With all poultry, in my opinion, a good dry warm roost is half the battle; and to keep the damp away, sand, dry earth, chaff, or anything that is at hand and will effect this object, should be spread upon the floor, and frequently changed.





71421 CON.

COLUMBIAN FOWL.

BLACK AND WHITE SPANISH FOWLS.

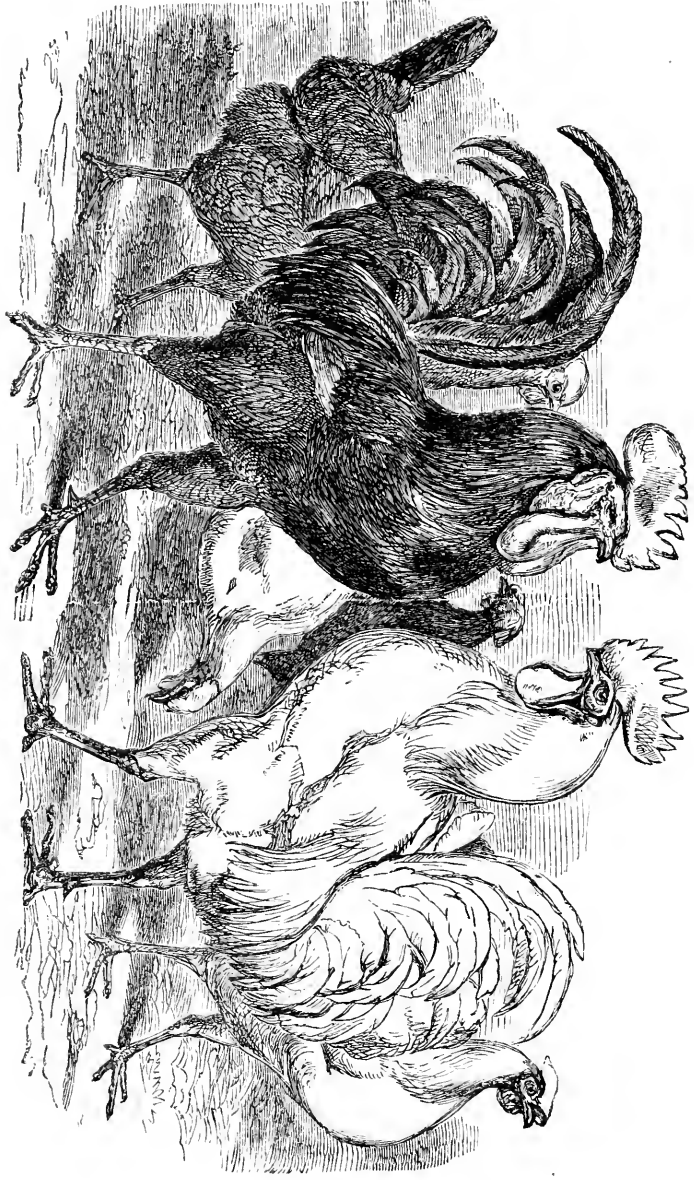



“ These are all the precautions I employ, and they prove amply sufficient to keep my birds in health, vigour, and beauty.”

In concluding the present chapter on the Spanish fowl, a few remarks may be made on the different cross-bred birds owing their parentage to this race. It is difficult to imagine any cross that would not destroy the noble and truly aristocratic appearance of these birds, and that without any counterbalancing advantage to be gained, for the long limbs of the Spanish would not fail to deteriorate the form of any other variety, unless, indeed, it be that of the Malay. In consequence of Cochin hens being frequently kept as foster-mothers for Spanish, crosses between a Spanish cock and Cochin hens are not unfrequent; these mongrels are good layers of fair-sized eggs, and also good sitters, but the plumage varies in colour, nor can they be regarded as ornamental. Some cross-bred chickens between the White Spanish and White Cochin were remarkable as being of a uniform slaty grey, closely resembling the Andalusians in colour.

Some suggestions were made some time back by Mr. Trotter in the Royal Agricultural Society's Journal, as to the improvement in the size of the eggs of the Silver Pencilled Hamburg or Chitteprat by a cross with the Spanish; but the fact was probably overlooked that a cross between two non-sitting varieties of poultry almost invariably produces a mongrel that becomes broody and sits with remarkable steadiness; hence the value of such birds, viewed as mere machines for converting so much barley into eggs, would be greatly less than that of either of the pure breeds from which they were descended.

The only disease which requires notice in this place is the frostbitten comb to which Spanish exposed in cold situations are not unfrequently subject. When this accident occurs, the comb becomes very dark-coloured and stiff: if the bird is, with a mistaken spirit of kindness, taken into a warm room, mortification inevitably takes place, and the entire or partial loss of the comb is the result; if, on the contrary, the circulation is restored by rubbing the comb with snow, or, if that is not to be procured, with ice-cold water, until such time as the natural colour is restored, no harm results, provided the application is made before the bird has been suffering any lengthened period of time.

The most important varieties of the Spanish breed are the *Minorcas* and the *Andalusians*, to which may be added the *White Spanish*, the *Anconas*, and the *Columbians*.

The *Minorca fowl* is very common in Devonshire and Cornwall, and other counties of the west of England, though by no means limited to that district. In the western parts of Cornwall especially, birds of this variety have long been valued as first-rate layers, and consequently they form the principal stock of many poultry-yards. The milder temperature of the south of England offers peculiar advantages for the successful management of these fowls, which, though for a long period accustomed to our climate, still manifest impatience of severe cold.

In the *Minorca* fowls the white face so characteristic of the *Black Spanish* is absent, the ear-lobe alone being of that colour. But in both male and female

there is the same full development of comb and wattle, especially in the hens, some of which are inconvenienced in feeding by the large comb flapping over the eye and interfering with the action of the beak. They are also lower on the legs and of squarer build than the true Spanish. Minorcas are excellent layers, but very bad sitters, rarely if ever evincing any desire to incubate. As hardy and abundant egg-producers they are especially valuable. As table fowls, their more rounded form and shorter legs give them advantages over their aristocratic relations.

The *Ancona*, now very rarely seen at our shows, is closely related to the *Minorca*, the difference being that it possesses a mottled or splashed plumage, the colours of which are very uncertain; they are usually black and white, but specimens of a rich partridge-colour were formerly not unfrequent. The colours of the mottled *Ancona* are seldom clear; and their appearance, therefore, is rarely calculated to obtain admiration.

Under the title of the *White Spanish* are included two varieties of the breed: one resulting from the action of some peculiar constitutional cause, which determines the production of a partial or entire white plumage at moulting time in a bird previously black; occasionally, also, white Albino chickens will be bred from black parents,—but in breeding from both these varieties, the original colour is generally reproduced.

A permanent breed of *White Spanish* was frequently exhibited some few years since; but the frequent presence of an additional toe, and the red colour of the face, led to the suspicion of their being cross-bred birds; and the want of that striking contrast between the jet-black plumage, the coral comb, and white face, which adds so remarkably to the ornamental appearance of the original bird, caused them to have but few admirers.

The *Andalusians*, however, have become established favourites with several breeders; and a poultry exhibition seldom occurs in which good specimens do not make their appearance, and take honours in the class for extra varieties. One of the most successful exhibitors of this variety is Mr. Coles, of Fareham, Hants, to whom we are indebted for the following account of their characteristics:—

In weight and size the *Andalusians* resemble the *Spanish*: the cocks weigh from six to seven pounds, the hens from five to six pounds. The carriage and form are stately and good, not differing from that of the *Black Spanish*.

The general colour of the plumage varies from dark slate bordering on black, to a dove-colour, the hens being generally bluish grey.

The legs and feet should be blue, and totally free from feathering.

The comb in the cock should be very large, erect, single, and evenly serrated, that of the hen very large, single, and pendent. The wattles are well developed.

The ear-lobe white in both sexes; but the face, unlike that of the *Spanish*, is red.

In addition to the above description, Mr. Coles has furnished us with the following account of the economical merits of his favourite breed:—"I have

kept the Andalusian fowls for several years, and find they are the least trouble of any variety tried by me; my runs are very limited, without grass-field or outlet; and I have less sickness in this class than in Black Spanish. I obtained my first stock from Portsmouth, where they were landed from a Spanish trader in 1851. I consider them in all respects very superior for hardiness, and as layers. Coming to hand early, they no doubt would be a useful kind to breed as a table fowl, in the early part of the year. The hens usually commence laying in December, and continue with scarcely any omission until the following November, averaging four to five eggs each weekly. I have pullets, hatched early in March last, that commenced laying in August, when little more than five months old. They are non-sitters; I have never had one instance of their wanting to hatch. I find the chickens very hardy, feathering early, and very precocious. I have had them crow at six weeks old. I believe Andalusians to be a useful and beautiful variety, that only requires to be better known to be appreciated. I find them far wilder in their habits than Black Spanish, and also more pugnacious. As to feeding, my system is—corn in variety, night and morning; soft food in the middle of the day; meat once a week, with all the green food that can be procured from a large garden; and I believe my birds are far healthier in their confined runs, than those of my neighbours having plenty of grass outlet. After fifteen years trial of them I find they still maintain their merits as a prolific and hardy breed; they do not degenerate, but maintain their characteristics without variation.”

Mr. John Taylor, formerly one of the most enthusiastic amateurs of this variety, states in his description of them:—“The following are some of the points to which I attach most importance: comb large, erect, and evenly serrated; cheek white; legs bluish; plumage bluish-grey or dove-colour, each feather being lightly margined with a darker tint. Hackles glossy, velvety, black, falling evenly on each side of the breast, in strong contrast to the colour of the latter; tail full, carried very uprightly, with the sickle feathers well arched. The hens have the same colours, but their combs are pendent.

“Cocks will average in weight 7lbs., while the hens may be stated at about 5½lbs. Pullets hatched in April commence laying in October, and continue throughout the winter. Two pullets and three hens averaged 120 eggs each in the year. In shape and colour they resemble those of the Black Spanish. The hens seldom show any desire to sit; but when this does happen, they prove themselves excellent mothers. The chickens, unlike the Black Spanish, are feathered early, are hardy and very precocious. As a table fowl, I have a very high opinion of their excellence.”

We may gather from this statement of Mr. Taylor's, that the Andalusian has a fair title to be considered as a permanent variety of the Spanish family. The rich slate-colour of their bodies is well contrasted with the deep black of their hackle and tail; while in size and vigour of constitution, especially as chickens, they seem to be on at least equal terms with their black relations.

The title of *Columbian fowls* was formerly given to a large black variety of

poultry that was held in some repute from its magnificent size and hardihood. The name, like that of almost all other poultry, is a misnomer. Neither our ordinary fowls, nor any of those birds that are closely related to them and constitute the genus *Gallus*, are natives of the American continent. The denizens of the farmyard were introduced to the west after the discovery of America by Columbus. The origin of the so-called Columbian fowls is obviously to be traced to a cross between the Spanish and the Malay. The well-developed comb and wattles and the black plumage being derived from the first-named parent: the large size, great weight, and hardihood, from the latter. Columbians are stated, by those who have kept them, to be remarkably prolific, laying numerous eggs of large size, which produce rapidly growing and precocious chickens. Should any fancier deem the variety worth reproducing, we should recommend him to select a very large, well-developed Spanish cock, redness of face being quite immaterial, and to mate him to some large-sized Malay hens. By this arrangement, the desired form, colour, and size would be more readily obtained than by matching a Malay cock with Spanish hens, for it is an axiom in breeding that the external characters of form and colour are chiefly derived from the male parent, whilst size, constitution and vigour follow the female. Here the comb, the dark plumage, the well-developed tail and prominent breast might be secured in conjunction with the heavy weight of the Malay. But whether or not the variety is worth the trouble of thus reproducing, we must leave to the taste or fancy of the breeder. In poultry, as in most other matters, the old maxim respecting individual taste, *de gustibus non est disputandum*, is undeniable. Some men can see nothing but elegance and grace in the quaint outlines of a Cochin, whilst the æsthetic perceptions of others are gratified by the contemplation of the feathered crest of the Polish, and a third set regard a Frizzled fowl, with all its feathers turned the wrong way, as though it had been pulled through a hedge backwards, the very perfection of gallinaceous beauty.

CHAPTER XII.

THE GAME FOWL.

GAME are pre-eminently the English fowl ; in no other country but our own is the true-bred Game cock indigenous.

Cock-fighting has been pursued from time immemorial in many parts of the world, and is now a national pastime in the East ; but the birds employed for the purpose are what would be termed in this country small varieties of the Malay, wanting altogether the exquisite beauty of form and vigorous grace that characterize the true English breed. In the well-known print of Col. Mordaunt's celebrated Indian cock-fight the birds delineated are most of the Malay stamp, larger, heavier, and much more clumsy in their form, gait, and movement than those of English descent.

There cannot be a doubt that the superiority of the Game fowls bred in England has been entirely due to the practice of cock-fighting, which was extensively indulged in by all classes of society until the comparatively recent legal enactments, rendering its practice punishable with heavy pecuniary penalties.

The practice of cock-fighting may be regarded as one which carries out, under man's supervision, the principle of action which has been so ably described by Darwin as "the struggle for life." Those cocks which have proved the strongest, most active, and courageous, and have stricken down their antagonists in the pit, have been preserved by man as the progenitors of their kind, this process of "selection" has been carried on for a long series of generations, and the ultimate result has been that the English Game fowl is unequalled in elegance of form, and is universally regarded as the highest possible type of gallinaceous beauty.

In this country so great has been the care taken of their purity of blood, that private stud books and tables of descent have been kept, and these carry back the unstained origin of many strains for more than a century.

In describing the characteristics of the Game fowl, there is a generally recognized standard for form and figure, which must not be departed from, whatever variety of colour the birds may present. Consequently, these characters may be stated once for all, leaving merely the variations in plumage to be spoken of under the head of each sub-variety.

In weight, Game fowls vary very considerably. In the days when they were bred almost exclusively for the cockpit, 4 lbs. 8 or 10 oz. for the cocks was the size aimed at by the breeders ; at the present time this limit is often passed, and some

of our most successful exhibitors state that their birds reach 6 lbs. when two years old; but beyond this weight the bar sinister may be looked for in their escutcheon, owing to an alliance with that baue of the English Game fowl, the Malay.

The carriage and form of the Game cock are certainly more beautiful than that of any other variety of domestic fowl. The neck is long, strong, and gracefully curved; the hackle short and very close; the breast broad; the back short, broad across the shoulders; the whole body very firm and hard, with a perfectly straight breast and back, the latter tapering towards the tail; the wings large and powerful, and carried closely pressed into the sides; the thighs strong, muscular, and short, tightly clothed with feathers, and well set forward on the body, so as to be available for fighting; the shanks rather long, strong but not coarse, covered with fine scales, and of moderate length; the feet flat and thin, the toes long and spreading, so as to give a good hold on the ground; the hind toe must be set low down, so as to rest flatly on the ground, and not merely touch with the point,—a defect which is known as “duck-footed,” and is regarded as a serious disqualification, as it renders the bird unsteady when pushed backwards by his opponent.

The plumage is compact, hard, and mail-like to a remarkable degree, and possesses a brilliant glossiness that cannot be surpassed. The tail in the cock is rather long, the sickle feathers gracefully arched, not very broad, and carried closely together, the whole tail curved backwards and not brought forwards over the back,—a defect which causes the bird to be termed squirrel-tailed.

The head in this variety is extremely beautiful, being thin and long, like that of a greyhound; the beak massive at its root, strong and well curved; the eye large, very full, and brilliant in lustre; the ear-lobe and face of a bright scarlet, and the comb in undubbed birds single, erect, and thin. The spur, which is exceedingly dense and sharp, should be set low on the leg, its power as a weapon being thereby greatly increased; it may be remarked that this offensive organ is often present in the softer sex.

In the hen, the form, making due allowance for the difference of sex and alteration of plumage, resembles that of the cock. The head is neater, the face lean and thin. The small thin comb should be low in front, evenly serrated, and perfectly erect. The deaf ear and wattles should be small. The neck, from the absence of hackle feathers, looks longer and more slender than that of her mate. The tail feathers should be held closely together, and not spread out like a fan, as not unfrequently stated. The plumage should be so close that the form of the wing should be distinctly visible, the outline not being hidden by the feathers of the body.

The varieties of Game are very numerous, as from the anxiety to avoid any deterioration in figure or courage, crosses between the principal breeds have been frequently resorted to, so that a number of sub-varieties present themselves to our notice, many of which are still further complicated by the use of names of merely provincial employment.





LEIGHTON, BROTHERS.

BLACK-BREASTED RED GAME

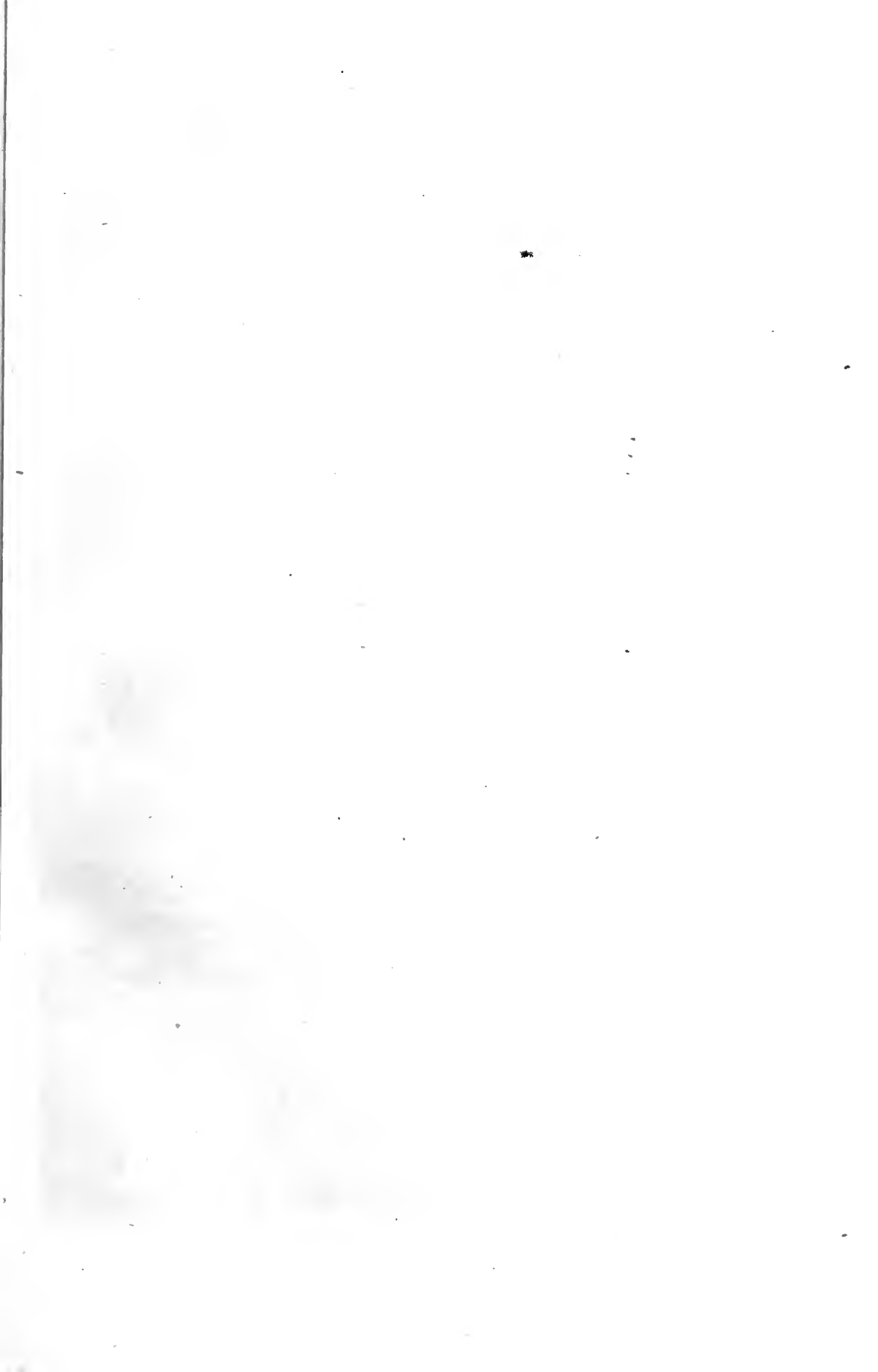

In place of endeavouring to give a description of each sub-variety, frequently perhaps of merely local celebrity, we will follow the arrangement that is used at the principal poultry exhibitions, and describe the different breeds of Game fowls in the following order:—

Black-breasted Reds, Brown-breasted Reds, Duckwings both yellow and white, with which are usually classed the Greys and Blues, Blacks (including the Brassy-winged), Whites, and Piles.

In the "Standard of Excellence," published by the Poultry Club, the characters of Ginger-red and Birchen-yellow are also given; and there are also several breeds of less notoriety, as the Henny-tailed, the Indian, &c.

For the description of the most important of these varieties we are indebted to Mr. John Douglas, of the Clumber Aviaries. Writing of the Black-reds, he says:—

"At the present date, pure black-breasted red game are scarcer in England than was formerly the case. This arises from their having been so much crossed with brown-red, duckwing, and piles, that the pure colour has been nearly lost. The colour most frequently seen at the present time is a dull clay, or deep rusty red on the hackle, back, shoulders, and shoulder coverts. Instead of the beautiful orange-red, so much admired, the points of the hackle feathers are frequently of a red straw colour: these defects arise from injudicious crossing and want of sufficient knowledge respecting the production of colour. We must act upon the old maxim that 'like begets like,' and breed with perseverance, from pure-feathered birds, in order to obtain the pure colours we desire. The most important points in the colour of a black-red cock are that the feathers of the head should be dark red, inclining to orange; the hackle clear orange-red to the very points of the feathers; the back, shoulders, and shoulder coverts rich violet-red, the saddle orange-red, and the breast and tail rich black, perfectly free from white.

"In the different strains of black-reds the hackles frequently run off to a very light shade at the points of the feathers, especially if there is any duckwing blood in the strain; whereas the birds that have a trace of the brown-red cross have a deep or dark red hackle, which, in consequence of a sameness of colour, does not contrast well with the back and saddle, where a marked distinction ought to appear. If you breed from these deep reds, the pullets produced are of too dark a brown, and have the feathers of a dull light colour, instead of the beautiful golden brown, with a deep salmon breast, which should mark a pure black-red pullet. Black-red hens, to mate with pure-coloured cocks, must have light golden hackles striped with black, the colours being distinct and not running into each other; the back and shoulder coverts must be light brown, slightly inclined to a shade of straw colour, perfectly free from mousing or pencilling; the breast clear salmon colour well up to the throat, but becoming ashy towards the lower part of the breast.

"Black-red hens, like all varieties of game, are good sitters and mothers, being very careful of their young; but they are rather savage towards other chickens, therefore it is desirable to coop them a good distance apart. I never set more

than eleven eggs under a game hen, and do not like to have any chickens hatched before the middle of April, but as many as I possibly can in May. I have never found early-hatched game chickens feather so well as those hatched at the end of April and during May. I have often seen chickens hatched in February commence to throw their feathers about September—not, however, in a regular moult, but gradually lose their plumage by degrees, without acquiring the good firm feather which is so necessary to success in the game classes.

“After they have hatched, I coop the hens with chickens until the latter are seven or eight weeks old, feeding them liberally with custard and oatmeal, in the same way as I recommended for rearing Dorkings.

“I consider it exceedingly desirable to send out each cockerel and four or five pullets to a run directly on their leaving the hens, and prefer a cottage run if possible. When brought up at a cottage, chickens will always show boldest from the first year; for being accustomed to the presence of society is beneficial to them, giving them boldness and confidence to be stared at in a crowded show. If I have not a sufficient number of walks or separate runs, I put all the cockerels together, dubbing them when about four months old, as runs turn up for them, not daring to dubb them and turn them down again amongst each other, or war to the death would occur to nearly all. The pullets I simply turn down in any of the home runs, picking out all those that are in the least inclined to run red or pencilled on the wing, or with light breasts, and killing them off for the table as wanted.

“Under the name of brown-breasted red game are included streaky-breasted, marble-breasted, and ginger-breasted red; in fact, there are as many shades of colour admissible as there are days in a month: there is no other breed of game having so many variations in colour as brown-reds, owing to the fact that they are bred to a very great extent by men who rear birds for the pit and who care nothing whatever about shades of colour, therefore do not trouble themselves to mate their birds so as to breed true to feather, but match up blues, piles, duns, and brown and black reds indiscriminately; therefore the blood of these various strains is so intermixed that it takes a length of time to produce anything like uniformity of colour, if any of these birds are bred from.

“It is true that a few gentlemen exhibit birds almost all one colour: they are but few, and well do they know the trouble they have had to breed them up to anything like the standard, and the large number of faulty-coloured birds they rear. Brown-reds have deteriorated to a great extent of late years. Some few years ago the managers of the Liverpool exhibition had to refuse entries for their £100 gamecock sweepstakes two months before the show opened. At that time you could see as many as twenty or thirty brown-reds, every one of which almost seemed better as you looked at him than any of the others, and was really something strikingly beautiful to stand and admire; but now you have to hunt a show to find more than one or two above ordinary merit.

“Another cause of the falling off of the brown-reds has been the increase in

the number of their admirers, and the high prices given for birds within the last few years; consequently the breeders of these birds have had such a call for them that any birds bred by crossing the different strains, if at all near the mark for colour, have been hunted up and sold for high prices. The result of breeding from those fine-feathered cross-bred birds is to produce foul-feathered chickens; sometimes they are crow-winged with dark bodies, others are ginger or robin-breasted, and many other shades of brown-reds are produced, but all without the striking contrast that ought to be seen in the different parts of the plumage of a pure brown-red.

“The purest strain of brown-reds—I mean a strain that has not had any black, red, duckwing, blue, ginger or pile cross for many years—will still produce several shades of colour in one brood, showing that the breed may have been crossed at some period. The colours in brown-reds that I have found to come most certainly like the parents are a light streaky-breasted cock, with back and shoulder coverts dark crimson; saddle red maroon on centre, passing off to a dark lemon and straw; hackle red, with the middle of each feather dark. Hen with the body nearly black, but intermixed with grey on the wing; the hackle bright brassy orgolden.

“By breeding from dark-wing birds, and dull deep red cocks and coppery-hackled hens, you obtain hardy-looking fowls, but with no beauty of plumage, and very little distinction in colour; but the ginger-breasted cock mated with light brown-red hens, with feathers streaked with gold, produce many chickens like their parents. The dark streaky-breasted cocks, if mated with light-coloured hens, sometimes throw those clear-feathered, streaky-breasted cocks that are so much admired. The cross with a good feathered black-red cock and dark brown-red gold-hackle hen sometimes gets beautiful cockerels, but nothing will give so much satisfaction as the first named put together, if the birds happen to hit.

“The other colours of brown-reds are seldom shown, and as it is doubtful if they ever will become favourites, it is not necessary to describe them, especially as it is almost impossible to breed them true to any particular colour; in fact they come anyhow, at random, and amongst some of the best broods they will make their appearance at times.

“In duckwing game the cocks, to be correct in colour, should have the hackle nearly clear white, with a very slight tinge of straw colour, without any decided yellow tinge or dark streak on the feather. It may be asked, Where are we to see such birds? I can only say there have been such, and I am in hopes of seeing them again before many years. The saddle should be as nearly as possible the colour of the hackle; the back a maroon straw; the shoulder coverts a rich brass or copper maroon; the breast and tail pure black. The hens, to match these cocks, should have their necks of a clear silver striped with black, the silver to go right up to the comb, but being a little darker above the eyes; the back and shoulder coverts, a bluish grey shaft of feather, scarcely showing any difference from the rest of the feather—any approach to red or pencilling is decidedly objectionable; the breast salmon colour, of a nice rich shade.

“To breed duckwing cocks of these colours, the hen herself must be bred from duckwings on both sides, or you will not get the bright colours desired. The cock employed must be a pure black-red, for if a cross-bred cock is selected you are certain to lose the black breast; on the other hand, if you want to breed duckwing pullets, a good coloured duckwing cock may be put with pure black-red hens, but you get the finest coloured pullets from duckwing hens running with a duckwing cock, but in no instance did I ever know a good cock obtained in this way; for by breeding from two silver-grey duckwings, you get marble-breasted, throstle-breasted, and mealy greys, and by breeding from half-bred duckwing you get dark maroon shoulders, and yellow hackles tinged with red, and mealy-winged hens with pale breasts.

“Crossing the half-breds of the different strains has at the present day nearly destroyed our beautiful silver duckwings. To get them again will take some time. Before concluding what I have to say about breeding duckwings, I may add that now and then it is desirable to cross with the brown-red, which assists to give a hardness to the feather.

“The best piles are bred by crossing red and white game, but they may also be bred from a pile cock and pile hens. Some of the best and purest piles I ever saw were bred from a spangled cock and white hen. There is a breed of spangles sometimes seen at shows which can be traced back to a breed of tasselled spangles that the late Lord Lichfield had in Staffordshire twenty-five years back, and to which many strains of reds throw back, even up to this day.

“With regard to breeding pure white or pure black game, I may state a strange fact, that if you cross a black with a white game you get birds of both breeds of the clearest colour.”

In the foregoing communication from Mr. Douglas, the three chief varieties of game fowl, namely the black-reds, brown-reds, and duckwings, are so fully described as hardly to require any further account at our hands.

One point, however, to which attention has not been drawn is the colour of the legs. It is hardly necessary to state that all the birds in a show-pen must match in this respect, or they would inevitably be passed over by the judges without even the chance of a commendation.

The colours most desired vary in the different varieties; thus, in the black-reds, the shanks may be either willow, olive, yellow, white, or blue, being most esteemed in the order in which they are named. In the brown and ginger reds, olive, bronzy black, or dark willow, are according to the “Standard of Excellence” the correct hues.

The shanks of the yellow duckwings are given as willow, olive, or yellow; those of the silver duckwings willow, olive, bronze, or blue.

The *Piles* are the Game fowls whose plumage has a proportion of white for one of its component colours. They are frequently heavy birds, and were formerly highly esteemed for practical purposes, and in many districts are still greatly esteemed. The cocks of all the various strains of Piles are red and white, or



DICKWING GAME FOWLS.



yellow and white, in one or other of the shades of those colours; but the markings of each individual vary so greatly, that it is somewhat difficult to describe their arrangement. The object of the breeders of show birds is to get the colours in the cocks as distinct and brilliant as possible. It is a singular circumstance that in breeding Piles from a black-red and a white, the red colour should remain almost unchanged, whilst the black becomes white; so much is this the case that, in the opinion of many Pile breeders, the most desired arrangement of colours for a Pile is that he should be red where a black-breasted red is red, and white where he is black. The "Standard of Excellence," however, departs somewhat from this rule, permitting the upper part of the breast of a Pile cock to be marbled with red. The same high authority describes the hens as being chestnut red and white, the tail being exclusively of the latter colour. The legs of Pile game should be yellow, willow, or white.

White game require no lengthened description of the characteristics of the plumage: it should be pure and unsullied white in both sexes, the cock being as free from yellow tinge as possible. The colour of the legs varies; most breeders prefer the yellow—some, however, adhering to the white. In the midland counties, where they have long been favourites, the white game are frequently termed "Smocks."

Black game are birds of unquestionable purity, being formerly a celebrated fighting breed. Their plumage, in good specimens, is of an extraordinary degree of metallic brilliancy, resplendent with lustrous shades of green and purple. The legs should be dark olive or black.

In brassy-winged game, the cocks have the wing-coverts of a bright golden yellow, the rest of the plumage being entirely of the beautiful raven black, characteristic of the pure black birds. The hens are of a uniform good black; the wing-coverts being destitute of the peculiar colour of those of the cock.

Blues and greys have usually a dull slate breast, with straw-coloured hackle and saddle; the hens being wholly of the former colour.

The Birchen yellow cock has a deep straw-coloured hackle and saddle, passing into a coppery colour on the back. The breast is cream colour, the feathers having a reddish-brown shaft, the tail black. The hens are extremely pretty, being of a general greyish colour, but the hackle feathers being margined with black, and those of the breast with creamy white.

The cuckoo game, now almost, if not quite extinct, repeated the colours of the cuckoo dorking, each feather being banded with dark grey on a lighter ground.

The Hennies, or Hen-Cocks, from their singular variation of plumage, demand a larger notice at our hands. The following account of the origin of one of these strains is from the pen of the present Editor, Mr. Tegetmeier, who writes:—

"The most important abnormal variation hitherto described in the covering of birds is the assumption of male plumage by females; this is common in the ordinary pheasant, and is always connected with diseased or abortive ovaries. The hens exhibiting this change are consequently always sterile. The late Mr. Yarrell

published an account of these cases, illustrated by drawings of dissections, in the *Philosophical Transactions* for 1827, and his 'History of British Birds,' vol. ii., page 319. The same change of plumage, arising from a similar cause, also occurs occasionally in the hen of the common domestic fowl (*Gallus domesticus*), although a barren hen more commonly assumes merely the comb and wattles of the male without changing the appearance of the feathers. Some very well-marked specimens of this latter change were deposited by me in the museum of the Royal College of Surgeons two or three years since. The variation illustrated by the specimens exhibited by me to the members of the Zoological Society, March 26, 1861, is the converse of that which has been mentioned, it being the assumption of the female plumage by the adult male.

"It is well known that there are certain breeds of domestic fowl the males of which are always more or less hen-feathered; the most remarkable of these is the Sebright bantam. In this breed, however, the variation is hereditary, and the young cocks are as hen-feathered as their progenitors. Under the title of hen-cocks, certain game fowls acquired a high degree of notoriety for their prowess in the cock-pit. I have an engraving, representing a bird of this description that was formerly the property of George Edwards, the jockey who rode Phosphorus and Variation when they won the Derby and the Oaks. He is represented as trimmed for fighting, and is described as "Hector, a hen-cock." The late Mr. Caldwell informed me that he perfectly remembered the bird, and that he was notorious as having won a Welsh main—the most trying test of courage and endurance to which a game cock can be subjected. The peculiarity of plumage was hereditary in this variety of fowls.

"The specimen that I exhibited to the society was bred by myself, and had never been out of my possession, consequently I was able to describe with great certainty the remarkable changes that it underwent; and as I have been breeding from the strain some years, I can speak without doubt as to there being no cross of any description introduced. The cock, whose portrait in his hen-feathered condition was engraved from a photograph, was hatched in the spring of 1859, his parents being of the variety known as brown-breasted red game bantams. When seven months old he assumed the full male plumage at his autumnal moult, and I preserved him as my best stock bird for the next season.

"During the year 1860 I bred some very good chickens from him. At the autumnal moult of that year, however, he lost all his cock-feathers; those of the neck, of the saddle, and the streaming sickle feathers of the tail, alike disappeared, their places being supplied by feathers which, both in form and colour, were the exact counterpart of those of a hen of the same variety. This wonderful change was attended with slight increase of size, a great increase of combativeness, and certainly did not depend on any loss of generative power, as in the early part of the next year I sent him with a couple of hens to a run removed from other fowls, and hatched several strong healthy broods from the eggs.

"Some of the cocks were full male-plumage birds of very superior character; a

pen exhibited by Mr. Angel took the second prize at the Crystal Palace show that year. Others of the cocks subsequently bred from him were as hen-feathered as their parent, and retained their hen-like plumage after several moults. Nothing would have been easier than to have established a permanent breed or variety of



hen-feathered brown-red game bantams, had it been considered desirable to do so. The old bird died in 1864, retaining his hen-feathered plumage till the last. His disposition did not at all accord with his feminine appearance: he was combative and courageous to an extreme degree, and as he possessed the sharpest natural spurs I ever felt, he was a dangerous opponent for cocks many times his weight. In fact, I had a great difficulty in getting a run for him, as he had a troublesome habit of blinding cocks five or six times his weight."

This description of the bird was originally published in the *Field* newspaper with the engraving inserted above, and elicited the following interesting communication from one of the most experienced game-cock breeders, who, writing under the signature of "Outright," said:—

"When the art of cock-fighting occupied the attention of country gentlemen and the sport had not become illegal, there might be seen in the yards of tenant farmers many beautiful specimens of the game-fowls of this country—the fine, glossy, black, brown, or streak-breasted red; the gorgeous yellow duckwing; the glittering and gaudy pile, with his wing blood-red, sometimes varying in colour, pied or spotted, and occasionally milk white; the suspicious-looking smoky, or red dun; the black tawny or polecat; and, lastly, the hen-cock, in colour like the ordinary brown-breasted red hen, with short plumage and partridge hackle. These latter birds were never favourites in that celebrated arena for gallic combats, the Royal Pit, in Tufton Street, Westminster, and in

the great mains fought there by feeders of reputation and eminence, such as Gilliver, Potter, Walters, Nash, and Leicester, in which the birds belonging to Mr. Germaine, Lord Ongley, Lord Derby, and other gentlemen of note were to be found, hen-cocks rarely were weighed for the main, but were frequently fought in the byes.

“Generally speaking, hen-cocks were not of the figure and frame to make what was technically called fine match-cocks or big birds at their weight, but they very frequently carried a great deal of spur. One quality they had, which made it dangerous to bet against them—their exact resemblance to a hen. Unless the man who handled against the hen-cock was very careful to convince the bird which it was his province to set, that he was to fight a cock and not a hen (which could only be done by allowing a good deal of pecking to take place before the birds were delivered), the cock, when on the pit, would mistake the hen-cock for one of the fair sex, and proceed to put his wing down, and offer certain delicate attentions, in the middle of which he would receive his death-blow, or get the silver spur driven into his throat, and all chance of recovering his amatory mistake rendered hopeless. In the course of a somewhat long experience as a cock-fighter, I have seen this happen perhaps half a dozen times.

“I had a pair of these birds (brother and sister, cock and hen) given to me by the late William Stradling, probably the best handler that ever went into a pit. I never could get a bird more than 3 lb. 10 oz. from them. The hen was small. The cock fought at 4 lb. while in my possession, and crippled a very fine cock (who, in all probability, otherwise would have made short work with him) by being mistaken for a hen, and getting the first blow. The only difference in the plumage of these two birds was in the length of the tail, which, in the male bird, was something longer than that of the hen, and exactly resembled the drawing of Mr. Tegetmeier’s specimen. I afterwards crossed the hen with a black-red of my own breeding; the result was, that these chickens, which had the usual feather of the game-cock, were never more than tolerable, although the brood cock was of as good blood as any cock then bred. On the other hand, the only chicken which turned out to be a hen-cock proved to be a very good one, and fought a terrible battle as a stag, but lost by an accident.”

The Indian game fowls that have been imported are coarse, heavy, ill-shaped birds, that have evidently been produced by crossing the true English game fowl with several of the smaller Malay native breeds; they fight with courage and bull-dog like tenacity of purpose, but without the wondrous activity of the true breed.

A very singular variety of game fowl, said to be of Indian origin, is described in the following communication from Mr. B. P. Brent, of Parkhurst, near Uckfield, who writes:—

“A cockerel and two hens were sent me by a friend in Germany, who informed me the breed was brought from India, that it was rare and much prized, a good cock fetching 3 or 4 Fredrick d’ors. My cockerel is a dark-breasted red, almost

black-breasted,—not a large bird, but of good game shape, with yellow legs. The striking peculiarity of the breed consists in the number of spurs the cocks have on their shanks,—three, four, or five on each leg; the best cocks having ten spurs. My cockerel, although a young bird, shows the knobs of four spurs on each shank, one above the other, in a row, where the spurs usually grow. The hens are of the brown partridge colour usual in game fowls of the red breeds, with yellow legs—very neat little birds, sprightly and active. One of them commenced laying shortly before Christmas Day, and by the end of January had laid 26 eggs: the eggs are medium-sized and slightly tinted.”

Little need be said as to the accommodation necessary for game fowls. A good grass run is essential, and we cannot advise their being kept by any who are unable to grant them this indulgence. They are impatient of restraint, and never appear in really good condition when debarred from the country exercise that seems required by their hardy constitutions.

In the selection of breeding stock, whatever the variety preferred, the greatest care must be taken, in matching the proposed parents, as regards form, feather, and the colours of the beak and legs; since an injudicious selection may injure the strain for years, and present unwelcome features even after generations have passed away.

The male bird does not appear to influence the progeny to the same extent as the hen. Thus Mr. Brent has observed—“In breeding them much depends on the purity of the hens, for a good game hen, with a dunghill cock, will breed good fighting birds; but the best game cock, with a dunghill hen, will not breed a bird good for anything.” Respecting the ages of the breeding stock, it is not desirable to mate old birds together; a stag or last year’s bird, placed with hens of two or three years old, will be found to produce finer chickens than when an old cock is mated with last season’s hens; at least such was the experience of the breeders for the cock-pit. Where great excellence is aimed at, we would not advise the companionship of more than four hens with the cock. The rule to avoid all relationship in your brood stock, if possible, was not constantly followed by the breeders of fighting birds. They made one exception, that of pairing a hen to her own son; and provided both were superior birds, they found the result very satisfactory; but they were cautious not to repeat the in-and-in breeding.

In colour, the eggs of the game fowl vary from a dull white to fawn, but crosses with the Indian bird impart a still darker tint. The average weight of those laid by full-grown pullets is 2 oz., and $2\frac{1}{2}$ oz. might be considered as a fair weight for those of the full-grown hen.

As sitters, Game hens have no superiors. Quiet on their eggs, regular in the hours for coming off and returning to their charge, and confident, from their fearless disposition, of repressing the incursions of any intruder, they rarely fail to bring off good broods. Hatching accomplished, their merits appear in a still more conspicuous light. Ever on their guard, not even the shadow of a bird overhead, or the approach of man or beast, but finds them ready to do battle for their

offspring ; and numerous instances are on record where rats and other vermin have thus fallen before them.

Their remarkable prowess in defending their young is strongly set forth in the following most interesting account with which we have been favoured by Mr. Hewitt :—“ Not a doubt presents itself to my own mind, that, viewed exclusively for their actual merits, unenumbered by the caprice of poultry fashion or individual prejudice, Game fowls are undoubtedly the most strikingly beautiful of any among the very numerous varieties of domestic poultry. Among any of the truly bred fowls of this variety, the superiority of gait and general contour strikes the eye of parties even the most indifferent and uninterested : and from this cause I have almost universally noticed that the avenues appropriated to the Game at our poultry shows, are those most commonly thronged by visitors. This fully proves how much a good display in these classes tends to the pecuniary success of such meetings. In situations where a free unlimited range can be tolerated, there is not a doubt that Game fowls will take care of themselves, and their progeny, more successfully than any other kind of poultry. Accidents of any kind where these advantages exist very rarely occur ; as of all poultry none are more vigilant in avoiding dangers, nor, again, so capable of repelling aggression ; and many are the instances that recall themselves to my memory of cases in which powerful adversaries have found a retreat suddenly forced upon them : or if persisting in their attacks, have at length been laid prostrate and powerless in the field despite of the superior strength that was relied on for ensuring a very different issue. I will simply refer to a couple of such incidents, where prowess alone carried the day, and also where the odds were vastly in favour of the assailant.

“ In a very rural part of Derbyshire, some ten or eleven years back, a Black-breasted Red Game cock (only a small bird, in weight about four pounds two or three ounces) was ‘ walked ’ with three or four good hens, one of which had some chickens running with her, about a fortnight old. These latter were enjoying themselves in rather an exposed situation to the windward of some heather. A kite (or, as there called, ‘ a gled ’) that was on wing outlooking for the first prey that might offer, espied them ; and without the slightest warning, dashed violently at one of the chicks that had strayed farther from its protector. The hen, however, instantly espied the coming danger, and flew, regardless altogether of self-preservation, to the rescue. This first effort of the dauntless mother certainly saved the chicken, and drew the attention of the kite more especially to herself. At this instant the cock, that was some twenty yards off, attracted by the outcries of his mate, went valiantly to the encounter, and on first meeting his unusual foe was unfortunately clutched by the wing with one or both feet of the kite, nor could the quickly-repeated efforts of the cock disengage itself. Although labouring under so material a disadvantage, he still fought on, and, as the result proved, successfully. It was in truth an up and down fight, sometimes the cock, at others the kite, appearing to have the advantage ; feathers flew around the combatants, and an eye-witness ran rapidly to the spot, in the hope to prevent the escape of the intruder.

No services whatever, on his part, were required, as, before he reached them, victory had favoured our gallant hero. The kite had received a blow from the spur of the cock,—which, it should be borne in mind, was simply the natural one; it had entirely destroyed the right eye, and bursting through the skull at the back of it, penetrated the brain, so that death ensued as instantaneously as by gunshot. It was only with difficulty the spur could be disengaged; and the tenacious grasp of the kite was maintained even in death. The cock proved but triflingly injured by the *mélée*; and the fallen one, after being rudely preserved by some neighbouring taxidermist, still graces a private collection of the fauna of the United Kingdom.

“The second instance was not, as above, a casual occurrence, but premeditated by a couple of friends of mine, not only as a test of the dauntless valour of a Game hen, but to teach a useful and admonitory lesson to an intruder, whose fondness for chickens had added a somewhat extravagant item to the losses of a notorious poultry amateur, and that, too, among chickens of high merit and considerable pecuniary value.

“It seems a large cat had for many weeks been making daily incursions, and had succeeded not only in taking a chicken at every visit, but had likewise very seriously maltreated the old hens on three different occasions. They were Cochins, and had become so alarmed by the frequent repetitions of these inroads as to scarcely make any attempt at protection for their chickens; and consequently the cat had increased in audacity daily. It was under these depressing circumstances that a brother amateur volunteered ‘a certain cure,’ if he were allowed unrestrained liberty as to the means adopted; a proviso most cheerfully permitted. Having cooped up all the chickens, and parent birds also, of the fowls that usually had sole possession of the yard, he produced a most beautiful Game hen and chickens, the latter not more than three or four days old; the hen being armed with a pair of steel spurs, somewhat shorter than those used in the cockpit, but well suited for the purpose intended; and being naturally a spurred hen, they were easily and firmly attached. The lot being placed at freedom in the yard, the hen, from all around being strange, was necessarily restless, and the chickens equally noisy. Grimalkin, with stealthy pace, was soon seen crouching along a wall about nine feet high; the hen unfortunately at this moment had flown into the body of a covered cart, that prevented any possibility of her seeing the threatened danger. A spring from the top of the wall—or rather gliding down it some few feet, and then darting, as it were, from it midway—placed puss in possession of the nearest chicken, and all the spectators thought certainly one youngster was irretrievably forfeited to the experiment; but the idea was erroneous: with a shriek the hen flew headlong at the enemy of her brood. Puss seemed but little concerned at her fury, as the impunity with which she had faced other hens seemed rather to inspire her with confidence, all but amounting to imperturbability.

“Perceiving the coming attack, the cat loosed the chicken from her mouth, but

instantaneously placed one foot upon it, and with hair erect looked defiantly ; while a few deeply-drawn breathings at the window told how anxiously the lookers-on speculated as to the event. The Cochins—poor, heavy, domesticated dames—had always proved slow in their motions, and their efforts were easily avoided. Not so now : a blow the eye could scarcely follow, and a scream most dissimilar to the noise from anything feline, gave evidence the contest was not so very unequal as it appeared to be. Two or three other blows, in the most rapid succession possible, made retreat evidently the only way that remained to the cat of making the best of an unlucky speculation ; still, with an obduracy most remarkable, she once more seized the chicken with her mouth and sprang with it upon the wall. Nevertheless, bravery carried the day,—the hen proved close to her heels, and another double rap brought both antagonists headlong back again to the ground. The cat then loosed the chicken, bolted to another less exposed outlet, and the hen quickly commenced her muster-roll, which embraced the whole of her progeny, and none were injured, the hen herself escaping literally without a scratch ; although her artificial helps were besmeared with gore,—as was the scene of this extraordinary encounter. Some half year afterwards, I heard on inquiry that a longing, lingering look was frequently still indulged in by the aggressor, but always from afar,—and the promise of the owner of the Game hen has been fulfilled : the cure was a certain one.

“ No doubt one cause of Game fowls passing through such really trying ordeals scatheless and unharmed, is the extraordinary elasticity and invulnerability of their plumage as compared with that of other poultry. The more truly the birds are bred the more conspicuously by far will this characteristic show itself. I once saw a singular experiment tried on a feather plucked from the wing of a highly-bred two-year old Game cock, to prove the difference in its repulsiveness, compared to a similar feather taken from a grey dorking's wing, and another from that of a Cochin. Tested by length, they were the same ; in circumference they differed widely. When measured by the tool used by dealers in iron wire, the Cochin was triflingly the thickest of the three ; the dorking feather stood second ; and the Game cock's proved much less than either of the others. They were alternately placed in a vice by the quill-end, each being protected from injury by a pair of hollow ‘clams,’ fitting round it closely to prevent the quill splitting from the unusual pressure, whilst the distance they projected was equal in all cases, causing an equality as to leverage ;—the ribbed or under part of the feather was placed uppermost, and weights applied to them very gradually. Suffice it to say, the resistance in the Game feather, before giving way, was equal to something more than that of the two others combined ! Its elasticity proved nearly equal to that of the same thickness of unannealed iron wire.

“ Hardy as Game fowls are under natural conditions, none seem more impatient of confinement, or less benefit to their owner if deprived of freedom, country air, and exercise ; in such cases they speedily become sickly, and lose most of their

commanding characteristics. But even when this ill-judged treatment is combined with unnatural food, they struggle on protractedly before death relieves them, their constitution being unsurpassed by any fowls.

“With good range, their flesh undoubtedly is excellent, and to my palate the best-flavoured of all fowls. I willingly admit two trifling drawbacks,—viz., limited size, and generally an inclination to prove yellow in the skin. Yet, with these admitted, I still wish any sceptic to try for himself a Game pullet killed shortly before commencing laying her first eggs, and I do not doubt his becoming a convert to my opinion; whilst the carving-knife will prove my best witness, that they carry more flesh than any variety of fowls whatever, under natural and inexpensive feeding.”

The newly-hatched chickens are exceedingly attractive in appearance; those of the darker breeds are light brown, with a broad dark-brown stripe down the back, and a narrower line over the eye. The duckwings, greys, and blues have proportionally paler hues, but the stripe is rarely absent.

The chickens feather rapidly, and with ordinary care and a liberal and varied diet, such as custard, chopped egg, with a portion of onions, chives, or leeks, bread-crumbs, grits, boiled oatmeal, wheat, and barley, with some new milk, in the earlier stages of their growth, are reared with less difficulty than those of other fowls. Nor are they subject to any maladies of chickenhood beyond what is common to poultry generally.

The removal of the combs, ear-lobes, and wattles, of game cocks, or, as it is technically termed, dubbing, is objected to by some persons, being regarded by them as being as senseless a proceeding as docking the tail and ears of a horse. This objection, however, arises from their ignorance of the nature and disposition of these birds. Game and game bantams, if worthy of the name, and if possessing the proverbial combativeness and courage of the race, *will* fight; they are provided naturally with offensive and even deadly weapons, and their combats are in obedience to a law of nature which man can modify to a certain extent, but cannot altogether obviate. The object of these combats, when they occur in a state of nature, is one conducing to the well-being of the race. Into this matter, however, we do not propose to enter at present.

Our object is twofold: to prove the desirability of dubbing the birds, and to describe the manner in which the operation should be performed. Firstly, as to the desirability of dubbing; no one who has ever kept these birds can doubt for a moment the advantage of the plan. Game cocks will fight until one becomes master of the situation. In these combats an undubbed bird is at fearful disadvantage: his comb and gills offer an easy hold to his adversary's beak, and as a cock always strikes where he holds, when once he has seized his foe he has him entirely in his power. Even supposing that the bird is not killed, the loss of blood suffered by an undubbed cock is much greater than that sustained by one that has been trimmed.

Now for the operation;—Cocks should not be dubbed till their combs have

acquired their full size and development, which occurs about the same time that the birds get their perfect male plumage. The bird should be held by an assistant, and as the comb offers a good hold, it should not be taken off until after the wattles are removed. The head being turned over and held by the comb, these should be cut away with a pair of sharp scissors, those which are made of a slightly curved form for trimming the feet of horses being by far the most convenient in use. The cut should commence at the back, and come forward to the front of the head. During the operation, the wattle that is being cut off should not be pulled; if it is, a jagged, irregular cut results. When the two are successively taken off as recommended, two long straight cuts are produced and a narrow strip of skin is left along the centre of the under jaw; this strip it is most important to preserve, for if it be cut away the throat is bared at its under part, and a large portion becomes exposed; this heals over with slowness, and an irregular, uneven surface is the result. Some persons prefer to dissect off the wattles with the points of the scissors in preference to removing them with one cut.

After the removal of the wattles, the bird should be turned over, and the scissors placed at the back of the comb, as close as possible to the head. They should then be closed and the comb cut away with one smooth, steady cut towards the point of the beak. Less than two minutes in skilful hands will finish the operation, and the cock will instantly proceed to eat as if nothing had happened; in fact we have seen birds pick up and devour their own wattles immediately on being placed on the ground. It is neither necessary nor desirable to make any application to the wounds made by the operation of dubbing.

When the scars, left by the removal of the wattles, have fallen off, the deaf ears, or ear-lobes, should be taken off; this should also be done with a single clean cut of the sharp scissors, great care being taken to include as much of the ear-lobe as possible, without injuring the orifice of the ears. If these operations have been skilfully performed, there will be but little trimming required afterwards, and as soon as the wounds are healed, the elegant snake-like head and neck of the animal are shown in their full beauty.

A treatise on Game fowls could hardly be regarded as complete without some allusion to the practices which have rendered this breed so truly celebrated. Cock-fighting has been an institution that has been viewed with favour by a very large portion of the human race from time immemorial. At the present period its practice in Great Britain is illegal; although on what ground other and far crueller sports should be allowed and positively encouraged by all ranks from the prince to the peasant, and this suppressed, it would puzzle a casuist to explain.

In all animals that associate together in flocks or herds, consisting of one male and several females, the males are provided with horns, spurs, or some other deadly weapons, by which the strongest male destroys or drives away the weaker, and so perpetuates the most vigorous and perfect race. These animals are all endowed with a great amount of combativeness and courage, and fight, whenever





LICHTON, BROTHERS.

DUCK WINGED QUAIL.

they come in contact with one another, with an instinct implanted in them by a higher than human intelligence.

It is frequently alleged against cock-fighters that they supplant the natural spurs by others of steel or silver. It should be remembered, however, that these, being more efficacious even than the natural weapons, render the combats only less prolonged. To any one who will view the question apart from prejudice, or the maudlin sentimentality that is current at the present time, it must be obvious that a far greater amount of cruelty is evidenced in the setting a pack of hounds to pursue a fox for hours together, till the wretched animal sinks exhausted, and is, whilst still living, torn limb from limb—we beg pardon, “broken up” is the delicate expression by which this dismemberment is described. But, say the advocates of the chase, that sport is redeemed by the manly courage exercised by the hare and foxhunter; as though his risking his own neck could lessen one iota the suffering of the animal he is pursuing.

Cocks fight willingly; the hunted hare, the fox, the deer, the salmon struggling for hours on the hook, the vermin pining for days in a steel trap in order that the animals he naturally preys upon may be reared for sport, are all the unwilling victims of the superior force or intellect of man. Doubtless, however, such views as we have expressed will be, with many persons, unpopular at the present day—each individual, as Butler writes, compounds for cruelties

“ He is inclined to,
By damning those he has no mind to.”

Reminding one of the lines of Somerville, the author of the poem of “The Chase,” who, being an advocate for hunting hares with harriers, writes:—

“ Nor the timorous hare
O'ermatch'd destroy, but leave that vile offence
To the mean, murd'rous, *coursing* crew, intent
On blood and spoil. O blast their hopes, just Heaven!
And all their painful drudgeries repay
With disappointment and severe remorse.”

THE CHASE, Book I.

Let us not be misunderstood, we are not advocating the practice of cock-fighting, but merely denouncing the inconsistency of those who indulge in other sports attended with a far greater amount of suffering, and who regard themselves as severely virtuous because they denounce this one. We never fought a cock, or bred one for fighting; that we have witnessed cock-fights we do not deny, and as our readers may like to read a description of a combat, we reproduce the following account of one witnessed by ourselves some few years since:—

“ * * * * * Young Green burst into the room. ‘Tegg, my boy,’ said he, ‘come along, here’s the chance you have been waiting for so long.’ Ewart, who has been up at the Poultry Show, says he has never seen a cock-fight, so Tait and two or three others, who have got some cocks left over from the main they fought on Tuesday, are going to show him what a cock-fight really is.’

“I need not tell you I did not wait for a second invitation, as you know I am one of those fellows who like to add to my small stock of knowledge by seeing everything: so I jumped up, and in a minute or two found myself in a back room over Holecomb’s shop, in the High-street.

“On going in, I found about twenty fellows there, all of the right sort; I was not a little surprised to see the Mayor amongst them. He nodded to me, and said, ‘This is Nova Scotia, I believe, Mr. Tegg;’ and seeing that I did not instantly catch his meaning, he added, ‘Such things, you know, are not allowed in England.’

“I afterwards heard that, though the head magistrate of the place, he was known to be very partial to cock-fighting; and that he was once present at a main when the police burst in, and being too fat and pudgy to slope off with the rest, he got into the large chimney, standing with one foot on each hob of the grate. The police saw and knew the boots, but of course they did not look up the chimney, as they could have no suspicion that his worship’s legs were in them.

“In the middle of Holecomb’s room was unrolled a piece of matting; and all the visitors stood round in a large ring, which was cleared for the setters and the birds.

“On some pegs were hung ten or a dozen white canvas bags, with the bottoms filled with straw, each holding a cock ready trimmed and heeled.

“It was a strange sight to me to see the ‘setter,’ Old Sam, take out one of his trimmed birds: it was a splendid red cock with a black breast; the feathers around his throat were cut close, so that as he reached his serpent-like neck out of the bag it looked as fierce as that of a rattle-snake: his hard and horny beak was thick and massive at the roots; and his eye large, fiery, and expressive of savage courage. His wing-feathers were trimmed to less than half their length, and his tail docked, so as to be of a triangular shape, like that of a nick-tailed horse. The spurs natural to his firm, bony shanks had been cut short, and their places supplied by steel heels nearly two inches in length; each of these had a ring to go over the bottom of the natural spur, and was fastened to a piece of leather which was neatly but firmly secured to the leg by a waxed thread, so artistically tied as not to impede the free motion of the limb.

“The other ‘setter,’ young Gillingham, pulled out a red and white bird, which they called a ‘pile;’ this had been treated in the same manner, and was equally closely trimmed and heeled. As soon as the birds saw each other both uttered a chuckle of defiance, when, holding them near, the ‘setters’ permitted them to strike at each other with their beaks. The object of the trimming was evident, it being to prevent the opposing bird getting a ready hold of his opponent by the feathers.

“After stimulating their courage by these means, the “setters” stooped down and placed the birds on the floor opposite each other. They rushed forward, and for a few moments stood with their beaks close touching, raising their heads together, each one trying to get the advantage of the first cut. In an instant they

sprang together high up in the air, and for a moment nothing was to be seen but a confused mass of legs, wings, and feathers.

“As they rebounded from the force of the blow the result of the struggle was evident. Gillingham’s bird had been hit; the spur of the red cock had gone through the neck. ‘He’s throated,’ cried out young Green; ‘two to one on the black-red.’

“The ‘setters’ caught up their birds in an instant, and smoothing their ruffled plumage, again placed them on the mat. But the contrast was striking. Old Sam’s bird looked fiercer than ever, and was hard to hold. But Gillingham’s ‘pile’ stood unsteady, and though he rushed forward with the courage of desperation, the red cock sprang above him, and the steel heels were buried up to their hilts in the body of his prostrate foe.

“The second fight was over in a few seconds; at the first fly the victor drove his spur through the centre of the back into the heart of his opponent, whose head sank, blood poured in a stream from his mouth, and he fell forward and died without a struggle.

“The third was a different sort of thing every way. Old Sam’s bird was a strong beautiful duckwing, Gillingham’s a Birchen grey. The advantage, at first, was altogether with the duckwing, which was a stronger bird, and longer in the reach of the neck, but the Birchen was of the highest courage, and fought without flinching; at last, when nearly overpowered, he struck the duckwing in the head, and the blow deprived his opponent of sight, either wholly or partially.

“It was a cruel sight to see these noble birds, the stronger blinded, but still trying to seize his adversary with his beak and hold him, whilst he struck him down with his spurs; the weaker, with his life ebbing rapidly away, but still fighting to the death against his blinded foe. At last the duckwing caught him by the throat, and leaping into the air above, brought down the spurs with a stroke that no living bird could have withstood.

“At this moment there was heard a loud and angry discussion, followed by a hurried knocking at the door of the room. Instantly a vision of the court-house rose up to my mind, with a certain hard-featured clerical magistrate on the bench, and your friend Tegg and one or two others in the dock. This vision rapidly progressed, and a homily on the brutality of such sports, and the folly of fining men of wealth and position, was imagined by my fertile brain, the whole concluding with an idea of a sentence of two months at the county gaol, in grey fustian, and with hair dressed after the most approved Newgate cut. My imagination must have been very rapid, for in an instant the knocking was repeated, still louder than before. As I looked round, I could not help laughing at the blank visages of the gentlemen present. Old Sam, however, seemed to take it easy, but that was not to be wondered at: he knew what it was, as he was once in trouble about a bull-bait which took place at three o’clock one fine July morning on the Lancashire moors.

“‘Try the window,’ said Tom Green. ‘It’s too high,’ said the pudgy Mayor; ‘besides, there’s certain to be some of them in the yard.’—‘Open the door,’ called

out a stentorian voice outside. 'Why, it's only Jack Brown,' said Green, when there was a general laugh, and, the door being unlocked, in rushed Brown. In consequence of the alarm, the duckwing cock was left standing by the body of his fallen foe. Brown looked at it, and, in a voice of anguish, cried out, 'You don't mean to say that you've been and fought him? Why, it's Tom Challenger's cock, and I shall have to pay five pounds for him.'

"And so, sure enough, it was. Brown, it appeared, meant to exhibit at the poultry show a pen of duckwing game, and not thinking his own bird good enough to win, he wrote to Challenger, who has some of the best blood in England, for a bird. One was sent on approval, to be charged five pounds if he was kept. When Jack Brown got him, he liked his own better, as matching the hens; so left Challenger's in his yard. Not knowing of this substitution, the getters-up of the fight had sent for Brown's bird and got Challenger's. So Jack has got to pay the money for him; and now he's so knocked about that he's not worth a crown. Everybody laughed when he heard this explanation except Jack, who said he should not have minded so much if he'd been present, as he should have backed Challenger's cock for a 'fiver.' Of the two other battles, Gillingham's side won the first; but in the last fight, his bird, after receiving a good deal of punishment, turned tail and lost the main.

"I dare say you will tell me that I ought to be ashamed of myself for going to such a demoralizing and brutalizing spectacle; but I think that there is something to be said for everything in this world, even for cock-fighting.

"On the general principle of common sense, let me ask you, who are in the habit of eating veal that is half an hour in the process of slow killing, and of enjoying your hunted hare that has for fifty minutes been in an agony of mortal fear, until at last, exhausted and shrieking, with every fibre in its body quivering with intense excitement, and every air-cell in its lungs filled with blood and lymph, it sinks and receives a death-bite from hounds more merciful than their masters,—are you, I ask, the man to rail against allowing two gallant and noble animals to follow an impulse that has been implanted in them for a wise purpose, that you are too short-sighted or wilfully obtuse to see? The natural instinct of gregarious animals is to fight, so that the stronger males should destroy the weaker and perpetuate the noblest race; all, consequently, are provided (by Nature—ay, there's the rub) with lethal weapons for this purpose.

"As I once heard asked, suppose you were to inquire of a game-cock, whether he would rather have his cervical vertebrae dislocated by the hand of Betty the poultry maid, or take his chance of life in mortal combat with his gallant antagonist in the next farm-yard, can you doubt his answer?"

Being anxious that THE POULTRY BOOK should be deficient in no subjects connected with fowls, we applied to an experienced feeder for the pit for some information as to the mode in which the birds were fed to the high degree of condition that is necessary to their success in these combats. His reply is that

rules for training for the cock-pit cannot be written, as so much depends on the judgment of the feeders, some of whom prefer shutting up the birds without food for some time, until they are hungry, then giving a mild dose of physic, such as a spoonful of coarse sugar, to reduce their weight, which others do by sparring with the spurs guarded by muffs. The birds ought not to be kept up more than a week or eight days ; during this time they should be fed as early as five o'clock in the morning, again slightly at mid-day, and lastly at five in the evening. Most feeders employ bread made of wheaten meal and eggs ; others of the old school prefer the best old barley, and hard-boiled egg chopped fine. During the feeding the pens must be kept scrupulously clean, the head of the bird sponged every morning with tepid water with a little white vinegar in it, and the feet daily cleaned with soap and hot water. The exact time to bring a bird to his highest condition and his best fighting weight are points that require long experience to determine, and cannot be imparted by any other means.

CHAPTER XIII.

PENCILLED HAMBURGHS.

IN approaching the consideration of those varieties of poultry now known as Hamburgs, we are entering upon a subject that has given rise to warmer controversy than almost any other within the whole range of poultry literature. At the present time, at the great majority of poultry exhibitions, classes are arranged and prizes offered for five varieties included under the general name of Hamburgs, namely, Gold and Silver pencilled Hamburgs, Gold and Silver spangled Hamburgs, and Black Hamburgs. Erroneous as this nomenclature undoubtedly is, its general recognition is an established fact: it is employed at nine-tenths of our poultry shows, and understood by the great body of exhibitors and breeders. Such being the case, we are afraid that any attempt at alteration would be injurious in the extreme, and attended by almost inextricable confusion.

The correctness of such a system of nomenclature is entirely another question. There is no doubt but that these fowls had originally no title whatever to the name of Hamburgs, which was in the first instance given to them by some gentlemen connected with the early Birmingham shows. It is true that the pencilled birds formerly were, and still are, imported in considerable numbers from Holland, under the name of Pencilled Dutch, and Dutch Every-day Layers; but the spangled birds appear to be exclusively English fowls, and are essentially distinct varieties, differing in size, plumage, and in the formation of the skull, and lastly, the name of Hamburg had previously been applied to one of the varieties of feather-crested fowl, now, with an equal absence of geographical correctness, known as Pelish. A more unfortunate selection of a name could scarcely have been made; but having come into general use, it would only render "confusion worse confounded" to attempt to introduce any fresh alteration; and of the old names which were superseded, it is not too much to say that the majority of them were equally objectionable to those in present use.

The only alteration which could be made without extreme confusion, would be that suggested some time since by a writer in the *Field* newspaper, namely, to substitute the term "fowls," for that of "Hamburgs," when the varieties would be classified as the Gold and Silver pencilled fowls, and Gold and Silver spangled fowls. This would do away at once with the very objectionable and absurd name of Hamburg, the no less erroneous one of Pheasant fowls, and a whole host of ill-understood provincialisms that are merely of local employment. But unfortunately there are serious objections to this proposal: in the first place, two very distinct breeds, namely, the Lancashire Mooneys and the Yorkshire Pheasant fowls are included





LEIGHTON, BROK.

GOLDEN-PENCILED HAMBURGERS.

under the name of Spangled Hamburghs, and the suggested alteration would leave the Black Hamburghs without a name, as they could scarcely be termed Black fowls.

The Pencilled and Spangled birds, although frequently described together, are so essentially different in characters that their consideration will be greatly facilitated by regarding each as a distinct variety, and devoting to them separate chapters.

The Silver-pencilled birds may first claim our attention. It deserves our notice that tradition, our oldest naturalists, and even the names by which our fowls were originally called, all assign to them an Eastern origin; even many of our modern names,—Bantam, Malay, Cochin, Chittagong, and Brahmapoutra,—point to a similar origin: nor is the fowl now under our consideration an exception, for its earliest describer, Aldrovandus, calls it the *Gallina Turcica*, or Turkish fowl. The white body, the black markings, the greenish-black tail, and the blue-tinged legs, are all characters which show that the old naturalist had before him specimens of the Silver-pencilled Hamburg. Perhaps no variety of fowl ever rejoiced in more synonyms than this very pretty, and, in suitable situations, profitable breed; they have been long termed *Bolton Grays*, from being extensively and successfully cultivated in and about Bolton, in Lancashire; *Creoles*, from the intermixture of the black and white in their plumage; *Creels*, which is only a provincial mode of pronouncing Creoles; *Corals*, because the numerous points of their polished, bright scarlet rose combs bear no distant resemblance to red coral; *Pencilled Dutch*, because many are imported from Holland; *Dutch Every-day Layers* and *Everlastings*, for the same reason, and their great productiveness as layers; and *Chitteprats*, the derivation of which is not so obvious. Chitface, according to Bailey the lexicographer, means a meagre child; and *Chitteprat*, if intended to describe a diminutive hen, would not be misapplied to one of this variety.

The general characters of Pencilled Hamburghs may be thus stated:—They are birds of small size, compact and neat in form, sprightly and cheerful in carriage. In the plumage on the body of the hens, each feather (with the exception of those of the neck-hackle, which should be perfectly free from dark marks), is pencilled with several transverse bars of black on a clear ground, which is white in the silver, and a rich bay in the golden birds. These pencillings have given rise to the name of the variety. In the cocks, however, there is a general absence of these markings, the birds being either white or bay. In both sexes the legs are blue, with fine bone. The comb is a rose, square in front and well-peaked behind; the ear-lobe a well-defined white; the face scarlet. For a detailed account of their characteristics we are indebted to Mr. B. P. Brent, a gentleman whose diligent researches into the history of many of the varieties of poultry entitle him to the thanks of all interested in the subject, and who has been known as a successful rearer of this breed for many years; although it is but fair to state that he repudiates most strongly the introduction of the term “Hamburg,” and regards their proper title as that of Pencilled Grays or Bays, or Pencilled Dutch Every-day Layers.

The characteristics of the Silver-pencilled, as here given, are strictly in accordance with those laid down in the "Standard of Excellence."

In weight and size Silver-pencilled Hamburgs are considerably below the general standard: the carriage of the cock is very erect; the tail is well borne up, and the head occasionally thrown back so far that the neck often touches the tail; the general form is exceedingly neat and elegant. In the hen the carriage is sprightly and active, but not so impudent as that of the cock; both sexes are alike noisy and restless in their habits, neat and very pretty in their form. The neck-hackle in both sexes should be pure white; pencilling with black, a very frequent fault in the hackle of the hens, being very objectionable. The saddle of the cock must be pure mealy white. The cock's tail is black, the sickle and side sickle-feathers being glossed with green, and having a narrow white edging. In the hens the tail must be distinctly barred or pencilled with black.

The breast and thighs of the cock are white, as are the upper wing-coverts or shoulder, but the lower wing-coverts are marked with black on the inner web, showing a line of dots across the wing, forming a bar. The secondary quills, or those flight-feathers which are alone visible when the wing is closed, are white on the outer web and blackish on the inner web, and have a rich green-glossed black spot at the end of each feather. In the hens the entire plumage of the body, namely, that of the breast, back, wings, and thighs, should have each feather distinctly pencilled or marked across with transverse bars of black; the more defined these are, the better, as there should be a perfect freedom from a mossy appearance, which is caused by the two colours running into one another. The legs and feet in both sexes should be of a clear leaden or slaty blue. The comb in the cock is evenly set on the head, square in front, well sprigged above with small even points, not hollowed on the upper surface, and terminating in a single flattened pike behind, which inclines slightly upwards. In the hen the comb is the same in form but very much smaller. The ear-lobe in both sexes must be a dead opaque white, free from red on the edge.

Mr. Brent also states, "By all means avoid the chestnut patch which is too frequently seen on the wing of the Silver-pencilled cock, who should have a sufficient depth of colour in the markings of the wings, and in the gray down at the roots of the feathers, or he will not breed darkly-marked hens; for although the sickle feathers of a Golden cock may be bronzed all over without fear of spoiling him as a breeding bird, such an amount of silver on a Silver cock's tail would, in the majority of cases, cause him to throw light hens. The tail of a Silver-pencilled pullet should be neatly barred in her first full-sized plumage; but they generally become waved or grizzled after the second or third moult."

The same description applies generally to the characters of the Golden-pencilled birds, substituting the rich deep reddish bay as the ground-colour for the clear white silvery ground that characterises the Silver birds. As, however, there is a slight difference in the marking of the sickle feathers and tail coverts, we quote the following from the "Standard:" The sickle feathers of the cock, according to

this high authority, should be of a rich black down the middle of the feather, the entire length edged with bronze, each bronze edge as near one fourth the width of the feather as possible; the more distinct the two colours and free from running into each other the better; and the entire plumage of the Golden-pencilled hens, with the exception of the neck-hackle, which is pure golden bay, must have a deep golden bay ground, free from either lacing or mousing; each feather, including tail feathers, being distinctly pencilled across with rich black; the pencilling not to follow the outline of the feather, but to go straight across on each side of the shaft. The two colours distinct, well defined, and not shading or running into each other.

Mr. Brent remarks, "As a Golden cock will breed good hens with much less depth of under-colour than the Silvers, the argument in favour of their having bars on the wings and black inner webs to the quill feathers is not so imperative; and the sickle feathers of the Golden cock may be bronzed all over without so much lessening his value as a stock bird."

"It is my opinion," continues this writer, "that the inner tail feathers of both Golden and Silver pencilled cocks should be a deep unspotted black; that the tail-coverts, or, as they are commonly called, the sickle-feathers, should be of a deep glossy black, with green and purple reflections, and finely edged or laced in the Golden with coppery brown or bronze, and in the Silver with greyish white. I am aware that this opinion is adverse to that of some of our judges and exhibitors, and that they consider a wholly bronzed or silvered tail of much importance; but such theory is not borne out by the experience of the practical breeder. Numbers of instances might be quoted to show the fallacy of the bronzy tails. How often is it noticeable in the show-pens that the cocks with the most silvered or bronzed tails are matched with the worst-marked hens. At a late show I noticed two pens of magnificently marked Silver hens, better than which I never remember seeing, with a card above them which informed the public that the hens only were sold, but the cocks were not purchased; nor were the pens noticed by the judges. Why? because they had black tails. The sickle feathers were only edged, as I contend they ought to be; and, moreover, they had the bars on the wings, so difficult a point to be obtained in this breed. By bars I do not mean a double row of moons or spots, like those of the Pheasant-fowl, or so-called Spangled Hamburgh, but simply an irregular narrow black line across the wing, formed by small spots on the end of the first row of the wing-covert feathers. These covert feathers should be marked with black on the inner web, which is hidden from view, the outer being clear, either red in the Golden or whitish in the Silver, with a narrow black spot at the point, which forms the bars.

"My reason for advocating the dark tail and bars on the wings is the necessity of a certain depth of under-colour in the cock; for as the male parent influences the plumage of the female offspring, so, if the cock has not a sufficiently dark under-colour, he cannot, as a rule, produce dark, well-marked pullets; and it is therefore necessary that the cock should have a dark tail, and that the inner webs of the

secondary wing feathers should be black, and the inner web of the lower covert feathers should be barred with black. These I consider as the outward signs of a Pencilled cock being likely to produce good, well-marked hens. I do not pretend that it is an infallible rule—exceptions may occur; nevertheless, my experience shows that a cock with good depth of under-colour will, as a general rule produce much handsomer pullets, and in much greater abundance, than a light one with a light silver tail or white pinion feathers—a point which is too often disregarded by our judges and breeders of this truly beautiful and useful variety.”

With regard to the effects of crossing the two Pencilled varieties, Mr. Brent states,—“A Golden-pencilled cock coupled with a Silver-pencilled hen, I have always noticed to produce Golden-pencilled pullets, and Silver cockerels with a chestnut wing patch.”

Pencilled Hamburgs of both varieties are scarcely to be surpassed in beauty by any of the other denizens of the poultry yard: the slight compact form of the hens; their sprightly, active, cheerful carriage; and the contrast of their ample scarlet combs and well-defined white ear-lobes, with their neatly barred plumage, render them exceedingly ornamental. Nor are they behind in profitable characteristics; for being of roving habits, they range well, and provide themselves with a considerable portion of food; in fact, in many situations, their powers of flight are so much exercised as to lead them to be an annoyance to neighbouring residents. But this, again, is not without its own special utility, for it renders their abstraction by any pilfering thief an act of very considerable difficulty; and if disturbed at night, they commence and continue such an outcry as can scarcely fail in arousing the sleeping vigilance of their owner.

As layers, Pencilled Hamburgs, as may be judged from their synonym of Dutch Everlasting Layers, rank very high, although, as may be imagined from the size of the hens, the eggs are rather small. They are non-sitters; not one in many hundred ever indicating the slightest desire to hatch. For the following excellent *résumé* of their economical merits, we are again under obligations to Mr. Edward Hewitt, who states:—“The Hamburgs are excellent layers, provided they have free liberty on an unrestricted grass-run; they are most impatient of confinement, particularly the Pencilled varieties, and very susceptible of disease wherever overpopulation and limited space are unfortunately combined. They shift for themselves better than any, excepting the Game, and are not, therefore, expensive as to keeping; indeed, I believe (in comparison to the food consumed) none produce so large an amount of eggs, taking the whole year from end to end, whether we estimate by weight in the aggregate, or by numbers; their chief production, however, is during the milder months. The flesh of Hamburgs is very superior; and they are always, as chickens, in fit condition for the spit, if only tolerably well fed, without any additional preparation. Being a small-boned fowl, they proved, when carved, to be much more fleshy than might be imagined at first-sight.

“They generally roost high, and in places difficult of access, if any possible chance of so doing presents itself; combined with this, if disturbed during night-

time, they never cease screaming violently until destroyed outright; hence, I have known many instances where midnight prowlers after hen-roosts have been at once detected, or luckily prevented absconding with their booty, the reiterated cries of alarm from their victims calling forth the immediate aid of the proprietor. In case, too, of attack from vermin, their agility generally preserves them from injury; for on such occasions they will fly like pheasants, and readily take to trees or the highest buildings. For these simple reasons, it is very rarely any of these fowls are absent without leave.

“I have, during my somewhat lengthened experience in poultry matters, met with a few isolated instances in which Hamburgs have incubated their own nest of eggs steadily, and afterwards manifested the most exemplary attention to their chickens. But such cases are very few, and quite opposed to general rule: it is also invariable, so far as my knowledge extends, that the nests of such hens have been stolen in some secret out-of-the-way place, and the numbers of eggs previously laid have held out unusual inducements to incubation. On one occasion, more particularly, I well recollect a Golden-pencilled Hamburg hen who laid away under the floor of a barn, to which, unknown to the owner, she had obtained a private mode of access: she laid all her eggs on the dry, somewhat chaffy ground, a hollow being made previously by her own exertions. Here, quite secluded from observation or even daylight, she hatched eighteen chickens, and brought them out herself; and after-inspection by the owner proved that all the eggs had produced chickens, as the shells remaining tallied with the number of chickens produced. The hen succeeded in rearing sixteen of these youngsters. I also knew another case, in which from sixteen eggs laid away behind some old refuse timber, fourteen chickens were hatched, whilst the remaining two contained fully-formed chickens; the exact number that were eventually reared I do not know, but am certain it proved the greater proportion. A circumstance connected with these instances of Hamburgs hatching their own young, though a digression, I consider well worthy of notice; viz., in both cases referred to, the proprietors of the fowls mentioned had placed many sets of other eggs from the same hens under strange foster-mothers, a large proportion of which were unproductive, whilst the eggs in the stolen nests were all fruitful. I will not myself attempt to assign a cause for this marked difference in their fertility, but simply confine myself to the narration of the fact. In both instances these fowls were harassed by a continual and rigid daily search for eggs produced, and thus fretted, concealed their nests, most probably, simply to avoid molestation. I myself never yet knew any case whatever where a thoroughly well-bred Hamburg hen commenced sitting openly. They will sometimes appear dull and broody for a day or two under such circumstances; but the effort seems quite unnatural, and speedily passes away. It is but right to add, in the two first instances I have mentioned of successful rearing, both parents were perfectly well-bred; and the offspring, thus strangely procured, afterwards took numerous first prizes at different poultry exhibitions.

“All the Hamburgs are somewhat prone to faulty combs, from either being

hollow in their centre, or, what is a still more fatal disqualification for exhibition, the combs lop over, or fall to one side or other: this should be most especially avoided in selecting for the purposes of competition. Humpbacked Hamburgs are also by no means uncommon; but whether for exhibition or for brood stock, they should never be retained, as such malformations are not only inadmissible for premiums, but also because this failing oftentimes proves hereditary for very many generations. The Hamburgs are extremely ornamental varieties of poultry, and form very striking additions when standing in groups near any homestead; this, combined with their extraordinary production of eggs, the excellent quality of the flesh, together with the very small amount of general care they entail, causes them to be almost universal favourites. They are, however, somewhat troublesome and untiring pests when they happen to indulge in encroachments upon garden grounds, scarcely any natural fence being impervious to them; and even continuous ejections will not frustrate their determination to persist in such encroachments. Still, all matters duly considered as to production and maintenance, I myself know no kind of fowls that will pay better than they do."

There is one drawback to the value of both Gold and Silver Pencilled Hamburgs, and that, it must be acknowledged, is a serious one. If hatched in the early spring of the year, say before May, they are difficult to rear, being very delicate during chickenhood, and suffering severely in cold wet weather; and the old birds are perhaps more subject to roup, if kept in damp, cold, unhealthy situations, than any variety of fowl, except, perhaps, Black Polish. Dryness in the poultry-yard, a sheltered run and good feeding, are the best preventives of this scourge of the poultry breeder. For the treatment, when it has unfortunately gained entrance into the stock, we must refer to the general chapter treating on Poultry Diseases.

But it cannot be too strongly impressed on all poultry keepers that roup always commences with cold in the head; a discharge takes place from the nostrils, the fowl affected shakes its head and throws off the discharge as long as it remains of a watery character; when it becomes more glutenous and adhesive, the bird wipes it off on the feathers at the base of the wing, which in time become matted with the diseased secretion; in a still more advanced stage the external openings of the nostrils close, and the fowl breathes with difficulty, each expiration being accompanied with a distension of the skin of the throat and under jaw. As the secretion can no longer be got off through the nostrils, it is forced by the pressure of the air expired, in breathing, through the lachrymal duct into the eye, and causes the frothy appearance of that organ unfortunately too well known to most poultry keepers. As the disease progresses the discharge accumulates in the nasal cavities, the face consequently swells, the bird becomes blind, and the diseased secretion particularly offensive.

In the earlier stages, when roup is merely a simple cold, the disease can be cured by warm housing, and stimulating strengthening food,—peppered potatoes, cayenne, a little bread sopped in ale, etc.; but in the later stages it is one of the

most intractable diseases; from the peculiar structure of the nostrils in the fowl it is almost impossible to apply any lotion to the diseased surface, and outward applications to the face are obviously useless. In our own yards we at once sacrifice any roup chicken and bury them out of sight; roup, in fact, should be treated by prevention; like the cattle plague, it is much better to stamp it out than to trifle with it. If fowls are reared from healthy stock, not overcrowded, have a good range, are well fed, and have dry clean wholesome roosting houses, roup will not trouble the poultry breeder; when it does occur he had much better look to the sanitary conditions of his poultry yard than endeavour to save the lives of a few sickly chickens that will never be worth the pains bestowed upon them.

CHAPTER XIV.

SPANGLED HAMBURGHS.

THE same warm discussions which have arisen respecting the nomenclature of the birds described in the last chapter, have, even with increased intensity, prevailed respecting the varieties at present under consideration.

Of their origin, it may be stated that little or nothing is known ; and their history is simply this, that, under the names of Gold, Silver, and Black Pheasant fowls, Gold and Silver Mooneys, and Red Caps, they have been long and assiduously cultivated by the north of England breeders. For long periods of time have Pheasant-fowl clubs existed in several of the northern towns, where single hens were exhibited for competition, the prizes being frequently such homely articles as copper tea-kettles, coal-scuttles, rocking-chairs, and other equally useful implements of household utility. To the name of Hamburg they have, as stated in our last chapter, not the slightest claim, it having been given to them at Birmingham, because of their fancied resemblance to the Pencilled Dutch. Still, as before stated, the name of Spangled Hamburgs has been generally received and understood ; and therefore, erroneous as it doubtless is, we avoid a greater confusion by retaining it.

Although all Spangled Hamburgs have certain general characters in common, such as spangled or mooned plumage, rose or double combs, and blue legs, nevertheless there are great differences in the different varieties, and there can be no doubt that several very distinct breeds, known as Gold and Silver Mooneys, and Gold and Silver Pheasant fowls, have been included under this title. These, as far as we are aware, have never been accurately described, nor, in fact, has their description been even attempted by any one practically acquainted with the distinctions between them, and the results obtained by crossing the different varieties.

One great reason why Spangled Hamburgs have not been as generally cultivated in the south of England as in the north has doubtless been this ignorance respecting them. The caprice of the judges, or the custom of the time, has called for pens containing, not pure bred birds, but those consisting of Mooney hens and half-bred Pheasant cocks. The winning pens have been purchased by persons ignorant of this fact, and the purchasers have been disgusted with Spangled Hamburgs in consequence of their not being able to cull a single pen of show birds from ever so large a number of chickens reared from their purchased stock.

Under these circumstances, we have the greatest pleasure in being able to place before our readers the following most valuable article on the different breeds

of Spangled Hamburgs, from the pen of the very highest authority on the subject, Mr. Richard Teebay, of Fullwood, Preston, and, by his kindness, we are enabled to illustrate it by original drawings of the feathers of all the different varieties.

“The fowls included under the name of Golden-spangled Hamburgs are of two very distinct breeds. One variety has been bred and exhibited for a long series of years by the colliers, hand-loom weavers, and others in Lancashire. These men have long had their clubs and held their annual exhibitions, prizes being offered for pairs of hens and pairs of pullets, as well as for single hens and single pullets. These prizes were awarded in accordance with rules and points very similar to those laid down in the ‘Standard of Excellence’ issued by the Poultry Club. The local name of this variety is that of Golden Mooneys, from the rich iridescent green-black spangles, on the end of the feathers, the ground-colour being a beautiful clear golden bay.

“The other variety was formerly bred in Yorkshire, the fowls being known by the local name of Golden Pheasants, from the similarity of their markings to those on the breast of the cock pheasant.

“Golden Mooneys, which I will first describe, are rather small birds, with neat heads, tight rose combs, small deaf-ears which are not pendant but quite close to the face, and which are very seldom pure white. The plumage of the mooney hens is exceedingly close and glossy, the ground-colour being a rich clear golden bay, each of the body feathers having a large round rich green-black moon or spangle on the end (Fig. 1); the neck should be striped with rich green-black; the tail feathers black; the forepart of the breast of the cock is often rich green-black, but lower down and on the sides the ground is beautifully clear golden bay, with very large distinct round rich moons, without the least mossaing or lacing.

“The spangles on the true Golden Mooneys are large, round, very black, with beautiful green reflections; but they have often the fault of showing a little white on the end of the feather beyond the moon.

“Golden-pheasant fowls are heavier birds than the Golden Mooneys, with larger and looser rose combs, and large pendant deaf-ears, which are generally pure white; their plumage is not so close and glossy as that of the mooneys. The bay ground-colour is often slightly mossaed with brown; the black spangles on the end of the body feathers are crescentic, and not circular (Fig. 2); the neck is striped with black; tail feathers black; on the breast of the cock the black spots on the ends of the feathers generally run up the edges, somewhat like a bad, ill-defined lacing, and give the breast a very streaky appearance. The Yorkshire Golden-pheasant hens are seldom seen at shows, but they are better layers, hardier fowls, and much easier to rear than the true Golden Mooneys.

“Golden-mooney hens are very seldom seen exhibited with true-bred mooney cocks, as the latter are small, and it is rarely they have the whole surface of the deaf-ears white in colour; and as a little red on the margin of the deaf-ear appears to be looked upon as a disqualification by some judges, however good the bird may be in other respects (this has been particularly noticeable at one of our largest

poultry shows, the deaf-ear of the cock appearing to be the only point taken into consideration), it is now rare to see a true-bred mooney cock exhibited, but cross-bred cocks, betwixt the Yorkshire Golden-pheasant and the Golden Mooney, take the place of the true mooney cock in the pen with Golden-mooney hens, merely because the cross-bred bird generally has a large pure white deaf-ear; yet the hens bred from the cross are quite worthless as exhibition birds, there seldom being two alike in depth of ground-colour; the marking is always patchy, generally dark and much laced on the breast, and only very faintly marked on the lower part of the back, very few having a good round spangle on any part whatever, and many are very much mossed and brown near the tail. Crossing the two breeds without spoiling the beauty of marking seen in the true mooney is quite impossible.

“Golden-pheasants occasionally produce hen-feathered cocks, in which the saddle feathers are exactly like those on the hen’s back (Fig. 8), only the moons are larger. The tail of the hen-feathered cock is similar to, but larger than, that of the hen, the two first tail feathers being only about one inch longer than the others, and very slightly curved. There are no sickle feathers, the side-tail feathers being as straight as in the hen; all the tail feathers are beautifully mooned. These birds are often used to breed from, and are quite as prolific as full-tailed cocks. Golden-mooneys do not produce hen-feathered cocks.

“In the Silver-spangled Hamburgs, as in the Golden, two different varieties are included. The Lancashire Silver Mooneys, which were bred and exhibited in Lancashire by the old clubs, and the Yorkshire Silver-pheasant fowls.

“The Silver-mooney hens are much larger than the Silver-pheasant hens, yet the Silver-mooney cocks are smaller and shorter in the legs than the Silver-pheasant cocks.

“The Silver Mooneys, like the Golden-pheasants, often breed perfectly hen-feathered cocks, with the whole plumage as beautifully and regularly mooned as the hens. This never occurs in the true Silver-pheasant breed.

“Silver Mooneys have rather large coarse heads, rose combs, dark faces, very close small deaf-ears, which are rarely pure white, but generally, in the hens, of a sort of leaden colour. The plumage of the hens is hard and close, ground-colour a beautiful silvery white, with a very large, round, rich green-black moons or spangles on the end of each of the body feathers. The hackle of the cock is silvery-white, and free from yellow shade; the ends of the longest feathers are tipped with rich black; the neck of the hen is silver striped with rich green-black, the moons on the greater and lesser wing coverts of both sexes forming two distinct rich black bars across the wing. The tail of the hen is silver on the outside, the feathers terminating with very large rich black moons; the inside of the tail much darker than the outside. The tail in the cock is almost entirely black.

“The Yorkshire Silver-pheasants have neat heads, and rose combs, with large deaf-ears which are often pure white. The plumage has pure white ground, with a black spangle on the end of each of the body feathers; the spangles are smaller, not so rich in colour, and seldom so round as in the mooney; the hackle of the





LEIGHTON, BROTHERS.

SILVER SPANGLED HAMBURGS.

Harrison



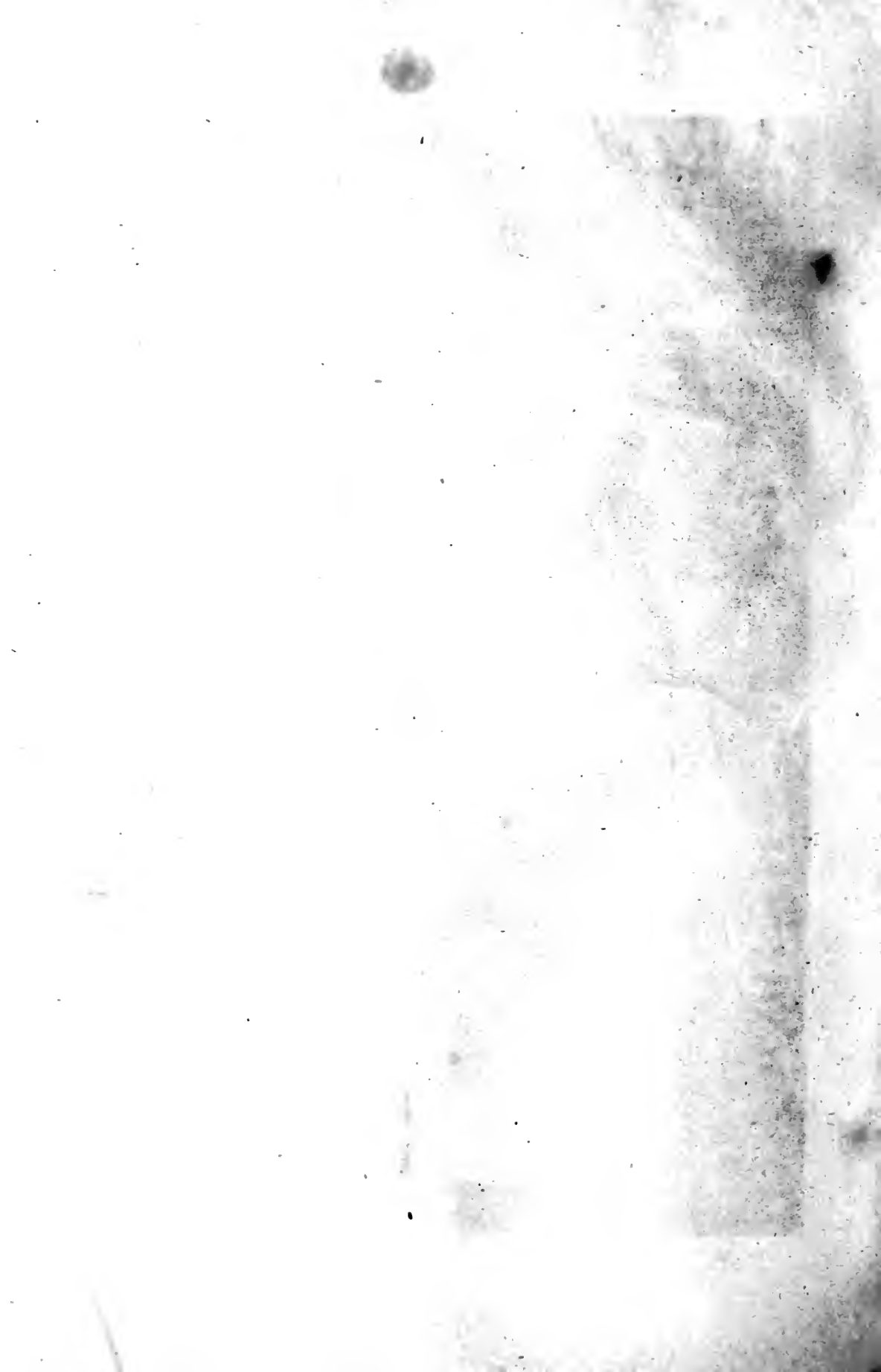

cocks is white, often tinged with yellow, the longest feathers slightly tipped with black. The neck of the hen is white, striped with black, the spangles on the greater and lesser wing coverts forming two distinct bars across the wing. The tail of both cock and hen white, ending with black spangles.

“In the true Silver-mooney hen the spangles are very rich and round; these hens are often seen at shows, but they are seldom exhibited with the true mooney cocks, the latter finding little favour on account of their stained deaf-ears and dark tail, and smaller and shorter build, yet it is quite impossible to breed good Mooney hens with any other than a true-bred Mooney cock. A large number of the clearest tailed Silver-spangled cocks are bred from Lancashire Silver-mooney cocks and rather light Yorkshire Silver-pheasant hens; the cockerels from this cross frequently have very pure white deaf-ears and clear tails, but they are generally too light on the breast, particularly in the higher part. The pullets from the cross are quite worthless, being nearly always deficient in mooning on the shoulder coverts. Should a pullet by any chance appear amongst these cross breeds passable in marking, she always, at her first moult, becomes light on the shoulder and higher part of the back; whereas the true-bred Silver-mooney hen will moult true all her life without the slightest deterioration in the marking of any part. I have now a Silver-mooney hen, seven years old, that has often been successfully exhibited and has moulted without the slightest perceptible difference in marking, except that the moons appear to increase slightly in size. The two hens formerly exhibited so successfully by Mr. Beldon, and afterwards by Mr. Wood of Kendal, are true Lancashire Mooneys, and though they have been so very frequently shown for at least six years as seldom to have been more than a few weeks at once at their own home, their marking is as near perfection as possible. The slightest impurity of blood, in either the Gold or Silver birds, always shows itself in the bar feathers of the wings, which become laced; consequently a laced wing in adult birds is looked upon, both by the Yorkshire and Lancashire breeders, with perfect disgust. Chickens of the truest blood in their first year often show a little lacing on the bar feathers: this is generally the case in Golden-mooney pullets, but after their first adult moult, if there is no stain in the blood, their bar feathers are beautifully clear and free from that imperfection. Impurity of blood also shows itself in mossaing and lacing, especially on the feathers near the tail and breast, and in the Silver hens by clouded necks.

“The colour of the down at the base of the feathers varies very much in the different varieties. In the pure-bred Mooney the down is a rich black, much darker than in the Pheasant fowl, and extends farther up towards the middle of the feathers. Some of the silvers bred from Mooney cocks and Silver Pheasant hens, have pure white down on the bottom of the feathers, the down at the root of the cock's tail is pure white, and there are not any spangles on the tips of the tail feathers; these birds are often called clear-tailed cocks, on account of the

purity of the white in the tail; their legs are nearly always far too light, the slightest shade of blue only being visible in the front; the back being white and flesh colour.

“All the four varieties are non-sitters; the Golden-mooneys are the least prolific; the others, where the place is not over-stocked with fowls, and they can have their liberty, lay an extraordinary quantity of eggs, and are so fertile that every egg generally produces a chick. There is no trouble in attending them when hatching; the chicks generally break the shell in nearly equal halves, and (unless the eggs were very old when set) within a few minutes of each other; they are lively little things; immediately after being hatched, almost as soon as they are dry, they will put out their little neat heads all round the hen. As compared with other chickens, they are restless, nearly always seeking for insects, requiring but little hand feeding, and if they have their liberty and a good grass run they are very quick in feathering and remarkably easy to rear; but when confined in a yard, or at a place where there is a large number of chickens, they sometimes die off quickly in whole broods; at other times they will remain pining about without growing for weeks and then recover.

“In their first feathers they are beautifully pencilled (Fig. 8), and are not spangled on any part whatever, until they get their second feathers, then it is the fancier anxiously scans the development of each feather, scrutinizing the shape of the spots most narrowly. The deaf-ear, also, at this time begins to show itself in a bare silver coloured spot; should it be bright red, even at this early age, there is little hope of its ever becoming wholly white.

“They are truly the cottager’s fowls, and if allowed will often make their appearance in the house, where they become the tamest of pets, flying on the shoulder or hand of the person who feeds them; yet with strangers they are very shy and wild, especially if the owner or some one of his family is not present.”

The Black Hamburg, or Black Pheasant fowl, remains to be described. This variety is rising rapidly in public estimation, and there are no large shows where it does not make its appearance, even when no distinct prizes are offered for the breed, as they are frequent winners in the Variety Class. Black Hamburgs are larger than the spangled breeds: heavy cock birds will not unfrequently attain a weight of six or seven pounds. The general character of the plumage is strongly marked, it being a superb jet black, with an intense velvety-green spangle at the end of each feather. The tail in the cock is very long, full, and well developed; of a deep hue, the outside flowing feathers being glossed with the richest green-black; the breast of the cock is also of an intense black, with dark green spangles; the lower wing-coverts, or what constitutes the bars in the lighter breeds, are of an intense, well-developed green, extremely beautiful; the legs and feet blue; the cock’s comb is largely developed and better shaped than in any other double-combed bird; the wattles are large and round, but not particularly long; the ear-lobe is white and round: very distinct from face, which is perfectly red. The hens are large,

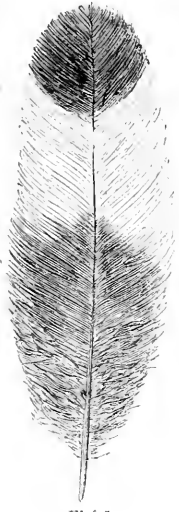

Fig. 1.

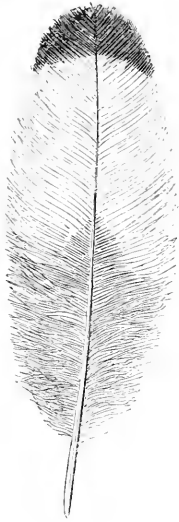

Fig. 2.

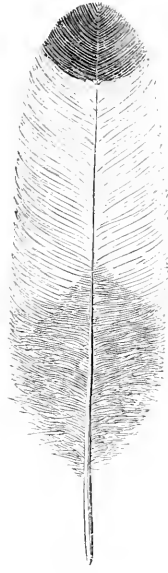

Fig. 3.

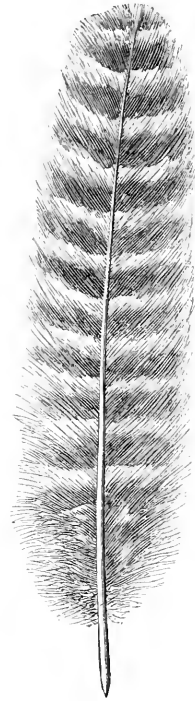

Fig. 4.



Fig. 5.

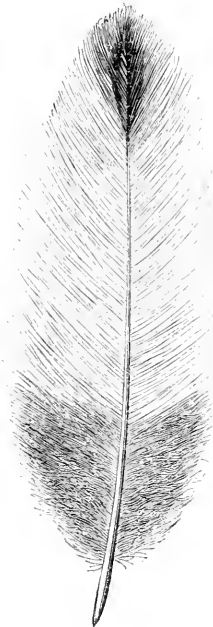

Fig. 6.



Fig. 7.

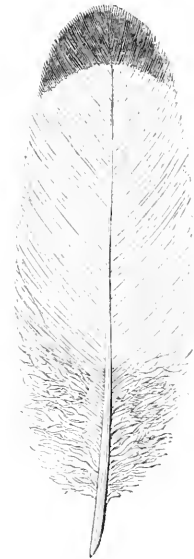

Fig. 8.

FEATHERS OF THE DIFFERENT BREEDS OF SPANGLED HAMBURGHS.

1. Feather of Lancashire Mooney Hen.
2. Feather of Golden Pheasant Hen.
3. Feather of Silver Pheasant Hen.
4. Wing Feather of Silver Mooney Chicken.
5. Hackle of full-feathered Silver Mooney Cock.
6. Hackle of Hen-feathered Silver Mooney Cock.
7. Saddle Feather of full plumaged Golden Pheasant Cock.
8. Saddle Feather of Hen-feathered Golden Pheasant Cock.

square, short on the legs, and heavy. They are generally rather wild; and as layers, not to be surpassed under any circumstances.

In any previous description of the Black Hamburgs, or Pheasant Fowl, the existence of the green-black spangles at the end of each feather has been passed over without notice. But it is, in fact, the presence of these spangles that gives rise to the rich glossy appearance of the plumage; in a bright light the contrast between the jet black of the ground-colour and the iridescent green-black of the spangles is strikingly evident.

As stated by Mr. Teebay, the Lancashire breeders have long had annual exhibitions of these fowls, the hens or pullets only being exhibited. As it is always interesting to trace the progress of any variety, we subjoin the table of points by which the Golden Mooneys were formerly judged at these local shows. The ignorance respecting these beautiful birds that prevailed in the south of England may be judged from the fact that, in the Poultry Book published by Messrs. Wingfield and Johnson, these characteristics were given as applicable to both sexes, and Mr. Harrison Weir's drawing of Golden-pencilled Hamburgs was described as being one of Golden-spangled birds.

TABLE OF POINTS IN THE GOLDEN MOONEY HENS.

POINTS.	MARKS OF FEATHERS, ETC., CONSIDERED BEST.
1st.—COMB . . .	Best double; best square; the most erect and best piked behind.
2nd.—EARS . . .	The largest and most white.
3rd.—NECK . . .	The best streaked with green-black in the middle of the feathers; and best fringed with gold at the edges.
4th.—BREAST . . .	The largest moons; best and brightest green-black, most free from being tipped with white or red at the end of the moon, and the clearest and best red from the moon to the bottom colour.
5th.—BACK . . .	The largest moons; best and brightest green-black, least tipped with white or red at the edges of the moon, and the best and clearest red from the moon to the bottom colour.
6th.—RUMP . . .	The largest moons; best and brightest green-black, least tipped with white or red at the edges of the moon, and the best and clearest red from the moon to the bottom colour.
7th.—WING . . .	This is divided into four parts:—1st, <i>Bow</i> . Best and brightest green-black, and best and clearest red.—2nd, <i>Bars</i> . To have two distinct bars, composed of the largest, clearest, brightest, and

POINTS

MARKS OF FEATHERS, ETC., CONSIDERED BEST.

best green-black moons, and the clearest and best red from the moon to the bottom colour.—3rd, *Flight*. The clearest and best red.—4th, *The Lacing, or top of the wing, above the flight*. Largest, clearest, brightest, and best green-black spots on the end of the feathers, and the best and clearest red from the spot to the bottom colour.

8th.—TAIL	The brightest, darkest, and best green-black. To be full-feathered.
9th.—LEGS	Best and clearest blue.
10th.—GENERAL APPEARANCE	The best feathered hen.

The black pheasants were also exhibited, and the following shows the points by which they were judged.

TABLE OF POINTS IN THE BLACK-PHEASANT FOWL HENS.

1st.—COMB	Best double; best square; most erect; and best piked behind.
2nd.—EARS	Largest and purest white.
3rd.—COLOUR	The best and richest glossed green-black.
4th.—LEGS	Best and clearest blue.
5th.—GENERAL APPEARANCE	Best feathered hen.

Spangled Hamburgs are usually regarded as birds exceedingly impatient of confinement, and requiring a large and extensive grass-run: they fly, as has been justly remarked, like pheasants, and know not bounds. The following communication from the Rev. A. G. Brooke, formerly a very successful exhibitor of Silver Spangles, will therefore be read with interest, proving, as it does, the possibility of keeping these active and roaming birds in perfect health and brilliant plumage in very close confinement. Mr. Brooke states:—"My silver-spangled birds I always keep confined in places about twelve feet long and six feet wide, exclusive of the sleeping apartments, which are well ventilated, and have the floors either of asphalt, brick, or wood, raised a foot from the ground, and freshly sanded every morning. Their runs are also freshly sanded or gravelled once a week, and every morning swept clean, and then turned over with a spade, which prevents the ground becoming tainted. The fowls are not at all impatient of confinement, but appear very happy and comfortable, and thrive remarkably well. I never keep more than three birds in one yard—namely, a cock and two hens,—as I have always found the fewer, when confined, the better. I am very particular that their water pans should be kept particularly clean, and as regards their food, I vary it as much as possible, always taking care that they have some sort of food by them. In the morning I generally give them mashed potatoes or middlings and barley-meal; and

in the afternoon, either barley or oats, with a most liberal supply of green-meat, such as cabbages or grass. Spangled Hamburgs are rather susceptible of cold; but I generally find that a few mashed potatoes, with a little cayenne-pepper, always relieves them. I have kept them in the manner I have described for the last three years, and have never had a fowl ill with roup or any other disease. I believe that when thus confined, cleanliness and a liberal supply of food are most essential. I have kept many other breed of fowls, but have found that none of them would better bear confinement for any length of time. As regards the number of eggs laid by Spangled Hamburgs, I think it far exceeds that of any other variety. Mine average 220 a year from each hen—I am now writing of birds that are kept confined. To keep them free from vermin, it is essential that they should be supplied with a sand bath, which they use daily.”

Little more remains to be said respecting the varieties of Spangled Hamburgs; their elegance and utility are daily increasing the number of their admirers; and they promise in a short time to be as highly appreciated in the south as they have long been in the north of England. In fact, until recently, they were scarcely known in the southern counties: and even as late as 1852, it was stated in “Baily on Fowls,” that they were “good mothers”—a very convincing proof of the prevailing ignorance respecting them. As egg-producers they are unquestionably unrivalled; they commence laying at a very early age; never require to sit; rapidly get through their moult; and, if well fed, lay steadily during winter, unless the weather is very severe.

Spangled Hamburgs are not only larger but much hardier than the Pencilled birds, being infinitely less subject to roup. During chickenhood, however, they do not possess the hardihood of Cochins or Brahmas, and therefore it is not desirable to hatch them before April or May; nor do they thrive so well as the Asiatics, if hatched at a late period of the year.

Hamburgs are valued in accordance with the perfection of their peculiar and characteristic markings, rather than by size or weight. It follows from this circumstance, that any cross-bred birds from any of the varieties must be of but very small value. The great merit of Hamburgs is as egg-producers,—a property which depends on their non-incubating habits: but cross-bred birds, as before stated, even if between two varieties that do not sit, are generally good mothers, and their broodiness necessarily interferes with their egg-producing powers. Nevertheless, it is always interesting to trace the result of such alliances; and we therefore extract from the *Field* the letter of a correspondent detailing the results of some experiments in cross-breeding Pencilled and Spangled Hamburgs with other varieties.

“1st. A cross between a Golden-pencilled Hamburg cock and Spanish hen.—The chickens were not very large. Colour: the greater part of them bronze, and one or two black; legs black; single and rose-combs. Not very hardy; good layers; small eggs.

“2nd. Golden-pencilled Hamburg hen and Golden-spangled Bearded Polish

cock.—Chickens: cockerels about the size of barn-door fowls, red, with spangled breasts, beards, small top-knots, large white ear-lobes, blue legs; pullets brown, with spangled breasts and necks, backs running into grizzle. Excellent layers, and good-sized eggs.

“3rd. Silver-spangled Hamburgh cock and Brahma hen.—Chickens large, very handsome. Cockerels; silver-spangled breasts and slightly spangled over the back, with flowing tails, rose-combs, large red ear-lobes, blue legs, feathered. Pullets: silver-spangled. They are the handsomest cross-bred fowls I have seen.

“4th. Silver-spangled Hamburgh cock and Buff Cochin-China hen.—Two pullets: dark gray, running into a grizzle; legs blue; single combs. Inferior to the cross with Brahmas.

“5th. Silver-spangled Hamburgh cock and White-faced Spanish hen.—Chickens: very hardy, short-legged, plump fowls; single and rose-combs; large white ear-lobes; black legs; neck silver-laced, and the remainder of the body dark gray.”

It is singular that in the two instances of crossing with Spanish hens, the chickens produced by the Golden-pencilled Hamburgh cock partook of the delicacy of the sire; whereas those from the Spangled Hamburgh cock and Spanish hen are described as very hardy.

Before concluding this chapter on Spangled Hamburgs it is desirable to correct an erroneous impression that the breeds known as Gold and Silver Pheasant fowls originated in crosses with the wild pheasant. As this opinion is still held by many who are unacquainted with the fact that all such hybrids are sterile, we have much pleasure in inserting the following account of several of these birds from the pen of Mr. Hewitt, who writes:—

“As my desire is to prevent, as far as possible, any poultry amateur from incurring unnecessary trouble or expense at the commencement of his career, by the pursuit of objects that are either altogether unattainable or actually worthless, if secured, perhaps a few hints as to hybrids between the pheasant and fowl will be esteemed interesting, as at one period I devoted considerable attention to the subject; and although these experiments were continued for some years, and necessarily entailed no slight expenditure, the results were, as a whole, the very reverse of satisfactory, for my hope was to procure a really beautiful as well as singular plumage. The common popular error that, even in the present day, fails not to delude numbers of unpractised poultry fanciers into the impression that the variety of the Golden-spangled Hamburgh known in the northern counties as the ‘Golden Pheasant,’ or ‘Pheasant Fowl,’ is the product of a ‘cross’ between the real pheasant of our woods and a hen of our common domestic fowl, I should have thought was a folly that had long since been exploded, being a position that no real naturalist could by possibility have ever entertained. Yet so it is: many parties are still found, not only dictatorially asserting it as an absolute fact, but likewise producing the common Spangled Hamburgh fowl as the fruit or invariable product of this unusual connection. Such individuals generally endeavour to support their statement by an appeal to the regularity of the markings of the

birds produced; and insist that the repetition of the cross at intervals is actually needful, to perpetuate this beautiful marking of feather. However dogmatically such an assertion may be enforced, it is, without doubt, the most egregious nonsense that was ever attempted to be palmed on the public; and evidently in not a few instances is practised on the unwary simply to secure a sale for birds at enhanced prices, and of course at sums far beyond their real value, as varieties of the domestic fowl.

“That the common wild pheasant will breed occasionally with the domestic fowl, and that too of almost any variety, I unhesitatingly admit; but although I have for years made the closest investigation in all such cases as came under my notice, I never, most certainly, met with even one solitary, one isolated instance, where a hybrid was produced if the pheasant had been wild bred and still retained unlimited freedom. To obtain so unnatural a product, I have always found it altogether indispensable for the pheasant itself to have been previously hatched and reared beneath a common fowl. If afterwards restored to comparative liberty, I have then known the pheasant so released to still associate with the poultry, and actually produce hybrids with a domestic fowl; but even in this case, the partiality has been confined to some particular favourite, and the pheasant has certainly not lavished his attentions equally on all. But even these instances are exceedingly rare ones; and the half-bred offspring is only to be attained, as a rule, by close confinement of the pheasant with its allotted mate, either directly in an aviary, or some very restricted premises of a like nature. Here difficulties still surround the fancier who attempts their procreation, for but few of the eggs will usually prove fertilized; and that, too, however fond and salacious the pheasant may appear to be, or however carefully its owner may have guarded against the male bird's access to females of its own race—for the introduction of even a single hen pheasant will commonly estrange all feelings of affection from the common fowls. The results desired are rendered far more probable, as may be supposed, by confining the attentions of the pheasant to one solitary female of the variety of domesticated poultry that may have been arranged. It is also certain, that pheasants are most capricious in their attachments, and that with some hens they will not associate under any circumstances whatever, though constantly abiding with them in apparent good-fellowship. Again, not unfrequently, from some inexplicable cause or other, they seem to entertain the most determined aversion to the mate selected for them by their proprietor; and certain it is that, in this case, no artifice will produce anything even approaching to reconciliation. In such an exigency, the old school axiom, that ‘perseverance commands success,’ is thrown overboard altogether; and the sooner a change takes place, the greater probability will there be of a successful issue. I will now very briefly describe the results obtained by crossing the cock pheasant with hens of the five following varieties, namely, Spanish game, Buff Bantam, Golden-spangled and Silver-spangled. All the five hybrids possessed the following general characteristics:—Extraordinary wildness; heads altogether devoid of either comb, wattles, or deaf-ear; tails very

closely approximating in general conformation to that of the pheasant, but not so lengthy; and the bodily size was far superior to that of the hen producing them. The colours of the plumage in all cases (one excepted) were likewise excessively darker than that of the variety of hen from which they were produced; whilst their general contour, as a whole, inclined most entirely to that of the pheasant.—The hybrid produced between the pheasant and the Spanish hen was bred by Mr. Keeling, of Vauxhall, Birmingham, and proved, when adult, entirely black, but of a dull sooty hue; the eyes were yellow. The weight of this bird was nearly seven pounds; and it therefore, to the eye, presented an appearance nearly as large as that of the curassow. Around the eye, and more particularly on the face beneath it, the velvety character peculiar to the pheasant itself was well developed. In the hybrid produced from a black-breasted red game hen, the scapular feathers were marked with nearly as much regularity as in the male parent, as were also those on the breast; but the ground colour was so extremely dark (resembling wetted cinnamon), that none of these markings were visible, unless a powerful light rested on the bird's plumage. The neck was iridescent black, brightly glossed with green. This specimen possessed a perfectly plain face, feathered up closely to the eyelid; the eyes being deep hazel. This bird, which was in my own possession, was very large, and weighed somewhat more than six and a half pounds.—The specimen resulting from the cross between the cock pheasant and a Buff Bantam was bred by the gamekeeper at Chirk Castle, Denbighshire. It was very nearly as dark-coloured as the one last described; but in patches it was irregularly tortoiseshelled, and was really a handsome bird, in size fully equal to a Malay hen. Although the neck and head were dark as a pheasant's, the face bore a strong resemblance to white Genoa velvet, a singularity which caused it to be greatly admired. The eyes were yellow. The offspring of the Golden-spangled Hamburgh hen and cock pheasant was a bird black in the ground-colour, the tips of the shoulder and crop feathers slightly laced with very deep brown; the tail being slightly barred. The whole bird did not, at two years old, possess one single spangle, although the mother was a very perfect mooned bird. The hybrid was the property of a friend at Wolverhampton, who, on account of its indomitable wildness, objected to its being caught for the purpose of weighing; therefore, my description of size must be confined to the fact that it appeared fully twice as large as the mother hen. The last of these hybrids that I shall describe was produced from a really superior Silver-spangled Hamburgh hen. It was bred by Mr. Watson, of Birmingham, and was the most attractive in its plumage of any I ever yet met with. The ground-colour was silvery white, the markings of an irregular but most curious close pencilling, the wing-feathers and tail being deeply barred; the face was flesh-colour, without even the vestige of feathers of any kind; the eyes were as purely white as those of a grey parrot. This gave the bird a somewhat sickly look (that was unpleasingly suggestive of poultry when long diseased, and the florid hues have left them pale and emaciated); still, the defect proved only an eyesore, for the hybrid was unquestionably in good condition, strong, and heart-

well. It was fully twice the size of the pheasant. The pencillings of this bird showed at intervals a disposition to run into each other ; on the shoulders especially they mingled, until they actually formed a kind of general fretwork : I will particularly allude to the fact that not a single spangle was visible anywhere ; although, had any existed at all, they would have been very apparent, on account of the lightness of the ground-colour. All the markings were of a very deep black colour. From the five results just narrated (and I could easily allude to numerous other cases if I desired it), it will be seen that in no case was there to be found the 'spangle' or 'moon' so much dwelt on as the consequence of consanguinity with the pheasant. Why such a fiction should be persisted in, I really cannot imagine ; except by attributing it to the misrepresentation employed to impose on the inexperienced or the credulous ; and my object in refuting this popular error is, if possible, to prevent it being again practised on the unwary. My own motive for attempting their production was entirely to investigate the production of the different markings and character of the birds. The markings were as variable as they could be, and the birds as pugnacious as it is possible to imagine ; and I never knew any instance where they did not destroy all the eggs to which they could gain access. As anticipated, they were always sterile, and unsociable. It should be borne in mind that the five instances specified were not cases where only a single bird was produced from a hatch of eggs, for it generally happens that if a single egg proves fertilized, there are several others that are equally productive in the same nest ; but I have purposely selected them as fitting illustrations. Oftentimes, however, very large numbers of eggs may be incubated before a solitary chicken is obtained. When once hatched, they are very easily reared, but manifest their peculiar and extreme pugnacity at a very early age, maintaining a constant warfare, even when among themselves,—a feature that continues to their life's end, whatever description of poultry may be appointed as their associates. This want of sociability renders them perpetual pests unless they enjoy exclusive possession of their habitation. Indeed, a gentleman who once accompanied me to inspect several of them that had been reared with great kindness and good usage, and still remained constantly under the eye of their owner, remarked—' They seem as wild as hyenas.' They are in truth always, if in health, roaming about in the most unsettled manner from morn until night closely approaches ; their cry is peculiar to themselves, and the frequency with which it is uttered is annoying, as it is plaintive, hoarse, and guttural. The greatly increased size and weight of these birds beyond that of their immediate progenitors is very striking to the eye at first sight, but is of no importance in a practical point of view, as any intermixture between birds of distinct species, as pheasants and fowls, can never be extended beyond the first cross. At poultry exhibitions they invariably serve as a great attraction to visitors, and my opinion is, that such a position is the extreme limit of their utility."

It may perhaps be imagined by some of our readers, that we have allotted more space to the discussion of the characters of these hybrids than the subject deserves ;

but the belief in the possibility of obtaining a fertile cross breed between the pheasant and the domestic fowl is so prevalent, that we felt desirous of adducing a sufficient number of examples to set the question at rest; more especially as, in a treatise on fowls published only a few years since, these hybrids were said to be fertile, not only with pure-bred fowls, but also *inter se*, and their progeny was traced through several generations. But we cannot discover any person except the writer who was cognizant of the experiments or saw the results that were said to have been obtained.

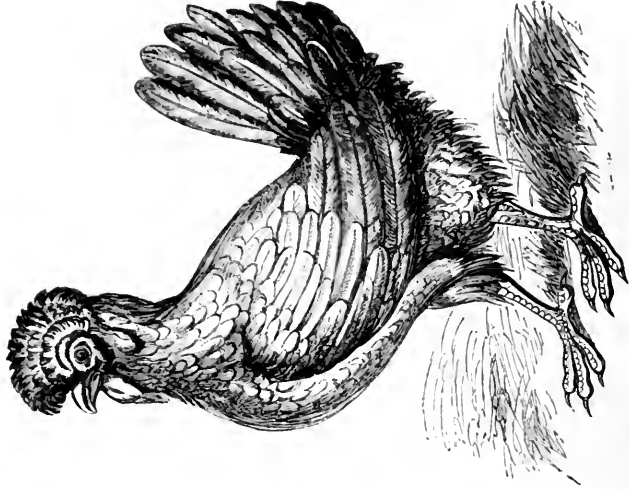

PADUAN OF PAVIANIAN FOWLS. AFTER ALDROVANDUS.

CHAPTER XV.

WHITE-CRESTED BLACK POLISH FOWLS.

UNDER the title of Polish Fowls are included all those varieties characterized by the possession of a very largely developed crest of feathers on the head. Their history can be traced back as far as the time of Ulysses Aldrovandi, better known under his Latinized name of Aldrovandus, a Bolognese gentleman, who was born in 1527, and died in 1605. Aldrovandus devoted his time to the pursuit of natural history, and exhausted his resources in collecting specimens and in the payment of artists and engravers. During his life, he published three folio volumes on birds; and, after his death, several on other departments of natural history were published at the expense of the Bolognese Senate. Aldrovandus describes and gives figures of several varieties of fowls, as the Crested, a white fowl with a lark's crest; the Dwarf (*Pumilio*), a small breed of various colours, also crested; the Feather-legged; the Turkish, with a double comb, and well developed wattles; the Persian, with short legs, and an enormous double comb; the Frizzled Fowl; the Woolly Fowl, analogous to the Silky Fowl of the present day; the Paduan, or Patavinian breed: these he describes as follows:—"There are kinds of gallinaceous birds, larger than ours, which are commonly called Patavinians. We present pictures of the male and the female. The cock is exceedingly beautiful, being richly decorated with five colours, viz. black, white, green, red, and ochre; the body black, the neck covered with white feathers, and the wings and the tail partly black and partly green; the tail of the same hue, but the roots of the feathers whitish, and some of the flight-feathers also white. The eyes are surrounded by red circles, the comb is very small, the bill and feet yellow, and the head is adorned with a beautiful crest. In the hen there is no white, except the white pellicle at the opening of the ears. She is altogether of a greenish-black colour, with yellow feet, and a very small comb, slightly tinged with red."

The figures given in the old folio of Aldrovandus are of great size; but, on a smaller scale, they are correctly reproduced in the opposite plate. In the time of Aldrovandus there were no poultry-shows, and consequently birds were often matched together irrespective of colour and form: we must not, therefore, be surprised that in the hen there are not any wattles, but merely a fulness of the neck feathers, tending towards a beard; the cock, on the contrary, is well wattled, and has abundance of sickle-feathers, or tail-coverts, though the whole of that appendage is very short, which perhaps may be accounted for by the circumstance that he was probably a cockerel, being without even a trace of spurs on the legs.

There can be but little doubt that these birds were the progenitors of the present breeds known as Polands or Polish fowls; under which title are included, in our present nomenclature, those varieties of fowls characterized by the possession of a very largely developed crest of feathers.

Of the origin of the Polish fowls, little or nothing is known: they are not unfrequently stated to be the descendants of the great fowl of St. Jago; but as there are more than twenty places in different quarters of the globe termed St. Jago, the information is not of a very satisfactory character. With the kingdom of Poland, it is certain they have no connection whatever; whence, then, it may be asked, is the origin of the title by which they are so generally known? By some writers this name has been declared to be a recent innovation; but the White-crested Black have been known by it to the London dealers for at least half a century; and in the earliest editions of "Mowbray on Domestic Poultry," they are termed Polands.

The most satisfactory solution to the question is that offered by the late Dr. Horner, who wrote as follows: "In scientific nomenclature, it has ever been the practice to designate new genera, species, or varieties, from certain resemblances to other well-known or familiar things, or from certain striking features; so has it been, I conceive, with the Polish fowl.

"Its remarkably elevated, rounded, and prominent skull-cap, or poll, could not escape the observation of the older naturalists. Again, the large crest of feathers, or top-knot, is another attribute which must have bespoken consideration in any name to be given to this variety of fowl. The term *poll* is not unfrequently used to designate the feathers, hair, or even wool, on the head of an animal: so that whether we look at the unique anatomical conformation of the bird's head, or at its more ostensible bunch of feathers, it must have commanded attention. Its *head* or *poll* was its peculiarity—*i.e.* the bird with the remarkable head or poll; hence Pollish or Polish fowl. It is quite evident that this bird has nothing to do with the country of Poland; and the disease of the hair, *Plica polonica*, offers no analogy, as in this disease the hair is closely matted to the head; and is usually also thin or spare in quantity, very different to the full, erect, and flowing top-knot of the Polish fowl."

Presuming this derivation to be correct, the superiority of the term *Polish* over that of *Polands* is obvious, without taking into consideration the grammatical inaccuracy of the latter title.

There are certain characteristics common to the whole group of Polish fowls, which may be alluded to before entering upon a consideration of the different varieties. The most important is the possession of the feathered crest, which in the cocks is composed of long pointed feathers, closely resembling those of the hackle; and, in the hens, of feathers of the ordinary character, rounded at the extremity. The crest in both sexes arises from a globular tuber, situated on the fore-part of the skull: an intimate connection exists between the size of this swelling and that of the crest. In all cases where the swelling is not largely developed, there cannot exist a good crest; and as this tuber is formed before birth, it is easy

to select those chickens that will be well crested, immediately on their emerging from the shell. Perhaps the most extraordinary circumstance connected with this swelling is, that it contains by far the greater part of the brain—being, in fact, a protuberance of the frontal or forehead bone; even in old fowls, however, this tuber rarely becomes entirely bony, but consists in great part of membrane: hence there is no protection for the brain beyond the feathers of the crest and the integuments; so that a slight blow on the head, that would not affect an ordinary bird in the least, will destroy a Polish fowl.

The peculiar structure of the skull of these crested fowls, was noticed as long since as 1656, being described by Peter Borelli, in his "*Histor. et Observat. rarior.*," page 154, and formed the subject of a chapter by the celebrated Blumenbach, who, in his work entitled "*De Anomalis et Vitiosis Quibusdam Nisus Formativi Aberrationibus Commentatio. Gottingae 1813.*" writes:—

"Those forces which act on the configuration of bones, may be observed in that aberration of the formative nisus by which the primitive stock of animals degenerates into constant and hereditary varieties.

"As a sample of these, I may mention the remarkable variety of domestic poultry which are distinguished by a thickly feathered crest on the head and by a ball-like protuberance of the forehead connected with it.

"After having subjected to the dissecting knife, and carefully compared with each other, numerous heads of this variety at different ages, I think I have discovered that the principal cause of the wonderful change of form is to be found in the tight transverse construction of the integuments of the head. By this, the region of the skull beneath is hindered to such a degree from its normal increase, that the brain itself is tightly constricted, so that being pressed in front and raised upward, it, as it were, inflates the fore part of the skull into a bony ball; the occipital part of it, on account of the smaller increase of the cerebellum, appears more depressed; the skull itself, however, thus wonderfully inflated, becomes thinner than is usual in other poultry.

"It is well known, moreover, that this serious alteration of form in the brain exerts an influence on the intellectual faculties of these fowls; they are almost always, though in various degrees, stupid, and, as it were, without intelligence.

"What we have observed above concerning the aberrations of the formative nisus, namely, that it occurs less frequently in animals of the male sex than in females, is confirmed by the examples of this variety of poultry distinguished by the protuberance on the head; for of this deformity very slight traces indeed are found in the cocks, and those but seldom.

"It is surprising that Pallas should have thought it probable that this variety of poultry, affected with the ball-like formation on the forehead, has been produced by a cross of the Numidian Meleagris with the common poultry: this opinion, not to mention other things plainly contrary to it, is easily refuted on careful dissection, by a comparison of the horned head of that bird with the skulls of the crested poultry. For in the Meleagris that small conical and com-

pressed bony off-growth which rests on the frontal part of the head, is plainly solid, and has not the least connection with the cavity of the skull."

Blumenbach was evidently not intimately acquainted with this singular variety of fowls, as he makes several erroneous statements respecting their instincts and habits, and states that the abnormal formation is confined to the female sex. Some years since, the Editor, Mr. Tegetmeier, paid much attention to this very remarkable aberration, and, having made a large number of preparations of the crania of both sexes at different ages, read a paper on the subject before the members of the Zoological Society, which was illustrated by engravings, and published in the Proceedings of the Society.

The following cuts represent very faithfully this strange formation. The first figure shows the entire skull of a Golden-spangled Polish hen, the second that of a Silver-spangled Polish cock, which has been divided by a vertical longitudinal section :—

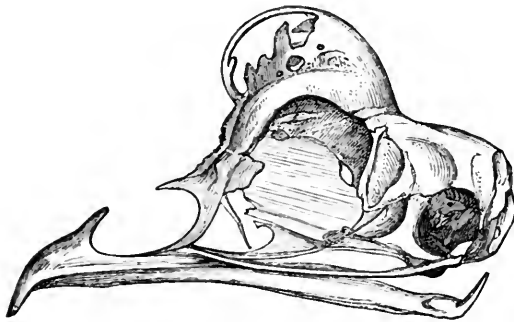

Fig. 1. Skull of a Crested Hen, showing the spherical tuberosity supporting the crest, and the deficiency of the intermaxillary bones supporting the nostrils.

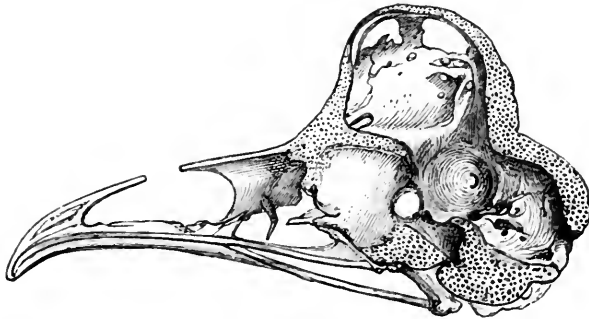

Fig. 2. Section of the skull of a Crested Cock, showing the shape of the cavity containing the brain.

By referring to these engravings, it will be seen that the tuberosity, which is situated on the fore part of the skull, is formed of bone, but that there are several apertures, which in the living animal are closed in by membrane.

On looking at the section, it may be noticed that the anterior part of the brain is entirely contained in this tuberosity, so that this important organ is really of an hourglass shape. This peculiarity in its form does not, however, as Blumenbach

stated, appear to affect the instinct or intelligence of the birds, as they do not differ in these respects from other non-sitting varieties of domestic poultry. The formation is connected in some very mysterious manner with the size of the crest of feathers which ornaments the head of the Polish fowls: whenever there is a large crest there is a large tuberosity, and *vice versá*—indeed, it appears impossible for one to exist without the other.

The young when first hatched show the prominence most distinctly, each little chick running about with a head that looks as if half a marble had been thrust under the skin of the skull; and by the size of the tuberosity, even at this early age, the birds can be selected that will have the best developed crests.

Before the recent investigations of Mr. Tegetmeier and Mr. R. Palmer Williams, of Dublin, so little was known about these birds that Blumenbach's errors remained uncorrected; and in the museum of the Royal College of Surgeons there was a skull described in the catalogue as the result of disease, whereas the peculiarity is the natural formation in every variety of largely crested fowl, and may be found in the Spangled Polish, both gold and silver; in the White, and in the White-crested Black, although the latter is evidently a very distinct breed.

Another marked peculiarity in the skulls of the Polish fowls is the deficiency in the bones of the upper mandible. These bones (the intermaxillary) in most fowls are arched upwards, and give due support to the membrane of the nostrils; in all the heavily crested birds, however, they are more or less deficient, as shown in the figures of the Polish skulls on the previous page. The nostrils consequently are flattened and scarcely so freely open as in other varieties.

The comb of the crested birds also assumes a peculiar character; it consists of two horns, forming a kind of crescent, as shown in the coloured engraving of the Crèvecœurs. In good specimens of Polish, the comb is so very small as to be almost wanting, but, however minute, the two-horned character is almost always visible on close inspection, unless, indeed, as not unfrequently occurs, its entire extinction has been effected by artificial aid.

The Polish fowls, as a class, are constituted of several well marked and very distinct varieties. Among the best known are the White-crested Black, the Gold and the Silver Spangled, the Pure White, the Pure Black, the Blue, and the Buff spangled with white, without including in the group those nearly related to the crested breed, known as Sultans, Houdans, Crèvecœurs, &c., &c.

The White-crested Black are better known throughout England than the other varieties. We will, therefore, take them first on our list. Respecting this breed, Mr. P. Jones, one of the oldest Polish fanciers, writes as follows:—

“They are not a hardy or prolific fowl, except under very favourable circumstances with regard to locality, temperature, sun, &c.; they will not do well in damp, low-lying situations; but I believe that in a dry atmosphere, with dry, sandy or chalky soil, and plenty of room, they may be reared very successfully and with profit. With regard to their appearance, there can be no denying their claims to personal beauty; in fact, I think few sights so pretty as about a dozen well-matched

perfect specimens in good condition on a smooth lawn or well-kept run; but, on the contrary, nothing can look more deplorable than to see them in bad condition, with their crests saturated with mud and water, tails drooping, and heads between their shoulders, and snuffling and sneezing with roup, to which disease there are few fowls more liable, and few more difficult to cure. I have known apparently sound healthy birds from a good dry run in the south of England, put into an ordinarily good yard near London, all stricken down in twenty-four hours, one half dying in a week, while the survivors presented the pitiable spectacle I have just described. But I do not wish to discourage my readers from keeping this beautiful variety. To those who live in suitable localities they will give both pleasure and profit, the hens being good layers and non-incubators—these being, indeed, the attributes of all the Polish varieties.

“The cock should be about 5 lb. or 6 lb. in weight, with a bold and graceful carriage, the neck slightly arched back towards the tail; body round, short, and plump, and with rather short leaden blue or black legs; the colour of a uniform deep black throughout, with iridescent tints on the neck, tail, and saddle feathers; the sickle-feathers should be quite free from grizzling with white; the crest should be large, full, and regular, well filled on the crown or centre of the head, and each feather of a clear pure white; in front, immediately over the beak, there are sure to be a few black feathers, but of course the fewer and smaller the better; there should be no appearance of comb, but full, well-developed wattles of a brilliant red; the ear-lobes should be moderate in size and white in colour.

“The hens should be about 4 lb. to 5 lb., the body somewhat similar in form to that of the cock, but rather more compact; the crest very full and globular, without any black feathers intermixed, and the fewer the better in front; but we should never be deceived by any bird which may be shown without them, as, if not present, they have been removed.”

The following remarks on the breed are from the pen of Mr. Hewitt, who formerly was in the possession of superior specimens of this variety:—“There are few descriptions of poultry, if any, that are more truly ornamental than the Black Polish; the extreme contrast between the colours of the body feathers and those of the crests rendering them not only a very conspicuous but universally admired breed, even among those individuals who are not exactly to be classed among poultry amateurs. But, in justice, I must record my opinion in their favour, as really useful as well as ornamental fowl. They are non-sitters, and interminable layers, always providing, however, the locality suits them. The subsoil for them (to ensure complete success) must be dry, and the situation of their run not exposed to cold damp raw biting winds. If not possessed already of these natural advantages of locality, then I would very strongly advise any amateur to select some more hardy kind of poultry, or he may involuntarily subject himself to much trial of temper and unnecessary vexation. If once they should happen to become diseased, White-crested Black Polish are assuredly the most difficult of any description of fowls to restore to health, by any medical



LEIGHTON, BROTHERS

WYETH'S GUNNED BLACK POLISH,





appliances with which I am acquainted. There is little doubt in my mind that this is greatly induced by the large quantity of moisture the top-knots will retain during drizzling hazy weather. The feathers of the crests are placed in a position rather to hold than repel damp; and from retaining it for some hours, the cold and moisture combined of course superinduce disease—more particularly as regards colds in the eyes, and in the head generally. For this reason, Polish of all kinds require shelter that is always available in cases of sudden rains, even more particularly than other breeds of poultry. If, however, well provided with this accommodation, and likewise enjoying a dry warm walk, there is not any variety that I think more remunerative, so far as the production of a large number of eggs is considered; it is worthy of especial note, also, that the eggs produced are of a superior quality for the table. As it may possibly prevent the like misfortune to some others, who are now commencing their poultry career as amateurs, I will briefly mention a circumstance that cost me some loss at the onset of my fancy for Polish. In those cases where the crests are fully developed, it is perfectly impossible for the birds to see any approach from behind, and, consequently, Polish are naturally very timid of coming danger, probably from feeling their inability to avoid it: it was, doubtless, from these causes that in some instances, when I suddenly caught or rather quickly picked up the birds, they have instantaneously died in my hands from apoplexy, without any real injury from external pressure. A slight shudder and indistinct gurgling noise were the only accompaniment of their sudden decease. This disaster seemed to be particularly common among those chickens that, hitherto enjoying an unlimited wild run, had, for increased safety from thieves, been removed to close quarters. After its unpleasant repetition (and that generally in the cases of my very best birds) I never took them into hand without first speaking to them; and from that hour I never lost another specimen by the cause complained of.

“In no class of fowls has trimming been so universally carried out at our poultry-shows as in Black Polish; indeed the difficulty is generally to find a pen in which the crests have been left as naturally grown. This arises from the fact that the less black they show around the top-knots the better; and hence some owners are so daring as to actually remove all such feathers as they deem objectionable. Wherever so gross a case of tampering has fallen under my notice, I have considered it my duty to disqualify the birds immediately; although it seems to have been a deception that, beyond all others, has been countenanced by some of our poultry judges. I do not myself endorse the opinion that trimming in one class is less objectionable than in others; indeed, I hope that the practice will not be longer indulged in, as in close inspections it is generally discoverable, and most undoubtedly, in fairness to the conscientious exhibitor, it ought to be countenanced.

“Having for some years paid extreme attention to the culture of this elegant variety, I will just mention the results of my experience. In the first place, the crests are, without doubt, their most prominent characteristics; and to breed them

well-formed and extremely large is a great desideratum. I repeatedly proved that a first-rate crested cock, though mated to a hen with a somewhat indifferent top-knot, produced far better chickens than where the selection was reversed; I would therefore strongly enjoin the greatest care in the well-advised selection of the male. In reference to hatching, the eggs must be incubated by some other hen. In the choice of this foster-mother, I would state that large hens are very objectionable, as Black Polish chickens seem even more susceptible of injury than those of other descriptions. Cochin hens are very apt to leave their chickens before they are five or six weeks old; and as this happens to be a period of peculiar fatality to broods of young Polish, they should not be employed as their foster-mothers. No hens will, it is certain, prove more vigilant, successful, and enduring mothers than game hens. As young Polish are apt to droop away suddenly, I will relate the treatment I found most beneficial. I gave them full feed of crushed hemp-seed, chopped cheese, and maggots from stale flesh—the latter well scoured for some days in bran or sand, to cleanse them from impurities: it proved a very easy remedy and successful mode of treatment."

The circumstance that White-crested Black Polish require a dry sandy run, and warm sheltered situation, is proved by the fact that several of our most successful exhibitors reside on the dry sandy soil of the New Forest.

From the White-crested Black Polish, as from the Black Spanish and all other black-plumaged fowls, are occasionally produced perfectly white birds, with light eyes and the other features which have obtained for such productions the name of "Albinos." They are both slight in frame and delicate in constitution; and we cannot recommend the attempt to breed from them, their produce being of a most unsatisfactory description, both as regards form and colour. They are, it should be remembered, perfectly distinct from the Bearded White Polish.

CHAPTER XVI.

SPANGLED AND WHITE POLISH FOWLS.

NO sooner do we quit the White-crested Black Polish than the question of the relative superiority of the bearded or wattled birds immediately presents itself, as all the other varieties of Polish occasionally exhibit birds with and without the beard. The beardless birds, however, have of late years gone entirely out of favour, and, as we think, deservedly so, as they are inferior in all the characteristics of Polish to the bearded varieties. Mr. Baker, of Chelsea, states, that "having been lately in the south of France, where the Polish are much prized and infinitely superior to any we have in this country, I was enabled to make further inquiries as to the relative purity of the bearded and unbearded varieties, both Gold and Silver Spangled, and was then fully confirmed in my opinion as to the superiority of the former. I perfectly recollect that, some twenty years ago, there was a club of Polish fanciers at Ringolane, where the well-developed beard was considered of as much consequence as a good crest."

In the bearded Polish, immediately below the cheek, and covering the front of the throat, is a collection of elongated feathers, regularly imbricated and of triangular form; the broadest part, or base, is uppermost, extending in a line, as whiskers, below the eyes. These feathers, from the base to the point below, should occupy a space of about two inches. In the unbearded birds, the neck is comparatively slender, and destitute of the voluminous hackle that encircles that of the bearded varieties: the wattles are large, and the ear-lobe, from the absence of the ruff, more apparent. The skull, too, is less rounded, and, as a consequence, the crest less perfect, especially in the Gold-spangled, which, as it has been well said, appear to be waiting for some lucky accident to give to them good top-knots. The principal features of the Polish family—the protuberant breast, arched tail, and rounded body—are common to the varieties now under consideration and the White-crested Black; but the latter are shorter on the leg and of less weight than the spangled birds.

Of the spangled birds the Silvers may first claim our attention; and here we gladly avail ourselves of the assistance of Mr. P. Jones, of Fulham, a most experienced breeder and successful exhibitor of this beautiful variety.

"The weight of a spangled cock should not be under six pounds—from that to seven and a half pounds is large enough; but a tall large bird shows advantageously, not only in the poultry-yard, but in a show-pen. The size of the hen is

not very important in Polish; from four to five and a half pounds is a good average weight.

“The carriage of the cock is bold and erect to an extreme degree; the breast is thrown well forward, the head and tail carried well up; the wings rather low, so as to show the bars and the lacing; the general form of the body is round and plump, the keel of the breastbone well covered with flesh; body short; the neck moderate in length and gracefully arched. In the hens the form of the body is round and compact; the head and tail carried well up.

“The plumage of the cock is ample and flowing, and should be well and evenly marked; the feathers of the crest, neck, and saddle long, but abundant and strong in the shaft; the fluff on the abdomen should be very short; the ground colour of the plumage must be of the purest clear white, and markings of intense metallic black. In the hen the plumage is rather close and compact on the back; the fluff short, but ample. Clearness of ground colour, and intensity of black in the markings, are very important.

“The neck-hackle in the cock is very abundant; formed of long and strong feathers, which are white at the base, edged and tipped with black, the hackle should come well forward to the front of the neck, and on to the shoulders—the more free from a straw or yellow tinge the better. In the hen the hackle is full, but rather short, making the neck appear thick; each feather should be well marked with a dark black spangle.

“The saddle of the cock should flow well round the tail and rump, and hang well down; that portion behind the thighs is frequently white, but in perfect birds all the saddle-feathers are beautifully tipped with black. In the hen the saddle feathers are rather long towards the tail, each one being boldly spangled.

“The cock’s tail should be long, ample, and flowing; with well arched centro sickle-feathers, abundantly furnished with beautifully marked tail covert-feathers. No variety of domesticated poultry has a finer or handsomer tail, when fully developed. The sickle-feathers should be purely white, each being tipped with a large black spot. The tail in the hen is somewhat large; each feather should have a clear white ground, ending in a large lustrous black spangle. This is a great desideratum.

“The breast, in both sexes, should be well and evenly spangled from the throat to the thighs, with moon-shaped black markings on the purest white ground. The breasts of the cocks have generally a tendency to be too dark, and are sometimes quite black in the upper part.

“The shoulder of the cock should be a little lighter than the general average of colour—this, to my mind, is a great improvement; but it should be lightly spangled or spotted. That of the hen, though well spangled, is somewhat liable to get short of colouring after the second year.

“The feathers forming the wing coverts or bars in both sexes must, to constitute good birds, be well and boldly spangled, so as to constitute two transverse bars, united by delicate lacing; this is an important and necessary condition, and



LEIGHTON, BROS.

SILVER POLISH.



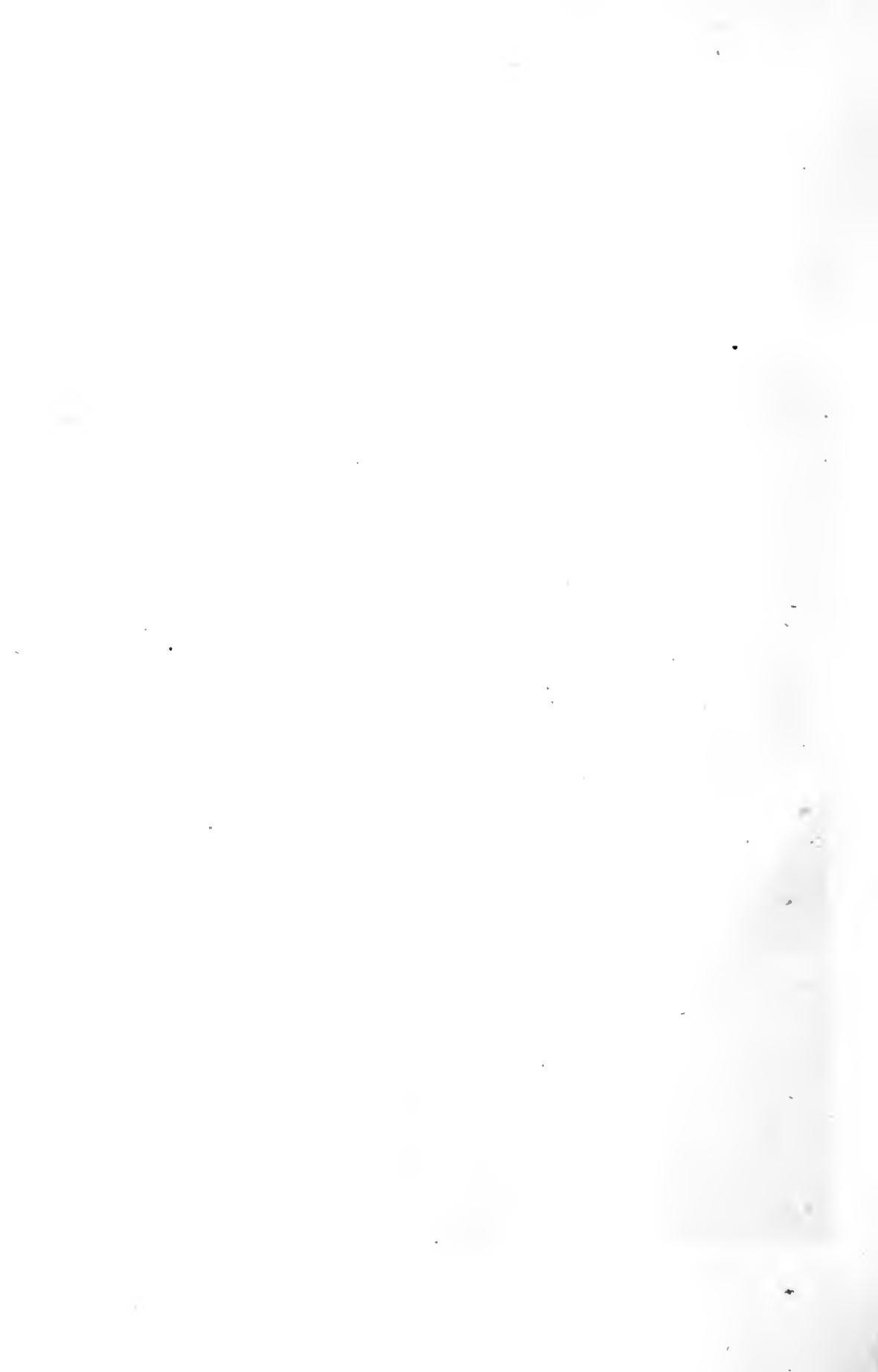

must be insisted on. The bars in the hen are the same as in the cock, but are less bold and defined.

“The secondary quills should have a clear white ground, with a large green-black spangle at the end of each feather. The thighs of the Spangled Polish are long, and should be well spangled to the hock. The legs and feet blue, fine in bone, with neat scales, and the toes rather long.

“The crest, which is the most striking characteristic of the Polish breed, is long in the best cocks, very large and full, extending regularly all round, and hiding the head and part of neck; it should have no vacancy in centre; each feather of the crest should be black at base, white for some distance in the centre, and, finally, if tipped with black it is perfect. The crest of the hen should be very large, ample, and compact, forming a globular mass of feathers, regular in shape; each feather well and evenly marked, with a white eye in the centre. After a year or two most hens get a few white feathers in the crest, but the less they are in number the better. In neither sex should there be any perceptible comb or wattles, but in place of the latter a large, triangular-shaped, black or spangled beard.

“The ear-lobe in Spangled Polish should be small and white; the face hardly seen, being covered with feathers and hidden by crest. The colour of the eye should be dark, that of the beak blue, to match the legs and feet.”

In addition to these characteristics of the breed, Mr. Jones has kindly favoured us with the following remarks:—“There is, perhaps, scarcely any breed of domestic poultry about which there exists, amongst amateurs, such a diversity of opinion as to what should constitute a perfect bird, as in the case of Silver Polish. Some breeders say they should be spangled; others, again, hold that they were originally a laced fowl. Some maintain that they should be bearded; others that they should be beardless, and furnished with wattles like their relatives the White-crested Black. Again, it used to be urged that the hens should have white crests: now a white crest is regarded as a disqualification. With reference to the first question, whether the birds should be spangled or laced, it will not be denied that many of the best birds which have been exhibited at our leading shows, have had a tendency to lacing; that is to say, the spangle, as it is called, instead of being confined to the end of the feather, has had more the shape of an elongated crescent, the horns running up the edges of the feather. This is more particularly to be observed on the breast and back of the hens; but in some of the cocks this lacing has been equally well defined on the breast. It is a remarkable fact that from the same parents are sometimes produced both laced and spangled chickens. The question of beards or wattles has now pretty well resolved itself into beards, and the larger the better. I confess my predilection is in favour of the beard,—as it appears much more in character with the general attributes of the bird, one of which is abundant plumage in every part.

“With regard to tails, I like a clear tail in the hen; and, however anomalous

it may appear, I do not object to have the feathers beautifully and slightly mossed or mottled in the cock, with a good and well-defined blotch at the tip: if the mossing, however, is heavy, the beauty and distinctness of the spangled tip is lost.

“As to their merits as a useful as well as ornamental variety, I may say that, having kept them somewhat successfully (as the prize lists of most of the leading shows some few years back will bear witness) for several years, and having attended to them entirely myself, I can speak with the greatest confidence on the subject.

“That they may be kept and bred in very small and confined places, I know; but I also know they do much better if they have the advantage of an extended run: but in this latter case they require a great deal of attention, as the crests are apt to become clogged with wet and mud, which in smaller places, from the necessity for constant cleanliness, is to a great extent avoided. In some situations I have had whole clutches of chickens reared year after year without the loss of a single bird, except by accident; while at others, and even at home, I have sometimes lost whole broods at about six weeks old: the first had to shift almost for themselves, while the others had every care bestowed on them. From the moment of hatching to six or eight weeks old, nothing can be harder; but from that age up to five or six months, I have found them difficult to rear at home, although, as I stated before, I have had from country runs eight and ten from a brood four months old, all healthy plump birds. As table chickens, I prefer them for their great delicacy. As layers during the spring and summer months, I believe they are second to none; and the eggs being of a good average size, would certainly stand the test of weight, in the aggregate, with almost any other variety. I have had them laying from January to October, and being non-sitters, the individual produce during that time is considerable. They are more easily kept within bounds by a fence of moderate height than many other varieties, particularly if the bottom part of the fence, to the height of about eighteen inches, be quite close; because, although they undoubtedly have the full use of their wings, yet their upward range of vision being circumscribed by the overhanging crest, and the close bottom to the fence preventing their seeing beyond in that direction, they are fain to content themselves where they are. I believe them to be naturally of a contented disposition, and form attachments to their feeders more rapidly than any other variety. I have had a cock which would at any hour of the night fly from his perch by candle-light at my call, and feed from my hand; in fact, almost every Polish fowl I ever had would feed from my hand during the day. As adult birds, I do not find them more liable to disease than others. As exhibition fowls my experience certainly proves they will stand the wear and tear of travelling and excitement of the show-room—as well as their unavoidable attendant, long abstinence—at any rate quite as well as any other variety; and if I were to say better, I do not think I should be wide of the mark. To sum up—and making every allowance for my own peculiar taste—I believe they stand at the top of the

list of fancy poultry ; combining, as they do, with their universally acknowledged beauty, so many of the points of excellence found in those varieties which are bred more for utility than ornament."

With regard to the disputed question as to whether these birds should be really spangled, as their name implies, or laced, we cannot but agree with Mr. Jones that some of the best birds that have been exhibited have been of the latter description. Most amateurs and judges, however, declare strongly in favour of spangling in preference to lacing, and this opinion is supported by the high authority of the "Standard of Excellence." That good birds of this variety existed many years since, may be gathered from the following communication from Mr. Hewitt:— "Spangled Polish certainly did exist, bred as truly to feather as any other variety of fowls, within the space of some twenty-five years. About that time I had opportunities of closely inspecting them, as they were kept within a few doors of the house in which I then resided. From this circumstance I can speak with the most entire confidence of the exactness of the following brief description. In size they very closely resembled those to which we now give the designation of Spangled Polish ; but they differed in the extraordinary intensity of the blue colour of the legs ; the spurs in the adult males were of ivory whiteness, and had a tendency to turn up, until they nearly touched the knee-joints. Of combs they had not even the rudiment ; and the wattles were only slightly developed. The ear-lobes were florid, tinged with white about their centres. The ground colour of the plumage was white, the whole of the feather being clear, without any lineal markings, and simply tipped with an iridescent black spangle. In the hens this marking was nearly circular, and without the slightest vestige of white beyond it. In the cocks, particularly the old ones, the crests flowed freely on all sides, and eventually became an impediment to their feeding, unless the corn was placed in a trough. The feathers in their crests, being naturally of a similar conformation to those of the neck-hackle, showed a fringe of white beyond the black spot towards the tip. The tails of both sexes were clear, spangled at the extremity, as in the Silver-spangled Hamburgs ; the side tail-coverts of the cock being spangled also : adding greatly to the beauty of the bird. On the saddle of the hens, where the feathers closely overlapped, the distinctness of the spots gave way to a somewhat increased depth of colour, that was really objectionable ; still, any of these feathers, examined separately, proved to be equally correctly spangled. The wings were simply double 'barred,' by the close position of the spangles ; but no sign of side-lacings was perceptible. The lesser flight-feathers were well marked at the extremities only. The first imported parent birds, that came originally from Lisbon, were Silvers ; but in the course of a few generations they sported several Golden chickens, but always marked as their predecessors. These were purposely mated for two successive years, without any possibility whatever of access to their lighter-coloured relatives ; yet, strange to say, they never bred any but Silver chickens, and those without the least impurity of the ground colour. These spangled birds proved themselves most abundant layers and non-sitters, and

apparently enjoyed much hardier constitutions than any of our present varieties of Polish. Having given the most perfect description I now can from recollection, I cannot conclude without bearing testimony to their superlative beauty. I have striven to obtain some of this strain, but I found, on inquiry, to my great chagrin, that the poultry had passed into other hands. The new owners were no fanciers, and to improve them they had for many years crossed them with the Game; and I was consequently nonsuited."

The Golden-spangled Polish differ so slightly from the Silvers, that a detailed description of their characteristics is not required; as, after making due allowance for the difference in ground colour, the same remarks will, with scarcely any variation, apply to both varieties.

The late Dr. Horner, of Hull, who was long known as one of the most diligent and successful amateurs of this variety, kindly favoured us with the following remarks on the breed:—"As to carriage (I write of the Golden, which I keep), it is nearly as bumptious as that of the Bantam; the breast being very protuberant, the tail very full and flowing, and well arched upon the back.

"As to comb, there should not be any, not even a spike. I do allow a very small patch of red comb-like structure, the size of a small split pea, lying close like skin, at the root of the bill; but no spikes. The feathers of the top-knot are not simply red, for the lower part is black, the extension of the black up the feather differing a little in different birds; but always should be there. In a properly marked hen, the top-knot should be spangled like the rest of the body, and not black. Now, as to white feathers in the top-knots of cocks, and hens also, they are always present in birds two years old and upwards; they are commonly absent till the birds are a year old, but they will surely come, in greater or less number, with the autumnal moult. Their presence must not be considered a fault. Possibly, as a matter of taste, some would like them without white; whilst others certainly prefer them with white feathers.

"As to tail in the cock, it is generally black, bordered with chestnut, as are the sickle-feathers also; but the smaller side wavy feathers are like those of the body, rich chestnut, edged with iridescent black. The tail of the hen is chestnut, tipped with black. The cock's tail is often grizzled with white, and the hen's often speckled and scratchy with black: such markings are, of course, to be regarded as imperfections.

"The crest of the cock must not be flattened at the top, as in such cases the feathers are too thin and long; nor should it divide down the middle like a girl's hair. It must, as far as possible, preserve a rounded globular form, which it will do if the feathers are plentiful and not too long. I may just further add, that the Polish is a spangled bird; and hence I consider lacing (except on the wings) as an imperfection. I strongly object to lacing on the breast of cocks—not an uncommon thing to see; lacing on the backs of hens, that is, on the saddle and rump, is also wrong—the feathers should be spangled."





LEIGHTON, BROS.

GOLDEN-SPANCLED POLISH.

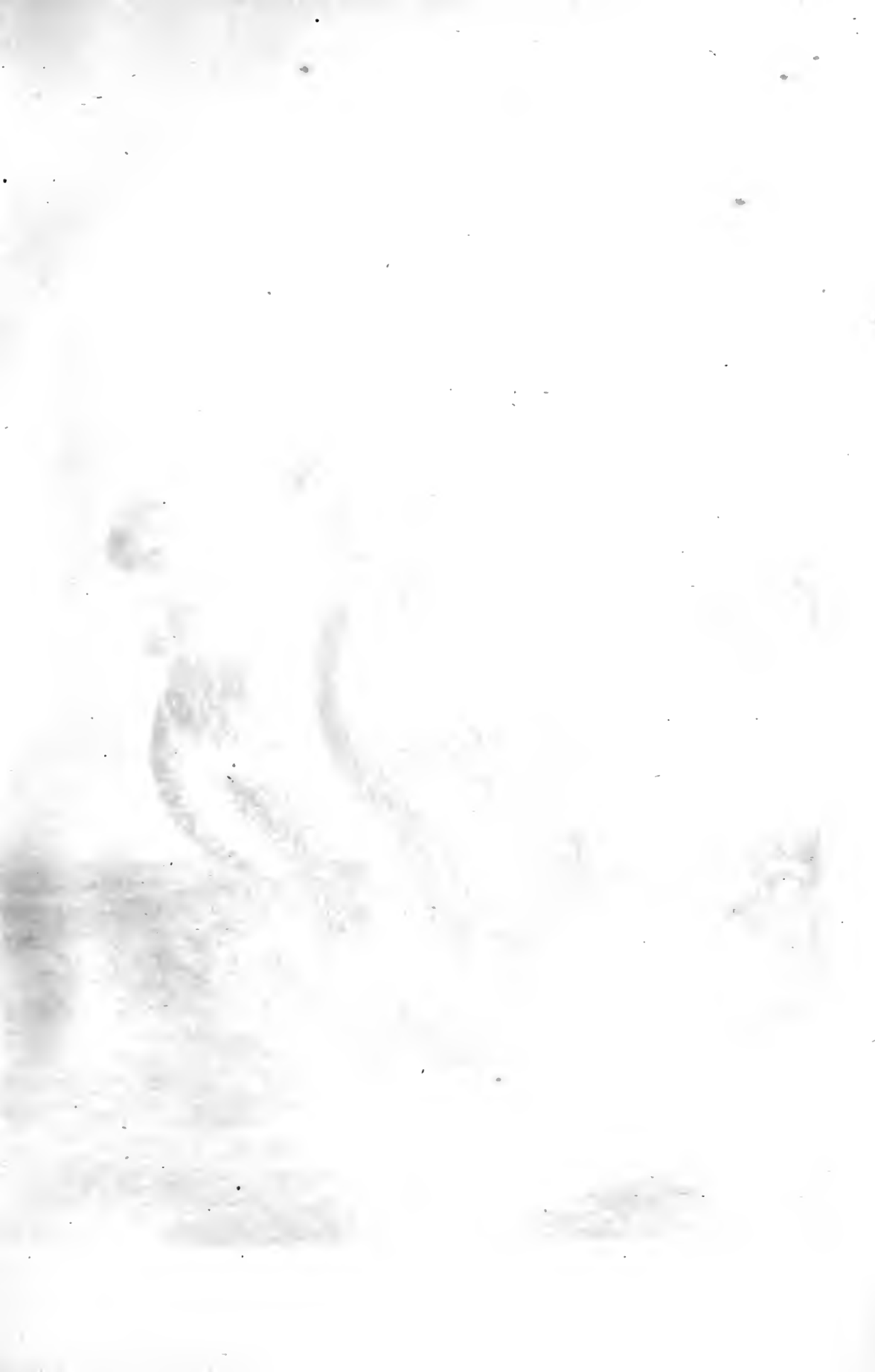



The White Polish differ essentially, as we have already observed, from the occasional white specimens produced from the White-crested Black with wattles, and are a distinct and recognized variety; their chickens, both in colour, vigour, and all other respects, bearing an exact resemblance to the parents. They are unquestionably derived from the bearded spangled birds, inferior specimens distinctly showing faint smudgy spangles on the feathers of the breast, &c.; which, however, are totally absent in really first-class birds. They have not been so frequently seen of late years at the poultry-shows as their beauty and economical merits render desirable. White Polish possess all the characteristics of the family in the highest possible degree, the crests in good specimens are very large and perfect; and our experience leads us to regard them as hardier and more easily reared on a clayey soil than either the Golden or Silver Spangled.

Black-bearded Polish are occasionally seen at our poultry-shows, but can hardly be regarded as an established variety. The Editor's own experience leads him to regard them as an occasional production from the White birds—at least his own White occasionally produced Black; but he is unable to state what the characteristics of the chickens bred from the Black would be, as he has never attempted to rear any.

The Blue or Grey Polish are also the frequent produce of the White Polish, which they resemble in all characteristics except colour; as might be expected from their accidental origin, they cannot be depended upon to produce chickens closely resembling the parents, but occasionally throw cuckoo, white, or speckled produce.

The Cuckoo Polish, resembling in markings the Cuckoo Dorkings, are another occasional variation from the bearded breeds; but they have not been received with much favour at the hands of the public.

Buff Polish—or Chamois Polish, as they are sometimes called, though for what reason it would be very difficult to explain—are exceedingly pretty when truly marked and well crested. To be perfect, these birds should resemble the Golden-spangled, with these important differences,—namely, that the feathers should be spangled with white instead of black, and that the ground colour should be a delicate buff in the hens, with a greater degree of depth and richness of colour in the cocks. From these birds having only recently come into notice, they have not been bred up to this high standard of merit; but those that approach to it are exceedingly ornamental, and evidently would amply repay the trouble of a few years' careful selection and breeding.

It is a singular circumstance that when a variation of colour takes place in the plumage of birds, the change from black to white appears to be much more easily effected than from any other colour to white. Thus, when black, red, and white Game fowls are crossed, Piles are produced, in which the black disappears, but the red of the saddle and hackle remains. By crossing a Golden-spangled and White Polish, these Spangled Buff or Chamois Polish are produced,

in which the black spangle of the Golden bird is changed into the white spangle of the Buff, the ground colour remaining almost unchanged.

The Black-crested White Polish may next claim our consideration, as there is abundant evidence to prove that such a breed formerly existed. Mr. R. Palmer Williams, of Dublin, a gentleman who has paid great attention to the history of the different varieties of crested fowls, has favoured us with the following remarks on these birds:—"The breed, up to about thirty years ago, was to be had in some parts of Ireland, as I have been informed by friends who knew it well and describe it as a very superior one; they were extinguished, I may say, in consequence of a famine and there being no Poultry Societies in those days. A few years after this time, I heard of the breed, and tried to procure it; and having heard that it was to be had at Bordeaux, I went specially for it, but was informed that there, as well as at Paris, the breed had been, but was not then, to be met with; so that it would appear that about the same time it vanished everywhere. From time to time I picked up birds from which I thought to have recovered the breed: and had I had the fine specimens of Crested White fowl now to be obtained, I think the breed might have been recovered. The last of those I had, a hen, is now in the museum of the Dublin Natural History Society. Her crest is black, and a few of the hackle-feathers black. The parties who last had the Black-crested White in Ireland were the descendants of the French Huguenots at Portarlington and Maryborough, which would lead me to expect the breed came from France, if not from Holland."

Mr. B. P. Brent also states respecting them:—"The last good specimen I saw was in the year 1854, at St. Omer in France; it was a hen, and belonged to a boat-builder, who lived by the canal. She was of large size, so that the Malays in the same yard appeared small in comparison; her colour was white, with a large black top-knot, some few of the feathers of which were, however, tipped with white: her bill and feet were dark slate-colour, shape very plump and round. Her owner described her as an excellent layer, the eggs being also of large size. He had endeavoured to get others of the same breed, especially a cock, but hitherto without success, although they were said to exist in Brittany."

The Editor of the present edition of the "Poultry Book," Mr. Tegetmeier, endeavoured for a series of years to reproduce this breed by crossing the different varieties of Polish—having as his foundation a white hen that showed a tendency to dark in the crest. The experiments were only partially successful: there was no difficulty in producing white chickens with black crests; but white feathers made their appearance in the crests the first autumn, and increased in number at every subsequent moult; so that after a few seasons the birds lost all beauty of appearance. Still it may be regretted that the experiment was not continuously persevered with, as doubtless it would have required but a few more years of careful selection to have resuscitated one of the most beautiful of all the ornamental breeds.

The results of crossing Polish with other varieties are described in the previous or following chapters. Respecting the interbreeding of the Golden, Silver, and Black varieties, Dr. Horner states : “ When the Golden or Silver Spangled are crossed with each other, cock with hen, or hen with cock, I found that the chickens in both cases were purely marked—*i.e.* they were well defined Silver, or otherwise Golden, Spangled. But when the Golden-spangled and the Beardless Black, with white crest, are thus united, the chickens partake of the colour of both parents in various degrees.”

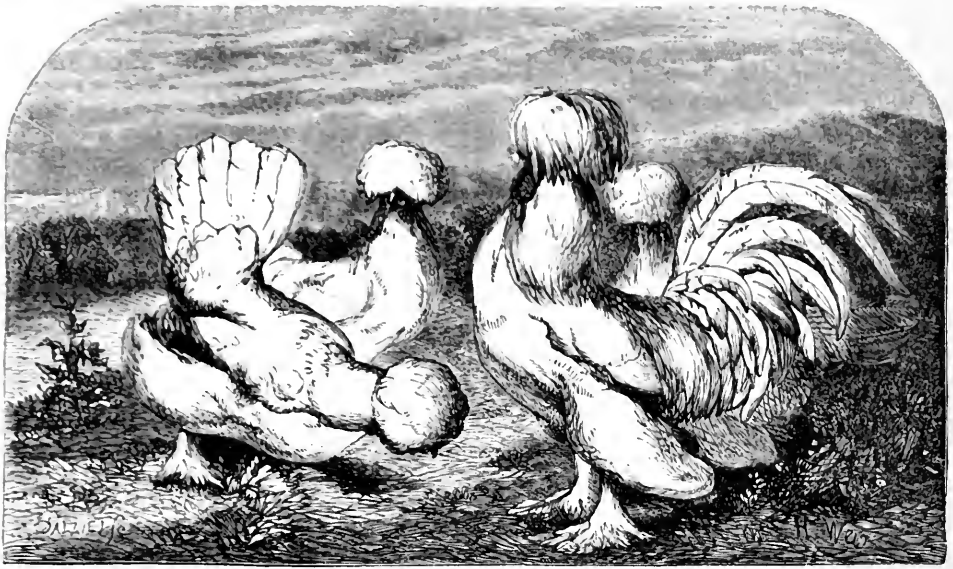

THE SERAI TA-OOK, OR SULTAN FOWLS.

CHAPTER XVII.

SULTAN FOWLS.

THE Sultans, or Feather-footed White Polish, are a very elegant and pleasing variety: they were first imported into this country from Turkey, by Miss Watts of Hampstead; their exceedingly ornamental appearance has gained them many admirers, and they are now established favourites at our shows. The following description of them was published by the lady above-mentioned:—

“*The Serai-Täook, or Fowls of the Sultan.*—This is the last Polish fowl introduced among us: they partake of the character of Polish in their chief characteristics, in compactness of form and good laying qualities. They were sent to us by a friend living at Constantinople, in January, 1854. A year before, we had sent him some Cochinchina fowls, with which he was very much pleased; and when his son soon after came to England, he said he could send from Turkey some fowls with which we should be pleased. Scraps of information about muffs, and divers beauties and decorations, arrived before the fowls, and led to expectations of something much prettier than the pretty Ptarmigan, in which we had always noticed a certain uncertainty in tuft and comb.

“In January they arrived in a steamer chiefly manned by Turks. The voyage had been long and rough; and poor fowls so rolled over and glued into one mass with filth were never seen. Months afterwards, with the aid of one of the first fanciers in the country, we spent an hour in trying to ascertain whether the feathers of the cock were white or striped, and almost concluded that the last was the true state of the case, although they had been described by our friend as ‘*bellissimi galli bianchi.*’

“We at once saw enough to make us very unwilling to be entirely dependent for the breed on the one sad-looking gentleman, with his tuft heavy with dirt, dirt for a mantle, and his long clogged tail hanging round on one side; and we wrote directly for another importation, especially for a cock, and to ask the name they had at home. In answer to the first request, we found that good fowls of the kind are difficult to get there; our friend has ever since been trying to get us two or three more, but cannot succeed either in Constantinople or other parts of Turkey: the first he can meet with will be sent. With regard to the name, he told us they are called Serai-Täook. Serai, as is known by every reader of Eastern lore, is the name of the Sultan's palace; Täook is Turkish for fowl; the simplest translation of this is, ‘Sultan's fowls,’ or ‘fowls of the Sultan;’ a name which has the double advantage of being the nearest to be found to that by which they have been known in their own country, and of designating the country from which they came.

“Time very soon restored the fowls to perfect health and partial cleanliness; but it was not until after the moulting season that they showed themselves as the ‘bellissimi galli bianchi’ described by our Constantinople friend.

“They rather resemble our White Polish, but with more abundant furnishing, and shorter legs, which are vulture-hocked and feathered to the toes.

“In general habits they are brisk and happy-tempered; but not kept in as easily as Cochin-Chinas. They are very good layers; their eggs are large and white; they are non-sitters and small eaters. A grass run with them will remain green long after the crop would have been cleared by either Brahmas or Cochins; and with scattered food they soon become satisfied, and walk away.

“In size, Sultans are smaller than the generality of Polish, the cocks weighing from four to five pounds; the hens being in proportion. In form they are very plump, full-crested, short-legged, and compact; the plumage pure and unsullied white throughout, and very abundant; their tails are ample, and carried erect; their thighs are short, and furnished with feathers which project beyond the joint, or, as it is termed, are vulture-hocked. Their legs are short, white, and profusely feathered to the feet, which are five-toed. The comb consists of two small spikes, situated at the base of a full-sized globular Polish crest; the wattles are rudimentary, both sexes being amply bearded. No fowls are more abundantly decorated—full tail, abundant furnishing, boots, vulture hocks, beards, whiskers, and full round Polish crests. Good birds of this variety possess the peculiar structure of the skull that has already been described as characterizing the Polish breeds.”

At the present time, the most successful breeder and exhibitor of this very pretty variety is Mr. F. W. Zurhorst, of Donnybrook, to whom we are indebted for the following account of their characteristics and habits:—

“A Sultan cock should have a full round crest, not branching out on either side, like too many of our modern Polish, and leaving an open space in the centre, but formed of closely set, silky, arched feathers, not concealing the eyes, but leaving them unobscured. The small red wattles ought to be smooth, but are generally a

little wrinkled and shrivelled. The comb is small and spiky, though in some of the pure-bred specimens it becomes occasionally large, coarse, and branched. Both sexes have the neck full and arched: that of the cock is clothed with a full ample hackle. The tail is furnished with abundant sickle feathers, the throat is fully muffled, the breast plump, the body square and compact; the legs closely feathered, and furnished with those accessory plumes which constitute what is known as vulture hocks.

“The legs, as old age approaches, are apt to get red, swollen, and inflamed, a fact that I attribute to the peculiarity of the spur growing in a curved form round the leg, the point generally growing in, and producing, in old age, considerable irritation. My old birds are all so, and the pure-bred young ones inherit this peculiarity. I have also noticed it in those specimens I have seen at shows, which looked like the pure strain.

“Sultans are abundant layers of moderate-sized eggs. As adults they are as hardy as any birds I know, with the exception of the tendency to cold, to which all crested birds are subject if unsheltered during rainy weather; but the chickens, from their rapid and early feathering, are difficult to rear, evidently suffering severely from the extra strain on their young constitutions. Sultans are small feeders: from their quick, lively, and eccentric ways, they make most interesting pets.

“In my own individual opinion they are unquestionably an original and pure breed, entirely distinct from any other crested breed I am acquainted with; the fifth toe and other characteristic peculiarities being transmitted in pure specimens with the greatest certainty.

“They have evidently been largely crossed with other varieties, thus producing the spurious breed formerly known as Ptarmigans; the small flat falling crest, exposed red face, absence of muffling, and slight shank-feathering, being abundant proofs of a deteriorating cross.

“At the same time, I believe that an infusion of fresh blood is much wanted; and I thought myself singularly fortunate when a friend described minutely a white-crested bird which a lady had had given her by the captain of a vessel from the Mediterranean, requesting to know the name of the breed. Evidently Sultan, I thought; and without much delay a negotiation for an exchange was entered into, which resulted in my receiving an exact counterpart of the old hens I had—direct descendants of the birds first imported by Miss Watts—and fully confirming her interesting account of the original introduction of the breed into this country. I have since bred many birds, and some of my finest specimens, from the hen in question.

“From what I see at the shows, I cannot but think pure Sultans are very scarce, and that many of the fowls so called are the result of modern attempts at their manufacture.

“I believe I have said all I have to say respecting this variety, with the exception that, like most crested birds, they are non-sitters.

“ I trust that others, besides myself, will exert themselves to keep the pure breed in existence ; for they are cheerful, lively, and prolific birds, an ornament to any aviary, and easily kept in confinement.”

A few years since, some very inferior specimens of Feather-legged White Polish were imported, and, under the name of Ptarmigan fowls, were exhibited at several of the poultry-shows. They attracted considerable attention at the time of their introduction ; but were so inferior in size of crest and in character of comb to the Sultans, that the latter have thrown them completely into the shade.

The Rumpless Polish, or Ghondooks, must be included amongst the varieties of crested fowls. These very remarkable birds were first introduced by Mr. Higgs, of Southampton, who exhibited a pen of Black Ghondooks, some few years since, when, from their extraordinary conformation, they attracted great attention. They were small Polish, with crests not fully developed, bearded, vulture-hocked, feather-legged, and perfectly rumpless, being totally destitute of that portion of the backbone which forms the framework of the tail. Their carriage was peculiarly upright and striking ; and altogether they were very remarkable fowls. Some purely white Ghondooks were subsequently imported, and passed into the possession of the Editor. By carefully crossing these birds with other crested fowls, the size of their crests was much improved, without losing their peculiar characteristics ; and in this mode a variety of well-crested Rumpless Polish was established some years since, when the White variety was very successfully exhibited by Mr. Tegetmeier, and the Black by Miss Bush, of Clifton.

But little more remains to be said on the subject of any of the numerous varieties of Polish. Their general management when chickens has already been alluded to in the articles of Messrs. Hewitt and Jones ; one precaution, however, may be suggested, viz. the desirability of removing the pipes or tubes of membrane which surround the feathers of the crest, when the latter have obtained their full length. In all the other feathers of the body this is accomplished by the fowl itself : but it is obvious the beak cannot be applied to the crest. By gently compressing each pipe between the thumb and finger nail, it is broken and removed, and the feather at once expands to its full dimensions. Care must be taken not to interfere with the feathers which have not attained their full growth, as they are, when immature, easily pulled out, to the serious injury of the crest.

The sexes of Polish are difficult to distinguish at an early age ; the first indication to be relied on consists in the form of the feathers of the crest. These are much more pointed in the cockerels than in the young pullets, and, to a practised eye, afford a ready means of distinction. As to their diseases, in damp situations they are liable to a chronic cold, apt to degenerate into roup ; and they are, if too closely bred, liable to tuberculous diseases and deformity of the spine, causing what is usually termed humpback. In these weakly bred specimens one hip is very liable to be higher than the other, and the birds also show a great tendency to become wry-tailed ; consequently it is important not to interbreed closely, as

either of these defects amounts to a total disqualification in the exhibition pen, and, moreover, they possess the serious disadvantage of being hereditary. Polish, unless supplied with a sand-bath, are subject to be infested with vermin of a large character, but which are readily destroyed by dusting flour of sulphur under the feathers; a common flour-dredger, or pepper-caster, being employed for the purpose.

CHAPTER XVIII.

THE FRENCH BREEDS :

HOUDANS, CREVECŒURS, LA FLECHE, LA BRESSE, GUELDRES, ETC.

THE rearing of poultry for the table has long been regarded as one of the staple industries of the French people. As a rule their market fowls are far superior to those of England, and are produced in much larger numbers. At the present time, we are importing no less than six millions of eggs per week from France, and purchasing them at a cheaper rate than they can be produced in our own country. These circumstances render it most desirable that we should ascertain what the conditions are under which our neighbours surpass us in profitable poultry-keeping.

Attention has recently been directed to poultry-keeping in France by the publication in this country of an account of a horse-feeding poultry establishment near Paris. This ridiculous hoax would not have been worth notice had it not been reproduced and commented upon by persons from whom better judgment might have been expected. The account was reprinted in many of our first-class periodicals—such as the *Gardener's Chronicle*, the *Mark Lane Express*, the various agricultural journals, &c. So high an authority as Mr. Cuthbert S. Johnston, F.R.S., published the following article respecting it, in the *Mark Lane Express*. Mr. Johnston states :—

“With care and good management, no branch of domestic industry is more profitable than rearing poultry. But then we must carefully attend to the precautions essential to secure success. Thus, many persons have supposed that what is profitable on a small scale might be made still more so when merely carried on to a larger extent; but repeated experiments in this and other countries have proved this to be a mistake. The secret of the matter is, that hens cannot thrive and lay without a considerable quantity of animal food. Where but a limited number of fowls are kept about the farm-yard, the natural supply of insects is sufficient to meet this demand; but when attempts have been made to extend the business beyond the source of supply, they have not prospered. It will be seen from the following interesting account, that M. de Sora, in France, has adopted a method that has proved completely successful, by affording an artificial supply of this essential portion of their food.

“The French practical philosophers certainly know how to make the most of things. Thus M. de Sora has the power of making hens lay every day in the year by feeding them on horseflesh. The fact that hens do not lay eggs

in winter as well as in summer is well known, and the simple reason appears to be that they do not get the supply of meat which they obtain in the warm season from worms and insects. M. de Sora was aware of these facts, and living at the time upon a dilapidated estate a few miles from Paris, the land having been bequeathed to him a few years previously, he set himself earnestly to the task of constructing a henary which should be productive twelve months in the year. He soon ascertained that a certain quantity of raw mincemeat, given regularly with other food, produced the desired result; and commencing with only some 300 fowls, he found that they averaged the first year some twenty-five dozen eggs in the 365 days. The past season he has wintered, thus far, about 100,000 hens, and a fair proportion of male birds, with a close approximation to the same results. During the spring, summer, and autumn, they have the range of the estate, but always under surveillance. In winter their apartments are kept at an agreeable temperature; and although they have mincemeat rations the year round, yet the quantity is much increased during the cold weather. They have free access to pure water, gravel, and sand, and their combs are always red. To supply this great consumption of meat, M. de Sora has availed himself of the superannuated and damaged horses which can always be gathered from the stables of Paris and the suburbs. The horses are taken to an *abattoir* owned by M. de Sora, and there neatly and scientifically slaughtered. The blood is saved clean and unmixed with offal. This is sold for the purposes of the arts, at a remunerative price. The skin goes to the tanner; the head, hoofs, shanks, &c., to the glue-maker and Prussian-blue manufacturer; the large bones make a cheap substitute for ivory with the button-maker; while the remainder of the osseous structure is manufactured into ivory black, or used in the shape of bone-dust for agricultural purposes. Even the marrow is preserved; and much of the now fashionable and highly-perfumed lip-salve and pomade was once enclosed in the leg-bones of old horses. Uses are also found for the entrails; and, in fact, no portion of the beast is wasted.

“The flesh is carefully dissected off the bones, and being cut into suitable proportions, it is run through a series of revolving knives, the apparatus being similar to a sausage machine of immense size, and is delivered in the shape of a homogeneous mass of mincemeat, highly seasoned, into casks, which are immediately headed up, and conveyed per railroad to the egg-plantation of M. de Sora.

“The consumption of horses for this purpose by M. de Sora has been at the rate of twenty-two per day for the last twelvemonths, and so economical are all his arrangements, that he is enabled to make a profit on the cost of the animals by the sale of the extraneous substances enumerated above—thus furnishing to himself the mincemeat for much less than nothing delivered at his henary. It has been ascertained that a slight addition of salt and ground pepper to the mass is beneficial to the fowls; yet M. de Sora does not depend upon these conditions alone to prevent putrefaction, but has his store-rooms so contrived as to be kept at a temperature just removed from the freezing-point through the year, so that

the mincemeat never becomes sour or offensive. The fowls eat it with avidity; they are ever in good condition, and they lay an egg almost daily in all weathers and in all seasons. The sheds, offices, and other buildings are built around a quadrangle, enclosing about twenty acres—the general feeding ground. This latter is subdivided by fences of open paling, so that only a limited number of fowls are allowed to herd together; and these are ranged into different apartments, according to their age, no bird being allowed to exceed the duration of four years of life. At the end of the fourth year they are placed in the fattening-coops for about three weeks, fed entirely on crushed grain, and then sent alive to the city of Paris.

“As one item alone in this immense business, it may be mentioned that in the months of September, October, and November last, M. de Sora sent nearly 1,000 dozens of capons to the metropolis. He never allows a hen to sit. The breeding-rooms are warmed by steam, and the heat is kept up with remarkable uniformity to that evolved by the fowl during the process of incubation, which is known to then mark higher on the thermometer than at any other period. A series of shelves, one above the other, form the nests, while blankets are spread over the eggs to exclude any accidental light. The hatched chicks are removed to the nursery every morning, and fresh eggs laid in to supply the place of empty shells. A constant succession of chickens is thus ensured, and, moreover, the feathers are free from vermin. M. de Sora permits the males and females to mingle freely at all seasons, and after a fair trial of all the various breeds, has cleared his establishment of every Shanghai and Cochin-China, breeding only from the old-fashioned barn-yard chanticleers. He contends that the extra size of the body and eggs pertaining to these foreign breeds can only be produced and sustained by extra food, while for capon-raising the flesh is neither so delicate nor juicy as that of the native breed. The manure produced in this French establishment is no small item, and since it forms the very best fertilizer for many descriptions of plants, it is eagerly sought for at very high prices by the market-gardeners in the vicinity. The proprietor estimates the yield of this year at about 100 cords. [A cord of wood in England is equal to 128 cubic feet.] He employs nearly 100 persons in different departments; three-fourths of whom, however, are females. The sale of eggs during the past winter has averaged about 40,000 dozen per week, at the rate of six dozen for four francs.

“These details are well worthy of our serious attention. That the demand for poultry and eggs in this country far exceeds the native supply is evinced by the large amount of poultry and foreign eggs annually supplied to us. In 1862, 235,230,860 eggs were imported. It does indeed seem probable that in certain of our localities, where animal food unfit for human consumption can be procured at a reasonable rate, we might profitably imitate the great establishments of M. de Sora. Has the effect of giving a considerable portion of fish in the food of poultry been ascertained? Why not devote the spoilt meat of London, and other populous places, which is now largely condemned as unfit for human food, to a

properly-regulated establishment of this kind? Thus would the poultry-yard restore to us, in the shape of wholesome food, what is now so often condemned by the inspector to the fire; and, moreover, if once a demand for the poultry-yard arose in this way, the temptation to consign spoilt meat to London would be diminished—the risk, now so dangerous to its owner and the consumer, avoided.”

Mr. Johnston says these details are worthy of our serious consideration. It is difficult to imagine how such a ridiculous statement could have received any consideration whatever without the absurdity of the hoax being at once apparent; and yet, to our own knowledge, it was generally credited, and persons made journeys from the United States, and even from Australia, expressly to learn the details of the mode of working adopted at this supposititious establishment. To any person having even a very slight practical acquaintance with poultry matters, such a statement as that the “300 fowls averaged the first year some twenty-five dozen, or 300 eggs, in the 365 days,” carries its own refutation. When we take into consideration the fact that a certain portion of the fowls must have been cocks, and that time must have been lost during the periods at which the hens were brooding and recovering from their annual moult, it is evident that during a considerable portion of the year the hens of these three hundred fowls must have laid two eggs a day each to make up this fabulous average. Again, the statement that the fowls are fattened for the market at the end of the fourth year, is one that could never have been reproduced by any person having any knowledge of the subject. A fowl of four years of age is beyond any ordinary power of mastication. The most convincing proof of the non-existence of this establishment is contained in the following extract from Mr. Geyelin’s pamphlet on poultry-keeping. Mr. Geyelin was formerly the manager of the National Poultry Company’s establishment at Bromley, Kent, and, in company with two of the directors, took a journey in search of M. de Sora’s establishment, the result of which we give in his own words. In his report to the Company he states—

“The primary object of the journey was to ascertain everything connected with poultry-breeding in France which might assist in promoting the success of our undertaking; also to inquire into the truth of numerous assertions in the public papers that there existed in the vicinity of Paris most extensive Gallinocultural establishments, which by their particular system of artificial incubation, rearing, and feeding poultry on horseflesh, realized, in one instance—viz., in that of M. de Sora—upwards of £40,000 per annum. I need scarcely say that, after the most searching investigation within a radius of forty miles of Paris, my opinion has been fully confirmed that such establishments do not nor can possibly exist; moreover, I can now firmly assert that there is not one establishment in existence within fifty miles of Paris where poultry-breeding is carried on otherwise than on the old farm system; in fact, as you will perceive hereafter, I have spared neither time nor expense in this inquiry; yet, although I have been unable to trace any-

thing like a system in poultry-breeding in France at all approaching to that we are about to carry out, it cannot be denied that I have obtained very valuable information, which will no doubt prove of great advantage to our Company; moreover, I observed such startling novelties connected with poultry-breeding in France, that I deemed it to the interest of our Society that at least two of the Directors should come there also, to enable them to corroborate this report, which otherwise might have borne the appearance of exaggeration in many respects, and perhaps have still left a doubt in the minds of many persons whether I really made all possible inquiries into the truth of the reported existence of Gallinocultural establishments in France.

“I will now briefly relate the steps I have taken to inquire into this matter. At the Jardin des Plantes of Paris, which corresponds to our Zoological Society in Regent’s Park, also at the Acclimation Society in the Bois de Boulogne, where the various breeds of poultry form an important object, the existence of any such Gallinocultural establishments in France was totally unknown, and they observed very justly that if any such really were to exist they would be the first to know of it. Next I called three consecutive market days at the wholesale poultry market, La Vallée, Paris, where all the poultry, dead or alive, forwarded from the various parts of France, is sold by auction, from 5 till 9 o’clock in the morning. Several agents and poulterers made inquiries for me of poultry merchants from the different parts of France, but with the same result. I made further inquiries at the dead poultry market at the Halles Centrales, also of a number of fancy poultry dealers, but all to no purpose. A few days later, on calling again at the Jardin d’Acclimation, Monsieur A. Geoffroy St. Hilaire, the director, told me that a friend of his had informed him that such an establishment really did exist at Mouy, near Beauvais in Picardie; and he gave me his card, and the following in writing, adding, however, that he did not believe in it, and that he should feel obliged by my communicating to him the result of my investigation:—

“‘On m’a affirmé qu’il existe à Mouy près de Beauvais un grand établissement de Gallinoculture—M. de Sora, si toutefois mes renseignements sont exacts, entretiendrait à Mouy (12,000) douze mille volailles, avec lesquels il approvisionne les marchés de Paris.’

“I then at once telegraphed the following:—‘De Sora, Mouy (expres), Beauvais. Avez vous un établissement de Gallinoculture? Réponse payée bureau restant.
‘GEYELIN.’

At the same time I posted a letter to the same effect and asking permission to visit the establishment. The reply to the telegram was—*not known*; the letter as yet has not been returned. But to make the inquiry triply sure, I started myself for Mouy; arrived at Reil Junction, I was informed that such an establishment really did exist at Mouy, and within half a mile of the railway station; which news delighted me—to know that my journey was not like a wild goose chase. Therefore, on arriving at Mouy, I proceeded at once to the poultry establish-

ment; but not to that of M. de Sora, whose name is not even known to any person in that neighbourhood, but of M. Manoury, *éleveur à Angy près Mouy*, to whom I briefly related the object of my call. I was received with every courtesy, and informed that he knew of no such name as M. de Sora, nor of any establishment of the kind, but that he devoted his time to rearing some 5,000 head of poultry per annum; he neither fed them on horseflesh nor supplied the markets of Paris; that he sold none but pure breeds, and those to gentlemen and fancy poultry dealers."

This extract may be considered as satisfactorily disposing of the question as to the existence or non-existence of M. de Sora's establishment. Mr. Geyelin's journey, however, was not without interest from other points of view. He describes in particular the manner in which turkeys are employed in France as foster parents for chicken. This plan has been introduced with some considerable degree of success into this country; and we have since seen a large number of chickens carefully protected by turkey cocks, confined under coops.

Mr. Geyelin writes:—

"Amongst some places I visited, in company with two of your shareholders, may be mentioned the farm of Madame La Marquise de la Briffe, *Chateau du Neuville, Gambais, near Houdan*, where we observed twelve turkeys hatching at the same time; here, also, we witnessed the rearing and fattening, which will be alluded to hereafter. In another place, that of M. Auché, of Gambais, a hatcher by trade, we observed some sixty turkeys hatching at the same time; and we were informed that during winter and early spring he had sometimes upwards of one hundred hatching at the same time, and that each turkey continued hatching for at least three months. At the farm of M. Louis Mary, at *St. Julien de Faucon, near Lizieux, in Calvados*, I saw a turkey that was then sitting that had been so upwards of six months, and, considering it rather cruel, the hatcher, to prove the contrary, took her off the nest and put her in the meadow, and also removed the eggs; the turkey, however, to my surprise, returned immediately to her nest and called in a most plaintive voice for her eggs. Then some eggs were placed in a corner of a box, which she instantly drew under her with her beak, and seemed quite delighted. Moreover, I was informed that it was of great economical advantage to employ turkeys to hatch, as they eat very little and get very fat in their state of confinement, and therefore fit for the market any day.

"The hatching-room is kept dark, and at an even temperature in summer and winter. In this room a number of boxes, two feet long, one foot wide, and one foot six inches deep, are ranged along the walls. These boxes are covered in with lattice or wire-work, and serve for turkeys to hatch any kind of eggs. Similar boxes, but of smaller dimensions, are provided for broody fowls. The bed of the boxes is formed of heather, straw, hay, or cocoa-fibres; and the number of eggs for turkeys to hatch is two dozen, and one dozen for hens.

"At any time of the year, turkeys, whether broody or not, are taught to hatch in

the following manner :—Some addled eggs are emptied, then filled with plaster of Paris, then placed into a nest ; after which a turkey is fetched from the yard and placed on the eggs, and covered over with lattice. For the first forty-eight hours she will endeavour to get out of her confinement, but soon becomes reconciled to it when fresh eggs are substituted for the plaster of Paris ones : they will then continue to hatch, without intermission, from three to six months, and even longer ; the chickens being withdrawn as soon as hatched, and fresh eggs substituted. After the third day the eggs are examined, and the clear eggs withdrawn,—which are then sold in the market for new-laid ; but, as they may be soiled or discoloured from having been sat upon, they clean them with water and silver-sand to restore their original whiteness.

“ The turkeys are taken off their nest once a day to feed and to remove their excrements from the nest ; but after a while they cease self-feeding, when it is necessary to cram them, and give them some water once a day.

“ In some parts of France, where poultry-breeding is carried on as a trade, they seldom allow a hen to lead the chickens after being hatched, as the hen is more valuable for laying eggs ; but they entrust this office either to capons or turkeys, who are said to be far better protectors to the chickens than a hen. They require, however, a certain amount of schooling preparatory to being entrusted with their charge, which consists in this : When a turkey has been hatching for some months and shows a disposition to leave off, a glassful of wine is given her in the evening, and a number of chickens are substituted for the eggs ; on waking in the morning she kindly takes to them, and leads them about, strutting amidst a troop of seventy to one hundred chickens with a dignity of a drum-major. When, however, a troop leader is required that has not been hatching, such as a capon or a turkey, then it is usual to pluck some of their feathers from the breasts, and to give them a glass of wine, and whilst in a state of inebriation to place some chickens under them ; on getting sober the next morning they feel that some sudden change has come over them, and as the denuded part is kept warm by the chickens they take also kindly to them.

“ In conclusion, I feel in justice bound to say, that these artificial living protectors are most efficient to shelter chickens in the day-time ; and in the evening they are placed with their charge in a shallow box filled with hay, from which they do not move till the door of the room is opened next morning. I must not omit to mention that the chickens are not entrusted to the mother or a leader before they are a week old, and then only in fine weather.”

The importance of poultry-keeping as a branch of rural economy in France did not need the absurd exaggeration of the De Sora hoax to call attention to the subject. In this country we have, perhaps, been too much in the habit of looking at poultry from a fancy point of view. If we set aside the awards in our Dorking classes, the prizes at the various poultry-shows have always been bestowed in accordance with the value of the fowls as ornamental, rather than as profitable

poultry. Prizes have rarely been offered for fowls simply as table poultry. It is therefore with much pleasure that we call attention to the following account of the show of fat poultry at Paris, which was instituted by the Minister of Agriculture, and held in December, 1864, in the *salons* in the *Palais de l'Industrie* at Paris. The exhibition was a great success; there were more than five hundred contributors, and between two and three thousand specimens of poultry, including fowls, turkeys, geese, and ducks, all killed, and ready for cooking. Nineteen departments were represented. The arrangements were admirable; sloping tables were placed around, and double stands of the same kind in the centre of each room. These were covered with blue paper, upon which the poultry was laid out with ample space on all sides, the various lots, each consisting of four specimens, being separated by fillets of wood, painted red, so that every article exhibited could be seen perfectly. On the walls were neatly-painted devices, containing the names of the classes and localities in which they were produced. The first day was devoted to making the necessary arrangements; the second, till one o'clock, to the decisions of the jury, after which the public were admitted at a charge of half a franc; and the third to exhibition and sale of the articles. The jury was composed of Count Leopold le Hon, president, representative in the Corps Législatif of the district La Bresse (in Burgundy), famous for its poultry; two inspectors-general of agriculture; four farmers, and four dealers in poultry. The sum of 4,000 francs was devoted to prizes, besides medals in gold, silver, and bronze. The grand prize consisted of a large gold medal and 1,000 francs. The awards were marked by means of oval cast-iron tablets, painted blue, with the raised letters picked out in gold colour. The fowls were divided into five classes—birds of the races of La Bresse, of La Fleche, of Houdan, of Normandy (better known in England as Creveœurs), and all other varieties. Medals and prizes in money were given in all the classes, both for capons and poulardes. The Bresse fowls were by far the most numerous, 600 lots being exhibited against 200 Houdans, 200 Normans, or Creveœurs, and 150 La Fleche. Gold, silver, and a number of bronze medals and honourable mentions were awarded in each class, and the grand *prix d'honneur* was awarded to M. Gorgondet, of Treffort, in the department of the Aix, for four pullets of the race of La Bresse. The other classes consisted of turkeys, ducks, geese, pigeons, Guinea fowls, and other poultry. The fowls of La Bresse were not so remarkable for size as for smallness of bone and plumpness; the manner in which they are prepared for market is quite artistic. Some of the geese were very good—truly gigantic; but the turkeys would not have borne comparison with those of Leadenhall market. The sale was very brisk, and the names of almost every celebrated gastronomic establishment in Paris were to be seen on tickets in all directions. Forty and fifty francs were asked and easily obtained for prize geese and turkeys; and fowls that had obtained medals were marked in the morning after the exhibition as high, if not higher, than thirty-six francs each.

The proceedings did not terminate with the award of the prizes; for at the





LEIGHTON, PROS.

H O U D A N E .





Agriculturists' dinner, held during the show, the discussion of the merits of the poultry was the chief topic, and the first agriculturists in France were called upon to decide practically on the comparative merits of two breeds—the La Bresse and the Crevecœurs. Fowls were discussed in every sense both during and after dinner. Their feeding, cost, age, and market price were enlarged upon by keen advocates, with a view to giving prominence to the peculiar merits of their respective favourites. The loss of weight occasioned by various modes of cookery came at last under discussion, and the questions mooted became too subtle and various to be decided without an adjourned meeting and more elaborate tests.

At the dinner held on the 26th of January, 1865, the discussion was renewed, and some Houdan breeders entered the lists against the Crevecœurs and the Bressians, the former competitors.

Five specimens were selected from each of the three rival breeds for special comparison, and were weighed before and after being prepared for the cook, and also when roasted.

The average weight of these fowls was as follows :—

	La Bresse.	Houdan.	Crevecœur.
	lb. oz.	lb. oz.	lb. oz.
Unprepared	6 12	5 4	4 11
Prepared for the cook	5 5½	4 3	3 14
Cooked	3 3¾	2 15¾	2 12½

Or, more precisely, the loss per cent. was as follows ;—

	La Bresse.	Houdan.	Crevecœur.
In preparing for cook	20·98	20·32	17·58
In cooking	40·68	28·83	28·42
Total loss per cent.	52·51	44·32	40·95

The Crevecœur chickens are stated by M. de Kergolay to have been younger than their rivals, and on that account to have lost less weight, since the fattening process had not been carried so far in their case.

The Houdan breed are also very precocious ; those hatched with the new year being ready for market by the middle of April, after three weeks of fattening on barley-meal moistened in milk, "bolted" three times a day without drink, the cost of food being 1s. to 1s. 3d.

M. de Lavergne, one of the highest French agricultural authorities, contributed to "Le Journal d'Agriculture Pratique" for January, 1865, a paper on "the Importance of Poultry in France." This valuable article was reproduced in the Journal of the Royal Agricultural Society of England, with other important documents, which were translated by Mr. Frere, from whose paper we have derived much valuable information on the subject of the present chapter.

M. de Lavergne states that in 1840 no notice was taken of poultry in the statistics of the empire ; in 1858 it was stated incidentally that the proceeds amounted to 88,000,000 francs (£3,500,000), derived half from poultry proper, and half from eggs and feathers,—an estimate much below the mark, as he proceeds to show.

With reference to eggs, there are existing accounts by which that estimate may

be approximately tested. First, the value of the export trade, 24,000,000 francs; secondly, the consumption at Paris, equivalent to 12,000,000 francs; in all, 36,000,000—leaving only 8,000,000 for all the rest of France, even if the feathers are quite left out of the account. Such an estimate is therefore quite inadmissible; for as the population of Paris is one-twentieth of that of all France, at Paris rates the total value would be 240,000,000 francs.

M. de Lavergne, however, admitting that the consumption per head in the provinces is less than at Paris, considers it may be fairly set at rather more than half as great; and that the eggs, which at Paris are worth 60 francs per 1,000, average 40 francs per 1,000 in the country. He thus obtains a total of 100,000,000 francs, or, with the export, 125,000,000, as the annual value of French eggs, and considers this estimate to be under the truth. As to the poultry, it is harder to generalize. That sold in Paris at 1 franc per lb. is choice and dear; in the country it is not so much in use, and cheaper. On the whole, he concludes that the poultry may, like the eggs, be valued at 125,000,000 francs (£5,000,000); a result sufficient to provoke further and more precise investigation, for his estimates only profess to be tentative and approximate. At this rate the consumption amounts to 5s. per head for the whole of the population.

For Paris a more exact account is kept, which exhibits very striking results. The value of the poultry and game together consumed in that city rose from £560,000 in 1852 to £800,000 in 1862; and that of the eggs from £246,000 to £480,000. It is estimated that there is about five times as much poultry as game consumed. The population of the capital had meanwhile increased by 300,000 souls. It is calculated that prior to 1789, the Parisians consumed annually 8 lb. per head of game and poultry, but, in 1862, 30 lb.—a very significant index of increased wealth and prosperity.

The next point for consideration is the distribution of this rural wealth, *i.e.*, which departments are most and which least noted for breeding fowls. It will be sufficient to state that of the twenty leading departments, eleven encircle and supply Paris; with these two other departments, Calvados and Eure-et-Loire, may perhaps best be classed; “Le Nord” and Pas de Calais have a large home consumption to meet; two departments supply Lyons; and the remaining five are in the valley of the Garonne, where both soil and climate are so favourable that chickens form part of the common food of the inhabitants. As a rule, the districts that grow buckwheat are famous for poultry; not so those which grow rye.

These statistical inquiries were followed up by a more detailed inquiry by M. Barral into the sale of the Houdan poultry in the department Seine-et-Oise. The official returns for the three districts which rear these fowls are as follow:—

		Poultry.	Eggs and Feathers.
		£	£
Arrondissement of Mantes	12,593	9,761
Arrondissement of Dreux	8,937	7,516
Arrondissement of Nogent	2,278	2,804
		£23,808	£20,081

or, in round numbers, the chickens sold may be valued at £24,000. But a pamphlet printed by M. Delafosse, *propriétaire d'Orval, Goussainville près Houdan*, estimates the value of the fat chickens sold in the three leading market-towns much higher. He states, that it is to be desired that the excellent and fine breed of Houdan poultry should be propagated in every other country, as it is in France where the poultry trade has taken such a development that it forms one of the principal sources of riches. A few statistics of this trade in the neighbourhood of Houdan will give a correct idea of its importance. At the markets of Houdan, Dreux, and Nogent-le-Soi, there are sold annually upwards of 6,000,000 fat poultry, namely:—

	Per Week.	Per Year.	Annual Value. £
Houdan (Chief Market in Mantès) ...	50,000 ...	1,920,000 ...	76,800
Dreux	50,000 ...	2,400,000 ...	96,000
Nogent-le-Soi	35,000 ...	1,680,000 ...	67,200
Totals	125,000	6,000,000	£240,000

a sum ten times as large as the official returns assign to the whole of the three "arrondissements." Of this sum, £136,000, according to M. Delafosse, is paid by the purveyors of Paris to three communes alone, in these proportions:—

	£
Goussainville	64,000
Saint Lubin de la Haye	60,000
Havelu	12,000
	£136,000

The remainder is drawn from other communes or purchased by poulterers of Versailles, St. Germain, &c. The inference drawn from the comparison of these two statements is, that M. de Lavergne is quite within the mark when he multiplies threefold the official return of the value of the poultry of France.

Having treated of the subject of French poultry generally, it is desirable that we should enter into an examination of the merits of the different breeds enumerated at the head of this chapter. We will commence with the Houdans.

In an article on the relative economical merits of the several varieties of French poultry which was published in *The Field*, it was stated:—"The Houdans may certainly be regarded as the Dorkings of France. Large, heavy, short-legged, five-toed fowls, with small, light bone, a remarkable absence of offal, and with irregularly speckled or mottled plumage, they strongly recall to mind the old-fashioned coloured Dorking, as it existed before any attention had been directed to uniformity of feathering by the poultry shows. Their merits as table fowl are of the highest excellence. No pure-bred chickens mature with greater, or perhaps with as great a degree of rapidity; they feather early, are extremely hardy, and are consequently easily reared. The old birds are robust, and the eggs, which are numerous, are remarkable as being almost invariably fertile. There can be no doubt of the economic value of this race, more especially for table purposes."

The accompanying woodcut, taken from the birds which obtained the first prize at Paris in 1865, and which afterwards passed into the possession of the National Poultry Company, shows the characteristics of this breed, which is thus described in Mr. Geyelin's pamphlet:—

“Whatever has been said to the contrary, this breed, when pure, is most characteristic; but it must be admitted that most of the farmers near Houdan know as little of the pure Houdan breed as those of La Fleche and Crevecoeur know of theirs; and if you were to order some first-class birds of them, irrespective of price, they would with good conscience forward fowls of a large size—but, from a want of knowledge, some cross breeds. To illustrate this, I may mention that I could have purchased at the markets in those respective localities splendid thorough-bred specimens for about three shillings, the price of common fowls,—but which were worth in France even one pound each. There are, however, in each locality some persons who take an interest in their pure breeds, particularly since they have been encouraged by the reward of prizes from poultry exhibitions.

“The Houdan fowl has a very bulky appearance, its plumage invariably black and white spangled; a crest of the same colour; comb triple, the outsides opening like two leaves of a book, and the centre having the appearance of an ill-shaped long strawberry. With the cock the comb is very large, whilst with the hen it ought to be scarcely perceptible. The legs are strong and of a lead colour, with five claws, the two hind ones one above the other. Strongly developed whiskers and beards both in cocks and hens. This is one of the finest races of fowls, but its qualities surpass even its beauty; besides the smallness of their bones, the fineness of their flesh, they are of an extraordinary precocity and fecundity; they lay large and white eggs, and the chickens are fit for the table at four months old. It is, however, observed that they are very indifferent for hatching. The weight of adults is from seven to eight pounds, in which the bones figure for one-eighth. The chickens, when four months old, weigh, without the intestines, about four-and-a-half pounds.”

Little more remains to be said respecting the appearance and merits of this breed. It is obvious that in a variety which is essentially valuable as supplying fowls for the table, compact heavy bodies, short legs, absence of offal, hardihood, and early maturity are of much greater importance than any peculiar arrangement of colour and marking. In fact, the disposition of the colour has hardly been attended to by the French breeders. Some of the hens are very dark; others, on the contrary, but slightly speckled with black; and even the size of the feathered crests varies very greatly in different specimens. Should the Houdans ever become as fashionable in this country as their merits deserve, the points that would be looked for by the judges in a show-pen will be mainly, size, and compactness of form; uniformity of marking in the pen; well-developed crests, particularly in the hens; and in the cocks the crescentic lobed comb with its central mass. As there is a strong feeling in England in favour of the additional toe in the Dorking fowl, we



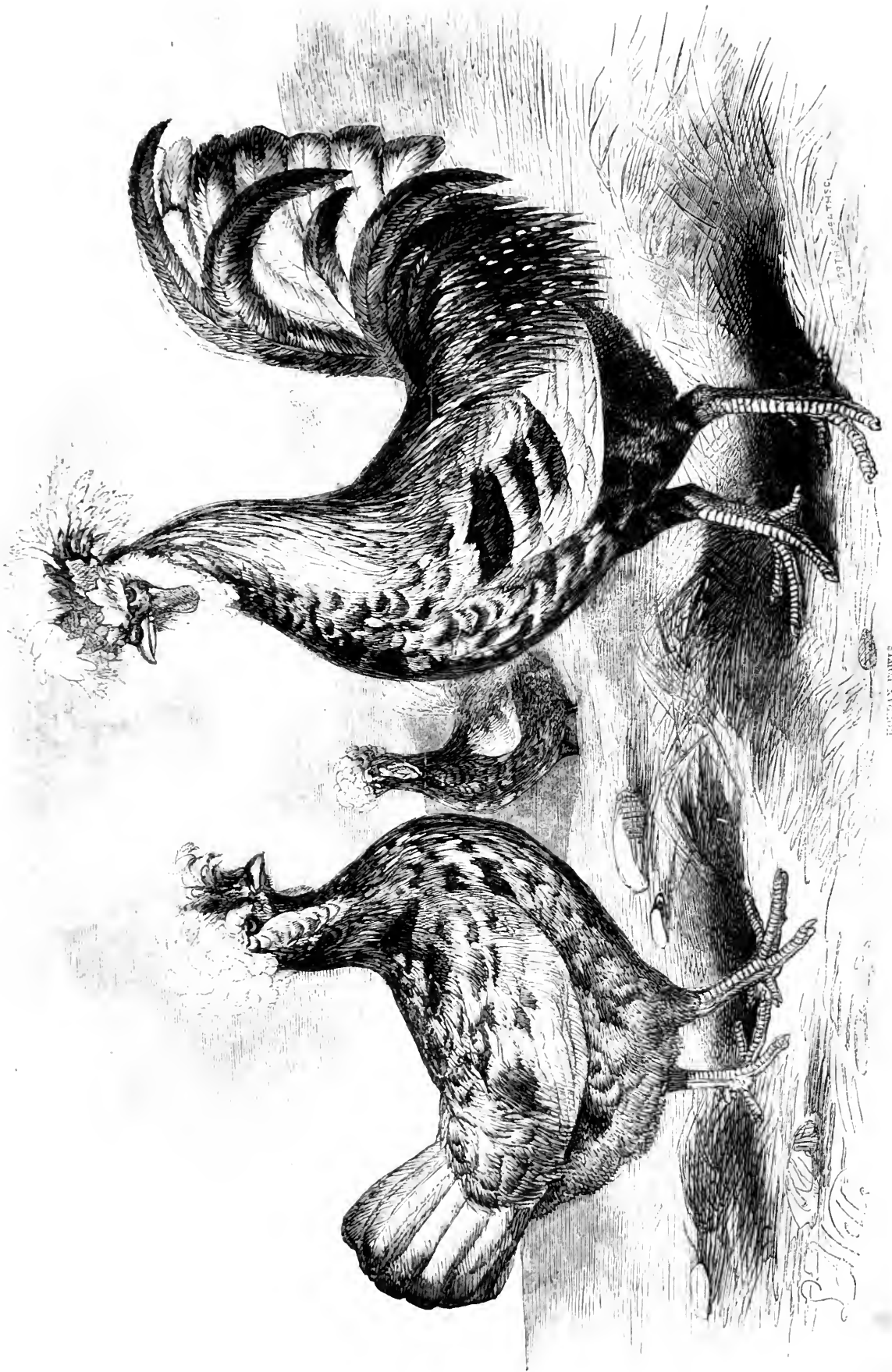

ROSEAN FOWLS

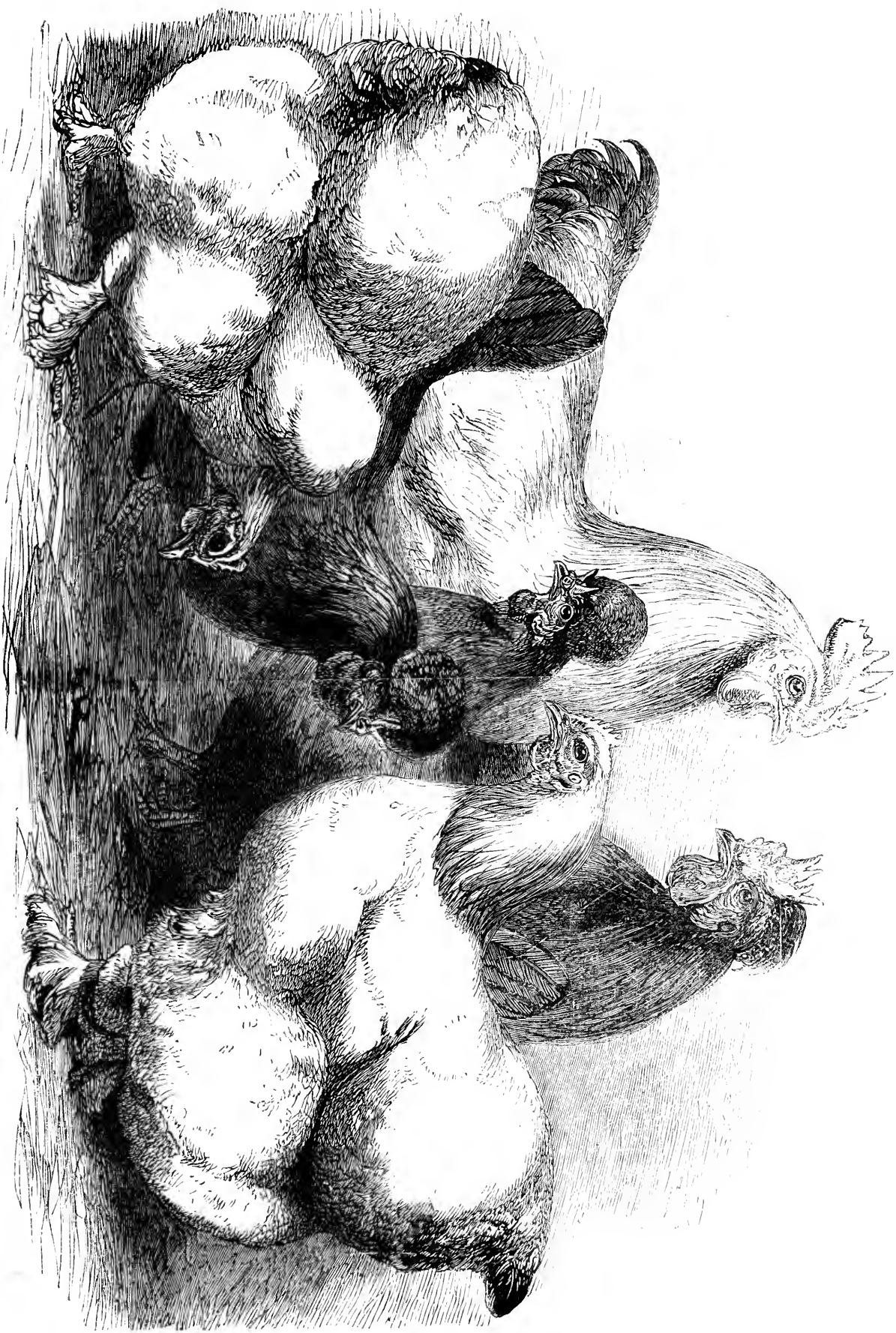



may suppose that this useless appendage will be regarded as equally indispensable in the Houdan.

The popular prejudice in favour of stoutness of bone in the shank or leg, we hope, will not influence the breed. Dorking breeders are continually boasting of the thickness of the leg-bones in their fowls. The French breeders, on the other hand, are, with much more sense, in the habit of calling attention to the small bones of the best breeds. If a Dorking farmer is asked why he likes thick legs in his birds, he replies that "you must have large bones to get a large frame," confounding stoutness of bone with size of frame-work; whereas the two things have no connection whatever. No grazier would tolerate a thick leg in a short-horn, however large its frame; but would regard the extra weight of bone as so much offal, as the French breeder justly regards it in his favourite table-fowls.

The Houdan chickens are very pretty when in the down and first plumage. The neck, back, and wings are black; the breast and under parts white. From the very first they are lively, hardy, little things; feathering very early and maturing with a marvellous rapidity.

There can be little doubt that the merits of the breed will ensure for it a favourable reception in this country.

Next in our list follow the celebrated Normandy table-fowls known as the Creve-cœurs. Some idea of the value attached to this breed by our French neighbours, may be gained from a statement of the fact, that at the first great Agricultural Exhibition in Paris, in 1855, there were two equal sets of prizes offered for the poultry exhibited; the first for Creve-cœurs, the second for all other varieties taken together. As Creve-cœurs are essentially French fowls, it will perhaps be desirable in the first instance to give the description of them published in the work termed "*Oiseaux de Basse Cour*," by Mme. Millet Robinet. The authoress of this book, which was issued under the authority of the Minister of Agriculture, states:—

"In Normandy, especially in the neighbourhood of Creve-cœur, there is a variety of fowl which supplies Paris with a large proportion of the handsome poultry with which the markets abound.

"The hens are low on the legs, with large fleshy thighs, the wings large, and the body square; the abdomen is voluminous and pendent, especially in those which are more than a year old; they walk slowly, scratch but little, and rarely fly. Their plumage is black, or black and white variegated: they carry on their heads a large tuft, and a small upright two-horned comb; whilst a large cravat of feathers under the neck gives to them a matronly air. They are very tame, ramble but little, and prefer seeking their food on the dunghill in the poultry-yard to wandering afar off. They are somewhat later in laying, and, perhaps, lay less frequently than the common (French) fowl; but their eggs are much larger, and they continue to lay a longer time. They sit badly, and are apt to break their eggs from their great weight, which is, at least, one-third more than that of the common fowls: they are very easily fattened.

“The cocks, which are similar in form to the hens, have a brilliant black plumage, sometimes golden or silver-coloured; their heads are handsomely surmounted with beautiful tufts, and large, toothed, two-horned combs, which, together, form a kind of crown; they have also dense cravats of feathers, and are adorned with handsome pendent wattles.”

The finest capons of this breed, when fattened for the table, are described by the same authoress as weighing four kilogrammes, or rather more than nine pounds English weight.

The Crevecœurs have been much longer known in this country than the Houdans. Their black plumage, large crests, and two-horned combs render them very conspicuous, if not elegant fowls. Their characters are most admirably given in the coloured illustration of a group, drawn by Harrison Weir. Like the Houdans, they are heavy, short-legged, compact fowls, but their shanks are much darker in colour and four-toed. They lay large eggs, and as a rule do not sit. There is no doubt of their value as table fowl, but in this country they certainly are not as hardy as the Houdan breed, nor are the chickens hatched and reared with such facility, being more affected by cold damp weather than any other of the French breeds. In favourable localities they mature very rapidly, and, under the general title of Normandy fowls, furnish a very large proportion of the first-class poultry that appears in the markets of Paris.

As exhibition fowls, it is desirable that they should be heavy, compact, as free from light feathers as possible, well crested, and with the two-horned crescentic comb well developed.

There is a variety of this breed of a slaty blue colour; but those that we have seen have not been equal either in appearance or weight to the darker variety.

Both Houdans and Crevecœurs offer great advantages for cross-breeding for the table. Large Dorking hens running with imported cocks produce, in the early spring, chickens that for size, hardihood, early maturity, and fitness for the market, surpass those of any pure breed that we have ever raised.

It may be well to state that some of the French writers estimate the value of the Crevecœurs as even greater than that of the Houdans. Thus M. Jacque states—

“This breed produces some of the best fowls which appear in the French markets. Its bones are even lighter than those of the Houdan; its flesh is finer, shorter, whiter, and more readily takes on fat. The pullets are of extraordinary precocity, since they may be put up to fatten at the age of three months, and they are ready for the table in fifteen days after. At four months old a fowl of this breed has reached its full perfection as to weight and quality. A poularde of five or six months attains the weight of six-and-a-half pounds when fattened, and weighs four-and-a-half pounds dressed for the cook. It is this race which produces the fine poulardes and capons sold in the markets of France. Those of the Houdan race, although of superior quality, come after them. The Crevecœur is the first race in France for delicacy of flesh, ease of fattening, and precocity; and we

believe that it is the first in the world in these respects. It is one of the best for crossing.

“The hen produces large eggs, and is an excellent layer, but scarcely ever sits; and the eggs must therefore be hatched by other fowls. In many parts of France turkey-hens are made use of for this purpose, as they can be taught to sit almost at any time.”

Our own experience would not lead us to form quite so high an estimate of their merits as M. Jacque has done.

The third variety on our list, the La Fleche, are a tall, handsome breed, so close and hard-feathered that they are much heavier than they appear to the eye. They are capital layers of large eggs, and heavy fowls for the spit; but when plucked their long legs and black shanks are against their value as market fowls, at least in England, where there is a prejudice in favour of white legs in table poultry. They stand very much in the same relation to the Houdans that the old-fashioned large Spanish fowl does to the coloured Dorking.

Mr. Geyelin writes as follows respecting them:—

“In appearance the La Fleche somewhat resemble the Spanish; the plumage, which is jet black, fits close to the body, and gives an idea of less bulk than those of Houdan and Creveccœur, although they actually are heavier fowls.

“In the markets, on account of the exquisite flavour of the flesh, they fetch fabulous prices; at the time I was at La Fleche, the beginning of July, the fat chickens sold at five shillings each. Their skin is white, fine, transparent, and very elastic, which enables them to take an extraordinary amount of fat. The weight of the full-grown birds is from eight to ten pounds, and the bones less than one-eighth of the weight; when standing erect they measure twenty-two inches in height, and twenty-three inches in circumference, taken from under the wings. The legs are four-clawed, of a lead colour, the comb two-horned, the face white, like the Spanish; they lay abundantly early in the year, but as sitters they are as bad as the Spanish.”

In this country they have been known for a few years, and have been frequently exhibited at the poultry shows, where large close-feathered specimens, with good white ear-lobes, pure black plumage, and well-marked two-horned combs, have rarely failed in taking prizes. Some of the birds exhibited have shown small crests; but these have not met with favour in the eyes of the judges. As far as regards their value as table fowls, and the method of fattening them for the French markets, we must refer to the following account of twenty years' experience in rearing birds of this breed by Mdlle. Millet Robinet, the author of “Oiseaux de Basse Cour” (Paris, Dusacq), a work from which we have previously quoted, and a high authority on the subject:—

Mdlle. Robinet states, the poularde to be fattened should be five or six months old, and should not have laid; the flesh under the wings should be very white; the eyes under the lids should be red; the claws should be short, the rump and

shoulders large ; it should be in good condition when put up to fatten." Mille. Robinet considers cramming the most effectual and economical means of fattening. This requires the use of coops, in which each fowl has its own compartment. The coop is a long narrow wooden box, set on short legs : the outer walls and partitions are close boarded, and the bottom is made with rounded spars $1\frac{1}{2}$ in. in diameter, running lengthways of the coop : on these spars the fowls perch, their dung falling through the bars. The top consists of a sliding door, nearly as wide as the compartment, by which the chickens are taken in or out. The partitions are eight inches apart, so that the fowl cannot turn itself round. The length of each box may be regulated by circumstances, care being taken that the attendant has room to pass along and to sit down ; and furthermore, that cocks, capons, and pullets, or the lean and the fat lots, be not mixed up indiscriminately. Fowls of different degrees of fatness should not inhabit the same box, because their rations will differ, and the new comers will disturb the older settlers by their noise.

Young cocks will fatten, though not so readily as capons ; their flesh is somewhat inferior in delicacy to that of capons, and more so than that of the poulardes.

The floor below the boxes is covered with ashes, or dry earth, to catch the droppings, which are removed every two days with a scraper. The dung is equal in value to guano, and should be preserved from waste and moisture in old casks.

The food for fattening fowls in France is chiefly buckwheat meal, bolted quite fine. This is kneaded up with sweet milk till it gets the consistency of baker's dough ; it is then cut up into rations about the size of two eggs, which are made up into rolls about the thickness of a woman's finger, but varying with the sizes of the fowls ; these are subdivided by a sloping cut into "pâtous," or pellets, about two-and-a-half inches long.

A board is used for mixing the flour with the milk, which in winter should be lukewarm. It is poured into a hole made in the heap of flour, and mixed up little by little with a wooden spoon so long as it is taken up ; the dough is then kneaded by the hands till it no longer adheres to them.

Some say that oatmeal, or even barley-meal, is a good substitute for buckwheat-meal ; but Mille. Millet Robinet is not of that opinion. Indian corn may do, but it is dear, and makes a short crumbly paste, unless mixed with buckwheat, when it answers well if cheap enough ; but buckwheat is a hardy plant, which may be grown anywhere at small cost.

The food is thus administered :—The attendant puts on an apron which will stand being soiled or torn, and having the pellets at hand with a bowl of clear water ; she takes the first fowl from its cage gently and carefully, not by the wings or the legs, but with both hands under the breast ; she then seats herself with the fowl upon her knees, putting its rump under her left arm, by which she supports it ; the left hand then opens its mouth (a little practice makes this very easy), and the right hand takes up a pellet, soaks it well in the water (this is essential), shakes it on its way to the open mouth, puts it straight down, and





J. D. HUNTER, BROS.

LA FÉLIX

carefully crams it with the forefinger well into the gullet ; when it is so far settled down that the fowl cannot eject it, she presses it down with thumb and forefinger into the crop, taking care not to fracture the pellet.

Other pellets follow the first, till the feeding is finished, in less time than one would imagine. It sometimes happens in cramming, that the trachea is pressed together with the gullet ; this causes the fowl to cough, but it is not of any serious consequence, and with a little care is easily avoided. The fowl when fed is again held with both hands under its breast, and replaced in its cage without fluttering ; and so on with each fowl.

The chicken should have two meals in twenty-four hours, twelve hours apart, provided with the utmost punctuality ; if it has to wait it becomes uneasy, if fed too soon it has an indigestion, and in either case loses weight. On the first day of cramming only a few pellets are given at each meal ; the allowance being gradually increased till it reaches twelve to fifteen pellets. The crop may be filled, but at each meal you must make sure that the last is duly digested, which is easily ascertained by gentle handling. If there be any food in it, digestion has not gone on properly ; the fowl must miss a meal, and have rather a smaller allowance next time ; if too much food be forced upon the animal at first, it will get out of health and have to be set at liberty.

The fattening process ought to be complete in two or three weeks, but for extra fat poultry twenty-five or twenty-six days are required ; with good management you may go on for thirty days ; after this the creature becomes choked with accumulated fat, wastes away, and dies.

When a fowl is to be killed, it should first be fasted for twelve to fifteen hours, and then held carefully, the mouth opened, and the pointed blade of a knife thrust into the palate till it pierces the brain ; or a few feathers may be plucked from the side of the head, just below the ear, and a deep incision made at the spot. In any case it must be fastened up by the heels immediately afterwards, that it may bleed freely, for on this the whiteness of the flesh depends ; but during its struggles it should be held by the head.

After drawing and trussing, the chicken is bandaged, until cold, to mould its form ; and if the weather is warm it is plunged for a short time into very cold water. A fowl takes usually rather more than a peck of buckwheat to fatten it. The fat of fowls so managed is of a dull white colour ; their flesh is as it were seen through a transparent, delicate skin.

At the Paris fat poultry show, the four young La Fleche cocks, to which the prize was given, averaged eleven pounds (English) each, and sold at from 20s. to 24s. each.

We have now to enter upon the consideration of the fowls reared in the district of La Bresse, in the north-eastern portion of France. The fowls from this tract of country are well known in the Paris markets, and at the exhibition of fat poultry took the greatest number of prizes. It is rather difficult to account for this fact, for they are certainly smaller birds than either of the three varieties first named.

It must, in fact, have been due to their being more carefully fattened with buckwheat meal and milk than their competitors. The National Poultry Company, which has paid much attention to these French breeds, has imported a number of the La Bresse fowls; but they are very inferior to the other French varieties in its possession. In fact, the La Bresse appear to have no special characters whatever, but look like ordinary single-combed, speckle-feathered, farmyard fowls. As stated before, their triumph at the fat poultry show must have been owing to their being very highly fattened—a conclusion which is supported by the fact that in cooking they lost more than the other breeds.

M. Dubose, a strong advocate for the La Bresse fowls, has written the following account of the district and its poultry; this was translated by Mr. Frere, and appeared in the *Journal of the Royal Agricultural Society*, from which we extract it:

“La Bresse, which now constitutes the ‘arrondissement’ of Bourg in the department of Ain, extends from the banks of the Saône eastward to the spurs of the Jura, and consists of three very distinct districts. The western district joining the Saône is populous (having 97 inhabitants to 100 acres); the lands, which mostly belong to the occupiers, are worth from £80 to £100 per acre, more than half being in excellent pasture, and much stock is kept; in the district on the extreme east, adjoining the mountains, the population (23 to 100 acres) is alert, hard-working, and frugal, but hardly live at ease; there are 100 acres of arable to 22 of meadow, for which the vineyards are but a poor substitute; much of the land is still waste.

“The central region (which includes the towns of Bourg and Coligny) is in most respects midway between the other two; most of the soil is reclaimed or on the point of being so, and the rents (now 24s. to 32s. per acre) have doubled since the old French Revolution. No region has had greater difficulties to surmount than this; none has combated them more vigorously.

“The land was flat and impermeable, destitute of lime, covered with stagnant pools of water, and the roads were proverbially bad. To get rid of the water, the arable fields have, with incalculable toil and perseverance, been raised at the middle so as to slope to the four borders, and intersected by a network of open drains at right angles one to the other. Leases some centuries old contain covenants that the farmer shall cart 2,000 to 3,000 cartloads of earth yearly. The work seems to have been completed in the early part of the eighteenth century. After this, beds of marl were found and applied generally to the land; since 1836 the roads have been set to rights.

“Alternate husbandry with crops of roots and clover followed, stolen green crops being obtained. One peculiarity that attracted the special attention of M. de Lavergne was, that the growth of maize is combined with that of buckwheat.

“By the end of the eighteenth century the district had established its reputation for capons and poulardes: about the same time the growth of maize became general, for consumption by oxen and pigs as well as poultry.

“The rearing of fowls in La Bresse is one of the staple occupations of the

locality; but it is not carried on in large establishments, experience proving that the collection of large numbers of poultry in one place invariably gives rise to epidemics amongst them. The Bresse race is not, however, so pure as some others, the delicacy of the meat and the rapidity of the fattening being supposed to depend principally on soil and the mode of feeding. The Bresse pullet can be fattened at the age of three months, while those of other localities are not got ready for market until a much later period.

“The fowls of La Bresse have certain features which clearly distinguish them from other breeds of the neighbourhood. They are above the average size, short legged, small boned, the plumage white, with some few spots of grey. The comb is single, straight, and indented. They have four toes on the leg, which is brown and smooth; the skin is fine, and the flesh delicate and savoury.

“The hens begin to lay in February, and for a month or six weeks lay daily, then three or four times a week, until they have laid about 160 eggs, besides rearing two or three broods.

“The cocks are changed continually, local experience confirming the general opinion that the produce of young males fatten the most speedily.

“The first broods come off in March; the earliest chickens appear at market at the beginning of May: they then, at two months old, weigh 2 lb., and sell for 2 to $2\frac{1}{4}$ francs.

“The chickens when young are fed on a paste made of skim-milk, bran, and potatoes, boiled and mashed; when older they have tail corn or buckwheat. The ‘pillettes’ which are to become poulardes are put into the coop at the age of three to three and a half months; the capons at four months. In the extreme cold of winter the fattening process occupies three or four weeks longer than at other times.

“A fat poularde of La Bresse at four or five months weighs 6 lb., a capon six months old 8 lb. to 10 lb.

“The fattening goes on in a closed and dark chamber; each fowl has a small box allotted to it, and is kept almost motionless. The food given is a mixture of the meal of white maize and of buckwheat, moistened with skim-milk. The poultry-woman takes the bird between her knees, opens the beak with her left hand, and inserts a pellet with her right. After three or four weeks of fattening they are killed by bleeding them at the palate:* they are carefully plucked at once, and then wrapped in a piece of fine linen steeped in milk, and fastened on with a piece of string: this is kept on until they are sold. To produce a fine poularde takes about five gallons of meal.

“Their whiteness, fine grain, and rounded form, cause them to be in great demand. The best specimens are bought by purveyors, who forward them to various parts of France, Germany, Switzerland, and Italy. The home markets have a

* *Query*—By thrusting a sharp-pointed knife through the back of the roof of the mouth into the brain, there being no large vessel in the roof of the mouth.—ED. POULTRY BOOK.

weekly supply of some thousands throughout the winter, weighing from 2 lb. to 6 lb. apiece. Several communes realize more than £80 per week for four or five months for their poultry. The price varies with the season, being highest about New Year's Day, especially if the weather is cold, and admits of carriage to a distance.

“The general run of prices at Bourg Market is—

			<i>s.</i>	<i>d.</i>		<i>s.</i>	<i>d.</i>
For fowls, half-fat, weighing 3 lb.	...		2	6	to	3	4
” ” 4 lb.	...		4	0	„	5	0
Choice specimens :—							
Poulardes, 6 lb. (nett)	7	0	„	8	0
Capons, 8 lb.	8	0	„	10	0
” 10 lb.	12	0	„	14	6

“Very choice capons sometimes make as much as £1 apiece. During the last twenty years the price has not varied materially, but the sale has at least tripled.

“On every farm poultry is fatted to a certain extent, but the trade in choice specimens is, in some measure, confined to small proprietors or farmers in certain communes on the borders of La Bresse and Revormont. One of these ‘*Chambriers*’ will sell between September and March 200 to 300 fowls, half-fat, or prime-fat specimens, making of his poultry alone from £3 to nearly £5 per acre of his occupation.

“All do not succeed alike, even when favourably circumstanced, for certain families and farms enjoy a special reputation; but success generally depends on having the breed quite pure. Cross-breeding has been tried at various times, to increase the size or improve the quality of the race, but these attempts proved failures. When a cross with the far-famed Cochins was tried there was a gain in size, but a loss in delicacy and flavour, so that this cross is now quite interdicted. Any fowl that shows the least sign of cross-breeding by a yellow tinge, or even by having yellow scales on the legs, loses at once one-fifth or one-sixth of its value at market. These attempts have served at least to establish the value of the breed, and the importance of maintaining its purity.

“In short, their delicate mould, early maturity, and readiness to fatten, make them the short-horns of the poultry-yard, with this advantage over their bovine rivals—that the quality of the flesh is first-rate, as various renowned epicures have testified. Until lately the poultry of La Bresse was little known or appreciated at Paris, though for forty years it has been exported to St. Petersburg.

“The breed is hardy, and will adapt itself to all parts of France. But the fattening trade is not so accommodating. To insure success not only the pure breed and the proper food (white maize and buckwheat) must be procured, but the skill and the habits handed down from one generation to another among the farmers of La Bresse must be naturalized and followed up.”

In reading this account of the habits of the fowls of the district of La Bresse,

we conceive that it is necessary to make very considerable allowance for the patriotic enthusiasm of M. Dubosc. Doubtless the fowls so carefully fattened are admirable specimens of table poultry; but thus treated, almost any small-boned white-skinned variety would be equally good. The birds themselves are much smaller than either the Houdans, Crevecœurs, or La Fleche, and offer no more evidence of being a pure breed than the ordinary mongrels of a farmyard, where purity of race is not at all regarded. If any enterprising Bressian agriculturist were to import a few good Dorkings to cross with the native stock, he would achieve a success that would place him far in advance of all his competitors.

For determining the relative value of the different breeds of French fowls on this side of the Channel, we have much pleasure in availing ourselves of the knowledge of Mr. F. W. Zurhorst, the Honorary Secretary of the Poultry Club, a breeder of great practical experience, who has reared most of the French varieties. Mr. Zurhorst writes as follows:—

“In giving my experience and opinion on the characteristics and merits of the French breeds, it must be borne in mind that I do not pretend to a lengthened acquaintance with them, but during the two or three seasons I have kept them, I have bestowed much careful attention on their comparative merits, and if my opinions differ from those of persons who have had longer to do with them, they must simply be taken for their worth.

“I will begin with the breed I have been longest acquainted with, viz. Crevecœurs. Mr. Harrison Weir has so happily caught the characteristics, and what I may call the expression, of these birds, that little need be said on that subject. They certainly are very handsome; I cannot wonder at our judges giving a preference to the perfect, intense glossy black, only to be met with in rare specimens, over the red or straw-coloured mixed hackle and saddle, which invariably distinguish the larger birds; but at the same time, on economical grounds, I would deprecate their being so judged, as they are large, compact birds, delicate in their flesh, and if the leading points denoting purity of race be present, viz. crest, comb, and shape, size should be the test of merit, and colour ignored.

“Crevecœurs are lively in their temperament, but in this climate by no means prolific, and I find it is almost useless to set their eggs before April.

“They are delicate in constitution, and as a pure breed these characteristics must place them in the second rank of French fowls in economical value. They will unquestionably deteriorate if bred for colour, but at the same time will always be cultivated for their handsome and original appearance.

“My next experience is with Houdans, and I do not hesitate to commence with the broad assertion that they are by far the most valuable breed that has been added to our collection for many years.

“Unusual fertility (I never knew an egg fairly set to miss), very early maturity, extreme hardiness, both as adults and chickens, together with a large, compact Dorking body, with little offal, white flesh, and legs only slightly shaded, are the leading characteristics of the breed.

“Abundant layers of moderate-sized eggs, they in this point far excel the Crevecœurs, which are only moderate in this respect, and their broken plumage of black and white, handsome crests, and branching coral combs, make them fully their equals in point of beauty. My chickens of this year are the object of admiration, for their size and beauty, to all visitors to the yard, and I am quite jealous of the new comers putting my old favourite Sultans and White Cochins so much in the shade.

“As a cross with our common breeds, they are of inestimable value, not only from the certainty of the introduction of thoroughly alien blood, but also from the valuable characteristics I have named.

“The abominable fifth claw, which I suppose must be insisted on as a mark of purity of breed, is by no means a certainty, as many chickens come four-clawed, and it would not be difficult to breed it out, but I must say, as far as my observation extends, it has not in this breed the detrimental effect it has on our highly-bred Dorkings, much of whose tendency to disease of the foot and claw I attribute to this monstrosity.

“By careful attention to breeding for size, and avoidance of inter-breeding, I feel sure this variety will ere long surpass our far-famed Dorkings, whose increasing delicacy of constitution fits them only for certain favoured climates and soils, and materially lessens their utility.

“Now, for the La Fleche—long, weird, hobgoblin-looking birds, prolific layers of tremendous eggs of moderate fertility; large and turkey-like, they are far superior to Spanish as table birds, and fully equal them as layers.

“They are less hardy than Houdans, and their chickens much more difficult to rear, being like the Crevecœurs, subject to throat attacks. They are liable not only to the disease known as gapes, but also to inflammation of the windpipe, accompanied by mucous deposit, producing what is familiarly known as “the rattles.” The specimens we see in the show-pens are invariably jet or brown-black; but I find the chickens are by no means true to this colour, for in the blackest, white feathers appear on the wings, and many come with chestnut and grey wings and breasts. I would warn those who must have them black, not to breed from brown-black hens, but from jet-blacks.

“The adult cocks, as might be supposed from their length of limb, and size of body, are much subject in this climate to leg-weakness and disease of the knee-joint, and suffer much from travelling to and from shows.

“In the foregoing remarks I have treated these breeds from an economical point of view, not as exhibition birds; and I believe the best interests of the community will be served by making all points subservient to size, health, and condition.

“In Crevecœurs I should look for size, handsome antler-like comb, full pendulous wattles, full crest, squareness and fulness of body, and sound health and condition; plumage black, mixed with straw or red, or all black indifferently, full rich hackle, and well sickled tail.

“In Houdans I want size, with compact bodies, broad breasts, legs as light as possible in colour, five claws, plumage similar to that of the Crevecœurs, but broken black and white; brisk lively carriage, and sound health and condition.

“In La Fleche I look for size, large long bodies, long snaky necks, large evenly double-spiked combs, utter absence of crest, long pendulous wattles, and white deaf-ears, shanks long and dark in colour, tail jet-black and rather small. This breed differs materially in the shape of the head from any of the others, it being long and Malay-like, inducing a suspicion that that old standard variety had at some time or other something to do with the foundation of this new breed.

“That these three breeds all come true to points, if not to colour, is sufficient to establish them as separate and notable varieties, though it is not difficult to trace in all of them the characteristics of some of our old-established, pure breeds.

“Of the La Bresse, Guelders, and other French breeds, I know nothing; but I do not hesitate to pronounce those I have mentioned on the present occasion as valuable acquisitions, and I give my verdict for the Houdans, as by far the best. I should have mentioned that they are all heavy feeders, but the Crevecœur and La Fleche astoundingly so for their size; a Crevecœur in full health will eat as much or more than a Buff Cochin.”

There remains for our consideration the continental breed, known as Gueldres or Guelders. These birds, though not much known in this country, have been long described in the American works on poultry, in which they are termed Guelderlands, after the province of Holland of that name, lying south of the Zuyder Zee, whence they are said to have been obtained.

Guelders are birds of medium size, with very full, prominent breasts, and large flowing tails. Their most striking characteristics are in the head, which is ornamented with very large pendant wattles, but is destitute of either feathered crest or comb, unless the existence of one or two red points—which are often entirely absent—can be regarded as the latter organ in a very rudimentary condition. Their colour is generally either grey, cuckoo, or pure black, but we have seen them spangled, like a Golden Polish.

There is no doubt whatever that the Guelders were originally a sport from the feather-crested Polish family. The black look exactly like a White-crested Black Polish, wanting the crest: there is the same form of body, fulness of chest, largely developed pendulous wattles, and nostrils flattened and deformed, from the absence of the intermaxillary bones.

In those spangled birds that we have seen, the analogy to the gold-spangled Polish was equally close, the birds being as fully bearded as the most ardent Polish fancier could desire.

The Cuckoo Guelders have large pendulous wattles like the black, and some of the American birds of this colour have strongly-feathered legs.

Guelders are very good layers, and, as might be expected from their close affinity to the Polish, are non-sitters. They may be correctly characterized as very useful

fowls for family purposes, carrying a great amount of flesh on the breast, but they are rather too small to furnish first class-fowls for the markets—at least in this country, where full-sized poultry always commands a more than proportionate price.

The manager of the National Poultry Company describes Guelders as “handsome birds of Cuckoo plumage, close fitting, like that of the La Fleche. They are not quite as large as the Houdans, but equally hardy. They are abundant layers of very fine, large, fertile eggs, and also good table fowls. It would be difficult to say which do better, the Houdan or Guelder chickens. I like this breed so well that I class them next to the Houdans.

La Bresse are the fat poultry of France, and that is all I can say for them, they have no thoroughly marked characteristics.”

The remaining French breeds resemble the La Bresse in being destitute of any specially marked characters. Thus the fowls of Mans, well known in the French markets, are closely allied to the Creveœurs. In the catalogue of the collection in the Jardin Zoologique D'Acclimatation they are thus described:—“The fowls of Mans have a small crest of feathers falling over the back of the head; the comb, double and very large, is formed of small excrecences grouped together. The wattles are rounded and of medium length; the plumage is in general black with green reflections. These fowls are of moderate size; they lay large eggs, but do not sit. They furnish very good table poultry, fattening very readily when cooped.” Several other breeds are also described in the French poultry books, but they do not appear to possess any decided individuality that calls for special attention; in fact, as described, it is difficult to distinguish one breed from another.

CHAPTER XIX.

THE SILK FOWL.

THE Silk fowl is one of very great antiquity. The celebrated naturalist Gesner, who lived in the early part of the sixteenth century (1516 to 1565), published engravings of several varieties of poultry in his "History of Birds." One of the fowls represented by him is a woolly hen, which he termed *Gallina Lanigera*. The bird is represented without any tail-feathers; rose-combed, clean legged, and with four-toed feet. Aldrovandus, whose treatise on birds was published in the following century (1645), enters largely into the different varieties known to the ancients; he also describes and illustrates a woolly hen, and states that in the East, fowls are bred as white as snow, covered, not with feathers, but with wool, like sheep; and that in the city of Quelinfu, *in regno Mangi*, M. Paulus Venetus says that hens are to be found which have, instead of feathers, hairs like those of a cat, and that in colour they are black, and lay good eggs. Aldrovandus's figure of the woolly fowl is tailless, and the wings are not visible; the hen has a double comb, deeply serrated, well developed wattles, short and thick legs, and four-toed feet. At the period at which Aldrovandus wrote, these woolly fowls could not have been known in England, or even common on the Continent, for in Willoughby's "Ornithology," published in 1678, and edited by the celebrated John Ray, it is stated—"The wool-bearing hen I take to be altogether fabulous, and its figure in Aldrovandus fictitious." It is further suggested that it might be the frizzled hen, or even a cassowary. There can be but little doubt, however, that the birds described by Gesner and Aldrovandus resembled what are now known as Silk fowls.

The Silk fowl is a native of the East of Asia. Mr. Edward Blyth, formerly Curator of the Asiatic Society's Museum, writing from Calcutta, states—"The only Silky fowls I have seen here were from China, or Malacca, or Singapore: the latter with single red combs and wattles; the former with complex, blackish rose-combs, very short, stubby beaks, and a quantity of glaucous blue skin in place of wattles, imparting a most remarkable appearance."

The usual colour for the plumage of Silk fowls is white with a black or dark-blue skin, the surface of the bones is also covered with a dark membrane or periosteum. The feathers have the webs separated, so that their covering seems formed of hair rather than that which is ordinarily allotted to birds; the quill feathers of the wings have the filaments of the vanes so much divided that they are useless as a means of flight, and the tail in the best specimens is but little

more developed than that of a Cochin; but a sickle-tail, arising in all probability from a cross with some other breed, is not unfrequent.

The comb is usually depressed and warty, approaching in form to that of the Malay; but variations in this respect are frequent, and single combs, with those of an intermediate character, are by no means uncommon. The one first mentioned, however, is regarded as the most correct form; its colour, with that of the wattles, should be of a dull leaden blue; the face is very thinly covered with feathers, through which the dark-blue skin is conspicuous; the ear-lobes are commonly of a bright blue; the legs, which are not unfrequently heavily feathered, are dark blue, almost black, as are the feet, which are generally furnished with five toes, and many specimens are furnished with a small feathered crest at the back of the comb. In form, Silk fowls are compact, and low on the legs; in this respect resembling well-bred Cochins.

Silk fowls are by no means of so great a weight as they appear, for their feathers, when in good condition, are very fluffy, and stand well out from the body, giving them the appearance of far greater bulk than they in reality possess. Their ordinary weight is under two pounds each for the hens, and two pounds and a half for the cocks. From their small size they are not unfrequently termed silky Bantams, and are often exhibited at our poultry shows in the classes for those breeds.

The eggs laid by Silk fowls are small in size, and of a pale buff colour. The hens usually lay about twenty or five-and-twenty eggs before showing any desire to sit; they are admirable mothers, and on this account as well as from the warmth afforded by their downy plumage, they are well suited for rearing pheasants or partridges.

The chickens of the white variety are hatched with canary-coloured down, and more attractive little creatures can hardly be conceived. They are easy to rear when hatched not earlier than March or April. To those who may wish to keep a few fowls in an aviary, or in a garden or shrubbery, the Silkie has many recommendations, for they are docile, readily confined by a very low fence, and easily contented within very narrow limits. In such localities they may be relied on to furnish a supply of excellent eggs for the breakfast-table; and when desirous of sitting, they may safely be intrusted with the eggs of any other fowl. The point, however, in which these birds appear to least advantage, is in their character as table-birds; for their black skin and dark bones are, with most persons, fatal objections. If, however, the repugnance to their appearance can be overcome, they will be found admirable eating, as Temminck truly remarks—"It is certain that the flavour and whiteness of the flesh of these fowls greatly surpasses that of other poultry, and if their disagreeable aspect when on a dish did not keep them from our tables, we should estimate them as fully equal to Guinea fowls, which they resemble in the whiteness and flavour of their flesh."

Mr. Hewitt sums up their advantages and drawbacks very impartially, in the following remarks—"I believe them to be a variety that quickly degenerate, when

bred in our climate; as those I first possessed produced chickens in a few years after their importation, in which the peculiarities of their race were fast waning away, although the degeneracy was not to be attributed to cross-breeding with other poultry. I am certain that no fowls I ever possessed were so satisfactory for rearing pheasants, partridges, and other delicate youngsters: under their protection, I scarcely lost a single chicken. The unusual warmth of their plumage, no doubt, produced this result; and they are certainly well worth a trial by those who are interested in the production of game artificially. They were also tolerable layers, and the eggs were of equal excellence to those of other fowls. The young chickens are both interesting, unique, and very beautiful. They are certainly a variety of poultry that require far more protection from hard and wet weather than most others. Their downy covering soon becomes saturated; and if much exposed, disease inevitably ensues.

“Silk fowls should be strictly limited to their own particular walk, and prohibited the possibility of access to any other description of fowls; for by crossing, the injury is equally apparent in the offspring, whether considered as fancy fowls, or designed for table purposes. For the last-named service, so far as appearances alone are concerned, they are the very reverse of covetable.

“The skin of highly-bred Silk fowls, if boiled, assumes an extremely dark violet colour, and the external surface of all the bones is of a precisely similar hue; should they, on the other hand, have been roasted, they become even less inviting, for by this treatment they appear considerably darker still, and of course cannot be placed before visitors who are unaccustomed to them, without a general explanation that seldom proves perfectly satisfactory. Even though so untempting to the eye, they are not an indifferent fowl as to flavour: I have many times partaken of both pure and cross-bred Silk fowls, and found them, when well fed, equal to most others.

“I found in all instances that the silkiness from which these fowls derive their appellation, is not transmitted to the offspring produced by intermixture with other varieties; these chickens simply betray their origin by the colour of the skin and bone—indeed, they exhibit but little of the general outward character of their silky ancestry; and thence it is that country poulterers are themselves frequently unaware of this great drawback to their value as sale birds, until they are denuded of their feathers. With all their failings, they are really invaluable for the rearing of tender chickens requiring great warmth and care.”

It is usually stated, in the compilations that have issued from the press as original works on poultry, that the Silk fowl is the *Gallus Morio* of Temminck; this statement is, however, perfectly destitute of foundation. Temminck, in his “*Histoire Naturelle Générale des Gallinacés*,” describes the breed under the name of the *Coq à Duvet*, and gives it the scientific title of *Gallus Lanatus*, or downy fowl, and the name *Gallus Morio* is applied by him to the *Coq Nègre*, the negro, or black-skinned fowl, which has plumage of the ordinary character. This latter breed is evidently the result of a cross between the silky and the ordinary fowl. The

editor, Mr. Tegetmeier, made some experiments on the cross breeding of Silkys with other varieties, the result of which may be worth recording, as the knowledge of them may prevent some annoyance to those keeping Silk fowls. He found that when they were crossed with other breeds, the chickens produced seldom had the silky feathers, but were clothed in plumage of the ordinary character. In one case of a Silky hen running with a Spanish cock, of nine chickens hatched, eight were cockerels; they all had dark plumage, with brassy hackles and saddles, and in one or two instances, spangled breasts. The single pullet was black. All the birds were characterized by a black skin and periosteum, and much of the cellular



FEATHER OF SILKY COCHON.

tissue or structure separating the layers of muscles on the breast and legs, was also black, though the flesh itself was white and very excellent eating. These fowls were obviously identical with the *Gallus Morio*, or negro fowl, of Temminck.

The pullet and one of the cocks were mated the following season, and the produce closely resembled the parents; one of the chickens, however, was covered with feathers like those of the Silky fowl; her plumage was black, and in form she partook more of the character of the Spanish than of the Silky breed. Subsequently the cock was given away, and allowed to run with a number of common hens, but the result was not satisfactory, as the chickens hatched in the farm-yard were dark in the skin and bone, and regarded with disfavour by the purchasers.

Whatever may be the objection to these negro fowls as regards their appearance upon the table, none can be alleged against their edible qualities, which are undeniably good. In France, where they are curious in cookery, these fowls are even valued for their appearance, and at one of the dinners of the Acclimatization Society, held at St. James's Hall, there were some boiled negro fowls served up, surrounded with white sauce, to make the dark colour more evident.

The silky character of the feathers is one which occasionally occurs in other breeds, as in the Cochin; and when this is the case, it may be propagated by a careful selection of brood stock. The so-called Emu fowl, or Silky Cochin, has already been described (see page 46). The preceding wood-cut shows the peculiar character of the feather in this breed; it is very accurately rendered in the engraving, which has been carefully copied from a photograph, the feather itself having been used as the negative.

CHAPTER XX.

THE FRIZZLED FOWL.

BIRDS with feathers more or less completely recurved are not uncommon in many parts of the East. In a large collection of the domesticated birds of nearly every country in the world, formed by Mr. C. Darwin, and placed at our service, many specimens occur with recurved feathers, some like Malays, with short frizzled hackles, and others with the peculiar plumage passing over the entire body.

Frizzled fowls were described by Aldrovandus in 1645, and his description and engravings were alluded to by Willoughby, who, in his "Ornithology," states— "We have often seen, and ourselves also have now at Middleton, another kind or variety of hen called in English the Frisland hen, not (as I suppose) because it was first brought to us out of Frisland, but because the feathers of the body are curled or frizzled; by which epithet I believe this bird was first called, the word being afterwards, by the mistake of the vulgar, corrupted into *Frisland*, of like sound. For knowing this to be an outlandish hen, they thought it could not be more fitly denominated than from its country, and thereupon imagined it to be called a *Frisland* hen, instead of a frizzled hen. Nor did they want a probable argument to induce them to think it to be of a *Frisland* breed or original, viz. the curling of the feathers, which one would be apt to attribute to the horror of cold. I suppose this to be the same bird which Aldrovandus hath put in the chapter of monstrous hens in the last place, whose figure, he saith, was sent him by Pompilius Tagliaferrus, of Parma, with this description: 'I would have you to understand that there are two things especially found in this cock worthy of admiration. The first and chief is, that the feathers of its wings have a contrary situation to those of other birds, for that side which in others is naturally undermost or inmost, in this is turned outward, so that the whole wing seems to be inverted; the other is, that the feathers of the neck are reflected towards the head, like a crest or ruff, which way the whole tail also turns up.'"

Mr. E. L. Layard, writing from Ceylon, states that this fowl "is called by the Cingalese, *Caprikukullo*. It is found here but rarely, and the natives say they came from Batavia. This agrees with Temminck."

The Frizzled fowl is the *Gallus crispus* (Frizzled fowl) of Brisson, and the *Gallus pennis revolutis* (Fowl with rolled-back feathers) of Linnaeus; the *Coq à plumes frisées* of Temminck, who states that it is domesticated, and thrives well in Southern Asia, Java, Sumatra, and all the Philippine Islands, and that the prevailing colour of the race is white, the legs being generally smooth; but there



FRIZZLED FOWLS.

H. W. M.

are many specimens variously coloured with black and brown, and some have feathered or booted legs.

The most ornamental that we have seen are those with white feathers over the entire body. In good specimens they curve back from the body, so as to give the bird an appearance of being ruffled, or of having its feathers rubbed in the wrong direction; the tail is generally ample and well sickled. As the birds have not been bred to any particular standard, their size, the colour of the plumage and legs, and the character of the combs, vary greatly in different specimens. The engraving gives a very faithful representation of some exceedingly good specimens.

The following remarks on this variety have been kindly furnished for the present volume by Mr. Hewitt:—

“No variety of fowls can possibly present a more unique appearance than does the Frizzled fowl. All the body feathers, without exception, appear twisted outwards and backwards—similarly to the curled feathers in the tail of a drake—exposing the down underneath to the influence of the weather; it is to this exposure that I myself attribute the fact of their being the most uncertain layers I ever met with among any variety of poultry. After the occurrence of rain I have found that the Frizzled fowls continued in a state of dampness for several hours after the common poultry have become perfectly dry, and the results prove they are susceptible of injuries from such exposure. Those breeders with whom I have personally conversed, all declare they do not approve of the Frizzled fowls, from their want of constitution; and from the fact that when dressed for the purposes of sale they carry so little flesh in accordance to the apparent size of the fowl itself. I have myself tested them as mothers, but find many superior; and, when killed for table, they are of scarcely passable quality. The full-grown cocks generally weigh about five pounds, the hens nearly four. In plumage they are mostly white; still I have seen many brown and grey specimens. They usually are of a somewhat sickly appearance, and generally, if handled, feel thin and spare. Their combs are generally single, and the wattles large. The tails, which are of full size, have, like the flight-feathers of the wings, a broken, irregular appearance on the vane, as though they had been ruffled by passing the hand down them. I have met with many persons that have kept them for fancy sake, who regretted the experiment, as the fowls often became diseased, and were generally out of condition, although enjoying the same advantages as all the other varieties that remained in perfect health. They are quickly prevented from laying by the occurrence of severe weather, at which time they look very forlorn and wretched; and always appear to suffer far more from exposure to cold and wet than the generality of fowls.”

CHAPTER XXI.

THE RUMPLESS FOWL.

THE Rumpless fowl was described and figured by Aldrovandus, under the title of the Persian fowl, in the edition published in 1645. In this work, which is still extant, the cock is represented with short stout legs, feet with four toes, and a few drooping saddle feathers falling over behind, in the place of the tail. The hen is of the same general form as the cock; both sexes are represented with double combs, that of the cock being of enormous size, and deeply serrated.

This is the *Gallus ecaudatus*, or *Coq Wallikikilli* of Temminck, and the *Gallina cauda seu uropygio carens*, or Fowl without a tail, or rump, of Linnæus. It is the *Rumpless* or *Persian Cock* of Latham, and the *Rumpkin* of others; the specimens figured by Aldrovandus two centuries ago, appear only to have differed from those which are now seen in having a black plumage variously marked with yellow.

Sonini and Temminck state that it is a native of the Ceylon forests, and is called by the natives *Wallikikilli*, or *Cock of the Woods*. These erroneous statements are disproved by Mr. E. L. Layard. Writing from Ceylon in 1850, he says:—"The Rumpless fowl is not a wild inhabitant of this island, in spite of Temminck. It is a rather rare, tame introduction from Cochin, I am told. It may appear like boasting, but I can confidently say I am more acquainted with the Ceylon Fauna than any man living, and that if the bird had existed wild I must have seen it. *Wallikikilli* is the name for the female of *Gallus Stanleyi*, meaning literally, *Walli*, jungle, and *kikilli*, hen. The name of the Rumpkin is *Chocikukullo*, literally Cochin fowls."—"Gard. Chron.," 1851, 619.)

There can be no doubt that the Rumpless fowl does not exist in a wild state in any region of the globe. It has evidently taken its rise in an accidental variation, which has been perpetuated by the care of man; its continued existence is a very good example of the perpetuation of a variety by the process of artificial selection. Temminck, though in error respecting their origin, described the structural peculiarities of these remarkable fowls with great accuracy. He states:—"The distinctive characters of this species consist in the loss of the last vertebræ of the back, those that bear the fleshy protuberance termed the rump; the absence of these vertebræ is the natural cause of the cocks and the hens of this kind losing the feathers of the tail."

At a recent date there were in the Zoological Gardens, Paris, specimens of Rumpless fowls described under the erroneous name of "*Wallikiki*."

The Rev. J. Clayton, in the "Philosophical Transactions" for 1693, p. 992, says that he observed in Virginia that the hens and cocks were for the most part

without tails ; adding, that he was assured that our English hens, after some time, lose their rumps. Buffon accepted this absurd statement as truth, and even Dr. Latham seems not to have felt certain of its being untrue.

The general characters of the Rumpless breeds vary very much. Aldrovandus describes them as being black ; at present, they exist of various colours : in many, white feathers largely prevail ; some are irregularly spangled, whilst others, in plumage, resemble the Black-breasted Red Game.

Mr. Hewitt states respecting them that—“ It is difficult to breed them to any particular colour ; as with the most rigid care in the selection of the brood-stock, the chickens sport into nearly every variety of marking and ground-colour. The only birds of this kind that I ever knew to breed truly—so far as colour was considered—were purely white ones ; they were by far the prettiest collection of Rumpless fowls that ever came under my notice. They were all white, without exception, and every bird had a somewhat small single comb. Like this variety generally, they were good layers and sat well. The wattles were very compact, and the legs and feet were of a rather heavy, bony appearance, the colour being white. This strain of Rumpless fowls originally came from the Isle of Man. From this island I have known others introduced into the Liverpool market that were quite black ; others a beautiful fawn, and likewise several lots irregularly speckled, and, indeed, without possessing any characteristic whatever, except being rumpless. Extraordinary differences in point of size exist in these fowls ; some specimens range as heavily as six and a half to seven pounds each ; others do not exceed two and a half or three pounds. Some have small lark-crests ; others—and these constitute the majority—have none. As usually met with, they appear to possess no distinguishing formation of comb ; rosy, cupped, and flat combs being equally prevalent. There is, therefore, no positive standard that can be laid down as the peculiarities of this variety, save the one to which their name refers. The size of the eggs varies proportionately with that of the hens by which they are produced ; they are white, and somewhat larger than might have been anticipated. I now proceed to mention a still more perplexing proof of their versatility of character : a friend of mine purchased a successful pen at a poultry-show, taking them away to a walk where no other fowls ever trespassed ; and yet the chickens were, in a considerable number of instances, furnished with fully-developed tail-feathers, being not rumpless. On inquiry of the previous owner, he stated—‘ Mine have always done so from the time I first kept them ; but the tailed birds will very probably produce rumpless chickens.’ Three such birds were then purposely retained ; and they produced the next year more than twenty youngsters, all of which, but one, were rumpless and destitute of tail-feathers. The white ones I have before alluded to, occasionally produced chickens that were not rumpless, but only rarely. I believe Rumpless fowls to be hardy, as even in exposed situations, on the sides of Welsh mountains, they continue in good health and prosper well, even in cases where the fowls at all times shift for themselves, and but slight attention is shown to the chickens. I can willingly add my testimony, likewise,

to the good quality of a Rumpless fowl on the dinner-table, the flesh being abundant, white, firm, and of good flavour; but, as a drawback to their utility, it may be stated that all Rumpless fowls are sadly prone to lay unfertilized eggs."

There can be no difficulty whatever in rearing specimens of almost any breed without a tail. Some years since the editor had in his possession a specimen of a tailless crested bird, and from this hen, as described at page 191, he reared a number of Rumpless Polish, by mating her with a White Polish cock; some of the offspring were matched up with Golden Polish, and some very good Rumpless Gold-spangled chickens were the result. The strain was then given to a gentleman, who, though not an exhibitor, has amused himself in mating these Rumpless birds with other varieties; in this manner he has reduced their size very much, and has at present a pretty set of very small Rumpless Nankin Bantams, which are the greatest novelty we have ever seen in Rumpless breeds.

CHAPTER XXII.

DUMPIES—REDCAPS—BARNDOR FOWLS—DOMESTIC FOWLS OF INDIA.

DUMPIES, OR SCOTCH BAKIES.

UNDER this title a breed of fowls has long been known in Scotland. The most important characteristic of these birds is the extreme shortness of the bones of the leg, the shank bone often not exceeding two inches in length. In America they are termed Creepers, and are held in higher esteem than in this country, being frequently crossed with Cochins and other large breeds. One of the first exhibitors of the variety in England thus describes them:—"The Scotch Bakies, or Dumpies, are a breed of fowls closely resembling the Dorking in form, symmetry, and quality of flesh; the average weight of the full-grown male bird is from six pounds to seven pounds, and of the hens, from five pounds to six pounds; their legs are singularly short, not exceeding two inches in length from the hock joint; the comb is generally single, erect, and well serrated; the body round and plump, and the tail ample. As layers and sitters, they have great merit. They are gentle and quiet when hatching, and subsequently prove attentive mothers, their short legs enabling the chickens to brood well under them, even when standing up. They are perfectly hardy, and a good variety, well adapted for the table; their eggs are larger than the usual average of an English market egg."

The results obtained by crossing these birds with other breeds are thus described by Mr. Hewitt:—"It is well known that most of our largest breeds have a tendency to become leggy. In the Dumpies we at once obtain the best possible cross that could be desired for correcting this evil, as the shank-bone of well-bred birds barely exceeds a couple of inches in length. Dumpies carry much meat in proportion to their apparent size, the flesh on their wings, breasts, and merry-thoughts being largely developed. Their superior qualifications for the spit have urged a few persevering amateurs to commence a series of crossings for the purpose of improving our table fowls, and the produce of two such experiments I will describe. A Buff Cochin hen running with a Dumpy cock produced chickens that proved very weighty birds, but which were not by any means distinguished for their beauty; their chief recommendation consisted entirely in the twofold excellency of their being inexhaustible layers, and as almost interminable sitters. They were very careful mothers of their chickens, and tended them much longer than thorough-bred Cochins would have done. This cross exhibited a coarse, unseemly head, with a large, flagging, heavily-serrated comb, and very long loose wattles. In colour, they were mostly grizzled, with white about the wings, the ground being rich buff;

they proved invariably silver-hackled; the body, too, had a somewhat freckled appearance, and they were not feather-legged; the colour of the legs was white. It was, therefore, next to impossible to detect their actual lineage by the eye, more particularly as they stood somewhat higher on the legs than the old Cochin mother. In the other case the Dumpy was crossed with a very superior darkly-feathered robin-breasted Gray Dorking hen. This cross was exceedingly satisfactory; the chickens were very neat, cleanly-looking birds, no way reduced in actual size from that of their Dorking parent, but rendered much lower on the leg; from their extraordinary dumpiness, they did not look as heavy as they really were, but an appeal to the scales told immensely to their advantage. Many possessed the additional Dorking toe, and showed a very close approach to the most form of this variety, but they lacked apparent size; it was on handling that their great weight became evident. Their plumage was an irregularly speckled, and even the second cross with the Dorking did not materially diminish this eyesore. They did not lay anything like so well, nor did they prove of the strong rude health that characterized the half-bred Cochins. They laid but very little better than Dorkings. Divested of their feathers they were specimens worthy of any board, and this characteristic constituted their great advantage."

A few years since, Dumpies very frequently made their appearance in the "Variety Class" at the poultry shows, but lately they have gone out of fashion, at least in England, and we have not seen a good pen exhibited for some time.

REDCAPS.

At some of the shows in the North of England, prizes are offered for Redcaps, in addition to those for Golden-spangled Hamburgs, with which the Redcaps are often said to be identical. In some localities these birds are highly valued as profitable fowls and abundant egg producers, and we have seen nearly thirty pens entered for competition at a Yorkshire show.

The chief points in which Redcaps differ from Spangled Hamburgs are in size, in combs, and in markings. In size they very greatly excel the usual Hamburgs, being as large and compact as ordinary Dorkings; and in markings they want the regularity and beauty of spangle so characteristic of Golden Mooney and Pheasant fowls, being much darker on the breast and other parts. The most striking difference, however, is in the extraordinary development of comb; this is increased in size to so great a degree, that the combs of the hens are much larger than those of the ordinary Hamburg cocks, even when at their greatest size. So enormous are they, that it is almost impossible for them to balance on the skull, and they constantly lop over to one side. This, however, is not regarded as a serious defect by the amateurs of the breed, their aim being to produce combs that are of extreme size, square in front, well spiked, and peaked behind; in fact, a rose comb, immensely magnified. The cocks not unfrequently possess combs upwards of three inches in breadth at the front, and more than four

in length, measured to the end of the peak behind. Valuable as Redcaps may be, both as table fowl and as enormous egg producers, we cannot do more than regard them as a local breed, not likely ever to rise into general estimation. The excessive development of comb, so highly valued by the fancier of the variety, is a property that would rather be regarded as a deformity by amateurs in general.

BARN-DOOR FOWLS.

The title of Barn-door fowls is given to the mongrels that are found existing in all places where no care whatever is taken respecting the purity of the breed of poultry. Their characteristics vary in almost every locality. In many parts of the country, the ordinary farm-yard fowls show a strong likeness to the game breed, arising from the custom, formerly so extensively followed, of putting game cocks out "to walk" at the cottagers' and tenants' of the landed proprietors. In some of the old leases, drawn up when cock-fighting was not an illegal amusement, a clause was inserted that each tenant should walk a cock or cocks for the proprietor of the soil. The close, hard feathered, neat, compact fowls, seen in so many districts, evidently result from this custom. In parts of the country where other breeds are largely kept, their mongrel progeny are visible: thus, near London, the common fowls show a strong infusion of the Spanish blood.

In parts of the New Forest, in Hampshire, Polish parentage has given rise to many crested hens. At the time of the Cochin mania, when every one tried to rear birds that were to sell at one pound sterling per pound, avoirdupois, Cochins were raised in every locality, the result being that fowls having a yellow skin, and legs with heavy useless bone, appeared for a few seasons in all the poulterers' shops; and the higglers who bought up the young birds to fatten for the London markets, denounced the introduction of the fashionable Asiatic breed, with a zeal and energy more vigorous than polite.

The Barn-door fowls would not require any lengthened consideration, except to correct an impression that still exists in the minds of some prejudiced persons, who assert that these common mongrels are superior for economical purposes to any pure and well-marked breed. We would inquire of such persons if they know of any Barn-door fowls that lay as many eggs as Hamburgs, amongst the non-sitters, or the Cochins or Brahmas amongst the sitters, or whether any are equal to Dorkings or Houdans as table fowl. These erroneous views may be accounted for by the fact that, until within the last few years, the improvement of poultry has been generally neglected in this country; it is only recently that we have been aroused to a correct appreciation of their value. Every competent person who now directs his thoughts to the subject, at once acknowledges that poultry are as capable as any other kind of farming stock of being increased in value by breeding from select specimens; and the consequences of this conviction are apparent in the fact that the improvement which has been effected up to the present time has been of a most marked and decided character. If any sanguine poultry-breeder had prophesied a few years since that Dorking pullets would be

shown weighing nine pounds each, that three Aylesbury ducks would be exhibited weighing thirty pounds, a pair of turkeys nearly fifty pounds, and a couple of geese exceeding half a hundredweight, he would have been regarded as a harmless enthusiast; yet these weights have been reached, and doubtless will, in their turn, be surpassed. In addition to weight, other characteristics have been improved, early maturity has been encouraged, greater hardiness of constitution bestowed, an increased production of eggs secured.

We are not desirous of converting every farmer into a breeder of ornamental or exhibition poultry; but we do plead very strongly for the substitution of good short-legged table fowls, or of prolific layers, for the weedy stilty mongrels, neither good as market fowls nor valuable as egg producers, that now disgrace far too many of our farm-yards. Farmers unduly neglect this source of wealth. They too often keep worthless stocks of fowls under conditions not conducive to their well-doing, and complain that they do not pay the expenses of their keep. Some agriculturists, on the other hand, have found their fowls pay well; but then their birds receive the same degree of attention that is given to the other specimens of valuable live stock.

There is one great drawback to the profitable rearing of table fowls near London, namely, the want of a more direct communication between the rearers and the consumers. The middle men, or the market salesmen, swallow up a very large proportion of the profits. The producer reaps but a small return, the poulterer pays a high price, and has to reimburse himself by charging the consumer at a very exorbitant rate. Unfortunately, it is not easy to suggest how this state of things can be remedied. But the evil is one which bears heavily alike on the producers and consumers. The former are entirely in the hands of the salesman, who returns what sum he chooses for the fowls consigned to him, and the remuneration is of so poor a character that few farmers find it answer their purpose to send fowls to the London markets. Consequently, the tables of the metropolis are ill supplied, and poultry is far dearer than it should be, to the loss of all parties concerned except the salesman.

THE DOMESTIC FOWLS OF INDIA.

In the chapter on the Malay fowls, we have alluded to the general characters of the domesticated Indian varieties, some of which are of large size. There is, however, no evidence whatever of the existence of any wild type approaching the fowl termed by Temminck *Gallus giganteus*. The theory that every domesticated variety must have had its wild original, has given rise to the most erroneous suppositions, which, being repeated by writer after writer, have at last been accepted as facts, and statements have been made and implicitly believed, that the Rumpless, the Silk fowls, the Malays, and even the Crested breeds, have all had their wild progenitors roaming at large in the Eastern jungles. In the proceedings of the Zoological Society for 1832, Colonel Sykes described, under the name of the Kulm fowl, a large variety, domesticated in the Deccan; this has

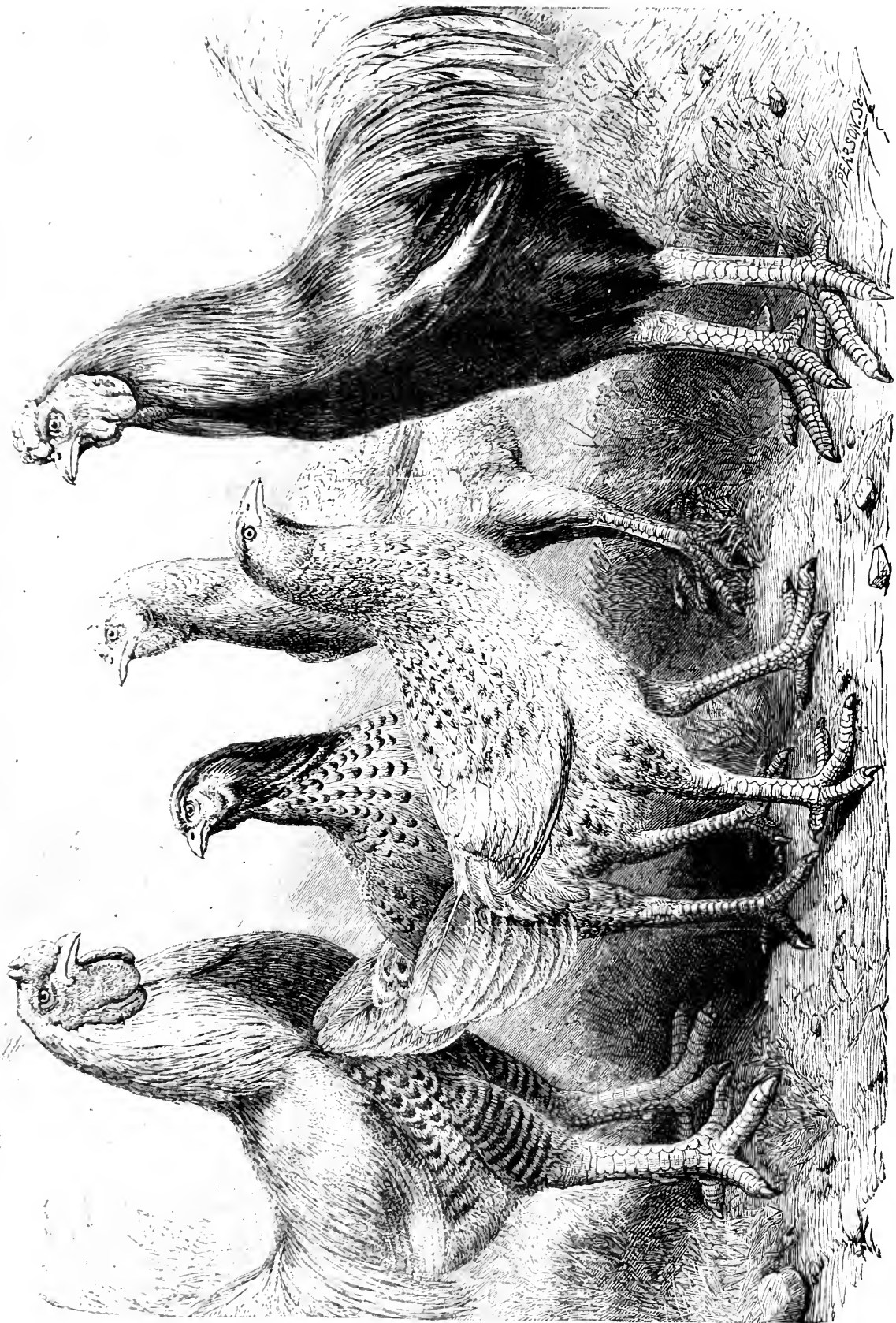

EGGUM PILLY GAGGIZES.

been erroneously regarded as descended from, or identical with, the supposed wild *Gallus giganteus*, of whose existence there is no evidence whatever. Many of the Indian breeds are of what may be termed the Malayan type, and characterized by great height, long snaky necks with short hackle feathers, scanty tail coverts, close firm plumage, and stout elongated shanks. Some years since, a breed of this kind was exhibited at our poultry shows under the title of Rangoon fowls, and in the *Illustrated London News* of April, 1865, there was figured a group of Indian fowls, with the name of Begum Pilly Gaguzes. For the liberty of reproducing this engraving we are indebted to the courtesy of the proprietors of that journal. The birds it portrays are good examples of the Malayan type, but are neither so close feathered, so tall, or so weighty as the best examples of Malays exhibited at our ordinary shows; the height of the cock was stated to be two feet six inches, and the weight of young birds when seven or eight months old, was given as eight pounds each. In the account of these birds that accompanied the engraving, it was stated that they were introduced for the purpose of crossing with Dorkings, and thus improving our common breeds, but for this purpose a good Brahma or short-legged Cochin would be far superior. The engraving, however, is of much interest as illustrating a type of fowl common over a large portion of the south of Asia.

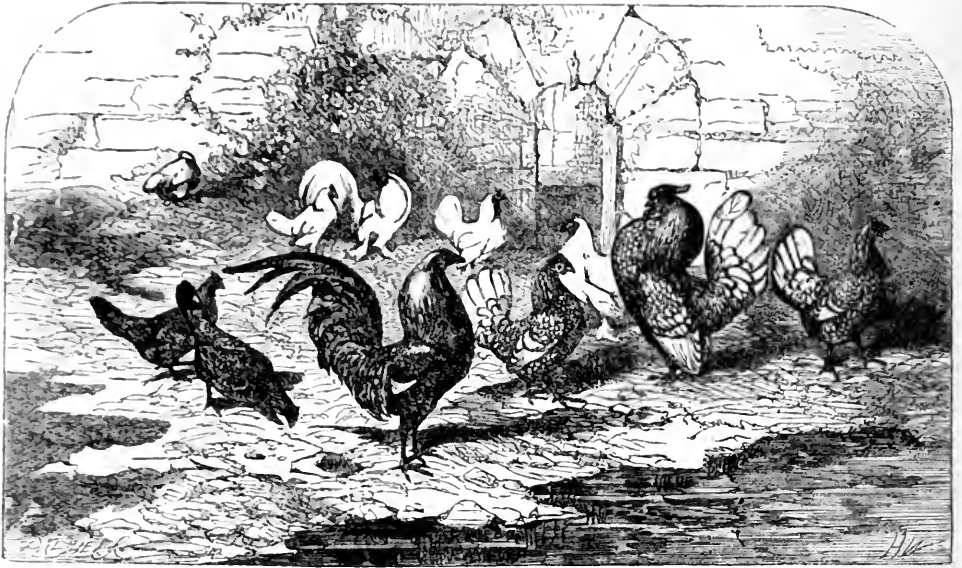

CHAPTER XXIII.

BANTAMS.

IT is usually stated in works on Poultry, that the smaller varieties of domesticated fowls, known under the general name of Bantams, are the descendants of certain distinct species of wild fowls existing in the Eastern Archipelago. There is, however, no real foundation for this statement. Bantams of all kinds are merely domesticated varieties that have been reared and rendered permanent by the care of man. Two of the most distinct kinds, namely, the Sebright and the Game Bantams, have been produced within the memory of persons now living, and, were all the different varieties exterminated, they could be reproduced by careful breeding for a few years.

Dwarfed fowls have been known since the time of Pliny, who states—"There is a dwarfed kind of fowls that are extraordinarily small and yet fruitful."

Aldrovandus describes a dwarf hen, and he is quoted by Willoughby, writing in 1678, who states—"This variety is found in England, is kept by the curious, and called *Grigs*." Since that time the smaller breeds of fowls have been noticed by all writers on the subject.

The different varieties of Bantams reared in this country at the present time are numerous. The breeds most in request are the following:—The Sebright, or Gold and Silver-laced Bantams; the Black Bantam; the White Bantam; and the Game Bantam. To these may be added the older breeds, such as the Booted or Feather-





LEIGHTON, BRAM

GOLD AND SILVER LACED BANTAMS.

legged Bantam, the Nankin and Partridge-coloured varieties, and the more recent introductions, such as the Pekin or Cochin Bantam, the Japanese Bantam, &c.

THE SEBRIGHT, OR GOLD AND SILVER-LACED BANTAMS.

The Sebright, or Gold and Silver-laced Bantams, are undoubtedly the most artificial breed of fowls we possess, and, on account of their extraordinary beauty, and the high value of perfect specimens, may first claim our attention. Regarding the history of these birds, the following communication, published some time since by the editor, contains the most definite and accurate account that has been made public:—

“Respecting the origin of these remarkable birds, no satisfactory account has ever yet been given to the public; consequently, numerous and contradictory statements are current concerning them. By some they have been termed the ‘Sebright Jungle Fowl,’ as though they were the direct and unmixed descendants of a breed from the Indian jungles; but it is hardly requisite to state that the wild original is unknown to naturalists. Others, again, have attributed their origin to careful crosses between the old Nankin-coloured Bantam, and some of our Hamburgs or Pheasant fowls; whilst a third have referred them to a cross between the Bantam and the Laced Polish.

“The last supposition seems, at first sight, to be the most monstrous, from the assumed difficulty of getting rid of the crest and nostril of the Polish fowl; but, in reality, this is not a valid objection. I have, for some time, been devoting much attention to the different Polish varieties and their crosses, and can state from experience that, by careful selection, the Polish crest may be entirely bred out in the second generation—that is to say, that fowls may be one quarter Polish, and yet show no trace of crest. I do not say that this will be the case in all that are thus bred, but it will be in many; and the converse also holds good, that many birds reared from a half-bred and a pure Polish may show no perceptible falling off in the size of crest from that of fowls whose pedigree is unmixed.

“For example, last season I reared some cross-bred fowls between White Cochin hens and a White Polish cock; they were white, slightly crested, bearded, with blue legs, slightly feathered; one I kept as a sitter, and she was running this year with a very large-crested Polish cock. I hatched a few of her eggs, and have now before me a White Polish cockerel thus produced, with very full crest, the only trace of his illegitimacy being that his blue legs are slightly feathered.

“I mention these cases to prove that the supposed difficulty of getting rid of the Polish crest is not an insuperable objection to the Polish Sebright theory; but, fortunately, I have something more than mere theory to advance. The following account was, by the kindness of the late Dr. Horner, obtained from the present Sir Thomas Sebright, for the purpose of publication in the POULTRY BOOK:—

“Dr. Horner stated: ‘The following information was courteously given me by

the present Sir Thomas Sebright himself. It was about the year 1800 that the late Sir John Sebright began to fashion the Sebright Bantam. The first cross was between a common Bantam and the Polish fowl. The chickens resulting from this alliance were bred in-and-in until the required markings and size were secured. Sir John then accidentally found a hen-tailed Bantam cock in the country where he was travelling. This short-tailed bird he in-bred with his newly manufactured Bantams, thereby giving their progeny the present form of the square tail. Sir Thomas is quite satisfied that it was the Polish, and not the Golden Pheasant (now named the Spangled Hamburgh), with which the Bantam was first crossed. I thought, in my inexperience, that the top-knot and beard of the Polish could hardly have been got rid of; but the last two seasons alone have been sufficient to show me how easy it is to get rid of these appendages. Thus, last year, I had a young cock bird with a beard, and also with a crest of feathers behind a somewhat irregular rose-comb. This bird was bred from a Polish cock and one of Sir Thomas Sebright's Bantams. This year I crossed this young cock with a Golden Pheasant hen, and obtained three chickens, all cocks. One of these is quite free from both beard and crest, and with a fine rose-comb and good wattles; the other two have no crests, but have some beard, fine rose-comb, and small wattles.

“This account, I think, may be regarded as putting the question at rest, for I do not see that we can have any higher authority on the subject; and I must say that I feel a considerable amount of pleasure in having been the channel through which this interesting fact has been made known.”

Sebright Bantams are of two varieties, Golden and Silver-laced. In the first the ground-colour is of a rich golden tint; in the second it should be a pure silvery white; every feather should be perfectly laced—that is, edged with a line of black, completely encircling the feather.

One of the most remarkable characteristics of the Sebright cock is the total absence of the usual hackle and saddle-feathers common to the sex; he is also perfectly “*hen-tailed*,” or devoid of arched sickle-feathers; the principal feathers being nearly straight, and forming a square tail like that of the hen. The tail side-coverts are well developed; and great stress is laid on their being perfectly laced, as in no part of the plumage is the colour more apt to run. The comb in show birds must be double, terminating in a well-formed point; while the legs and feet are required to be blue, and wholly free from the least appearance of feathers. The feathers on the head are apt to appear dark, from the wider margin of the lacing; this, however, should be avoided, since a main point of the Sebright is the preservation of the same proportion of ground-colour and lacing throughout the whole of its plumage. The ear-lobe is small, and, in our opinion, should be white; but this is rarely, if ever, seen. Mr. Hewitt thus alludes to this point:—“In the Sebright Laced Bantams I have yet to see a specimen in which the ear-lobe is perfectly white; for, although so many have been bred by myself in the last twenty years, all that I have ever yet had were either more or less blushed, or perfectly red

in the ear-lobe. I freely admit that I should prefer the white, but feel confident that it is not to be generally, if ever, obtained. I have also invariably noticed that any unusual whiteness of the ear-lobe is accompanied by a great falling off in the lacing, and therefore, if attainable only at so great a cost, it must not be insisted on. Whether the ear-lobe is white, or possesses the blue tinge, either form would place the bird above those of its competitors who, equal in other points, manifested the decided red stain. In the carriage of these birds we find the very extreme of pride, vanity, and self-importance; the feet are raised in walking much more than in any other of the Bantams, and planted again with the greatest deliberation and precision. When alarmed, their deportment is most striking; the wings drop to the ground, not listlessly, but as if determined to make the most of their tiny proportions; while the head is thrown back, and the tail raised, so that they nearly meet."

It is desirable to give a more minute description of the characteristics of these birds, as it is necessary to breed them to an exact standard for exhibition. We have, therefore, much pleasure in adding the following detailed description by Mr. Hewitt, who is known as one of the most successful breeders of both varieties.

Respecting their weight and size, Mr. Hewitt gives 20 ounces as the extreme weight for the cock, and states that, if less, the bird is greatly to be preferred for exhibition, though for stock they are rarely useful at a less size; but it is desirable to breed them a few ounces less for show purposes. In the hens the extreme weight is 16 ounces: the same remarks apply respecting the weight of exhibition and stock birds as in the case of the cock.

The carriage of the Sebright cock is the height of self-importance; the head is drawn back, until the tail, which is well raised, nearly touches it; the wings droop about half way down the legs; the birds are restless, impatient, and constantly moving; much given to pugnacity, and always seeking antagonists, which they attack fiercely, despising disparity of size altogether, and, from their rapidity of motion, are frequently triumphant over weighty adversaries. In the hens, the carriage is upstart, gay, and lively.

The general character of the plumage of the cock is very fine, close-lying, and in first-class birds laced accurately throughout. Across the shoulders is generally the most faulty part, if the birds are not very correctly bred; but in really good breeds no such imperfection of plumage exists. It is imperative in first-class birds that the lacing should completely encircle the feathers. In the hens the plumage should be brilliant, well-laced, very close-lying, and compact; each feather being very long and narrow.

The neck of both sexes must be perfectly hen-hackled, and accurately laced; although, near the head, from the feathers being smaller, the black predominates.

The conformation of the saddle-feathers in the cock is the same as in the hen, being all regularly laced; as the feathers approach nearer the tail, they become

wonderfully distinct and beautiful in their markings. The saddle of the hen is perfectly laced with a clear unsullied ground. The feathers generally look dark here, because they overlap each other considerably.

The tail in the cock should have a perfectly clear ground-colour (golden or silver, as the case may be); every feather should be laced throughout; but this degree of perfection is only rarely attainable. The tail, however, must be perfectly hen-tailed, tipped with black, and without sickles. A clear ground-colour is a most important advantage in the tail of a Sebright, but very difficult to obtain in the male bird. In the hen, the tail somewhat longer than in other Bantams, the ground-colour perfectly clear, and the lacings accurately marked. In the hens this is much more easily attained than in the cocks.

The breast of both sexes must be accurately laced throughout.

The secondary quill-feathers that are visible when the wing is closed, must be accurately and completely laced throughout, with a perfectly clear ground; perfection in this point is most important.

The primary quills or flight-feathers should have a clear gold or silver ground, and be tipped with black. But in very aged fowls of the Golden-laced, they almost always become grizzled with white, particularly towards the roots.

In the thighs the feathers are much darker than the body plumage; but nevertheless they should still show the laced margin.

The legs and feet are entirely slate-coloured, small and well-formed, and quite free from feathers.

The comb must be of a perfect double or rose shape, set firmly on the head, without any tendency to fall over on either side; full of points, which are rather more blunted than in the Hamburgh fowls. It should end in a good peak behind, turning slightly upwards; be neat, but not overgrown; a comb that is raised highly from the head is called helmet-combed, and is objectionable. In the hen the rose-comb should be well-formed and very neat, the peak at the back well defined and up-turning. A depression at the back of the comb is a very common, but great failing, equally objectionable for breeding and for exhibition. In Sebrights of both sexes the combs are more livid in colour than in most other breeds.

The wattles should be small, florid, and not hanging loosely, those of the hen being still more compact than they are found in the cock.

A white ear-lobe is greatly to be preferred, if attainable without failings in the lacing of the plumage, but a red ear-lobe is admissible. The face is very neat, and a little darkened round the eyes, or gipsy-faced, as it is commonly called, compared with that of other fowls. In the hens the face possesses the very extreme of neatness, is highly expressive, and with a jaunty appearance.

The eye is dark-red, vivacious, impatient, and sparkling; the bill uniformly slate-coloured.

With regard to the selection of birds for breeding stock, Mr. Hewitt remarks:—At three years old the Sebright becomes what is called kite-winged; that is, the

principal feathers of the tail and wings are greatly grizzled with white, and the birds are sadly deteriorated for exhibition. Frequently, however, have I found that in this state they produce stock far superior to those that have been reared from them in their pristine beauty.

It is also found that better markings are usually produced by the union of a heavily-laced bird with one that is scarcely sufficiently so, than when both parents are perfect in this respect. "Why this should be so," says Mr. Hewitt, "I know not; but I am confident that those that are best-laced frequently produce offspring very far from perfect in their markings, while those formerly so successfully exhibited by myself were bred as stated."

With regard to the breeding of these birds, Mr. Hewitt has favoured us with the following remarks:—

"Of Sebright Bantams, whether Golden or Silver-laced, I am, by dearly-bought experience, assured that a perfectly hen-tailed cock is rarely serviceable for brood purposes, however valuable he may be in the exhibition pen. I do not insist on the unvarying sterility of such a male bird, because a few exceptions have come within my knowledge; but the general rule is that eggs laid to such a cock are either entirely sterile, or only one egg in many nests proves productive,—although as an exception the most compact hen-tailed cock I ever yet met with has the sole range of my yard, and the eggs of the hens (running with him) are in almost every instance fertilized. The ground-colour of this bird's tail is perfectly clear frosted silver, the markings as complete as though laced by the hand of an artist, and the whole bird unexceptionable. This is the only instance I ever yet met with in which such a male Sebright proved a really satisfactory stock bird. The combined experience of many other admirers of the Sebright Bantams is concurrent with my own—viz. that even a very trifling disposition to sickle-feather in the tail brings with it proportionably increased productiveness; and that, on the other hand, absolute perfection of hen-tailed character in the male bird as generally entails sterility. It must be remembered, these remarks apply to Sebrights as stock birds, and not to exhibition fowls. In the latter position, no one can entertain more positive approval than myself of the so-called hen-tail, and success in the show-pen depends exclusively on outward appearance, altogether regardless of powers of procreation; but to introduce an entirely faultless cock as the progenitor of future stock, is almost always apt to lead to disappointment. I have noticed, as a general rule, that even the slightest deviation from feminine character in the tail of the male Sebright—say the elongation by only half an inch of the two principal tail-feathers—brings with it a probability of fertility; and would therefore advise Sebright amateurs desirous of breeding these birds, not as a rule to depend exclusively and altogether on a perfectly hen-tailed cock.

"I am convinced that very much of the disappointment so generally complained of, in breeding chickens in anything like proportionate numbers to the eggs incubated, arises altogether from the principle of purposely selecting

the most diminutive, and consequently the most weakly, fowls of this variety, as the parent birds. This plan would not receive the sanction of the breeders of any other kind of stock whatever, simply on account of its inevitable tendency to produce deterioration of character in the offspring; nor have I the slightest doubt in my own mind but that the determination of Sebright amateurs to obtain small birds, by any and every means, has increased the difficulty of breeding them as much as the mistake of constant inter-breeding. Great care should be taken that all the stock birds have perfect rose-combs, as no others are admissible for competition; and imperfections of the comb are apt to prove hereditary for many generations, and are very difficult to breed out. Another very essential feature is the clear ground-colour of the old birds selected for stock, as even the slightest impurity in this respect is perpetuated in the offspring. In my remarks as to male Sebright Bantams, I particularly desire to be very distinctly understood. A cock of this variety for exhibition purposes undoubtedly should possess neither hackle nor saddle feathers; and as to the tail, should be altogether devoid of sickle-feathers—the hen-tail makes the perfect bird; but they rarely breed well, so for that especial reason are so much the more valuable when they do. When possessing a good hen-tail with the side tail-coverts regularly and distinctly marked, it is impossible to imagine a more beautiful specimen in any variety of fancy poultry. The gait of some of these birds is extraordinarily characteristic: I have seen the carriage so peculiar, that the head and tail have nearly touched each other if the fowls were a little alarmed; and the lacings on the breast and wing-coverts thus displayed itself to unusual advantage. In the Sebright chickens I have invariably found those covered with the darkest down, when first hatched, eventually made the best laced specimens; and that the lighter coloured are less distinctly laced, when adult, in exact proportion to the lightness of their colour when hatched.”

The assumption of the male plumage by barren hens has been already alluded to in the chapter on Game fowls. The change from the female to the male plumage, as before remarked, is always accompanied by perfect sterility, whether it shows itself in the hen pheasant or in the hen of any of the varieties of the domestic fowl. In those cases that have been hitherto observed, the barren hen has assumed the plumage proper to a male of her own variety. But in an interesting case made known to us by Mr. Hewitt, in which a Sebright hen assumed the masculine attire, the conditions are somewhat different. The male Sebright being perfectly hen-feathered, has no male plumage, properly so called, both sexes being feathered alike; consequently, if any change occurs in the plumage of a Sebright hen, it must be by the assumption of feathers which are not proper to the male of that breed.

The barren hen in the possession of Mr. Hewitt that has assumed a cock's plumage, has the hackle-feathers fully four inches long, narrow and pointed, with broad dark margins and a narrow line of white running down the centre of each feather. The saddle-feathers are five inches in length, narrow, pointed, and

beautifully and regularly laced with a dark border around a light centre. The sickle-feathers are fully a foot in length, arching over in the most perfect manner, light in colour, and tipped with black at the extremities.

This case is a very remarkable one. That the barren hen, in assuming the male garb, should, as it were, become more masculine than a cock of her own variety, indicates very strongly that the hen-feathered condition of the male Sebright is an abnormal variation which has been propagated by the careful process of artificial selection, and which would soon be merged in the general stock, were it not kept up by care and attention on the part of the poultry fanciers.

BLACK AND WHITE BANTAMS.

Black Bantams constitute one of the established classes at the poultry exhibitions; and judging from the great improvement that has been effected in them during the last few years, are certain to maintain their position for the time to come. A lengthened description of their characteristics is not required, inasmuch as the plumage should be a uniform black, without the slightest trace of any other colour. In the cock the lustre of the feathers should be decided, reflecting the same resplendent metallic purple tints that are seen in high-class Spanish; the hens of course being of a duller hue. The comb in the cock should be a bright crimson rose-comb; the wattles and face red; the ear-lobes perfectly white, strictly defined, and not implicating the face; the tail should be full, carried jauntily towards the back of the head, and with well-arched sickle-feathers; the legs short, and black or dark leaden-blue in colour.

White Bantams, although, like the Black, established favourites at our shows, scarcely require a more detailed description. The smallest possible size consistent with health and condition, a plumage of immaculate whiteness, a full sickle-tail, neat rose-comb, red face, white ear-lobes, neat small-boned white legs and feet, include their principal characteristics. In size they should be very diminutive, first-rate specimens not reaching one pound and three quarters a pair.

In the "Standard of Excellence" it is laid down as a rule that both black and white bantams are disqualified as exhibition birds if the cocks weigh above 20 or the hens more than 18 ounces each.

Mr. Hewitt, whose opinion is always valuable, has furnished us with the following notes on these two breeds:—

"Although the rule is strictly imperative as to Sebrights, that the male bird should be perfectly hen-tailed, the contrary holds good with both Black and White Bantams, in both of which varieties well-developed sickle-feathers are essential. When the tail is thus ample, it adds also very greatly to the general beauty of the bird. Of late years, at many of our poultry exhibitions, we have met with specimens far less in size than those formerly shown; and adult hens, in good condition, varying from ten to twelve ounces in weight, are not by any means rare, both among Black and White Bantams. The cocks will generally exceed the weight of their mates by about a quarter of a pound.

“A very prevailing fault in White Bantam cocks is an inclination to assume a yellowish tinge, or even a very slight saffron hue, across the shoulders and saddle, as they arrive at maturity, a defect which is fatal to the success of the pen at any exhibition, if competing with fowls without this drawback. It is also a fault that it is most difficult to eradicate, as it is apt to prove hereditary. For this reason the greatest care should be taken to avoid a male bird possessing this blemish, when selecting brood stock. Yellow or blue legs are also most objectionable in White Bantams; their legs should be clear white, without any stain whatever. Black Bantams, on the contrary, must have black legs. In both varieties the combs are rosy, and should be small, neat, and firmly seated to the head. Among Black Bantams it is by no means uncommon to find a cock of two or three years old assume a ruddy hue on the longest of the neck-hackles, and even occasionally to moult brassy-winged, or even red-shouldered. It is needless to say these fowls are then perfectly useless as showbirds; nor would I depend on any such bird for stock. I have seen this failing occur in a Black Bantam cock that had been hitherto considered as one of the best of his race; for three years he was perfectly black, and afterwards showed annually an increasing amount of the faulty colouring complained of. Perfectly white ear-lobes, by the striking contrast they afford to the colour of the plumage, greatly increase the beauty of a pen of this variety.”

GAME BANTAMS.

There is, perhaps, no variety of ornamental fowl that has sprung so rapidly into favour as this exceedingly beautiful and diminutive breed. A few years ago they were almost unheard of; but now the offer of a five-pound silver cup will secure an entry of forty or fifty birds; and a show hardly occurs in which there is not a class for them.

With regard to their origin, there is no doubt that they have been produced in two modes,—firstly, by the continued in-and-in breeding of the ordinary Game fowls, by which size has been lost, whilst the other characteristics have been in great part maintained: thus, Mr. Monsey, of Norwich, a well-known and very successful breeder and exhibitor of both Game and Bantams, has reared them very carefully, by closely inter-breeding the same strain of Game fowls for several years, and continually selecting the smallest specimens. On the other hand, by crossing a small Game cock with a Bantam hen, the requisite size has been obtained, although at a loss of some of the beauty of the breed. There is little doubt that both these courses have had their share in the production of most of the specimens now seen at our shows.

So much for the origin; now for the characteristics of the breed. These require very little detail. Game Bantams, both cocks and hens, should be exact and perfect diminutives of the ordinary Game fowl, not only in feather, which is easily obtained, but also in comb, eye, beak, form, carriage, and even courage; and just in proportion as they depart from this standard do they become



LEIGHTON, BRO.

WHITE AND GAME BANTAMS.



of less and less value. So universally is this fact recognized, that in the "Standard of Excellence," no distinct characteristics are printed for Game Bantams, it being stated with regard to their general shape and colour that they are the same as in the corresponding varieties of Game fowl, but that those cocks weighing above 24 ounces, or hens more than 20 ounces, are regarded as disqualified for competition.

The ordinary Bantam form, with short legs, wings scraping the ground, and the carriage of the head and tail like that of a fantail pigeon, is exceedingly objectionable when occurring in Game Bantams. What should be aimed at is the well-developed thigh and leg, and gallant bearing of the Game cock; with a long neck, and the wings closely pressed in to the body; the head should be exceedingly neat, although the beak should be massive at the root; but it is only a useless repetition to go over the points of Game Bantams in detail, for they are precisely similar to those already laid down in the chapter on Game Fowls.

With regard to colour, the black-reds have been most abundant, and are those most generally shown. In this variety the cocks are usually good, but the hens are apt to be faulty in colour.

Brown-reds are not as common as black-reds, but exceedingly good specimens are often shown. Duckwings, though not uncommon, are certainly not equal to the black or brown-reds. It is very rare to see a pen of Duckwing Game Bantams equal in colour to a good pen of full-sized Duckwing Game, but doubtless it will only require a few years more careful breeding to produce them as good in character as the other varieties. For many years Pile Game Bantams were regarded as great desiderata, and numerous were the attempts made to rear them by crossing the different breeds of Game Bantams with the common White Bantam. For a long time the efforts were not very successful, but at present we have Pile Game Bantams frequently appearing at our exhibitions; not perhaps showing the full merits of the other breeds, but still very passable specimens of the variety. White Game Bantams are still desiderata.

Of all Bantams the Game breeds are the hardiest and most self-reliant. They may be reared with safety anywhere; for, being active, vigilant, and possessed of great powers of flight, they readily escape from all pursuers; as sitters and mothers they are unsurpassed; and being active foragers, they find a large proportion of their own food, and when killed furnish the plumpest of all poultry for the table.

FEATHER-LEGGED BANTAMS.

The Feather-legged and Feather-footed Bantams were formerly amongst the most common of their race in this country. They were to be found of various colours, as black, white, yellow, and also speckled; and were larger than the birds of the present day, and more stoutly built. They possessed one great recommendation in their comparative inability to employ their booted legs for the purpose of scratching; their utility, therefore, in a garden, in destroying grubs

and insects, was not counterbalanced by much injury to the seed-beds and borders. The inordinate length of the feathers on their legs and feet was injurious to their chickens. In wet weather, especially, the young broods were apt to be entangled and crushed, and the employment of the hen as a mother was sadly interfered with.

Mr. Hewitt remarks concerning this variety that—"Perfectly bred birds of this description are now very rarely to be met with, although some twenty-five or thirty years since they were not by any means an uncommon variety. The old booted Bantam was a hardy and extraordinary-looking fowl, considerably larger, however, than the Bantams that we at the present time generally meet with; the point which Bantam-fanciers now consider all-important, diminutiveness, having been but little attended to, as they used to weigh nearly two pounds each. Booted Bantams are usually of a brown or grey speckled colour throughout, having either single or rosy combs, and very lively intelligent-looking faces. The most evident singularity of this variety is the extraordinary development of the feathers of the thigh, which in well-bred fowls are so lengthy as to wear away considerably (by the friction of walking) upon the surface of the ground. If any of the largest of these feathers are closely examined, they prove quite as long in the shaft as those of the wing itself. The 'boots' or feathers, extending along the outside of the legs to the feet (and in most instances to the two outside toes also), are frequently longer than the feathers of the wings themselves, especially if the fowls have been well attended to, and enjoy a walk where they are not likely to break them in pieces. By reference to my early memoranda of this breed, I find the longest boots I ever remember seeing were in a cock; they measured nine and a half inches on each leg. 'Muffs' (as they were formerly called) of seven inches long were easily acquired. From this peculiarity, these fowls scratch less in gardens than any I ever possessed; but few advantages prove real benefits if tested in all ways. The boots, during the time of incubation, are apt to drag the eggs from the nest; and not unfrequently, during the first few days of their existence, prove fatal to the chickens also; and should any of the long feathers on the leg be injured at the base, during their growth, they bleed very profusely. Booted Bantams are good layers, and the fowls themselves very plump and excellent for the table."

Some very good specimens of purely White Booted Bantams have been exhibited within the last few years, and certainly have been not the least attractive specimens of their race.

PEKIN OR COCHIN BANTAMS.

The most remarkable novelty that has appeared in the Bantam classes at our poultry shows for several years past is unquestionably the singular variety known as the Pekin Bantam. These birds may be described as miniature Cochins, bearing the same relation to the full-sized Buff Cochins that Game Bantams do to ordinary Game fowls, but with a still greater disparity of size between the two

racés. So close is the resemblance of the Pekin Bantams to the colour, form, and feathering of the Buff Cochins, that on their first exhibition it was generally imagined that they had been bred down from the large variety, in a similar manner to

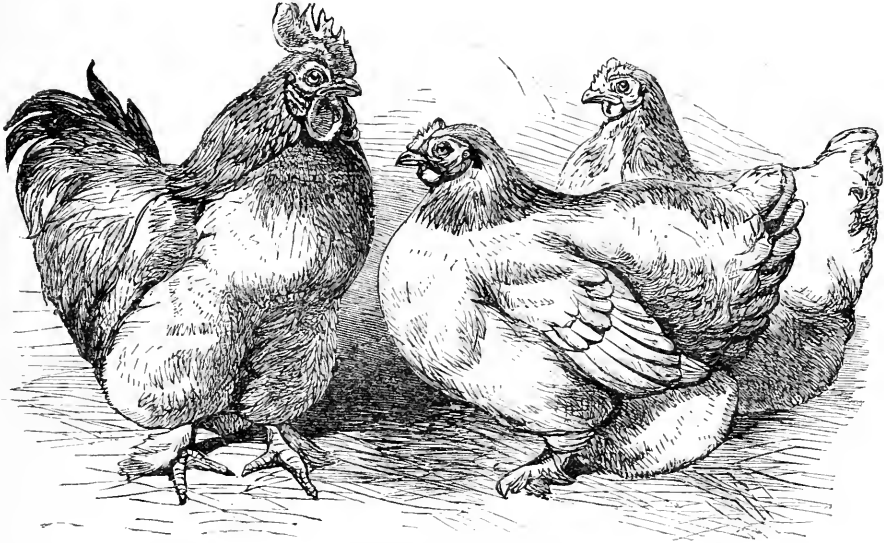

PEKIN OR COCHIN BANTAMS.

that in which the Game Bantams had been produced from Game. On inquiry, however, we find that the breed did not originate in England, but that the birds were obtained from China at the sacking of the Summer Palace at Pekin. During the occupation of the Palace by the British, a pair of these Bantams used to come daily into the officers' tents to be fed; and as a quantity of spoil was being collected to be sent to England, these two were caught up and forwarded. This pair were the progenitors of all those since reared in England. The very close in-and-in breeding necessitated by the introduction of only a single pair has had its inevitable result in the want of fertility in the eggs, and great mortality of the chickens; consequently the great drawback to these very singular little birds is the extreme difficulty of breeding them; as the chicks die in the shell, at various stages of development. Under these circumstances, it is obvious that unless some new blood be introduced, this very quaint variety will become extinct. As the probability of any fresh importation from Pekin is rather doubtful, we should strongly recommend the introduction of fresh vigour from another breed, and the subsequent restoration of the desired characters by careful selection of brood stock. Thus a small nankin-coloured Bantam hen, placed with these birds, would produce half-bred chickens; of these, one or two of the pullets most closely resembling the Pekin Bantams should be reserved, and matched with a pure bred Pekin cock. From this union would result chickens three-fourths Pekinese. The hens of this latter cross, again mated to a Pekin cock, would produce birds of seven-eighths Pekin blood; and if care were taken and judgment exercised in the selection of

the breeding stock, there would not be the slightest visible trace of the bar sinister in their escutcheon.

With regard to the characteristics of these quaint little orientals, much need not be said; their form is so correctly given in the sketch by Harrison Weir that a lengthened description is not required. The fluffy plumage, the uncouth cochin form, the feathered legs and single comb, are admirably portrayed.

As they are regarded as Bantams, it is needless to insist on the fact that the smaller the size the more highly would the specimens be valued in the show-pen. Pekin Bantams are stated to be good sitters and mothers; the males even take a share in brooding the chickens; but they have been too recently introduced into this country and too sparsely distributed for their merits to be generally appreciated.

Since the above description has been in type, we have received the following interesting account of the cross-breeding of these birds from one of the most successful exhibitors of the variety, who states:—

“The first pen ever exhibited was at the last show ever held at the Crystal Palace. I believe that was in the year 1863. Whenever I have heard of these birds being shown I have made inquiries about them, and can only find traces of the one original stock. To remedy the mortality of my chickens, I last year procured a White Feather-legged Bantam hen with single comb, and penned her with a Pekin Bantam cock; from them I reared one cross-bred pullet, which I mated with a Pekin cock. I have now hatched from her eggs some very fine chickens, that can scarcely be distinguished from the pure-bred birds, excepting that they carry the tail rather too high. I think in another season I shall be able to breed out that defect as I intend to put a cross-bred cock to the pure Pekin hen and also breed from the pure-bred cock with the cross-bred pullets. I have no doubt I shall obtain chickens very like the original. The cross-bred chickens that I have raised this year have been very strong and easily reared.”

JAPANESE BANTAMS.

The comparatively recent extension of our intercourse with the Japanese people has resulted in the addition of a new variety to our list of Bantams.

Examples of the Japanese breed have been frequently exhibited at our shows, and good specimens have almost always secured prizes in the class for new varieties of Bantams.

The birds of this breed may be described as exceedingly short-legged, full-feathered, little fowls, with largely-developed single combs, and very full-sized well-sickled tails.

In colour they vary very much; some are marked in precisely the same manner as the Cuckoo Dorkings, both cocks and hens showing the same transverse bands of dark greyish blue over a lighter ground-colour; others are variously marked and speckled; but by far the prettiest arrangement of colours in the plumage is found in those that have pure white bodies and wings with flowing black sickle feathers in the tail.

This combination is very elegant, and is rarely passed over without notice by the judges at the poultry shows.

In addition to these varieties some small Frizzled-feathered Bantams have also been introduced from Japan.

NANKIN BANTAMS, ETC.

Before the advent of Poultry shows had led fanciers to look for breeds characterized by strongly-marked and very distinctive peculiarities, several varieties of Bantams were to be found in different districts of the country. Some short-legged breeds were known as Creepers, or Jumpers, from the nature of the locomotion necessitated by the extreme shortness of their shanks; others were named from the marks upon their feathers, as the Spangled and Partridge Bantams.

At the present time a variety of a slaty, or blue-dun colour, closely approaching that of the Andalusian Fowl, or blue-dun Game Fowl, are sometimes exhibited, under the name of Fly-fishers, probably from the fact that their slate-coloured hackle-feathers are in considerable demand amongst fishing-tackle makers, for the purpose of manufacturing artificial flies.

One of the most common of the old Bantams was that known as the nankin or yellow breed. These, although now seldom exhibited, still have their admirers. Their prevailing colour is that of the pale orange yellow of the nankin cotton. The hens are usually slightly pencilled on the hackle; and the cocks show an intermixture of darker colours on the wings and saddle, and a well-arched dark tail: they usually possess double or rose-combs, and dark unfeathered legs.

Such are the principal varieties of Bantams at present known in this country. The different breeds have been so generally diffused that they have inter-bred not only with each other but with the smaller varieties of the ordinary fowls; consequently there may be seen in many poultry yards mongrel Bantams of every conceivable variety, that possess no distinctive character beyond that of being more diminutive than the ordinary fowls.

The chickens of almost all the varieties of Bantams are hardy, and sufficiently easy to rear, provided they are kept from wet during the first week or ten days of their lives, as at this early age the least dampness seems fatal to their well-doing. They do not require any particular dietary: a due supply of animal food in the shape of ants' eggs, or, failing that, custard as advised for Dorkings, oatmeal, grits and small tail-wheat, will rapidly get them through all the difficulties of chickenhood.

The hens are admirable sitters and mothers, and are generally chosen as foster parents of partridges it is wished to rear in a state of domestication.

Even as profitable poultry Bantams are not destitute of merit; in proportion to the amount of food they consume they furnish a very fair supply of eggs, which may be cooked on the breakfast-table by placing them in a basin and pouring

boiling water upon them, renewing it by a fresh supply in the course of two or three minutes. As table fowls the hardy little Game breeds are really excellent; plump, full-chested, and meaty, they may be served up as substitutes for partridges; and if they are allowed a free range in coppices, where they can supply themselves with a great variety of insect food, they acquire a game-like flavour, that adds very greatly to their value on the table. As useful and ornamental pets we know of no birds that are superior.

CHAPTER XXIV.

THE ORIGIN OF THE DOMESTICATED VARIETIES OF FOWLS.—THE JUNGLE FOWLS.

THERE is perhaps no subject in the whole range of poultry literature, on which more absolute nonsense has been written than on the origin of the different breeds of our domesticated poultry. In place of making any accurate scientific investigation into the facts of the subject, the majority of writers on poultry have adopted certain theories, and endeavoured to prove them by the most ridiculous statements, which they have gravely put forward as truth. If any naturalist wishes to read the absurd fancies of the compilers of treatises on poultry, we would advise him to turn to the chapter on "The Wild Fowls of India," in Messrs. Wingfield and Johnson's Poultry Book.

It is there stated that the Kulm cock of India, or St. Jago fowl, the *Gallus giganteus* of Temminck (a breed which is a domesticated variety nowhere existing in a wild state), is one of the races of wild Galli, to be regarded as the forefathers of our poultry yard.

We are also informed that "the Jungle fowl consists of two distinct species," the Bengal Jungle fowl, and the Sonnerat Jungle fowl, and that the *Gallus Stanleyi* (which is in reality the wild fowl of Ceylon, and a perfectly distinct species), is "a variety of Sonnerat's fowl."

Although Jungle fowls are said to be of two distinct species, the writers state "that many of our present breeds of fowls may have been derived from these four species—*Gallus giganteus*, *Gallus Sonneratii*, *Gallus furcatus*, and *Gallus Bankiva*, we have little doubt. But still these are not necessarily to be regarded as the sole ancestors."

After this definite statement, one would hardly expect to find on the same page that *Gallus furcatus* "seems to possess no tie that might connect it with our domestic race." Such are the blunders of compilers who write on subjects on which they are perfectly ignorant. Amongst other ridiculous statements in the same chapter, is one that the Black-red Game is descended from the Bengal Jungle fowl, and the Duckwing from the Sonnerat, the authors, or rather compilers, ignoring three facts, the knowledge of either of which would show the absurd nature of their theory: first, that the hybrid Sonnerats are almost always sterile; second, that they possess the peculiarly flattened shaft to the feather, which so strikingly distinguishes the Sonnerat cock, and which is absent in every domestic variety; and last, that Black-red Game fowls may be bred from Duckwings, Duckwings from Black-reds; in fact these birds are habitually reared

in this manner, as may be ascertained by reference to the chapter on Game Fowls in the present volume.

We have quoted these remarks to show the amount of ignorance that prevails respecting the origin of our domestic breeds, selecting Messrs. Johnson and Wingfield's book as being comparatively recent, and the most pretentious work that has been published on the subject.

Leaving the absurd conclusions of the mere bookmaker for the investigations of men who are of the highest authority as observant naturalists, we arrive at a totally different conclusion.

Three of the most eminent naturalists of the present day, working independently of each other, and regarding the same facts from different points of view, have come to a similar conclusion respecting the origin of our domestic breeds—a conclusion that must be acquiesced in by all who have studied their premises. It is that there is but one species from whence all our domesticated varieties have descended, and that that species is the common red Jungle fowl, the *Gallus ferrugineus*, of India.

Mr. T. C. Jerdon, the author of that admirable work, "The Birds of India;" Mr. E. Blyth, whose opportunities for personal investigation into the history of these birds has been unusually great; and Mr. C. Darwin, whose attention has been devoted for many years to the study of the subject of variation in our domesticated animals, have all independently arrived at this conclusion.

The facts on which their inferences are based are too numerous to be detailed at length in a work of the character of the present volume, but they may be briefly alluded to. In the first place, no one of the numerous domesticated varieties exists in a wild state; the forests of the tropical world know no such fowls as the Kulm cock, the Silky fowl, the Cochin, the Frizzled fowl, the Bantam, &c., &c., as is so constantly stated by writers on poultry.

Such being the case, we must either imagine the origin of our domestic breeds to be some species that no longer exists in the wild state;—or to be some existing wild species;—or to be the result of crosses between several existing wild species. The first supposition is most improbable. We know that the jungles of India offer to birds by far too secure an abode for us to imagine that the original breed of poultry has been exterminated. The improbability that our breeds are the results of crosses between two or more species has been already alluded to. The investigations of Dr. Salter, which were detailed at length in the "Natural History Review," prove most convincingly that the hybrids so produced are deficient in fertility, and that the cross-bred races soon die out, even under the most favourable circumstances. Moreover, their plumage is unlike that of any domestic variety. Hence we are reduced to regard the common Jungle fowl, the *Gallus ferrugineus* of Gmelin, as the original species from whence all our varieties are derived.

To the minds of persons unaccustomed to study the extent of variation in species, this conclusion may appear very forced and unnatural. That the Cochin

and the Bantam, the Game cock and the Silk fowl, had but one origin, seems at first sight incredible; but the existence, in other species of animals, of varieties as diverse as these is universally acknowledged. The gulf between the European and the Negro, or that separating the Turk from the Tasmanian, is as great as that between any two varieties of fowls. The toy terrier and the gigantic St. Bernard are as diverse as any two gallinaceous varieties.

Such being the conclusions arrived at by the most eminent authorities on natural history, it is desirable that we should possess a detailed description of the form, plumage, and habits of the wild original of our domestic breeds. For this purpose we take the liberty of quoting, with some slight additions from Jerdon and other authorities, the following most interesting account of the Jungle fowl, from the pen of a well-known Indian ornithologist, who has published the results of his observations in *The Field* under the signature of Ornithognomon.

The genus *Gallus* includes several distinct species; the *Gallus ferrugineus*, also called the *Gallus Bankiva*, of Continental India; the *Gallus Sonneratii*, of Southern India only; and *Gallus furcatus*, of Java; the *Gallus Stanleyi*, of Ceylon, which resembles the *Gallus ferrugineus*, but is red beneath; and several other doubtful species, as the *Gallus Aeneus*, supposed to be a hybrid between the *Gallus furcatus* and *Gallus ferrugineus*; and a species has been lately described from Batavia under the name of *Gallus Temminckii*.

The common Jungle fowl of India is the *Gallus ferrugineus* of Gmelin, the *Gallus Bankiva* of Temminck, the "Bunmoorgh," or "Junglee Moorgh," of the Hindostanians, "Bunkookra" (Bengali), "Geragogor" (Gonds), "Natsoopia" (Botan), Paroktshee (Lepchas of Dorjelling), "Beer seem" (Koles), "Tauquet" (Burmese), "Ayamootan" (Malay), "Brooga" (Sumatra), "Bengkicoo," or "Bengkeekó" (Javanese).

The cock measures, from the tip of the bill to the tip of the tail, about 26 inches; 2 feet 3 inches across the stretched wings; the length of the closed wing is from 8 to 9 inches; the tail measures 15 inches; the leg or tibia is 4 inches long; the tarsus or shank, 3 inches; the middle toe, $1\frac{3}{4}$ inches; the spur, 1 to $1\frac{1}{2}$ inches; and the weight of the bird is about $2\frac{1}{4}$ pounds.

The hen is only 1 foot 5 inches long, the length of the tail 7 inches, and the wings spread 2 feet.

These dimensions, which are taken from average-sized specimens, show how domestication and feeding have increased the size of our common breeds, some of which almost rival the turkey in size.

The following are the points indicating the pure wild breed:—

The form is bulky, broad across the back and shoulders, the bird standing high and very erect, with protruding breast and a nearly horizontal tail, the tips of the centre feathers of which barely clear the ground. The plumage is thick, and the feathers of the neck and upper tail-coverts are linear, pointed, and drooping. Head and face bare, with a small circular patch of feathers over the ear-hole. The comb is high and serrated, rising from nostrils and overhanging the occiput.

There are two wattles under the base of the bill, and a smaller pendulous flap under each ear; in the female both comb and wattles are rudimentary. The bill does not alter in domestication. Legs stout, rather lengthened, with a single row of scales in front, and a double row behind, the sides of leg being reticulated. Toes rather short, and webbed to nearly their first joints; a large spur on the inner side of the shank, about three-quarters of an inch above the thumb, attaining a length of one inch and a half in old birds. The wings are short and bowed; the quill-feathers suddenly narrowed from near their bases; the fifth and sixth primaries are the longest; the secondaries very little shorter. The tail is composed of fourteen feathers, shaped as in the barn-door cock, but not held so vertically.

In the cock, the iris is orange; the bill, horn colour; legs, blackish-lead colour, with a slight green tinge; the face, comb, wattles, and throat, fleshy carmine; neck and head feathers, bright orange, pale and golden where flowing over the back; the feathers at bottom of neck, black at the bases; back, rich deep vinous rust colour; lower back and upper tail-coverts, fiery orange, the latter golden-tipped; tail and its longest upper coverts, or sickle-feathers, black, glossed with green; wing-coverts like those of the back, but the two-last rows black, glossed with green; the secondaries, chestnut on the outerweb, and dusky within; the primaries dusky; all the lower parts black; the ear-coverts are white in the Bengal birds and orange rusty in the Burmese and Malayan varieties.

The hen has the skin of the face a paler red than in the male; legs, livid horn colour; crown, ear-coverts, and throat, vinous rusty; rest of neck, golden tawny; each hackle is centered with brownish-black, and the larger ones are shafted with tawny colour within the black. All the upper parts are full burnt-umber brown, the feathers vermiculated and centered sepia, with pale tawny shafts; the side tail-feathers are plain sepia, as are the inner webs of all the remiges; all under parts vinous reddish-brown, the shafts pale; primaries and their coverts, plain sepia, with the outer margins ashy.

The breast and under parts of the young cock-birds are much broken up with rusty-coloured feathers, and in the first moult both sexes are similarly coloured mottled brown, with dusky wings and tail; when first hatched, the chicks are covered with cream-coloured down, and have sepia-coloured bands along centre of head and through the eyes.

Every poultry fancier will at once recognize the fact that of all our domesticated varieties, the breed which most closely resembles the Jungle cock in colour, form, and carriage, is the Black-breasted Red Game. If the tail of a small Game cock of this variety were depressed so as to be carried horizontally, it would be difficult to distinguish the bird, provided it had not been dubbed, from the descendants of its wild progenitors, and now roaming at large in the Indian jungle.

The Jungle fowl is found all over Continental India wherever jungle exists—to the westward, as far south as the Vindhian range and the Raj-peepla Hills; to the

eastward it extends into the Madras Presidency as far as the Godavery, where it meets with Sonnerat's Jungle fowl, individuals of the two species frequently interbreeding. It is more abundant to the eastward of the Ganges, through the vast Teraij and Morung forests, Dacca, Silhet, and Chittagong; and, farther south, through Arakan, Burma, and Tenasserim, Malayana, and the islands of the Archipelago as far as Timor and the Bonin Isles. All the individuals in the Indo-Chinese countries are subject to a trifling variation, having the ear-coverts red or rust coloured instead of white. The birds found in the Cis-Himalayan range are said to be paler coloured than those farther south.

In India proper I have found this bird more numerous to the south than to the north of the Ganges. It is off the alluvium in the dry, stony jungles between Midnapoor and Chota Nagpoor, that the Jungle fowl are met with in the greatest numbers. In favourable situations, such as the narrow strips of cultivated land in the woods, I have, after the crops have been reaped, seen as many as twenty or thirty together gleaning about in the stubble; and where the country is thinly inhabited they will, in twos and threes, advance pretty boldly into the open. They are at all times excessively timid and wary. When approached in open spots, far from covert, they take wing as readily as partridges, springing with a loud flutter, and flying steadily and strongly to the jungle, with rapid beats and alternate sailings of their wings. They alight generally within the edge of the covert, and then run so long and swiftly as to render it quite hopeless to follow them. There is no bird more difficult to approach, or even to see, when in the jungle. The cocks may be heard of a morning or evening crowing all round, but the utmost precaution will not, in most cases, enable the sportsman to creep within shot or sight of the bird. The hen, too, announces the important fact of having laid an egg with the same vociferation as in the domestic state, but is silent ere the stealthiest footstep can approach her hiding-place, and, gliding with stealthy feet under the dense foliage, is soon far away in the deep recesses of the jungle. To a stranger it is not a little curious to hear the familiar sounds of our farm-yards issuing from the depths of the wild forest. The crowing of the cocks, the cackling of the hens, the chirruping of the chickens, are precisely the same as we have been accustomed to hear since the earliest dawnings of our intelligence, and, associated as the homely sounds are with civilization and domestication, they appear out of place in the solitude of the jungle!

Owing to its secluded life, the breeding habits of this bird are very little known. A question has arisen amongst naturalists as to whether the cock in its natural state is monogamous or polygamous. I am inclined to think the latter, from seeing always so many hens to one male bird, and this in every season of the year. The information I have gathered from birdcatchers, who are in the jungles during the twelve months, certainly confirms the above conjecture. The period for incubation varies according to locality, but is generally at the beginning of the rains—*i. e.*, June. I have seen eggs, however, in March, and Jerdon says the hen breeds as early as in January and as late as July. She selects for this purpose some secret thicket in the most retired and dense part of the jungle,

scraping together a few leaves on the ground by way of nest. She remains as part of the cock's seraglio until some seven or ten or a dozen eggs have been deposited in the above spot, to which she stealthily repairs every day, and finally quits her party and retires alone and unseen to perform the duties of incubation. The chicks are hatched, as usual, in about twenty days, and follow the mother soon after they have emerged from the eggshell; and she leads them about, teaching them how to find their own sustenance, till they are big enough to shift for themselves, by which time the young cocks, finding that they cannot in honour come within a few yards of each other without a battle, separate, each one taking a number of hens with him. These particulars I have gathered from native informants; but I can add from my own experience that either the season of incubation is uncertain, or that the hens lay in the cold weather with no more ulterior views than the domestic birds, for both in February and in March I have heard them emit that peculiar cackle, "*Tuk-tuk-tuk-tuk-takauk!*" by which, every one knows, a hen in a farm-yard proclaims to the good housewife a fresh acquisition to her larder.

The flesh of the Jungle fowl, under favourable circumstances, is the most delicious of all game, but that of the old cock is beyond human powers of mastication. A young bird hung till moderately high can hardly be distinguished in flavour from the pheasant. The pugnacity of the male is as great in its wild state as in domestication, and affords ready facilities for its death or capture. The Burmans and Talaings pin down a tame cock or tether him by the leg in some spot frequented by wild poultry, when his cries soon attract a knight errant of the tribe either within range of a gun, or the grasp of snares thickly set round the decoy.

As may be supposed, the Burmese and Arakanese, gamblers from childhood, are well versed in the mysteries of cock-fighting. They do not clip the birds, as the promoters and followers of this amusement in England do, but give them the full benefit of their plumes, and arm them usually with but one "steel," a tremendous weapon, in shape and size like a large penknife, and which generally proves fatal in a very few rounds. The great mass of the poultry in Burma and Arakan is of the Game breed, descended from *Gallus ferrugineus*, but having acquired in process of time yellow legs and great increase of size.

Though the voice of the Jungle fowl has no pretensions to melody, it possesses great variety of intonation and expression. The crow of the male is too well known to require description. The cry is a challenge to combat, doubtless, but at the same time is regularly periodical, the inclination to "crow" coming upon the bird apparently every three hours—that is at the commencement of every fresh watch, a division of time descended from remotest antiquity. When the cock has discovered some food, which he considers might be acceptable to the members of his harem, he calls them to the spot with a deep, soft clucking, similar to that which the hen employs to feed her young, picks up and lays down the morsels before them, and while they are greedily feeding, struts about with

great pride and an utter disregard of his own gastronomic requirements. Indeed, were it not for a mouthful now and then taken on the sly, it is difficult to conceive how the cock manages to sustain his portly body. On rare occasions intense hunger seem to overcome the poor fellow's sense of his devoirs to the fair sex, and I have at such moments, to my great amusement, detected him in the act of furtively swallowing a choice bit, or bolting it in the face of dame Partlet, to her astonishment, just as she had been invited to partake of it herself. When danger threatens, especially in the shape of a hawk or kite in the air, the cock utters a long, low croak, an unmistakable warning to "look out," on which the whole community of hens and young birds scamper under cover, while the chief remains ready to fight all comers. These birds roost always on some eminence in a wild state, on trees in the jungle; and before all the party has settled to sleep the male occasionally gives a low, prolonged cooing whistle, to which a hen or two sometimes respond. As morning dawns they leap silently to the ground, and remain feeding about, and at or near six o'clock the cock mounts some elevation, and begins to crow at intervals for a quarter of an hour or so, after clapping his wings together two or three times back to back.

This bird must be sought in all jungly country which is partly cultivated; and where paddy fields extend in long strips into the forest, two sportsmen walking one on each side just within the cover, with a line of beaters between them, can enjoy very pretty shooting. The fowls rise from the stubble and fly into the wood, passing over head, and the sport resembles pheasant-shooting in England, the flight and size of the birds being pretty similar. When the fields have been cleared of the fowls, the shooting may be continued with success in the woods if they be pretty open, and the sportsman furnished with spaniels; which cause the birds to tree, from whence very pretty snap-shots may be obtained, as they will often rest on a high branch till the sportsman has arrived underneath before taking wing again. Both cocks and hens make a desperate cackling and flutter when thus roused up by dogs, and I know of no shooting which requires greater nerve and steadiness. If there are no dogs the birds will not tree, but run slyly and silently along and are seen no more, unless you be mounted on an elephant, when it is easy enough to pot them, should you be so minded, as they skulk under the brushwood. The wild poultry are not subject to migrations, even to the extent to which pea-fowl shift their quarters; but in the hot season and the rains they retire deeper into the woods, the cultivated tracts no longer affording food, while the sylvan recesses provide seclusion and shelter for breeding.

It may be asked, What are the processes by which all our various breeds have been derived from this one species? The explanation is not difficult. All animals, even those in a wild state, are subject to variation; differently coloured and formed individuals of every species are occasionally observed. These variations occur much more frequently amongst animals in a state of domestication; and mankind, from the remotest ages, have observed that such changes are hereditary; hence,

when any variety has been noticed which it has been thought desirable to perpetuate, the progeny have been preserved. This process of artificial selection has been carried on for generation after generation: where great size has been required, the largest specimens have been selected for brood stock, and our Cochins and Brahmas have been the result. On the other hand, when smallness of size has been aimed at, the best specimens have been selected, and our bantam breeds have been thus produced.

Colour, form, and even character, have been varied in the same manner. Amongst the old cockfighters, a game cock that would not fight was killed and eaten, and the race was perpetuated by those birds having the highest strength, agility, and courage. In the same manner variations of habit were rendered permanent. Eggs were required in larger numbers than chickens, and our new sitting varieties were the result of the care shown in the selection of breeding stock from those fowls that were the best layers and showed the least inclination to sit.

The varieties that were produced with so much care, require the same attention for their continued perpetuation; without it, all our valuable domestic animals would degenerate into a comparatively worthless collection of mongrels, destitute of the good qualities that distinguished so many of those varieties that are now characterized as pure breeds.

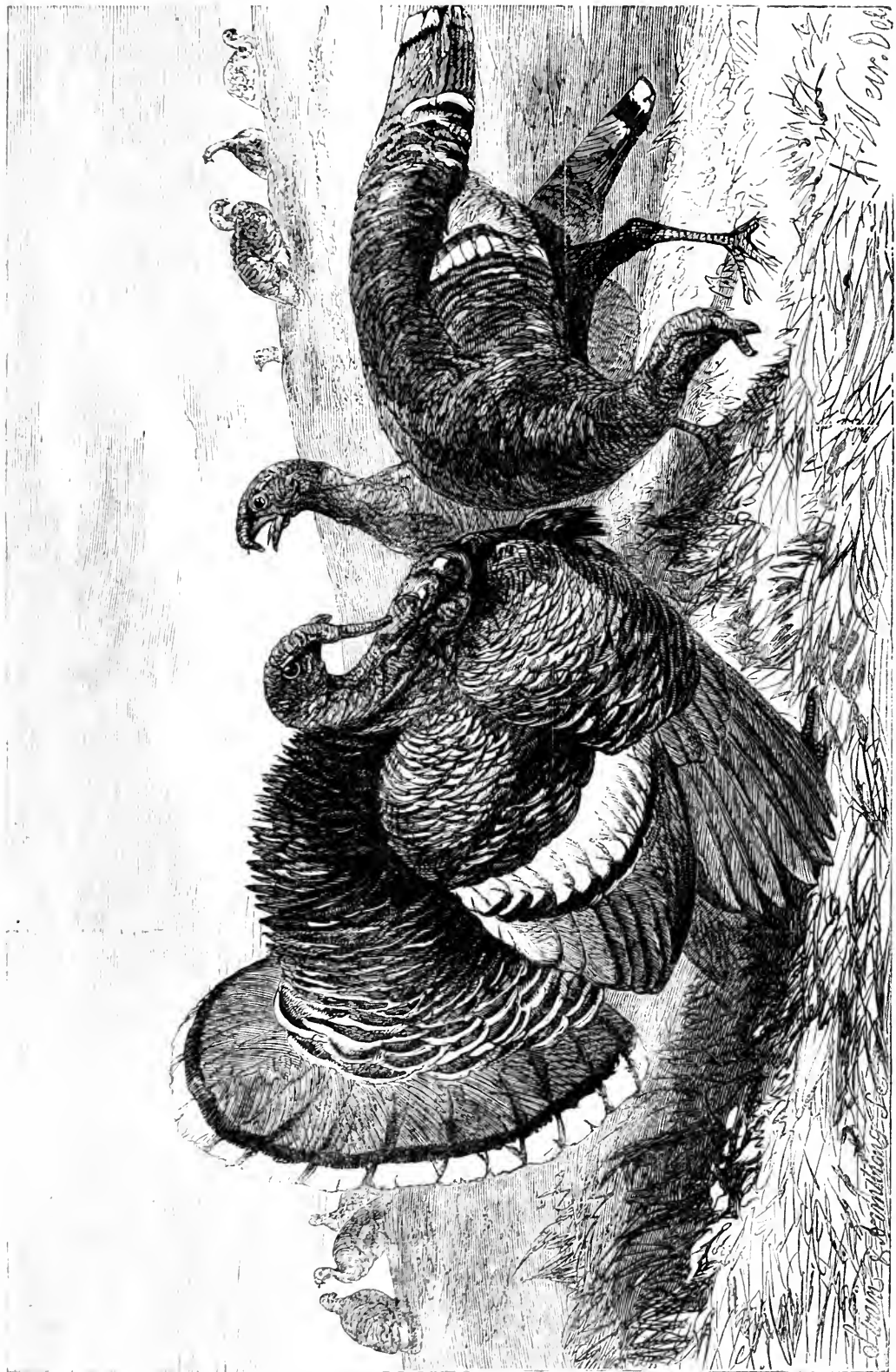

TURKEY.

H. W. C. D. C.
J. H. B. A. M. I. O. N. S. C.

CHAPTER XXV.

THE TURKEY.

THE origin of the Turkey of our farm yards is, like that of many other of our domestic animals, a matter of very considerable uncertainty. If there is one fact more clearly ascertained respecting the Turkey than another, it is that it is certainly not descended from the common wild American species, as is generally stated by the compilers of the greater number of our works on poultry.

The different wild species of the genus *Meleagris*, known to naturalists, are only three in number:—the Wild American Turkey, common to Canada and the United States, *M. Americana*; the Mexican species, *M. Mexicana*; and the Ocellated Turkey of Honduras, *M. Ocellata*; and in addition, we have the tame bird, *M. Gallopavo*.

As the wild American species is so generally regarded as the origin of the domestic breed, it is desirable to describe it somewhat in detail; we therefore quote the following from the report of the American Department of Agriculture for 1864, in which Mr. Elliot states:—

“When full grown, the male will measure four feet in length and nearly five feet in the stretch of its wings. The naked skin of the head and neck is blue, with the wattles red, as are also the legs. The feathers of the neck and body generally are a coppery bronze, changing in some lights to a greenish or purplish shade, and margined with an opaque line of velvet black. The back and rump are also black, and tipped with a light chestnut. Near the end is a band of black, broadest on the outer feathers, and narrowing as it approaches the central ones. Between the bars on the feathers is a confused sprinkling of black. Neither upon the tail nor its coverts is there any white, and this is one of the means by which the wild bird can always be distinguished from the domesticated. From the centre of the breast hangs a long, coarse, hairy tuft, sometimes not found in the other sex. The female differs principally from the male in being smaller in size, less brilliant in colouring, and in the absence of the spur, and the fleshy process at the base of the bill.”

A well-known sportsman and traveller, Captain Flack, writing in the *Field* under the signature of “The Ranger,” gives the following graphic account of the habits of this species:—

“ The best Game bird of America, and, at the same time, the largest and the wildest, is the wild Turkey (*Meleagris Americana*). There are four distinct species of turkeys known. The first is the American bird, once abundant throughout the Atlantic States, but now rarely found east of the Mississippi, except in the Southern States. In Florida, Alabama, Mississippi, and Louisiana, there are yet a great many left, and probably they will find security in the tangled forests and canebrakes of those states, for many years to come; but west of the Mississippi, in Arkansas and Texas, they are, except here and there, as plentiful as they ever were. The second is the Mexican, *M. Mexicana*; it is found upon the high table lands of Mexico, and throughout the Rocky Mountain district. It is reported to differ materially from the first in many points; but as I have never seen the bird, I can personally give no opinion. The third—the Ocellated Turkey, *M. Ocellata*, of Central America—has the plumage of his neck, breast, and body almost as gaudy as a peacock's tail: its fine metallic tints flash with green, with purple, and gold in the sunshine. The fourth and last is the tame species *M. Gallopavo*; and most likely this—as is supposed to be the case with nearly all our domesticated animals—has been tame for ages. Doubtless the original of domestic cattle, sheep, horses, camels, pigs, fowls, ducks, and, in all probability, turkeys, have existed tame as long as domestic man; and if, as has been stated, the Spaniards found a tame breed of turkeys possessed by the inhabitants both in Mexico and the West Indian Islands, it would go far to prove that the domestic turkey is a distinct species; for though thousands of wild turkeys have been hatched under barn-door fowls, they have invariably strayed off the following spring to their wild kindred in the forests, with whom they have remained, and all attempts to retain the wild turkey as a barn-yard fowl have completely failed.

“ The wild turkey cock is never seen fairly but in the forest. The war-horse, described by Job, and the sorriest hack on Hampstead-heath, when his Sunday troubles are over, would present scarcely a greater contrast than does the wild bird to the tame; nothing alive shows more points of health and purity of blood than does this fine bird. His clean game head is fully four feet from the ground, and his bright hazel eyes are full of intelligence and suspicion, so different from the dull expression of the tame bird. His great breadth of shoulder, deep chest, and clean, firm step, must strike the most superficial observer. The general tints of the ‘gobbler’—for he is a far handsomer bird than the hen, and generally twice the latter's size—are purple, and a deep, rich brown, with various shades of gold and violet colours gleaming upon his close-lying plumage, as the sunlight plays upon their surface. The head and neck, where bare of feathers, are of a darker blue than in the tame variety, whilst the tuft, resembling horse hair, which hangs from the breast, often measures, in full-grown males, nearly a foot. I have one by me which measures eleven inches; the turkey upon which it grew, and which I killed, weighed thirty pounds. I have heard of others weighing greater weights than this, and some are even stated to have reached forty pounds; but I have never seen them, though I do not dispute that such have been killed.

“If the weather is mild and warm towards the end of February, the forests, just before day and at daybreak, are filled with the gobblings of the cocks, and the responsive cluckings of the hens; and this continues through March and April. By the close of the latter month the clucking has almost entirely ceased, as the hens are upon their nests, which they keep carefully concealed from the gobblers. These latter, at this time, worn out with their amorous duties and battles with their rivals, are nearly mute; and now, having nothing to fight about, and being weak and thin, wander about by themselves through the summer, too worthless for powder and shot. So poor are they, that they have given rise to an Indian proverb, ‘As poor as a turkey in summer.’

“The hen generally makes her nest some two or three hundred yards from the edge of the forest in the prairie, and never very far from water, to which, being a thirsty bird, she makes about three visits a day—in the morning, at noon, and in the evening. Prairie sloughs, which run out some distance from the main timber into the prairies, and which have some little timber upon them, are favourite nesting places, as she can steal from the forest, under the shelter of the straggling timber, undetected by the gobblers, gain her nest on the prairie, and sit in peace; as the gobblers at this time, poverty-stricken and ashamed of themselves, seek the thickest parts of the woods to hide in, and rarely then venture into the open. But, poor or fat, whenever the cock finds a nest he breaks it up, and he never neglects to break the skulls of all the young chicks he comes across.

“The chicks when hatched are very small, and covered with a more hairy covering than the down which young tame turkeys have. If the season be a dry one they thrive very fast, as insect food is abundant; but whenever it is a wet season the young ones ‘fare but middling,’ as they are particularly tender, and are easily killed by damp and chilly weather. Upon the dryness of the season, therefore, the turkey-hunter builds his hopes of the plentifulness of his game.

“By October the young birds have become nearly full-grown, and able to take care of themselves; the hens have recovered the flesh which they had lost by sitting, whilst leading their young in pursuit of the myriads of grasshoppers which swarm on a southern prairie during the summer; and the gobblers having picked up their good condition by feeding upon wild grapes, blackberries, mulberries, nuts, grubs, and the thousand-and-one treasures scattered in the forest, and so, all feeling strong and fat, they gradually join their forces and form ‘gangs,’ as the backwoodsmen call them, often consisting of a hundred individuals or more in each gang. From this ‘gathering of the clans,’ October is named the ‘Turkey month’ by the Indians.

“At this season the turkeys wander over a great extent of country in search of ‘mast,’ remaining in one place only so long as the acorns, pecan nuts, and other food remains plentiful; and when that is exhausted they move on in search of more, rarely rising unless they have a river to cross, or are flushed by a hunter’s dog, or by wolves, foxes, wild cats, &c. When the river to be crossed is a very wide one, such as the Mississippi, they often spend a day or two upon its

anks, as though considering the difficulties of the attempt. During this time the males strut backwards and forwards, their 'fans' expanded, their wings sweeping the ground, and their throats rolling out gobble after gobble in quick succession, as though trying to inspire the hens and young birds with courage for the undertaking. Finally, when the courage of all has been wound up to the proper pitch, the whole flock flies up into the tops of the highest trees, where they sit a short time longer, stretching their necks out towards the bank they desire to gain, as though estimating the distance to be crossed, as well as gathering breath for the prolonged flight. At last, seemingly at a given signal, all take wing; but in their progress across there is always a descent, and few except the strongest ever land much beyond the bank, the younger and feebler often falling into the water.—not always to perish, for they can swim a little; but many frequently gain the bank, exhausted and bedraggled, only to fall a prey to some wolves or wild cats, who, warned by the two or three days gobbling on the opposite bank, are on the look-out for 'wrecks.' Very often the backwoods-squatter also profits by the flight, for, having heard the noise, he prepares to secure a few to lard down in a barrel for future consumption at his wigwam. Judging, from former flights, where the 'gang' will make his side of the stream, he lies concealed, and when the flight does take place, he takes advantage of the birds' necessities, and secures 'a right smart chance of 'em.'

"From October to February the turkeys remain in larger or smaller companies together, when, as before stated, the preparations for breeding commence.

"The wild turkey, as an object of pursuit, is the shyest and most wary of all game; even where they are plentiful and rarely hunted, the person who pursues them must have some knowledge of the bird and its habits to hope for success; where they are scarce and have been much hunted, they become inconceivably wild and suspicious, and only the veteran hunter then can kill them; young half or three-quarters grown birds are more easily killed."

In addition to those killed by the gun, a great many turkeys are caught in traps of various kinds. A common one is made of young trees four or five inches in diameter. Two are laid on the ground parallel to each other, and at a distance of about ten feet apart. Two others are then laid across the ends of these, and at right angles to them. This is continued until the trap is about four feet high. The top is covered with similar pieces of wood, and heavy logs are laid on top of these, to render the whole structure steady. A trench is then made under one side of the trap, about eighteen inches in width and depth. The trench opens into the trap slantingly, and pretty abruptly. It gradually rises until it obtains the level of the surrounding ground. Over the portion of the trench that is within the pen a lot of sticks are placed, so as to make a kind of bridge a foot in breadth. A quantity of Indian corn is then placed in the trap, as well as in the trench. A few grains are dropped every step or so for a considerable distance from the trap. A flock of turkeys coming up, follow this train of corn, and searching for the grains of corn, are gradually led into the trench, where they find

a good quantity, and from that into the trap. Here they find still more, and they fall to work like a parcel of gluttons and gorge themselves.

When they are full they raise up their heads, and, seeing into what kind of a place they have been led, try to make their egress. They endeavour to force their way out of the side and top of the pen, but never for a moment think of looking downwards, or trying to escape by the passage through which they entered. They therefore remain there until the owner of the trap arrives and secures his booty.

Professor Spencer Baird, one of the highest scientific authorities on ornithological subjects, in his great work on the birds of North America, states distinctly that "the wild turkey of Eastern North America differs in several points, both in structure and manners, from the domesticated birds: the latter possess a large dewlap, extending from the base of the lower jaw to the large caruncles on the lower part of the neck.

"The domestic turkey, even those showing the closest resemblance to the wild birds, may always be distinguished by a whitish tip to the tail, and by the tail coverts being edged with whitish, which is never seen in the wild bird.

"Again, the wild turkey is stated never to have been so domesticated as to breed in confinement, notwithstanding the repeated efforts made to accomplish this result; again, the difference of the colour of the flesh in the two birds is considerable, that of the wild bird being much darker.

"On the whole, it is exceedingly probable that the two breeds are specifically distinct."

Professor Baird supports the following hypothesis:—"That, in addition to the three well-known species of *Meleagris*, namely *M. Ocellata*, from Central America; *M. Americana*, the wild American species; and *M. Mexicana*, the Mexican species, there originally existed a distinct breed, the original of our domesticated breed; that this was indigenous to the West India Islands, and was transplanted as tamed to Mexico, and from thence taken to Europe in 1520; and that ultimately the wild original was exterminated by the natives, and no longer exists in the wild state. This hypothesis will explain the fact of our nowhere meeting with any wild turkeys of the present day, closely resembling the domestic breed."

This conclusion appears, at least, to possess a high degree of probability; nevertheless, some of our distinguished naturalists have entertained a different opinion. Thus, Mr. Gould, in a communication made to the Zoological Society in 1856, respecting the existence of the Mexican species, which had not previously been described, states:—

"In the lapse of time the origin of several of the animals which man has subjected to his dominion, and which are of the greatest service to his necessities, or his pleasures, has become involved in obscurity. As instances, we may point among quadrupeds to the camel, the horse, and the dog; and among birds, to the various poultry birds, water-fowls, and pigeons, all of which were derived from

the Old World. The productions of the New World have not yielded such ready obedience to his sway, since only one of its birds has been domesticated, the Turkey; but a like fate, if I mistake not, has attended the origin of this acquisition, which, although the breed has not been known to us more than 300 years, is equally wrapped in obscurity. 'So involved,' says Mr. Martin, 'is the early history of the Turkey, and so ignorant the writers of the sixteenth and seventeenth centuries appear to have been about it, that they have regarded it as a bird known to the ancients, namely the Guinea fowl or Pintado, a mistake which was not cleared up until the middle of the eighteenth century.'

"The appellation of Turkey, which the bird bears in our country, arose, according to Willoughby, from a supposition that it came originally from the country so called. Mexico was first discovered by Grijalva in 1518. Oviedo speaks of the Turkey as a kind of peacock abounding in New Spain, which had already, in 1526, been transported in a domestic state to the islands and the Spanish Main, where it was kept by the Christian colonists. It is reported to have been introduced into England in 1524, and is enumerated as among the dainties of the table in 1541. In 1573, it had become the customary Christmas fare of the farmer.

"Every author who has written on the subject, since the days of Linnæus, has considered it to be derived from the well-known wild Turkey of North America; but on account of the great differences which are met with among our domestic Turkeys, and the circumstance of the wild Turkeys recently imported from North America not readily associating or pairing with them, I have for some years past entertained a contrary opinion.

"In Canada and the United States the Turkey is partially migratory, visiting those countries, during the summer, for the purpose of breeding; and although some writers state that it is a native of Mexico, I can hardly think it likely that it ranges very far south in the latter country, for from the southern boundary of Canada to Mexico is nearly 2,000 miles, and it is unlikely, I think, that a bird of the cold regions of Canada should also be indigenous to the hotter country of Mexico, whence, and not from North America, the Turkey was originally introduced into Europe by the Spaniards, early in the sixteenth century.

"Believing the Mexican to be distinct from the North American species, it becomes necessary that one of them should receive a new name; and a question then arises to which of the two should it be given. My opinion is, that it will be better to call the present one *Mexicana*, after the country of which it is a native.

"For size, this new Turkey exceeds that of the largest specimens of the North American species; but it has shorter legs, a considerably larger and more broadly expanded tail, conspicuously toned with brown and black, and terminated with white; the tail coverts are very profusely developed, largely tipped with white, and bounded, posteriorly, with a narrow line of black, their basal portions being rich metallic bronze.

"The same arrangement of colouring also prevails on the feathers of the lower part of the flanks; and on the under tail coverts, where it is particularly fine.

The centre of the back is black, with green, purplish, and red reflections; the back of the neck, upper part of the back and shoulders, are in some light bronzy, in others the colour of fire; the greater wing coverts are uniform bronzy brown, forming a conspicuous band across the wing; all the primaries are crossed by mottled bars of blackish brown and white, freckled with brown; all the under surface is fiery copper, intensely brilliant in certain lights, and becoming darker towards the flanks.

“ Total length 4 feet 4 inches; bill $2\frac{1}{2}$ inches, wing $21\frac{3}{4}$ inches, tail 16 inches, and, when spread, about 24 inches across; tarsi $6\frac{3}{4}$ inches.

“ In the report of an expedition down the Tuni and Colorado Rivers by Captain L. Sitgreaves, lately published in America, the following passage occurs in reference to Wild Turkeys:—

“ ‘ They are also found in New Mexico, in the neighbourhood of the copper-mines. I am told by our officers that those found there are of enormous size. Mr. Lerouse, our guide, informed me that the Turkeys of the Gila River were different from those found east of the Rio Grande, and that they have much white about them.’

“ These are doubtless identical with the bird under consideration.”

Having given the opinions of these two eminent ornithologists in their own words, it may be expected that we should state which opinion we regard as the more probable. We think the balance of probability is in favour of that proposed by Professor Spencer Baird, and are therefore inclined to favour the hypothesis which regards the original of our domestic Turkey as no longer existing in a wild state.

The remaining wild species, the Honduras or Ocellated Turkey, is a native of Guatemala, the province of Peten and Yucatan. The extraordinary brilliancy of its plumage renders it almost equal in beauty of colouring to the Impeyan pheasant, which scarcely surpasses it in the metallic lustre of the feathers. In size it is nearly equal to the common Turkey. At the base of the upper mandible of the bill is a long fleshy caruncle, capable of contraction and dilatation as the bird is excited or tranquil. The head and part of the neck are naked, and of similar livid colour, but without those caruncles or fleshy tubercles on the lower part which are so characteristic of the common species. On the breast, the tuft of coarse hair that forms so characteristic a feature in the common Turkey is absent.

The feathers of the upper part of the body are mostly of a brilliant bronzed green, terminated by two bands; the first black, and that next the tip of a golden bronze colour. Lower down the back the colours become more vivid, and are tinted with emerald green, rich blue, or red, according as the light falls upon them. On the tail the bars or bands become broader, and even more brilliant, making each feather appear as if eyed or ocellated; and from the arrangement of the tail coverts there appear four rows of these brilliant metallic eyes. The upper wing coverts are a rich bright chestnut, which strongly contrasts with the white of the feathers of the lower part of the wing.

The entire plumage may be described as far more brilliant, varied, and beautiful

than that of any other Turkey. The general appearance of the bird differs widely from that of the domestic species, as is evident from the subjoined very accurate engraving from the pencil of Mr. Wood.

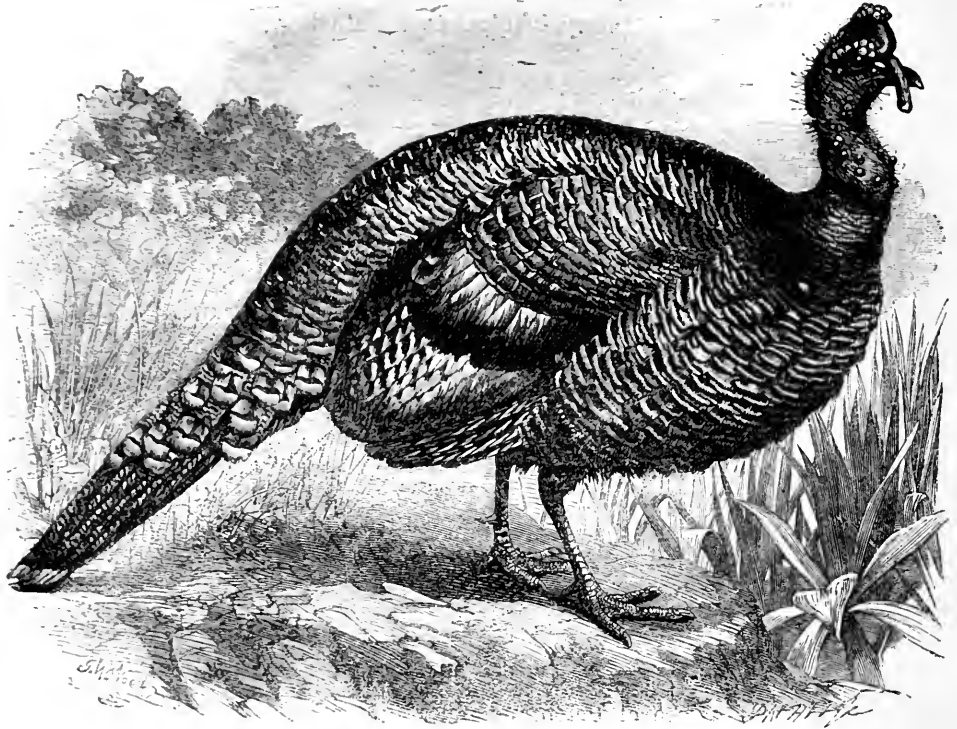

HONDURAS TURKLY. MELEAGRIS OCELLATA.

We need hardly state that this lovely species, which, could it but be naturalized, would be so great an ornament to our poultry yards, has no claim to be considered as the origin of our domestic species; and we can only fall back upon the hypotheses of Mr. Gould or Professor Baird.

Having thus fully discussed the vexed question of the origin of the Turkey, we now come to the management of the animal as a domestic fowl. Of all the authors who have written on this bird, Mr. Trotter, who, some few years since, published an essay in the Journal of the Royal Agricultural Society, is by far the most sensible and practical writer that has come under our notice. The information he imparts is evidently the result of his own experience, and we have much pleasure in quoting his remarks on the subject, which are as follows:—

“ There is a great difference of opinion respecting the age when turkeys are in their prime, and how long they continue profitable. I consider the cock to be at his prime at three years, and the hen at two years old; whether they should be continued to be bred from after these ages depends on the discretion of the owner. Some cocks are famous for being the sires of a healthy offspring, and so are some





LEIGHTON, BRUS.

TURKEY.



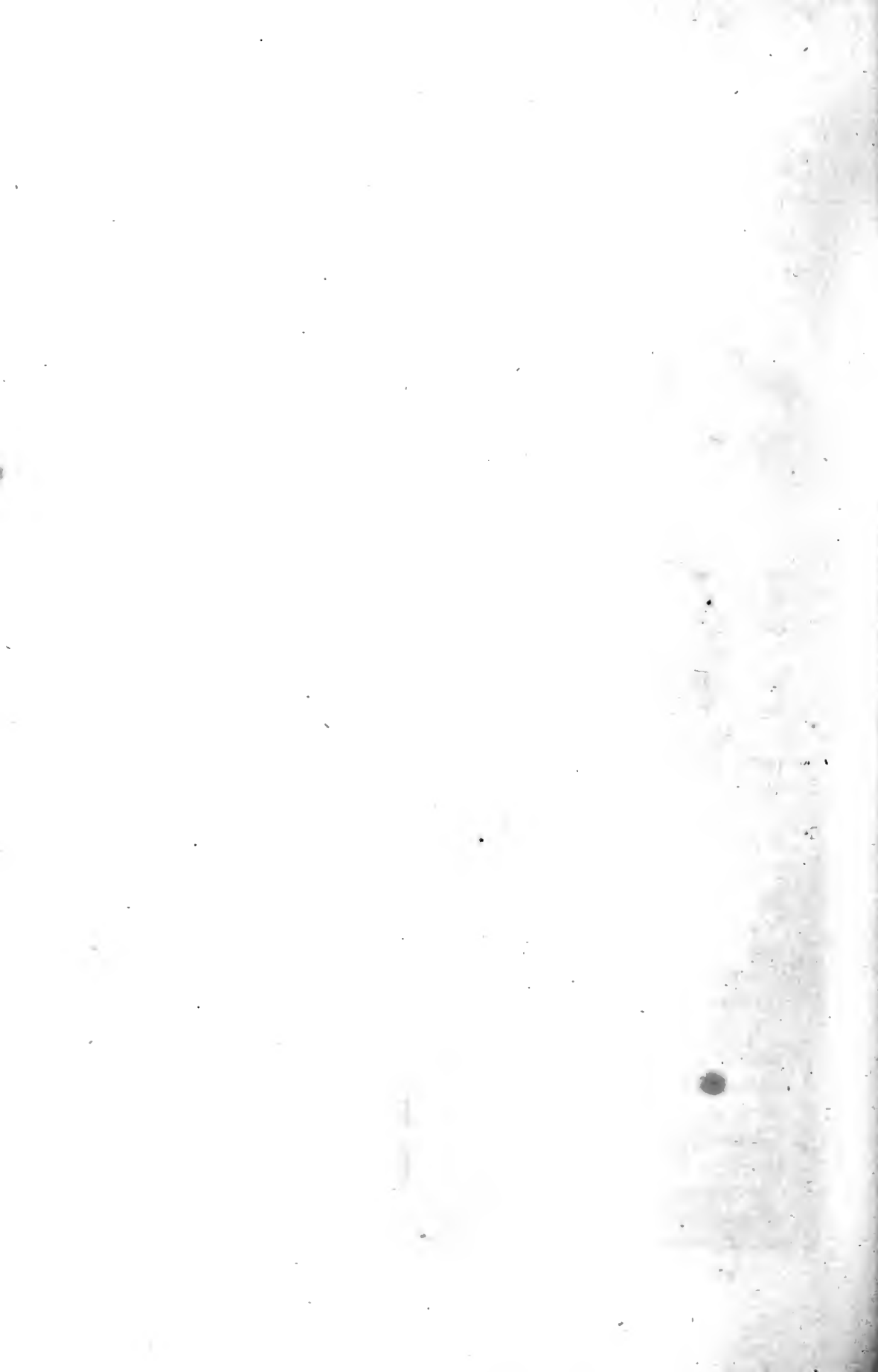

hens for being good sitters and nurses. To dispose of such, before symptoms of declining constitution are displayed in the health and number of the chicks, would display a want of judgment.

“ One fecundation is sufficient to render fertile all the eggs which are of one laying. This has been strongly denied by some; but the fact is undoubted, for in this district many people keep hens only, and have to send them to some neighbour's cock: the hen is sent once only, yet it is known that nothing more is generally required to ensure the fertility of all the eggs of that laying.

“ The number of hens running to one cock should not exceed fifteen, and the majority of breeders allow even a smaller number.

“ Some hen-turkeys lay every day; others lay two days in succession, and miss the third; while others lay only every other day.

“ The turkey-cock, in a state of nature, is ever seeking to destroy the eggs of the hen; and she, to elude him, seeks some secluded place in which to make her nest. In a domestic state, they in a great measure still retain the same propensities; it is therefore necessary to examine the hens every morning during the laying season, and keep in those that have to lay that day. If the hens be allowed to seek nests for themselves, the eggs are very frequently destroyed by magpies, rats, weasels, &c., or are lost.

“ The number of eggs laid by the turkey at one time varies from twelve to twenty—most generally sixteen or seventeen; a number quite sufficient to be securely covered.

“ The eggs should be taken from the nest every day as soon as convenient, and placed in a vessel containing bran, or some other bad conductor of heat. I have not tried crushed charcoal, but should think it would answer very well.

“ The desire a turkey displays to sit is known by her remaining on the nest. It is not desirable that she should have the eggs immediately given to her; it is best to test her constancy for two or three days; at the end of which, should she prove true, they must be given to her—care being taken to have the eggs, if they be not all her own, as near as possible of the same age. To accomplish this, the eggs should have the date on which they were laid marked on them with a pencil.

“ The management should be such as to prevent other hens from laying in the nests occupied by those sitting: but as ‘accidents occur in the best regulated families,’ the eggs with which the turkey or other fowl is set should be marked to distinguish them from those which may afterwards be laid. This is best accomplished by surrounding them with a ring of ink marked with a pen. This method of marking is preferable to writing on one end, as it enables the owner to distinguish at a glance the egg which has been added since the commencement of the sitting.

“ Some people recommend the sitting of two turkeys at the same time, so as to be able to give both broods to one hen, that the other may again be at liberty to commence laying, and of course a second brood is got much sooner.

“ So closely does the turkey-hen sit during the time of incubation, that very

frequently she has to be forced off the nest. This must be daily attended to; otherwise, from want of food, she will get much reduced. I need not insist on the necessity of abundant feeding. The turkey is rather an absent bird, and so much does she enjoy herself when from her nest, that she often forgets to return to it in due time. The poultry-keeper must see to this, and never allow her to remain off more than twenty minutes, unless the weather be very fine, when she may have the indulgence of a few extra minutes. I do not admit the desirability of any further interference. No one save the person in charge should be allowed to come near the hen whilst she is sitting.

“ Many writers on poultry have stated that the turkey-chick leaves the shell on the thirty-first day of incubation. This does not agree with my experience, as I have not found thirty-one days necessary. On referring to my note book I find that one of my turkeys had twelve eggs given to her on Monday, May 7, 1849. On Sunday morning, June 3, eleven fine strong chicks were found beneath her; the weather during the time was very warm, which would, of course, have the effect of bringing the chicks out a little sooner. Nevertheless, I cannot agree with those who state that the time of incubation of the turkey is thirty-one days: instances of such a long time must be very rare indeed, and I should look on them as omens of bad success. The number of eggs laid by the turkey I have named was few; but I must state that she was of a second brood, hatched the previous year, and consequently was very young. This fact proves the fallacy of the assertion that the females of a second brood should not be allowed to sit.

“ Should some of the turkey-chicks be slower in freeing themselves from the shell than others, they should be left undisturbed under the hen, when they will do much better than if they or the chicks already hatched are removed. I wish to point out the impropriety of interference; as the result will, in almost every instance, be in favour of allowing nature to have her sway. Many recommend the removal of the chicks from the nest as they come out—I highly disapprove of the plan; however, some people are so anxious to know the issue, that no argument is sufficient to induce them to ‘let well be well:’ such, therefore, may remove the chicks and put them in some warm place, as the mother, from being so much disturbed, is apt, at this critical juncture, to trample them to death.

“ The turkey-chicks should not have food forced on them, at least not in the manner some do, by forcing them to swallow it. A drop of milk or water is of great service to them, and should be given by dipping the finger into the liquid and then putting the drop on to the beak; this is better than dipping the beak into the milk or water, as it prevents the chicks from getting wet—a thing to be scrupulously avoided.

“ The turkey-chick is much more stupid than that of the fowl: the latter soon pecks with facility. On this account it is very recommendable to have two or three of them in every brood of the former; so that they, by force of example, learn to peck much sooner. This is accomplished by placing two or three fowl’s eggs beneath the turkey at the end of the seventh day of incubation. The food I

have found answer best consists of equal portions of oatmeal and the crumbs of white bread, mixed with a little boiling water, a light-boiled egg, and a considerable quantity of the leaves of the dandelion chopped small. This mixture should be given very frequently, in small quantities, on a clean floor. The reason why I have recommended the leaves of the dandelion before parsley, nettles, &c., is conclusive. A person I had in my service (with abilities and acquirements far beyond her sphere), had observed that turkeys, when running about, always devoured with avidity the leaves of this plant; and she accordingly determined to try the experiment of mixing it with the food for the turkey-chicks; and such was her success, that during the whole time (five years) she was with us she never lost one chick; and, moreover, when they were disposed of, they were not only equal but superior to all others in the market. She was most assiduous in her duties, never allowing them to be exposed to a single drop of rain if it were possible to prevent it, until she was pretty certain they were old enough to bear it. About twice a week she gave them buttermilk to drink (always giving it them in very shallow vessels); at other times she gave them water. She also fed them partly on curds, than which nothing can be better: they should be made fresh every day. She gradually discontinued the use of oatmeal and the crumbs, by substituting for them, at first, a small quantity of barley meal, and increasing it until the chicks were eight or nine weeks old, at which age the oatmeal was left off. When a week old, the chopped eggs were discontinued. A boiled potato, moderately warm, should occasionally be given.

“Undoubtedly the greatest obstacle to the profitable rearing of turkeys in our climate is dampness. It is, therefore, of the utmost importance to have the house in which they are kept thoroughly dry—never allow them to go out when it rains, or when there is any dew. These rules must be strictly enforced until the chicks are nine or ten weeks old, at which age their backs will be found sufficiently well covered with feathers to withstand a shower of rain: still at this age they should not be too much exposed. Intense sunshine should all this time be guarded against.

“Some turkey cocks trample the chicks to death, while others are proud of their offspring; it is therefore necessary to watch the movements of the cock when first introduced to his family; and should a want of paternal affection be displayed, he must be punished, as he justly deserves, with confinement or banishment. I have waited until I have known the opposite propensities displayed by different turkey cocks in a state of domestication, before I have taken into consideration the situation of the hatching nests. Should the turkey cock not be ill-disposed, then the nests may be made in the turkey-house, while he is allowed to roost in it as usual; but should his character not be of the best sort, then he must be either excluded from the house, or the nests must be made in some other situation. With regard to the arrangement of the house appropriated to the turkeys, so much depends on the general construction of the farm buildings, that it is very difficult to give an opinion suitable to all circumstances. Should

the turkey-house not be perfectly free from dampness, then it will be best to have the nests in that apartment of the fowl-house occupied by the breeding fowls ; but should the turkey-house be all that can be desired, then I would either advise the exclusion of the cock, or the dividing of the house into two parts, similar to the fowl-house. I must here repeat my conviction of the necessity of having the hatching nests in the apartment in which are the laying nests.

“Turkeys should be so fed as to be ever ready for the spit. This is my practice, and I always procure the best prices in the market—not for them only, but for all sorts of poultry ; it would be useless to say more. However, I should remark that many people, after harvest, turn the turkeys into the adjoining stubble fields, where they pick up a great deal which would be wasted. From the position of our farm-buildings we have not been able to do this, and therefore cannot give a decided opinion on the practice.”

Having given these practical directions on the management of turkeys, as followed in England, from the pen of so good an authority, we wish, in contrast to the English method of rearing and feeding, to insert the following, on the continental methods, from an account communicated to the Imperial Society of Acclimatisation by M. Le Docteur Saccé, who writes :—

“For the hatching, I use willow baskets, the bottoms of which are covered with straw, moss, or heath, on which I lay a bed of hay carefully crushed, so that the nest shall not be too deep, which exposes the eggs to the risk of being broken by rolling against each other, and hinders the bird from warming them equally. Alongside of the baskets, within reach of the hatchers, are two troughs, the one full of oats, the other of water ; and every twenty-four hours the turkey is lifted off her eggs that she may roll in the dust to get rid of the vermin. In five or six minutes the indefatigable sitter returns to her eggs, which, according to the surrounding temperature, are hatched from the 27th to the 30th day. I have always seen them hatched in the course of the 28th, because I kept my hatchers in a very warm and dry room. This hatching place is in general much the best in our temperate and humid regions ; but when the summer is scorching it dries the eggs too much, and causes the chicks to remain glued to the shell ; an inconvenience to be obviated by slightly sprinkling the eggs with water whenever the turkey leaves the nest. The hatching place should be sheltered from draughts, from noise, and direct and powerful light.

“As soon as the chicks appear, the fowls are no longer touched ; but, twenty-four hours after, I place alongside of the nest some handfuls of very fine hay, on which I set the mother, losing no time in giving her her chicks, which one after the other are slipped under her.

“During the first eight days the little ones are fed on eggs boiled hard and minced ; during the second, I add to this bread-crumbs chopped with nettles, parsley, and onions. During the third week I keep back the eggs, and only continue the bread and the vegetables ; then instead of the bread I give moistened meal, boiled peas, and above all, millet, of which young turkeys are very fond.

“When the birds are sickly they are easily cured by making them swallow a peppercorn, their bills being carefully opened to avoid hurting them.

“Some authors advise the letting out of these birds when the weather is fine; but when following this advice, I have lost so many that I have given it up altogether. I have since left them in their garrets till they had put forth the red, which occurs in from six weeks to two months, taking care to give them as much air as possible; and from that time I have not lost one. During the crisis of putting forth the red—that is, the red protuberances of the head and neck—I again give the little turkeys stimulating food, consisting of bread minced with onions and nettles or parsley. When this is past, the turkeys are as robust as previously they were delicate, and stand all weather; now is the time to let them out to the open country, where they feed themselves on all sorts of herbs and insects, of which they are so fond that in Switzerland they are made to follow the plough for the purpose of destroying the turned-up larvæ of cockchafers.

“In order to fatten them, I have only to shut them up in a court for two or three weeks, feeding them on meal soaked in water, boiled potatoes, and maize, avoiding oleaginous seeds, because these communicate their oily flavour to the flesh of the birds.”

To these directions of Mr. Trotter and Dr. Sacc, we would only add a strong recommendation to our readers to employ that admirable combination of egg and milk, recommended by Mr. Douglas in the chapter on Coloured Dorkings (page 88). Animal food is required by young turkeys that are prevented from ranging, and there is no form in which it can be given at all approaching in nutritive value and easy digestibility to the custard prepared as directed. We speak from personal experience, and can positively affirm that it is the most successful artificial food ever devised for young gallinaceous birds, deprived of a free range and natural insect food.

The varieties of the Turkey are—the Norfolk or Black, and the Cambridge, the colours of which vary very much, the prevailing hues being grey or bronze, the latter varying from a light copper-colour to a very dark tint, which is generally preferred.

Many of these dark birds are exhibited as American or cross-bred American turkeys, under the idea that they are the pure or half-bred wild North American species; but, as we have previously demonstrated, this statement has no foundation in fact.

The White are very elegant, and though the most tender of all to rear, are not so in anything like the same degree as the white peafowl. It is well known that most birds, wild as well as tame, occasionally produce perfectly white individuals of more delicate constitution than their parents. There can be no doubt that the selection and pairing of such is the way in which the breed of white turkeys has been established and kept up. However, with all care, they will now and then “cry back,” and produce speckled or pied birds; and so show a tendency to return to their normal plumage. It is remarkable that in specimens

which are snow-white, the tuft on the breast remains black, looking in the hens like a tail of ermine, and showing as a great ornament. The head and caruncles on the neck of the male are, when excited, of the same blue-white and red hues as seen in the darker bird. Thus the creature, with small portions of black, blue, and scarlet, relieving his snowy and trembling flakes of plumage, is truly beautiful; and some keep them in spite of the disadvantages attending them.

One advantage they possess over the darker breeds is, that their fluff or the soft-plumed feathers of the thighs are valued by the plumasiers, and realize a fair price in the ornamental feather market.

The weight of the first class turkeys exhibited for competition at the principal shows, may be estimated from one example. At the Birmingham poultry show, held in December, 1865, the weight of the first prize pair of old birds was 47 lb.; those which received the second prize weighed 46 lb.; and those taking the third prize, 45 lb. Of the young turkeys the first prize pair weighed 40 lb., the second 36 lb., and the third 35½ lb. All these birds were of the Cambridge variety; the superior size of the birds of this breed renders them almost always successful, when they come into competition with the black or white varieties.

In the show-pen the chief points looked for in turkeys are size and symmetry; crooked backs, breasts, or legs, or deformity in any part, being held as disqualifications. The birds in the same pen must match in colour, which should be rich and bright, showing the high condition and vigorous health necessary to success in competing for prizes at an exhibition.

CHAPTER XXVI.

THE PEAFOWL.

THE Peafowls, which are all natives of India, China, Java, and the Philippines, form a very well marked group of birds, known to ornithologists as constituting the genus *Pavo*. These fowls are distinguished from the other gallinaceous birds by having the head ornamented with an erect crest of feathers of a peculiar structure. The space around the eye is naked; the true tail of moderate length, comprised of eighteen feathers; the feathers of the back and upper tail coverts are of great length, and beautifully ocellated. The tarsi or shanks are long and spurred in the male.

It is usually stated that but two species are known,—the common peacock, *Pavo cristatus*, and the Javan species, *Pavo muticus*. But Dr. Selater has recently described, under the name of the black-winged peafowl, *Pavo nigripennis*, a third which seems perfectly distinct from the two former. The common Peafowl, *Pavo cristatus*, has been known from the earliest periods; we are informed that the navy of Solomon brought to him every three years peacocks from Tarshish, 1 Kings x. 22. Peafowls were known to the Greeks, and largely bred by the Romans. The bird in its wild state is a native of the peninsula of India, the Himalayan mountains, up to a height of several thousand feet, the jungles in the salt range of the Punjab, and the island of Ceylon. Jerdon, in his admirable work, thus describes it:—

“ Male with the head, neck, and breast rich purple, with gold and green reflections; back green, the feathers scale-like, with coppery edges; the wings with the inner coverts, including the shoulder, white, striated with black; the middle coverts deep blue; the primaries and tail chesnut; abdomen and vent black; the train chiefly green, beautifully ocellated; the thigh coverts yellowish grey; head with a crest of about twenty-four feathers, only webbed at the tip, and green with blue and gold reflections. Bill horny brown; orbits naked whitish; the irides of dark brown; legs horny brown. Length to the end of the true tail, $3\frac{1}{2}$ to 4 feet; wing 18 inches; tail 24; the long train sometimes measures $4\frac{1}{2}$ feet, and even more.

“ The female or Peahen is chesnut brown, the upper plumage light hair-brown, with faint wavings, increased on the upper tail-coverts; quills brown; some of the wing-coverts mottled dusky and whitish; tail deep brown with whitish tips; chin

and throat white; breast as the neck; abdomen white, with the lower parts and under tail-coverts brown.

“Length 38 to 40 inches; wing 16; tail 14. The crest is shorter and duller in its tint than in the male.

“The Peafowl is too well known to require a more ample description. It inhabits the whole of India Proper, being replaced in Assam and the countries to the East by another species. It frequents forests, and jungly places, more especially delighting in hilly and mountainous districts; and, in the more open and level country, wooded ravines and river banks are its never-failing resort. It comes forth to the open glades and fields to feed in the morning and evening, retiring to the jungles for shelter during the heat of the day, and roosting at night on high trees. It ascends the Neilgherry and other mountain regions in Southern India, to 6,000 feet or so of elevation, but it does not ascend the Himalayas, at all events in Sikim, beyond 2,000 feet. In many parts of the country it is almost domesticated, entering villages and roosting on the huts; and it is venerated by the natives in many districts. Many Hindoo temples have large flocks of them; indeed, shooting it is forbidden in some Hindoo states. The Peafowl breeds, according to the locality, from April till October, generally in Southern India towards the close of the rains, laying from 4 to 8 or 9 eggs in some sequestered spot. The Peacock during the courting season raises his tail vertically, and with it of course the lengthened train, spreading it out and strutting about to captivate the hen birds; and he has the power of clattering the feathers in a most curious manner.

“It is a beautiful sight to come suddenly on twenty or thirty Peafowl, the males displaying their gorgeous trains, and strutting about in all the pomp of pride before the gratified females. The train of course increases in length for many years at each successive moult, but it appears to be shed very irregularly.

“Though it cannot be said to be a favourite game with sportsmen in India, few can resist a shot at a fine peacock whirring past when hunting for small game: yet pea-chicks are well worth a morning’s shikar for the table, and a plump young peahen, if kept for two or three days, is really excellent. An old peacock is only fit to make soup of. A bird merely winged will often escape by the fleetness of its running. They generally roost on particular trees, and by going early or late to this place, they can readily be shot.

“Peafowl are easily caught in snares, common hair-nooses, and are generally brought in alive, for sale in numbers, in those districts where they abound. In confinement they will destroy snakes and other reptiles, and in their wild state feed much on various insects and grubs, also on flower buds and young shoots, as well as on grain.”

The naturalist who published a series of admirable articles on the Game birds of India in *The Field*, under the *nom-de-plume* of “Ornithognomon,” thus graphically described the habits of these birds in their wild state:—

“In the months of December and January the temperature in the forests of

Central India, especially in the valleys, is very low, the cold, from sudden evaporation, being intense at sunrise. The peafowl in the forests may be observed at such times still roosting, long after the sun has risen above the horizon. As the mist rises off the valleys, and gathering into little clouds, goes rolling up the hill-sides till lost in the ethereal blue, the peafowl descend from their perches on some huge seemul or saul tree, and threading their way in silence through the under-wood, emerge into the fields, and make sad havoc with the chunna, ooid (both vetches), wheat, or rice. When sated they retire into the neighbouring thin jungle, and there preen themselves, and dry their bedewed plumage in the sun. The cock stands on a mound, or a fallen trunk, and sends forth his well-known cry, 'pehaun—pehaun,' which is soon answered from other parts of the forest. The hens ramble about, or lie down dusting their plumage; and so they pass the early hours while the air is still cool, and hundreds of little birds are flitting and chirruping about the scarlet blossoms of the 'polás' or the 'seemul.' As the sun rises and the dewy sparkle on the foliage dries up, the air becomes hot and still, the feathered songsters vanish into shady nooks, and our friends the peafowl depart silently into the coolest depths of the forest, to some little sandy stream canopied by verdant boughs, or to thick beds of reeds and grass, or dense thorny brakes overshadowed by mossy rocks, where, though the sun blaze over the open country, the green shades are cool, and the silence of repose unbroken, though the shrill cry of the cicada may be heard ringing faintly through the wood. There are spots in these saul forests which, for luxurious coolness during the sultriest weather, rival the most elaborately devised recesses of the Alhambra, or the tinkling fountains and rose bowers of Ispahan—the paradise of the old Persian—and the wilder denizens of the woods show no small discernment in selecting them. Many a delightful dreamy hour I have passed in some such delicious spot, watching the little crystal streamlet at my feet, lazily scanning the endless variety of unknown plants, flowers, ferns, fungi, and mosses scattered around, or following the movements of some honey sucker, as the tiny feathered jewel, emboldened by the silence, displayed his brilliant plumage scarce a yard from my admiring eyes. In such lovely retreats one might cheat the hot hours of noon, and rob them of their discomfort; but, alas! these are the spots where lurks malaria, and, moreover, where one may be very apt to intrude on the privacy of some misanthropic tiger! The fact that where peafowl abound tigers are very likely to be met with is well known to Indian sportsmen, and is confidently believed by the natives themselves.

“These birds cease to congregate soon after the crops are off the ground. The pairing season is in the early part of the hot weather. The peacock has then assumed his full train, that is, the longest or last rows of his upper tail coverts, which he displays of a morning, strutting about before his wives. These strange gestures, which the natives gravely denominate the peacock's *nautch*, or dance, are very similar to those of a turkey cock, and accompanied by an occasional odd shiver of the quills, produced apparently by a convulsive jerk of the abdomen.

These are all blandishments, we are told, to allure the female, and doubtless have a most fascinating effect.

“ The hen lays in Central India during June and July. The eggs, amounting sometimes to eight or ten, are laid on the bare ground, generally under a thicket, in the deepest and most secluded part of the jungle; they are of a dull brownish white, about $2\frac{3}{4}$ inches in length, and $2\frac{1}{4}$ in breadth. The chicks run about as soon as hatched. They are at first covered with down, and in about a week begin to assume their first feathers, which are of a dull dark brown above and paler below, in both sexes, the sides of the head whitish, with a dark band through the eye. The cock remains for a year or eighteen months of the same colour as the hen, and does not assume the long tail coverts till the third year; these fall off when moulting in the rains, and the new coverts remain short till about November or December, when the last rows elongate rapidly.

“ Peafowl, as may be seen amongst those reared with our poultry, are omnivorous—insects, worms, reptiles, flesh, fish, are as readily devoured as grain. In a farmyard they are mischievous in killing and devouring chickens, and, though reared from the egg in confinement, they rarely become thoroughly domesticated, but ramble farther and farther as they grow. They are vicious birds, and show their tameness by attacking infirm persons and children.”

The Burman or Javan Peacock, *Pavo muticus*, which is often erroneously termed the Japan Peacock, is a native of the Burmese and Malay countries, as far northwards as Aracan and Sumatra, and is abundant all over Java. “ It is,” writes Ornithognomon, “ a finer and larger species than the preceding. The dimensions of a cock bird killed by me in the Tenasserim provinces, were as follows—Entire length from bill to the tip of the longest upper tail covert, 7 ft. 3 in. ; the coverts exceeded the tail itself by 3 ft. 3 in. ; wing, 1 ft. $3\frac{1}{2}$ in. ; spread of the wings, 5 ft. 9 in. ; bill, $1\frac{3}{4}$ in. ; tarsus, 5 in. ; middle toe, 3 in.

“ The neck is more bulky than in the Bengal or common peacock, and the plumage on it laminated, or scale-like. In other respects, the form resembles that of the common species, except in the crest, which is long and narrow, standing vertically on the upper part of the occiput, and composed of narrow feathers, scantily webbed basally, and ending in oblong blades. Each of the long flowing upper tail coverts ends in an ocellum, or eye, coloured similarly to those in the train of the ordinary peacock; but the longest or last of these coverts have the terminal portion emarginate, or crescent-shaped, as if the ocellum had been cut out. The lateral or outermost of these coverts are more thickly webbed and curved inwards, so as to bend over the adjoining ones; they terminate in points, without ocelli.

“ It would occupy too much space to describe with accuracy the colours of this splendid bird. It differs from the common peacock chiefly in the following particulars. The bare skin of the face is a livid smalt blue from the bill round the eye; but below and behind this the skin is orpiment yellow, with a patch of black hairs over the ear. The crest, the feathered part of the head, and the entire neck

are glossy bottle-green, each feather based steel blue. As these increase in size towards the lower part of the neck, they assume marginally more and more a coppery golden hue, with their centres and extreme edges lovely resplendent blue-green. The breast rich blue-green, the feathers scale-like, and margined with gold and copper; rest of the lower parts dark blue-green, dulled with blackish; entire back a rich coppery brown colour, with darker shades and transverse line, and bars of green and whitish brown. Towards the upper tail coverts these marks grow more defined and regular, till the coverts themselves become altogether rich green, blazing in lights with gold and copper, and regularly barred with whity brown; the tail is deep olivaceous brown, indistinctly barred paler; scapulars, as back; all the wing coverts velvety sepia, but everywhere glowing with rich green and Prussian blue; tertial and secondary quills black, with a shine of blue; primaries ruddy buff colour.

“In the breeding dress, the upper tail coverts are replaced by feathers similar to those in the train of the common peacock, but there is more of the bronze tinge in these plumes of the Burman bird.

“The female differs from the cock bird much as in the Bengal species.

“The green or Burman peacock inhabits the countries along the eastern margin of the Bay of Bengal, Arakan, Burma, Tenasserim, Siam, and so on towards the south, throughout Malayana to Java, &c. The northerly and southerly limits of its habitat I do not know. As Jerdon does not include it in his birds of India, it is probable that it does not extend into Chittagong.

“The habits of the *Pavo muticus* are so similar to those of its congener as scarcely to admit of separate description; but I should say it was a still more strictly sylvan or forest-haunting bird. Cultivation does not appear to entice it far from its leafy fastnesses, as it does with the Bengal species; and it is in consequence more secluded, wilder, and difficult of approach, besides being far less numerous. I have never seen more than three or four of the Burman peafowl together, whereas the Bengal species unite in flocks of 30, 40, or 50. It haunts the thickest jungle, whether on level ground or on the sides of small hills, and is frequently found in the masses of elephant grass which so commonly skirt the smaller brackish creeks and nullas of Arakan. A specimen with a full train is seldom seen, except in the beginning of the rains, which is the season of courtship. About August they moult, drop their long ocellated tail coverts, and assume the simpler green-barred ones. The train appears again in the succeeding March or April; but the moulting of this bird appears to be irregular, and I have seen cock birds with fine flowing trains in January and February. The hen incubates in the rains, but at uncertain periods; the young just hatched have been brought to me at Moulmein at different times, from August till January. The eggs cannot be distinguished from those of the Bengal bird.

“The Burmese and Talaings, who never keep or tame wild animals, do not attempt to domesticate the peacock, but will now and then bring them into Moulmein for sale. The chicks resemble those of the Bengal species, and are difficult to rear.

They either fly off as soon as fully fledged, or pine away if kept shut up. Occasionally one will attach itself to the compound or poultry-yard for a year or two, but the bird is not a pleasant pet. If rendered at all familiar, it becomes impudent and vicious; attacking elderly gentlemen or ladies suddenly and treacherously by the rear, flying at and severely buffeting and pecking children, lapdogs, &c., and sometimes wantonly destroying young poultry. The cry or call of the Burman peacock is somewhat harsher than that of the Bengal species."

Hybrids between these two species are not rare in India.

Since the time of Linnæus only these two species have been generally recognized, but at a meeting of the Zoological Society, Dr. Selater called attention to a third distinct species, in some respects intermediate between the other two, and which, though long since brought into Europe, and often bred in our menageries, seems in some mysterious manner to have escaped the notice of naturalists, and to have been left unprovided with a specific name.

This bird is the black-shouldered peacock of "Latham's General History," vol. viii. p. 114, where its differences from the true *Pavo cristatus* are accurately pointed out. In the black-winged peacock the metallic green of the back, which forms the centre of the train, when extended, is of a more golden hue than in the common species *Pavo cristatus*. The whole of the secondaries, scapulars, and wing-coverts are black, with narrow edges of green, which become bluish towards the carpal joint; in this particular it resembles the Javan peacock, and is very distinct from the *Pavo cristatus*, or common species, in which all these feathers are cream coloured crossed with black markings. Again, the thighs of the black-winged peacock are black, as in the Javan species, whereas in the common breed they are always of a pale drab.

The female of the black-winged species is of a much lighter colouring than the common peahen, being almost entirely of a pale cream colour, mottled with dark colouring above, and is readily recognizable at first sight. In this respect the black-winged is not intermediate between the two other species, since the female of the Javan is much more like the male.

Dr. Selater asks what is the black-winged peacock: is it a domestic variety, a hybrid, or a wild species? He concludes that it is not a domestic variety, because the differences are constant and descend to the progeny, and are not of the kind induced by domestication. Temminck considered the black-shouldered as the true wild species, and our common breed a variety of it; but there are many facts against this view. The common wild species of Hindostan is undoubtedly the common *Pavo cristatus*, and the black-winged is unknown in that country. It cannot be a hybrid, because the hybrids bred between the Javan and the common species have very different characters altogether. Moreover, the birds are perfectly fertile, and their characters fixed. If, therefore, it is not a variety or a hybrid, it must be a distinct species, and probably occupies a distinct geographical position. Dr. Selater is inclined to regard it as a distinct species, and proposes for it the name of *Pavo Nigripennis*: at the same time



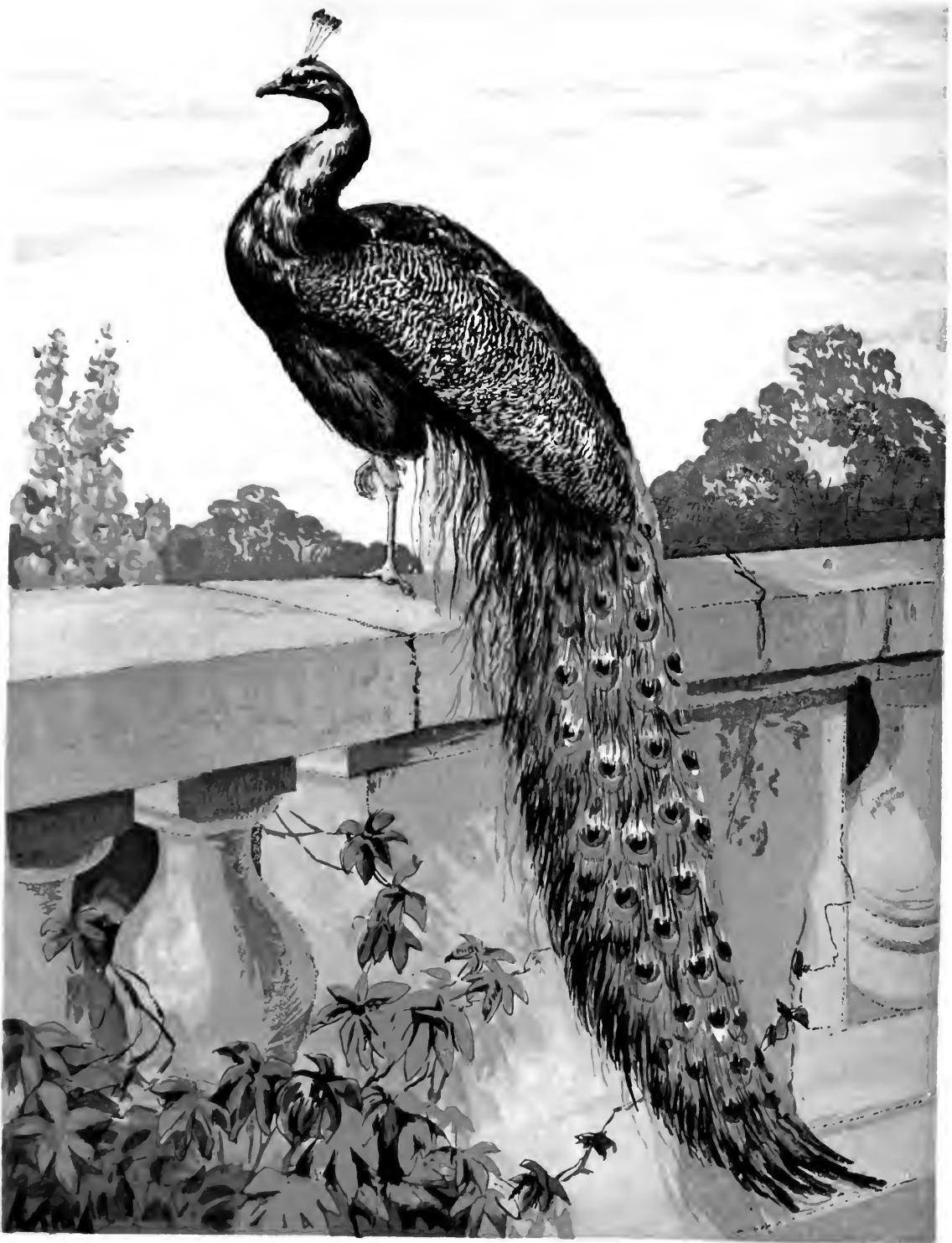

LEIGHTON, BROS

PEACOCK.





he expresses his doubt by asking, "Can the bird be the Malayan form of the common species?"

In a domestic state we are more intimately acquainted with the habits of the common species than with those of the Javan and black-winged birds.

Remarkable changes and variations have been produced and perpetuated, by the influence of domestication, on the colour of the plumage of the Peacock. Thus pied and purely white varieties are by no means uncommon—with some persons they are favourites—but they certainly are wanting in the gorgeous beauty of the natural birds.

In a state of nature the Peacock is polygamous, and in domestication one cock may be mated with three or four hens. The Peahen makes her nest on the ground, laying usually five or six eggs before sitting. The period of incubation is thirty days. In wet weather the chicks are tender, and should be reared with as much care as pheasants or turkeys. The best food for them is custard, ants' eggs, meal worms, oatmeal and milk, etc. As they progress, they may be fed on small wheat, barley, or any grain.

Mr. Hewitt has kindly furnished the following notes on the habits of these birds in a domestic state:—"The habits of these birds are naturally wild and unsociable, whilst their love of an unlimited range makes them difficult of restraint. If they are removed to fresh premises, a very considerable time usually elapses before they appear reconciled to their new home.

"This, in my opinion, arises in a great degree from the extended range that is generally allotted to them; as in several instances within my knowledge, peafowls have been domesticated so completely, as to become quite as sociable as any other variety of poultry. In all such cases, however, they were hatched by a common hen.

"A friend of mine has a rather extensive flock of that beautiful species the Javan Peafowl, the domesticity of which is worth mentioning. They breed very freely, and prove equally hardy to rear as the common kind. At breakfast-time each day, they invariably attend at the glass-doors of the breakfast-room; here they patiently await any remnants from the morning meal their proprietor thinks well to apportion them. If no notice is taken of them, they will trumpet, and beat the glass with their bills, to attract the attention of the inmates.

"I once possessed a male of the common species. It had been reared by a Sebright Bantam hen from an egg found in a field of mowing-grass, at the time of cutting. He had no companions but Sebrights, many of which were of great value; yet I never knew even a solitary instance of his injuring one of them.

"During the number of years this bird was in my possession, even the small Sebright chickens were perfectly safe with him, when they too were only a few days old; but I believe this peculiarity arose from the fact of his never having ever seen a female of his own species.

"If Peafowls are indifferently attended to, their propensity to stroll away is

greater than that of any poultry with which I am acquainted, except aquatic birds.

“At moulting-time their determination to preserve the most rigid seclusion is a peculiarity that I have not seen noticed by any previous writer. At such times they will hide themselves anywhere, and appear to suffer constitutionally more than other descriptions of poultry. After the wonderfully rapid reproduction of the principal train feathers and general plumage, their friendliness returns.

“In general Peafowls are very troublesome among young poultry of every other kind, and cause considerable loss by their obstinate persecution of them, especially during the first few days of their existence.

“Peafowls are positive gourmands; they rarely refuse anything at all eatable, and are consequently very destructive in gardens. If the weather be not windy, the tops of the highest of buildings are their favourite sunning places, and they will reach them with a degree of ease that few parties would credit. As to their value on the table, I can confidently recommend young peafowls as most excellent.

“Their flesh very closely resembles that of the pheasant, and when in good condition, they certainly carry a far more abundant supply, in proportion to the weight of bone, than many other table-birds. If the soil is not a perfectly dry one, the young poults are very prone to cramp and bronchitis; but, on the contrary, if the surface is not retentive of moisture, the chicks grow very rapidly and are reared freely, requiring but little care after the first week or ten days.”

A very experienced amateur of Peafowls thus describes their habits and management:—

“The peahen will return to the same nest year after year if she is not disturbed. I have one ten or twelve years old, who has often done so; and the old lady is every year the happy mother of healthy chicks. Some of the peahens are accustomed to lay under a laurel or other evergreen, and others prefer an open meadow—spite of rain or scorching sun. In the latter case I always direct the mowers to leave a square patch of long grass; for I have known instances of the hen forsaking her eggs if disturbed. They are fond mothers, and never cast off their young till the following spring. It is worse than waste of time to put peafowl eggs under a common hen for hatching. Peachicks cling to the mothers until February. Nature would not prolong this maternal fondness unless it were essential for the well-doing of the chicks. Like other poultry, they would begin to take care of themselves if they were not later in coming to maturity. They are years longer than many other birds in attaining their mature plumage and growth. The young peafowl is at three years old only as a cockerel of one year with other poultry. Hens which turn off their broods after a few months cannot rear peachicks, which would pine and die for want of the parental care throughout the wintry months.

“At pairing time a change comes over the whole Peafowl race. The hen beats

away her brood; and peacocks which may have been friends for months are obliged to own the governor-in-chief, who, taking advantage of his high position, chases each unlucky bird that approaches him. I never, however, saw two peacocks fight.

“The hen, when leaving her nest during incubation, utters a loud, shrill, peculiar scream, which cannot be mistaken. It is well, then, to have in readiness a pan of water and a ball of barley-meal. After she has eaten a little she will suddenly run back to her eggs. I have bred a great many; and although mine have liberty to range over many acres, they never avail themselves of it, but delight to be near home, and to come to the accustomed window early every morning to be fed. At evening they again assemble; and, after their evening meal, each goes to his tree, and stays, in all weathers, until it is time to take wing and descend in the morning. The peahen must have her nest in a place which is secret and safe from the molestation of the cock; she sits twenty-eight days.”

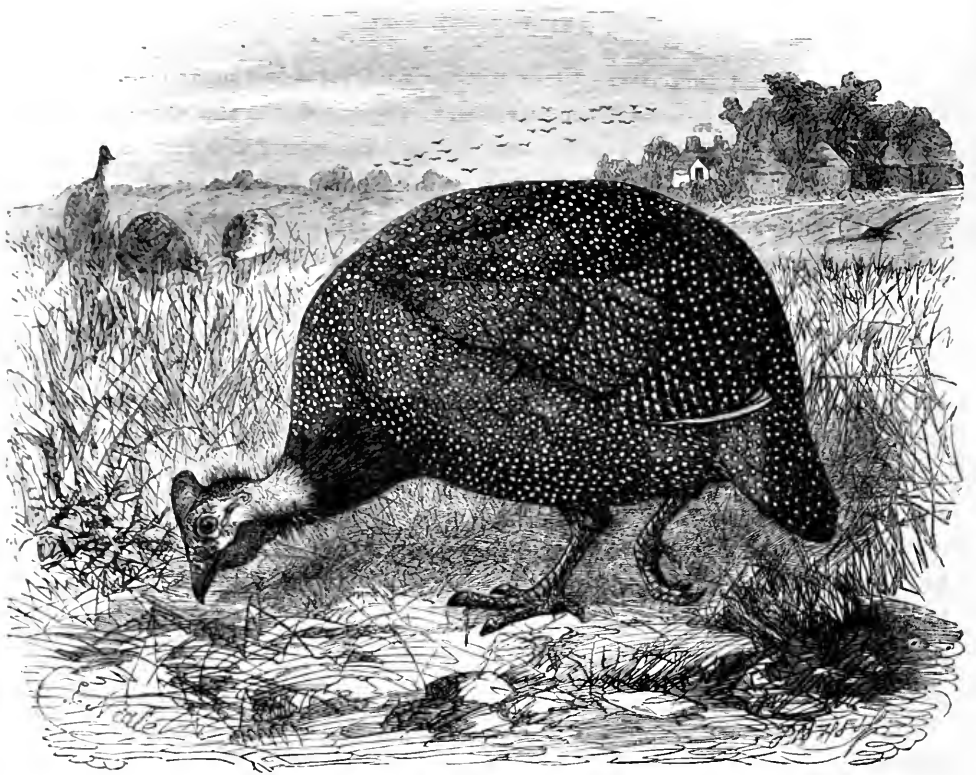

THE GUINEA FOWL.

CHAPTER XXVII.

THE GUINEA FOWL.

THE Guinea fowls, of which there are eight distinct species at present known to naturalists, are all natives of the African continent, or of the adjacent Island of Madagascar. They constitute the genus *Numida*, of which the West African wild species, *N. Meleagris*, is generally regarded as the origin of our domestic breed. This bird is found wild in Western Africa, extending from the Gambia southwards, through Ashantee to the Gaboon; it is also said to exist in the Cape de Verd Islands. Naturalists, however, incline to the belief that the East African, or, as it is generally termed, the Abyssinian Guinea fowl, *N. ptiloryncha*, found in Kordossan, Abyssinia, and Sennaar, is more likely to be the one to which we are indebted for this addition to our comparatively meagre stock of domesticated animals. As the Guinea fowl was well known to the Romans, and bore a high value at the public and private feasts at the time when the luxury of the empire was at its greatest height, this idea is exceedingly probable. The Romans held comparatively little intercourse with South Western Africa, but were so situated as to receive birds from the eastern part of the continent through Egypt, with which country they had constant intercourse.

Of the habits of these two species in their wild state on the African continent, but little is known; but the Guinea-fowl was introduced into the warm and genial climate of Jamaica, which closely resembles its own, nearly 200 years since; there it soon became wild, and was described as wild game 150 years ago. We may therefore avail ourselves of Mr. Gosse's description of its habits in that island, as being nearly identical with those of the birds in their native habitats.

"The Guinea-fowl," writes the author of the *Birds of Jamaica*, "makes itself too familiar to the settlers by its depredations in the provision grounds.

"In the cooler months of the year, they come in numerous coveys from the woods, and scatter themselves in the grounds at early dawn, scratch up the yams and cocoes. A large hole is dug by their vigorous feet in a very short time, and the tubers exposed, which are then pecked away, so as to be almost destroyed, and quite spoiled.

"A little later, when the planting season begins, they do still greater damage by digging up and devouring the seed-yams and cocoe-heads, thus frustrating the hopes of the husbandman in the bud. The corn is no sooner put into the ground than it is scratched out; and the peas are not only dug up by them, but shelled in the pod.

"The sweet potato, however, as I am informed, escapes their ravages, being invariably rejected by them. To protect the growing provisions, some of the negro peasants have recourse to scarecrows, and others endeavour to capture the birds by a common rat-gin set in their way. It must, however, be quite concealed, or it may as well be at home; it is therefore sunk in the ground, and lightly covered with earth and leaves.

"A springe is useless, unless the cord be blackened and discoloured, so as to resemble the dry trailing stem of some creeper, for they are birds of extreme caution and suspicion. It is hence extremely difficult to shoot them, their fears being readily alarmed, and their fleetness soon carrying them beyond the reach of pursuit. But the aid of a dog, even a common cur, greatly diminishes the difficulty. Pursuit by an animal whose speed exceeds their own, seems to paralyze them; they instantly betake themselves to a tree, whence they may be shot down with facility, as their whole senses appear to be concentrated on one object—the barking cur beneath, regarding whom with attentive eyes and outstretched neck, they dare not quit their position of defence. Flight cannot be protracted by them, nor is it trusted to as a means of escape, save to the extent of gaining the elevation of a tree; the body is too heavy, the wings too short and hollow, and the sternal apparatus too weak, for flight to be any other than a painful and laborious performance.

"The Guinea-fowl is sometimes caught by the following stratagem:—A small quantity of corn is steeped for a night in proof rum, and is then placed in a shallow vessel, with a little fresh rum, and the water expressed from a bitter cassava, grated: this is deposited within an enclosed ground, to which the depredators resort. A small quantity of the grated cassava is then strewn over it,

and it is left. The fowls eat the medicated food eagerly, and are soon found reeling about intoxicated, unable to escape, and content with thrusting their head into a corner. Frequently a large part of the flock are found dead from this cause.

“Though savoury, and in high request for the table, the Guinea-fowl sometimes acquires an insufferably rank odour, from feeding on the fetid *Petiveria alliacea*, and is then uncatable.

“The eggs are deposited in the midst of a dense tussock of grass, to the amount of a dozen or more. It is said that occasionally the number is greatly higher, and that they are laid *stratum super stratum*, with leaves between. If this is true, probably more than one hen participates in the maternity. The wild bird's egg measures $1\frac{7}{10}$ by $1\frac{1}{4}$ of an inch, and weighs six drachms one scruple.”

Martin gives the following very correct account of their habits:—

“The common Guinea-fowl, the *Gallina di Numidia* of the Italians, *Poule de Guinée* and *Peintade* of the French, *Pintado* of the Spanish, and *Perlhuhn* of the Germans, frequents the open glades and borders of forests, the banks of rivers, and other localities where grain, seeds, berries, insects, &c., offer an abundant supply of food. It is gregarious in its habits, associating in considerable flocks, which wander about during the day, and collect together on the approach of evening. They roost in clusters on the branches of trees or large bushes, ever and anon uttering their harsh grating cry, till they settle fairly for the night. The Guinea-fowl does not trust much to its wings as a means of escape from danger; indeed, it is not without some difficulty that these birds can be forced to take to flight, and then they wing their way only to a short distance, when they alight, and trust to their swiftness of foot. They run with very great celerity, are shy and wary, and seek refuge amongst the dense underwood, threading the mazes of their covert with wonderful address. The female incubates in some concealed spot on the ground.

“It appears likely that the ancient Greeks and Romans were well acquainted with the Guinea-fowl, yet it is not easy to trace out its history. In fact, strange as it may seem that a bird noticed by Aristotle, Clytus, Pliny, Varro, and Columella, should not, ages since, have pervaded Europe, it was not until after we had received the turkey, that the Guinea-fowl became naturalized in Western Europe. Its name does not occur amongst the list of birds appointed to be served up at the famous feast of Archbishop Neville, in the reign of Edward the Fourth. It does not appear in the Duke of Northumberland's Household Book (1512), nor is it alluded to in the Household Book of Henry the Eighth. Hence we must pardon Belon and Aldrovandus for considering the turkey as the *Meleagris* of the ancients, as it seems that they did not know the Guinea-fowl. From ancient times, through the middle ages, and to a comparatively recent period, all trace of this bird is lost. This bird is, indeed, so common in America and several of the West India islands, that some have thought it to be indigenous there; but in an old work (*Observ. sur les Côtes de l'Asie*) we are informed that, in the year 1508, or about that time,

numbers of these birds were carried into America by the vessels which traded in slaves; but that the Spaniards, instead of attempting to tame them or render them domestic, turned them at large into the wild savannahs, where they have increased in such numbers that they appear to be native. They are seen in vast flocks, and are called by the Spaniards and French *maroon pintades*—*maroon*, or more properly, in modern French, *marron*, meaning fugitive or emancipated.

“ The Guinea-fowl is kept in India, but, according to Colonel Sykes, is to be seen only in a domestic state, and is bred almost exclusively by European gentlemen. It thrives, he adds, as well as in his native country.

“ In England, the Guinea-fowl is less generally kept than the turkey, nor does it appear to abound in France. In the colder latitudes of Europe this bird is very rare, and is seldom, if ever, to be seen in Sweden, Norway, or Northern Russia. It is not noticed by Linnæus in his *Fauna Suecica*, though he was well acquainted with the species.

“ Like all the gallinaceous birds, the Guinea-fowl is esteemed for its flesh and its eggs, which, though smaller than those of the common fowl, are very excellent and numerous, the hen commencing to lay in the month of May, and continuing during the entire summer. After the pheasant season, young birds of the year are, on the table, by no means unworthy substitutes for that highly-prized game. Such birds are acceptable in the London market, and fetch a fair price. The Guinea-fowl is of a wild, shy, rambling disposition; and domesticated as it is, it pertinaciously retains its original habits, and is impatient of restraint. It loves to wander along hedgerows, over meadows, through clover or cornfields, and amidst copses and shrubberies; hence these birds require careful watching, for the hens will lay in secret places, and will sometimes absent themselves entirely from the farmyard until they return with a young brood around them. So ingeniously will they conceal themselves and their nest, so cautiously leave it and return to it, as to elude the searching glance of boys well used to bird-nesting; but it may always be found from the watchful presence of the cock while the hen is laying. There is one disadvantage in this, the bird will sit at a late period, and bring forth her brood when the season begins to be too cold for the tender chickens. The best plan is, to contrive that the hens shall lay in a quiet, secluded place, and to give about twenty of the earliest eggs to a common hen ready to receive them, who will perform the duties of incubation with steadiness. In this way a brood in May or June may be easily obtained. The young must receive the same treatment as those of the turkey, and equal care. They require a mixture of boiled vegetables, with custard, curds, farinaceous food, as grits, barleymeal, &c.; they should be induced to eat as often and as much as they will. In a short time they begin to search for insects and their larvæ; and with a little addition to such fare as this, and what vegetable matters they pick up, will keep themselves in good condition, without cramming or over-feeding. For a week or two before being killed for the table, they should have a liberal allowance of grain and meal.

“ The period of incubation is twenty-six to twenty-eight days. Though they are not unprofitable birds, as they are capable of procuring almost entirely their own living, they are rejected by many on account both of their wandering habits, which give trouble, and their disagreeable voice, resembling the noise of a wheel turning on an ungreased axletree. The males, when pugnacious, though spurless, are capable of inflicting considerable injury on other poultry with their stout hard beaks.

“ Like their wild progenitors, domestic Guinea-fowls prefer roosting in the open air to entering a fowl-house; they generally choose the lower branches of some tree, or those of large thick bushes, and there congregate together in close array; before going to roost they utter frequent calls to each other, and when one mounts the others follow in rotation; they retire early, before the common fowl or the peafowl.

“ The Guinea-fowl is not so large a bird as it appears, its loose full plumage making it seem larger than it is—it does not, when plucked, weigh more than a common fowl. The male and the female very much resemble each other; the male, however, has the casque higher, and the wattles are of a bluish red; the wattles in the female are smaller, and red.”

A very practical and experienced correspondent states:—

“ On visiting some of the large poultry-yards of this country, I have been struck at the general absence of Guinea-fowls. Their noise, difficulty in rearing the young, an instinctive desire to prowl away for nidification, coupled with a tendency, as is supposed, to scratch and destroy garden produce, appear to be the chief obstacles to their being favourites in England. I kept and reared hundreds of these beautiful birds in India for several years. Admitting, which I do, that their clamour is most annoying, especially when any strange animal approaches, or the hens are deprived of their mates, I do not assent to their being so mischievous or destitute of profit as many are disposed to do. The chief difficulty in rearing them in England appears to proceed from our humid climate; wet in any way, whether from the dewy grass or rain from clouds, causing the legs to become cramped or paralytic, which often terminates fatally. I conceive this might be obviated by the construction of a temporary outhouse, with its floor covered with dry gravel, and roof thoroughly waterproof; but the golden rule to preserve the young, is to feed them frequently during the day at intervals of two or three hours. Owing to the rapid growth of their feathers, their strength is severely taxed; and, unless a continual supply of food be administered, they will die of atrophy and starvation.

“ Guinea-fowls may do occasional harm to gardens, but ample compensation is made in the destruction of those insects which cause much greater injury. I have often inspected their crops, and found them to be full of insects, the most noxious known to gardeners. These birds in India generally commence laying after the monsoon, although they will do so at all seasons; and to secure the hens from the mongoose, as well as their eggs from snakes, or being damaged by the sun's heat,





LEIGHTON, BROS.

GUINEA FOWLS.



I had the whole flock shut up about 10 A.M. till 5 P.M., when numbers of eggs would be found scattered about the floor of the room. It was observed that, as ducks laid their eggs at early morn, so the Guinea-fowls deposited theirs, as a rule, towards evening. Whether the same process obtains here, I do not know; ducks, I believe, do lay at an early hour. It appears to me that, during this season of laying, and in order to obtain a good supply of eggs, the plan of confining the birds to the poultry-house daily might meet with equal success here, the great fecundity amply repaying for the little trouble the owners had taken.

“Guinea-fowls, by a little coaxing and regular feeding with the other poultry, may be rendered almost as tame as the latter, and to perch at night with them in the same house. Although its instinct leads it to roost on high trees, my birds were obliged to be secured in this way, or they would readily have fallen a prey to the wild cat of India. The male bird can be distinguished from the hen by its larger size and shrill noise, quite unlike that of the latter, which alone cries ‘Come back! come back!’ He, also, whilst feeding, or in company with others, often assumes a peculiar, restless, pugnacious attitude; not so the hen. Served up with good bread sauce and gravy during the spring of the year, the gallina is quite equal, if not superior, to the pheasant for the table.”—J. C.

These writers so nearly exhaust the practical part of our subject, that but little more remains to be said respecting the treatment of Guinea-fowls. Those who wish to commence keeping these birds will do well to procure sittings of eggs from one, or still better, from two different stocks, so as to lessen the chance of close interbreeding, and to hatch them under common hens; by so doing they will establish a flock with far less trouble than by buying mature birds, whose restless, roving disposition renders it difficult to attach to a new locality.

The eggs are most advantageously hatched under some small variety of fowl, such as the Game or Game Bantam. The chicks when first hatched are exceedingly elegant, being covered with striped down, which is set off by the red colour of the legs and beaks, and they are rendered still more attractive by their extreme activity. In rearing young Guinea-fowls, great care should be taken to feed them at very brief intervals of time, as they suffer much from even a short deprivation of food. No diet will be found more advantageous than the egg and milk prepared in the form of custard, as recommended in the chapter on coloured Dorkings (page 88). This should form a part of every meal for the first month, along with oatmeal mixed with milk and grits: and as the young broods grow up, small tail wheat, boiled vegetables, and potato may be added to their dieting. If a few nests of ants’ eggs can be obtained, they will be found superior to other food.

Complaints are often made respecting the large number of unprolific eggs that are laid by the Guinea-hens. This sometimes arises from the want of a due proportion of cocks and hens. In a wild state it is most probable that these birds pair, inasmuch as in the case of all animals that are gregarious, living in flocks consisting of one male to several females, the males are furnished with offensive

weapons, such as spurs or horns, with which the stronger attack and destroy or drive away the weaker; but the Guinea-fowl, like the partridge, is destitute of spurs, and therefore probably is naturally monogamous.

But whatever may be their habits when roaming wild in the tropical forests of Africa or in the Islands of the West Indies, in the artificial state of domestication their instincts and habits are greatly changed, and the experience of the best breeders tends to show that two hens to one cock is a more advantageous and profitable arrangement than keeping the two sexes in equal numbers.

The cocks may be readily distinguished from the hens by their shrill cry, which is quite unlike the constantly-reiterated "come back," "come back," of the hens, and also by a difference in the position of the wattles, which in the males are attached to the lower mandible in such a manner as to show the flat side or face forward; and, moreover, they are larger than those of the females.

Domestication has not effected any very marked changes in the size or general structure of these birds; some few alterations in colour, however, make their appearance from time to time, and have been propagated by careful breeding. In some varieties, the white spots on the feathers are almost entirely absent; in others, the position of the two colours is reversed, the spots being dark, and the general ground colour white. A third variety is perfectly white in the plumage; and a fourth, which may be produced by crossing the white and dark breeds, is pied more or less regularly with white and dark.

Cross bred birds between the Guinea-fowl and common fowl are rare; when produced they are true hybrids, being perfectly sterile, and incapable of reproduction amongst themselves, or with either of the species from which they were derived. It is a singular proof of the proneness of the older naturalists to theorize rather than to observe, that no less a celebrated writer than Pallas erroneously attributed the singular formation of the skulls of the crested Polish fowls to a cross between the common hen and the Guinea-fowl. It is needless to say, such a theory has not the slightest foundation in fact, being disproved by the absolute sterility of the hybrid between the two species, and also by anatomical research; the casque or helmet of the Guinea-fowl is a mere bony growth, whereas the tuber on the head of the Polish fowl is part of the cavity of the skull, and contains a large portion of the brain.

There is one point connected with the Guinea-fowl that still claims our notice, namely, the efforts that have been made to naturalize it as a wild bird in this country. In the South of England, in warm, dry localities, Guinea-fowls can be acclimatised with the greatest ease, by merely removing the eggs from the nest of a pheasant and substituting those of the Guinea-fowl, when the eggs will be duly hatched out, and the young Guinea-fowl follow the foster-parent. Reared in this manner, they become very wild and shy, partaking of all the characters of true *feræ naturæ*. If left undisturbed during the following season they pair, and breed with freedom, provided the locality be suitable; but wherever they have been thus

introduced into this country, it has been found necessary subsequently to extirpate the entire race, as by their continued persecution they drive away the pheasants and other feathered game from the covers in which they are reared. The experiment has also been tried of introducing them into some of the more barren moors in Ireland; but, as might have been expected, the young birds were found to be so extremely impatient of cold and dampness, that it was not attended with success.

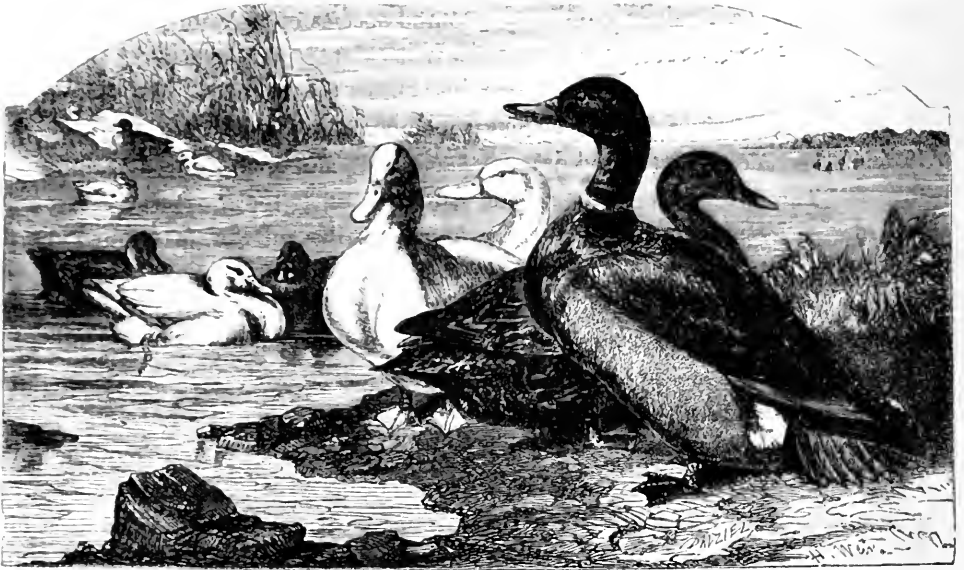

CHAPTER XXVIII.

DUCKS.

WITH regard to the origin of the numerous varieties of our domesticated ducks, a similar amount of rash assertion and ignorant assumption prevails as in the cases of the supposed origin of the other species of domestic poultry.

Naturalists who have paid the greatest degree of attention to the origin and variation of our domestic animals, have no doubt on the subject, referring all the varieties, even those most abnormal in form and colour, to the common Wild duck or Mallard. Mr. Darwin, whose researches into the variation of species have been carried on with great labour through a long series of years, has favoured us with his opinion on the subject. He states:—"With respect to the origin of the domestic duck, I have considered the case well, and am convinced that all the breeds, including the Black Labrador and Penguin ducks, are the descendants of the common Wild duck."

Such being the case, it is desirable to investigate to some extent the natural history and habits of the wild original, and this is more especially necessary, as the plumage of the so-called Rouen duck must accord precisely with that of the wild bird.

For these two reasons, we have quoted from the most practical and exact of all the writers on British Ornithology, the much-lamented Macgillivray, the following admirable account of the general characters, habits, and plumage of the wild birds. In the fifth volume of his most valuable treatise on British Birds, Macgillivray writes:—





LEITCH, BROTHERS

ROUTEN DUCKS.

BLACK EAST INDIAN, OR BUENOS AYRES DUCKS.

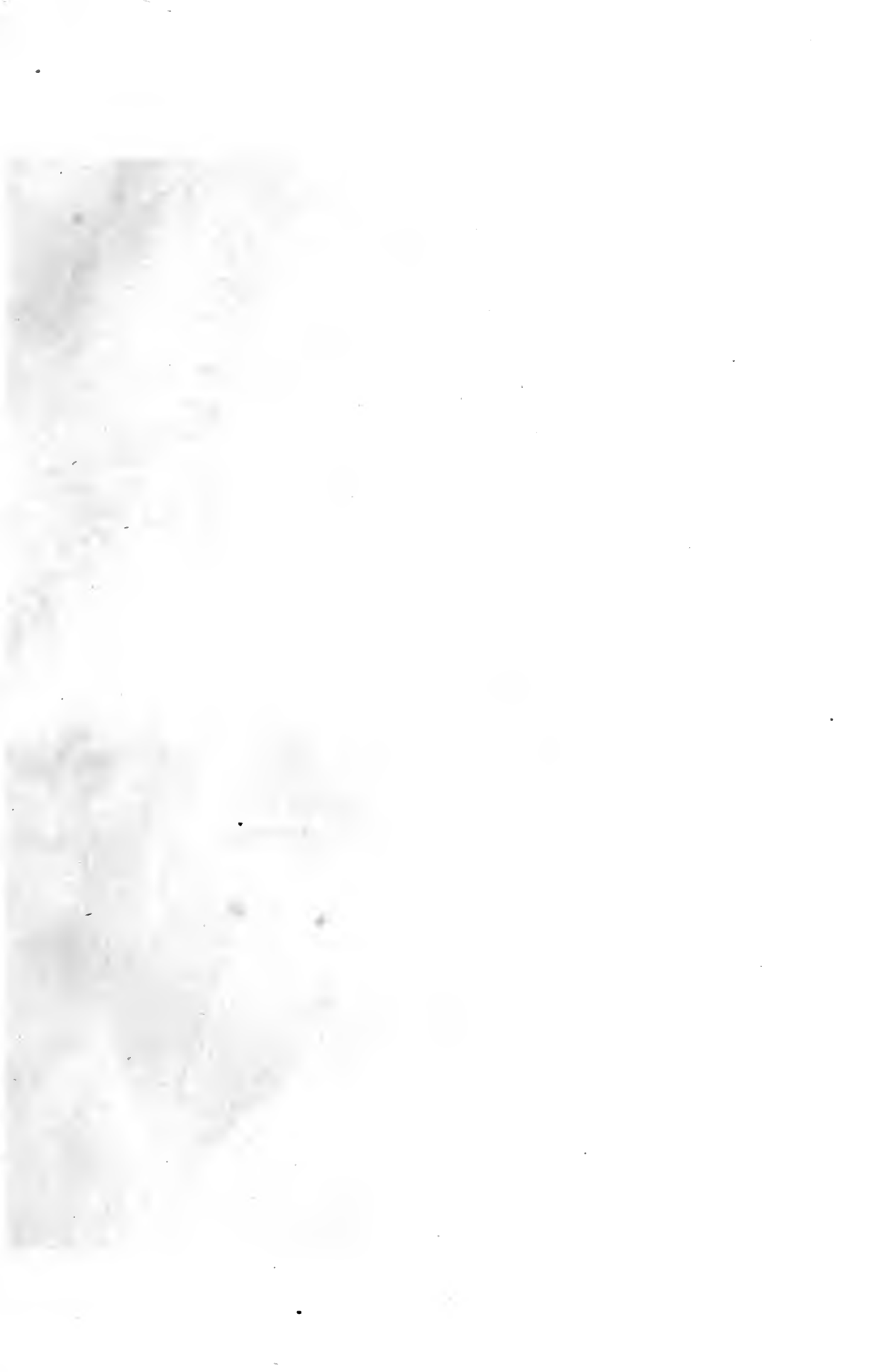



“The common Wild duck, or Mallard, if not the most elegantly formed, is certainly one of the most beautifully-coloured species of its family. The plumage is dense and elastic, on the head and upper neck short and splendid, the feathers of the forehead stiffish; of the cheeks and throat short, linear, slightly rounded; of the rest of the neck shortish, and very soft; on its lower anterior part, large, firm, glossy; on the rest of the lower parts full and blended; on the upper parts firmer. The wings are of moderate length, acute; the primaries narrow and tapering, the second quill longest, the first scarcely a quarter of an inch shorter; the secondaries a little incurvate, obliquely rounded; the inner elongated, very broad, acuminate. The tail is short, much rounded, of sixteen broad, acuminate feathers, and four medial, incumbent, recurvate, reduplicate.

“The bill is greenish-yellow, darker towards the end, with the unguis deep brown, the lower mandible reddish-yellow, brown at the end. The iris brown. The feet reddish-orange, the membranes pale reddish-brown, the claws deep reddish-brown. The forehead is blackish-green, the head and upper neck vivid deep green, changing to deep violet. On the middle of the neck is a ring of white, not quite complete behind. The lower neck and a small part of the breast are very deep chestnut or purplish-brown. The anterior part of the back is yellowish-brown tinged with grey; the scapulars grey, very minutely barred with brown; the hind part of the back brownish-black, the rump deep green, as are the four, recurved feathers of the tail, the rest being brownish-grey, broadly edged with white. The wing coverts are brownish-grey, as are the primary quills and coverts. The secondary coverts, excepting the inner, are white in the middle, with a terminal band of velvet black. About ten of the secondary quills have their outer webs brilliant deep green, changing to purplish-blue, with a black bar at the end, succeeded by white. The outer edges of the inner secondaries deep purplish-brown, the rest grey, minutely undulated with darker. The breast, sides, abdomen, and tibial feathers are greyish-white, very minutely undulated with dark-grey; the feathers under the tail black, glossed with blue; the axillars and lower wing coverts white. Length to end of tail, 24 inches; extent of wings, 35; wing from flexure, 11; tail, $4\frac{1}{4}$; bill along the ridge, $2\frac{1}{2}$; along the edge of lower mandible, $2\frac{7}{12}$; its height at the base, 1; greatest breadth, 1; tarsus, $1\frac{10}{12}$; first toe, $\frac{5}{12}$; its claw, $\frac{2}{12}$; second toe, $1\frac{5}{12}$; its claw, $\frac{4}{12}$; third toe, 2; its claw, $\frac{6}{12}$; fourth toe, $1\frac{1}{12}$; its claw, $\frac{4}{12}$.

“The female is considerably smaller, and very differently coloured. The bill is greenish-grey, darker towards the base; the plumage of the upper parts dusky-brown; the feathers edged with pale reddish-brown; the throat whitish; the lower parts yellowish-grey, faintly streaked and spotted with brown; the speculum as in the male; the middle tail-feathers straight. Length to the end of tail, 20 inches; extent of wings, 32.

“The females renew their plumage annually in autumn, as do the males. But the latter undergo a singular change in summer, which is thus described by Mr. Waterton:—

“About the 24th of May the breast and back of the drake exhibit the first

appearance of a change of colour. In a few days after, this the curled feathers above the tail drop out, and grey feathers begin to appear amongst the lovely green plumage which surrounds the eyes. Every succeeding day now brings marks of rapid change.

“ ‘ By the 23rd of June scarcely one green feather is to be seen on the head and neck of the bird. By the 6th of July every feather of the former brilliant plumage has disappeared, and the male has received a garb like that of the female, though of a somewhat darker tint. In the early part of August this new plumage begins to drop off gradually, and by the 10th of October the drake will appear again in all his rich magnificence of dress, than which scarcely anything throughout the whole wide field of nature can be seen more lovely, or better arranged to charm the eye of man.

“ ‘ I enclosed two male birds in a coop, from the middle of May to the middle of October, and saw them every day during the whole of their captivity. Perhaps the moulting in other individuals may vary a trifle with regard to time. Thus we may say that once every year, for a very short period, the drake goes, as it were, into an eclipse, so that, from the early part of the month of July to about the first week in August, neither in the poultry-yards of civilized man, nor through the vast expanse of nature’s wildest range, can there be found a drake in that plumage which, at all other seasons of the year, is so remarkably splendid and diversified.’

“ The Mallard, which is one of our truly indigenous ducks, occurs in variable numbers in all parts of the country, being more abundant in marshy and thinly-peopled districts than in such as are dry and well cultivated. It is almost needless to remark that the great improvements in agriculture that have taken place within the last 50 years, and especially the vast extension of draining, have banished it from many tracts where it was formerly very plentiful. Still it is by no means rare in any large section of the country, and in very many districts quite common. In winter, it for the most part removes from the higher grounds to the hollows and level tracts, and in frosty weather betakes itself to the shores of estuaries, and even of the open sea. In the Cromarty and Beaulie firths, great numbers occur along the shores during the winter and spring, and at night especially, frequent the muddy parts, where they feed on worms and mollusca. Around Edinburgh are numerous open ditches and some brooks, to which they resort at night, from October to April, when they may be started in great numbers by a person searching their haunts by moonlight.

“ A friend of mine has often shot them on such occasions, and I have myself seen them thus engaged. It being by touch more than by sight that the Mallard obtains its food: the night appears to be as favourable for this purpose as the day, and is chiefly used in populous districts, while in the wilder parts it feeds at least as much as by day. Marshy places, the margins of lakes, pools, and rivers, as well as brooks, rills, and ditches, are its principal places of resort at all seasons. It walks with ease, even runs with considerable speed, swims, and on occasion

dives, although not in search of food. Seeds of gramineæ and other plants, fleshy and fibrous roots, worms, mollusca, insects, small reptiles, and fishes, are the principal objects of its search. In shallow water, it reaches the bottom with its bill, keeping the hind part of the body erect by a continued motion of the feet. On the water it sits rather lightly, with the tail considerably inclined upwards; when searching under the surface it keeps the tail flat on the water, and when puddling at the bottom with its hind part up, it directs the tail backward. The male emits a low and rather soft cry, between a croak and a murmur, and the female a louder and clearer jabber. Both on being alarmed, and especially in flying off, quack; but the quack of the female is much louder. When feeding, they are silent; but when satiated they often amuse themselves with various jabberings, swim about, approach each other, move their heads backward and forward, 'duck' in the water, throwing it over their backs, shoot along its surface, half flying, half running, and, in short, are quite playful when in good humour.

“On being surprised or alarmed, whether on shore or on the water, they spring up at once with a bound, rise obliquely to a considerable height, and fly off with speed, their hard-quilled wings whistling against the air. When in full flight, their velocity is very great, being probably a hundred miles in the hour. Like other ducks, they impel themselves by quickly repeated flaps, without sailings or undulations.

“In March they pair, and soon after disperse and select a breeding-place. The nest, bulky, and rudely constructed of flags, sedges, grasses, and other plants, is placed on the ground in the midst of a marsh, or among reeds or rushes, sometimes in a meadow, or even among heath, but always near the water. Instances are recorded of its being built in the fork of a tree, and a duck has been known to occupy the deserted nest of a crow. The eggs, from five to ten, are pale dull-green, or greenish-white, two inches and a quarter in length, an inch and nine-twelfths in breadth. When incubation commences, the male takes his leave, though he keeps in the neighbourhood, and joining others, undergoes his annual moult.

“The female sits very closely, and, rather than leave her charge, will often allow a person to approach quite near.

“One day, while searching in the marsh at the head of Duddingston Loch for some plants, I was suddenly arrested by observing among my feet some living creature of considerable size. Perceiving it to be a duck, I instantly, perhaps instinctively, pounced upon it; but thinking the eight eggs a sufficient prize, I threw the poor bird into the air, when she flew off in silence. Frequently in leaving the nest she covers it rudely with straws and feathers, probably for the purpose of concealing the eggs. The young are hatched in four weeks, and, being covered with stiffish down, and quite alert, accompany their mother to the water, where they swim and dive as expertly as if they had been born in it. The mother shows the greatest attention to them, protects them from birds, feigns lameness to withdraw intruders from them, and leading about from place to place, secures for

them a proper supply of food. Sometimes the young birds are destroyed by pike, or fall a prey to rapacious birds. They are extremely active, and elude pursuit by diving and remaining under the water, with nothing but the bill above. I once came upon a whole brood of half-grown ducklings in a ditch, when in a moment they all disappeared under the water, and, although I searched everywhere for them, did not succeed in tracing a single individual.

“When the young are well grown, and the female replumed, the male commonly joins the flock, and they continue together. Several flocks often unite, but generally these birds are not very gregarious. Being highly and justly esteemed as food, Mallard are shot in great numbers, and are plentiful in our markets. Although they are of a more elegant form, and much more active than the domestic ducks, the latter often resemble them so closely in colour, as hardly to be distinguishable.

“Once, in the Outer Hebrides, when journeying across a moor, I met with a pair in a small lake overhung by a rock, from which I could easily have shot them, had I not supposed them to be tame ducks that had strayed to a distance from the huts, some of which were about half a mile distant. The young obtained from eggs hatched by domestic fowls generally make their escape.

“This species is found in all the northern and temperate parts of the old continent, and is equally met with in America as far south as the Gulf of Mexico.

“Although great numbers resort to the Arctic regions to breed, multitudes remain in all the temperate districts.

“Whether any immigration from the north takes place with us in autumn is not apparent. During winter the species is found in the most northern parts of Scotland, as well as in the most southern of England. It is common in Ireland, where, although great numbers immigrate every winter, the species breeds throughout the island.

“Mr. Burnett, of Kennay, has favoured me with the following note respecting the Mallard, as observed in his neighbourhood :—

“It is very plentiful in all our marshes and wet moors. It is to be seen on the Don, but not often, and only in certain spots, in the winter, particularly in time of hard frost. It feeds at night only, when it dives, but never so by day. In spring its principal food is frogs and their spawn, to obtain which it resorts to the marshes, where these animals most abound, and wherever wild ducks are numerous, are to be seen the mangled remains of these reptiles. They are also destructive to corn in the neighbourhood of their haunts, to which in general they are steadily attached. They breed in the month of April, mostly in marshy spots and bushy ponds. I have got a nest in a dry spot among furze, far from any water. The eggs are carefully concealed and covered up when the bird is off them. The attachment of this species to its young is very great. When a person approaches them, the parents go up to him, put themselves in his way, flutter on the ground before him, and run to induce him to follow. On visiting the pond at the north mill of Kintone last summer, I saw several broods, the parents all acting their parts

most admirably to draw me from the spot. The males, however, I have never seen thus employed.

“ I once observed nine very young ducklings in a moss-pot, and was amused to see how they kept together, always in the middle of the water. Numbers of the young, or flappers, are taken, mostly by dogs, in the end of July and in August. The males do not assume the female plumage until well on in June, and have their own bright dress again by the beginning of November. Wild ducks occasionally breed with the tame, the crosses showing a disposition to take wing. The young may be brought up, but are not to be trusted unless with tame ones, when they will keep at home. The crossed birds thus produced are said to have a fine flavour, and to be very readily fattened.’ ”

Mr. St. John, in his “ Wild Sports of the Highlands,” has a very pleasant chapter on Wild Ducks, in which he says :—

“ I have frequently caught and brought home young wild ducks. If confined in a yard or elsewhere for a week or two with tame birds, they strike up a companionship which keeps them from wandering when set at liberty. Some few years back I brought home three young wild ducks ; two of them turned out to be drakes. I sent away my tame drakes, and in consequence, the next season, had a large family of half-bred and wholly wild ducks, as the tame and wild bred together quite freely. The wild ducks which have been caught are the tamest of all ; throwing off all their natural shyness, they follow their feeder, and will eat corn out of the hand of any person with whom they are acquainted. The half-bred birds are sometimes pinioned, as they are inclined to fly away for the purpose of making their nests at a distance : at other times, they never attempt to leave the field in front of the house. These birds conceal their eggs with great care, and I have often been amused at the trouble the poor duck is put to in collecting dead leaves and straw to cover her eggs, when they are laid in a well-kept flower-bed. I often have a handful of straw laid on the grass at a convenient distance from the nest, which the old bird soon carries off and makes use of. The drakes, though they take no portion of the nesting labours, appear to keep a careful watch near at hand during the time the duck is sitting. The half-breeds have a peculiarity in common with the wild duck, which is, that they always pair, each drake taking charge of only one duck ; not, as is the case with the tame ducks, taking to himself a dozen wives. The young, too, when first hatched, have a great deal of the shyness of wild ducks, showing itself in a propensity to run off and hide in any hole or corner that is handy.

“ With regard to the larder, the half-wild ducks are an improvement on both the tame and wild, being superior to either in delicacy and flavour ; their active and neat appearance, too, make them a much more ornamental object (as they walk about in search of worms on the lawn or field) than a waddling, corpulent, barnyard duck.”

The young are at first covered with close stiffish down, of a greyish-yellow colour, variegated with dusky on the upper parts. The downy covering continues

for a month or more, when the first plumage is gradually perfected. The young are exceedingly active, dive expertly, hide themselves when alarmed under banks, in holes, or among reeds or other rank herbage, and seem to feed more on insects, slugs, and other small animals, than on vegetable substances.

A curious anecdote of a brood of wild ducks, told by his keeper, is thus related by Mr. St. John :—

“ He found in some very rough marly ground, which was formerly a peat-moss, eight young ducks nearly full grown, prisoners, as it were, in one of the old peat-holes. They had evidently tumbled in some time before, and had managed to subsist on the insects, &c., that it contained, or that fell into it. From the manner in which they had undermined the banks of their watery prison, the birds must have been in it for some weeks. The sides were perpendicular, but there were small resting-places under the bank which prevented them being drowned. The size of the place they were in was about eight feet square, and in this small space they had not only grown up, but thrived, being fully as large and heavy as any other young ducks of the same age.” In from eight to ten weeks after they are hatched, the young are able to fly.

The young, when fledged, resemble the female in colouring, and the young male assumes the full plumage of its sex at the end of its first autumn. Our domestic ducks are the offspring of the wild Mallard, greatly degenerated as to activity and beauty of form, but improved in bulk, and a susceptibility to fatten. Tame ducks lose their native delicacy of feeling, and instead of pairing for life, or at least for a season, become unprincipled socialists, every drake taking as many wives as he can get.

In connection with the subject of Wild Ducks, Mr. Edward Hewitt has supplied us with the following notes on their capture :—

“ No doubt many readers of the POULTRY BOOK will peruse with considerable interest two different ways of effecting this purpose, that I have frequently seen successfully practised, although I readily acknowledge neither the one means nor the other that I shall mention betoken much of the spirit of the legitimate sportsman, but when the extreme difficulty of getting even a single shot at these wary birds is considered, perhaps the pot-hunting character of the means pursued will be overlooked. Be this as it may, I will briefly detail them.

“ To ascertain the most favourite haunts of wild ducks is a matter of but little difficulty. This proved, the place should be baited for a few successive days, to encourage them to flock fearlessly and in numbers, and a little corn will not be ill bestowed. I have known even a single couple unmolested and enjoying the certainty of finding food joined during one short week by others, until fifteen or twenty composed the flock.

“ The first plan is by short lines, with a common fish-hook attached, the bait a small piece of the lungs of any animal; the ‘lights’ of a single rabbit will prove sufficient for twenty baits. As the bait itself will cause the hook to float, it is taken on the water, and then, the line being strong enough, the capture is certain.

It does not do to fasten these lines to the bank, or the birds still at liberty become so alarmed at the struggles of those that are hooked, that they will leave the spot, and be shy for long periods afterwards, and it is not a solitary capture or two that is intended. Previously, to baiting the hooks, a few strong stakes should be driven into the bottom of the shallow part of the ford, the tops being about a foot or so below the surface. The lines should be long enough to give a little freedom to the bird when gulping the bait, and the end opposite the hook is to be attached to a weight, such as a piece of brick, which is placed on the top of the stake, and the instant the bird is hooked, and consequently gives the slightest pull, the weight, being suddenly upset, drags the unfortunate captive under water, to be seen no more, until removed by the party who placed the temptation before it.

“On a long rail supported at the ends by two uprights, I have known a dozen such weights placed, and seven wild ducks caught during one night only.

“The second plan is singularly effective, and even less troublesome than the former one to put into operation, as a boat is not required.

“In this case traps, similar to rat-traps, are the means employed; the shallows should be previously supplied with not only a few ears of corn left swimming about on the surface, but some dozen heads or so should be attached to stones by pieces of string, so as to lie pretty close to the bottom, and they should be dropped in at intervals. After the interval of a few days, the traps, each baited with a single ear of corn only, firmly tied to the trigger, may be gently lowered to the bottom of the water, which for this purpose ought to average from fifteen to eighteen inches deep, and as these birds feed chiefly at nightfall and early dawn, the preparations for catching them are best completed by midday, and the traps left to take their own chance until the following morning. The ducks are generally caught midway along the head, are always quite dead, and mostly are altogether hidden from view by the water.

“From the peculiar character of their plumage, although apparently much wetted on their first removal, if hung up half an hour in the free air, they quickly dry, as the moisture is quite superficial.

“Among the advantages of these plans, the obvious ones are the following:—They both act without any noise whatever, nor does anything seen by the uncaught birds lead them to suspect danger. The entrapped ones seem merely to dive, the remainder still feed closely to them, and as unconcernedly as heretofore; and, moreover, the birds thus caught will keep good a very long time, having sustained no bruises whatever.”

Having given at length the history of the wild original of our domesticated breeds, it is now necessary to speak of the different varieties in detail. Of these, the most important are so-called Rouen or Roan duck, the White Aylesbury, the Call or Decoy duck, the Labrador, Buenos Ayres or East India duck, the Cayuga duck, the Penguin duck, the tufted or crested duck, and the hooked-bill duck.

THE ROUEN, OR ROAN DUCK.

The so-called Rouen duck does not require a lengthened description at our hands, it being simply a variety of the common domesticated Mallard, increased in size by abundant feeding and the careful selection of breeding stock. The breed obviously did not come from the locality from whence it takes its most common name, which is probably a corruption or mispronunciation of the term Roan duck. In fact, like all other geographical titles of our varieties of poultry, the word is a misnomer, and one which, if the alteration were not liable to lead to still greater confusion, it would be very desirable to abolish. Writing on this subject, a correspondent, Mr. E. G. Jones, states, "I have been a breeder of Rouens for some years, and take much interest in their history, but could never discover that Rouen was especially famous for this breed of birds. On the contrary, from inquiries made of poultry fanciers and others who have visited that locality, I have found that these birds were not reared there as a domestic fowl, nor did they abound in a wild state in that district.

"As to the application of the term, it is most probable that it is merely a corruption of the word Roan, or 'Grey duck,' and the animal is not without some claim to the cognomen.

"As to the origin of the breed, there can be little doubt that it has been bred from the Mallard, enlarged and improved by care and good feeding, and corresponds precisely with it in every respect in the details and marking of the plumage.

"The markings found also in the wild species are considered as the criteria of perfection by poultry fanciers and judges, in the present day, which proves much more than any facts I might advance. In support of this latter statement, I may state that I myself have bred from the 'Mallard drake' and 'Rouen duck,' and the produce was true in the marking, and full sized after the third cross."

Mr. Hewitt, writing of the points of merit in these birds, states, "I am confident that the Rouens are the most profitable of the duck tribe. They are more lethargic, and consequently more speedily fed than any others; they lay great numbers of large eggs, the average weight of which should be three and a half ounces, always above three ounces. The colour of the egg is a blue-green, the shell being considerably thicker than in the eggs of the Aylesbury breed.

"The flesh is of the highest possible flavour, and in first-rate specimens is abundant in quality. I have frequently known young drakes of only nine or ten weeks old to weigh when killed twelve pounds the pair, and in some instances even more than this. As regards the consumption of food, I have not found them to require more than the other varieties. In colour, the plumage should closely approximate to that of the common wild duck. The eyes, however, are deeply sunk in the head, and these ducks especially have, even when young, the appearance of old birds, the abdominal protuberance being, as in the case of the Toulouse geese, developed at a very early age.

"This enlargement of the lower part of the body in over-fat specimens causes it to rest upon the ground, not unfrequently to the destruction of the feathers.





Harmon New

LEIGHTON, BROS.

WHITE AYLESBURY DUCKS.

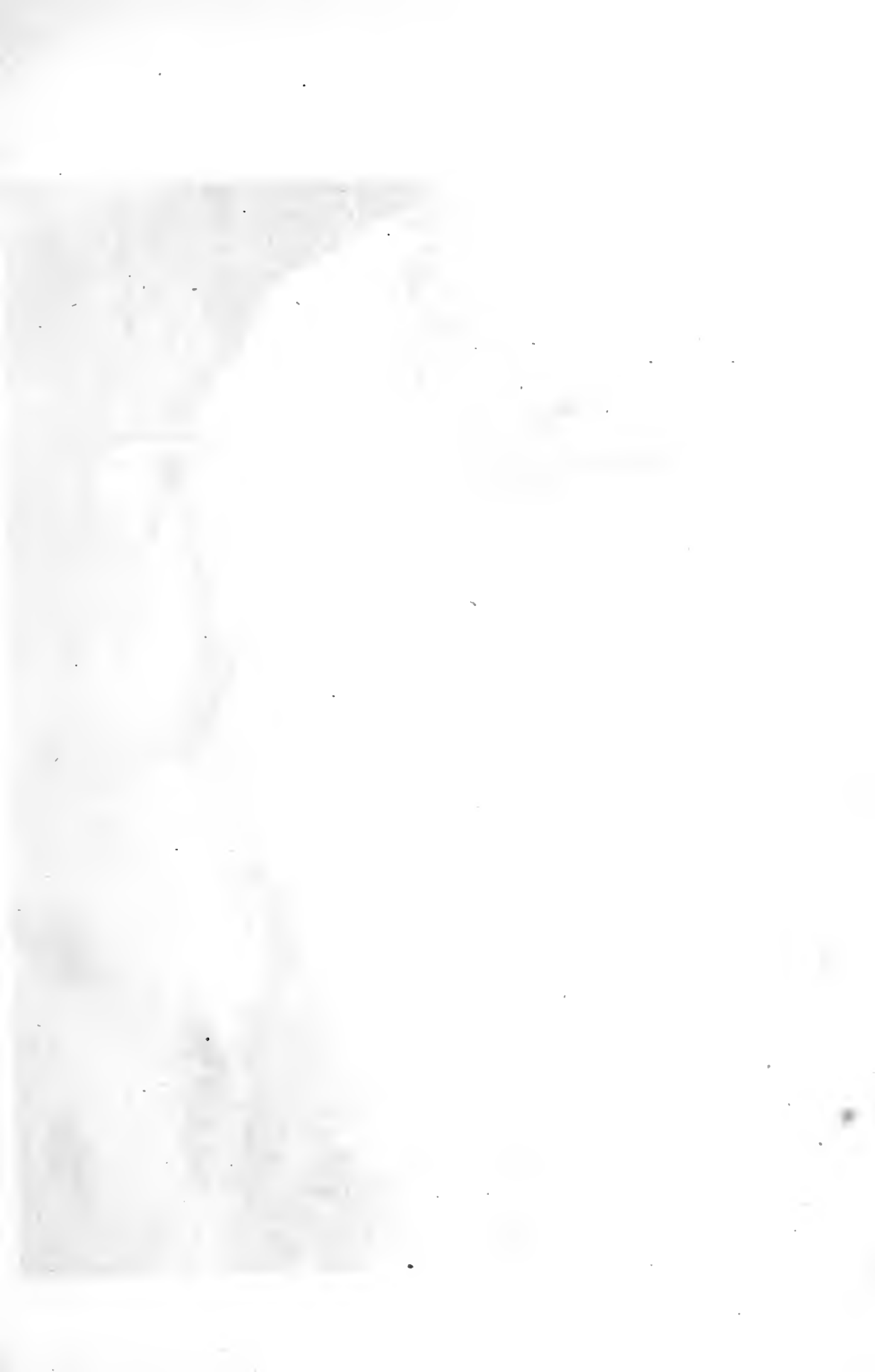



“The appearance of over fat birds is certainly ungainly, but the observer cannot fail to be struck with the size of good specimens of the family. Rouen ducks are as hardy as any other kind, and they rarely evince any disposition to wander from the neighbourhood of the homestead; so dull and lethargic are they, that they are liable to be picked up by any pilferer, and even if one bird is taken, the others will scarcely move away; they appear to care less for exercise on the water than any other variety.”

In weight, Rouens usually exceed any of the other varieties. At the Birmingham show of 1866, the weights of the three prize pairs were respectively nineteen, eighteen and a half, and seventeen and a quarter pounds.

The exact points required in the exhibition-pen are so fully detailed in the “Standard of Excellence,” which is reprinted in the Appendix, that no further details are necessary.

THE AYLESBURY DUCK.

The characteristics of this valuable variety are soon described. Great size, immaculate purity of white plumage, a large broad pale flesh-coloured bill, which should be free from dark marks or stains, constitute the most strongly-marked features of the breed. In weight, Aylesburys are generally somewhat inferior to the Rouens. Of late years, by careful selection of brood stock, great improvements have been effected in the size of this breed; formerly, twelve pounds per pair was thought a good, and sixteen pounds an extreme, weight; but at the last Birmingham show the first prize pair weighed eighteen pounds, and the birds had probably lost a pound during their journey from home.

Aylesburys are, if well fed, prolific layers of fine eggs, the shells of those laid by the best strains being of a clear white. As sitters, Aylesburys are better mothers than Rouens, not being so unwieldy in their actions.

Those intended for brood stock should not be fed to the extent that is requisite in the show-pen, many of the exhibition birds being so fat as to have the abdominal muscles stretched to such a degree that the birds are “down behind.” The inexperienced breeder should be cautious in purchasing such birds, as they are generally perfectly useless for stock purposes, the drakes and ducks being alike sterile.

In order to exhibit these birds in the state of repletion seen at our shows, they are kept away from water, fed most liberally on boiled meal or grain, and confined in a dark room, so as to maintain the delicate flesh-colour of the bills.

The feeding of all varieties of ducks is best managed by putting the grain into a pan of water. In this way it is taken more readily, not any portion is wasted by being trampled in the mud, and the birds are maintained in better health and in finer condition by not having to devour the food soiled by the manure of the yard. As the Aylesburys are the variety most generally selected for the supply of the London markets, the following extract from an article by Mr. Tegetmeier, on poultry regarded as agricultural stock, may not be without interest:—

“In suitable localities, no kind of poultry are more remunerative than ducks, whether regarded as egg-producers, or as furnishing young birds for the markets.

“The variety that is most remunerative is undoubtedly the large White Aylesbury. Their great weight, extreme prolificacy, and the rapidity with which the young ducklings attain a size fit for the table, render them superior to any other breed. The true Aylesbury are distinguished by their great size. The weight of the three prize pens (each containing a drake and one duck) at the Birmingham Show in 1866 was, the first prize pair, eighteen, and the second and third, sixteen and a half pounds each. If these birds are fed liberally, and kept in a house which is provided with fresh straw, and cleaned daily, they will lay during the coldest weather, when the eggs should be placed under hens. For this early hatching of ducklings; Cochins are particularly advantageous, as they sit well, and cover a large number of eggs. The ducklings when hatched should be fed most abundantly with slaked oatmeal, and afterwards with oats thrown into a pan of clean water. Their appetites are voracious; but their growth is remarkably rapid, and under this system of management they are fit for the market in less than two months. Those birds intended to be killed should be prevented from swimming; but those that are to be retained for stock should have free access to water.

“The profit of rearing young ducks for the London markets is very considerable. In some districts near the metropolis the labourers endeavour to get early clutches of ducklings, and rear them by hand in their cottages, and near Aylesbury great numbers are raised by persons who follow that occupation exclusively. The prices realized in the market by early ducklings, of necessity varies with the supply, but I have known them produce 8s. to 10s. each for several weeks together.

“One precaution should be taken in order to obtain all the eggs laid by the old ducks, namely, to shut them up during the night. It is generally at this time that they lay; and by adopting this precaution the whole of their eggs are secured; otherwise many are lost, as the ducks, until shortly before becoming broody, are careless layers, often dropping their eggs in the water, where they sink, and remain until putrid.”

THE BUENOS AYRES, EAST INDIA, OR LABRADOR DUCK.

If any circumstance were required to show the absurdity of geographical names for varieties of domestic animals, it would be found in the three titles given to this pretty little black variety of the Mallard. The bird is certainly not known in Labrador, nor is it common in the East Indies. The Zoological Society first received these birds from Buenos Ayres; but when we bear in mind the fact that sailing vessels are continually conveying birds from one port to another, the fact does not prove that they originated in that locality, nor is the knowledge of the place from whence they were obtained of any consequence, as they are obviously merely artificially perpetuated variations which do not exist in a wild state. Mr. Hewitt, who

has had great experience with water-fowl, has favoured us with the following notes on the management and characters of the variety :—

“ These birds are of exceedingly hardy constitution, and will bear severity of weather without any injury. They are, however, very prone to attempt to leave their habitation before any extreme change of weather, such as approaching storms or excessive frost. At these times their restlessness not unfrequently induces them to take wing, and sometimes, joining flocks of wild fowls, they fall a prey to persons shooting wild birds at the approach of nightfall. I know many broods of Buenos Ayres that, in winter-time, frequently absent themselves for many days together, and ramble to distant extensive waters, but eventually return in safety to their owners.

“ During these excursions they always become very wild, and it is with extreme difficulty any one can manage to approach them ; yet singularly, when they are permitted to return home again without injury or accident, they seem but little altered in their dispositions, and will retire to their usual haunts, as though no such freak had been indulged in. They are naturally somewhat shy at all times, but of course this trait of character is much modified by the treatment they receive from their owners. I have even known them fly to feeding-marshes, five or six miles from their owner's house, early in the morning, and return towards the time the poultry generally received their evening meal of corn, staying until morning. But much seems dependent on whether or no there are any wild ducks in the neighbourhood to entice them to such wayward practices, for certainly there are now many instances in which flocks of the Buenos Ayres ducks prove equally attached to the homestead as any other description of tame ducks.

“ The flavour of their flesh is very superior, and assimilates very closely to that of the Mallard. I have oftentimes known them placed on table as wild duck without the deception being discovered by considerable numbers of guests, and who afterwards, on being informed, could scarcely believe they had been thus imposed upon. Buenos Ayres ducks lay well, and the eggs are of good quality ; at the commencement of the laying season, the shells of the eggs are of a sooty hue ; gradually however, the eggs assume a more natural colour, until the last produced are but little different in appearance to those of the common wild duck. By very long domestication, these birds attain an increased size, and, although not permitted access to any common ducks, they even then will show a tendency to sport triflingly in colour, and even occasionally to mottle a little with white around the eyelids, or in scattered feathers here and there along the breast. Such birds are of course inadmissible in the exhibition-room.

“ Their plumage should be wholly black, glossed all over with a peculiarly lustrous though very dark green shade ; the legs are sooty black, as are the beaks of the females ; those of the drakes assume rather a dark yellowish green colour on the upper mandible ; the feathers on the head and neck of the males are far more glossy than those of their mates. The smallest and most neatly built among the Buenos Ayres are the most admired.”

THE CAYUGA, OR LARGE AMERICAN BLACK DUCK.

Under the title of the Cayuga, or Big Black duck, a large variety is known in the United States, which would be a desirable addition to our poultry-yards. Mr. C. N. Bement, a well-known transatlantic writer on poultry subjects, thus describes it in an article in the "American Country Gentleman:"—

"This bird derives its name from the lake on which it is supposed to have been first discovered. Of its origin, little is now known; it was quite common some fifty years ago in the barn-yards in the vicinity of Boston, &c. 'In the year 1812,' says Dr. Bachman, in a note addressed to Mr. Audubon, 'I saw in Dutchess county, in the State of New York, at the house of a miller, a fine flock of ducks, to the number of at least thirty, which, from their peculiar appearance, struck me as different from any I had before seen among the different varieties of the tame duck. On inquiry, I was informed that three years before a pair of these ducks had been captured in the mill-pond. They were kept in the poultry-yard, and it was said were easily tamed. One joint of the wing was taken off to prevent their flying away. In the following spring they were suffered to go into the pond, and they returned daily to the house to be fed. They built their nests on the edge of the pond, and reared large broods. The family of the miller used them occasionally as food, and considered them equal in flavour to the common duck, and they were easily raised. The old males were more beautiful than any I have examined since, and as yet, domestication has produced no variety in their plumage.'

"The young of this species,'—the Wild Black duck—says Audubon, 'grow with remarkable rapidity, and, like the Mallard, of which they seem to be only a variety, acquire the full beauty of their spring plumage before the season of reproduction commences. * * * * In the early part of autumn the young afford delicious eating—in our opinion, very much superior to the famous and more celebrated canvass-back duck.'

"It is admitted,' says another writer, 'that our Cayuga ducks originally sprung from the Wild Black duck; however altered they may now appear in bulk, colour, or habits, the essential habits remain the same; no disinclination to breed with each other is evinced between them, and the offspring are as prolific as their mutual parents. The general tone of their plumage is closely repeated in all specimens.'

"Of the origin of the Cayuga duck, I cannot give anything reliable. This duck has been bred in the country so long, that all trace of the origin is lost. Tradition says they are descended from a sort of wild ducks that stop in Cayuga Lake and Seneca River, on their passage North and South, fall and spring; yet from hunters I have never been able to obtain or hear of any closely resembling them, either in weights or feathers. Yet they are called the 'Big Black duck,' 'Cayuga,' or 'Lake duck.'

"The Black Cayuga duck in perfection, is black with a white collar on the neck, or white flecks on the neck and breast—rarely black without white, and as the

white seems inclined to increase, we usually select them nearly or quite black for breeding. The duck has a faint green tint on the head, neck and wings. The drakes usually show more white markings than ducks, and the green tint on head and neck is more strongly marked. They differ from the East Indian and Buenos Ayres ducks very materially; they are much larger, longer in body, and shorter in leg, better feeders, but are not so intense in colour; indeed, beside the East Indian, the Cayuga looks brown.

“When well fed, the duck begins to lay about April, and usually gives an egg every day until eighty or ninety are laid, when she will make her nest and sit, if allowed; if not, will generally lay a litter in September.

“The Cayuga ducks are hardy, of good size, and for the table are superior to other ducks; the flesh quite dark and high flavoured. If well fed, they become very fat; can be readily made so fat they cannot raise themselves from the ground by their wings, a foot wide board keeping my ducks from my little trout-pond. My flock last year weighed: drakes 9 pounds, ducks 8 pounds, or 17 pounds the pair; these are extreme weights, and only to be reached by careful feeding; 12 to 14 pounds the pair would be a good average. I once had a small flock that averaged at six months, 16 pounds the pair, but they had been forced to their utmost, and never gained weight after six months. The Cayuga duck is very quiet in its habits; they are rarely able to rise from the ground, a fence one foot high will turn them; they are not disposed to wander from home; they commence laying about the last of March, and lay fifty to ninety eggs, when they wish to sit, which they do well, but they are careless mothers; they cross readily with other ducks, and produce is certain.”

If it were considered desirable to establish a breed of large black ducks in this country, it would hardly be requisite to send across the Atlantic for the variety. By mating large Buenos Ayres drakes with heavy Rouen ducks, such a breed might readily be produced, and, by careful selection of brood stock for a few generations, would become firmly established.

CALL DUCKS.

The title of Call ducks is given to two small varieties of the domestic duck, that bear the same relation to the full-sized birds that Bantams do to ordinary fowls. They are known as the grey and the white Call; they both differ from ordinary breeds in their very small size; for show birds, the smaller the better. The shape of the head is also distinct; they are most esteemed when possessing a full round forehead, with a broad short bill. In colour, the grey Call should be an exact counterpart of the Rouen and wild breeds, not only in plumage but also in legs, feet and bill. The white Call should be clothed in feathers of pure and unsullied white; the bill, however, is not flesh-coloured, as that of the Aylesbury, but a bright clear unspotted yellow, any other colour being regarded as disqualifying the birds from success in a severe competition.

Call ducks, as their name implies, are remarkable for their loud and continuous

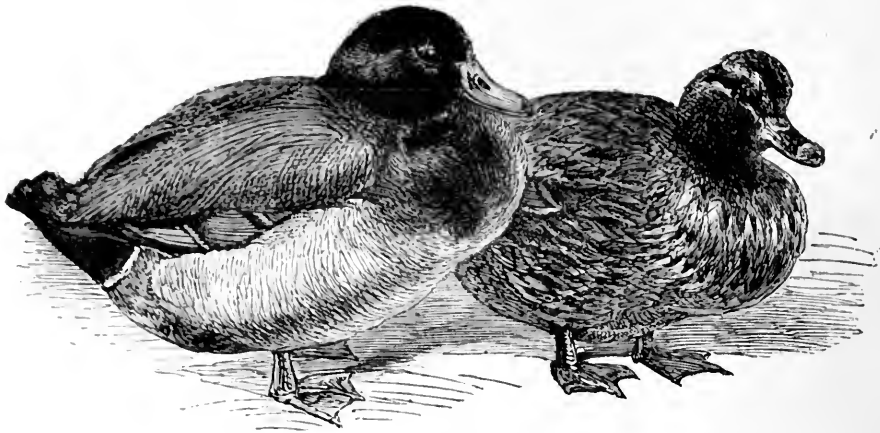

GREY CALL DUCKS.

quacking, in a shrill high note, which can be heard a great distance, and which renders them admirable as decoy ducks to allure the wild species to their destruction.

As fancy water-fowl on ornamental pieces of water, both varieties are very attractive.

THE PENGUIN DUCK.

This very extraordinary-looking duck is characterized by an extreme shortness of the femora, the thigh or upper bones of the legs; hence their feet are not brought, as in other ducks, under the middle of the body, at an equal distance from the head and tail, but are placed much farther behind. In consequence of this peculiarity of structure, the duck, in order to bring the centre of gravity over the point of support, is obliged to assume an erect attitude, like that of the Penguin, or other diving birds whose feet are placed in the same position.

Beyond this quaint peculiarity, the Penguin duck has no speciality to call for particular observation, or to distinguish it from the ordinary species, of which it is evidently only an accidental variation, perpetuated by the care of man. The colours of the Penguin duck are varied, and the bird breeds freely with any of the common varieties.

THE HOOKED-BILLED DUCK.

The Hooked-billed duck is another accidental variation which has been propagated by man. It is characterized by the bill being turned downwards, instead of being straight, as in the other varieties. In Holland this variety was formerly not unfrequent, and was frequently delineated by the old Dutch masters. In colour and size, the Hooked-billed ducks varied very considerably.

THE TUFTED, OR CRESTED DUCK.

This is another variation which has been perpetuated and even increased by the care and selection exercised by man.

It is characterized by a large tuft of feathers on the top of the skull, very like that of a Polish hen. In some cases this globular crest attains a large size, and renders the birds very remarkable objects. In the skulls of some specimens that we have examined after death, we have noticed a deficiency of the bones of the forehead, their place being supplied by a cartilaginous thickening of the membranes under the base of the crest.

THE FARM-YARD DUCK

Calls for no special description at our hands. In size, early maturity, and aptitude to fatten, the mongrel races that are found in too many localities are far inferior to the Aylesbury or Rouen breeds, whether regarded as profitable for the table or market, or viewed as ornamental and elegant water-fowl.

Before concluding this long list of the varieties of the domesticated duck, we may call attention to another variation that not unfrequently occurs, namely, the absence of the web or membrane between the toes; this also is hereditary, but it is not generally perpetuated by the owners, as the ducks have not the power of swimming with vigour. We mention it merely to notice a very common error concerning its production, namely, that the birds so varied are the result of a union between the common fowl and the duck: it should be needless to insist on the absurdity of such a belief, which has no foundation whatever in fact.

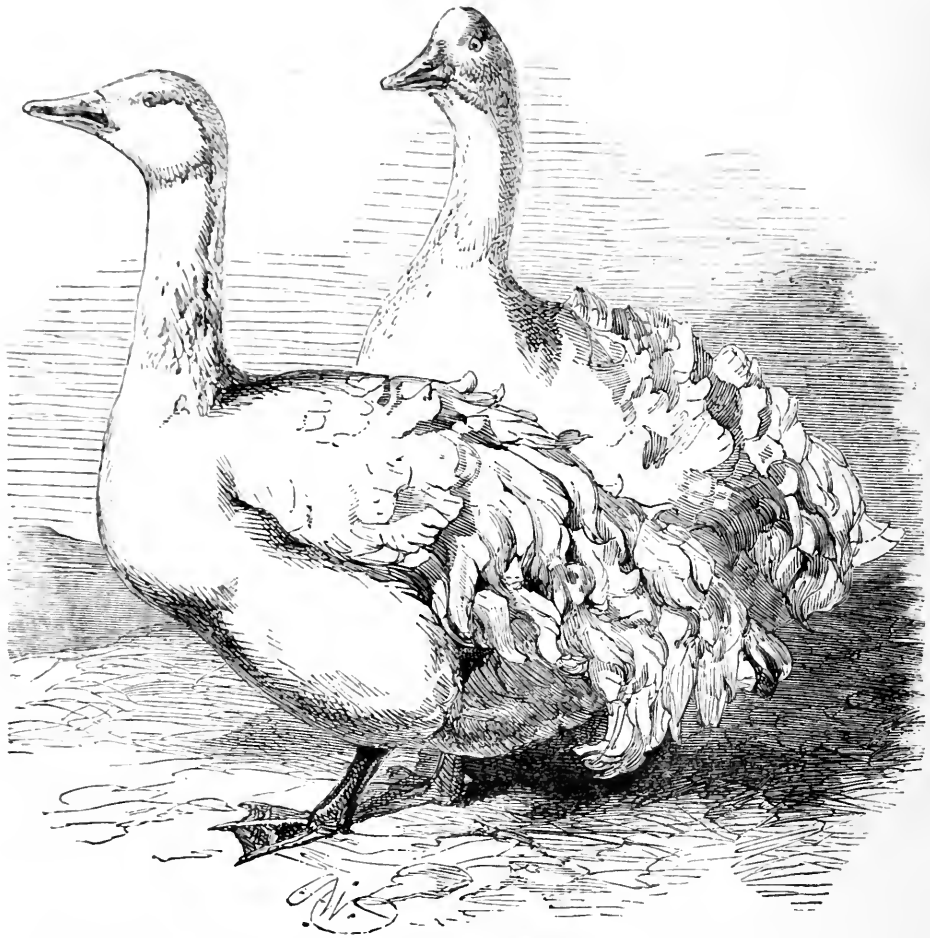

SEBASTOPOL GESE.

CHAPTER XXIX.

GEESE.

THE origin of the domestic goose is generally referred by naturalists to the well known wild species the Grey-lag goose, the *Anser ferus*. Mr. Yarrell, in his "History of British Birds," writing of the Grey-lag, states,—“This species is considered to be the origin from whence our valuable domestic race is derived; to show the aptitude of the wild bird to this purpose I may mention that the Zoological Society possessed a wild Grey-lag gander that had never associated with other species of wild geese kept on the same water with him, but that paired with a domestic goose, selected from exhibiting in her plumage the marks which belong to, and distinguish, the true Grey-lag. The goose laid a sitting of eggs, the offspring from which were prolific.” At the exhibition of



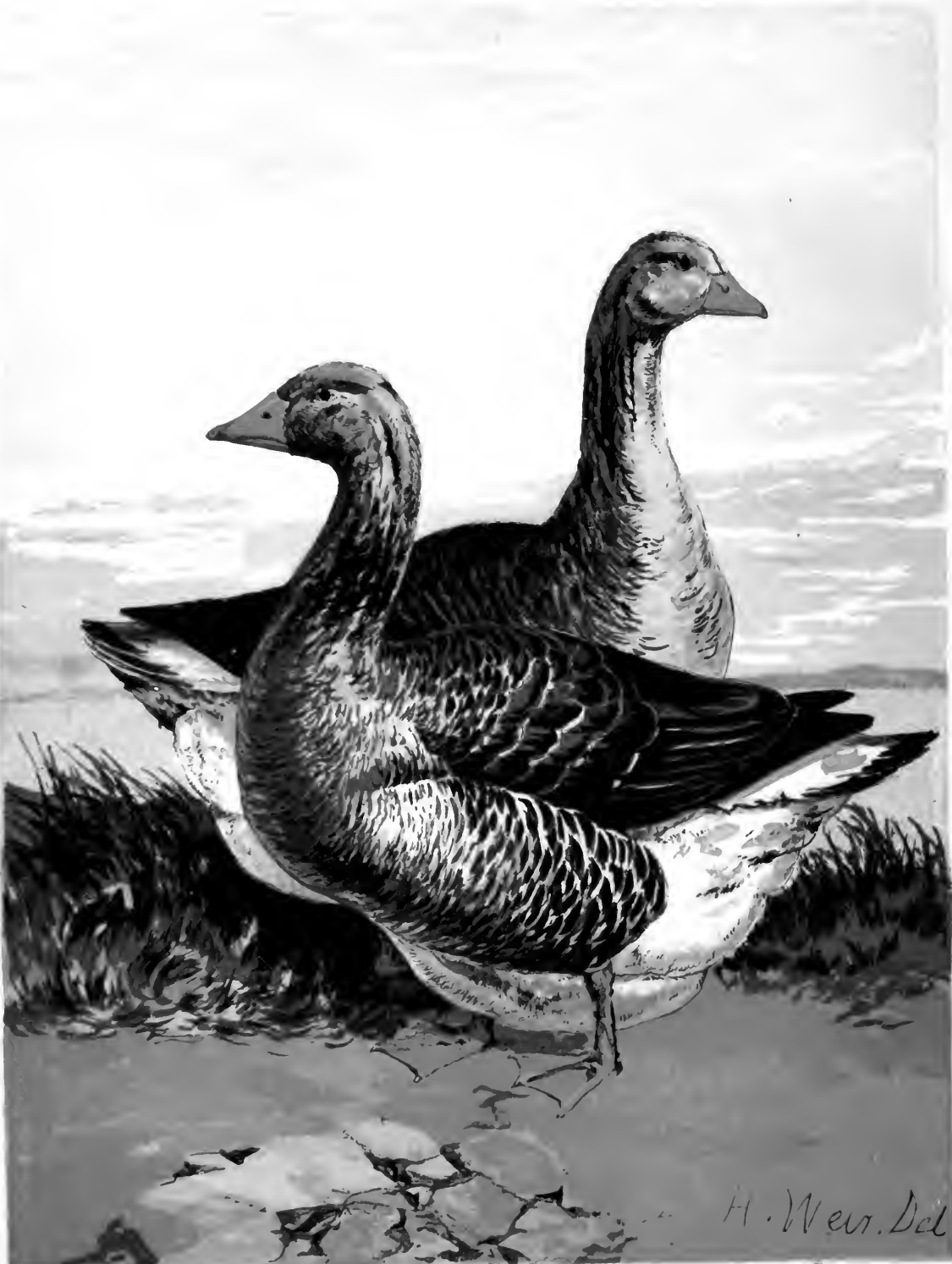

H. Weir. Del

FRIGHTON, BRO.

AMERICAN GOOSE.





domestic poultry and water-fowl held in the Gardens of the Zoological Society, Regent's Park, at the end of May, 1845, there was a fine specimen of Grey-lag goose sent from India by Mr. Blyth to Mr. Bartlett, who exhibited the bird. In the next coop was a fine pair of domestic geese: it was most obvious that these domestic geese were derived from the Grey-lag goose. The pinky flesh colour of the beak and the white nail; the distribution of the markings of the plumage generally; the large blue grey space on the anterior portion of the wing; the flesh colour of both the legs and feet, and the voice, were alike in both. The half-bred geese, previously referred to as bred by the Society, were also exactly similar.

“The *Candidus Anser* of Lucretius, which, by its cackling, excited the attention of the guard and saved the Roman Capitol, was perhaps of the same race as those we possess at the present time, as it is very likely that after the Romans had established themselves in this country, they would introduce many of their own domesticated animals.”

Mr. Yarrell goes on to say that he is unable to answer the question as to the origin of a white goose from a grey species; but this is really no argument against the theory which regards the Grey-lag as the origin of our tame birds, inasmuch as all animals vary in colour by domestication, and there is no difficulty in perpetuating any colour that may have been thus produced by careful and discriminating selection of breeding stock.

As those naturalists who have paid the greatest amount of attention to this group of animals regard the Grey-lag as the origin of our domestic breeds, it is desirable that we should enter into a consideration of the habits of the wild original. Writing of the Grey-lag (*Anser ferus*), Macgillivray states:—

“Whatever may have been the case formerly, when it was said to be very abundant, and permanently resident in England, this species is not now of common occurrence in any part of Britain, and does not remain to breed with us. In Ireland it is of occasional but rare occurrence in winter. Not being able to distinguish it, at a distance, from the Bean, and Short-billed or Pink-footed geese, I can say nothing respecting its peculiar habits, and, for the same reason, even those which are common to it and them, cannot be spoken of with certainty. However, this much may be said:—It makes its appearance in various parts of the country towards the beginning of winter, and departs in the end of April. It resorts, not to marshy places only, but to open pastures and cultivated fields; its food consisting of the root-stems of aquatic grasses, young corn, clover, and other green herbage. Being very shy and vigilant, it is not easily shot; and when feeding in the fields, on the alarm being given by one individual, they all erect their necks, run forward, and, uttering their loud grating cries, spring into the air. Their flight is rather heavy and sedate; when they are proceeding to a distance, performed at a great height, the birds on such occasions advancing in a line, or in two lines forming an acute angle. The flesh of this species is savoury,

having a higher flavour than that of the tame goose ; but it is not as often seen in our markets as the Bean goose.

By the older writers, this species was confounded with the Bean goose and the Pink-footed goose. The three are so very similar in plumage, that, until one has compared specimens of them, it is not easy to determine them separately. The present may, however, be known by its much larger bill, which is flesh-coloured, with its unguis whitish.

“The common domestic goose appears to be the civilized offspring of the Grey goose, to which, in bulk and proportion, it bears the same relations as other tame animals do to their prototypes : as a short-horned ox to a Devonshire ox, or a domestic drake to a mallard.”

The Grey-lag goose is widely distributed over the globe. Even in Northern India it is a common winter species. Jerdon, in his admirable work, thus describes the family and the species under notice :—

“The family of Anserinæ, the true geese, have a large heavy body, with a tolerably long neck and a small head. The wings are long and powerful. They live in flocks, breeding for the most part in the polar regions, and migrating in winter to more genial climes ; when flying, they maintain regular long lines, and emit loud clanging calls. In consequence of the forward position of the legs, they walk well on land. They feed entirely on vegetables, grazing on grass and young corn, their stout short bills being well suited to biting off the shoots ; and they spend the heat of the day on sand-banks in rivers or the centre of large lakes. They make large nests of grass, &c., on the ground in marshy places, and lay several whitish eggs. The first down of the nestlings is mottled.

“The common wild goose, or Grey-lag goose of England, is a common winter visitant to the north of India, extending its migrations to Central India, but is rarely seen farther south. It is sometimes met with in small parties of from four to twenty ; occasionally in vast flocks, which feed on young corn, grass, &c., and during the heat of the day rest on some sand-bank in the large rivers, or in the middle of a tank. This goose is a very wary bird, approached with difficulty when feeding, but may be occasionally stalked when feeding on the bank of a river or tank : I have often killed it from a boat. The flesh is excellent. In the wild state, it breeds in Northern Europe and Asia, making a large nest among the rushes, and laying from eight to twelve whitish eggs.

“The Chinese or Knobbed goose, the *Anser cygnoides*, was considered by Cuvier to belong to the swans, but is strictly a goose with sixteen cervical vertebræ. It is domesticated in China, and breeds readily with the common goose. Blyth considers the common goose of India to be a hybrid between this and *Anser cinereus*.”

The allied species of the genus *Anser*, namely the Bean, the Pink-footed and the White-fronted geese, though frequently stated to be in part the progenitors of our domestic variety, do not appear to cross readily with the common species,

or Grey-lag. Writing of the *Anser phœnicopus*, or Pink-footed goose, Mr. Yarrell states that—

“Little is known of the particular habits of this species in a wild state, but Temminck mentions that three specimens, kept in a domestic state, with others of the Grey, the Bean, and the White-fronted species, did not associate with either of them, but kept by themselves. The same habit has been observed of this species in two instances in this country.

“The Zoological Society have had a male for several years, which has never associated with any of those of the various other species with which it has been confined.

“The Ornithological Society had a female, which, during the summer of 1840, would not associate with any of the various species kept with her in St. James’s Park, yet she laid eight eggs, and began to sit; from which, of course, there were no proceeds.”

Leaving the question of the origin of the domestic goose, we now come to the consideration of the different domesticated varieties of this bird. The most marked are the large white goose, generally termed the Embden goose; the large grey goose, or Toulouse; the common mottled grey and white, or saddle-back goose; and lastly, the curled-feathered, or Sebastopol goose.

The common grey or white goose has no distinguishing features to call for special notice; it is inferior in size and capability of early maturity to the improved breeds, such as the Embden or Toulouse. Respecting the relative advantages of these two breeds, it is difficult to speak positively,—each have their admirers and advocates. Mr. Hewitt writes:—

“In geese I must claim pre-eminence for the Embden or white variety. I have traced the best specimens of this kind through several owners, and found that the originals (in these instances) came from Holland. One of their great advantages is this, that all the feathers being perfectly white, their value, where many are kept, is far greater in the market than is ever the case with coloured or mixed feathers. In weight, too, these birds have an advantage even over the Toulouse. In instituting comparisons between the white and coloured geese, I have noticed that the pendent abdominal pouch of the Toulouse tells sadly against it when dressed, and would undoubtedly be prejudicial to its sale, in accordance with the current opinion of such an appendage being indicative of advanced age; though, in the Toulouse, it is as apparent in the living gull of six months old, as it would be in the Embden variety at thrice as many years. The quality of the flesh is about equal in flavour in either kind; but the Embden is the earliest layer, and frequently rears two broods in one season, the young ones proving as hardy as any with which I am acquainted. The Embden goose has prominent blue eyes, is remarkably strong in the neck, and the feathers, from near the shoulder to the head, are far more curled than is seen in other birds.

“All white aquatic poultry are considered to dress, *id est*, ‘pluck’ of a clearer and better appearance, than the parti-coloured or dark-feathered birds, more

especially whilst young. This arises from the patches where the dark feathers grew, showing even after being carefully plucked, more particularly if the plumage at the time they are killed happens to be immature. Although when roasted no difference is perceptible, yet a clear-skinned bird always commands the most ready sale at the poulterer's."

In weight, these two celebrated varieties run very close together. The diligent and careful attention that has been paid of late years to the improvement of poultry, has resulted in a great increase in the size and weight of geese. At the last March show, 1866, the heaviest pair exhibited were the old Grey geese, the first prize pair of which weighed $59\frac{1}{2}$ lbs; the first prize old white geese being $57\frac{1}{4}$ lbs. A few years since, the rearing of a pair of geese, of any age or variety, that would weigh over half a hundred-weight, would have been regarded as a feat of impossible attainment; this limit has now been surpassed, and we have no more to believe that the *ne plus ultra* has been reached.

The first prize young birds of the year, at the same show, weighed between 42 lbs. and 43 lbs., in both the white and grey classes.

Among the most singular variations of plumage occurring in the domestic geese, may be mentioned that found in the so-called Sebastopol geese, figured at the commencement of this chapter. These geese were first exhibited by Mr. Harvey D. Bayly, in 1860, and were delineated and described in the *Illustrated London News*, of Sept. 8. The following was the account that was published respecting them on their first introduction:—

"Amongst the geese there were two curious specimens from Sebastopol, exhibited by Mr. T. H. D. Bayly. These birds are somewhat smaller than those of this country at a mature size, but they are of the purest white and the most perfect form, whilst the more conspicuous portion of their plumage is of a curly nature, affording a very striking contrast to the feathers of the ordinary English goose. The feathers on the back are curved and frilled upwards; the secondary feathers of the wings are elongated and twisted, also the tail coverts. These geese were sent to Mr. Bayly by John Harvey, Esq., who had been cruising in the Black Sea. Their weight is 11 lbs. each. They are of precisely the same habits as our English geese."

The great peculiarity in these geese consists in the extreme elongation of the feathers of the back (scapulars and tail coverts). The shafts of these long feathers split down their entire length, and then become twisted, so as to give rise to the peculiar curled appearance shown in the wood-cut. Since their first introduction these geese have propagated very freely, and are now constantly to be seen in the various poultry shows. As combining the ornamental and the useful, these quaint birds have few superiors.

The different varieties of geese must not be passed over without allusion to a very distinct species—the Chinese, also known as the Hong-kong, Knob-fronted, and occasionally as Spanish geese. These birds are so distinct in their form and habits, that Cuvier arranged them with the swans, and gave the species the

scientific name of *Cygnus anseroides*. Though now usually regarded as true geese, their close alliance to the swans is indicated by the specific name of *Anser cygnoides*. Of these birds two distinct varieties are known, one is pure white, with bright-yellow bills and feet. The coloured variety, which is more common, is remarkable for the modest arrangement of colour in the plumage, and is strongly characterized by a dark stripe down the back of the neck, a peculiarity which, in a lesser degree, characterizes the hybrids between it and the common species. As layers, Chinese geese are greatly superior to the common species, usually laying more than thirty eggs before wanting to sit: they commence in the very cold weather, and lay two, and sometimes even three, batches of eggs in the year. They are good grazers, but obtain a larger proportion of their food from streams than the common birds.

Nevertheless, they have their drawbacks: they are often accused of keeping up an incessant screaming clang, which is said to be continued throughout the night. That their voice has a disagreeable metallic resonance, is perfectly true, but it is uttered so seldom as to be quite unobjectionable. It is never to be heard during the night, and seldom in the day, except when they are frightened, or come home hungry. In the first case, it may be regarded as advantageous, as it may be regarded as a cry for assistance, or a warning that the owner's property is in danger; and in the second, their mouths are soon closed by a handful of oats or barley.

They are very domesticated, keeping near home, and returning constantly in the afternoon; but if they are not shut up a little before dark, they are apt to take to the river or any adjacent water, and, spite of all coaxing and remonstrance, persist in spending the night out of doors. This propensity is (in a place where they may meet with more admirers than their owner) somewhat of an objection; but it is the only fault that can be alleged against them. As table birds, they are of very superior quality.

They breed freely with the common goose, and what is very remarkable, the hybrids so produced are perfectly fertile if mated with either the Chinese or common geese; but there is some doubt whether they are fertile, *inter se*, that is, if mated with each other, so as to perpetuate the true cross. The experiment has been tried with birds of the same brood, but the only way in which it can be satisfactorily performed, is by pairing two half-bred birds not related.

The plan of feeding that it is best to adopt with these and other aquatic birds having an extensive range, is as follows:—In the morning early they should be let out, when they immediately proceed to the river or the water, and feed for an hour or two, they then come out, dress their feathers, and graze, afterwards they return to the river, and wander about until the afternoon, when they return, and should be rewarded for their attachment to home by a little corn. At dusk they should be shut up, about two handfuls of oats or barley being allowed to each bird. This is best placed in a large pan of water, in the house where they are enclosed.

One great advantage of the Chinese geese, over common breeds, is the early period at which they lay, often commencing in January or February. In this case, four or five of their eggs may at once be placed under a Cochin or Dorking hen, and the owner will be rewarded with young geese fit for the table at a period when his neighbours are looking forward for the hatching of their goslings.

With regard to the profitable management of geese as farming stock, the most sensible and practical directions that we have met with are those published by Mr. Trotter in his essay in the "Journal of the Royal Agricultural Society." These remarks we gladly transcribe.

"The management of geese is attended with less trouble than any other poultry (of course we mean in situations adapted for them); their food is of the very coarsest kind; I hesitate not, therefore, to affirm, that the profit arising from them is immense.

"We must, in the first place, attempt to set aside the prejudice which both ancient and modern writers have displayed against those which are parti-coloured. In the neighbourhood surrounding us large numbers are reared every year; we therefore have many opportunities of judging of the various qualities of the different colours to warrant us to come to conclusions without following in the path of compilers. I would as soon breed from a parti-coloured goose as from one all of the same colour. We had a grey and white goose which, for successive seasons, had two broods; the first never falling short of twelve (a number not one goose in twenty produces), and generally five, six, or seven, the second brood.

"Geese are kept not for the production of eggs for sale, but for the purpose of hatching; the number of geese to one gander should not, therefore, exceed four. It is said, and strongly insisted on, if the goose be not in water when receiving proofs of the attachment of her male companion, that the eggs will not be fertile. We cannot speak to this, never having tried the experiment of keeping them from the water; however, it is received as a fact, and some go so far as to drive the goose to the water with her mate as soon as she leaves the nest.

"The goose commences to lay in February, or March, and continues until she has from eight to fourteen eggs. Some writers assert that, by removing the eggs from the nest as fast as they are laid, she may be induced to lay as far as fifty, if highly fed. This appears to me very marvellous, for I never succeed in getting more than twelve or thirteen from one goose. The eggs are removed as soon as the goose leaves the nest; and I think it impossible for geese to be better fed than ours.

"The approach of the laying season is known by the goose picking up and throwing about her straws or small sticks, or by picking lime off walls. As soon as this is observed, a nest should be provided for her in the same house in which she has to sit. Every morning she must be examined; when she has to lay she must be kept in, and, if possible, compelled to lay in the nest provided for her: having once laid in it, she will seldom seek any other.

“When the goose is inclined to hatch she remains on the nest. During the first two or three days she seldom sits steadily; the eggs should not therefore be given to her until the third day. The time of incubation is about twenty-nine days. With geese, as with all poultry, during the time they are sitting the less they are interfered with the better. When the goose leaves her nest, care must be taken to supply a sufficient quantity of food and water, and that she does not remain too long from her eggs—say fifteen minutes.

“Goslings, being much hardier than the young of any other poultry, do not require so much caution in assisting such as make slow progress out of the shell.

“If the weather be fine, the goslings should be turned out into a sheltered situation the first day after being hatched; however, at this season the weather is not always so charming, and I may mention that we had a brood that came out a few years ago during a time when the ground was thickly covered with snow. The snow remained on the ground a fortnight, during which time it was essential to keep the goslings in the house. Grass being an indispensable part of the food of goslings, we were necessitated to procure for them pieces of turf. For the first few days goslings should have porridge, potatoes boiled, and given when moderately warm, bread-crumbs, or curds; and should not have liberty to swim in water; this restriction should be gradually dispensed with. When seven or eight days old no further care is necessary (unless in bad weather), beyond giving them food.

“I cannot agree with those who say that ‘the rankest, coarsest grasses constitute the goose’s delicacy.’ Turn geese into a pasture of various qualities of grass, and they will soon show to which they give preference. I am not assuming, but write from having observed that they are fondest of the sweetest grasses. I have also observed them ‘wagging’ through long grass, and drawing the heads of the grass through their bills, in order to procure the seed. The manner they turn their heads to one side to do this is very amusing. How coarse soever grass may be, geese will eat it, but to keep them well they must have an allowance once a day of something more substantial. A mixture of boiled potatoes will answer the purpose; but by comparing the prices of these with the prices of oats, and by taking the nutritious properties of both into consideration, we shall find that the latter are, at present prices (1850), considerably cheaper.

“It is the custom in some parts to take a portion of the feathers off the geese two or three times a year—a custom I strongly condemn: for, no later than last year, a party of whom I purchased a flock took advantage before delivering them of robbing them of a great part of their feathers; the consequence of which was the loss of the most of them. I admit a small quantity may be taken off with little or no injury; but then so few people can be trusted to do the work, that it is undoubtedly the best policy to let the feathers hang as they grow.”

We may supplement this judicious advice by the following, which Mr. Austin Williams, of Reading, formerly a very successful exhibitor of geese, has forwarded to us on their incubation, and on the management of the goslings:—"The period of incubation," writes Mr. Williams, "is about thirty days; but should the goose not sit close, it may extend one or two days over that period. I have generally found geese leave their home when sitting once a day, until within a day or so of hatching, when they are seldom disposed to quit their charge. At such times they should always be fed. It is certainly desirable that the sitting goose should have easy access to water, for a bath not only keeps her in health, but materially assists the process of hatching. For the last few days, I make a rule of placing food and water by the side of the old bird.

"As soon as the goslings become dry after hatching, I give them each a pellet of barley-meal, with milk to drink, since I think that they are thus strengthened. I then place the old goose with her goslings under a coop on a grass plat, the latter having sufficient room to pass between the bars, and pick the herbage, a privilege which they almost immediately avail themselves of. Barley-meal mixed to a crumbling consistency with water, and bruised oats, form their food until they gain strength, when the oats are given whole. My reason for giving them soft food is, that the gosling derives greater benefit from its being more easy of digestion. Some of my largest white goslings, hatched in the spring, will weigh in August from 13lbs. to 16lbs. each."

In one point, geese differ widely from any other species of domesticated poultry, namely, in their extreme longevity. On this subject Mr. Hewitt writes:--

"Perhaps there is scarcely any description of poultry that can boast of the extraordinary age of the goose, combined with continued productiveness. In poultry-breeding, we continually find, in other instances, that age brings with it decreased powers of production, and, at length, such birds cease breeding altogether. I could mention several instances of geese attaining twenty, or five-and-twenty years of age, and still, year by year, both laying and sitting as abundantly and as early as in former seasons. This remark, however, applies especially to birds which have during the whole period enjoyed free and unlimited range. I am aware of the existence of an old goose that has attained an age of nearly forty years, and that has never failed during that period to raise one or two good broods annually. She does not show any apparent mark of extreme old age, grazing freely as heretofore, and being very attentive to her offspring.

"Ganders, on the other hand, as far as my knowledge extends, never maintain their productiveness; and, generally speaking, they become, at the age of a few years only, perfect pests to all the weaker inhabitants of the farm, are easily irritated, especially if they have been teased, and really dangerous to young children, from the extreme violence and unexpected nature of their attacks. For these reasons, they are very rarely retained sufficiently long to prove the length of time they would continue of utility to their owners; but I am informed by

many of my country acquaintances, it is not by any means advisable to retain them for many seasons, as the offspring prove less hardy and far more degenerate, than where the old gander has been exchanged for a younger bird. My convictions tend therefore to the belief that aged geese are undoubtedly the best mothers, sitting more closely; and that afterwards they tend their goslings more efficiently than the younger and less experienced of their species; and, as a general rule also, the goslings when hatched are finer than those produced from the one-year old female, and also, whilst growing, feather with greater rapidity."

CHAPTER XXX.

THE DISEASES OF POULTRY.

BY THE EDITOR.

IN a work like the present, not intended for the professional reader, it will be found more convenient for the purpose of reference, to arrange the diseases of poultry under the headings of the organs that are affected, than in any more strictly scientific order. In accordance, therefore, with this plan, they will be treated of in the following sections:—

1. Diseases of the Brain and Nervous System; 2. Diseases of the Digestive Organs; 3. Diseases of the Lungs and Air Passages; 4. Diseases of the Egg Organs; 5. Diseases of the Limbs; 6. Diseases of the Skin; 7. Fractures of the Bones.

DISEASES OF THE BRAIN AND NERVOUS SYSTEM.

APOPLEXY.

Symptoms.—The symptoms of apoplexy are plain and decisive,—a fowl, apparently in the most robust health, falls down suddenly, and is found either dead or without sensation, or the power of motion. These symptoms are occasioned by the rupture of a vessel of the brain, and the consequent effusion of blood, which, by its pressure, produces the evil.

Causes.—Apoplexy is almost invariably caused by a full habit of body; it is therefore frequent in overfed birds, and is most common among laying hens, which are sometimes found dead on the nest,—the expulsive efforts required in laying being the immediate cause of the attack. Unnatural and over-stimulating food, as greaves, hemp, and a large proportion of pea or bean meal, greatly predisposes to the disease.

Treatment.—In this disease much may be done in the way of prevention,—little towards cure in an actual attack; the only hope consists in an instant and copious bleeding by opening a vein with a sharp-pointed penknife, or, still better, a lancet. The largest of the veins seen on the under side of the wing should be selected, and opened in a longitudinal direction, not cut across; and so long as the thumb is pressed on the vein, at any point between the opening and the body, the blood will be found to flow freely. If the bird recovers, it should be kept quiet, and fed on light food for some time after the operation.

VERTIGO.

Symptoms.—Fowls affected with this disease may be observed to run round in a circle, or to flutter about with but partial control over their muscular actions.

Causes.—The affection is one evidently caused by an undue determination of blood to the head, and is dependent on a full-blooded state of the system, usually the result of over-feeding.

Treatment.—I have always found that holding the head under a stream of cold water for a short time immediately arrests the disease; and a dose of any aperient, such as calomel, jalap, or castor oil, removes the tendency to the complaint.

PARALYSIS.

Symptoms.—An inability to move some of the limbs. In fowls, the legs usually are affected, and are totally destitute of the power of motion. Care must be taken not to confound this disease with leg-weakness, which will be described under the head of Diseases of the Limbs, and which requires a totally different mode of treatment.

Causes.—Paralysis usually depends on some affection of the spinal cord, and is another result of over-stimulating diet.

Treatment.—Nothing can be done by way of cure; the cases may be regarded as hopeless, or nearly so.

DISEASES OF THE DIGESTIVE ORGANS.

CROP-BOUND.

Symptoms.—The crop or membranous dilatation of the gullet, whose office it is to receive the food as it is swallowed, and to retain it until sufficiently softened by maceration, is sometimes so overcharged, that it is unable to expel its contents into the stomach. From the emptiness of the latter organ the bird feels hungry, and by continuing to eat adds to the mischief, until at last, by the contraction of the crop and the swelling of the grain, a hardened mass is formed, weighing in some cases nearly a pound, and, by the enormous protuberance it causes, giving evident indications of its presence. Sometimes the disease is occasioned by a single object being swallowed, whose size is too large to permit it to pass into the stomach. In this case it serves as a nucleus for other matters, and a mass is formed around it. I have now lying before me a piece of bone, one and a half inch long by three-quarters of an inch broad, which was embedded in a mass of horse-hair, oat-husk, and other vegetable fibres, the whole forming an egg-shaped solid, two and a half inches in the long, and one and a quarter inch in the short, diameter. This caused the death of the Dorking in whose crop it was found.

Treatment.—The treatment of this disorder is very simple. With a sharp pen-knife an incision must be made through the skin and upper part of the crop; the hardened mass loosened by some blunt-pointed instrument, and removed. If it has

remained many days, and is very offensive, the crop may then be washed out by pouring in some warm water. The incision, if small, may be left; but if large, a stitch or two is advisable. The bird should be fed on soft food for a day or two, and will rapidly recover.

INFLAMMATION OF THE FORE STOMACH, OR PROVENTRICULUS.

Symptoms.—When a fowl mopes and refuses to eat, without any apparent cause, or selects only soft food, rejecting corn or grain, and, gradually pining, becomes excessively thin, inflammation of the fore stomach may be suspected.

Causes.—Over-stimulating food, such as an excess of animal diet, greaves, spiced poultry meal, &c., necessarily make a greater call upon the digestive organs than more simple and wholesome diet. The stomach (or proventriculus of comparative anatomists), which is situated between the crop and the gizzard, secretes the gastric juice, in which the food is macerated previous to its passing on into the latter organ, to be ground by the triturating action of its powerful muscles. The amount of gastric juice must therefore be in proportion to the digestibility of the food; and hence, under the use of unnatural food, the organ is overworked, and stimulated to such an extent as to become inflamed. The secretion of gastric juice then ceases; the food is not digested, and consequently distends the stomach to an enormous degree; so that, although not naturally larger than half the finger, I have seen it four or five times the size of the gizzard.

Treatment.—The prevention of this disease, by the use of wholesome and natural diet, is easy: the cure in advanced cases very uncertain. The only treatment to be relied on would be the immediate employment of a plain dietary, consisting of cooked soft food, so as to make the least possible call on the digestive organs; and if to this regimen an occasional grain of calomel, at intervals of several days, be added, all is done that can be likely to benefit the patient.

DIARRHŒA.

Symptoms.—The symptoms of diarrhœa, or looseness, are so evident as to render description unnecessary.

Causes.—A too scanty supply of grain, which necessitates an excess of green food, or an unwholesome dietary of any description, are the usual causes of this complaint.

Treatment.—The treatment is simple: five grains of powdered chalk, the same quantity of rhubarb, and three of cayenne pepper, may be administered; and if the relaxation is not speedily checked, a grain of opium, and one of powdered ipecacuanha, may be given every four or six hours.

DISEASES OF THE LUNGS AND AIR-PASSAGES.

CATARRH.

Symptoms.—The symptoms of a cold, or catarrh, in fowls, are identical with those so familiar in the human subject—namely, a watery or adhesive

discharge from the nostrils, and a slight swelling of the eyelids; in worse cases the face is swollen at the sides, and the disease appears to pass on into true roup.

Causes.—The cause is exposure to cold and dampness, such as a long continuance of cold wet weather, or sleeping in roosting-places open to the north or east.

Treatment.—In simple cases, removal to a dry warm situation, and a supply of food rather more nutritious and stimulating than usual, soon effect a cure. I have found a little mashed boiled potato, well dusted with common pepper, very advantageous. In severe cases, the disease so closely resembles roup, that it may be treated in the same manner.

BRONCHITIS.

Symptoms.—If the cold, to use a popular mode of expression, settles on the lungs, instead of affecting the head, the symptoms are somewhat different; there is rattling in the throat, from the accumulation of mucus, which the fowl coughs up and expectorates at intervals.

Treatment.—Removal to a drier habitation is sufficient in almost all cases to effect a cure.

ROUP.

Symptoms.—The symptoms of roup are at first identical with those of a severe catarrh; the discharge from the nostril, however, soon loses its transparent character, becoming more or less opaque, and of a very peculiar and offensive odour; froth appears in the inner corner of the eye; the lids swell; and in severe cases the eye-ball is entirely concealed; the nostrils are closed by the discharge drying around them, and the eyelids are agglutinated together; the diseased secretion accumulates within to a great extent, consequently the sides of the face swell to an extreme degree, and the bird, unable to see or feed itself, suffers from great depression, and sinks rapidly.

Roup is essentially a disease of the lining membrane of the nasal cavities. This being inflamed, becomes swollen, and secretes the discharge before mentioned. These two circumstances combined tend to close up the small external aperture of the nostrils: as fowls habitually breathe through the nose, the mouth being kept closed, it follows that there is even in the early stages some difficulty of breathing, and a distension of the loose skin below the under-jaw may be often noticed. The frothy matter appearing at the corner of the eye results from the same cause; the air, stopped in its passage through the nose, passes up the tear duct, leading from the eye to the nose, and produces the appearance of bubbles in the corner of the eye. In very severe cases the cavity of the nose becomes filled with the diseased secretion, which cannot escape, owing to the small size and closure of the nostril, and then the face swells considerably.

With respect to the communication of this disease, my experiments prove that

it is exceedingly contagious. It is, I am inclined to think, frequently communicated by fowls drinking out of the same vessel, as the discharge from the nostrils of the sick bird contaminates the water as it drinks.

Treatment.—Warm dry lodging, and stimulating nutritious food, are the first essentials to recovery; in addition, the frequent removal of the dried discharge from around the eyes and nose, by warm bathing, must not be omitted. In the way of internal medicine, I find that nearly equal numbers recover under various modes of treatment. I have tried the following remedies—namely, iodine in tincture, mercurial ointment, and nitrate of silver, all applied externally to the sides of the face, without any advantage. Internally I have given calomel, sulphur, citrate of iron, calomel and opium, cayenne pepper, and sulphate of copper, without any very well-marked or decided improvement. The direct application of some remedial agent to the diseased membrane, promises the best result; but here we are met by the difficulty as to the application, for the nostrils are closed up, and it is nearly impracticable to pass anything through them. A very small bent tube can, however, be readily passed into the cavity of the nose through the slit in the roof of the mouth; and I have tried the effect of injecting a few drops of a dilute solution (10 grains to the ounce of water) of sulphate of copper, with very favourable results. The injecting tube is readily passed into each nostril, if inserted into the anterior part of the slit seen in the roof of the mouth, and directed outwards at right angles to the slit.

In very severe chronic cases, when there has been much swelling of the face, I have opened the side of the face, and removed the diseased secretion in a solid form.

In general I should say, kill a roup fowl at once, unless it is valuable, as the risk of its contaminating the whole yard is great. At all events, let it be instantly removed from the run.

GAPES.

Symptoms and Causes.—The name is sufficiently expressive as to the symptoms of this disease, which is occasioned by the occurrence of a parasite (*Sclerostoma syngamus*) in the trachea or windpipe.

This disease is so important, as causing the destruction of a large number of chickens, pheasants, and other gallinaceous birds, that I have much pleasure in inserting the following abstract of a valuable communication made by Dr. Spencer Cobbold, to the Linnean Society, on its history and treatment. Dr. Cobbold writes:—

“ This parasite has been found and recorded as occurring in the trachea of the following birds, namely, the turkey, domestic cock, pheasant, partridge, common duck, lapwing, black stork, magpie, hooded crow, green woodpecker, starling, and swift. I do not doubt that this list might be very much extended if ornithologists would favour us with their experience in the matter. In view of adding something to our knowledge of its structure, and, more particularly, in the hope of directing

general attention to the mode of checking its ravages, I have ventured to make it the subject of a special communication.

“My attention was recently directed to a small, diseased, almost featherless chicken, which I at once recognized as suffering from the *gapes*. The bird belonged to a brood consisting of eleven individuals, all of which were between six and seven weeks old. The ten healthy birds had individually attained a considerable size, an average example weighing $9\frac{1}{2}$ ounces; but the infested chicken had only acquired a weight of 4 ounces, in consequence of the deteriorating influences of impeded respiration. The strange habits of the chicken were also in keeping with its physical peculiarities. It held itself entirely aloof from the other members of the brood; and, as if to make up for its defective assimilating powers, tried to add to its substance by greedily devouring everything which came in its way, thus consuming fully two or three times as much as any other member of the brood. The only interruption to its constant eating during the day arose from the act of gaping, which took place at irregular intervals, sometimes as often as once every minute. The extension of the neck, and consequent elongation of the trachea, seems to have the effect of separating or unfolding the knot of enclosed parasites—sufficiently, at least, to allow of a certain degree of expiration and inspiration.

“Having obtained possession of the fowl, I operated upon it in the following manner: A very small portion of carded wool having been dipped in chloroform and placed in front of the bird's nostrils, it was soon rendered perfectly insensible. The skin of the neck was then divided, and the trachea slit up to the extent of about a quarter of an inch; and, introducing one prong of a pair of common dissecting forceps, I removed seven *Sclerostomata*. Six of these parasites were united in pairs, the odd worm being a female from which the mate had in all likelihood been rudely torn during the withdrawal of the forceps; and, if so, it escaped my observation. After I had closed the external wound in the skin with a single thread, the bird was permitted to wake out of its artificial sleep; and, notwithstanding that it had parted with a drop or two of blood, it soon recovered its legs, and ran about the table as vigorously as ever. Moreover, as if this were not enough to satisfy me as to its almost instantaneous cure, in a very few minutes afterwards it demolished the contents of a saucer partly filled with bread previously steeped in milk. An occasional gape was caused by an accumulation of frothy mucus within the injured trachea; but this obstruction the bird soon got rid of by a few shakes of the head, attended with sneezing. The only subsequent inconvenience to the bird arose from emphysematous distention of the cellular tissue of the head and neck. This was on two or three occasions relieved by a slight puncture of the extremely thin integument, the emphysema ceasing to form after the external wound had healed. This chicken was well fed, and rapidly attained the size of an ordinary full-grown pullet. I have since caused it to be killed; and on dissecting the neck, although there was no scar externally, a distinct cicatrix indicates the site of the operation on the trachea—the divided

cartilaginous rings, six in number, being united only by a thin layer of connective tissue.

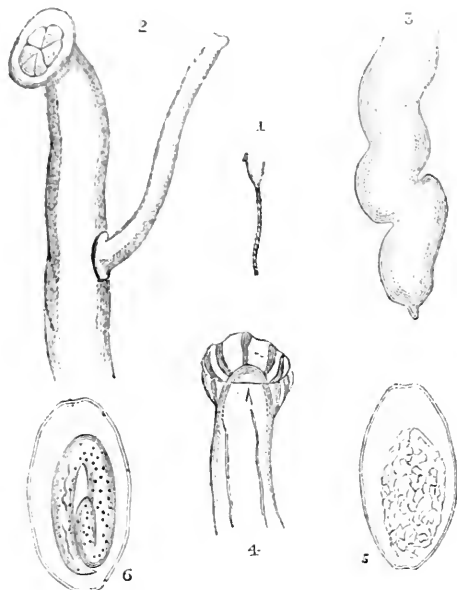

EXPLANATION OF WOOD-CUT.

Fig. 1. *Sclerostoma syngamus*, male and female. Natural size.
 Fig. 2. Upper part of the same, showing more especially the six-lobed circular lip of the female, and the mode of union. Enlarged.
 Fig. 3. Lower end of the body of the female, with its mucronate caudal appendage. Enlarged.

Fig. 4. Lower end of the body of the male, showing the cup-shaped bursa, hard rays, lateral muscles, digestive tube, and round tail. Magnified 30 diameters.
 Fig. 5. Mature egg. Magnified 220 diameters.
 Fig. 6. Egg, with contained embryo. Magnified 220 diameters.

“ Reverting now to the worms extracted from the trachea, I observe, in the first place, that the females have an average length of $\frac{2}{3}$ ths of an inch, the males scarcely exceeding $\frac{1}{3}$ th of an inch. In both sexes the bodies are tolerably uniform in breadth throughout; and that of the female measures 1-35th, whilst the transverse diameter of the male is only from 1-60th to 1-50th of an inch. The heads are relatively even more disproportionate. In the fresh state the mouth of the female was seen to be furnished with six prominent chitinous lips (fig. 2).

“ In both sexes the surface of the body is quite smooth, but the female displays a series of spirally-arranged lines, which at first sight convey the idea of a natural twisting of the body; this, however, is more apparent than real, being likewise more marked in some individuals than in others. The body of the female, towards the tail, exhibits a decided tendency to fold upon itself; and in one example this feature was very significant (fig. 3). The lower part of the body preserves a tolerably uniform thickness almost to the extremity, where it is suddenly constricted to form a short narrow mucronate pointed tail, scarcely visible to the naked eye. Employing a pocket-lens, it is easy to observe through the transparent integument the spacious digestive canal, surrounded on all sides by sinuous

foldings of the ovarium, tuba, and uterus—the vagina terminating laterally at a point corresponding with the line of the upper fourth of the body. Here the male is usually found rigidly affixed by means of a strong membranous sucker, which proceeds from the lower end of its body. This cup-shaped appendage is formed out of a folded extension of the skin which thus envelopes the centrally enclosed and rounded tail (fig. 4). The eggs of *Sclerostoma syngamus* are comparatively large, measuring, longitudinally, as much as the 1-250th of an inch (fig. 5). Many of the ova contain fully-formed embryos; and in the centre of the lower third of the body of one of them I distinctly perceived an undulating canal, probably constituting the as yet imperfectly formed intestinal tube. By whatever mode the young make their *exit* from the shell, it is manifest that prior to their expulsion they are sufficiently developed to undertake an active migration. Their next habitation may occur within the body of certain insect larvæ or even small land mollusks; but I think it more likely that they either enter the substance of vegetable matters or bury themselves in the soil at a short distance from the surface.”

Treatment.—The plan formerly adopted, of giving remedies internally to remove the worms, is not a good one, as the medicine has to be absorbed, pass into the blood, and act powerfully upon the body of the fowl before its purpose can be accomplished: its direct application to the worms is therefore preferable. This is readily secured by stripping the vane from a small quill feather, except half an inch at its extremity; this should then be dipped in spirits of turpentine; and the chicken being securely held by an assistant, the feather so prepared is passed neatly down through the small opening of the windpipe, which is readily seen at the base of the tongue.

The turpentine at once kills the parasites, and its application excites a fit of coughing, during which they are expelled: this mode of application requires some manual dexterity, and at times the irritation proves fatal. I have therefore suggested the shutting up of the chicken in a box, with some shavings dipped in spirits of turpentine, when the vapour arising from the extended surface produces in most cases an equally beneficial result.

In very urgent cases, the opening of the windpipe, as adopted by Dr. Cobbold, may be advantageously had recourse to; but this method is evidently only necessary when the disease has so far advanced that immediate suffocation becomes inevitable; or it may be resorted to when other methods have failed. In the most far-gone cases, instant relief will follow this operation, since the trachea may with certainty be cleared of all obstructions.

As Dr. Cobbold observes, the most essential thing in view of putting a check upon the future prevalence of the disease, is *the total destruction of the parasites after their removal*. If the worms be merely killed and thrown away (say upon the ground), it is scarcely likely that the mature eggs will have sustained any injury. Decomposition having set in, the young embryos will sooner or later

escape, migrate in the soil or elsewhere, and ultimately find their way into the air-passages of certain birds in the same manner as their parents did before them.

The worms, after removal, ought to be burnt, and the dead bodies of any chickens, young partridges, or other birds infested with these parasites, should be treated in the same manner, if we wish to prevent the spread of the disease.

PIP.

Symptoms.—The occurrence of a dry horny scale upon the tongue is generally regarded as characteristic of this disease, which, however, is by some confounded with gapes. The dry scaly tongue is, however, only a symptom caused by some other disease, which forces the fowl (which habitually breathes through the nostrils) to respire through the mouth; in this case the constant current of air dries the tongue, which becomes hard at the point, and assumes a very horny character. Thus, in any inflammatory affection of the windpipe, in gapes, catarrh, or roup, when the nostrils are closed by the discharge, the pip, as it is termed, makes its appearance. It should be regarded, however, as a symptom only, and not as the disease itself.

Treatment.—The treatment varies with the cause; if the scale of hardened membrane is loose, it should be removed. The absurd plan of nipping off the end of the tongue in chickens is still practised in some parts of the country: it is almost needless to say that it is alike useless and barbarous.

CONSUMPTION.

Symptoms.—Consumption, which is caused by the presence of scrofulous tubercles in the lungs, may almost always be induced in chickens by confining them in cold dark unhealthy places: I have also found tubercles in the liver and other organs of the body. The symptoms of consumption are not strongly marked in the early stages; in the more advanced state there is wasting, cough, and expectoration of matter.

Treatment.—It is fortunate that consumption can always be prevented by wholesome, abundant diet, and good housing, for in advanced stages it is quite incurable; where it is suspected to be commencing, cod-liver oil may be given, mixed with barley-meal; but as the disease is hereditary, a fowl so preserved would be worse than useless as a stock bird.

DISEASES OF THE EGG ORGANS.

The egg organs in the fowl consist of the ovary, situated on the fore part of the left kidney, and the oviduct, or egg-passage, leading from it to the outlet. The ovary in its inactive state consists of minute vesicles, the germs of future eggs. In its active condition these enlarge in regular succession, until each has attained the size of the natural yolk, when it is seized by the open funnel-shaped extremity

of the egg-passage, and as it passes along has successively secreted around it the white, with its twisted cords, which serve to maintain the yolk in a proper position in the shell; the membranes lining the shell; and, lastly, the shell itself; the white being necessarily formed at the upper part, the membrane at the middle section, and the shell at the lower part of the oviduct or egg-passage.

The ovary is not often subject to disease, except in old hens past laying, in which it sometimes degenerates; and it not unfrequently happens that the hen so affected is healthy in all other respects, and is only known to be diseased by her not laying, and frequent crowing: sometimes, as in the case of barren hen pheasants, she assumes the plumage of the male bird.

INFLAMMATION AND PROTRUSION OF THE EGG-PASSAGE.—SOFT EGGS.

Symptoms.—The symptoms of this complaint vary with the part of the oviduct affected. As the disorder occurs in laying hens, we are enabled to trace the seat of the complaint by the state of the extruded egg. If the lower part is unduly excited, the egg is expelled before the shell has been secreted, and a soft-skinned egg results. If the inflammation extends to the middle portion, the membrane is either misshapen or incomplete; and if the whole tube is inflamed, the yolks are dropped without any covering whatever.

The laying of soft eggs arises from several causes; and if all cases are treated alike, such an empirical method will certainly not be followed by success. The shell of the egg consists almost entirely of carbonate of lime, the same material which, in a different form, produces chalk, marble, limestone, and the shells of such animals as oysters, &c. The requisite quantity required for the formation of the eggshell must be obtained in or with the food, otherwise soft eggs result. When unshelled eggs arise from a deficiency of calcareous matter, the remedy is evident; a quantity of old mortarr ubbish, or oyster-shells heated to redness and then broken up, readily supply the material required.

Another cause of soft eggs is the excitement of the fowl from being driven about, or being worried in any manner. Heavy fowls, such as Creve Cœurs or Dorkings, &c., that are not so active as the smaller varieties of poultry, suffer much from being driven, frequently laying soft eggs afterwards. The remedy in this case is sufficiently simple, being merely rest.

Inflammation of the oviduct, or egg-passage, is a third cause, and in this case the eggs produced are usually irregular in form, or very imperfect. When the inflammation is very severe, the yolks may be expelled, as they are received from the ovary, without any white or membrane; at other times the white may be expelled with the yolks, or the eggs may be imperfectly or irregularly enclosed in membrane. The treatment of inflammation of the egg-passage is sufficiently simple. The object is to lower the inflammatory action; and this is best done by the use of a remedy which I proposed some years since, namely, one grain of calomel and one-twelfth of a grain of tartar emetic, given in barley-meal.

After its administration the hen generally ceases to lay for two or three days, and then resumes in a healthy manner; but if necessary, a second dose may be given.

It is almost needless to say that inflammation of the egg-passage is shown by general feverishness; the feathers (especially those over the back) are puffed out, and the hen mopes about, and strains to discharge the contents of the passage. I believe this inflammation to be often produced by over-stimulating or unwholesome food. I once gave my Dorkings some greaves, and the result was that every one laid soft eggs; and the disorder ceased, without the use of medicine, on a return to natural food.

Protrusion of the lower end of the egg-passage not unfrequently occurs in hens that are laying. It is sometimes caused by a disparity of size between the egg and the passage, and at other times seems connected with a general relaxation of the system. When protrusion occurs, the plan recommended is immediately to check the laying by the medicine above mentioned, and put the bird on a diet which contains no egg-forming materials, such as rice and potatoes; and after a few days the parts usually regain their natural position. If, however, another egg is formed, it usually happens that the efforts to expel it so much increase the mischief that the bird dies.

The disease is not unfrequently the precursor of apoplexy; if a soft egg, as frequently happens, is broken in the passage, the collapsed membrane, from its irregular form, is not readily expelled, and the efforts to get rid of it lead to the rupture of a vessel in the brain; at other times, the canal being closed, additional yolks accumulate above, causing a tumour, which is eventually fatal, and which is rapidly enlarged by the continued secretion of the oviduct. I have seen tumours upwards of a pound in weight produced in this manner.

DISEASES OF THE LIMBS.

LEG-WEAKNESS.

Symptoms.—This disease usually occurs in young birds, and more frequently in cockerels than pullets. The bird affected is, more or less, unable to support itself, and sinks down on the hocks after standing for a short time, or in bad cases is even unable to rise on the feet. In other respects the health is good, the appetite being at first, before the bird is injured by want of exercise, very good, and the comb red.

Causes.—The cause of this troublesome complaint, which frequently attacks the finest and heaviest birds, is, merely a rapid increase of weight, which is out of proportion to the muscular development; it consequently is often present in the weightiest birds, and in cockerels more frequently than in pullets; it is rarer in old birds, and is most common in the heaviest varieties, Cochins being more especially subject to it.

Constitutional weakness may, of course, produce it without any rapid growth.

Treatment.—Local applications are perfectly useless ; but the most rapid improvement follows from the administration of from three to eight grains of citrate of iron daily, and a due supply of nutritious food, care being taken to select such substances as are flesh-producing, and not fattening—wheat, barley, and a due supply of worms, or, in default, a little chopped meat, being preferable to rice or Indian corn.

RHEUMATISM AND CRAMP.

Symptoms.—These diseases, though differing in their nature, arise so constantly from the same cause, and are so readily removed by the same treatment, that I have placed them together. A disinclination and inability to move the limbs, evidently not arising from mere weakness, or a permanently cramped condition of the toes, are sufficiently characteristic.

Causes.—Both disorders are caused by exposure to cold and wet, and the tendency to them may be much counteracted by preventing the fowls, during their earliest chickenhood, from running among wet grass early in the morning.

Treatment.—Good food, and a warm dry habitation, are generally effectual. When chickens are hatched at such times as January and February, it must not be expected that any treatment can counteract perfectly the unnatural circumstances under which they are placed. If exposed, they suffer from cold ; and if confined in close rooms, the want of fresh air, natural green and insect food, produce unfortunate results.

Rheumatism is not unfrequently followed by inflammation of the heart, a disease which in the fowl is seldom suspected until so far advanced as to be necessarily fatal.

GOUT.

Symptoms.—Swelling of the feet, attended with a great degree of heat.

Treatment.—We have seen several cases of this disease in Cochins, and have been successful in some cases in removing it by employing calomel, one grain at night, and three drops of wine of colchicum twice a day, care being taken as to warmth, diet, &c.

BUMBLE FOOT.

Symptoms.—Dorkings are more especially subject to this disease. It commences by a small wart-like body on the ball of the foot. This enlarges, and at last ulcerates, producing so much mischief that the bird becomes lame and useless.

Causes.—The cause seems to be some slight injury from pressure on sharp stones ; this sets up a low inflammatory action on the thick skin of the foot, which is followed by the formation of the swelling. The disease does not originate in the tendons, nor even in the dense fascial covering, but in the cutis.

Treatment.—From the low state of vitality in the feet of birds, and the

inability to rest them when diseased, there is little hope of successful treatment in advanced cases. In early cases we have removed the corn-like tumours, and cauterized the part with nitrate of silver with success; but the adoption of low broad perches, which prevent the bird coming with violence to the ground on its descent, is the best remedy, inasmuch as prevention is in all cases better than cure.

DISEASES OF THE SKIN.

BALDNESS AND WHITE COMB.

Symptoms.—White comb is a hard and scurfy condition of that organ, to which the fowls kept in the confined stable-yards of large towns, and other unhealthy localities, or fed on bad food, are liable; in advanced cases the feathers fall off, leaving the head perfectly bare.

Causes.—Unnatural food, the want of fresh vegetables, and overcrowding in dark habitations, are the causes of these complaints.

Treatment.—A return to natural diet is indispensable to success; and if to this important requisite is added the administration of a five-grain Plummer's pill every other night for a week, immediate benefit will result. At the same time, it must be borne in mind, that the plumage will often not reappear until next moulting time.

LICE.

The symptoms and causes of these pests require no particular consideration. After trying many substances, we are convinced that the employment of flowers of brimstone, thoroughly dusted into the roots of the feathers, and spread over the entire skin, is, if used twice or thrice, at intervals of a few days, a certain remedy.

FRACTURES OF THE BONES.

Fractures of the bones of the body are less likely to occur in birds than in other animals, inasmuch as the framework is more completely united together, and is protected from injury by the feathers.

In cases where fracture of the ribs or other bones may be suspected, there would be great difficulty in determining the nature of the injury, and I do not think anything more could be done than keeping the bird quiet until recovery.

In cases of broken wings, the quill feathers would prevent any recourse being had to the ordinary method of bandaging. The plan I have pursued is, to tie, carefully, the ends of some of the quills together in their natural position, with the wing closed; this prevents motion of the broken ends of the bones; and by keeping the bird in an empty place, where there are no perches for it to attempt to fly upon, every chance of recovery is afforded.

Fracture of the fleshy part of the leg would be less manageable, and I can hardly recommend any bandaging that would be readily applied. The most common

fracture in fowls is that of the tarsus, or scaly part of the leg. This is usually treated by wrapping a slip of rag round the injured limb, and tying it with thread—a very imperfect plan, as motion of the broken bones is not prevented, and which is therefore frequently unsuccessful in its results. I always employ a modification of what is known to surgeons as a gum splint. The white of an egg is well beaten up with a fork, and spread upon a strip of thick, soft brown paper, as wide as can be smoothly wrapped around the broken limb. The fowl is held by an assistant, the leg slightly stretched, so as to bring the ends of the bones in a straight line, the moistened paper wrapped smoothly round several times, and secured by two or three turns of thread; and, lastly, to prevent the parts being moved before the paper has become dry and stiff, a thin splint of wood, such as is used for lighting pipes, bound with thread on each side: the wood may be removed the following day, as it then adds to the weight. The stiff paper forms a bandage which prevents all motion, and so places the limb in the best possible condition for union to take place.



APPENDIX.

THE

STANDARD OF EXCELLENCE IN EXHIBITION BIRDS.

Reprinted from the Original Work, by permission of "The Poultry Club,"
with the addition of French Breeds, &c.

THE points of excellence in the various breeds, as laid down by the compilers of "The Standard of Excellence," have been so generally agreed upon by the exhibitors and judges, that it has been thought most desirable to reproduce that work in the present volume. The Editor and Publisher of THE POULTRY BOOK have to acknowledge the great obligation they are under to the Members and Stewards of the Club for the permission which has been accorded to them. Whilst they are most happy to aid in extending a knowledge of this most useful compilation, they cannot but feel that the value of THE POULTRY BOOK to all exhibitors and breeders has been greatly enhanced by the republication of the "Standard" in its pages.

COCHINS.

GENERAL SHAPE.

THE COCK.

Comb—Single, fine, rather small, perfectly straight and upright, with well-defined serrations, and quite free from side-sprigs.
Beak—Curved, stout at the base and tapering to the point.
Head—Small for the size of the bird and carried rather forward.
Eye—Very bright and clear.
Deaf-ear—Large and pendent.
Wattles—Large, well rounded on the lower edge.
Neck—Hackle very full and abundant, the lower part reaching well on to the back, so as to produce a gradual slant from near the head to the middle of the back.
Back—Broad, with a gentle rise from the middle to the tail; saddle feathers very abundant.
Wings—Very small; the primaries doubled well under the secondaries, so as to be quite out of sight when the wing is closed.
Tail—Very small; the curved feathers numerous, broad, glossy, and soft; the whole tail forming a small hunch, carried rather horizontally than upright.
Breast—Deep, broad, and full.
Thighs—Very large and strong; plentifully covered with perfectly soft feathers, which on the lower part should be curved inward round the hock, so as nearly to hide the joint from view; Falcon or Vulture hocks, that is, those with hard, stiff feathers projecting in a straight line beyond the joint, are objectionable, but not a disqualification.
Fluff—Very abundant and soft, covering the hind parts, and standing out about the thighs.
Legs—Rather short; very thick and bony, wide apart, well feathered on the outside to the toes.
Toes—Straight and strong; the outer and middle toes being well feathered.
Carriage—Not so upright as other breeds, with a contented, intelligent appearance.

THE HEN.

Comb—Single, very small, fine, low in front, erect and perfectly straight; with small, well-defined serrations.
Beak—Small, curved, and tapering.
Head—Very small, neat, and taper.
Eye—Very bright and clear.
Deaf-ear—Rather large.
Wattles—Small, neatly rounded on the lower edge.
Neck—Short; carried forward, the lower part very full and broad; the feathers reaching well on to the back.
Back—Broad, with abundance of soft feathers rising from the middle of the back to the tail.
Wings—Very small; primaries doubled well under the secondaries, so as to be quite out of sight when the wing is closed; bow of the wings neatly covered by the breast feathers, and the points sunk well into the fluff.
Tail—Very short and small; carried horizontally, and almost hidden in soft feathers.
Breast—Broad and full; carried low.
Thighs—Large; abundantly covered with soft fluffy feathers; curving inward round the hock, so as to nearly hide the joint from view; Vulture or Falcon hocks are objectionable, but not a disqualification.
Fluff—Very soft and abundant, covering the hind parts and standing out about the thighs, giving the bird a very deep and broad appearance behind.
Legs—Short, thick, and bony; standing wide apart; and well feathered on the outside to the toes.
Toes—Strong and straight, the outer and middle toes well feathered.
Carriage—Low, with a contented intelligent appearance.

BUFF COCHINS.

COLOUR OF COCK.

Comb, Face, Deaf-ear, and Wattles—Brilliant red.
Head—Rich, clear buff.
Hackle, Back, Wings, and Saddle—Rich, deep, golden buff; the more uniform and even in colour the better; quite free from mealiness on the wing.

Breast, Thighs, and Fluff—Uniform clear, deep buff; as free from mottling or shading as possible.
Tail—Rich, dark chestnut, or bronzy chestnut mixed with black. Dark chestnut preferable.
Legs—Bright yellow; feathers clear, deep buff.

COLOUR OF HEN.

Comb, Face, Deaf-ear, and Wattles—Brilliant red.
Plumage—Uniform clear, deep buff throughout; the more uniformly clear and free from mottling or shading the better. A clear hackle preferred, but a slight marking at the end of the feathers of the neck not a disqualification.
Legs—Bright yellow, with feathers same colour as body feathers.

LEMON COCHINS.

COLOUR OF COCK.

Comb, Face, Deaf-ear, and Wattles—Brilliant red.
Head—Lemon, or light orange buff.
Hackle, Back, Wings, and Saddle—Rich, light orange buff; the more uniformly clear and even in colour the better, as free as possible from mealy tinge on the wings.
Breast, Thighs, and Fluff—Clear, uniform lemon buff.
Tail—Rich chestnut.
Legs—Bright yellow; feathers lemon buff.

COLOUR OF HEN.

Comb, Face, Deaf-ear, and Wattles—Brilliant red.
Plumage—Clear, lemon buff; uniform and even in colour throughout, and perfectly free from being mottled or shaded in any part.
Legs—Bright yellow, with feathers same colour as body feathers.

In Buff and Lemon Cochins the colours may be either as above, or intermingle betwixt the two; but the colours must be even and as free from mottling or shading as possible. The birds must also match in the pen.

SILVER BUFF COCHINS.

COLOUR OF COCK.

Comb, Face, Deaf-ear, and Wattles—Brilliant red.
Head—Light, silvery buff.
Hackle—Rich, gold colour.
Back, Shoulder Coverts, and Wings—Bright, silvery buff; the more even and uniform in colour the better.
Saddle—Rich, gold colour.
Breast, Thighs, and Fluff—Clear, light silvery buff.
Tail—Light chestnut; a slight mixture of white not very objectionable, though not desirable.
Legs—Bright yellow, with silvery buff feathers.

COLOUR OF HEN.

Comb, Face, Deaf-ear, and Wattles—Brilliant red.
Hackle—Rich, gold colour.
Remainder of the Plumage—Clear, light, silvery buff; the more even and uniform in colour the better.
Legs—Bright yellow, with feathers same colour as body feathers.

SILVER CINNAMON COCHINS.

COLOUR OF COCK.

Comb, Face, Deaf-ear, and Wattles—Brilliant red.
Head—Pale light cinnamon.
Hackle—Cinnamon, or rich bright cinnamon, slightly striped with white.
Back, Shoulders, and Wings—Pale buff, or rich bright cinnamon, mixed with white.
Saddle—Light cinnamon, or rich bright cinnamon, slightly striped with white.

Breast, Thighs, and Fluff—Pale buff.
Tail—Rich light cinnamon, or rich bright cinnamon, mixed with white.
Legs—Bright yellow, with feathers of a pale buff colour.

COLOUR OF HEN.

Comb, Face, Deaf-ear, and Wattles—Brilliant red.
Hackle—Rich deep cinnamon or chocolate.
Remainder of the Plumage—Pale buff; the more uniform and even in colour the better.
Legs—Bright yellow; feathers same colour as body feathers.

CINNAMON COCHINS.

COLOUR OF COCK.

Comb, Face, Deaf-ear, and Wattles—Brilliant red.
Head, Hackle, Back, Wings, and Saddle—Rich dark reddish cinnamon; the more uniform and even in colour the better.
Breast, Thighs, and Fluff—The colour of wetted cinnamon.
Tail—Rich bronzy black, the lesser coverts edged with very dark reddish cinnamon.
Legs—Bright yellow, with feathers colour of the breast feathers.

COLOUR OF HEN.

Comb, Face, Deaf-ear, and Wattles—Brilliant red.
Plumage—The colour of wetted cinnamon or deep chocolate throughout; the more uniform in colour and free from being mottled the better.
Legs—Bright yellow, with feathers same colour as body feathers.

Value of Points in Buff, Lemon, Silver Buff, Silver Cinnamon and Cinnamon Cochins.

Size	3
Colour	4
Head and Comb	1
Carriage of Wings	1
Legs	1
Fluff	1
General Symmetry	2
Condition	2
	<hr/>
	15

Disqualifications in Buff, Lemon, Silver Buff, Silver Cinnamon and Cinnamon Cochins.

Birds not matching in the pen, or with primary wing feathers, twisted or turned outside the wing, twisted combs, crooked backs, birds without feathers on the legs, or legs of any other colour than yellow.

GROUSE OR PARTRIDGE COCHINS.

COLOUR OF COCK.

Comb, Face, Deaf-ear, and Wattles—Rich brilliant red.
Head—Rich red.
Hackle—Rich bright red, with a rich black stripe down the middle of each feather.
Back and Shoulder Coverts—Rich dark red.
Wing Bow—Rich dark red.
 „ *Greater and Lesser Coverts*—Metallic greenish black, forming a wide bar across the wings.
 „ *Primary Quills*—Bay on outside web, dark on inside web.
 „ *Secondary Quills*—Rich bay on the outside web, black on the inner web, with a metallic black end to each feather.
Saddle—Rich bright red, with a black stripe down the middle of each feather.

Breast, Underpart of Body, and Thighs—Rich deep black.
Tail—Glossy black (white at the base of the feathers objectionable, but not a disqualification).
Legs—Dusky yellow, with black feathers.

GROUSE COCHINS.

COLOUR OF HEN.

Comb, Face, Deaf-ear, and Wattles—Brilliant red.
Head—Rich brown.
Neck—Rich reddish gold colour, with a broad black stripe down the middle of the feathers.
Remainder of the Plumage—Rich brown distinctly pencilled with darker brown; the pencilling reaching well up the front of the breast, and following the outline of the feathers.
Legs—Dusky yellow, with feathers same colour as body feathers.

PARTRIDGE COCHINS.

COLOUR OF HEN.

Comb, Face, Deaf-ear, and Wattles—Brilliant red.
Neck—Bright gold colour on the edge of the feathers, with a broad black stripe down the middle.
Remainder of the Plumage—Light brown distinctly pencilled with dark brown; the pencilling to reach well up the front of the breast. The shaft of the feathers on the back, shoulder coverts, bow of the wing, and sides, creamy white.
Legs—Dusky yellow, with brown feathers.

Points in Grouse and Partridge Cochins.

Size	3
Black Breast, Thighs, Fluff, and Leg feathers in the Cock	} 2
Breast of the Hen. Distinctly pencilled up the front	
Colour of the remaining plumage	2
Head and Comb	1
Carriage of Wings	1
Legs	1
Fluff	1
Symmetry	2
Condition	2
	—
	15
	—

Disqualifications in Grouse or Partridge Cochins.

Birds not matching in the pen—cocks with mottled breasts, hens with pale buff or clay breasts without pencilling, twisted combs, flight feathers turned outside the wing, crooked backs; absence of feathers on the legs.

WHITE COCHINS.

COLOUR OF COCK AND HEN.

Comb, Face, Deaf-ear, and Wattles—Brilliant red.
Plumage—Pure white throughout. The cock as free from yellow tinge as possible.
Legs—Bright yellow.

BLACK COCHINS.

COLOUR OF COCK AND HEN.

Comb, Face, Deaf-ear, and Wattles—Brilliant red.
Plumage—Perfectly black throughout. The cock as free from coppery red or brassy colour as possible.
Legs—Dark, with yellow tinge and black feathers.

Points in White or Black Cochins.

Size	3
Colour of Plumage—Purity of white in the whites, and richness of black in the blacks	4
Head and Comb	1
Carriage of Wings	1
Legs	1
Fluff	1
Symmetry	2
Condition	2
	—
	15
	—

Disqualifications in White or Black Cochins.

Twisted combs, crooked backs, flight feathers turned outside the wing. Birds not feathered on the legs, scales on the legs of the whites either green or willow.

BRAHMAS.

GENERAL SHAPE.

THE COCK.

Beak—Very strong, taper, and well curved.
Comb—Pea, small, low in front and firm on the head without falling over to either side, distinctly divided so as to have the appearance of three small combs joined together in the lower part and back, the largest in the middle, each part slightly and evenly serrated.
Head—Small and slender.
Eye—Prominent and bright.
Deaf-ear—Large and pendent.
Wattles—Small, well rounded on the lower edge.
Neck—Long, neatly curved, slender near the head, the juncture very distinct, hackle full and abundant, flowing well over the shoulders.
Breast—Very full, broad, and round; carried well forward.
Back—Short, broad, flat betwixt the shoulders, saddle feathers very abundant.
Wings—Small; the primaries doubled well under the secondaries, the points covered by the saddle feathers.
Tail—Small; carried very upright, the higher feathers spreading out laterally.
Tail Coverts—Broad, very abundant, soft, and curved over the tail.
Thighs—Very large and strong; abundantly covered with very soft fluffy feathers, curving inward round the hock so as to hide the joint from view. Vulture hocks are objectionable, but not a disqualification.
Fluff—Very abundant and soft, covering the hind parts, and standing out about the thighs, giving the bird a very broad and deep appearance behind.
Legs—Rather short, strong, and bony: standing well apart, very abundantly feathered down the outside to the end of the toes.
Toes—Straight and strong; the outer and middle toe being abundantly feathered.
Carriage—Very upright and strutting.

THE HEN.

Beak—Strong, curved, and taper.
Comb—Pea, very small and low, placed in front of the head, and having the appearance of three very small serrated combs pressed together, the largest in the middle.
Head—Small and slender.
Eye—Prominent and bright.
Deaf-ear—Large and pendent.
Wattles—Small, rounded on the lower edge.
Neck—Rather short, neatly curved, slender near the head, the juncture very distinct, full and broad in

the lower part; the feathers reaching well on to the shoulders.

Breast—Very deep, round, broad, and prominent.

Back—Broad and short; the feathers of the neck reaching to betwixt the shoulders, and abundance of soft, broad feathers rising to the tail.

Wings—Small; the low covered by the breast feathers, the primaries doubled well under the secondaries, the points of the wings clipped well into the abundance of soft feathers and fluff.

Tail—Small; very upright, almost buried in the soft ramp feathers.

Thighs—Strong and well covered with very soft feathers, curving round the hock so as to hide the joint from view; Vulture hocks are objectionable, but not a disqualification.

Fluff—Very abundant and soft, standing out about the hind part and thighs, giving the bird a very broad and deep appearance behind.

Legs—Short, very strong, wide apart, abundantly feathered on the outside to the toes.

Toes—Straight and strong, the outer and middle toe being well feathered.

Carriage—Low in comparison to the cock.

PENCILLED BRAHMAS.

COLOUR OF COCK.

Comb, Face, Deaf-ear, and Wattles—Bright red.

Head—White.

Neck, Hackle—Silvery white, striped with black.

Breast, Underpart of Body and Thighs—Black, slightly mottled with white.

Back and Shoulder Coverts—Silvery white.

Saddle—Silvery white, striped with black.

Wing Bow—Silvery white.

„ *Greater and Lesser Wing Coverts*—Metallic green black, forming a wide well-defined bar across the wing.

„ *Secondaries*—White on the outside web, black on the inside web, large green black spot on the end of the feather.

„ *Primaries*—Narrow edging of white on the outside web, black on the inside web.

Tail—Black.

Tail Coverts—Rich green black, lesser coverts edged with white.

Legs—Scales yellow, feathers black, mottled with white.

COLOUR OF HEN.

Comb, Face, Deaf-ear, and Wattles—Rich bright red.

Head—Grey.

Neck—Silvery white, striped with black.

Remainder of the Plumage—Dull white, minutely and distinctly pencilled throughout with dark pencilling, so close as almost to cover the ground colour, the pencilling reaching well up the front of the breast.

Legs—Scales yellow, with a dusky shade.

LIGHT BRAHMAS.

COLOUR OF COCK.

Comb, Face, Deaf-ear, and Wattles—Rich bright red.

Head—White.

Neck—White, with a distinct black stripe down the centre of the feather.

Breast, Underpart of Body, and Thighs—White.

Back and Shoulder Coverts—White.

Saddle—White, striped with black.

Wing Bow and Coverts—White.

„ *Primaries*—black.

„ *Secondaries*—White on outside web, black on inside web.

Tail—Black.

Tail Coverts—Glossy green black; lesser coverts silvered on the edge.

Legs—Scales bright yellow; feathers white, slightly mottled with black.

COLOUR OF HEN.

Comb, Face, Deaf-ear, and Wattles—Bright red.

Head—White.

Neck—White, distinctly striped down the middle of each feather with rich black.

Breast and Back—White.

Wing—White, the primaries alone being black.

Tail—Black, the two highest or deck-feathers edged with white.

Thighs and Fluff—White.

Legs—Bright rich yellow; feathers white, slightly mottled with black.

Points in Brahmans.

Size	3
Colour	4
Head and Comb	1
Wings. Primaries well tucked under secondaries	1
Legs, and featherings of ditto	1
Fluff	1
Symmetry	2
Condition	2
	5

Disqualifications.

Birds not matching in the pen, combs not uniform in the pen, or falling over to one side, crooked backs, legs not feathered to the toes, or of any other colour except yellow, or dusky yellow.

MALAYS.

GENERAL SHAPE.

THE COCK.

Beak—Very strong and curved.

Comb—Small, placed quite in front of the head, low and flat, covered over with very small warty indentations.

Head—Long, flat on the top, projecting over the eyes.

Eye—Bright, sunk beneath a projecting eyebrow, the eyelids pearly round the edge.

Face—Very naked and skinny, with a harsh cruel expression.

Wattles—Very small, mere folds of the naked skin of the throat.

Throat—Very skinny, and quite destitute of feathers.

Neck—Very long, slightly curved, rapidly slanting from the head; the hackle very hard, short, and scanty, particularly in the lower part.

Back—Very long, slightly curved, and rapidly slanting from the shoulders to the tail, the shoulder coverts and saddle feathers very short and hard.

Body—Long and round, the feathers on the lower part very short, giving the bird a cut-out appearance.

Wings—Very strong, projecting out prominently from the body even when closed.

Breast—Very deep.

Tail—Small, drooping, sickle and tail coverts slightly curved. (The neck, back, and tail forming three slight nearly equal curves.)

Thighs—Very long, round, strong and upright, the feathers very hard, short, and close, the hock joint being bare.

Legs—Very long, strong, round, straight and clean, perfectly free from feathers.

Toes—Very long, straight, strong, and powerful.

Plumage—Very hard, short, close and glossy.

Carriage—Very upright, and tall.

THE HEN.

Beak—Very strong and curved.
Comb—Very small, low, and flat, placed on the front of the head, covered over with small warty indentions.
Head—Long, very snaky, and flat on the top.
Eye—Bright, sunk beneath a projecting eyebrow, eyelids pearly round the edge.
Face—Very naked and skinny, with a cruel expression.
Wattles—Mere folds of the naked skin and throat.
Throat—Quite naked and very skinny.
Neck—Very long, rapidly slanting from the head; neck feathers very hard, short, and close, particularly in the lower part.
Back—Long, rapidly slanting to the tail, shoulder coverts very short.
Body—Long and round, narrow at the insertion of the tail.
Breast—Very deep.
Wings—Very strong, projecting very prominently from the body when closed.
Tail—Small, and carried upright.
Thighs—Very long, strong, and upright; feathers very close and short, the hock joint being nearly naked.
Legs—Very long, clean, straight, round and strong.
Toes—Long, powerful, straight, and strong.
Plumage—Very short, hard, close and glossy.
Carriage—Very upright.

COLOUR OF MALAY COCK.

Beak—Yellow.
Comb, Face, and naked skin of the Throat—Rich bright red.
Eyes—Bright fiery red.
Head and Neck—Rich glossy dark red.
Back and Shoulder Coverts—Glossy reddish maroon.
Breast—Black, slightly mottled with reddish brown.
Wing Bow—Glossy reddish maroon.
 „ *Coverts*—Rich metallic greenish or bluish black, forming a wide bar across the wing.
Wing Nights—Rich dark red.
Saddle—Rich glossy dark red.
Tail—Rich green black.
Thighs—Rich black, slightly mottled with reddish brown.
Legs—Bright rich yellow.

COLOUR OF MALAY HEN.

Beak—Yellow.
Comb, Face, and Throat—Bright red.
Eyes—Bright fiery red.
Head—Reddish brown.
Neck—Rich glossy reddish brown.
Back and Shoulder Coverts—Rich glossy reddish brown or cinnamon.
Breast and Thighs—Reddish brown or cinnamon.
Wings—Rich glossy reddish brown or cinnamon.
Tail—Rich dark reddish brown.
Legs—Bright rich yellow.

WHITE MALAYS.

Comb, Face, and naked skin on the Throat—Bright red.
Beak—Bright rich yellow.
Plumage—Pure white throughout.
Legs—Bright rich yellow, yellowish willow permissible.

Points in Malays.

Height	3
Shortness, hardness, and closeness of plumage	3
Head	1
Colour	3
Symmetry	3
Condition	2
	—
	15
	—

Disqualifications in Malays.

Birds not matching in the pen; in the dark birds legs of any other colour except yellow.

DORKINGS.

GENERAL SHAPE.

THE COCK.

Beak—Rather short and stout.
Comb—Either single or rose; if single, erect, straight, serrated, free from side-sprigs; if rose-combed, square in front, straight on the head, without hollow in the middle, large peak behind, inclining very slightly upwards.
Head—Neat.
Wattles—Broad, stout, rounded on the lower edge.
Neck—Very taper and well hackled.
Breast—Very deep, broad and full. Breast-bone long.
Body—Large, deep, compact, and plump, the back, belly, breast, and behind, almost forming a square.
Back—Very broad.
Wings—Large.
Tail—Very large, expanded, feathers broad and carried well up.
Sickle Feathers and Tail Coverts—Long, broad, sound and well arched.
Thighs—Short, stout, and straight.
Legs—Straight, short, stout, clean, and perfectly free from feathers, spurred on the inside.
Feet—Five-toed, the extra or supernumerary toe well developed, distinctly separated from the others, and pointing upwards.
Carriage and Appearance—Noble, bulky, and grand.

THE HEN.

Beak—Rather short.
Comb—If single, to be well developed, and falling over one side of the face; if rose, square in front, straight on the head, peak behind, inclining slightly upwards.
Wattles—Broad, rounded on the lower edge.
Head—Neat.
Neck—Short and taper.
Breast—Very deep, broad, and full.
Body—Large, compact, plump, and deep.
Back—Broad.
Wings—Large.
Tail—Large, expanded, the feathers broad.
Thighs—Short and stout.
Legs—Short, straight, thick, and strong.
Feet—Five-toed, the extra toe well developed, distinctly separated from the others and inclining upwards.
Carriage and Appearance—Bulky.

SILVER GREY DORKINGS.

COLOUR OF COCK.

Head and Neck Hackle—Clear white.
Comb, Face, and Wattles—Bright red.
Breast, Underpart of Body, and Thighs—Rich glossy black.
Back and Shoulder Coverts—Silvery white.
Saddle—Clear white.
Wing Bow—Silvery white.
 „ *Coverts*—Metallic green black, forming a wide bar across the wing.
 „ *Primaries*—White on the outside edge of the outer web, black on the inside web.
 „ *Secondaries*—Clear white on the outside web, black on the inside web, and also on the end of the feather.
Tail—Rich black.
Sickle Feathers—Rich metallic green black.

Tail Coverts—Rich metallic green black, the lesser ones silvered on the edge.
Legs—White, with a flesh-coloured tinge betwixt the scales.

COLOUR OF HEN.

Head—Silvery or ashy grey.
Comb, Face, and Wattles—Bright red.
Neck—Silvery white, striped with black.
Breast—Salmon red, shading off to grey towards the thighs.
Back and Shoulder Coverts—Silvery or slaty grey, free from dark bars or marks across the feathers, shaft of feathers white.
Wing Bow—Silvery or slaty grey, shaft of feathers white. Any tendency to red on the wings is highly objectionable.
Coverts and Flights—Slaty grey.
Tail—Dark grey, inside approaching black.
Thighs—Ashy grey.
Legs—White, with a flesh-coloured tinge betwixt the scales.

Points in Silver Grey Dorkings.

Size	3
Colour	3
Head and Comb	2
Legs, Feet, and Toes	2
Symmetry	3
Condition	2
	—
	15
	—

Disqualifications.

Birds without the fifth toe, or with crooked backs, wry tails, combs not uniform in the pen, white in cock's breast or tail, legs of any colour except white.

COLOURED DORKINGS.

The colour in these not material, providing the birds match in the pen.

Points in Coloured Dorkings.

Size	5
Head and Comb	2
Legs, Feet, and Toes	2
Symmetry	4
Condition	2
	—
	15
	—

Disqualifications.

Birds without the fifth toe, or with crooked backs, wry tails, combs not matching in the pen, legs of any other colour except white.

WHITE DORKINGS.

Comb, Face, and Wattles—Rich red.

The whole of the plumage in both cock and hen pure white, the more free from yellow tinge the better.

Legs—White.

Points in White Dorkings.

Size	4
Purity of White Plumage	2
Head and Comb	2
Legs, Feet, and Toes	2
Symmetry	3
Condition	2
	—
	15
	—

Disqualifications.

Birds without the fifth toe, or with crooked backs or wry tails, combs not uniform in the pen, coloured feathers in any part of the plumage.

SPANISH.

GENERAL SHAPE.

THE COCK.

Beak—Dark horn colour, rather long and stout.
Comb—Bright red, large, single, stiff, erect, straight, free from twists in front or falling over to either side at the back, deeply serrated, rising from the beak betwixt the fore part of the nostrils, and extending in an arched form over the back of the head, free from excrescences or side-sprigs, and not of too great thickness at the edge.

Head—Long, broad, and deep-sided.
Eyes—Large, the sight perfectly free, and not obstructed by the white.

Face—Pure opaque white, long and deep, the greater breadth of surface the better, providing it is smooth, free from wrinkles, and the sight not obstructed, rising well over the eye towards the comb in an arched form, extending towards the back of the head, and also to the base of the beak, covering the cheeks, and joining the ear-lobes and wattles.

Ear-lobes—Pure opaque white, very large and pendent, rather thin, smooth, well expanded and free from folds or wrinkles, extending well on each side of the neck, hanging down very low, not pointed, but regularly rounded in the lower part, and meeting in front, behind the wattles.

Wattles—Bright red; very long, thin, ribbon-like, and pendulous; the inside of the upper part, and skin betwixt, white.

Neck—Long, well hackled.

Breast—Round, full, and prominent.

Back—Slanting down to the tail.

Body—Wedge-shaped, narrowing to the tail.

Wings—Large, carried well up to the body.

Tail—Large, expanded and rather upright, but not carried over the back, or squirrel-tailed.

Sickle Feathers—Large and well curved.

Thighs—Long and slender.

Legs—Long, dark leaden blue, or blue.

Plumage—Rich glossy black, having a metallic green lustre on the hackle, back, wings, saddle, tail coverts, and sickle feathers.

Carriage—Upright and striking.

Disqualifications in Spanish Cocks.

Comb—Falling over to one side, or twisted in front over the nostrils.

Face—So puffy as to obstruct the sight; decided red mark above the eye.

Plumage—Of any other colour except black, or metallic green black.

Legs—Of any other colour except dark leaden blue, or blue.

THE HEN.

Beak—Dark horn colour, long.

Comb—Glossy bright red, large, single, serrated, drooping over to one side of the face, free from side-sprigs or duplicature.

Head—Long and deep.

Eye—Large.

Face—Pure opaque white, smooth and free from wrinkles, with great breadth of surface, rising well over the eye in an arched form, extending well towards the back of the head, and also to the beak, covering the cheek, and joining the ear-lobes and wattles.

Ear-lobes—Pure opaque white, large, pendent, smooth, well expanded, free from wrinkles, regularly rounded on the lower edge.

Wattles—Bright red, thin, pendent, and rounded on the lower edge.

Neck—Long and graceful.

Breast—Round and full.

Back—Slanting down to the tail.

Wings—Ample, carried close up to the body.
Tail—Large, carried rather upright, but not over the back, the two highest feathers slightly curved, especially in pullets.
Thighs—Long and slender.
Legs—Long, dark leaden blue, or blue.
Plumage—Black, with a rich metallic lustre on the back and wings.
Carriage—Upright, movement quick.

Disqualifications in Spanish Hens.

Duplicature of comb, comb small and erect (prick-combed); decided red mark over the eye; plumage of any other colour except black, or metallic black; legs of any other colour except dark leaden blue, or blue; birds that are trimmed in any part whatever.

Points in Spanish Fowl.

Comb	2
Face	3
Ear-lobe	3
Purity of White, Face and Ear-lobe	2
Symmetry	3
Condition of Plumage	2
	—
	15
	—

GAME.

GENERAL SHAPE.

THE COCK.

Beak—Strong, curved, very stout at the base.
Comb—In a chicken that has not been dubbed, single, small and thin, low in front, serrated, erect, and straight; in older birds, neatly dubbed, smooth, and free from warty appearances, small feathers or ridges on the edges.
Head—Long, thin, and taper, very strong at the juncture with the neck.
Eyes—Large, bright, and prominent, perfectly alike in colour, with a quick, fearless expression.
Face and Throat—Lean and thin.
Neck—Rather long and neatly arched, hackle short and very close.
Back—Rather short, flat, broad across the shoulders and narrowing to the tail.
Breast—Broad, round, and full.
Stern—Slender and very neat, saddle feathers very short and close.
Wings—Strong, long, and very powerful; the butts and shoulder part slightly raised, as if for a sudden spring, the remainder of the wings not drooping, but carried neatly and compactly to the sides, passing over the upper part of the thighs, the points resting under the saddle feathers.
Tail—Rather long, the feathers very sound and not too broad, carried well together, and not spread out, scattered or loose.
Sickle Feathers and Tail Coverts—Perfectly sound, narrow, hard, and wiry, not hanging loosely, well carried and neatly curved; the whole of the tail going backwards and not upright over the back, or squirrel-tailed.
Thighs—Round, stout, hard, and firm, rather short in proportion to the shank, placed well up towards the shoulders, and covered with very close short feathers, so as to have a velvety appearance.
Legs—Rather long, strong, bony, clean, standing well and evenly apart; the spurs set on low; the scales close and smooth.
Feet—Broad, flat, and thin; toes long, spreading, and straight, well furnished with strong nails, with the hind toe set low on the foot, standing well backwards

and flat on the ground, not merely touching with the point of the toe, or duck-footed.
Plumage—Close, sleek, and glossy, body feathers short, hard, and firm, quills very strong.
Body in hand—Very muscular, and firm, not soft or hollow on the sides, perfectly straight in the breast and back, and quite even in the hip bones.
Carriage—Upright, active and quick.

THE HEN.

Beak—Long, slightly curved, sharp at the point, and stout at the base.
Comb—Single, small, and thin, low in front, evenly serrated, perfectly erect and straight.
Head—Long, slender, very neat and taper.
Eyes—Bright, large, and prominent, perfectly alike in colour, with a quick and fiery expression.
Face—Lean and thin.
Deaf-ear—Very small, and close to the face.
Wattles—Small, thin, and neatly rounded on the edge.
Throat—Neat, the feathers very short and close.
Neck—Long, feathers very short, giving the neck a slender and very graceful appearance.
Back—Moderate in length, perfectly flat and broad across the shoulders, and narrowing to the tail.
Wings—Long and powerful, the butts and shoulders carried rather high, so as to cause a perfectly flat back, the points not drooping, but carried compactly to the sides.
Tail—Moderate in length, not carried over the back, but extending backwards; the feathers not scattered or spread out, but held neatly together.
Breast—Broad, round, and prominent.
Thighs—Stout, round, and neat, the feathers short and very close.
Legs—Long, very bony, clean, and taper, the scales narrow, smooth, close, and neat.
Feet—Broad, flat, and thin; toes spreading, long and straight, well furnished with strong nails, the hind toe set low on the foot, standing well backwards, and not duck-footed.
Plumage—Very close, sleek, and glossy; body feathers short, hard, and firm, quills strong.
Carriage—Rather upright, very neat, quick, and active.

BLACK-BREADED RED GAME.

COLOUR OF COCK.

Head—Very rich dark red.
Comb, Face, and Jaws—Very bright red.
Eyes—Bright, clear, deep bay.
Neck Hackle—Rich red, free from black or dark stripes.
Back, Shoulder, and Shoulder Coverts—Rich dark red.
Wing Butts—Black.
 „ *Bow*—Rich dark red, perfectly free from black feathers.
 „ *Greater and Lesser Coverts*—Metallic green black, forming a wide bar across the wing, perfectly even, well defined, and not irregular on the edges.
 „ *Primaries*—Bay on the outside web, black on the inside.
 „ *Secondaries*—Rich clear bright bay on the outside web, black on the inside web, with a rich metallic green black spot on the end of the feather.
Saddle—Rich red.
Tail—Rich black.
Sickle Feathers and Tail Coverts—Very rich metallic green black.
Breast, Underpart of Body and Thighs—Rich black, perfectly free from any admixture of red or other colour.

Legs—Either willow, olive, yellow, white, or blue. The colours preferred in the order in which they are named.

COLOUR OF HEN.

Head—Brown.

Comb, Face, Deaf-ear, and Wattles—Very bright red.

Neck—Light brownish yellow, striped with black.

Back and Shoulder Coverts—Brown.

Wing, Bone, Shoulder, and Coverts—Same colour as back, perfectly free from red.

.. *Primaries and Secondaries*—Brown.

Tail—Dark brown, approaching black.

Breast—Deep salmon, shading off to ashy brown towards the thighs.

Thighs—Ashy brown.

Legs—To match those of the cock.

BROWN RED GAME.

COLOUR OF COCK.

Head—Very dark red.

Comb, Face, and Jaws—Bright red or dark purple (gipsy-faced).

Eyes—Dark brown or black.

Neck Hackle—Dark red, shaft of feather black.

Back and Shoulder Coverts—Dark crimson red.

Saddle—Dark red, shaft of feathers black.

Wing, Butts—Black or very dark dusky brown.

.. *Shoulder and Bow*—Dark crimson red.

.. *Coverts*—Rich glossy black.

.. *Primaries*—Dusky black.

.. *Secondaries*—Black, with a metallic lustre towards the end of the feathers.

Tail—Black.

Sickle Feathers and Tail Coverts—Rich glossy black.

Breast—Reddish brown streaked with black, shaft of feather black; the ground colour becoming darker as it approaches the lower part and thighs.

Thighs—Dusky black.

Legs—Olive bronzy black, or dark willow.

COLOUR OF HEN.

Head—Dark dusky brown, approaching a dusky black.

Comb, Face, Deaf-ear, and Wattles—Bright red or dark purple.

Eyes—Very dark brown or black.

Neck—Coppery yellow, striped with black.

Remainder of the Plumage—Very dark brown, approaching to black.

Legs—To match those of the cock.

GINGER RED GAME.

COLOUR OF COCK.

Head—Red.

Face and Jaws—Reddish purple.

Eyes—Brown.

Neck Hackle—Rich clear red.

Back, Shoulder Coverts, and Bow of the Wings—Rich red.

Wing—Primaries and secondaries brownish red.

Saddle—Rich clear red.

Tail—Black.

Sickle Feathers and Tail Coverts—Rich black, the lesser coverts edged with red.

Breast—Ginger red, becoming darker as it approaches the thighs.

Thighs—Dusky red.

Legs—Olive, bronzy black, or dark willow.

COLOUR OF HEN.

Head—Yellowish brown.

Comb, Face, Deaf-ear, and Wattles—Purple.

Eyes—Brown, perfectly alike in colour.

Neck—Golden yellow, striped with black.

Breast—Higher part towards the throat yellowish brown, shaft and a narrow margin of the feathers a much lighter shade.

.. Lower part and sides, dark dusky brown, with a narrow margin of the feathers of a golden ginger shade.

Remainder of the Plumage—Yellowish brown, with a narrow margin of the feathers of a golden ginger shade.

Legs—Same colour as those of the cock.

YELLOW DUCK-WING GAME.

COLOUR OF COCK.

Head—Straw-coloured yellow.

Comb, Face, and Jaws—Bright red.

Neck Hackle—Clear, straw colour, free from black.

Back, Shoulder Coverts, and Bow of the Wing—Rich, uniform, bright copper or maroon; the more even, clear, and unmixed in colour the better.

Wing Butts—Black.

.. *Greater and Lesser Coverts*—Steel blue, or metallic black, forming a wide bar across the wing.

.. *Primaries*—Straw white on the outside web, dark on the inside web.

.. *Secondaries*—White on the outside web, black on the inside, and on the end of the feathers.

Saddle—Clear straw colour.

Breast, Underpart of Body, and Thighs—Rich black.

Tail—Black.

Sickle Feathers and Tail Coverts—Rich metallic green black.

Legs—Willow, yellow, or olive.

COLOUR OF HEN.

Head—Grey.

Comb, Face, Deaf-ear, and Wattles—Bright red.

Neck—White, striped with black.

Breast—Salmon red, shading off to ashy grey towards the thighs.

Back, and Shoulder Coverts—Bluish or slaty grey, shaft of feather white.

Wing, Shoulder, and Bow—Slaty or bluish grey, shaft of feather white. Red or brown on the wing very objectionable.

Wing Coverts and Flight—Slaty or bluish grey.

Tail—Dark grey, the inside approaching black.

Thighs—Ashy grey.

Legs—To match those of the cock.

SILVER DUCK-WING GAME.

COLOUR OF COCK.

Head—Silvery white.

Face, Jaws, and Comb—Bright red.

Neck—Hackle clear white, without any mixture of black or other colour.

Breast, Underparts of Body, and Thighs—Black.

Back and Shoulder Coverts—Silvery white.

Saddle—Clear white.

Wing Butts—Black.

.. *Bow*—Silvery white.

.. *Coverts*—Steel blue, forming a wide bar across the wing.

.. *Primaries*—White on the outside web, dark on the inside web.

.. *Secondaries*—Clear white on the outside web, black on the inside web, and on the end of the feathers.

Tail—Black.

Sickle Feathers and Tail Coverts—Metallic green black the lesser tail coverts slightly edged with white.

Legs—Willow, olive, bronze, or blue.

COLOUR OF HEN.

Head—Silvery grey.
Comb, Face, Deaf-ear, and Wattles—Bright red.
Neck—Silver, striped with black.
Breast—Salmon.
Back and Shoulder Coverts—Silvery or ashy grey, shaft of feather white.
Wing Bow—Ashy grey, shaft of feather white. Red or brown on the wing very objectionable.
 „ *Flight and Coverts*—Grey.
Tail—Dark grey, approaching black.
Thighs—Ashy grey.
Legs—To match those of the cock.

BIRCHEN YELLOW GAME.

COLOUR OF COCK.

Head—Dark straw colour.
Face and Wattles—Either red or purple.
Neck—Hackle, deep straw colour, striped with reddish brown.
Breast—Reddish brown, shaft and narrow margin of the feathers cream colour.
Back and Shoulder Coverts—Rich coppery straw, marked with reddish brown.
Saddle—Deep straw, striped with reddish brown.
Wing Butts—Dull black.
 „ *Bow*—Rich dark coppery straw, slightly marked with reddish brown.
 „ *Coverts*—Cream colour, mottled with reddish brown and tipped with chocolate.
 „ *Flight*—Reddish brown.
Tail—Black.
Sickles—Bronzy black.
Tail Coverts—Bronzy black, the lesser with a narrow margin of cream colour.
Legs—Bronzy black, olive, willow, or yellow.

COLOUR OF HEN.

Head—Dark grey.
Comb, Face, Deaf-ear, and Wattles—Either red or purple.
Neck—Grey, striped with dull black.
Breast—Greyish brown, shaft and margin of feather creamy white.
Back and Shoulder Coverts—Greyish brown; shaft of feather dull creamy white.
Wing Bow—Greyish brown, shaft of feather dull creamy white.
 „ *Coverts*—Greyish brown.
 „ *Flights*—Dark grey.
Tail—Dark greyish brown.
Thighs—Greyish brown.
Legs—To match those of the cock.

PILE GAME.

COLOUR OF COCK.

Head—Deep chestnut red.
Comb, &c.—Rich bright red.
Neck Hackle and Saddle—Light chestnut red on the outside of the web of the feather; the middle of each feather white towards the end.
Breast—Higher part marbled red and white, lower part white, or entirely white.
Back, Shoulder Coverts, and Bow of the Wings—Rich, uniform red.
Greater and Lesser Wing Coverts—White, edged with red.
Wing Secondaries—White on the outside web, red on the inside web, with a rich red spot on the end of the feather.
 „ *Primaries*—White.
Thighs—White.
Tail—White.
Legs—Yellow, willow, or white.

COLOUR OF HEN.

Comb, Face, Deaf-ear, and Wattles—Bright red.
Neck—Chestnut and white.
Breast—Chestnut red on the front part, mottled with white on the lower part.
Thighs and Tail—White.
Remainder of the Plumage—White, mottled with light chestnut red.
Legs—To match those of the cock.

WHITE GAME.

Comb, Face, Deaf-ear, and Wattles—Very bright red.
 The whole of the plumage clear white. The cock's plumage as free from yellow tinge as possible.
Legs—Yellow or white.

BLACK GAME.

Comb, &c.—Bright red.
 The whole of the plumage glossy black, with a metallic lustre on cock's hackle, back, saddle, wings, and tail.
Legs—Bronzy black, dark olive, or leaden black.

Points in Game.

Shape of Head and Neck	2
Body and Wings	2
Tail	2
Thighs, Legs, and Tees	2
Colour of Plumage	3
Symmetry, Handling	2
Condition, and Hardness of Plumage	2
	15

Disqualifications.

Colour of legs, or plumage, not matching in the pen; crooked backs or breasts; adult cocks not dubbed.

HAMBURGHES.

GENERAL SHAPE.

THE COCK.

Beak—Medium.
Comb—Double, not so large as to overhang the eyes or beak, square in front, fitting close and straight on the head without inclining to either side, no hollow in the centre, uniform on each side, the top covered over with small points, with a peak behind, inclining very slightly upwards.
Head—Rather short and small.
Eye—Full and quick.
Deaf-ear—Not pendent, but fitting close to the face, flat, of medium size, round, and even on the surface.
Wattles—Broad, thin, and well rounded on the lower edge.
Neck—Taper, the higher part carried well over the back, hackle full, the lower part flowing well on to the shoulders.
Breast—Round, full, and prominent, carried well forward.
Back—Short, well furnished with saddle feathers.
Wings—Ample, points carried rather low.
Tail—Full, expanded, sickle feathers well curved.
Thighs—Short and neat.
Legs—Slender, rather short, very neat, and taper.
Plumage—Rich and glossy.
Carriage—Upright and strutting, graceful, quick, and restless.

THE HEN.

Beak—Rather small.
Comb—Same shape as that of cock, but very much less; smaller in the pencilled than in the spangled varieties.

Head—Small and very neat.
Eye—Full and very quick.
Deaf-ear—Small, flat, rounded in the lower part, fitting close to the face, and not pendent.
Wattles—Small and thin, rounded on the lower edge.
Neck—Taper and very graceful.
Breast—Broad, plump, and carried forward.
Back—Rather short, but not so much so in appearance as in the cock.
Wings—Ample, carried very neatly to the body.
Tail—Full, expanded, and well carried.
Thighs—Short and neat.
Legs—Very slender, neat, and taper.
Plumage—Close and glossy.
Carriage—Graceful, quick, and restless.

GOLDEN PENCILLED HAMBURGHIS.

COLOUR OF COCK.

Comb, Face, and Wattles—Rich red.
Deaf-ear—Pure opaque white, free from red on the edge.
Head and Hackle—Clear reddish bay.
Back, Saddle, Bow of the Wing, Shoulder and Wing Coverts—Rich deep reddish bay.
Flight—Reddish bay on the outside web, black on the inside web.
Secondaries—Reddish bay on the outside web, the inside web pencilled across with broad black marks, each feather ending with a rich black spot.
Breast and Thighs—Reddish bay.
Tail—Black.
Sickle Feathers and Tail Coverts—Rich black down the middle of the feather, the entire length edged with bronze, each brouze edge as near one-fourth the width of the feather as possible; the more distinct the two colours the better.
Legs—Slaty blue.

COLOUR OF HEN.

Comb, Face, and Wattles—Rich red.
Deaf-ear—Pure opaque white, free from red on the edge.
Head and Neck—Clear deep golden bay.
Remainder of the Plumage—Clear deep golden bay, free from either lacing or mousing; each feather (including tail feathers) distinctly pencilled across with rich black; the pencilling not to follow the outline of the feather, but to go straight across on each side of the shaft. The two colours distinct, well defined, and not shading into each other.
Legs—Slaty blue.

SILVER PENCILLED HAMBURGHIS.

The same standard will apply to the Silver Pencilled Hamburgs, substituting a clear silvery white ground for a golden one. The silver cock as free as possible from yellow tinge.

PENCILLED HAMBURGHIS.

Points in Cocks.

Comb	3
Deaf-ear	2
Colour of Plumage, except tail, sickle feathers, and tail coverts	3
Colour of Tail, Sickle Feathers, and Tail coverts	3
Symmetry	2
Condition	2
	—
	15
	—

Points in Hens.

Comb	2
Deaf-ear	2
Purity of Colour in Head and Neck	3
Purity of Ground Colour, and accurate and distinct Pencilling in every part, except head and neck	4
Symmetry	2
Condition	2
	—
	15
	—

Disqualifications.

Hen-feathered cocks, crooked backs, wry tails, combs single or falling over to one side, red deaf-ears, shanks of any other colour except blue.

GOLDEN-SPANGLED HAMBURGHIS.

COLOUR OF COCK.

Comb, Face, and Wattles—Rich bright red.
Deaf-ear—Opaque white.
Head—Deep reddish bay.
Hackle—Rich deep golden bay, each feather striped down the centre with rich green black, each colour well defined, and not clouded.
Breast, Underpart of Body, and Thighs—Golden bay, free from mousing, streaking, or lacing, each feather ending with a round, large, rich black moon or spangle, the moons increasing in size in proportion to the size of the feather.
Back and Shoulder Coverts—Rich deep reddish bay, distinctly spangled with rich metallic black, the texture of the feather giving the spangle a starry or rayed appearance.
Saddle—Rich reddish golden bay, each feather striped down the centre with rich metallic green black.
Wing Bow—Rich reddish golden bay, distinctly spangled with black.
 „ *Bars*—The greater and lesser wing coverts clear reddish golden bay, free from lacing, each feather ending with a large round green-black spangle, forming two distinct parallel green black bars across the wing.
 „ *Primaries*—Bay, ending with a black spot.
 „ *Secondaries*—Rich golden bay, each feather ending with a rich green-black spot.
Tail—Black.
Sickle Feathers and Tail Coverts—Rich green black.
Legs—Slaty blue.

COLOUR OF HEN.

Comb, Face, and Wattles—Rich bright red.
Deaf-ear—Opaque white.
Head—Golden bay, distinctly tipped with black.
Neck—Golden bay, each feather distinctly striped down the centre with rich green black, the colours distinct and not clouded.
Breast, Underpart of Body, and Thighs—Clear golden bay, free from mousing or lacing, each feather ending with a distinct large, round, rich green-black moon or spangle, the moons increasing in size in proportion to the size of the feather.
Back, Shoulder Coverts, and Rump—Rich clear golden bay, free from mousing or lacing, each feather ending with a distinct large, round, rich green-black spangle.
Wing Bow—Rich clear golden bay, each feather ending with a distinct round rich green-black spangle.
 „ *Bars*—Greater and lesser wing coverts rich clear golden bay, free from lacing, each feather ending with a large, round, rich, green-black spangle, forming two distinct parallel green black bars across the wings.
 „ *Primaries*—Golden bay, each feather ending with a black spangle.
 „ *Secondaries*—Golden bay, each feather ending with a rich green-black half-moon or crescent-

shaped spangle, termed by the Lancashire fanciers, "lacing on the top of the wing above the flight."

Tail—Black.

Tail Coverts—Golden bay, free from mossaing or lacing, each feather ending with a rich green-black spangle.

Legs—Slaty blue.

Hens in a pen to match as nearly as possible in size of markings and depth of colour.

SILVER-SPANGLED HAMBURGHES.

COLOUR OF COCK.

Comb, Face, and Wattles—Rich bright red.

Deaf-ear—Opaque white.

Head—Silvery white.

Hackle—Silvery white, free from yellow tinge, the longest feathers ending with a small black spangle.

Breast, Underpart of Body, and Thighs—Clear silvery white, free from lacing or mossaing, each feather ending with a distinct large, round, rich black moon or spangle, the moons increasing in size in proportion to the size of the feather.

Back and Shoulder Coverts—Pure white, free from yellow tinge, distinctly spangled with black, the texture of the feather giving the spangle a starry or rayed appearance.

Saddle—Silvery white, free from yellow, the largest feathers ending with a small black spangle.

Wing Bow—Pure white, distinctly spangled with black spangles.

„ *Bars*—The greater and lesser wing coverts clear silvery white, free from lacing, each feather ending in a large green-black moon or spangle, forming two distinct parallel black bars across the wing.

„ *Primaries*—Pure white, each feather ending with a distinct black spangle.

„ *Secondaries*—Pure white, each feather ending in a half-moon shaped green-black spot.

Tail—White on the outside, each feather ending in a large black spangle.

Sickle Feathers and Tail Coverts—White, each feather ending with a rich green-black spangle.

Legs—Slaty blue.

COLOUR OF HEN.

Comb, Face, and Wattles—Rich bright red.

Deaf-ear—Opaque white.

Head—Silvery white, distinctly spangled with small black spangles.

Neck—Clear silvery white, each feather distinctly striped towards the end with rich black, each colour well defined and not clouded.

Breast, Underpart of Body, and Thighs—Clear silvery white, free from lacing or mossaing, each feather ending with a distinct large, round, black moon or spangle, the moons increasing in size in proportion to the size of the feather.

Back, Shoulder Coverts, and Rump—Clear silvery white, free from mossaing or lacing, each feather ending with a distinct large, round rich green-black moon or spangle.

Wing Bow—Clear silvery white, each feather ending with a distinct round, rich green-black spangle.

„ *Bars*—Greater and lesser wing coverts clear silvery white, free from lacing or mossaing, each feather ending with a large round green-black spangle, forming two distinct parallel black bars across the wing.

„ *Primaries*—White, each feather ending with a distinct black spangle.

„ *Secondaries*—Clear silvery white, each feather ending with a large half-moon shaped green-

black spangle, termed by the Lancashire fanciers "lacing on the top of the wing."

Tail—White on the outside, each feather ending with a large round black spangle.

Tail Coverts—Clear silvery white, free from mossaing or lacing, each feather ending with a distinct large, round, green-black spangle.

Legs—Slaty blue.

Hens in a pen to match as nearly as possible in size of markings and depth of colour, &c.

Points in Spangled Hamburg Cocks.

Comb	2
Deaf-ear	2
Colours and Marking of Head, Hackle, Back, Saddle, and Tail	3
Breast, Underparts of Body and Thighs	2
Wings and Bars	2
Symmetry	2
Condition	2
	<hr/>
	15
	<hr/>

Points in Spangled Hamburg Hens.

Combs	2
Deaf-ear	2
Neck most distinctly and evenly striped	1
Remainder of Plumage (except tail in Golden) clearness of ground colour, evenness and distinctness of spangling, with rich large round spangles	4
Bars	2
Symmetry	2
Condition	2
	<hr/>
	15
	<hr/>

Disqualifications.

Hen-feathered cocks, crooked backs, wry tails, combs single, or falling over to one side, red deaf-ears, birds without distinct bars across the wing. Legs of any other colour except blue.

BLACK HAMBURGHES.

Comb, Face, and Wattles—Rich bright red; the face perfectly free from white.

Deaf-ear—Pure opaque white; round and small, fitting close to the face; not pendent.

Plumage—Very rich glossy green black.

Legs—Blue or dark leaden blue.

Points in Black Hamburgs.

Comb, Head, and Face	3
Deaf-ear	2
Plumage	4
Shape	4
Condition	2
	<hr/>
	15
	<hr/>

Disqualifications.

Combs falling over to one side, or so large as to obstruct the sight, red deaf-ears, crooked backs, wry tails, or legs of any colour except blue or dark leaden blue.

POLISH.
GENERAL SHAPE.

THE COCK.

Crest—Composed of feathers similar in texture to the hackle, very large, round, close, and well fitted on the crown of the head, falling backwards, and rather lower on the sides than over the beak, but not so low on the sides as to prevent the bird from seeing.

Head—With round protuberance on the top, concealed by the large crest.
Eye—Large, full, and bright.
Deaf-ear—Small, even on the surface, rounded on the lower edge.
Wattles—In the unbearded varieties, thin, and pendulous; in the bearded varieties, none—the underside of the beak and throat being covered with a full, close, muffy beard.
Neck—Medium in length, slightly and neatly curving over the back and well hackled.
Breast—Deep, full, round, and carried prominently forward.
Back—Perfectly straight, wide betwixt the shoulders, and tapering to the tail; hip-bones even.
Wings—Ample.
Tail—Large, rather erect, expanded, and well adorned with sickle feathers.
Thighs—Short in the white-crested black, rather long in the spangled varieties.
Legs—Rather short in the white-crested blacks, long in the spangled varieties.
Carriage—Erect.

THE HEN.

Crest—Very large, round, straight on the head, not inclining to either side, the surface close, firm, and even.
Head—Round, the protuberance concealed by the crest.
Eye—Large, full, and bright.
Deaf-ear—Small, even on the surface, and rounded on the lower edge.
Wattles—In the unbearded varieties, small and thin; in the bearded varieties, none—the throat and underside of the beak being covered with a full close beard.
Neck—Rather short and taper.
Breast—Very full, round, and prominent.
Back—Straight, the hip-bones even.
Wings—Ample.
Tail—Large, expanded, and broad at the end.
Thighs—Short in the white-crested black, rather long in the spangled varieties.
Legs—Clean, neat, and taper; short in the white-crested blacks, rather long in the spangled varieties.
Carriage—Rather upright.

WHITE-CRESTED BLACK POLISH.

COLOUR.

Crest—Pure white; the less black in front the better.
Deaf-ear—Pure opaque white.
Remainder of the Plumage—Uniformly rich glossy black.
Legs—Lead-en blue, or black.

Points in White-crested Black Polish.

Size of Crest	3
Shape of Crest	3
Crest of the purest white, and most free from black	2
Deaf-ear	1
Richest black Plumage	2
Symmetry	2
Condition and General Appearance	2
	<hr/>
	15
	<hr/>

Disqualifications.

Crooked backs, wry tails, white feathers in any part except the crest, legs of any other colour except dark lead-en blue, or blue.

GOLDEN-SPANGLED POLISH.

COLOUR OF COCK.

Crest—Golden bay, laced with black; in adults, white feathers may appear.
Hackle and Saddle—Golden bay, the end of each feather laced with black.
Breast—Clear golden bay, free from mousing, each feather ending with a round rich black spangle, the spangle increasing in size in proportion to the size of the feather.
Back, Shoulder Coverts, and Bow of the Wing—Rich golden bay, spangled with black, the texture of the feather giving the spangle a rayed appearance.
Bars—Greater and lesser wing coverts, golden bay, each feather laced on the edge with black, and ending with a large black spangle, forming two distinct black bars across the wing.
Primaries—Bay, ending with a black spot.
Secondaries—Golden bay, with a distinct crescent-shaped green-black mark on the end of each feather.
Thighs—Bay, spangled with black.
Tail—Rich golden bay, each feather ending with a rich black spot.
Sickle Feathers—Rich golden bay, ending with a rich black spangle.
Tail Coverts—Rich golden bay, edged with rich black, and ending with a rich black spangle.
Legs—Blue.

COLOUR OF HEN.

Crest—Golden bay, each feather laced with black; in adults, white feathers may appear.
Neck—Golden bay, laced with black.
Breast, Underparts of Body, and Thighs—Clear golden bay (free from mousing), each feather ending with a distinct round, rich, black spangle, the spangle increasing in size in proportion to the size of the feather.
Back and Shoulder Coverts—Golden bay, each feather ending with a distinct round black spangle.
Wing Bow—Golden bay, each feather ending with a crescent-shaped black spangle.
Wing Coverts—Golden bay, each feather laced or edged with black, and ending with a large black spangle, forming two distinct black bars across the wing.
Primaries—Bay, each feather ending with a black spot.
Secondaries—Golden bay, each feather ending with a crescent-shaped black mark.
Tail—Bay, each feather ending with a large black spangle.
Legs—Blue.

SILVER-SPANGLED POLISH.

Colour and Marking the same as in Golden, substituting Silvery White Ground for Golden Bay.

Points in Spangled Polish.

Size of Crest	3
Shape of do.	3
Colour of do.	1
Plumage accurately marked according to the foregoing rules	2
Purity of Ground Colour	1
Bars	1
Symmetry	2
Condition	2
	<hr/>
	5
	<hr/>

Disqualifications.

Crooked backs, wry tails, legs of any other colour except blue.

SULTANS.

THE COCK.

Crest—Composed of hackle feathers, full, and arched over the eyes, and round head, full in centre, and falling softly and evenly round at back, not straight and stiff as in Polish; the front free from feathers falling forward, and neatly arched at both sides.
Beak—Brilliant white, tinged with red at base, very curved, and with broad cavernous nostrils.
Comb—Invisible, or two small spikes, brilliantly red.
Muffling—Thick and close round the throat, meeting the crest, and covering the face.
Eye—Bright, vivacious, and intelligent.
Wattles—Small and rather shrivelled.
Neck—Rather short, carried well back, very arched, and very thickly hackled.
Breast—Deep, full, round, and carried well forward.
Body—Very square, deep, and carried low.
Back—Straight, and rather broad.
Wings—Ample, and carried down.
Tail—Large, erect, and well sickled.
Thighs—Very short and well feathered.
Legs—Very short, feathered to the toes, with full, long vulture hocks.
Toes—Straight, five in number.
Colour of Plumage—Brilliantly white throughout.
Carriage—Rather low, brisk, and vivacious.

THE HEN.

Crest—Full, round, close, and globular.
Eye—Bright and intelligent.
Muffling—Very thick and close round the throat, going well back, covering the face, and meeting the crest.
Beak—Curved, clear, transparent white.
Neck—Short, fully arched, and very thickly feathered, carried well back.
Breast—Full, deep, and prominent.
Back—Straight and broad.
Body—Very square, and carried low and forward.
Wings—Full, and carried low.
Tail—Large, erect, and well expanded.
Thighs—Very short and well feathered.
Legs—Very short, feathered to the toes, with full, large vulture hocks.
Toes—Five in number.
Colour of Plumage—Brilliantly white throughout.
Carriage—Low, forward, brisk, and lively.

Points.

Crest	4
Muffling	3
Shape	3
Leg-feathering	3
Condition	2
	—
	15
	—

Disqualifications.

Any colour but white in the plumage, crooked crest, bare red face, or absence of muffling, deficiency of leg-feathering, or absence of vulture hocks, beak any colour but white, deformity of any kind.

HOUDANS.

THE COCK.

Crest—Composed of hackle feathers, full, and well arched, falling back, and right and left of comb, clear of the eye, rather than over it.
Comb—Well developed, large, red, and branching, broad at base, well indented, looking like a mass of coral with antler-like branches, inclining rather backward into the crest.
Beak—Curved, with nostrils wide and cavernous, as in Polish, dark horn colour.
Eye—Large, full, bright, and lively; colour various.

Wattles—Thin, rather long, neatly rounded, and bright red.
Muffling or Beard—Full and thick under beak, and reaching well back in a curve to the back of eye.
Face—Red; the less seen the better.
Breast—Deep, full, and plump.
Back—Wide and straight.
Wings—Moderate, and carried well up.
Tail—Moderate, erect, and well sickled.
Thighs—The shorter the better.
Legs—Fine in bone, white shaded.
Toes—Five in number, the fifth curved upwards at back.
Colour—Broken black and white, as evenly broken as possible, free from coloured feathers, which, however, though objectionable, are not a disqualification.
Carriage—Lively, brisk, well set up, and spirited.

THE HEN.

Crest—Large, compact, and even, as in Polish.
Comb—Small, branching, and coral-like.
Eye—Full and bright.
Wattles—Small, red, and neatly rounded.
Muffling—Full, forming a thick beard reaching back to the eye.
Neck—Rather short, full feathered, and arched.
Breast—Full and deep.
Back—Wide and straight.
Wings—Moderate, and carried closely to body.
Tail—Moderate, and fan-like, carried well up.
Thighs—Short.
Legs—Fine in bone, white, or shaded in colour.
Toes—Five in number, the hind or fifth claw curved upwards.
Colour—As in cock.
Carriage—Brisk, and rather upright.

Points.

Size	4
Crest	4
Symmetry	2
Plumage	2
Condition	2
Five Claws	1
	—
	15
	—

Disqualifications.

Absence of crest. Deformity of any kind. Main colour or ground colour other than black and white.

CREVE CŒURS.

THE COCK.

Crest—As in the Polish cock, but perfectly black; white feathers a defect, but not a disqualification.
Head—As in Polish cock.
Comb—Brilliant red, two-horned in shape, but free from tynes, slightly sprigged at base, of good size, showing well in front of the crest.
Eye—Full, bright, and very vivacious.
Deaf-ears—Small and nearly concealed.
Face—Red, well muffed.
Wattles—Moderately pendulous, and evenly rounded, brilliant red.
Muffling—Close and thick, running to back of eye in a handsome curve.
Beak—Black, with horn-coloured tip, strong and well curved, with highly arched broad nostrils, as in Polish.
Neck—Moderate in length, thickly hackled, well arched, and carried a little back.
Breast—Broad and full, carried well forward.
Back—Wide, perfectly straight, and free from deformity.
Body—Long and square.
Wings—Closely set, and well clipped up.
Tail—Full and ample, well sickled, and carried rather erect.
Thighs—Rather short, well set in body.

Legs—Black or slate; the shorter the better, rather fine in the bone. Free from feathers.
Carriage—Upright, smart, vivacious, and watchful.
Colour—Brilliant black. Red or straw feathers in the hackle or saddle undesirable, but not a disqualification.

THE HEN.

Crest—Full and globular, as in the Polish black; white feathers objectionable, but not a disqualification.
Head—As in Polish.
Eye—Full and bright.
Deaf-ears—Small, hidden by muffling.
Muffling—Thick and full, extending well back to crest, and forming a thick beard under the beak.
Wattles—Very small and neatly rounded.
Neck—Thick and arched.
Breast—Full, plump, and carried well forward.
Body—Square, and carried low.
Back—Straight and broad.
Wings—Well clipped up.
Tail—Large and well expanded.
Thighs—Short, and well set into body.
Legs—Short as possible, free from feathers, rather small in bone, slate or black in colour.
Carriage—Upright and vivacious.
Colour—Brilliant black; a brown tinge very undesirable.

	Points in Creve Cœurs.
Size	4
Crest	3
Shape and Symmetry	2
Colour	3
Condition	2
Comb	1
	—
	15
	—

Disqualifications in Creve Cœurs.

Deformity of any kind. Coloured feathers elsewhere than in crest, neck, or saddle, feathered legs, and shanks of any other colour than black or slate.

LA FLECHE.

THE COCK.

Beak—Black, strong, and curved; nostrils, wide and cavernous, as in Polish, with small spot or knob of bright red flesh at junction of nostril with beak.
Comb—Branching and antler-like, like two horns pointed straight up, brilliant red.
Ear-lobes—Large, and as white as possible.
Head—Long.
Eye—Bright, large, and watchful.
Face—Red, and rather bare.
Wattles—Red, long, and pendulous, well rounded.
Neck—Long, rather curved, and upright; hackle thick, but rather short.
Back—Very long and broad, slanting towards the tail.
Wings—Long, and well clipped in.
Breast—Broad, and rather full.
Tail—Rather small, and carried low.
Thighs—Strong, long, and well set into body.
Legs—Long, strong, and black or slate in colour.
Toes—Four.
Plumage—Close and hard, brilliant metallic black.
Carriage—Very upright, dignified, and watchful.

THE HEN.

Beak—Black, strong, and curved; nostrils arched, broad, and cavernous.
Comb—Double-spiked and branching, standing well up, or the branches inclining a little forward, small.
Head—Long.
Eye—Bright and watchful.
Face—Red, and rather bare.
Deaf-ear—Small and white.
Wattles—Red, small, and neatly rounded.
Neck—Long and straight.
Back—Broad and tapering towards the tail.

Body—Wide and deep.
Breast—Very broad.
Wings—Large, and well clipped up.
Tail—Small in proportion, but well expanded, and carried upright.
Thighs—Long, and well set into body.
Legs—Long, well boned, black or slaty in colour.
Plumage—Brilliant metallic black, close and hard.
Carriage—Upright, dignified, and watchful.

	Points.
Size	5
Comb	3
Shape	3
Condition	3
Deaf-ear	1
	—
	15

Disqualifications.

Plumage any colour but black, presence of crest, feathered legs, deformity of any kind, legs any colour but black or dark.

BANTAMS.

GAME BANTAMS.

GENERAL SHAPE AND COLOUR.

The same as in the corresponding varieties of Game Fowls.

Points in Game Bantams.

Smallness of Size	2
Colour	3
Shape of Head and Neck	2
„ Body and Wings	2
„ Tail	2
„ Thighs, Legs, and Toes	2
Condition	2
	—
	15

Disqualifications.

Cocks above 24 oz. or hens above 20 oz.; adult cocks undubbed, colour of legs not uniform in the pen, birds not matching in the pen.

SEBRIGHT BANTAMS.

GENERAL SHAPE—THE COCK.

Comb—Double, square in front, fitting close and straight on the head, the top covered with small points, with a peak behind turning slightly upwards.
Head—Small, round in front, carried well back towards the tail.
Beak—Short, slightly curved.
Eye—Full.
Wattles—Broad, rounded on the lower edge.
Deaf-ear—Flat.
Neck—Neat and taper, quite free from hackle feathers.
Breast—Round, full, and carried prominently forward.
Back—Very short, perfectly free from saddle feathers.
Wings—Ample, the points carried very low, almost touching the ground.
Tail—Square, similar to the hen, free from sickle or curved feathers, the feathers broadest towards the end.
Tail Coverts—Straight, round at the end and lying close to the sides of the tail.
Thighs—Very short.
Legs—Short, slender, and very taper.
Plumage—Close, perfectly hen-feathered.
Carriage—Very upright and strutting.

THE HEN.

Very similar to the cock. The comb and wattles much smaller, and the head neater.

COLOUR OF GOLD-LACED SEBRIGHTS.

Head, Face, and Wattles—Rich red.
Deaf-ear—White.

Plumage—Rich golden yellow, every feather laced with rich black, that is, having a narrow, even, well-defined rich black edge all round the feathers; the two colours distinct, and not shading into each other, the lacing of the same width on the sides as on the ends of the feathers.

Legs—Slaty blue.

COLOUR OF SILVER-LACED SEBRIGHTS.

Similar to the golden, substituting silvery white for the golden yellow ground colour.

Points in Sebrights.	
Plumage most evenly and distinctly laced throughout	4
Purity of Ground Colour in Silver, and richness and clearness of Ground Colour in Golden	2
Comb	2
Tail	1
Smallness	2
Symmetry	2
Condition and General Appearance	2
	<hr/>
	15

Disqualifications.

Cocks weighing more than 20 oz.; hens more than 18 oz.
Cocks having either hackle, saddle, or sickle feathers.
Legs of any colour except slate blue.

BLACK AND WHITE BANTAMS.

GENERAL SHAPE—THE COCK.

Comb—Double, square in front, close and straight on the head, the top covered with small points, with a peak behind, turning slightly upwards.

Head—Small, round, and carried well back towards the tail.

Beak—Short, slightly curved.

Eye—Prominent.

Deaf-ear—Flat and even on the surface.

Wattles—Broad and thin, rounded on the lower edge.

Neck—Very taper, curving well back, so as to bring the back of the head towards the tail; hackle full and long, flowing well over the shoulders.

Breast—Round, and carried prominently forward.

Back—Very short, saddle feathers long.

Wings—Ample, the points drooping so as nearly to touch the ground, the secondaries slightly expanded.

Tail—Full, expanded, well adorned with long curving sickle feathers, carried well up towards the back of the head.

Thighs—Short. [the head.]

Legs—Short, clean, and taper.

Carriage—Very upright, proud, and strutting.

THE HEN.

Comb—Same shape as that of cock, but very much smaller.

Head—Small, round, and neat.

Beak—Small.

Eye—Full and quick.

Deaf-ear—Flat, and even on the surface.

Wattles—Small.

Neck—Short and taper, carried well back.

Breast—Round and prominent.

Back—Short.

Wings—Ample, points drooping.

Tail—Full, expanded, carried rather upright.

Thighs—Short.

Legs—Short, clean and taper.

Carriage—Upright and strutting.

COLOUR OF BLACK BANTAMS.

Comb, Face, and Wattles—Rich bright red.

Beak—Dark horn colour, or black.

Deaf-ear—Pure white.

Plumage—Rich black throughout.

Legs—Black, or very dark leaden blue.

COLOUR OF WHITE BANTAMS.

Comb, Face, and Wattles—Rich scarlet red.

Beak—White.

Deaf-ear—Pure white.

Plumage—Pure white, as free from yellow tinge as possible.

Legs—White, with a slight pink tinge on the back, and betwixt the scales.

Points in Black or White Bantams.	
Purity of White or Richness of Black	3
Smallness	3
Symmetry	3
Comb	2
Deaf-ear	2
Condition and General Appearance	2
	<hr/>
	15

Disqualifications.

Cocks more than 20 oz., or hens more than 18 oz.
Legs of black bantams not black or dark leaden blue.
Legs of white bantams of any other colour except white.

TURKEYS.

Head and Face—Very bright and rich in colour.

Eyes—Bright and clear.

Body—Long and deep.

Wings—Powerful, and well carried.

Breast—Broad, very long, and perfectly straight.

Thighs—Muscular, straight, and strong.

Legs—Very strong, and perfectly straight.

Plumage—Sound, hard, and glossy.

Colour—Rich, the birds matching in the pen.

Points.

Size	6
Symmetry	4
Richness of Colour, and Matching in the Pen	3
Condition	2
	<hr/>
	15

Disqualifications.

Crooked breasts, backs, or legs, or deformity in any part.

DUCKS.

AYLESBURY.

GENERAL SHAPE AND COLOUR.

Bill—Long and broad; when viewed sideways, nearly straight from the top of the head to the tip of the bill; of a delicate pale flesh colour, perfectly free from black or dark marks.

Head—Long and fine.

Neck—Long, slender, and gracefully curved.

Body—Long and deep.

Back—Long and broad.

Wings—Strong, carried well up, and not drooping.

Tail—Feathers stiff and hard, with hard curled feathers in the drake.

Thighs—Short.

Legs—Short and strong; bright light orange colour.

Plumage—Pure white throughout.

Points in Aylesbury Ducks.

Purity of Colour and Shape of Bill	3
Size	4
Symmetry	3
Purity of Colour in Plumage	3
Condition	2
	<hr/>
	15

Disqualifications.

Birds so fat as to be down behind, bills deep yellow, or marked with black, plumage of any colour except white.

ROUEN DUCKS.

GENERAL SHAPE AND COLOUR—THE DRAKE.

Bill—Long, broad, and rather wider at the tip than at the base; when viewed sideways, nearly straight from the crown of the head to the tip of the bill; the longer the better. Colour, greenish yellow, without any other colour except the black bean at the tip.
Head—Long and fine; rich lustrous green.
Eye—Dark hazel.
Neck—Long, slender, and neatly curved; colour, the same lustrous green as the head, with a distinct white ring on the lower part not quite meeting at the back.
Breast—Broad and deep; the front part very rich purplish brown, or claret colour; free from grey feathers, the claret colour extending as far as possible towards the legs.
Back—Long; higher part ashy grey mixed with green, becoming a rich, lustrous green on the lower part and rump.
Shoulder Coverts—Grey, finely streaked with waving brown lines.
Wings—Greyish brown, mixed with green, with a broad ribbon mark of rich purple, with metallic reflections of blue and green, and edged with white; the two colours quite distinct.
 ,, *Flight Feathers*—Dark, dusky brown, quite free from white.
Underpart of Body and Sides—Beautiful grey, becoming lighter grey near the vent, and ending in solid black under the tail.
Tail—Feathers hard and stiff; dark ashy brown, the outer web in old birds edged with white.
Tail Coverts—Curled feathers hard and well curled; black, with very rich purple reflections.
Legs and Feet—Orange, with a tinge of brown.

THE DUCK.

Bill—Broad, long, and somewhat flat; brownish orange, with a dark blotch on the upper part.
Head—Long and fine; deep brown, with two light pale brown stripes on each side from the bill past the eye.
Neck—Long, slender, and neatly curved; light brown, pencilled with darker brown, and quite free from the least appearance of a white ring.
Breast, Underpart of Body and Sides—Greyish brown, each feather marked distinctly with a rich dark brown pencilling.
Back—Long; light brown, richly marked with green.
Wings—Greyish brown, mixed with green, with a broad ribbon mark of rich purple, edged with white, the two colours distinct.
 ,, *Flight Feathers*—Brown, perfectly free from white.
Tail Coverts—Brown, beautifully pencilled with broad distinct pencilling of dark greenish brown.
Tail—Light brown, with distinct broad wavy pencilling of dark greenish brown.
Legs—Orange, or brown and orange.

Points in Rouen Ducks.

Shape and Colour of Bill	3
Size	4
Colour of Plumage	3
Symmetry	2
Condition	2
	—
	15
	—

Disqualifications.

Bills clear yellow, dark green, blue or lead colour; any white in the flight feathers of either sex; birds so fat as to lie down behind.

BLACK EAST INDIAN.

GENERAL SHAPE AND COLOUR.

Shape—The entire form remarkably slender, neat, and graceful.
Size—The smaller the better.
Plumage—Rich lustrous black, with a brilliant velvety green tint throughout; perfectly free from white or brown feathers on any part whatever.
Bill of the Drake—Very dark yellowish green, without spot or blemish.
Bill of the Duck—Very dark.
Legs—Dark.

Points in Black East Indian Ducks.

Bill	2
Symmetry, Neatness, and Elegance of Form	3
Richness of Plumage	4
Smallness of Size	4
Condition	2
	—
	15
	—

Disqualifications.

White in any part of the plumage.

CALL DUCKS.

Shape—The entire form very short; round and compact, with very full, round, high forehead, and short broad bill.
Size—The smaller the better.
Colour—In the grey variety,—bill, legs, and plumage the same as in the Rouen.
 ,, In the white variety,—bill bright, clear, unspotted yellow. Plumage pure white.
Legs—Bright orange.

Points in Call Ducks.

Smallness of Size	5
Bill and Stop of the Forehead	2
Symmetry and Compactness of Shape	3
Colour of Plumage	3
Condition	2
	—
	15
	—

Disqualifications in Grey Call Ducks.

White ring on the neck of the duck; white flight feathers in either sex.

Disqualifications in White Call Ducks.

Coloured feathers in any part of the plumage; bills of any colour except yellow.

GEESE.

TOULOUSE.

Carriage—Tall and erect; bodies nearly touching the ground.
Colour—Breast and body, light grey; back, dark grey; neck, darker grey than back; wings and belly, shading off to white, though but little white visible.
Bill—Pale flesh colour.
Legs and Feet—Deep orange, inclined to red.

EMBDEN.

Plumage—Uniformly pure white.
Bill—Flesh colour.
Legs and Feet—Orange.

Points in Geese.

Size and Weight	6
Symmetry	4
Colour	3
Condition	2
	—
	15
	—

INDEX.

A.	PAGE		PAGE
Aldrovandus on Paduan fowls	171	Brown, Mr. C., on Spanish fowls	105
" on Silk fowls	221	Brown-red Game	126
Andalusians	120	Buenos Ayres ducks	306
Apoplexy in fowls	322	Bumble foot in fowls	333
Audubon on the Cayuga duck	308	Burnham, Mr. G. P., on the origin of Brahmas	55
Aylesbury ducks	305	C.	
B.		Call-ducks	309
Baird, Professor Spencer, on the wild turkey	269	Caponizing	94
Ballance, Mr. Charles, on Malays	75, 79	Caprikukullo	226
Bantams	240	Cayuga or large black ducks	308
" black	247	Chalybeate for fowls	16
" Cochin or Pekin	251	Chamois Polish fowls	185
" feather-legged	249	Chickens, management of	32, 88
" Game	248	Chittagongs	81
" Gold and Silver-laced	241	Chitteprats	147
" Japanese	252	Clift, Mr., on white Dorkings	99
" Nankin	253	Cobbold, Dr. Spencer, on the cause of gapes	326
" Sebright	241	Cochins	37
" white	247	Cochin Bantams	251
Barn-door fowls	235	Cochins, black	44
Barn-yard duck	311	" buff, Mr. Hewitt, on the characteristics of	41
Begum Pilly gaguzes	239	" cross-bred, as table fowls	50
Bement, Mr. C., on Cayuga duck	308	" grouse-coloured	43
Birehen Game	131	" first introduction into England	37
Black-red Game	125	" partridge	43
Blumenbach on the skulls of crested fowls	173	" silver-cinnamon	43
Bolton Greys	147	" value as market and table fowls	43
Bond, Mr., on Spanish fowls	103, 114	" white	44
Borelli on the skulls of crested fowls	173	Cock-fighting	140
Brahmas	55	Cold in fowls	324
" characteristics of dark and light	66	Coles, Mr., on Andalusians	120
" history of introduction into England	55	Columbian fowls	121
" value as table fowls	72	Columella on Roman fowls	82
Breed, definition of a pure breed	64	Consumption in fowls	330
Breeding in-and-in	79	Coops for fattening	90
Brent, Mr. B. P., on many-spurred Game fowls	72	Coq à Duvet	223
" on pencilled Hamburgs	147	" Nègre	223
Broken bones in fowls	324	" à plumes frisées	226
Bronchitis in fowls	325	" wallikikilli	230
Brook, Rev. A. G., on the management of Ham- burghs	163	Corals	147
" on Malays	79	Cramming as practised in France	212
		Cramming fowls	93
		Cramp in fowls	333

	PAGE		PAGE
Creels or Creoles	147	Game Bantams	248
Crevecoeurs	209, 217	„ fowls	123
Crested duck	311	„ fowls, many-spurred	135
Crook, Mr., on Spanish fowls	107	Gapes	326
Crop-bound fowls	323	Geese	312
Custard for chickens	88	„ Chinese	316
		„ Grey-lag	314
D.		„ Sebastopol	316
Darwin, Mr. C., on the origin of the domestic duck	296	Geyelin, Mr., exposure of the de Sora Noax	196
„ on the origin of the domestic fowl	256	„ on French poultry breeding	191, 211
Diarrhœa in fowls	324	Ghondooks	191
Diseases of poultry	322	Gould, Mr., on the Mexican turkey	269
Dorkings, coloured	82	Gout in fowls	333
„ cuckoo	97	Grain, value of different kinds as food	12
„ silver-grey	83	Grigs, described by Willoughby	240
„ white	99	Guelders	219
Douglas, Mr. J., on breeding Dorkings	86	Guinea-fowls	288
„ „ Game fowls	125		
Dubbing Game fowls	139	II.	
Ducks	297	Hamburghs, black	158
Duckwing Game	127	„ pencilled	146
Dumpies	233	„ spangled	154
		Hen-cocks	131
E.		Hen-feathered Pheasant fowl	156
Early broods, to obtain	19	Henny Game fowls	131
Earth as a deodorizer in poultry houses	9	Hewitt, Mr. E., on black and white Bantams	247
East Indian ducks	306	„ Buenos Ayres ducks	307
Egg organs, diseases of	330	„ characteristics of buff Cochins	41, 46
Eggs, best mode of packing for travelling	31	„ characteristics of Dorkings	84
„ modes of preserving	30	„ on Dumpies	233
„ sex of, not to be distinguished	111	„ on courage of Game fowls	136
„ sterile, to distinguish	21	„ on Frizzled fowls	229
„ structure and development of	25	„ on hybrids between pheasants and fowls	164
Elgar, Mr., on cuckoo Dorkings	97	„ on Malays	75
Emu fowls	225	„ on Pea-fowls	285
Every-day layers	147	„ on pencilled Hamburghs	150
		„ on Polish fowls	177, 183
F.		„ on the Rouen duck	304
Fattening-coops	90	„ on rumpless fowls	231
„ fowls, methods followed in England	90	„ on characteristics of Sebright Bantams	241
„ methods followed in France	211, 215	„ on Silk fowls	222
Feather-legged Bantams	249	„ on Spanish fowls	104, 106
Feeding, general principles of	11	„ on the capture of wild ducks	301
Flack, Capt., on the wild turkey	265	„ on white geese	315, 320
Fountain, best mode of constructing	15	Hooked-billed duck	310
French fowls	193	Horner, Dr. F. R., on Polish fowls	172, 184
Frizzled fowls	226	„ on the origin of the Sebright Bantam	241
		„ on the sounds in incubated eggs	27
G.		Hornby, Admiral, on Spanish fowls	110, 113
Gallus Æneus	257	Horse-flesh as food for fowls	194
„ Bankiva	257	Houdans	203, 217
„ ferrugineus	257	Hybrids between pheasants and fowls	164
„ furcatus	257		
„ giganteus	73, 236, 257	I.	
„ Lanatus	223	In-and-in breeding	79
„ Morio	223	Incubators	22
„ Sonneratii	257	India, domestic fowls of	236
„ Stanleyi	257	Indian Game fowls	73
„ Temminckii	257	Inflammation of stomach in fowls	324

	PAGE		PAGE
J.			
Japanese Bantams	252	Perches, form and arrangement of	2, 6
Jerdon, Mr., description of wild Pea-fowl	279	Pencilled Hamburgs	146
„ on the wild goose	314	Pheasant Malays	81
Johnson and Wingfield's, Messrs., errors respecting jungle fowls	255	Pheasant fowls	154
Johnston, Mr. C. S., on horse-fed poultry	193	Pile Game	128
Jones, Mr. P., on the value of Brahmas	73	Pip in fowls	330
„ on Polish fowls	175, 178	Polish fowls	171
Jungle fowls	255	„ black-crested white	186
K.			
Kulm fowl	236	„ rumpless	191
L.			
Labrador ducks	306	„ spangled	178
La Bresse fowls	213	„ white	185
La Fleche fowls	211, 218	Poulardes	96
Lavergne, M. de, on the value of poultry in France	201	Poultry houses	1, 4, 5, 8
Layard, Mr. E. L., on frizzled fowls	226	R.	
„ on rumpless fowls	230	Red-caps	234
Leg-weakness in fowls	332	Restorative for chicken	16
Lice in fowls	334	Rheumatism in fowls	333
M.			
Macgillivray on the wild duck	296	Roan ducks	304
„ on the wild goose'	313	Rouen ducks	304
Maggots for chickens	33	Roup	325
Malays	75	Rumpless fowls	230
Manx fowls	220	S.	
Martin, Mr. W. C. L., description of the Guinea-fowl	290	Sacc, M. le Docteur, on management of turkeys	276
Meleagris Americana	265	Sclater, Dr. P. L., on the black-winged Pea-fowls	284
„ Gallopavo	265	Sclerostoma syngamus	326, 328
„ Mexicana	265, 269	Scrofula in fowls	330
„ Ocellata	265, 271	Sebastopol geese	316
Millet Robinet, Mdle., on caponizing	94	Sebright Bantams	241
„ on fattening	211	Serai Täook	188
Minorcas	119	Sex of eggs, impossibility of distinguishing the	111
Mooneys	154	Shanghai, fowls at	39
N.			
Numida meleagris	288	Shanghai, see Cochins
„ ptiloryncha	288	Silk fowls	221
O.			
Origin of domesticated varieties	255	Silky Cochins	225
“Ornithognomon” on wild jungle fowls	257	Sitting hens, management of	17
„ on wild Pea-fowls	280	Soft eggs, causes of	331
P.			
Paralysis in fowls	323	Sora, M. de, fictitious account of establishment	193
Paris fat poultry show	200	Spangled Hamburgs	154
Pavo cristatus	279	Spanish fowls	102
„ muticus	279, 282	„ white	120
„ nigripennis	279, 284	St. John, Mr., on the wild duck	301
Pea-fowl	279	Sturgeon, Mr., description of Cochins	38, 40
Pekin Bantams	251	Sultan fowls	188
Penguin ducks	310	Surrey fowls	83
		Sussex fowls	83
		T.	
		Taylor, Mr. J., on Andalusians	121
		Teebay, Mr. R., on Brahmas	66, 72
		„ on Mooneys and Pheasant fowls	155
		Tegetmeier, Mr. W. B., on the characteristics of a pure breed	64
		„ on fattening Dorkings	89
		„ on hen-feathered Game cocks	131
		„ description of a cock-fight	141
		„ on skulls of crested fowls	174
		„ on feeding Aylesbury ducks	306
		„ on the origin of the Sebright Bantam	241
		„ the diseases of fowls	322

	PAGE		PAGE
Temminck on Silk fowls	222	Willoughby on frizzled fowls	226
Trotter, Mr., on the management of turkeys	272	,, on Silk fowls	221
,, on the management of geese	318	,, on Bantams	240
Turkey, the	265	White comb in fowls	334
V.			
Vertigo in fowls	323	Y.	
W.			
Waterton, Mr. C., on the change of plumage in the wild drake	297	Yarrell on the origin of the domestic goose	312, 315
Watts, Miss. E., on the merits of Brahmas	73	Z.	
,, on Sultan fowls	188	Zurhorst, Mr. F. W., characteristics of white Cochins	44
		,, on Sultans	189
		,, on the French breeds of fowls	217

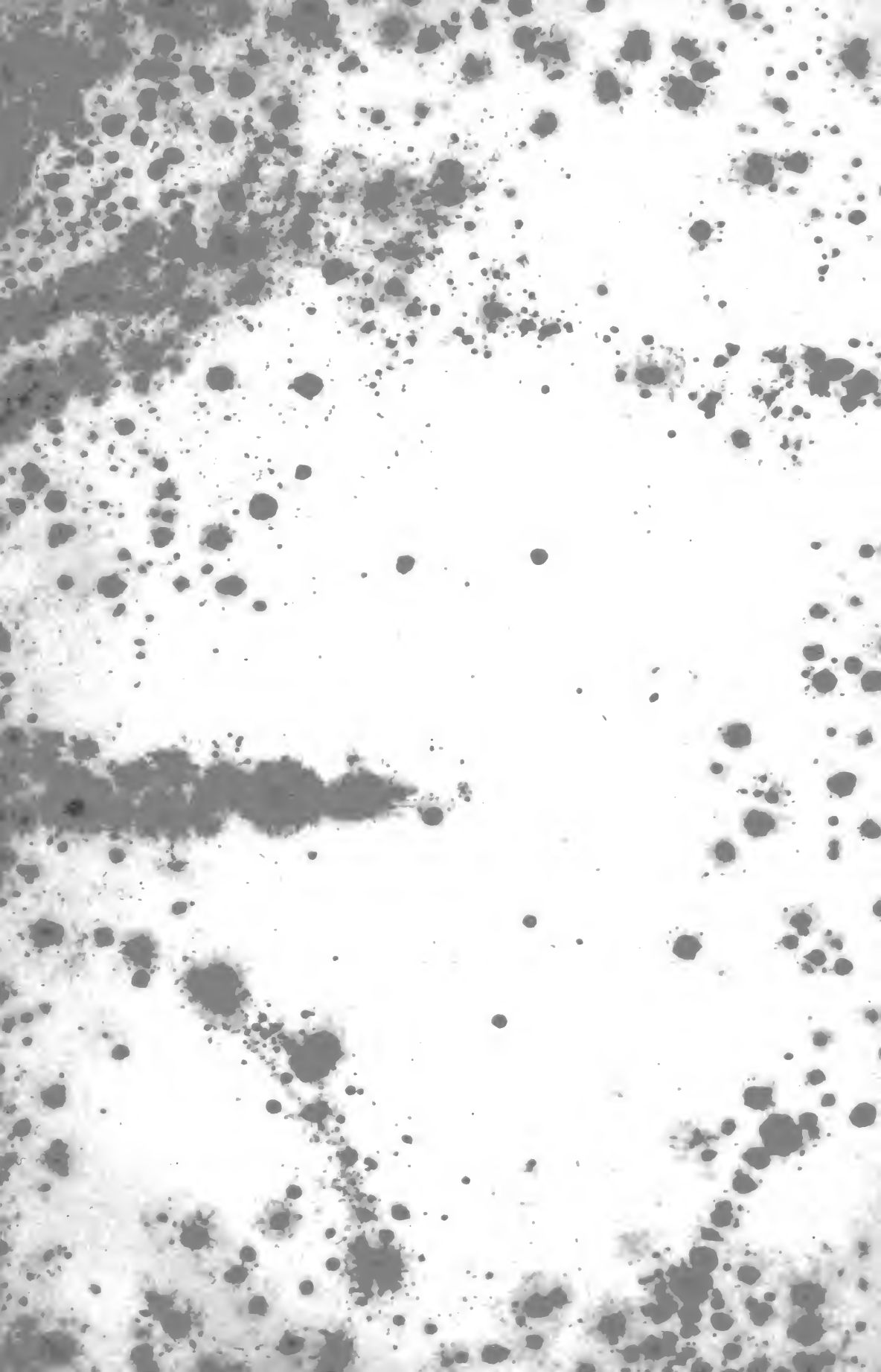

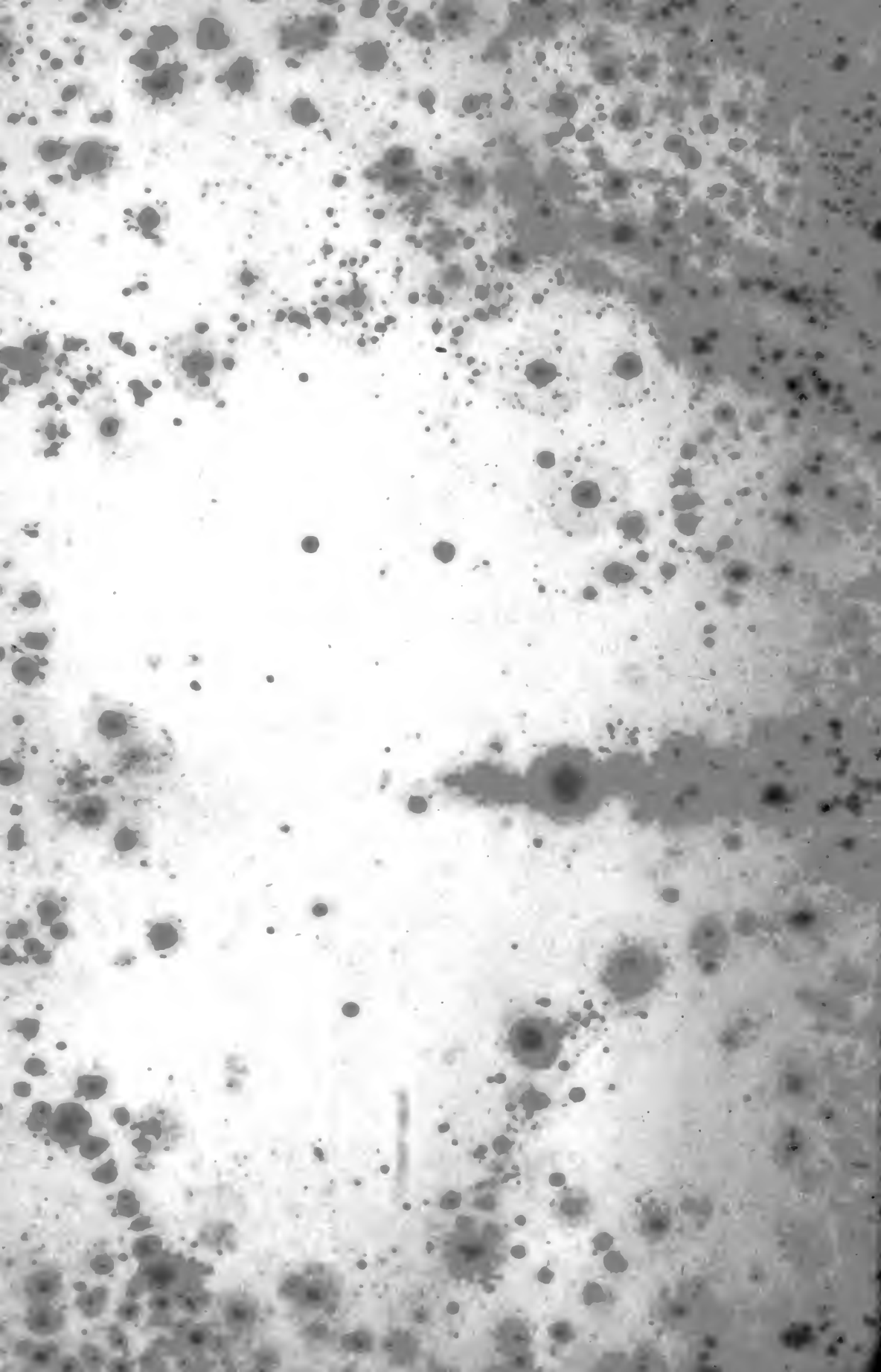

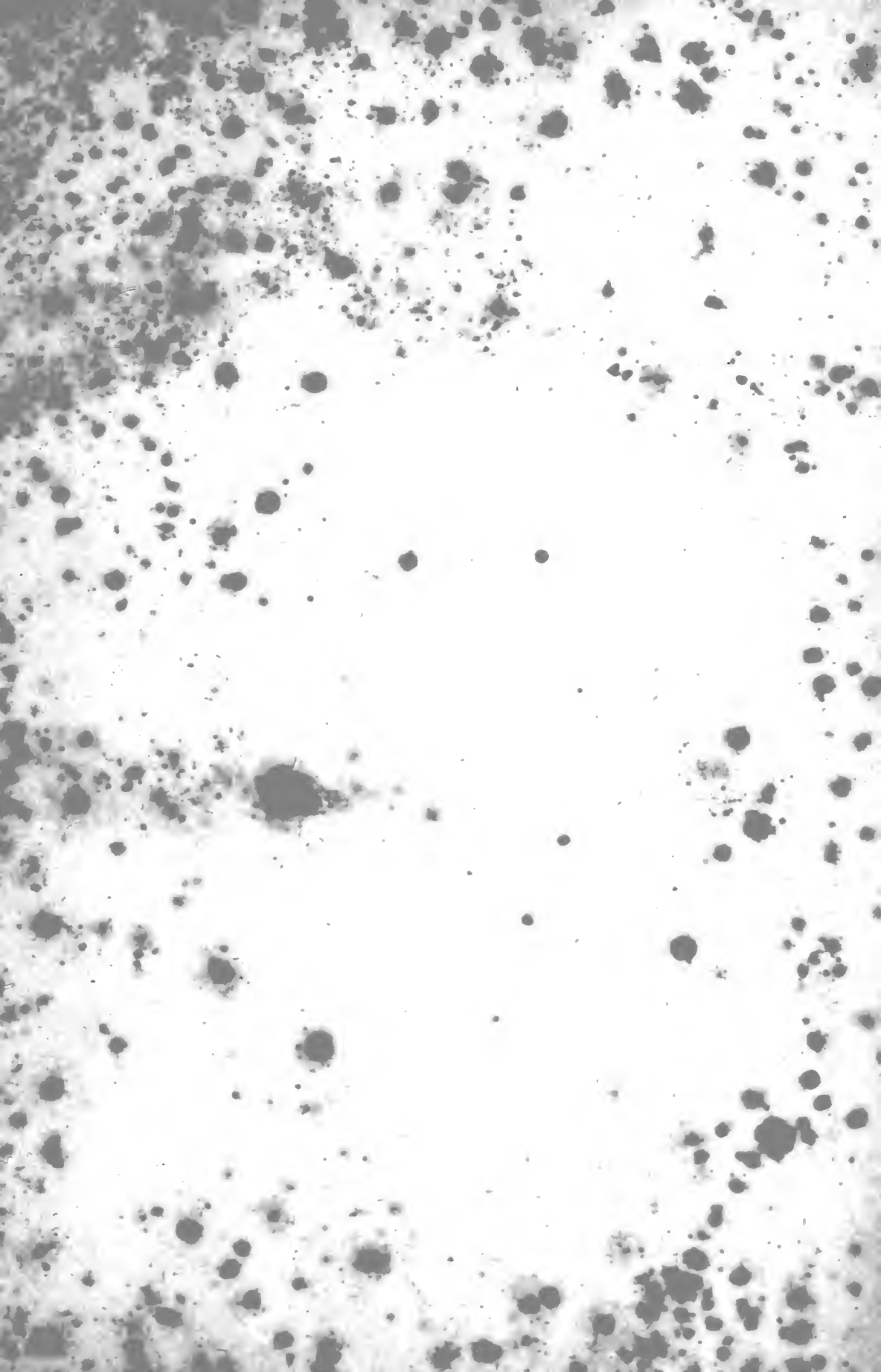

AGRICULTURE
FORESTRY
LIBRARY



