

UC-NRLF



\$B 33 909

Poultry Craft

GIFT OF

F. L. Griffin

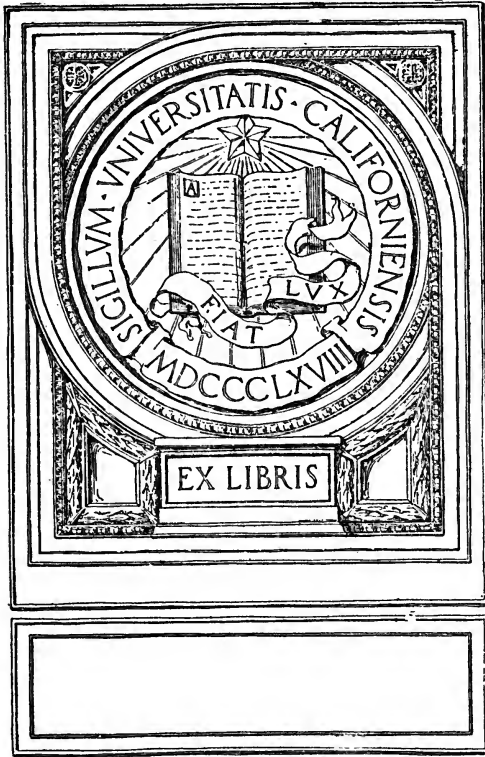

EX LIBRIS

LIBRARY
FREDERICK L. GRIFFIN

© 1917
KIEFER & HENNING

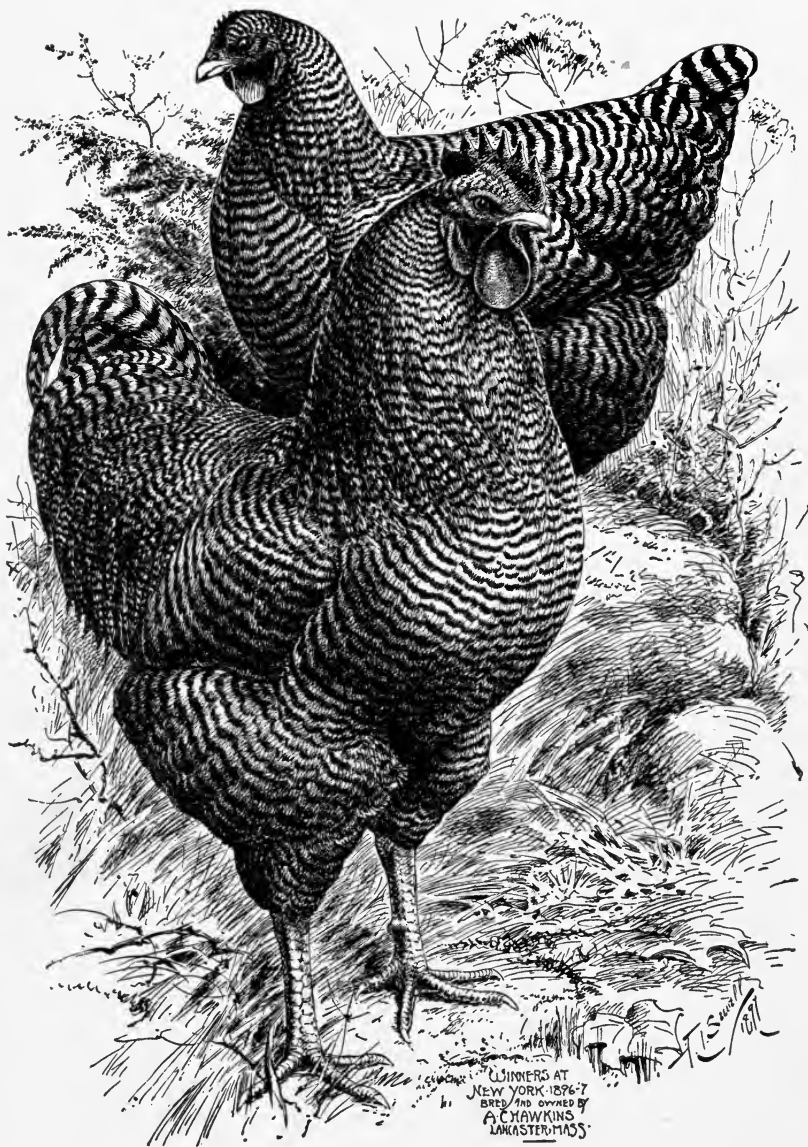

BARRED PLYMOUTH ROCKS.

The Original General Purpose Breed, and the First Breed Made in America.

BY COURTESY OF A. C. HAWKINS.

FARM-POULTRY SERIES. NO. 5.

POULTRY-CRAFT.

A TEXT-BOOK FOR POULTRY KEEPERS.

FULLY ILLUSTRATED.

WHAT TO DO.

HOW TO DO IT.

BY

JOHN H. ROBINSON.

Completely Indexed for the Convenience of Busy People.

PUBLISHED BY
FARM-POULTRY PUBLISHING CO., BOSTON, MASS.
1904.

LIBRARY OF
FREDERICK L. GRIFFEY

SF 477 /
R 54

Gift
F. L. Griffin

9/7/21

Copyright, 1899,

BY

I. S. JOHNSON & CO.,

BOSTON, MASS.

TO THE
LIBRARY OF THE
MUSEUM OF COMPARATIVE ZOOLOGY
HARVARD UNIVERSITY
CAMBRIDGE, MASS.

Press of S. G. Robinson, 267 Atlantic Ave., Boston.

LIBRARY OF THE
MUSEUM OF COMPARATIVE ZOOLOGY
HARVARD UNIVERSITY
CAMBRIDGE, MASS.

P R E F A C E .

For those who want to know about poultry keeping, for those who wish to learn poultry keeping, and for poultry keepers who cannot always remember things they know at the moment they happen to need them, this book was written: to the small army of writers of permanent and current poultry literature, nearly every one of whom has in some way contributed to its making, it is respectfully dedicated.

The growing interest in fine fowls and the widening of the field of profitable operations in poultry culture have created a demand for a book which will give to one who thinks of engaging in poultry keeping an intelligent understanding of its possibilities and probabilities, whether for pleasure or profit, and a comprehensive idea of the ways and means of production and distribution of this country's enormous crops of poultry and eggs. Following this demand comes another, for a book of elementary instruction in all branches of poultry keeping. Separate books to meet these demands would be, in large part, duplicates, because before beginning it is necessary one should know, though superficially, many things which afterward he must learn thoroughly if his work with poultry is to be successful. With systematic, logical arrangement of the text, and with a complete carefully prepared index it was possible to make a book of information for inquirers and instruction for beginners, also a book for ready reference on poultry topics. There has long been pressing need of such a book. For years the publishers have had frequent calls for a book to which a poultry keeper could go for information on any and every matter, and find it in an instant.

It is, perhaps, superfluous to say of such a book that it is essentially a compilation. This is measurably true even of the matter not credited to other writers. My work has been to condense and put in convenient form information which by reason of its abundance and the multitude of its sources has not been available for those who needed it most,—to give, as it were, the composite opinion of sometimes conflicting authorities on each matter treated. That conclusions should invariably be correct and every estimate unaffected by his personal opinion, would be more than a writer could hope, and more than a reader ought to expect; but, as I have endeavored to state each subject

treated fairly, honestly, and (as I believe) in accordance with the best interests of those for whom the book is written, I feel confident that no one of them will find in it statements that will mislead, or advice which he will follow to his disadvantage and loss.

The matter of credits for borrowed matter in a book composed as this is, requires particular mention. Only a few of the more important direct quotations are fully credited. Matter which has been adapted, condensed, and rearranged in harmony with the scheme of the work, is credited generally to the author only — the name of the paper or book from which it is taken not being added, because in a number of cases a short paragraph is compiled from statements of the same writer in several different books and papers, and to give each paper credit would have detracted too much from the simplicity of statement sought. Food rations taken from contributions of writers describing the methods of others, are credited to the persons using the rations.

For the rest, while acknowledging a general indebtedness to the poultry literature of the day, I would here acknowledge special indebtedness to the books and paper consulted most: — to *Poultry Culture*, Felch; *The Practical Poultry Keeper*, Wright; *Poultry*, McFetridge; *Incubation and Its Natural Laws*, Cyphers; *The Practical Poultry Grower*, Myrick; *Broilers for Profit*, and *A Living From Poultry*, Boyer; *Duck Culture*, Rankin; *Farm-Poultry Doctor*, Sanborn; to files of *Farm-Poultry* for the views of a great number of writers on almost every topic treated; to the *Reliable Poultry Journal* for matter pertaining to many subjects, but especially for information relating to the mating of thoroughbred fowls, and to turkeys, ducks, and geese; to the *American Fancier*, *Poultry Monthly*, *American Poultry Journal*, and *Poultry Herald* for many valuable suggestions; and to various national and state bulletins for information regarding foods and feeding.

The illustrations not otherwise credited were made for this book, or are reproduced from *Farm-Poultry*.

JOHN H. ROBINSON.

Waltham, Mass., 1899.

CONTENTS.

CHAPTER I.

POULTRY KEEPING AND POULTRY KEEPERS	-	-	-	-	7
-------------------------------------	---	---	---	---	---

CHAPTER II.

LOCATION — SITUATION	-	-	-	-	17
----------------------	---	---	---	---	----

CHAPTER III.

POULTRY HOUSES AND YARDS	-	-	-	-	23
--------------------------	---	---	---	---	----

CHAPTER IV.

POULTRY FIXTURES	-	-	-	-	53
------------------	---	---	---	---	----

CHAPTER V.

FOWLS DESCRIBED	-	-	-	-	61
-----------------	---	---	---	---	----

CHAPTER VI.

CHOOSING A VARIETY — BUYING STOCK	-	-	-	-	81
-----------------------------------	---	---	---	---	----

CHAPTER VII.

FOODS AND FEEDING	-	-	-	-	92
-------------------	---	---	---	---	----

CHAPTER VIII.

SCIENCE IN POULTRY FEEDING	-	-	-	-	109
----------------------------	---	---	---	---	-----

POULTRY-CRAFT.

CHAPTER I.

Poultry Keeping and Poultry Keepers.

1. Classification.—Business and pleasure are often combined in poultry keeping. This, and the complexity of the relations of the different branches of the industry, makes a classification of poultry keepers difficult. The outline presented here will, however, give the reader at a glance an idea of the relations of the different branches to each other, and of the principal combinations which occur.

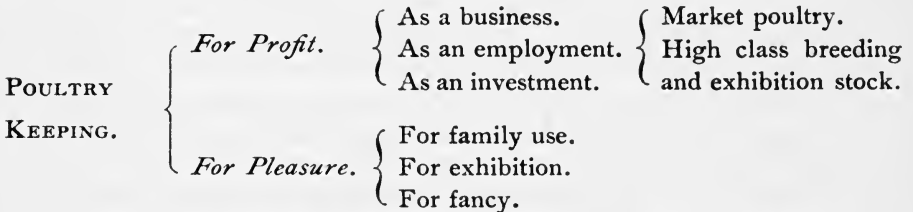

2. Poultry Keeping as a Business.—This is poultry keeping as carried on by those who invest in it their capital and give it their time. The last mentioned condition distinguishes it from poultry keeping as an investment. Only in recent years has poultry keeping taken a place among recognized industries. The bulk of the country's enormous crop of poultry products comes from many hundreds of thousands of small producers. The number of poultry keepers making a living from the production of eggs and poultry is very small compared with the great number of small producers, but is rapidly increasing. To make the business successful a man must be an expert in the management of fowls, and must have good business judgment, with enough business training to make him accurate, methodical and prompt in his work and dealings. Many of the successful poultrymen of today were not experts when they began. Many learned business methods as their establishments grew. One who would make such examples of success the excuse for giving his capital, time and labor to an occupation he does not understand should remember that, when these men began, the problem of profitably keeping fowls in large numbers had not been solved, and successes with fowls in small numbers were mostly matters of chance. With rare exceptions they began with very limited capital. Lack of capital made it

quite impossible for their plants to grow beyond their ability to manage them. These men were pioneers in poultrying. The records of their progress are found in modern books on poultry, and in the files of the poultry journals. The results of their work may be seen in up-to-date poultry plants, and in the methods in use on such plants. The beginner of today finds sources of information and instruction to which his predecessors could not resort. He would be foolish, indeed, not to take advantage of such opportunities. *A man should learn the business before engaging in it on his own account.* Books and papers are within the reach of all. Practical instruction is more difficult to obtain—the difficulty being to some extent due to the fact that those who want instruction are so often unwilling to pay for it. Too many have thought a few months of their unskilled labor on a poultry farm would amply pay for time devoted to teaching them, for losses and damages due to their inexperience, and for the opportunity to draw at will on the accumulated knowledge of an expert poultryman. Those qualified to give instruction will not take pupils on such terms.

3. How Much Income.—Business Risks.—A living from poultry is surer to one who makes it his business than are profits from poultry to one investing in a poultry plant to be conducted by another. To give a definite idea of the amount to be annually realized from a plant of any given capacity, would be as impossible as to estimate in advance the annual profits in any business. People do make such estimates; but, how often are they right? It may be said, however, that except in a few rare instances, poultry keeping is not a lucrative business. Very few poultrymen are making more than a good living. Whether one can make a living from poultry, will depend on his fitness for the business, his judgment in choosing a location, and on the effects of influences by which, like every other business, this is affected. The poultry keeper is subject to all ordinary business risks. Those who go into this business should not fail to consider; that,

Success, the success that brings a living from poultry, means work—hand work, head work, and hard work. This is a condition not peculiar to poultry keeping; that,

Prices fluctuate, and profits vary accordingly; and that,

Causes beyond a man's control may cause his failure, or delay his success.

Those points need to be emphasized, because of some serious misconceptions which have arisen in regard to poultry keeping as compared with other businesses. It is unique in some respects, but not in being exempt from influences affecting business in general.

4. More About Profits.—More detailed statements concerning profits can now be given. Having read the last paragraph, no one need misunderstand the statements in this. Experienced poultrymen know about what they can count on under favorable circumstances. They also know how to make

the best of unfavorable circumstances. If they see loss coming in one place they make special efforts to offset it by securing extra profit in another. The average profit on eggs, at market prices, is one dollar per year per hen. This is what a skilled poultryman considers a safe figure. One dollar a head is approximately what skill secures from large flocks—for eggs alone. The best authority on broilers places the average profit per bird at not over twenty cents. On eggs for hatching, sold at two dollars a sitting, the profit will rarely exceed a dollar a sitting; often will not reach that figure. A breeder whose trade is in stock birds selling at one to five dollars per head, will average about two dollars per bird. If he has managed his stock right nearly all of this will be profit. It is easily seen that at these figures there is no "big money" in the business. In fact, in market poultry alone one does not find it easy to make a living unless his plant is large and much of the work is done by cheap labor. The profitable combination for a small plant is one which with a stock of thoroughbred poultry averaging for the year three hundred to four hundred hens, yields a profit of \$300 to \$400 for market eggs; about \$100 for eggs for hatching; \$150 to \$200 for market poultry; and \$200 to \$300 for breeding stock—in all \$750 to \$1,000. Something like this is what a fairly skillful poultryman without special reputation as a breeder of high class stock may expect from a plant on which he can do all the work, and which, if he constructs the buildings himself, will cost anywhere from \$1,000 to \$1,500 in addition to the cost of the land and the first cost of the stock. It is not safe to figure an income on the basis of the large profits sometimes reported for single flocks, or for a season's work under exceptionally favorable conditions. Nor is it wise for a beginner to count on profits as large as those of the more successful poultryman, which are often much greater than the figures here given. When one begins to see the big prices and big profits coming his way it is time enough to begin estimates with the big figures.

Though not to be used as bases of estimates, the prices of high class stock merit attention as showing what is possible when ability to breed good stock, and reputation as a breeder, have been acquired. Prices for eggs range from \$3 to \$5 per sitting; \$5, \$10, \$15, are quite common prices for fowls for breeding and for the smaller exhibitions. Prices of birds "fit" for the larger shows range from the figures given up to \$25, \$35, \$50, \$100. Single birds have been sold as high as \$250. Just how much of these various amounts is profit, it is not possible to even approximately average, for this class of breeders never make their accounts public as market poultry men so often do. The expenses of exhibiting and advertising are considerable. Yet the proportion of profit to price is greater than when sales are made at small figures, and, generally, the higher the price the greater the proportion of profit. To the limited number who can get these prices, poultry keeping, whether an exclusive business, a side issue, or a recreation, is very profitable. The beginner, while disregarding them in his present calculations, may look forward to them as the rewards of special ability.

5. Is There Danger of Overdoing the Business?—The United States imports annually about one million dozens of eggs. This fact is often cited to show that the business is in no danger of being overdone. It is assumed that, as long as eggs are imported the domestic supply must be inadequate. A comparison of the amount of imports with the total home product, shows that this assumption is a fallacy. A million dozen is less than one-tenth of one per cent of the (estimated) total annual egg crop. In effect the nation produces all the poultry and eggs it uses, and consumes all it produces. During a considerable portion of each year the markets are glutted with stock of inferior quality. The kind of poultry keeping which produces such stock is already overdone. On the other hand, the demand for stock of superior quality is in advance of the supply, and there is every reason to believe that this condition will continue for a long time. A poultryman making a wise choice of location with reference to this demand, and producing articles of the grade it calls for, need have no fears of overstocking his market. In the trade in breeding and exhibition stock, conditions are different. Successful sales depend much on reputation and skillful advertising. Lacking these, breeders often fail to sell really fine stock of varieties in good demand.

6. Comparison of the Different Branches of Poultry Keeping.—Attention has already been called to the advisability of combining branches of the industry. As a matter of fact, poultry keepers doing an exclusive business cannot keep to one branch. A living from poultry requires combinations, and some branches depend on others. The egg farmer who rears his layers, as nearly all do, has large quantities of poultry to sell. The broiler farmer who produces on his own plant the eggs for his incubators—and this is the only way to get reliable eggs in quantity—has eggs to sell during a part of the year. Besides, broiler raising is a business for a season. It has never been made profitable on a large scale as an exclusive business. In connection with an egg farm, or as winter employment for those whose regular occupation leaves them idle in winter, it pays. Sales of eggs for hatching are limited to a few months in the spring. The bulk of the trade in breeding stock is done in the first three months of the year. Expenses keep steadily on through every twelvemonth. So it comes about that, though one may start business intending to confine himself to a single branch, he is obliged to make a combination like that suggested in ¶4, in order to handle his stock to best advantage and have a regular income. He may give relatively more or less attention to the various branches than is suggested there, but that combination, in some proportions, is the one to which a poultry business, large or small, inevitably tends.

7. Poultry Keeping as an Adjunct of Another Business.—The greater number of those deriving a considerable income from poultry keeping conduct it as an adjunct of another business, as farming, fruit growing,

gardening, dairying. The reasons for this are similar to those which lead to diversified farming. It is often found that a stock of poultry can be handled, in connection with some other occupation, with greater profit than would come from giving more attention to the other occupation, or from an exclusive poultry business. A good example is where a milkman finds his income too small for his living, and the demand for milk not great enough to justify increasing his herd. In such a case a man of judgment combines with his established business another, profits from which will round out his income. Poultry keeping is well adapted to such combinations, and is well worth the consideration of anyone so situated that he must combine two occupations. It should be added that such combinations ought to be made only in the extreme cases; that is, where the business is so small that one can give personal supervision to every part of it; or where, as on some large stock or fruit farms, there is an opportunity to keep fowls on ground used partly for other purposes, and on a scale large enough to warrant the employment of a skillful poultryman. Attempts to combine poultry keeping with other occupations when there is more work than the proprietor can personally do or oversee, and less than will make it worth while to engage an expert poultryman, almost uniformly result in losses.

8. Poultry Keeping as an Employment.—As an employment poultry keeping offers, to both skilled and unskilled labor, opportunities similar to those afforded in other lines of animal and plant culture. Wages for skilled labor vary, depending on the size of the plant, the ability of the man, the amount of responsibility assumed. A fair average of the wages paid poultrymen who attend to and partially supervise the work on a plant, but have nothing to do with financial management, is \$60 a month, or \$40 and board. Those who take complete management receive more—sometimes much more. Unskilled laborers on poultry plants are paid, in any given locality, about the same as farm and dairy hands in that locality. One wishing to estimate the *ins* and *outs* of poultry keeping as an employment, may consider it in this way: In a year an expert poultryman will earn about the same as the average mechanic of the same relative degree of skill. He will have steadier work at a lower rate of wages, will work longer hours, have less leisure. There will be little danger of his being at any time long out of work. The demand for expert poultrymen is likely to continue in excess of the supply.

9. The Poultry Business as an Investment.—Many people are looking to poultry keeping as an investment for surplus funds. The profitableness of such ventures will depend—first, on the judgment shown in selecting a location, determining what branches of the business are to be followed, and choosing a manager; next, though to a less extent than in the case of one whose all is invested in his business, on the influence of the conditions mentioned in ¶3. The man who has capital to back him can weather

adverse storms which swamp the poultryman of limited means. No one should invest money in a poultry plant until he has enough general knowledge of the business to enable him to make an intelligent estimate of the advantages and disadvantages of different locations, considered with reference to the branch of the business to be followed; of the qualifications of applicants for the position of manager; and, of the probabilities of his investment proving satisfactory. Most of those who have made losing investments in poultry have put their money out first, and acquired the knowledge that would have enabled them to invest wisely afterward. Many have been led into rash ventures in poultry keeping by the belief that large profits would be realized from the outset. It usually requires several years to thoroughly equip a poultry plant and place it on a paying basis. The history of most large plants shows that this has been the case, even when abundance of capital was at command. The man with capital makes large plans, which it requires time to carry out. Practical poultry keeping as an investment must be on a large scale; on a small scale, even a prosperous business could not be expected to do more than make a living for the manager and his assistants. Some of the most profitable plants of this class combine market and "fancy" poultry breeding. There are numerous instances of persons of means breeding fowls both for pleasure and as an investment, taking a very active interest in the stock, but leaving the actual management of the poultry in the hands of a manager. An investment of this kind is probably the most profitable that can be made. A study of the subject of poultry culture as set forth in this book will give a good basis of knowledge of the matters one needs to know before investing. Further information should be sought in current poultry journals. The information derived from these sources should be supplemented by careful examinations of up-to-date poultry plants, and a study of the conditions, both general and local, of production and consumption of poultry products.

10. How to Learn Poultry Keeping. — Poultry keeping must be learned just as any other trade is learned — preferably by going to work for a poultryman. Opportunities to learn in this way are not numerous. One finding such an opportunity must expect to begin as an apprentice or unskilled laborer. If diligent and faithful to his employer's interests, he will soon be advanced to work involving responsibility and giving practice in poultry management. While thus engaged he should be a close student of poultry literature, and should make the most of every opportunity to visit the plants and observe the methods of other poultrymen. This course is recommended even for those who have the capital to put into a small plant. Two years of practical work under a competent instructor are worth more to anyone than a period twice as long passed in gaining experience independently. A very important consequence of taking this course is that the man with small capital risks none of it, (and may even add to what he had), before learning how to use it to best advantage. After two years of practical work, a bright man of

mature mind ought to be in a position to know how to make best use of his capital, and also how to make a business which he managed alone or with a little cheap help, pay expenses almost from the start. The course just outlined is that by which expert knowledge and skill are obtained at least expense. It is not always practicable. There are other ways. A partnership may be formed with an expert poultryman who thus becomes his partner's instructor. An expert may be engaged for a time as manager and adviser. After such arrangements as these the next best plan is to begin keeping fowls in a small way, increasing the flock as ability to manage larger numbers profitably is developed. In this one needs to be careful not to overstep the limits his experience places to profitable work. To those who have the capital the temptation to go too fast is very strong. Until one has thoroughly mastered the elements of poultry keeping, until he is "fit" to succeed, he ought to proceed as cautiously as if he had no capital but the profit from the flock.*

11. Beginning With Small Capital.—Without Capital.—A poultry business may be started on a very small capital, practically without capital, if one has other occupation which, while furnishing the means of living, leaves him time to properly care for his fowls. By careful management the gradually increasing income from the flock may be added to the capital until the operations are large enough to make poultrying the principal thing. The combination of circumstances favoring a growth of this kind is rare. For those who think of beginning in this way the caution: *Be sure of your ground before making any move involving expense*, needs to be repeated. In small beginnings of poultry keeping as an adjunct to dairying, gardening, etc., it is not usually difficult to make time to care for the poultry, and the poultry plant can easily make rapid growth. The important things in developing a plant begun in a small way, are:

Keep no more stock than can be given proper care.

Keep out of debt.

12. Poultry for Pleasure.—For Family Use.—When fowls are kept for a definite purpose, and that not the profit to be made from them, it is not wrong to say they are kept for pleasure. This statement holds good even when fowls primarily kept for pleasure afford some profit. Most "family" hens are kept for pleasure, the pleasure their owners get from producing their

* NOTE.—Those who, wishing to learn poultry keeping, do not meet favorable opportunities, are advised that it is in their power to materially assist the movement for special instruction in poultry keeping at the agricultural colleges. This they can do by showing those in charge of these institutions that a strong demand for such instruction exists. At the Rhode Island State Agricultural College a course of study in poultry culture was given in January, 1898. This was designed as the initial step in a movement to make instruction in poultry keeping a feature of the work of that college. Other states will follow the example of Rhode Island as fast as those interested make it clear that a course, once established, will be sustained.

own eggs and poultry, and having these articles strictly and reliably fresh. In many instances family hens are from a dollars and cents standpoint unprofitable. It costs more to produce the eggs and poultry used than it would to buy them—a state of affairs for which there is no good excuse, for very little skill in handling fowls is required to make such small flocks pay their way. Not many families are so situated that, wishing to keep a few fowls, they are unable to do so. As will be shown in succeeding chapters, there are breeds of fowls specially suited to close quarters. A little plot of ground, a little poultry house, a little flock of hens, and a little love for domestic animals, make a combination which will give the poor man in a city, at trifling cost, luxuries for which his rich neighbor is glad to pay liberally.

13. Poultry for Pleasure.—For Exhibition.—For Fancy.—

Though not the most important, this is the most prominent feature of poultry interests. It is so intimately associated with the business of breeding high class stock that it would puzzle many breeders to say whether they were in poultry for fancy or for business. The majority of fanciers, however, are in “the fancy” for pleasure. *Pleasure* means to one, winning at the exhibitions; to another, the possession of fine fowls; to others, the acquisition of knowledge of the laws of breeding and the exercise of skill in mating for special results. Many keep fowls simply that they may have some restful pursuit not in line with their regular work, to occupy mind and body in leisure hours. Poultry fancying is more than a mere amusement; it is a useful amusement, a recreation having a recognized moral and educational value—and, aside from the fact that it makes “business” for many people, the poultry fancy has an industrial influence in giving the initial impetus in the development of economic poultry interests. Everywhere general improvement in common fowls, and increased profits from fowls, have followed the introduction of “fancy” fowls. The claim of some fanciers that this improvement was due to the diffusion of the blood of their high class stock, can be only partially admitted. Undoubtedly new blood has done much, but practical illustrations of the advantages of good care and systematic breeding for a definite purpose, have done more. The “fancy’s” best contribution to the growth of industrial poultry culture has been along the line of suggestive teaching. The real usefulness of pleasurable poultry keeping needs to be better and more universally understood. It is equally desirable that fanciers should not make public extravagant estimates of the benefits they confer, and that the true value and dignity of poultry keeping for pleasure should be recognized by all poultrymen and by the general public.

14. Women as Poultry Keepers.—

The bulk of the supply of poultry products comes from flocks cared for principally by women. On farms the care of the fowls is usually left to the farmer’s wife or daughter. In towns the absence of the men from home during the working hours leaves the care of the poultry mostly to the women, even when the men take an interest in it.

Whether women are better fitted than men to care for fowls, is a question needing no discussion. The whole subject may be briefly summed up in the statement: Some people (men and women) make capable poultry keepers, and some do not. There are quite large poultry plants conducted by women. As a rule, poultry keeping on a scale to make a living for a family, is beyond a woman's strength. Still, a woman who can press some male member of the family into service to do occasional heavy jobs about the hen house, can handle several hundred hens, and make the profit from them a substantial part of the family income. Many women have been very successful as fanciers and breeders of high class stock; but that branch of poultry culture seems to have less attraction for women than for men. Under the conditions noted at the beginning of this paragraph, women assume the care of poultry through force of circumstances and custom. When they take up poultry keeping from choice it is usually from one or more of these reasons: that they may have poultry supplies for home use; or, profits from the hens for pin money; or, regular light outdoor work as a diversion from the monotony of housework. Thus with them poultry keeping is really an adjunct to their occupation as housewives. It is notable that, keeping fowls in this way, women are generally wiser than men, in keeping flocks no larger than they can care for, and in keeping out of debts on the hens' account. To this extent, if no further, women as a class are the better poultry keepers, and more often make small flocks pay.

15. Poultry Keeping for Invalids.—Invalids are attracted to poultry keeping as an occupation, thinking it one of the least laborious of outdoor callings. The all-important thing for invalids engaging in it is to keep the work within the limits of their strength. Unless this is done the work will do them more harm than good. There is little really heavy work about a poultry yard, but the work requires constant attention, is confining, and to some becomes monotonous. An invalid whose sickness is such, in kind or degree, that he could not give the fowls regular attention in all kinds of weather, ought not to engage in poultry keeping expecting to make it profitable. Nor should one unable by reason of physical disability to make a living at another occupation, hope to make one from this. The work on a poultry plant large enough to make a living for a family is not "light" work in any other sense than that it does not require great muscular exertion. It keeps an active man very busy through days of long hours. Invalids engaging in poultry keeping on a scale suited to their strength may make something—some part of a living, from it, while the work builds them up physically, and can be gradually developed into an extensive business yielding a living income.

16. Poultry Keeping for Children.—A child,—especially a boy—having reached such age that he can be trusted, (with a little oversight from some older person), to care for a flock of fowls, ought to be encouraged to take an interest in domestic fowls, and, if circumstances permit, should be given a

few hens. It is a well established fact, that an interest, as care-taker, in domestic animals, and particularly the smaller and weaker ones, helps to develop a humane character. Fowls can be kept where other domestic animals could not. The ownership of a flock of fowls gives the young poultryman opportunities to take some very practical lessons, but if the work is to have the best effect, parents should take interest enough in it and in poultry in general to fit them to act as guides and advisers.



CHAPTER II.

Location.—Situation.

17. Definitions of Terms.—By the *location* of a poultry plant, is meant its position with reference to markets, and as determined or affected by the general climatic conditions. *Situation* means the position of a poultry house, or the buildings constituting a poultry plant, as determined by those things which directly affect fowls, or increase or diminish the labor of caring for them. Every poultry keeper has to consider matters relating to the availability of particular *sites* for poultry houses. The question of *location* hardly needs attention from those not keeping poultry for profit.

18. Locating for Business.—Poultry Farming.—A good location is as necessary in poultry keeping as in any business. A wrong choice of location has caused many a failure. The first, and most important thing to consider is the matter of *markets*. This subject must be examined from several points of view. One whose capital is large enough to equip a large plant, and keep it running until it pays expenses, should decide first what branch, or branches, of the business are to be followed, and make choice of a location accordingly. If market poultrying is to be a specialty, he must locate within quick shipping distance of a large city, and should give the preference to a district containing many towns and small cities. In sections where a large part of the population is engaged in agriculture, the supply of eggs and poultry is, during the greater part of the year, in excess of the demand. As nearly all of this supply comes from small flocks kept under such conditions that the profits from each flock, in effect, equal the proceeds of the flock, agricultural districts are usually poor locations for special market poultry farming. It might be said that, except in the most densely populated districts, in proportion as poultry keeping is made profitable by the general farmers in any locality it becomes unprofitable to the specialist. This has been well illustrated, within a few years, in the state of Kansas, where, in the face of a notable increase of the poultry product of the state, it was reported that many of the large plants near Kansas City had gone out of business, unable to continue at a profit in competition with the farmers, whose output of eggs and poultry was year after year increasing in quantity and improving in quality. The poultry farmer must have a nearby market, where strictly fresh eggs and fancy dressed poultry will always command a premium. Thus it is seen that in this country the exclusive poultry farm can be made profitable only in limited areas. To be as exact as possible—it

would be unwise to attempt that line of business beyond quick shipping distance of a large city on the Atlantic or Pacific coast, except in mining districts or near large health or pleasure resorts. In all the large coast cities, and in adjacent cities and towns, the demand for the best poultry products is large enough to remove risk of an overstocked market. In the other places ranked as good locations for poultry farming, the demand is more limited, and is sometimes active but a short season each year. Those considering such locations should thoroughly investigate the conditions of local demand and supply before making a decision.

After the question of a market for products, comes the question of the market for the purchase of supplies. This is of little importance in most localities favorable to poultry farming. Yet there are places where, while prices of eggs and poultry are so high as to tempt investment, a plant would prove unprofitable because of the high prices of supplies and the uncertainty of being able to procure them as needed. Before passing this question one should give it as much attention as will prevent a mistake from neglect of it.

It will be found that in the case under consideration the matter of climate is unimportant, because there is no place in the areas adapted to large poultry farming where the climate is unfavorable. The poultry keeper may need to consider it for himself. As for the fowls, he will find that they quickly become acclimated anywhere.

19. Locating for Business.—Breeding High Class Stock.—In this case greater latitude of choice is possible. It is desirable, though not absolutely necessary, that all conditions should be favorable to the best development of fowls. It is, in reality, more a question of situation than of location. Situation is of greater importance. The business in fine poultry and eggs is done principally through the postoffice and the express companies. Wherever located, a breeder having good stock of a variety in demand, and properly advertising it, will not often find his location a handicap. It has been, and still is, true that in some sections high class poultry sells more freely than elsewhere. The interest in thoroughbred fowls spreads so rapidly that communities which a few years ago bought little high priced stock, now buy a great deal. Wherever anyone undertakes the breeding of thoroughbred stock, whether for market or fancy, the interest awakened by his venture gradually creates a demand. As it takes some time to establish a trade in this line, the beginner being always at a great disadvantage in competition with breeders of established reputation, it is often a good move on his part to locate where he will for a few years have little competition for the local trade, which, though small, must at first be his principal dependence.

20. Location.—The Combination of Market and Fancy Poultry.—These two branches have so far been treated separately. In actual practice they are oftenest combined. Many poultry farmers use thoroughbred stock

exclusively. Some have quite a large trade in the best grades of their stock, sold for breeding purposes at several times the prices for market poultry. A few whose principal interest is in practical poultry are successful exhibitors of standard fowls, and sell exhibition birds and birds for breeding exhibition stock at high prices. On the other hand, every extensive breeder of high class stock has to dispose of a considerable part of what he produces at market prices. As long as this can be regarded as a by-product, he need not consider the market for it when selecting a location; but, if he must depend on it for a considerable part of his income, it may be best to give market advantages great weight when deciding where to locate. The combination of exhibition, breeding and market stock, is generally the best for those in the business for profit; especially is this true in the case of a plant located outside of the areas adapted to exclusive market poultrying. Such a combination can be made profitable near almost any large town.

21. Buying Land for a Poultry Plant.—The plant should not be built on rented ground. The rent adds to current expenses. Removal means either the sacrifice of the greater part of the value of the improvements, or expense, and damage to buildings in moving. The amount of land needed for the plant depends as much on the system of housing used as on the number of fowls kept. A large stock kept on the colony plan will occupy a good sized farm. On most of the large plants the fowls are yarded, being housed in long sectional houses. This system brings a large stock upon a small area. From five to ten acres is ordinarily enough land for a poultryman. As far as suitability for poultry keeping goes, the soil need not be fertile. Often a tract admirably adapted to poultry keeping is quite worthless for other purposes. Nevertheless, it is not good policy to buy land that cannot be improved to make comfortable, pleasant home surroundings, for the poultryman's home and place of business are necessarily together. Another thing to consider in buying is, that poultry keeping and fruit raising or gardening are often profitably combined, and it is worth while to take account of the possibility of its proving advisable at some future time to make such a combination. Buying a place on time, is as bad a mistake as renting land. The beginner's profits cannot stand such drains.

22. Adapting Business to Location.—For nearly all who begin in a small way with the expectation of making a living, ultimately, from poultry—and for, perhaps, all who make poultrying an adjunct of another occupation, the question of location is, from the first, a closed question. They already have a site which they think might be used to advantage for poultry. The statements in the preceding paragraphs will suggest to such persons the branches of the business best suited to their circumstances. Thus, on a site suitable for poultry within one of the areas where exclusive market poultry keeping can always be made profitable, eggs and poultry will from

the start furnish the quickest, surest, most evenly distributed returns; while in other localities it will be better to make such a combination as the demands of the market, the amount of capital on hand, and the skill of the poultryman allow. At least a slight general acquaintance with the whole subject of poultry keeping is necessary before one can decide what to do and what not to do in any given case.

23. Situation.—General Remarks.—Though certain surroundings are more agreeable to fowls than others, and under favoring conditions they are handled at least cost for food and labor, there is nothing in the nature of domestic fowls to prevent their being thrifty and profitable in circumstances quite the reverse of those most agreeable. Indeed, it is coming to be well understood that, within reasonable limits, restraints on the natural tendencies of fowls are beneficial. Like all domestic animals, they can be accustomed to great changes of habit, as well as of climate. The breeds of fowls differ somewhat in adaptability to artificial conditions; but as a rule the welfare of the fowls depends more on the poultryman than on the nature of fowls or of their surroundings. Farms and large village lots furnish the best opportunities for poultry keeping. Fowls can be kept and, even, a few thrifty young reared on narrow city lots—sometimes in very close quarters. It has often been said that fowls can be kept wherever human beings can live. While not literally true, this statement is not far wrong—if its application is limited to fowls kept for pleasure. Whether fowls are kept for pleasure or profit, successful management consists in rightly balancing natural and artificial conditions, providing by art those things in which the situation is deficient, or when that is not possible, devising ways of compensating for nature's defects. Just here is where it is found that ways of caring for fowls for best results differ in different localities and situations. The needs of fowls do not vary; the resources of places do. In different places poultry keepers have to do different things to supply the same needs. This is all there is in the oft-repeated assertions that fowls cannot be handled in the west as in the east, in the south as in the north, in mountain countries as at the sea level. The poultryman in unusual circumstances must study his surroundings and their effects upon fowls, and vary treatment as he finds nature doing more or less in any direction; and he ought always to follow the general rules for caring for fowls under ordinary conditions, until by careful study of his situation he sees reason for making change in treatment or diet. He should not do extraordinary things without knowing *why* he does them. Unusual circumstances demand thoughtfulness and prudence, not eccentricity. The poultry keeper for pleasure can go as far as he likes in making good the natural defects of a site. One in business for profit needs the advantage of a situation with few defects. It is folly to undertake keeping fowls for profit on a site where the "outs" are so many that the making of a living is rendered unnecessarily laborious.

24. Situation.—Soils.—A sandy soil suits poultry best. A wet, heavy, clay soil is most unsuitable. A soil containing much alkali is to be avoided because of its bad effect on the skin and plumage. A sandy site is, in general, well drained, and is easily kept clean. Droppings falling on a porous sandy soil are at once deodorized by absorption of their liquids, the remaining solids are disintegrated and carried below the surface by rains; falling on clayey soil they form a crust on the surface, making it very foul. Between light sandy and heavy clay soils is a wide range and many kinds of soil, varying in suitability for poultry keeping as they approach to or depart from these extremes. Fowls are oftenest kept on medium soils, these being most common. Such soils are easily purified by occasionally spading or plowing the yards. Sometimes the same end is gained, and a regular supply of green food furnished the fowls, by an arrangement of alternate yards, which makes it possible to grow a green crop in one yard while the fowls are confined to the other. When fowls are kept on rather heavy soil, the surface should be graded to secure complete surface drainage, and as much as possible of the runs should be in permanent grass. It is advised to remove the earth in the house floors, replacing it with a few inches of sand or sandy loam over a bed of gravel. Made ground composed largely of rubbish, is most unsuitable for poultry. In hot damp weather the decomposed matter breeds disease germs, which cause epidemics. This condition persists for a long time after the making of the ground, and accounts for many mysterious outbreaks of disease. Ground of this kind is common in large cities and their suburbs. Poultry keepers should avoid it on their own account, and because of its possible effect on fowls.

25. Situation.—Drainage.—The site of a poultry house or plant should always be well drained. Water standing at the surface attracts filth. On ill-drained land one has bad footing while doing his work, and the work is consequently much harder. These are the things which first become apparent in a poorly drained place. More important than either, is the fact that the poultry house cannot be kept as dry as it should; any degree of continuous dampness is objectionable. A high site, hill, knoll, or slope is usually recommended, but ground level or in a depression is not altogether objectionable if well drained.

26. Situation.—Exposure.—Shelter.—Poultrymen prefer a site on a gentle slope facing south or southeast. It is desirable that the buildings receive the sunlight as long as possible on winter days, and be sheltered from cold winds. The lack of such natural advantage in a situation may be made good, as far as shelter from wind goes, by growing evergreens where they will serve as wind-breaks. A house placed where it does not get the sunlight is unfit for fowls. If it gets the sun for only a few hours daily it may be used. In such case it is most satisfactory to keep fowls only for family use,

replacing the stock each year. Stock birds soon degenerate away from the sun, and young stock makes but sickly growth without sunlight. In placing poultry buildings the most should be made of every natural advantage of the situation. Convenience to his house and for doing the work are points for the poultryman to consider, but ought never to be allowed to influence him when they conflict with matters essential to the welfare of the flock.



CHAPTER III.

Poultry Houses and Yards.

27. General Remarks.—It is important that fowls be properly housed. This can be accomplished without using elaborate or expensive buildings. A poultry house should be free from drafts, so constructed that the inner temperature will vary slowly with fluctuations in the weather. The windows should be so placed that the sun will shine into the house for a few hours daily,—in winter, the longer the better. These things, and a suitable situation, are essential. The permanent lack of any one of them invariably affects the health of the fowls, sooner or later bringing disease and loss. A house furnishing the conditions essential to the welfare of its tenants may be unsightly to the eye, inconvenient for the attendant, yet cannot be regarded as unsuitable for fowls. A person is sometimes so situated that if he would have a few fowls he must make shift to keep them in quarters not specially suited to poultry keeping. If the essential conditions specified can be secured, the fowls can do very well. If the conditions named cannot be secured, it is better not to try to keep poultry. The inconveniences incident to caring for fowls in makeshift and poorly planned houses are matters of small moment to the amateur who gives his fowls but little of his time. To one who keeps fowls on an increasing scale such inconveniences soon become costly annoyances, and the buildings, often, must be completely remodeled. It is therefore always best for a poultryman to consider carefully before beginning to build or to make alterations; and a beginner, particularly, should make himself so familiar with the principles of poultry house construction, the different styles of houses, the methods of platting poultry plants, that whatever the scale of his future operations, each building erected may be built to stand many years without alteration and without other repairs than those made necessary by the ordinary wear and tear of weather and daily use. Nearly all the designs given in this chapter are modeled after, or adapted from, plans used and approved by practical poultrymen. (The exceptions merit attention, embodying as they do some ideas approved by the experience of poultry keepers, though not yet tested). The buildings described have been selected as furnishing typical examples of different styles of poultry houses. As a comparison of the plans will show, many of the details may be applied in any or all the various styles of houses. The greatest possible variety has been introduced in the minor details of the drawings, to avoid an unnecessary multiplication of illustrations. Having selected the style of house which suits him best, anyone intelligent enough to build a poultry house can adapt to it such minor features of other

designs as his situation and his means demand. All the drawings show neat buildings, devoid of ornament. In nearly all the plans given it is designed that the ground floor shall be of earth, which is by all odds the best floor material, and should be used whenever that is practicable.

28. **A Cheap House for a Town Lot.**—In Fig. 1 is shown a simple

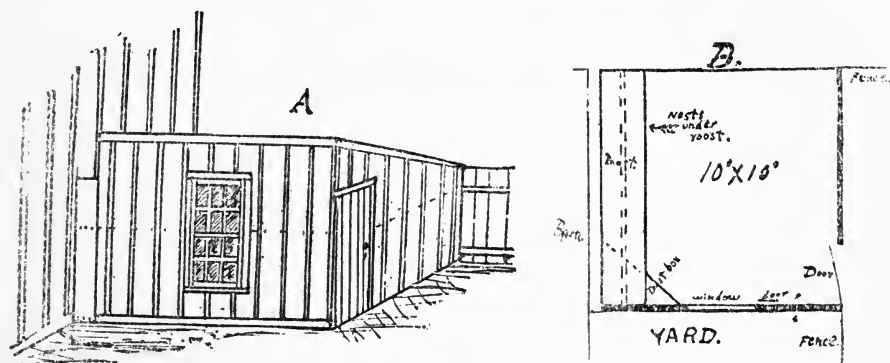

Fig. 1. A Cheap Small Poultry House. A.—perspective. B.—ground plan.

design for a cheap city poultry house, 10 ft. square on the ground; height in front 8 ft., in rear 5 ft. Such a house will accommodate from ten to twenty hens, according to breed, amount of yard room, etc. The only openings are the door in the east side, the window in the south front, and the small door giving access to the yard; the front and east side to be boarded up and down with boards 1 ft. wide, dressed on one side; the joints between the boards to be covered with battens. The west and north sides and the roof are of boards covered with building paper.

Materials.*

The frame of the building requires nine pieces of 2 x 3 scantling, 10 ft. long; four of these are for the sills, two for plates, (front and rear), two to go parallel to sills and half way up north and west sides, and one from which to cut the short horizontal pieces for middle of front and top of door opening; three pieces 2 x 3 scantling 16 ft. long, from which to cut four studs, each 8 ft. long for front corners and sides of window opening, two 5 ft. studs for rear corners, and two 3 ft. pieces for top and bottom of window opening; one piece of 2 x 3 scantling 14 ft. long from which to cut one 7 ft. stud to go at north side of door opening, and the horizontal piece for the middle of the east

*NOTE.—To give full lists of materials and suggestions in regard to using them for all the plans given in this chapter, is out of the question. Lists of materials are, however, given in a number of cases. In connection with this simple plan full instructions are given as to lumber used, what to order, and how to cut it to advantage. Occasional suggestions will be given as seems expedient with other plans. In all designs the construction is very simple; and having learned how to proceed in one case, the reader can easily apply his knowledge to any other.

side; three pieces 2 x 4 scantling 22 ft. long, from which to cut six rafters each about 10 ft. 6 in. long. (If it is desired they may be 11 ft. long, and allowed to project over front and rear walls. Sometimes dimension lumber over 20 ft. in length costs more per 1000 ft. than when in lengths of 20 ft. or less. When that is the case it is as well to use 12 ft. stuff for the rafters; or, for strictest economy in construction, to make the building six inches narrower than in the plan, and use 10 ft. stuff for rafters). Boards 16 ft. long should be used for the front and east side. For the long boards on the front 16 ft. boards cut in two are used without waste. A little ingenuity in cutting will leave very little waste in using 16 ft. stuff for the east side. Ten 16 ft. boards 1 ft. wide will be needed. The boards for the back, west side and roof, which are to be covered with building paper, may be either rough lumber or surfaced on one side. They need not be of equal widths, though of course there is no objection to that, except on the score of cost, selected widths often costing more. For the west side boards 16 ft. long should be used, and for the roof and rear wall boards 10 ft. long. Three boards of matched flooring, each 12 ft. long, will be needed for the door. There is needed then :

Dimension lumber:—

9 pieces 2 x 3 in. scantling 10 ft. long;	3 pieces 2 x 3 in. scantling 16 ft. long;
1 piece 2 x 3 in. scantling 14 ft. long;	3 pieces 2 x 4 in. scantling 22 ft. long;
	109 sq. ft.

Rough sheathing:—

160 sq. ft. boards 10 ft. long;	70 sq. ft. boards 10 ft. long	230 sq. ft.
Ten 12 in. boards 16 ft. long		160 sq. ft.
Three 6 in. matched boards 12 ft. long		18 sq. ft.
Battens, 2 in. wide, aggregating in length		160 ft.
Roofing paper, to cover		240 sq. ft.
Two 6-light sash, 10 x 14 glass; one lock; one pair hinges; nails, screws, etc.		

This estimate allows for lumber to be used in casing window and door, strips to finish at top and bottom of front and east side, stuff for nests, drop boards, roost and dust box. Prices of material vary in different places. Any lumber dealer can give exact cost of such a bill of goods in a few minutes.

29. Single House with Scratching Shed Underneath. — Fig. 2

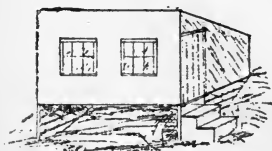

Fig. 2. House with Scratching Shed underneath.

shows a style of single house very often used when the site is so far from level that a space must be left below the floor, or a considerable fill made. The space below the floor of the house is used as a scratching shed, the height of the shed being proportionate to the slope of the hill and the width of the house. The higher sheds are usually so arranged that in rough weather the front can be

at least partially closed. The low sheds are usually left unprotected, but it is a good idea to have movable fronts to use to exclude snow in blizzard weather. The plan is sometimes used with long sectional houses.

30. Other Houses for Single Flocks.— All the poultry houses described in the next paragraph can, of course, be used for single flocks in yards. Single sections of most of the continuous houses described are used for one-pen houses, and these should be examined in connection with the plans just given.

31. The Colony Plan.— The objectionable features of this plan are such that it is not often deliberately adopted for a large poultry plant. Of late, some of those who have used the system seem inclined to discard it. The stronghold of the system of colonizing fowls in small families with free range has been the belief that fowls could be made more profitable on free range than in yards; that they would be healthier, more vigorous, more prolific, and the eggs would be more fertile. As this belief breaks down, people become more and more unwilling to put up with the defects of the system for the sake of its advantages, real and supposed. Briefly stated, the principal advantages of the colony plan are :

Cheaper houses.

No expense for fences.

The fowls can pick a part of their living.

The scrupulous attention to cleanliness and the care to provide regular supplies of animal and vegetable foods, which are a part of the routine work of most poultry farms, can be relaxed on a farm run on the colony plan.

The marked disadvantages of the system are :

Increased cost of labor in caring for fowls. Taking one thing and one season with another, the cost of labor is greater, notwithstanding the slight saving on some items of labor.

Greater difficulty in maintaining strict regularity in feeding. In bad weather, just when the most careful attention should be given them, the hens are often unavoidably neglected.

The difficulty of controlling disease in flocks allowed to mingle.

The modification of the colony plan, which places detached houses in large yards, loses the advantage of no cost for fences. Cost of fencing is so much increased that rarely is any saving effected in the total cost of housing and yarding. In snowy, stormy weather the difficulty of caring for the fowls is increased, rather than diminished.

The colony plan, with or without yards, loses its most serious objections in a mild climate. There are many special cases where it might be preferable to any other, particularly when poultry keeping is a side issue on a fruit or general farm, the hens being kept as insect exterminators, gleaners and scavengers. For the ordinary farm stock of poultry the colony plan, on a small scale, is often the best. The illustrations given show models of cheap and serviceable buildings in use on some of the farms run on the colony plan.

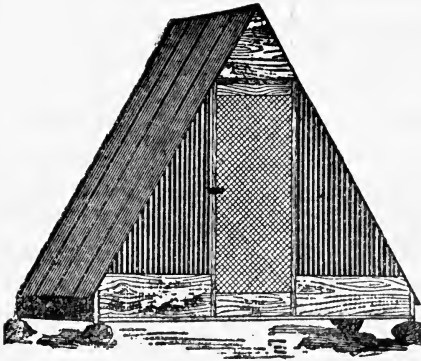

Fig. 3. A Tent Shaped Colony Plan House.

The tent shaped house, Fig. 3, is 8 ft. square on the ground, and 8 ft. to the apex. The floor is of plank, and the front open slat work. Houses like this are used upon a large New Hampshire farm. The capacity of the house is 12 hens; the cost, (in N. H.), about \$8.

Fig. 4 shows a house used on a Rhode Island farm. Ground dimensions are 8 x 12 ft.; height, to the eaves, 6 ft.; to the apex, 8 ft. The walls are of rough boards, battened. The roof is shingled. About twenty hens can be housed in it.

In Fig. 5 is shown a house of brick, or stone, with roof of boards covered with tarred felt. The drawing was made from a building on a Rhode Island farm. Each house of this style was 11 x 14 ft. on the ground; 7 ft. high in front, and 4 ft. high in rear. In each twenty hens were kept; but a house of

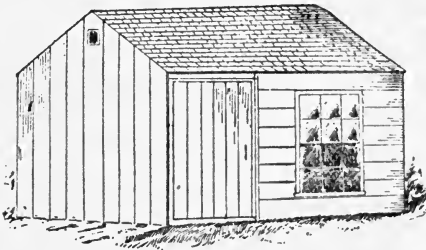

Fig. 4. Colony Plan House.

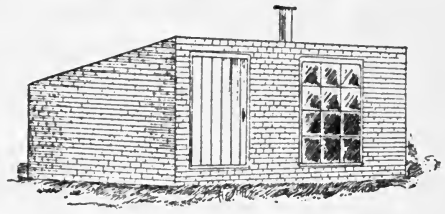

Fig. 5. Brick House — for the Colony Plan.

this size would not be overcrowded with twenty-five to thirty hens of the small or medium sized breeds. If new material must be bought and building labor hired, it does not generally pay to use brick and stone. If such materials are at hand, or can be procured at trifling cost, and the building done by the poultryman, there is no economy in rejecting them. Facility in making use of available building materials, foods, etc., is one test of a man's ability as a poultryman. Provided the house conforms to the essentials stated in ¶27, the widest latitude may be taken in using materials. Good houses have been log houses, grout houses, adobe houses. Poultry houses have been made with walls and roofs of old railroad ties, the crevices being filled with mud, and

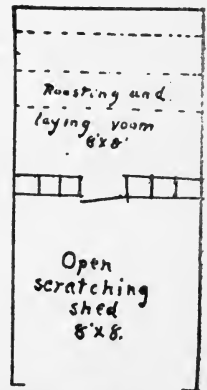
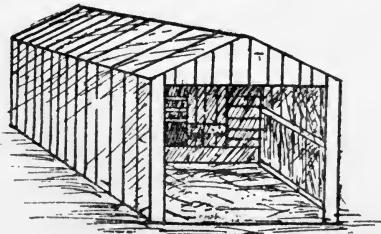

Fig. 6. A Colony Plan Scratching Shed House.

the roofs covered several inches deep with earth. Fig. 6 shows a single house often used with the colony plan. It is usually built without windows, the south front of the shed being always open, and the door between shed and roosting room being closed only in severe weather. Sometimes a slat door is hung inside to admit air, while keeping out night prowlers. The diagram is for a house 8 x 16 ft. on the ground, the floor space equally divided for the close room and the open shed.



Fig. 7. Two-Pen Poultry House.

PP, droppings boards; r r, roosts; N N, nests; D D, large doors; d d, small doors; w w, windows; W, water dish; g g, grit box; s, screen door; F F, fences.

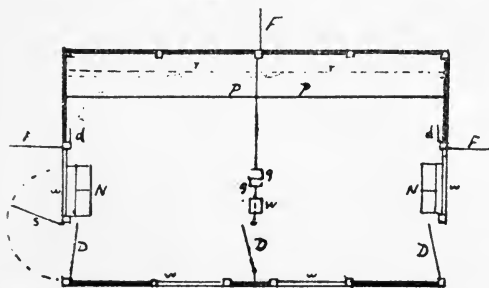

32. A Two-Pen Poultry

House. — Fig. 7 shows a small double poultry house, with yards at sides and to the rear of the house. The ground

dimensions are 10 x 16 ft.; height, at eaves, 6 ft.; at apex, 8 ft. It has shingled roof. The sides are of rough lumber covered with lapped siding.

Materials.

Dimension lumber:—

- 2 pieces 2 x 4 scantling 16 ft. long— for sills;
- 2 pieces 2 x 4 scantling 10 ft. long— for sills;
- 3 pieces 2 x 3 scantling 16 ft. long— for plates and studs;
- 14 pieces 2 x 3 scantling 12 ft. long— for rafters, studs, etc.;
- 1 piece 2 x 3 scantling 14 ft. long— for studs:

163 sq. ft.

16 ft. sheathing 500 sq. ft.

Siding 220 sq. ft.

6 12-inch boards 16 ft. long, dressed on one side, for cornice, casings, etc.

2 thousand shingles; 50 laths; 2 4-panel doors; 2 screen doors; 4 sash 6-light 10 x 14 glass; building paper to cover 500 sq. ft.; 2 pr. loose pin butt hinges; 1 pr. 6 in. T hinges; 1 lock; 1 bolt; nails, screws, etc.

From this bill of lumber enough will be left, after finishing exterior, for inside partition, roosts, droppings boards, nests, dust boxes.

33. Continuous, or Sectional Poultry Houses.—Intensive poultry keeping, many fowls on a small plot of ground, is the practice of most progressive poultrymen. The colony plan reproduces as many times as desired the conditions of the ordinary farm flock. A system of continuous or sectional houses multiplies as often as desired the conditions of the best kept flocks. The colony plan allows but eighty to one hundred hens to the acre. The continuous house system with suitable yards, allows four hundred to five hundred hens to the acre. The failures of the first attempts at intensive poultry keeping were due to the failures of the poultrymen to provide meat food, vegetable food, grit, exercise. With these errors corrected, results soon showed the superiority of the intensive system for those who make poultry keeping a business. The fact that it is the system almost universally adopted, makes superfluous a recital of its advantages further than intimated in describing the colony plan, and to be mentioned in the description of different styles of continuous houses.

34. Continuous House with Connecting Pens.—In a short house, or one containing a few long compartments, passage through the house is

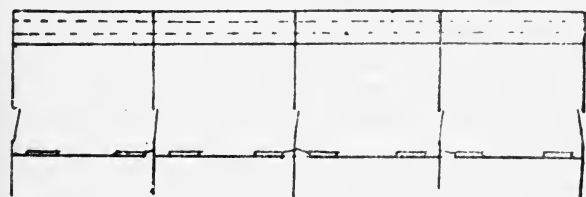
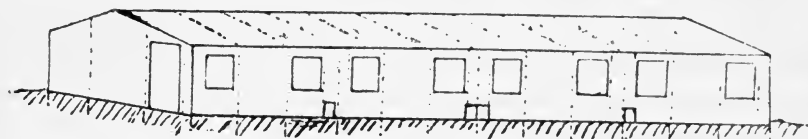

Fig. 8. Cheap Four Pen House. Dotted lines in the perspective indicate positions of studs and rafters; in the ground plan, positions of roosts.

usually from pen to pen.

Fig. 8 illustrates such a house, containing four

pens each 12 ft. square. It is a substantial, low cost house, the construction being the simplest consistent with strength and durability. It is built without sills or plates. The studs are spiked to short cedar posts, placed 4 ft. apart, set 18 in. into the ground, and projecting the same distance above ground; or the studs are used as posts, the end which goes into the ground having been coated with tar. The lower ends of the rafters rest upon the tops of these stud-posts; the upper ends are joined directly, being secured with spikes driven through each into the other, and all rafters except those at the ends being braced as shown in Fig. 9. The dotted lines in the drawing indicate the positions of studs and rafters. Each window opening adjoins a stud on one side; on the other side a short stud, simply nailed to the sheathing, is placed. This short stud extends 6 to 8 in. above the upper edge, and a like distance below the lower



Fig. 9.

edge of the window opening. No scantling are used above or below the opening. The sill of the window is a piece of 6-in. board, projecting an inch beyond the outer surface of the sheathing, and inclined just enough to prevent rain beating under the sash. The distance between studs should equal the width of the sash; the height of the opening should equal the length of the sash. The ends of the sheathing boards, projecting one-half inch or more beyond the studs, make the outside side sash stops. When the sill has been placed as described, and the sash put in, the upper rail of the sash will overlap the edge of the opening. For inside sash stops, strips of lath may be used at sides and on sill, and a stop about one inch square nailed to the top of the sash and to the sheathing. A window put in in this way is wind and water tight. The removal of the sash to fit the house for warm weather, and its replacement on the approach of winter, are the work of but an instant. The studs should be set plumb, and well braced, and the rafters trued and firmly braced until the sheathing is nailed on, and the boards of the partitions in place. Sheathing 12 or 16 ft. long should be used, and in putting it on joints should be broken about every two feet. Such a house can be either shingled or covered with a prepared paper. If not shingled, it can be easily taken down, moved, and set up again as good as at first, except that a part of the covering material might have to be renewed.

35. Continuous House for a Farm Flock. — The style of house just described is well suited for a farm stock when it is desirable to keep the fowls

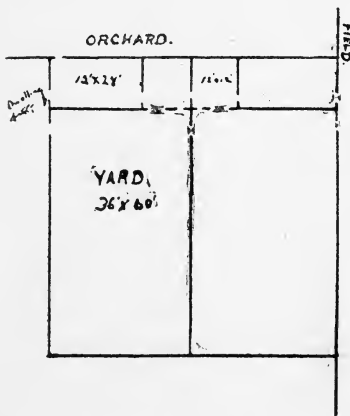

Fig. 10. Four Pen House for a Farm Flock.

in several flocks, and yet have them housed together. The plat shown in Fig. 10 provides for a house 12 x 72 ft., with a pen 12 x 24 ft. in each end, and two pens each 12 x 12 ft. in the middle. In the supposed case for which this plat is made, the hens from the east pen have the run of a field, meadow, or pasture lot; those from the west pen run into an orchard; while the middle pens, each connected with a yard 36 x 60 ft., can be used in season for breeding pens, for fattening pens, or simply in connection with adjacent end pens, giving the two large flocks additional house room. If the field fence is made "hen-tight" for ten rods each way from the house, there will be little danger of the flocks mingling.

36. Continuous House with a Walk. — In Fig. 11 is shown the diagram of a continuous house containing sixteen pens, each reached directly from a walk running the entire length of the building. Each pen is 8 ft. square. The passage is 4 ft. wide. The height of the building is 6 ft. at the eaves, 8 ft. at the peak. Joining the west end of the poultry house is a two-

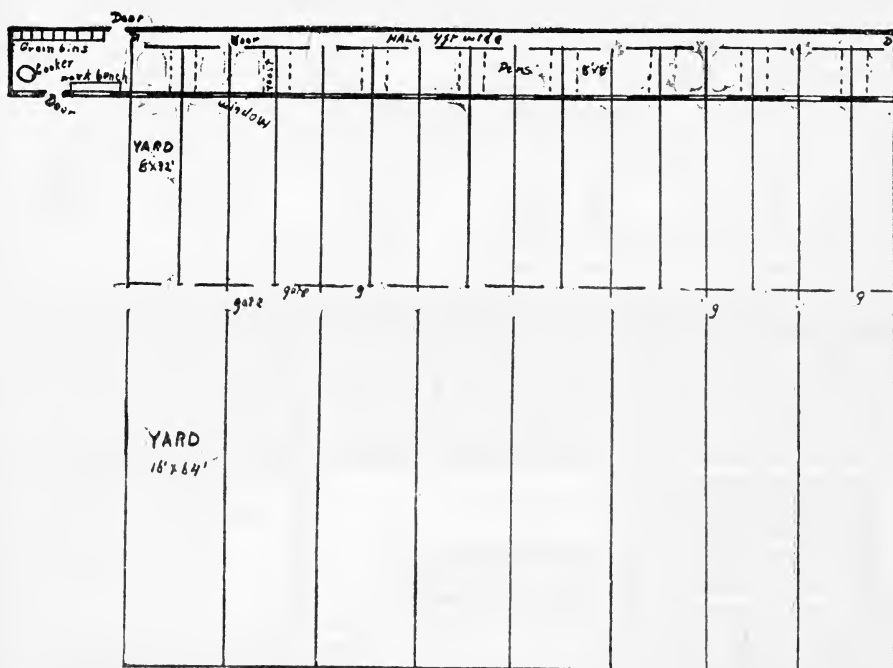

Fig. 11. Continuous House with a Walk.

story building to be used as work shop, cook room and store room. The ground dimensions of this building are 12 x 20 ft. It is 14 ft. high at the eaves, 16 ft. at peak of roof; the first story 8 ft. in the clear. The diagram also shows the plat of yards. The small yards 8 x 32 ft. correspond to the divisions of the house. For every two small yards there is one large yard 16 x 64 ft., to be kept in grass. The capacity of the house is one hundred and sixty to two hundred and forty fowls, with ten to fifteen in each pen.

The frame of the long house may be constructed with sills of 4 x 4 in. stuff; studs, plates and rafters of 2 x 3 in. scantling; studs and rafters being 4 ft. apart at centers, except in front, where the studs should be spaced to come beside window openings. The studs and rafters of the two-story building should be 2 ft. apart, at centers. If

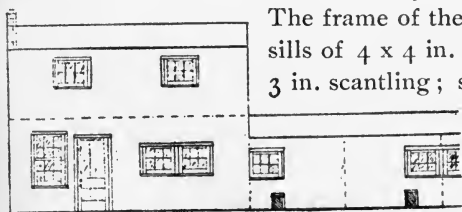

Fig. 12. Elevation of Front of Two Story Building and Part of Long Building in Fig. 11.

a board floor is put in the lower room 2 x 8 in. joists should be used, the same as for the upper floor.

Materials.

Dimension lumber:—

- | | |
|-----------------------------------|-----------------------------------|
| 20 pieces 4 x 4 in., 16 ft. long; | 26 pieces 2 x 3 in., 16 ft. long; |
| 94 pieces 2 x 3 in., 14 ft. long; | 45 pieces 2 x 3 in., 12 ft. long; |
| 2 pieces 2 x 3 in., 20 ft. long; | 24 pieces 2 x 8 in., 12 ft. long; |
| 8 pieces 2 x 2 in., 16 ft. long; | |

2210 sq. ft.

Sheathing, (rough)	5500 sq. ft.
Sheathing, (surfaced for droppings boards)	200 sq. ft.
Matched flooring for floors, doors, grain bins	750 sq. ft.
Building paper, to cover	4500 sq. ft.

2 rolls wire netting 5 ft. wide, 2-inch mesh.

22 6-light sash, 10 x 14 glass; 2 4-panel doors; 2 pr. loose pin butt hinges; 2 pr. 6-in. T hinges; 16 pr. 4-in. T hinges; 2 locks; nails, screws, hooks, staples, etc.

NOTE.—If the building is covered with shingles the pitch of the roofs must be greater than in the figure. The roofs should be 1 ft. higher at the peaks—35 thousand shingles are required to cover the building, laying them on the roof 5 in., and on the sides 6 in. to the weather.

37. Plan for Doing all Work from the Walk.—Fig. 13 shows how the pens in a house of the style described in ¶36 may be arranged to permit all work,—feeding, watering, cleaning droppings boards, and collecting

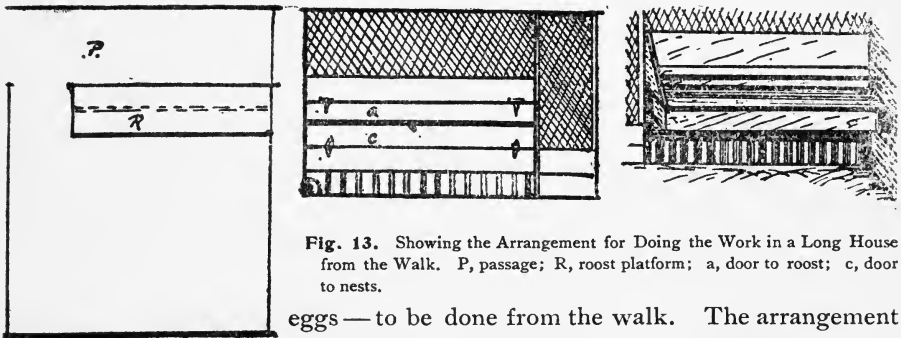

Fig. 13. Showing the Arrangement for Doing the Work in a Long House from the Walk. P, passage; R, roost platform; a, door to roost; c, door to nests.

eggs—to be done from the walk. The arrangement cannot be considered the best for a practical poultry man seeking a plan by which the items, cost, capacity, and convenience, are balanced with a view to the greatest profit. The plan is also open to criticism on the ground that nearly all work being done without going into the pens, the fowls do not become accustomed to the presence of the attendant. Then when it is necessary to go into the pens, the fowls make a disturbance detrimental to egg production. There are, however, cases where it is an advantage to the one caring for the fowls to be able to give them all necessary attention without going into the pens. The arrangement will recommend itself to those who want a house in which they can do the daily chores without being obliged to change from their ordinary dress to a poultryman's working clothes.

38. House with Two Rows of Pens and Passage.—The Monitor Top House.—Convenience alone being considered, this method of housing is superior to all others. A house of this style may face east and west, the common plan; or, south. In the houses with east and west exposures the pens on the east side receive only the morning sun; those on the west side receive the sun only in the afternoon. In what is known as the monitor top house, Fig. 14, the passage is made 3 ft. higher than in the common plain style house, and windows placed in each side of the extension, so that each

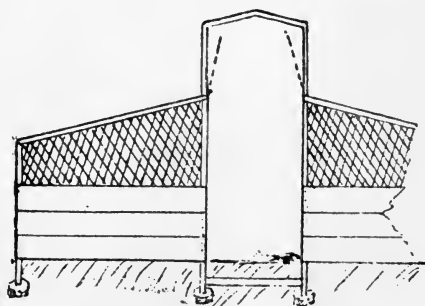
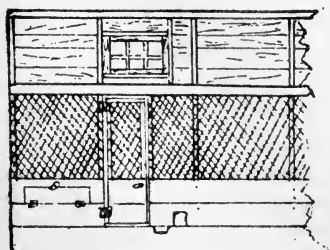
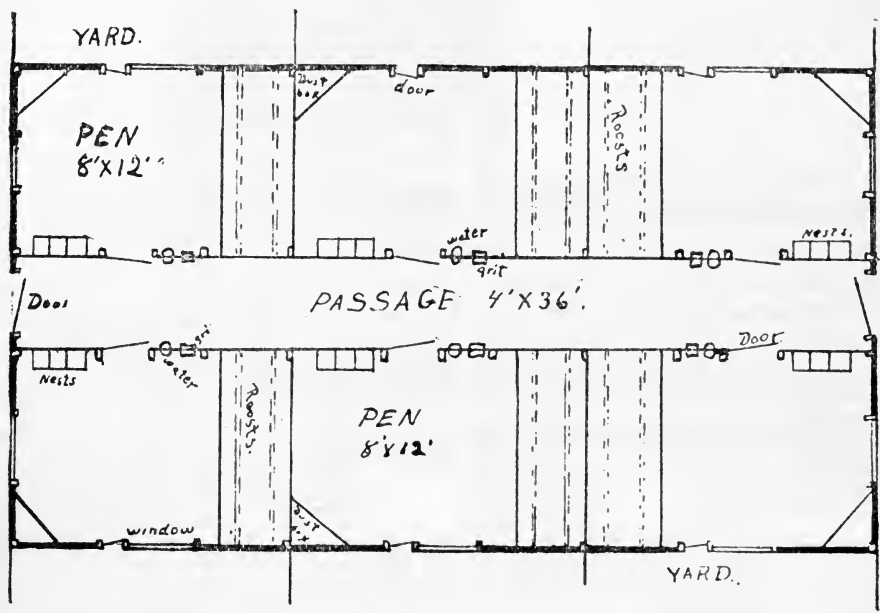
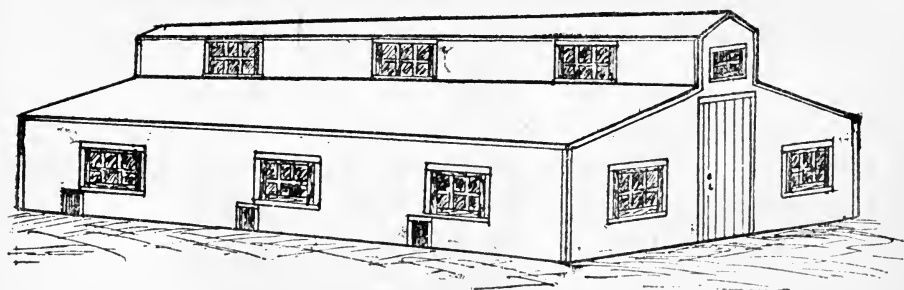

Fig. 14. Monitor Top House. Showing perspective, ground plan, partition between pen and passage, and partition between pens.

pen in the house receives both morning and afternoon sun. Opinion is divided as to the value of the monitor top house. Not enough of them have been constructed and fully tested to show whether the defects in the house are such as can be overcome, or are irremediable. As the matter stands, the monitor top house is recommended only for short houses and for plants in moderate climates.

Materials. (Fig. 13.)

28 short cedar posts to support sills.

Dimension lumber:—

2 pieces 4 x 4 in. 20 ft. long;	4 pieces 4 x 4 in. 18 ft. long;
18 pieces 2 x 3 in. 18 ft. long;	8 pieces 2 x 3 in. 12 ft. long;
38 pieces 2 x 3 in. 10 ft. long;	6 pieces 2 x 2 in. 16 ft. long;

620 sq. ft.

Sheathing 2000 sq. ft.

Matched flooring 300 sq. ft.

Building paper to cover 1600 sq. ft.

12 sash, 6-light, 10 x 12 glass; 98 sq. ft. wire netting, (2-in. mesh) 6 ft. wide; 256 sq. ft. netting 4 ft. wide; 2 pr. 6-in. T hinges, 6 pr. 4-in. T hinges, 6 pr. hinges for sash in top; locks, bolts, nails, etc.

To estimate material for a house without monitor top, use the same ground plan, but figure on studs in passage partitions 3 ft. shorter; rafters 2 ft. longer than the long rafters over the pens; as much less sheathing and building paper as are required for the sides of the monitor top; and only half as many pieces of sash.

39. The Semi-Monitor Top House. — Fig. 15 illustrates the adaptation

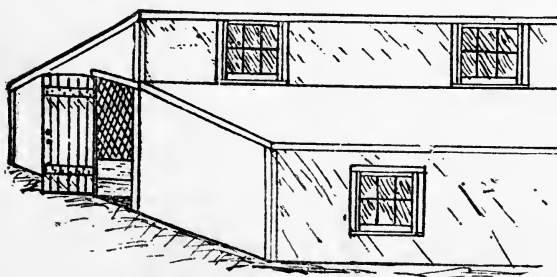

Fig. 15. Semi-Monitor Top House.

of the monitor top idea to a house facing south, but still having two rows of pens, and a walk in the middle. The plan is not a good one for permanent quarters for laying stock. For a surplus stock house it works very well. Sometimes it can be used on the site available better than any other.

40. A Scratching Shed House. — Without a Walk. — Fig. 16 shows

a very popular house. The prominent feature of the plan is that it gives the fowls a sheltered place with fresh air in abundance, and provision for exercise. The house illustrated is 10 ft. wide, 7 ft. high in front, and 4 ft. high in rear. Each 18 ft. section has a roosting room 8 x 10 ft., and an open front scratching shed 10 x 10 ft. The relative positions of the closed and open parts of adjoining sections are reversed, bringing the parts together in pairs, two closed rooms, then two open sheds. The cost of construction is thus diminished, and

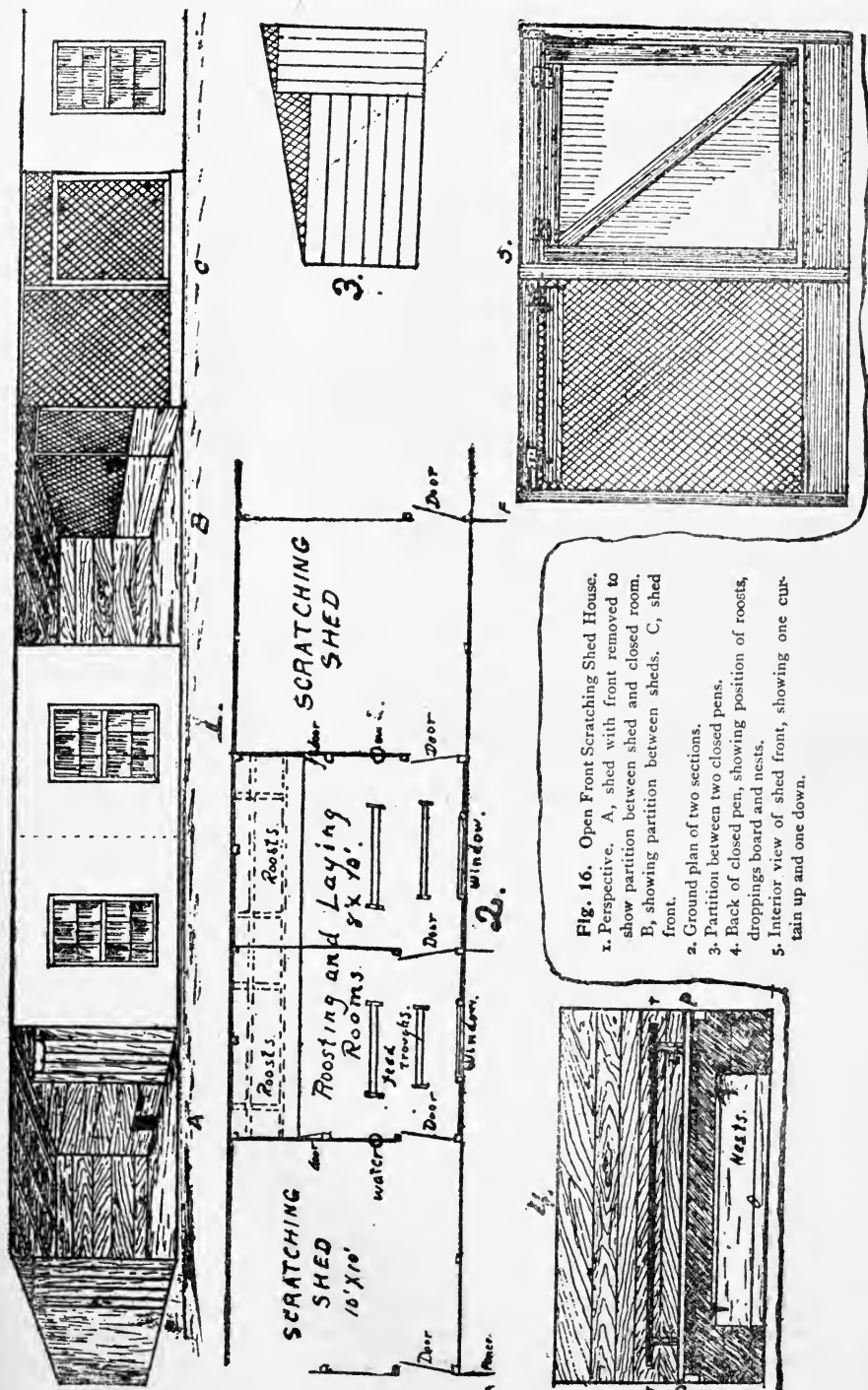

Fig. 16. Open Front Scratching Shed House.

1. Perspective, A, shed with front removed to show partition between shed and closed room.
2. Back of closed pen, showing position of roosts, droppings board and nests.
3. Interior view of shed front, showing one curtain up and one down.
4. Ground plan of two sections.
5. Partition between two closed pens.
6. Shed with front removed to show partition between shed and closed room.
7. Back of closed pen, showing position of roosts, droppings board and nests.
8. Interior view of shed front, showing one curtain up and one down.

the roosting rooms are warmer. The fronts of the sheds are of wire netting, with cloth curtains (on light wooden frames hung on hinges) inside, which are let down in stormy weather and on cold nights. Each section has a capacity of twenty to thirty fowls.

Materials.

23 short cedar posts to go under sills.

Dimension lumber:—

5 pieces 2 x 4 in. 10 ft. long;	4 pieces 2 x 4 in. 18 ft. long;
19 pieces 2 x 4 in. 12 ft. long;	4 pieces 2 x 3 in. 18 ft. long;
2 pieces 2 x 3 in. 16 ft. long;	6 pieces 2 x 3 in. 14 ft. long;
5 pieces 2 x 3 in. 12 ft. long:	

356 sq. ft.

Sheathing	1000 sq. ft.
Matched flooring	200 sq. ft.
Roofing paper to cover	800 sq. ft.
120 sq. ft. 6 ft. wide wire netting, 2-in. mesh; 64 sq. ft. 4 ft. wide wire netting; 12 yds. muslin for curtains; 4 6-light sash, 8 x 10 glass; 5 pr. 6-in T hinges; 2 pr. 3-in. T hinges; locks, latches, nails, etc.	

NOTE.—Studs should be placed as indicated by the small white squares in the diagram, rafters 2 ft. apart at centers. The plan may be changed to slightly lessen the cost and increase a little the capacity of the house. Records of numerous flocks kept in houses of this kind seem to show that the better plan is to have the two parts of the section of equal size, and cover both floors with scratching material. With such an arrangement, each part being 9 x 10 ft., all studs and rafters in a house with 18 ft. sections are placed 3 ft. apart.

41. Suggestions for Scratching Shed Houses.—The style of house described in ¶40 is the one most generally used. The original plan was for a close house, of which a part could be made an open shed at will. There is reason to think that in principle this is the better plan, though the particular design first given had objectionable features. In Fig. 17 are shown some suggestions for houses in which the scratching sheds can be open or close at will. The drawing at A represents a house with sections of different dimensions, the first 16 ft. long, the next 24 ft. long. Each section is divided into two equal parts, one of which can be made, practically, an open shed by opening the door, which is 4 ft. wide in the small section, and 6 ft. wide in the large one. The half-windows light the sheds when the doors are closed. The design at B shows another arrangement for fronts of shed rooms of same dimensions as at A. The doors proper are but 2 ft. wide. The half-windows are placed 1 ft. from the ground. The upper half of each front, exclusive of the door, can be opened or closed at will. By an arrangement of double hinging, shown in detail in Fig. 18, the shutters swing either in or out. In winter, when it is desirable to admit the sun, the shutters swing in. For warm weather, the shutters swing out, is an awning, excluding the sun from the shed, shading the half-windows, and making the shed during the heat of the day an ideal cool place for hens. The stop over the joint between

the lower edge of the shutter and the joint should be screwed to the shutter when the shutter is wanted to swing in, and to the jamb when the shutter swings out.

42. Scratching Shed House with a Walk.— Fig. 19 (p. 38) shows how a scratching shed house may be built with a passage from which each pen and shed is entered without passing through others. The pens are in two wings, running east and west from a two story building containing work shop, cook room and store room. In the original plan each wing, containing ten sections, was 180 ft. long. In the plan here given the length of the wings has been reduced to bring the illustration within the limits of the page. The walk is separated, by a tight partition, from pens and sheds, and is lighted by half-windows in the north wall, which in the original plan contained besides these openings a door every 60 ft. With wings as short as in the plan given, a door at the extreme end of each wing is all that is needed. This house has a low stone foundation. The floors are filled to the level of the sills with earth.

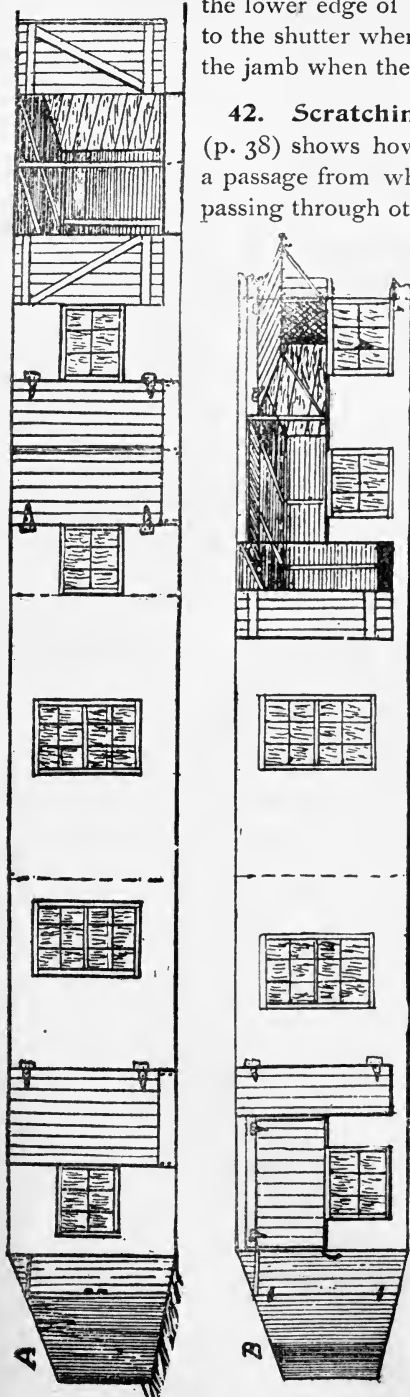

Fig. 17. Suggestions for Fronts of Scratching Shed Houses.

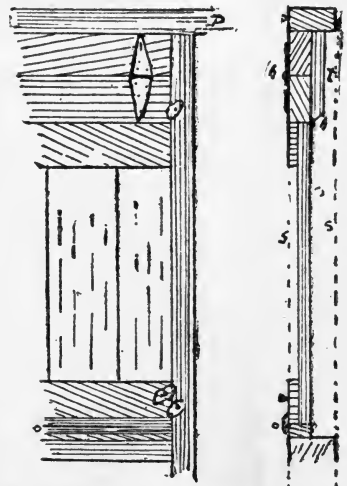
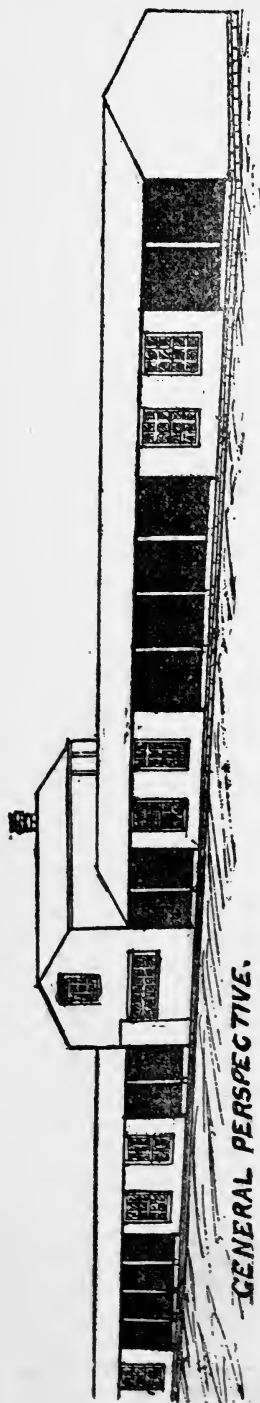
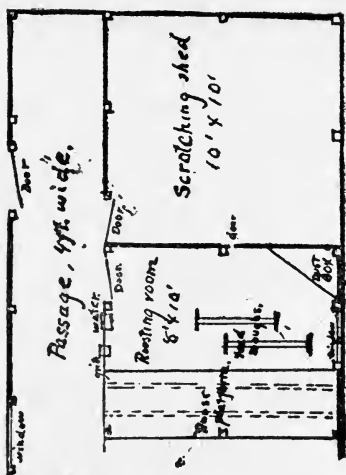

Fig. 18. Section and Inside of One End of a Shutter as shown at B, Fig. 17. P, plate; ss, position of stud; t, stop; hh, hinges.



GENERAL PERSPECTIVE.



GROUND PLAN OF PEN AND SHED
IN EAST END.

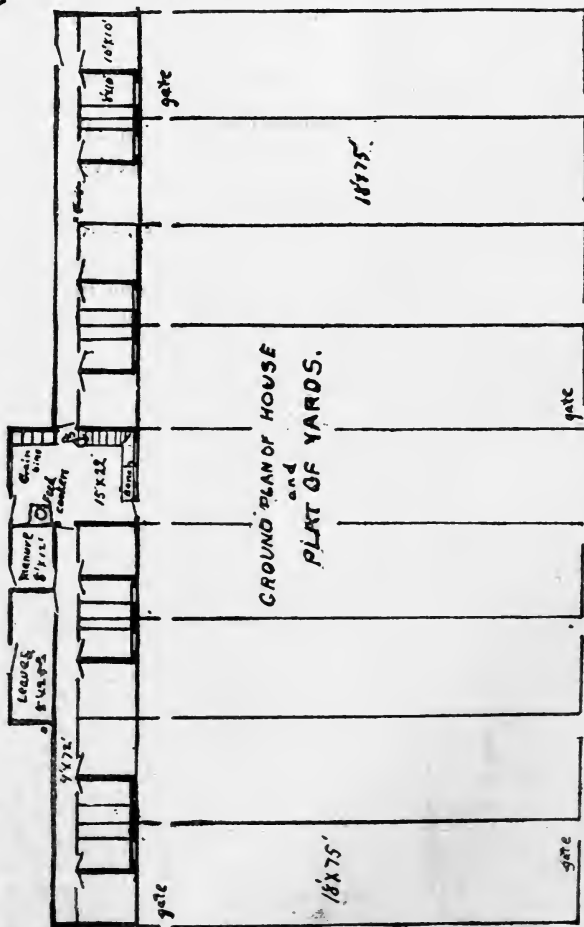

Fig. 19. Open Front Scratching Shed House with
Walk in Rear.

Materials.

Dimension lumber :—

- | | |
|----------------------------------|----------------------------------|
| 32 pieces 2 x 4 in. 18 ft. long; | 8 pieces 2 x 4 in. 16 ft. long; |
| 2 pieces 2 x 4 in. 14 ft. long; | 62 pieces 2 x 3 in. 16 ft. long; |
| 28 pieces 2 x 3 in. 14 ft. long; | 44 pieces 2 x 3 in. 12 ft. long; |
| 26 pieces 2 x 8 in. 16 ft. long; | 16 pieces 2 x 2 in. 10 ft. long: |

2120 sq. ft.

Sheathing 7000 sq. ft.

Matched flooring 1500 sq. ft.

Roofing paper to cover 5500 sq. ft.

24 6-light sash, 10 x 14 glass; 9 pr. 6-in. T hinges; 18 pr. 4-in. T hinges; locks, bolts, nails, screws, hooks, staples, etc. For the chimney about 40 bricks for each foot in height will be needed.

To Make the Joints at the Eaves Wind Tight.—In constructing the house from which this plan is adapted, the builder devised a novel and effective way of making the joint of the side walls and roof wind tight. The paper on the sides (see Fig. 20) is lapped over onto the first board of the roof.

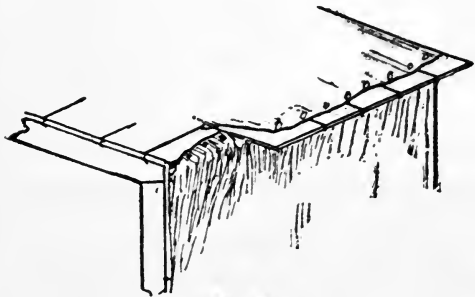

Fig. 20.

The paper on the sides (see Fig. 20) is lapped over onto the first board of the roof. A double row of shingles is then laid, just as if the roof was to be shingled, and the roof paper is lapped well over the shingles. If this plan is followed in constructing a house, three-fourths M. of shingles should be added to the bill of materials given.

43. A Poultry House with Roosts on the Warm Side.—In Fig. 21 (p. 40) is shown a house designed to combine the best features of plans already described, with a few ideas not heretofore generally applied to poultry houses. The radical difference between this and all other plans given, is that the roosts are placed near the south wall and parallel to it. As is well known, the south side of a room is, as a rule, the warmest side. The simple change in position of the roosts gives the fowls the warmest part of the house to sleep in. To make it possible to keep the fowls comfortably warm on the coldest nights, and to regulate the temperature near the roosts, the roosts are enclosed in a box, the entire front of which can be opened or closed as desired. (The boxed roost has been used for some time by breeders of large combed varieties, but has generally been placed either near the north wall, or in the middle of the pen, where it obstructs the light).

By removing the roosts from the north wall and doing away with a passage, both earth floor and litter can be removed and renewed through a half-window in the north side of each pen. This work can be done in each pen without disturbing the fowls in any other. The plan saves labor, earth and litter being transferred directly from wagon to pen, or *vice versa*. In most houses straw and litter are handled through the passage, or from pen to pen; earth through

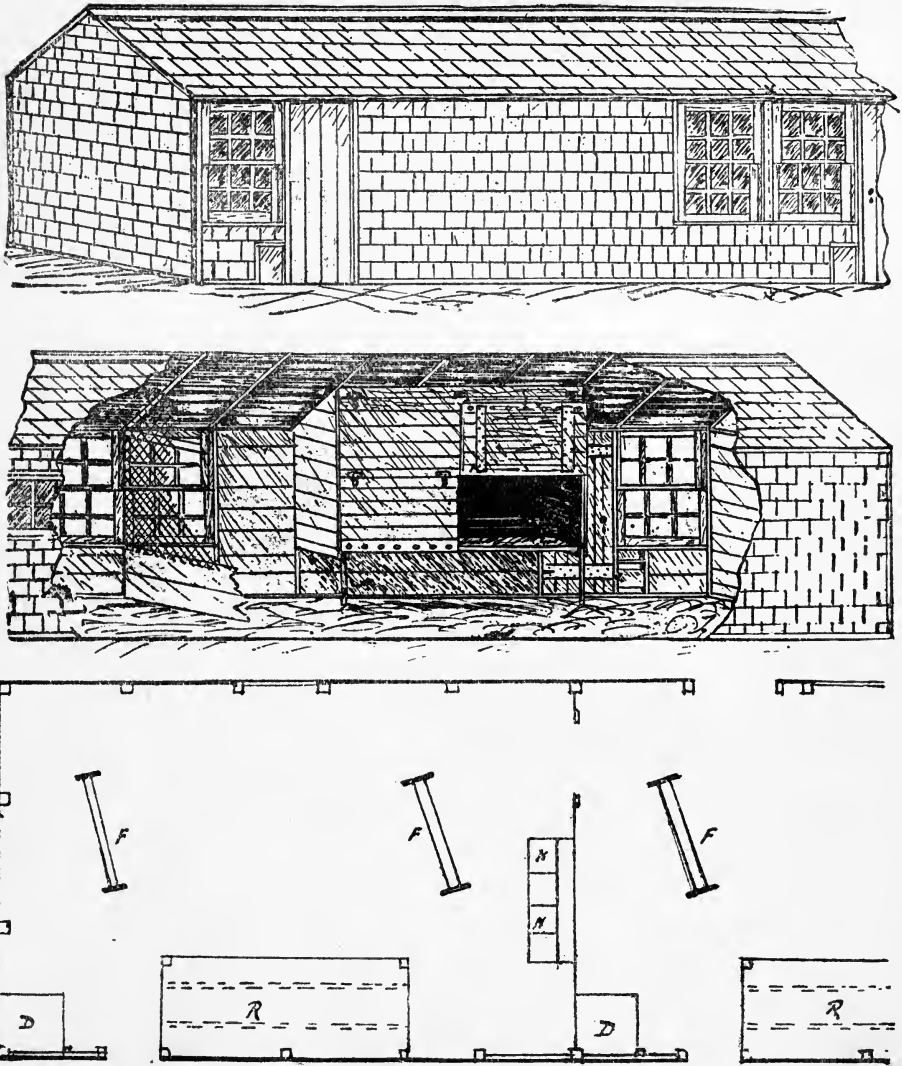

Fig. 21. Poultry House with Roosts on South Side.—Showing in the upper drawing the exterior perspective of a section 12 x 18 ft.; below it interior view of the south side and roost box; in the lower drawing the ground plan in which R is the roost box; N, nests; D, dust box; F, feed troughs; the small squares indicate the positions of studs.

the south windows, it being necessary to remove a section of every fence connecting with the house to make passage for the cart or wagon. The result of this cumbersome way of working is that the pen floors are more or less neglected. With this arrangement the work of keeping them in order can be made what it should be on a well regulated plant—an odd job to be taken up between routine tasks. The disadvantage of having no passage in a long house is partially obviated by placing an outside door in the north wall of every third pen (see Fig. 26). The roosts being at the south side and boxed

up, it is not so necessary that the north wall be tight as in other houses. These doors should, however, have outside storm doors which can be tightly closed in the severest weather.

The house can be built with a walk as shown in the diagram, Fig. 22. Here the walk is 3 ft. wide. (It can be wider if desired).

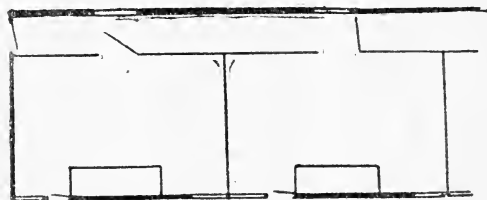

Fig. 22.

The door between walk and pen is at the middle of each pen, and opposite the half-window in the north wall. With this arrangement it is still possible to handle earth, etc., from pen to wagon and from wagon to pen, though the work is not quite so easy. The expense of a walk is considerable in a long house, and the additional width of the building does not increase its capacity. It is a question for each builder whether in his case the greater general convenience of the walk will compensate for the increased cost of the building, and some extra labor in doing special work.

The house shown in Fig. 22 is 12 x 18 ft.: 216 sq. ft. of floor space, of which all but that occupied by nests and dust box is available exercise space. The whole house can be tightly closed, or with the windows and doors in the south side open, will give all the fresh air that can be used. The doors and windows can be opened as much or as little as desired. The position of the windows gives the maximum of sunlight in the house, with the minimum exposure of glass. The bottom of the roost box is the droppings board, which should have strips of furring on the end and back edges, but not on the front edge, and should rest on cleats on which it will slide like a wide shallow drawer without a front. It can be removed in an instant, thus making it easy to get at the interior of the roost box to keep it clean and free from vermin. A row of 1-in. auger holes should be bored at the lower edge of each lower door to allow gases to escape when the box is tightly closed. If preferred, a curtain of burlap can be used in front of the roosts, instead of the doors. The illustration shows a house built with sills and plates, and having both roof and sides shingled. The cost of the house can be reduced by constructing as in Fig. 8. The roost box is built with ends front and bottom of matched flooring. Ordinarily the wall back of it need not be doubled, but in a very cold climate it might be well to line both back and top of the box with matched lumber.

Materials.

A single house of the dimensions in Fig. 21 requires:

Dimension lumber:—

2 pieces 4 x 4 in. 18 ft. long;

2 pieces 2 x 3 in. 18 ft. long;

3 pieces 2 x 3 in. 16 ft. long;

2 pieces 4 x 4 in. 12 ft. long;

14 pieces 2 x 3 in. 12 ft. long;

1 piece 2 x 3 in. 14 ft. long:

213 sq. ft.

Sheathing	600 sq. ft.
Matched flooring	150 sq. ft.
Roofing paper, or shingles to cover	600 sq. ft.
2 pr. 6-in. T hinges; 2 pr. 4-in. T hinges; lock, bolt, nails, etc.	

44. **A Complete Plant Under Cover.**—As a rule the plat of a large plant must conform to the “lay” of the land on which it is situated. It is

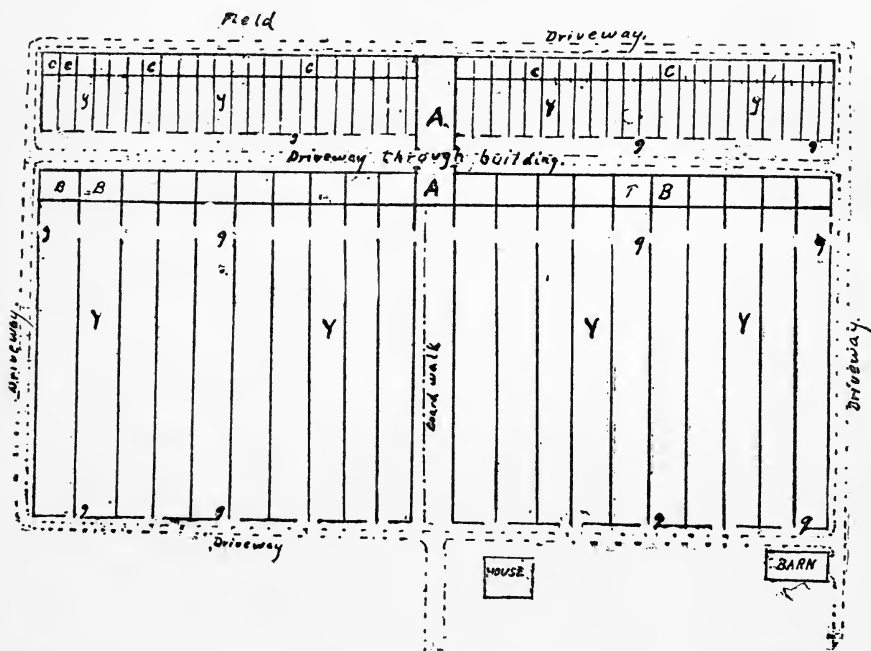

Fig. 23. Plat of Plant Arranged so that Work may all be done Under Cover in Stormy Weather.—A, central building; B B, laying houses; C C, brooder or brooder and surplus stock houses; Y y, yards; g g, gates.

not always possible to so place the buildings that the greatest convenience in doing the work is secured. Fig. 23 shows how, if there is available a piece of level or gently sloping, (to the south or southeast) ground, 400 ft. long, east and west, and 200 ft. wide, a large poultry plant arranged to permit the work to be done for days at a time without going from under cover, can be placed on it. (It is, of course, understood that on this space only the buildings and yards are placed. There must be additional room for rearing chicks for stock birds. While chicks can be reared in yards, the yards of this plant would not accommodate the stock on hand during spring and early summer months). Such an arrangement has immense advantages. The plant is very compact. All supplies are conveniently stored. Practically every part of the plant is accessible by wagon. But the best thing about the plan is that bad weather never need interfere with the care of the fowls. To the uninitiated it may seem a little thing that hens should be kept waiting for food for an

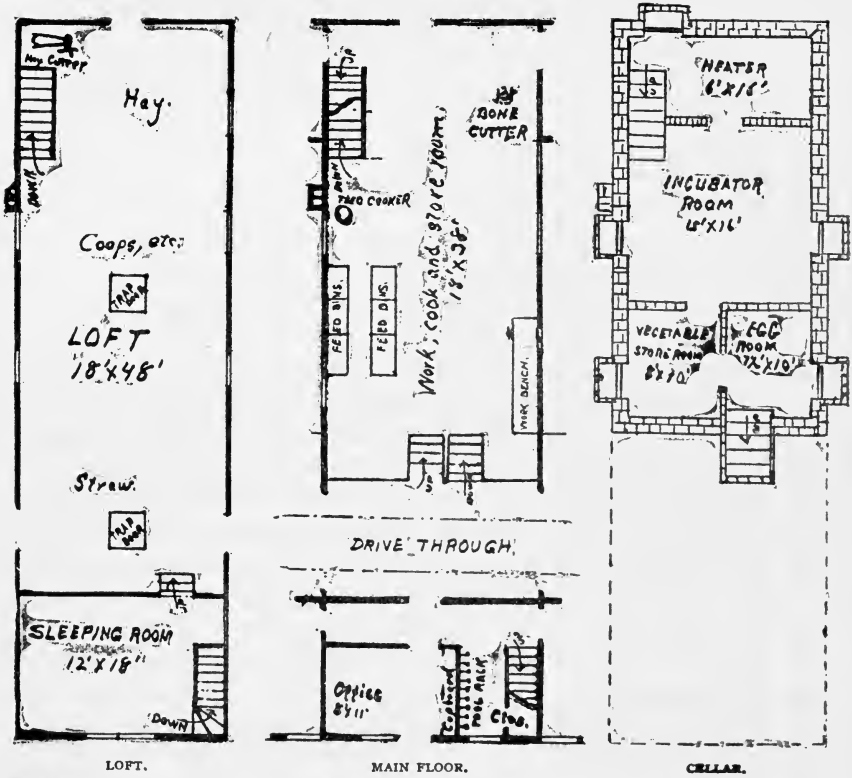

Fig. 24. Central Building of the Plant shown in Fig. 23.

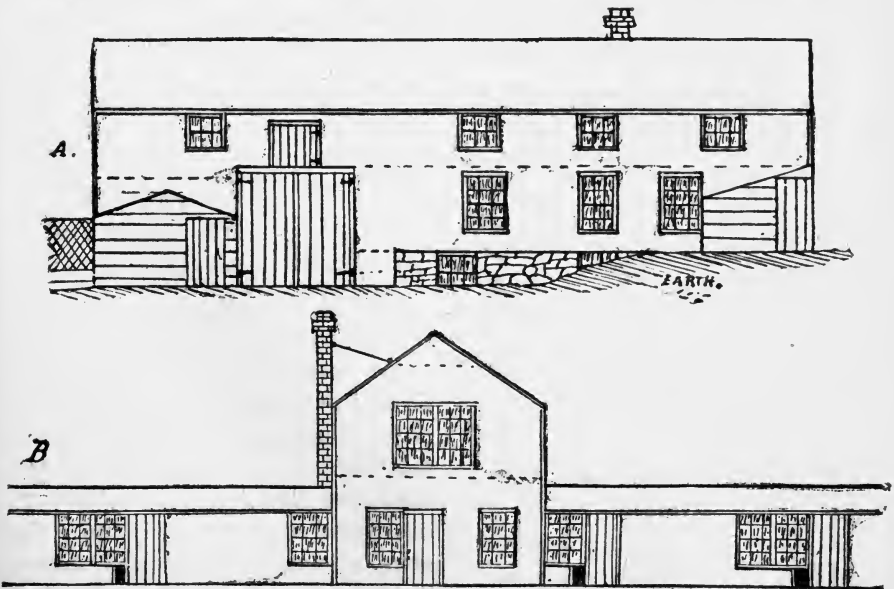

Fig. 25. Elevations of Central Building in Fig. 23.—A, east side; B, south side.

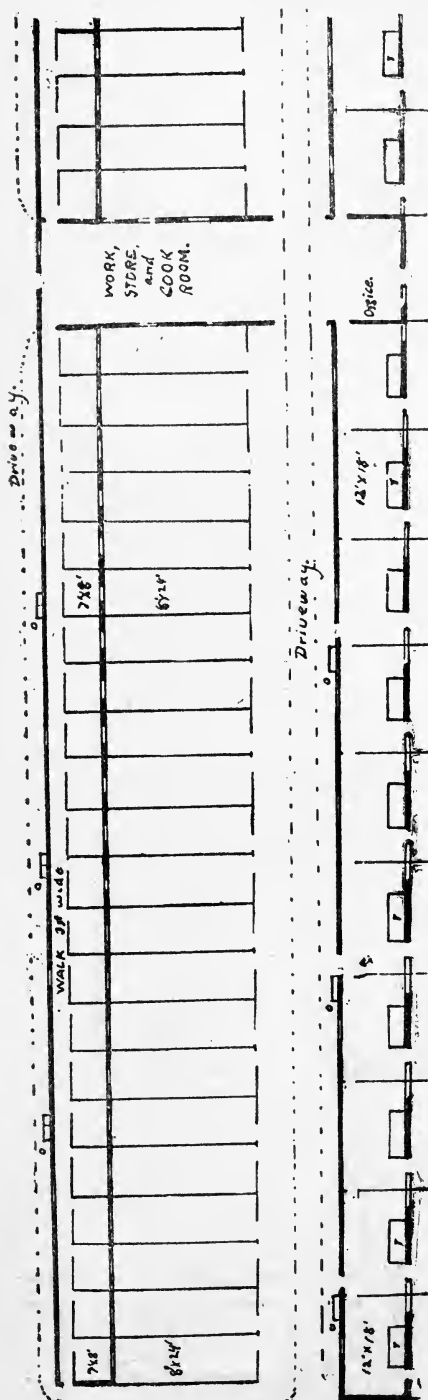

Fig. 26. Ground Plan of West Wings of Laying and Brooder Houses in Fig. 23. 000, droppings boxes, illustrated in Fig. 27.

hour or two on a winter morning, while paths are being broken from building to building; and that the poultry man should occasionally be obliged to add to his other tasks the dead weight of a few hours snow shoveling. One who has kept fowls for profit through a single winter knows that regular feeding is of the utmost importance. He also knows that it is at these waiting times that hens develop such vices as egg eating and feather pulling. He knows that it makes a difference to the poultry keeper whether his extra work must be done at high pressure before the regular day's work begins, or can be done more leisurely at intervals during the day. On a plant after this plan the only path to be made on a snowy morning is from the dwelling to the door of the main building. All others can wait for fine weather and a convenient season.

The plan provides for a central building, A A, connecting two long houses, B B B, for laying and breeding stock, and two long brooder or brooder and surplus stock houses, C C C. These long houses can be built in any style desired. The central building is sufficiently described in the diagrams in Fig. 24, and elevations in Fig. 25.

Fig. 26 shows the adaptation of house designs in Figs. 21 and 34, to this general plan. All supplies and products are kept in the central building. The droppings, collected daily, are placed in boxes, Fig. 27, distributed as at 000, Fig. 26. As often as necessary a wagon makes the round of the boxes, removing

the accumulated droppings. There should be a small covered opening through the north wall at each box, that it may not be necessary to leave the building to empty a pail of droppings. Some poultry keepers have bins for grain connected with each house much as these droppings boxes are, though not as numerous. The idea is a good one, and can be easily added here. These extra bins should be near the ends of the long houses furthest from the central building.

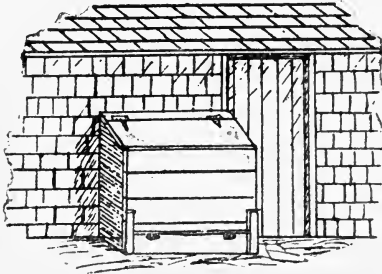

Fig. 27. Box for Storing Droppings.

The water supply for a plant of this kind is one of the first things to be considered. If connection can be made with a water system the problem is simple. Failing this, there should be a well, or cistern, from which water can be pumped to the main floor of the central building. If a well, there might be an advantage in having a windmill and tank so placed that water could be distributed by pressure to every part of the plant. A comparatively inexpensive way of securing a limited supply of water for emergency use is to place a large tank to be filled from the roof, in the loft of the main building. This tank should be provided with an overflow pipe, and the floor beneath it should be made strong enough to support its weight when full of water.

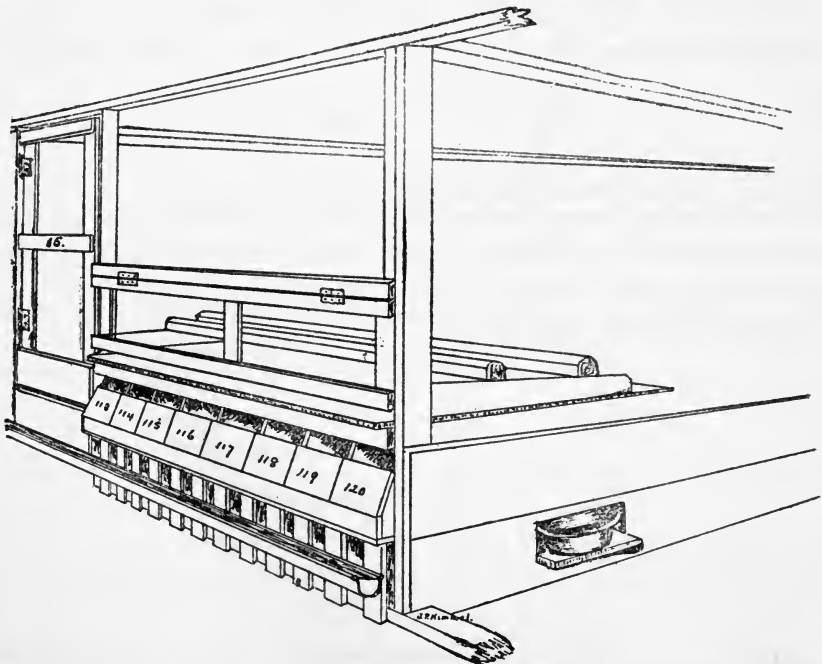

Fig. 28. Section of a Poultry House Arranged to Do all Work from the Walk. (By courtesy of J. P. Kimmel).

45. Incubator Cellars.—A dry well ventilated cellar or basement is the best place for an incubator. Machines can be run successfully in rooms wholly above ground, but require closer attention because of greater and more rapid variations in the temperature of the room. Where only one or two machines are used they are oftenest kept in the cellar of the dwelling. In case of fire this may invalidate insurance. It is better always to have a place specially for incubators. On a large plant the incubator cellar is a necessity. Various methods of constructing incubator cellars are shown in Figs. 24, 28, 34. In Fig. 29, are end and side elevations of an incubator cellar on the plan most used where a building especially for incubators is constructed. This diagram indicates an incubator room 7 to 8 ft. high at the sides. The floor is about 3 ft. below the level of the ground, and the earth is banked to the top of the wall.

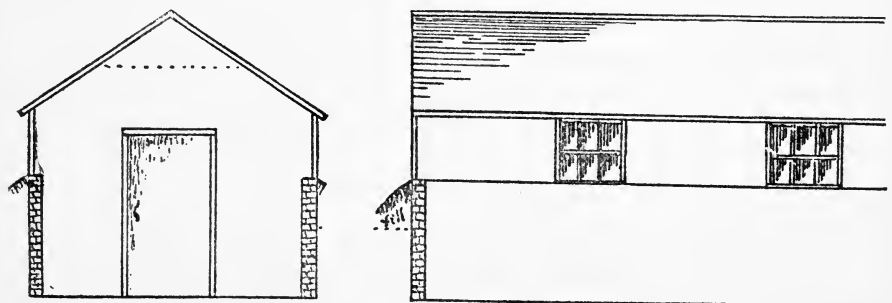

Fig. 29. Incubator Cellar — End and Side Elevations.

An incubator cellar need not be well lighted, but provision must be made for thorough ventilation. The air must be kept pure. Usually this is accomplished if the cellar has arrangements for ventilation about as in a good dwelling house cellar; but in a cellar where many incubators are used it is found to be an advantage to make the roof high so that the supply of air in the room will be ample. Nearly always the windows have double sash, those outside hinged at the top, the inside ones hinged at bottom, so avoiding direct draft on the machines when windows are open.

46. Brooder Houses.—The style of brooder house used will depend on the system of brooding adopted. If the continuous pipe system is used, the brooder house will, in its general features, resemble the long poultry house with passage and single row of pens. Fig. 29 is an exterior view of such a

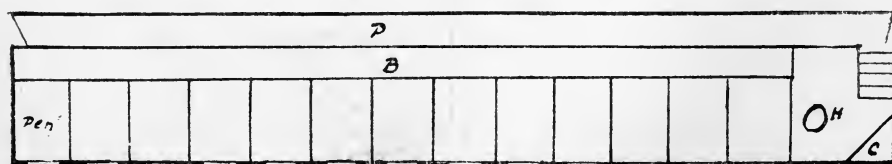

Fig. 30. Ground Plan of a Long Brooder House — Pipe System — single row of pens.

house. Fig. 30 shows a ground plan, and Fig. 31 a cross section, of a plain style brooder house very commonly used. It is 13 ft. wide, and any length desired. The walk is excavated to a depth of 18 inches, thus giving a passage along the north side of a house only $4\frac{1}{2}$ ft. high at the eaves. The walk is $3\frac{1}{2}$ ft. wide; the brooder 30 in. wide. Each pen is $5 \times 7\frac{1}{2}$ ft. The partitions between the pens is of board 1 ft., wire netting 2 ft., making the total height 3 ft. The partition between the pens and the walk is at the inner edge of the brooder. This brooder is really a long box containing, generally,

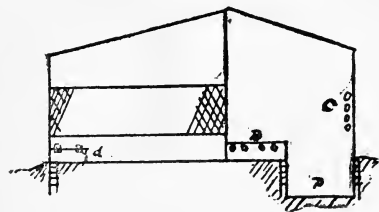

Fig. 31. Cross Section of Long Brooder House
— pipe system — single row of pens.

connecting with hot water heater, placed in a pit several feet below the level of the floor, at one end of the house. (In very long houses the heater is sometimes placed in the middle). At the end near the heater the pipes are about 4 in. from the floor. They rise gradually until, at the further end, they are 8 in. from the floor. They pass through holes bored at the proper height in each cross partition of the brooder, (the partitions of the brooder correspond to the pen partitions), and require no other supports. The top, or cover, of each section of the brooder is of matched boards held together with cleats, and lined on the under side with building paper. These covers are sometimes hinged; sometimes rest on cleats nailed to the sides of the brooder. The side of the brooder next the walk is a solid board. The side communicating with the pens is of woolen cloth with slits at short intervals to permit the chicks passing in and out. The pens nearest the heater, where the pipes are lowest, are used for the smallest chicks. As each hatch comes off the whole lot of chicks is advanced one or more pens, being driven through small doors in the partitions between the pens.

In the plan shown in Fig. 32 the pipes are laid level, and the smaller chicks brought near the heat by the use of movable floors or by filling up the brooder floors with chaff. This plan is preferred by many, as it does away with moving the chicks to accommodate each new lot. If pens are all of a size, the lots must be divided as the chicks grow. In some houses the pens are made of varied widths to provide for lots nearly equal in number, but varying in size. In the colder sections of the country many have put pipes along the north wall of the brooder house, because they found it difficult to keep up the temperature on cold nights. Their difficulty was due to using too small a heater; and the builder should take care to avoid their mistake instead of imitating their way of correcting it.

47. Nursery Brooders in a Long House.—Instead of starting chicks under pipes a few inches from the floor, many use nursery brooders. These are small separate brooders heated by lamps. They are purchased complete

from manufacturers, and are usually nearly, if not quite, like the brooders used for brooding in detached houses. When these brooders are used in connection with the pipe system, a common plan is to have the heater near the middle of a long house, pipes running one way from the heater, and the pens in the opposite direction being used for nursery brooders—one in each pen.

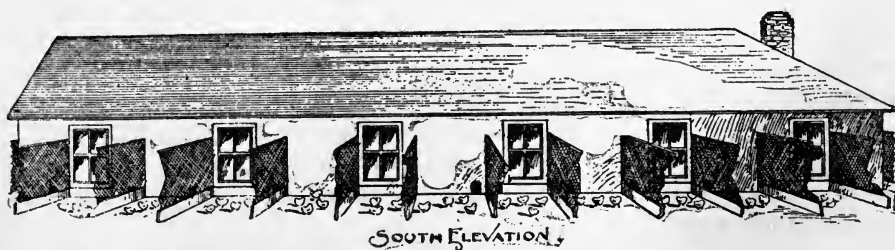
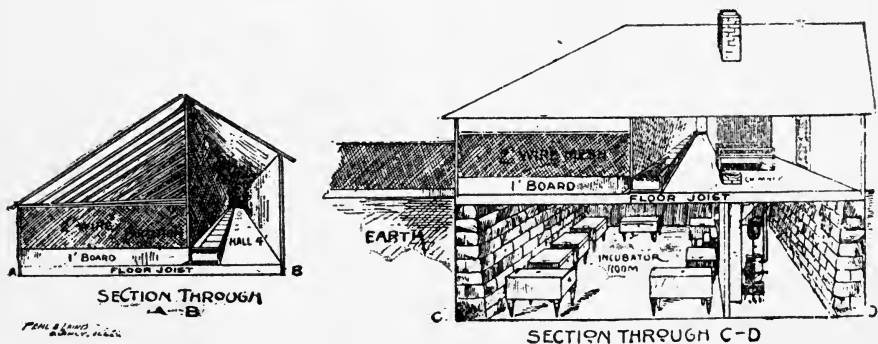
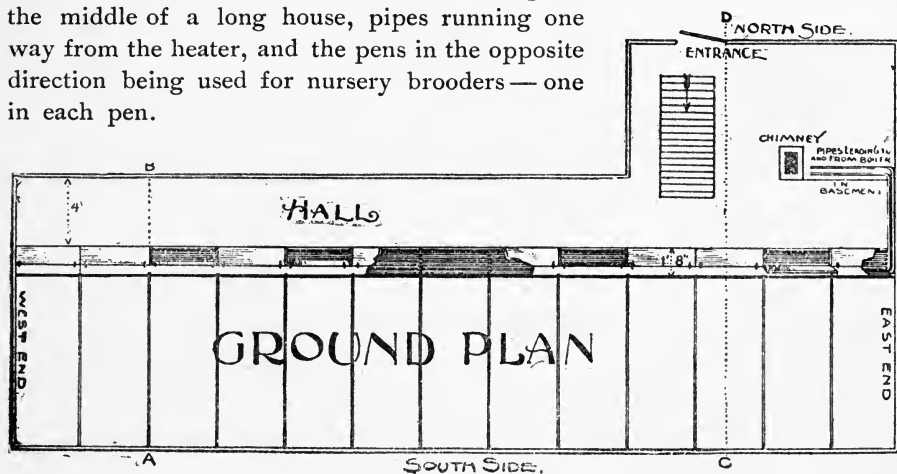

By Courtesy Reliable Poultry Journal.

Fig. 32. Brooder House with Incubator Cellar,—Main house, 16 x 52 ft.; wing, 8 x 16 ft.; basement, 16 x 16 ft.; hall, 4 ft. wide; pipes 8 in. from the floor, six one-inch flow pipes; one two-inch return pipe. House double boarded with paper between. Cost complete, about \$250.

48. Houses for Separate, or Detached Brooders. — The pipe brooder house can be used only to brood chicks; its arrangement makes it unsuitable for housing stock. Besides this, the brooder being built into the house, if

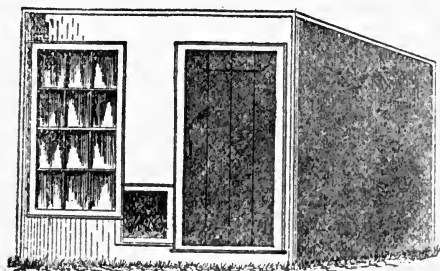

Fig. 33. A Detached Brooder House.

once it becomes infested with lice there is great difficulty in getting rid of them. Some poultrymen use detached brooder houses like that shown in Fig. 33. In this is placed a small brooder, which is removed when the chicks no longer need the heat. Roosts may then be put in, and the chicks kept in the same house until grown. Fig. 34 shows how this simple detached brooder

house has been developed into a long house with a separate compartment for each brooder. This house has no walk. Communication between pens is through doors, near the front in the partitions. There are yards, as wide as the sections of the house, and as long as wanted, and the house can be used for laying stock, for surplus cockerels, or for fattening stock.

49. Fences. — The fence question is a very simple one. The fence must be high enough to prevent the fowls from flying over; strong enough to stand a stiff wind storm without damage. Contiguous yards in which adult males are kept must have at least the first 2 ft. in height, of tight boards. The common fencing materials are lath, wire netting, and woven wire. Wire fences give best satisfaction. Lath fences are sometimes preferred for the shade they afford. It is better to use wire, and make shelters in the yards. For movable fences wire is now always used. The height of fence needed is: for Asiatics, 3 to 4 ft.; for American varieties, 5 to 6 ft.; for small breeds, 5 to 6 ft., according to size of yard; small yards require higher fences. If fowls are not kept in bounds by a 6-ft. fence their wings should be clipped, or the run covered with netting of 3-in. mesh.

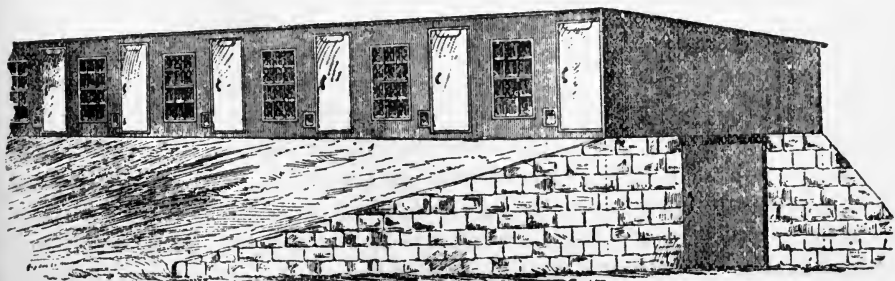

Fig. 34. A Brooder and Surplus Stock House.

50. Hints to Builders.—*How Much Room per Fowl.*—The rule so often given, 10 sq. ft. house floor space, and 100 sq. ft. yard space to each fowl, is not generally adhered to by poultry keepers. In practice it is found that small flocks need proportionally more room than large ones. Large hens need more room than small ones, though being less restive in confinement, the difference is not strictly in proportion to size. If fowls have to be closely housed for long periods they need more house room than if they can be out of doors nearly all the time. Some house plans give greater capacity than others, but this depends more on position of doors and windows, and arrangement of interior fixtures, than on actual floor dimensions.

House Room.—*Floor Space.*—For hens of the medium sized breeds, in flocks of twelve or more, the allowance of floor space should be 5 to 6 sq. ft. per hen. For smaller flocks the space per hen should increase as the number of hens decreases. Practically as large a house is needed for eight or ten hens as for twelve. This rule may safely be used in planning houses of any required average capacity. Inexperienced poultry keepers should keep on the safe side of it when stocking houses; for their judgment on the matters referred to as affecting the application of a general rule, is apt to be faulty, and most apt to err in the direction of overcrowding, which is a serious evil.

Cubic Space.—No rule for this need be given. The plain rule for height of buildings, given as *axiom 3*, under "Making Plans and Estimates," being followed, a house will have abundant air space for all the fowls its floor will accommodate.

Yard Room.—If yards are to be in permanent sod, the rule of 100 sq. ft. per hen is about right. If other provision is made for green food, the yards being simply exercise grounds, estimates for yards may be made on a basis of 25 to 30 sq. ft. per fowl. An intermediate system of yarding is sometimes used. This gives each pen of hens a small exercise yard, and to every two pens a grass yard. This last is generally smaller than could be kept in sod were the hens constantly on it, and the hens are given the run of the grass for only a few hours daily.

Making Plans and Estimates.—While not requiring much mechanical skill, economical poultry house construction calls for some ingenuity in planning to use materials without waste. Plans given in this chapter are drawn to scale, and may be used as working plans when no changes are made; but it is advised that for all but the most simple constructions plans be re-drawn on an enlarged scale. The mere drawing of the working plan gives the novice in building a better idea of what he has to do, and how best to go about it, and working from a plan he is less likely to make the numerous and common mistakes of amateur carpenters. If changes are made new plans must be drawn. One-fourth inch to the foot is a good scale for house plans; for plats of large plants a scale of one-sixteenth inch to the foot is convenient.

In making plans a few simple rules, which may well be called *axioms*, should be observed:

- (1.)—Permanent quarters for stock should be on the ground floor. Second floor space may be used for temporary quarters for surplus stock, for fitting exhibition birds, for storage, etc.; but not much second floor space is needed.
- (2.)—Walls should be perpendicular. A sloping front is a bad fault.
- (3.)—A house should be as high as necessary to accommodate those working in it; but not higher. Additional height increases the cost of the house, and increases the difficulty of regulating the temperature.

Ventilators are not needed. A poultry house can be aired just as a dwelling house is — by opening doors and windows as much or as little as the weather conditions require.

Buying Materials.—Lumber ordered should be of such lengths that there will be the least possible waste in using it. It is safest to order a little more than is needed. This insures against delays from shortages of material. What is not used can usually, if purchased of a local dealer, be returned. If not returnable it should be stored away for the time — sure to come — when it will be needed. Refuse to accept any and every piece of dimension lumber that is not straight, free from bad knots, and of the full length required. See to it that the sheathing delivered is of full surface measure. In estimating the amount of matched flooring, or lapped siding, needed to cover a given surface, make allowance for matching, or lapping, by adding one-fifth to the surface measure. Shingles of good quality are cheapest at first cost, as well as in the long run. The builders' rule is a thousand shingles laid 4 in. to the weather, to the square (100 sq. ft.) If the sheathing on poultry house roofs is laid close, and a thin sheathing paper used under the shingles, shingles may be laid $4\frac{1}{2}$ or 5 in. to the weather. On the sides of buildings they may be 5 or 6 in. to the weather. Taking both sides and roof into consideration, a safe estimate for shingles will be, a thousand to every 120 sq. ft.

Prepared Roofing Papers.—These vary in quality. Those advertised especially for poultry and farm buildings, are the best. Common tarred sheathing paper is not suitable for exterior use. Tarred felt may be used outside, and if protected with a coat of tar will last for some time, but is very much inferior to the specially prepared papers. Though the best papers are not as good as shingles, they are a boon to poultrymen with small capital; properly put on and regularly painted, they last a long time, and at first cost are much cheaper than shingles. Paper can also be used to cover old buildings not suitable for shingling. Dealers in builders' supplies generally carry stocks of roofing papers. Sometimes people hesitate to buy the special brand they want because the local dealer does not keep it, and the factory is so far away that freight would add too much to the cost. Manufacturers usually have distributing agents in different sections. Write to headquarters

for information. The request will be referred to the nearest agent. Different makes of paper vary in width, and in the quantity in a roll. When a particular kind of paper is to be used it may be well to make the dimensions of the building suit the paper. A change of a few inches in a measurement of the original plan sometimes saves material and labor without appreciably affecting the capacity of the house.

Paint. — Roofing papers and all exposed (outside) wood surfaces, except shingles, should be painted. Shingles on roofs of slight pitch last longer unpainted. Pure lead and oil makes the best paint. After this come the prepared paints ground in oil, of the consistency of keg lead, and to be thinned with oil. The best cheap paints are made of venetian red, yellow ochre, or brown earth paint, (often called mineral paint), mixed with boiled linseed oil. The red and yellow can be bought either in dry form or ground in oil. The brown is usually to be had only in the dry form. Paint, when applied, should be of such consistency that it works freely, but does not “run.”



CHAPTER IV.

Poultry Fixtures.

51. Roosts.—The reader will have noticed in the plans where the height of the roost is indicated the roosts are placed low down; he will also have observed that when more than one roost is used the roosts are on the same level. There are several reasons for low roosts. Fowls of the heavy breeds cannot fly to a high roost. Fowls of all but the lightest breeds often injure their feet by jumping from a high roost to a hard floor. When droppings boards are used they should be tolerably low down, both for convenience in cleaning, and that the least possible portion of dust from them may be breathed in by the person doing the work. The roost being but a few inches above the board, low roosts are most common, even for Leghorns and Minorcas. The object of having all roosts on the same level is to prevent fowls crowding one another from the roosts, as they do when the roosts are on different levels, and the fowls all trying to get on the highest. The amount of roost room per fowl varies with the size of the fowl. As a rule, fowls sit close together on the roosts, even in hot weather, and when there is room to spare. For Leghorns 6 to 7 in., for Wyandottes and Plymouth Rocks 7 to 9 in., for Brahmas and Cochins 8 to 10 in., will be safe estimates. The roosts should be about 8 in. from the droppings board, and, unless it extends clear across a pen, should be a little shorter than the board. Some use 2 x 2 in. scantling for roosts, others prefer wider stuff, especially for heavy fowls. For short wide roosts, inch stuff 4 or 5 in. wide will do. For long roosts, stuff must be thicker, or the weight of the fowls causes it to sag in the middle. The upper edges of the roost should be slightly rounded.

52. Droppings Boards.—These may be of matched flooring, or of sheathing surfaced on one side. Strips of furring 2 in. wide are generally nailed to the edges of the board to prevent the droppings being scattered. For a single roost, the board should be 18 or 20 in. wide; for two roosts, about 3 ft. wide. Droppings boards are a great convenience in a well kept house. A neglected house is better without them. If droppings are allowed to accumulate, the boards become saturated with liquid manure, and being so close under the fowls, make bad conditions worse.

53. Nests.—On some of the best equipped plants the nests in the laying pens are soap boxes placed on the floor in the corner. These answer admir-



Fig. 35. Dark Nests to go under Roost Platform.

Fig. 35 shows a bank of dark nests to go under a roost platform. Fig. 36 shows how dark nests may be constructed to attach to the wall at a suitable

height from the floor, thus saving floor space. This nest is movable. The sloping top prevents hens perching on it. Fig. 37 shows a good nest for a sitting hen. Fig. 38 shows similar nests built in pairs, and with movable front to confine the hens to the nests at the will of the keeper. Fig. 39 shows how nests may be placed in a partition and each nest connected at will with either of two pens.

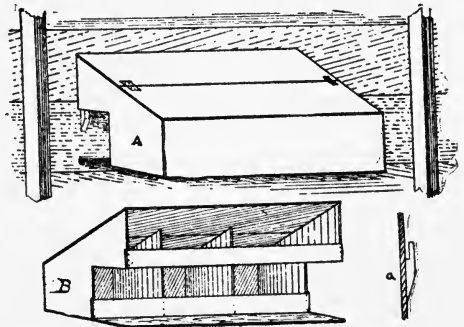

Fig. 36. Dark Nest to hang on Wall. A, exterior view; B, interior view; a, mortised block to hold nest in place.

of two pens. The particular advantage of these reversible nests is that they do away with the changing of the broody hens to new nests. Fig. 40 shows how the fronts of the nests are made. Covered nest boxes should be not less than 12 in. high, (14 in. is better), and from 12 to 14 in. square, according to the size of the hens.

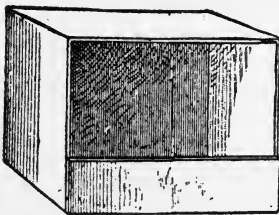

Fig. 37. Nest for a Sitting Hen.

Patent Nest Boxes.—Nest arrangements designed to show which hens are laying, and also to keep laying records of individual hens, cannot be described or illustrated here. The best of them are patented. The others do not meet general approval. Those wishing such nests will find them advertised in the poultry papers. They are not expensive, and, once used, are considered indispensable.

54. Feed Troughs.—The common V-shaped trough is the cheapest and most easily made. A trough 3 ft. 4 in. long may be made from a 10-in. board 4 ft. long, at a cost of about five cents.

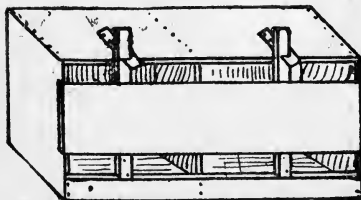

Fig. 38. Double Nest Box for Sitters.

To make such a trough cut a piece 8 in. long from the board: cut this again

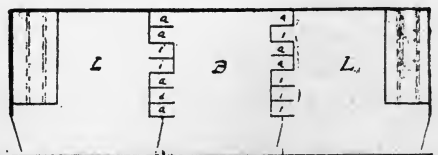

Fig. 39. Reversible Nests to go in partition between pens.

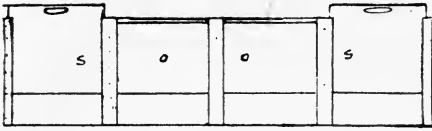

Fig. 40. Front of Reversible Nests, showing nests at o o, open; at s s, closed.

trymen use a shallow flat-bottomed box saving trough of this kind is made by using nailed at the middle to the edges of the bottom, thus making a reversible trough. A trough on the floor of a pen catches some litter and dust, which have to be removed before food is placed in it. This is usually effected, with an open trough, by turning it over. The reversible trough saves the movement of turning the trough back — quite a saving in a year on a large plant. Fig. 41 shows two feed troughs designed to keep fowls from getting in the troughs and fouling the food with their feet. Such troughs

should be used if soft food is allowed to stand before the fowls. In a clean house and for fowls fed only what mash they will eat “clean and quick,” the plain troughs are just as good. Those who want something nicer than the homemade trough of the practical poultryman will find several good feed troughs on sale.

lengthwise, making two pieces each 5 x 8 in. These are for the ends. Cut the remainder of the board in two, lengthwise, making one piece 4½ in. wide, the other 5½ in. wide. Nail the wide piece to the narrow one; nail on the ends. Many poultry-trough, 6 or 8 in. wide for the sides pieces 4 or 5 in. wide

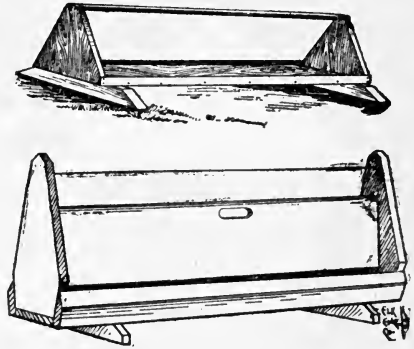

Fig. 41. Feed Troughs.

55. Drinking Vessels. — There are a number of different styles of drinking fountains made especially for fowls, on the market. Many poultry keepers prefer open drinking vessels. These may be of iron, galvanized iron, granite ware or tin. Objections to the use of tin drinking vessels because oxide of tin is a poison, are very far fetched. The amount of poison a fowl would take from the drinking water is infinitesimal. It is not advised to buy tin drinking vessels, — for in the end they are most expensive, — but often it is found convenient to use as drinking vessels tinware discarded for kitchen purposes. In a modern poultry house the water pans are placed on shelves, high enough from the floor to keep the “rough” of the dirt out, either in the hall partitions or in partitions between pens. They are sometimes protected by slats, but such an arrangement does not favor dispatch in cleaning and refilling vessels. Devices of this kind are often strongly recommended by those accustomed to their use, though the benefits are, all things considered, questionable. No matter what arrangement is made to keep coarse dirt out of the drinking pans, the fine dust, which is the objectionable and more injurious dirt, settles in them, and should be removed as often as fresh water is given.

56. Receptacles for Grit and Shell.—One of the most convenient of these is a metal trough, like a piece of the water gutter used under the eaves of buildings. This can be either attached to the wall or placed in a partition. A similar grit trough is easily made of wood, by making a short V-shaped trough with the angle of the sides very acute. In one side holes can be bored by which to hang the trough to nails driven into the wall at a suitable height from the floor. Boxes for grit and shell are sometimes made with hopper-like receptacles for a store of grit, the bottom of the box being a tray into which the grit feeds from the hopper as fast as taken from the tray.

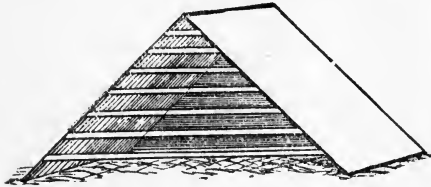

Fig. 42. Common A-shaped Coop.

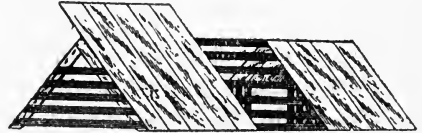

Fig. 43. A-Shaped Coop with Pen and Movable Shelter Board.

57. Coops for Broody Hens.—A small coop built into a corner of each laying pen, close to the roof, is a common provision for breaking up broody hens. Such a coop should be triangular. The outside wall forms one side, the cross partition the other. The front should be of slats, one or two of them being movable to admit the hens. Detached coops, having slat bottoms are often used, and are by some preferred, because the hens have to roost on the slats, and cannot continue brooding, as some hens will, in a corner of the coop.

58. Coops for Little Chicks.—Of these there is an almost endless variety, conforming generally to one of two plans; they are either A-shaped or box coops. Fig. 42 shows a common A-shaped coop, without floor or coop-pen for the hen. Fig. 43 shows another style of A-coop with partly closed front, coop-pen, and movable shelter board to keep out sun and rain. This

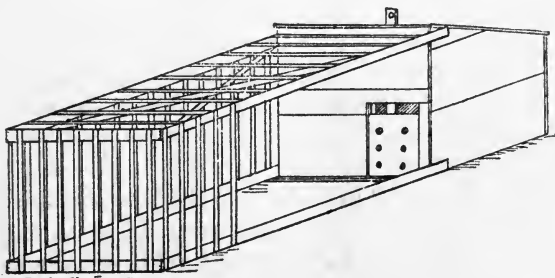

Fig. 44. Convenient Box Coop with Knock-down Pen.

coop may be made either with or without floor. A permanent floor in a coop of this shape is objectionable because of the difficulty of keeping the corners between floor and sides clean. This can be overcome by using a movable floor, which is easily made to slide in grooves formed by cleats near the bottom, (inside), of the sides of the roof. The coop from which the illustration was taken was of matched flooring, the sides of the roof 22 x 28 in., the angle between them a right angle; the coop pen 4 ft. long.

In Fig. 44 is shown a cheap and convenient box coop with "knock-down" coop-pen. This coop is 22 x 24 in.—outside measure,—on the ground; 24 in. high in front, and 16 in. high in rear. When made of these dimensions and of 10-in. boards the waste of material amounts to almost nothing. In the coop illustrated the standard of the door moves in a slot cut in the roof. The roof is nailed fast. The coop is cleaned by tipping the dirt to the back, then to corner opposite the door, then out through the door, the hen being meantime confined to the pen by a screen of lath placed across the end left open by the tipping back of the coop. Complete ventilation is insured by boring large auger holes in the door and in the upper part of the front; or, a crack an inch

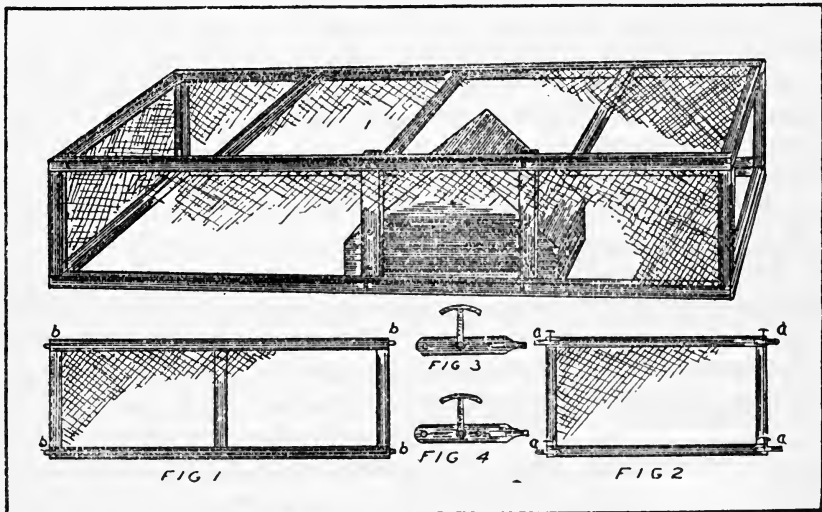

Fig. 45. Cat and Hawk Proof Coops. (By courtesy of Chas. Bennett).

BILL OF STOCK FOR ONE COOP:—

4 pieces 7-8 x 4 in. spruce 12 ft. long.	5 pieces 2 in. furring 5 1-2 ft. long.
4 pieces 7-8 x 4 in. spruce 5 ft. long.	8 hook clasps.
11 pieces 7-8 x 4 in. spruce 2 ft. long.	8 good sized staples.
2 pieces chicken netting (1 in. mesh) 18 in. wide, 12 ft. long.	
2 pieces chicken netting (1 in. mesh) 18 in. wide, 5 ft. long.	
1 piece wire netting (2 in. mesh) 5 ft. wide, 12 ft. long.	

TO MAKE UP:—Take four of the 12 ft. pieces and six of the 2 ft. pieces, and make two frames 2 x 12 ft. like Fig. 1. Then make two frames 2 x 5 ft. like Fig. 2. Now take the hook clasps, like Fig. 3, and drill and countersink an extra screw hole as in Fig. 4. The house for the chickens to stay in nights is shown, rear view, in the upper figure in the cut. It is made of 3-8 or 1-2 in. stuff. Make the floor 2 ft. square. Then take three pieces 7 or 8 in. wide for the walls. Nail the bottom to these. Then put roof on, being sure not to get it more than 2 ft. from floor of coop to peak of roof. On the back side, a few inches from one end, put a 2 ft. piece perpendicularly. This is to attach the house to the side of the coop so that it can be lifted with it.

Now take the hook clasps and put them on corners of Fig. 2, letting them project far enough to take the staples that are to be driven into the corners of Fig. 1. After hooking the end and side pieces together put a board on the front of the coop that will just fill the opening, hanging it with hinges from the top, so that when raised it will make a shade. Fasten a stick 2 1-4 to 3 ft. long to the lower edge of the door, to project through the netting of the top of coop. This is to open and close the door. Put the five pieces of furring across the top of coop, one at each end, one at the center, and one at the center of each space, and nail lightly. Spread the 2 in. netting over, and fasten with staples to the furring. After the season when you want to put the coop away take off top netting with the sticks, and roll up. Unhook the corners, take off house, and lay one of the long sides on the ground, cleats up, put ends on between the cleats, put other side on cleats down, drive a few nails where they will hold all the parts together, and the whole thing can be put away in a small space.—C. BENNETT.

wide may be left clear across the front. For spring and summer use it is better to leave the joints, between boards on the sides, uncovered. The joints in the roof should be covered with strips of lath or batten. The slide door can be placed outside if desired. Coops of this style are often made with hinged roofs, sometimes with only a part of the roof, or the lower half of the back on hinges to allow the coop being cleaned without being moved. A point to be always observed in making a coop of this kind is: if the roof is nailed fast, the door must be next a corner, to facilitate cleaning. The coop pen shown in the figure is 4 ft. long, 2 ft. high, 2 ft. wide between the side rails. The top and bottom rails are of 1-in stuff 2 in. wide. The sides and end are made separate; then the end is nailed to the sides, cross braces of lath nailed to the lower edges of the top side rails, the laths put on the top, the last lath at the open end being 4 in. from the ends of the side rails; a single strip of lath is nailed to the lower edge of the bottom side rails 4 in. from the end, and the pen is complete. When coop and pen are placed together, the ends of the side rails overlap the sides of the coop, and fitting snugly, hold the pen firmly in place. The coop is taken apart by simply taking off the top laths, removing braces, and knocking out the end. The spaces between the slats should be: on top, 3 in.; on sides, $2\frac{1}{2}$ in. for medium to small hens, 3 in. for medium to large ones. The material for a coop and pen as shown in the figure will cost about fifty cents.

59. Roosting Coop for Growing Chicks.—Fig. 46 shows a roosting coop of the general type used for growing stock when on summer range in fields and meadows. The front is

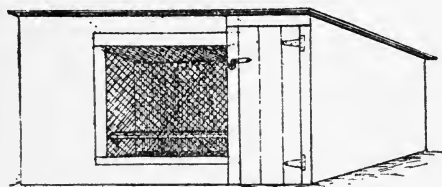

Fig. 46. Roosting Coop for Growing Chicks.

sometimes all of lath or netting, sometimes boarded part way down, and sometimes made close with tight door and movable window. A coop with the front last mentioned can be used in cold weather. These roosting coops are usually without floors. They should be of a size easily handled — 6 to 8 ft. long, about 3 ft. wide, 2 to $2\frac{1}{2}$ ft. high in rear, and 3 to $3\frac{1}{2}$ ft. high in front. Two roosts are placed in each pen about a foot from the ground. Coops of this kind can be bought in knock-down bundles at reasonable prices.

60. Incubators.—The large poultry keeper takes it for granted that incubators are to be a part of his equipment. A few of the older breeders, whose trade is principally in stock and exhibition birds, still hatch with hens; but for producing broilers and pullets in quantities for early layers, the artificial is the reliable method. On most large plants where hens are used their work is complementary to that of the machines. The small poultry keeper is often at a loss to know which method of hatching to use. It depends on the person as much as on circumstances. Some people cannot run an

incubator, or a machine of any kind, for three weeks without having something go wrong. Again, there are those who "have no luck" hatching with hens, yet are fairly successful with machines. So that it is difficult to frame a rule which can be uniformly applied. It may be said, however, that a poultry plant, though small, which is concerned with the production of early layers, or is stocked mostly with hens of non-sitting breeds, ought not to be dependent on hens for hatching. And, considering the degree of efficiency to which incubators have been brought, the practice of most progressive poultrymen, and the tendency toward a more general use of artificial methods, it is safe to advise that whenever more than two or three hundred chickens are to be hatched the incubator should be the main reliance. To the considerations named, add that the incubator is always ready for work. It is seen that even those who hatch annually less than two hundred chicks may find an incubator invaluable. Though in many cases hatching with hens is cheaper, and there are times—(as in hatching small lots of eggs from different pens, or of different varieties)—when a machine cannot well be used, a poultry keeper entirely dependent on hens for hatching is in a bad fix when the hens fail him. Delay in getting broody hens is one of the commonest causes of loss and disappointment in small poultry yards.

It is wiser to buy an incubator than to attempt to make one. Good incubators are sold at such low prices that there is little inducement to risk a homemade machine, though it were cheaper, which is to say the least, doubtful. The selection of a machine need not be the perplexing question some make it. Results with the best machines do not differ greatly. There are, to be sure, poor machines on the market; but it is easy to learn what machines are in use on the large market poultry plants where poor machines are not tolerated. If the beginner has to learn, unassisted, to run his machine, it will matter little which of the popular makes he buys. If a particular machine is being operated in his vicinity by some one who will give him instruction in incubator management, it is clearly to his advantage to buy a machine of that make.

61. Brooders.—Brooders are used even more generally than incubators. Many hatch with hens, and rear in brooders. Where incubators are used brooders are used as a matter of course. Brooder houses are an important part of a large plant. For small operations, either a small pipe system, an indoor brooder—in a house pen, or a detached brooder house—or an outdoor brooder, which needs no house, is used. What was said of homemade incubators is equally true of homemade brooders. Brooders can be purchased either direct from the manufacturers, or through dealers in poultry supplies. Pipe systems for any size of house desired are sold complete with full instructions for putting up, and sometimes with detailed plans of houses best suited for use with the system. In buying separate brooders it is well to remember that manufacturers usually overrate the capacity of brooders, that

the use of brooders of large capacity is not generally approved by experts, and that allowance must be made for the growth of chicks.

62. Feed Cookers.—Wherever a large stock of hens is kept, provision should be made for cooking the mash. On plants where a steam boiler is used, food is cooked in steam jacket kettles. Where steam is not available, set kettles—or, more commonly of late years, feed cookers, specially constructed stoves with large boilers—are used. For baking johnnycake for chicks, an oil or gas stove with oven may be used.

63. Feed Mixers.—Patented machines for mixing feed, either wet or dry, are on sale. Poultrymen who mix mill stuffs in proportions to suit themselves, will find it worth while to examine them.

64. Bone Cutters.—It is often hard to decide whether to use a bone cutter or buy prepared meat foods. Green cut bone is considered the best cut food of the kind; but it is not always possible to get fresh bone regularly, nor is it always economy for the poultryman to spend time and strength in running a bone cutter. Where the commercial products can be had without the addition of heavy freight bills to the cost price, it is more satisfactory to use them; elsewhere it is better to use the bone cutter. Many poultrymen cut as much green bone as they can, and also use prepared foods.

65. Grit Crushers.—There are few places where, if the commercial grits are not on sale, a natural substitute cannot be found. Wherever there is a gravel bed grit is easy to get. In the far west many poultry keepers use the coarse gravel from the large ant hills for grit. For those who must manufacture the grit they use, it is better, and in the end cheaper, to buy a grit crusher than to use primitive methods of grit making. The cost of the machines is small.

66. Hay Cutters are indispensable where many fowls are kept. On farms the hay for the hens can be cut in the large hay cutter gauged to its shortest cut. If a cutter is to be bought to cut hay for hens, one of the small machines made for poultrymen is preferable.

67. Miscellaneous.—In addition to the things specially mentioned in the preceding paragraphs, a poultryman's outfit includes: pails, for feed and water; scoops and spoons, or trowels for feeding; large coal buckets, for collecting droppings; hoes, rakes, shovels, forks, brooms, a wheelbarrow, etc.

NOTE.—Articles used particularly in dressing and marketing fowls will be described in the chapter devoted to those topics.

CHAPTER V.

Fowls Described.*

68. Kinds of Fowls.— *Common or Mongrel.*— Old dunghill stock more or less improved by irregular infusions of pure blood.

Fowls produced by indiscriminate crossings of pure breeds.

Cross bred,— produced from cross matings of pure breeds— usually applied only to the offspring of a first cross— further crossing producing either grades or mongrels, according as it is systematic or indiscriminate.

Grade,— produced by systematic crosses of a pure breed on another pure breed, or on common stock.

Pure bred,— thoroughbred, — the product of a union of typical specimens of its breed or variety, which, when mated to the breed type of the opposite sex produces offspring of both sexes true to type.

Standard bred †— bred to conform to the description of the breed or variety in the American Poultry Association's ‡ Standard.

*NOTE.— In the poultryman's vocabulary the word "fowl," used without a qualifying word, as *water-fowl*, *guinea-fowl*, always means "chicken"— specifically an adult chicken; while the words "chicken," and "chick," are applied to the young of the fowl.

†NOTE.— The terms, "standard bred," and "thoroughbred," are often used as synonyms, and in many cases are properly so used. Nearly all varieties which become at all popular are "admitted" to the Standard, and nearly all the varieties described in the Standard are thoroughbred. There are, however, pure breeds not recognized by the American Poultry Association, and fowls of recognized varieties may be pure in blood and well bred without conforming strictly to Standard requirements. The Standard color requirements for some varieties are such that the best types of the different sexes are produced from different matings, only one parent in each case being of the type desired in the offspring. Fowls bred in this way are in reality first crosses of distinct types of the same pure breed. There are some breeders of all varieties for which the system of double matings is used who use single matings, and produce stock that is thoroughbred and standard bred— though not, perhaps, reaching as high a degree of excellence as stock from the double matings.

Recognition by the American Poultry Association is not an indication of the popularity

69. Comparison of the Kinds of Fowls.—With other than pure bred fowls the progressive poultry keeper has little to do. With common or mongrel fowls he concerns himself least of all. That some mongrel hens are healthier and more prolific than some high class stock, is true. The converse of the proposition is equally true. As between all common hens and all pure bred hens, there is little to be said for common hens. The experience of most of those who are thoroughly familiar with both classes of stock has been that, with rare exceptions, they could get better practical results from thoroughbreds taken at random than from the most carefully selected common stock. The pure bred fowl is the result of selections extending through a long course of years. However faulty selection may at times have been from the economic point of view, the general result has been infinitely better than the *natural* selection which was given free course in the common fowls. It is not advised that a flock of mongrels doing well or fairly well be discarded out of hand, and a new beginning made with pure bred stock. It is advised that the mongrels be either graded up to the type of thoroughbred best suited to the keeper's purpose, or be gradually replaced with thoroughbred stock.

As between cross and pure bred fowls, it may be said that rarely is there produced a cross the good qualities of which cannot be paralleled in one or more pure breeds. Grades having three-fourths or more of the blood of a pure breed will usually be on a par in utility qualities with the average of that breed. Crossing and grading are ordinarily to be resorted to only for the purpose of utilizing stock on hand. They are emergency methods. A poultryman who continuously produces fowls of impure blood throws away one of his best chances of profit; for in the long run it costs no more to produce pure stock; and while sometimes pure stock of good quality has to be sold at the market price for poultry, it is certain that crosses and grades will not at any time bring much more than market prices — not often enough more to pay for advertising and cooping for shipment. It is the hereditary fixedness of certain desirable qualities and characters that gives the popular varieties of pure bred fowls — (whether bred for utility or fancy)—their superiority as money makers.

or value of a breed. Breeds and varieties which never become popular with any class of poultry keepers are recognized in the Standard, while useful breeds quite widely popular are rejected. Of more than seventy varieties of fowls, (excluding bantams), described in the Standard, less than half are popular,—*i. e.*, varieties commonly bred; and of these less than half, again, are popular in the sense of being commonly and extensively bred,—bred by those who keep fowls on a large scale.

‡NOTE.—*American Poultry Association*,—an organization of poultry breeder and fanciers, composed of persons who, their applications having been approved by vote of the association, become life members on payment of a fee of \$10. Though not a representative organization, its Standard descriptions are accepted by nearly all poultrymen, even those who breed for economic purposes breeding to Standard types as closely as they can without sacrificing utility qualities—as would be done in some cases by strict adherence to the Standard.

70. Relative Merits of Pure Bred Fowls.—It was said of situation that fowls could be kept wherever men could live. It might be said of the different varieties of fowls, that there is hardly one that could not be made commercially profitable even by market poultrymen and farmers. People who keep fowls for profit want not profit merely, but the greatest possible profit. The common experience of poultry keepers has sifted from the great number of varieties the few which with ordinarily good care and housing will yield the largest and surest returns. These are usually spoken of as the “practical breeds.” It will be seen as the varieties are described that often a single feature makes a variety objectionable for some purposes. This point will be considered more fully in the next chapter. It is mentioned here that the reader may keep it in mind when making comparisons of varieties. He will thus better understand how it is that the money making ranks of some excellent varieties are lower than their merits seem to deserve, and why it is that of two varieties nearly equal in average merit one may be very much better adapted to some special purpose than the other.

71. Terms Explained.—A few terms used in describing varieties need explanation.

Fowls are often classed according to economic qualities, as “egg breeds,” “meat breeds,” “general purpose breeds.” Such terms describe the prominent characteristic of the common type of a breed, and indicate the purpose for which *flocks* of the breed are commonly kept. Of so-called “egg breeds,” the most typical examples are Leghorns and Minorcas; of the “meat breeds,” there are three distinct types represented by the Brahma, the Dorking and the Cornish Indian Game; of “general purpose breeds,” Plymouth Rocks and Wyandottes are familiar illustrations. It must not be thought that fowls of the “meat breeds” are not good layers; or that good poultry cannot be produced from the egg breeds; or that “general purpose breeds” unite in perfection all the good qualities of domestic fowls. The “general purpose fowl” is a combination fowl of a type intermediate between the “egg” type and the Brahma “meat” type. General purpose breeds combine a high degree of excellence as egg producers with great merit as table poultry, and especially with adaptability to being fitted for the market at any time after reaching broiler size. Some breeders of Brahmas and Cochins breed fowls which for profitable egg production crowd the best “egg breeds,” and some breeders of the Mediterranean varieties prefer a type of fowl which is easily made profitable as poultry. Thus the choice of breeds is not always as limited as the general descriptions would imply.

Very hardy is applied to the breeds best able to resist exposure and unfavorable conditions. *Hardy* is applied to breeds which under ordinary conditions are generally free from disease. *Fairly hardy* is used to describe breeds requiring a little extra attention to keep them free from disease. *Rather delicate*, *delicate*, and *very delicate*, are used to express, as nearly as

possible, the relative vigor of the less hardy breeds. All these terms should be understood as of general application describing the average of the breed, not specimens or flocks noticeably better or worse than the average.

So the words, "sitters," and "non-sitters," must be understood as expressing general characteristics. It is doubtful whether there are any breeds strictly non-sitters. In nearly all of the so-called non-sitting varieties hens are sometimes found which show the desire to incubate. This does not necessarily indicate impurity of blood. In some of the "sitting" varieties are whole families or "strains" in which the desire to incubate is nearly lost.*

Eggs are usually classed according to color of shell, as "white" or "brown." In the white egg breeds the shells of the eggs are not pure white, but slightly tinted with a cream or flesh color. Hens of these breeds rarely lay eggs that are even a very light brown. In the colors of shells of the eggs of the brown egg breeds there is great variety, — tints ranging from a rich brown to creamy white. The very dark shelled eggs are usually characteristic of strains bred especially for market eggs.

Descriptions of Pure Bred Fowls.†

AMERICAN CLASS.

72. Plymouth Rocks.—*General Description.*—Hardy; general purpose; brown egg breed; sitters; medium to large in size. Standard weights, cock $9\frac{1}{2}$ lbs., cockerel 8 lbs., hen $7\frac{1}{2}$ lbs., pullet $6\frac{1}{2}$ lbs. The typical Plymouth Rock is a compactly built, strong, but not coarse boned fowl, the general contour of the body presenting the "wedge" shape so noticeable in a good dairy cow. This is more readily seen in the females than in the males, whose more erect carriage and lesser abdominal development takes away somewhat the wedge-like appearance of body. In all varieties the comb is single‡ and serrated, in size medium to small; ear lobes red, tail of medium length, and abundant. In beak, shanks and toes, deep yellow is the color coveted by fanciers. The skin should be yellow.

*NOTE.—Those who raise chicks with hens will always find it worth while when buying stock, to learn something of its incubating propensities; otherwise they may be disappointed in getting early chicks, for besides those families in which the hatching instinct is bred out, there are others the hens of which regularly continue laying for from three to five or six months after beginning without going broody.

†NOTE.—In describing varieties, a few non-Standard fowls, both domestic and foreign, are included with the classes to which they would naturally belong if admitted to the American Standard of Perfection, the arrangement of which is followed in these descriptions. The descriptions are not intended to be minutely exact. The purpose is to give to those not familiar with the varieties a general idea of the character and appearance of each, which if not entirely accurate, will not be misleading.

‡NOTE.—A variety with pea comb was admitted to the Standard, but failed to gain popular favor, and was subsequently dropped.

BARRED PLYMOUTH ROCKS.—Fig. 47.—The ground color of plumage varies

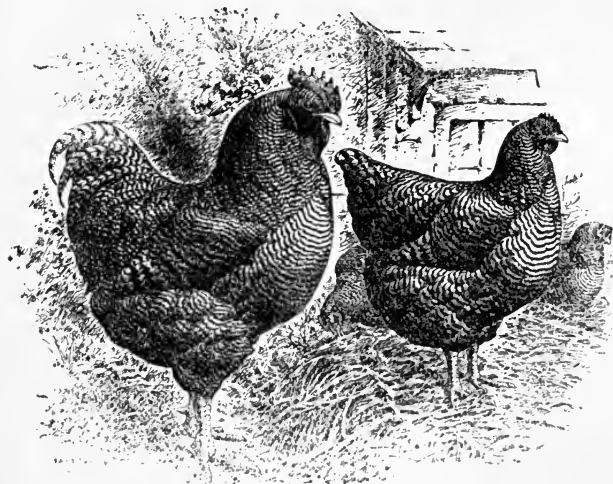

Fig. 47. Barred Plymouth Rocks.

from grayish white to pale ashen blue. In the best colored specimens the parallel bars crossing each feather run from leaden blue in light colored to blue black in dark specimens. In birds which fail in color the barring is usually indistinct; the dark bars show sometimes rusty red or brown, sometimes a greenish tinge. Clear yellow legs and beaks are common in the males, but not in

females, which oftener have a dark shading on the upper beak, and greenish shading or spots on the front of the leg. This variety is certainly the most popular of all with practical poultrymen, and, probably, also with fanciers. The difficulty of breeding it to the perfection of Standard color requirements, and the correspondingly high prices paid for first class specimens appeal strongly to the ambition and interest of the fancier-breeder. The double mating system is more generally practiced with this variety than with any other. It takes a novice some years to learn to produce high class stock. As commonly bred for practical purposes, little attention is given to nice color points.

WHITE PLYMOUTH ROCKS.—Fig. 48.—Were long considered more delicate than the Barred variety. With increasing popularity and more careful breeding for vigor they have become rugged. The Standard description calls for a *pure white* plumage, and yellow legs and skin; a com-

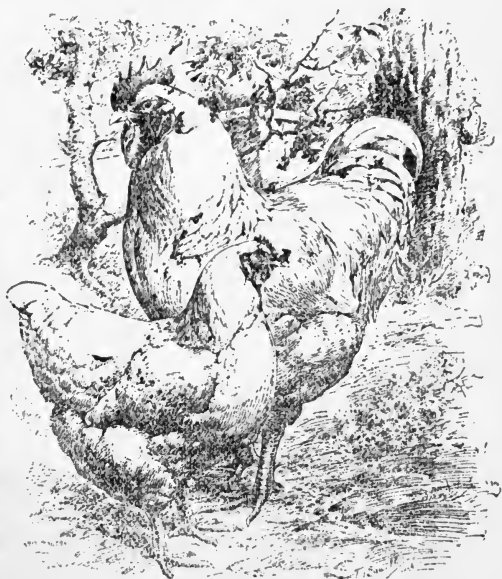

Fig. 48. White Plymouth Rocks.



Fig. 49. Buff Plymouth Rocks.

eties in practical qualities, they are not a good kind for a beginner who wishes to sell a part of his stock for breeding purposes. The variety is not well established, though many very fine specimens are produced. The color is difficult to handle, and in unskillful hands the proportion of culls is too large for profit. It is usually better for novices to leave the development of new breeds to experts. Breeders who will be satisfied for a few years with a large

combination difficult to get, and pronounced by many experienced breeders impossible to maintain. As a rule yellow legs and skin go with creamy white plumage, while a pure white plumage is accompanied by white or pink skin and faded yellow or flesh colored legs and beak. Practical breeders prefer the yellow legged fowls with a creamy white plumage, but avoid breeding from birds in whose plumage the yellow has unsightly prominence.

BUFF PLYMOUTH ROCKS.—Fig. 49.—A new variety, rapidly gaining popular favor. As in all buff fowls, the desired color is a uniform shade of buff free from white or black. Though the equals of the other varieties

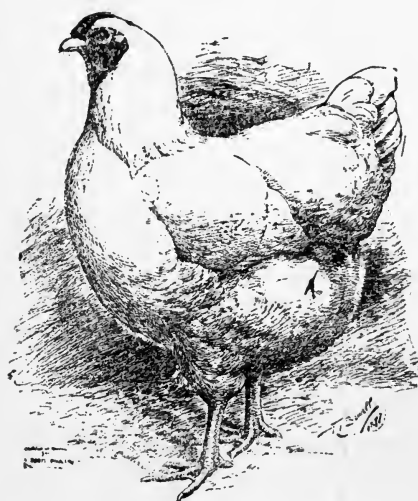

Fig. 50. White Wyandotte Pullet.
(By courtesy of A. G. Duston).

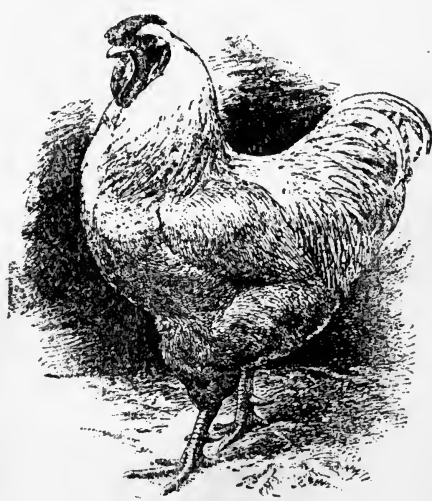

Fig. 51. White Wyandotte Cock.
(By courtesy of Howland & Whitney).

proportion of excellent fowls from the market standpoint, and a small percent of good Standard birds, will find the variety an interesting one to work with, and likely to prove immensely profitable in the future.

73. Wyandottes. — *General Description.* — Hardy; general purpose; brown egg breed; sitters; medium in size; Standard weights, cock $8\frac{1}{2}$ lbs., cockerel $7\frac{1}{2}$ lbs., hen $6\frac{1}{2}$ lbs., pullet $5\frac{1}{2}$ lbs. The distinguishing characteristics of the breed are the peculiar blocky, chunky body and small neat rose comb. Ear lobes are red; beak and legs yellow; tail medium length — abundant. In practical values they are generally rated with the Plymouth Rocks, but are less widely popular than that breed.

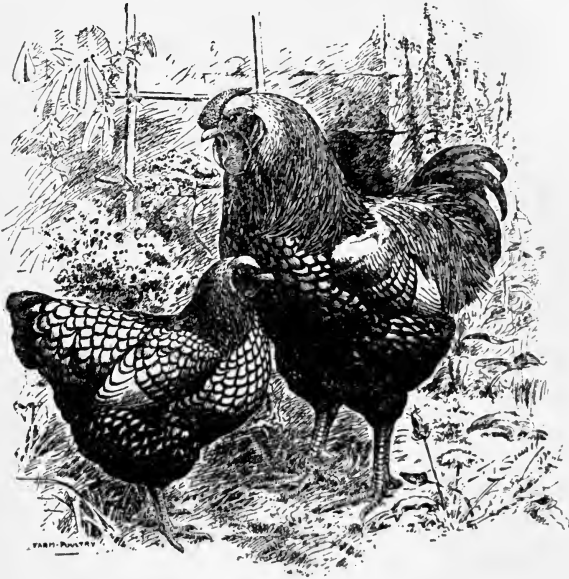

Fig. 52. Silver Wyandottes.

SILVER WYANDOTTES.
Fig. 52. — In color black and white, distributed as shown in the cut.

GOLDEN WYANDOTTES. — Figs. 53, 54. — In color black and golden bay, the bay taking the place of the white in the Silver variety.

Both of these varieties are difficult to breed to Standard colors. In some sections they (particularly the Silvers) are extensively kept by farmers. Both varieties are in demand among city poultry keepers, as their colors are not much disfigured by smoke, and they are not restive in close quarters.

WHITE WYANDOTTES. — This variety is the most formidable competitor the Barred Plymouth Rock has had to meet. The remarks on color of plumage, skin, etc., of White Plymouth Rocks, apply also to White Wyandottes. They are easy to breed uniform enough to satisfy a taste that is not fastidious about fancy points. This, and the absence of dark pinfeathers has brought them into high favor with practical poultrymen.

BLACK, AND BUFF WYANDOTTES. — After what has been said of the breed in general these need little description further than the naming of their colors. Black Wyandottes have never been popular with any class of poultry keepers. Buff Wyandottes are a new variety, and with Buff P. Rocks are strong competitors for the patronage which has been going to Barred P. Rocks and

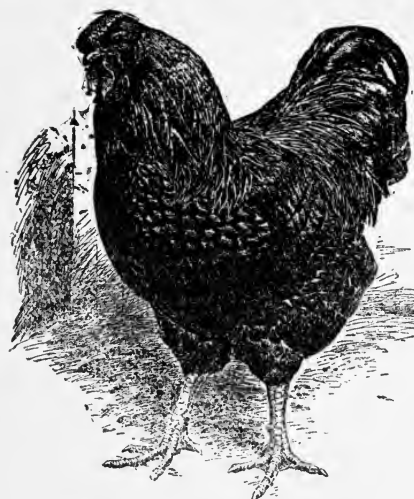

Fig. 53. Golden Wyandotte Cockerel.
(By courtesy of Ira Kellar).

White Wyandottes. The remarks on breeding Buff P. Rocks apply also to Buff Wyandottes.

74. Javas.—Black and Mottled.

Fig. 55. — Javas are fairly hardy, resemble Plymouth Rocks in general characters, and have the same Standard weights. They are longer bodied than the Plymouth Rocks. Their legs are willow colored. In most parts of the country they are rare. Mottled Javas are black and white in color. There is a white variety, very rare, and no longer recognized by the Standard.

75. American Dominiques. —

Fairly hardy; sitters; were at one time a very popular practical breed; superseded by the Barred Plymouth Rocks, which resemble them in color. Dominiques have rose combs, like those of Rose Comb Leghorns; red ear lobes; yellow beaks and legs; full, flowing tails.

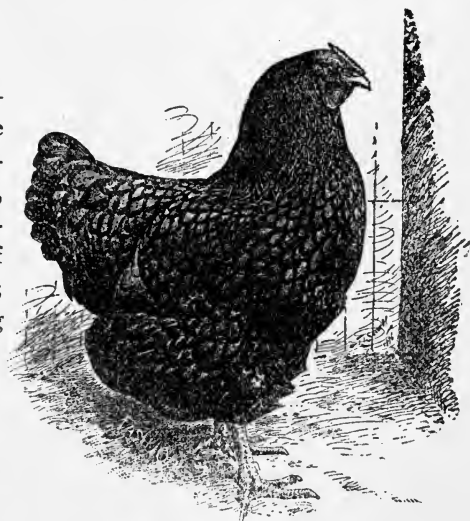

Fig. 54. Golden Wyandotte Hen.
(By courtesy of Ira Kellar).

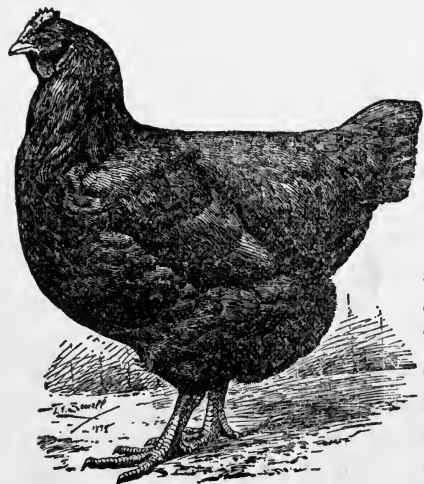

Fig. 55. Black Java Hen.

76. White Wonders.—(Non-Standard).

— Hardy; general purpose; brown egg breed; sitters; large medium in size. They somewhat resemble White Wyandottes, but are larger, and have lightly feathered shanks. They are quite popular among farmers and poultrymen in some localities, but are not much esteemed by fanciers.

77. Rhode Island Reds.—(Non-Standard).—Hardy; general purpose; brown egg breed; sitters; large medium in size. In color they are of a reddish buff, with a strong tendency to the black red color combination in the males. They are only locally popular, but are becoming celebrated for hardiness and prolific laying. In meat qualities they are considered inferior to the other American varieties.

ASIATIC CLASS.

78. Light Brahmas.—Fig. 56.—Very hardy; meat breed; large brown eggs; sitters; the largest variety of fowls. The Standard weights, cock 12 lbs., cockerel 10 lbs., hen 9½ lbs., pullet 8 lbs. Colors, black and white, as seen in the cut, except that in the flight feathers of the wings, not visible when folded, black largely predominates. They have pea combs; red ear lobes; short, full, spreading tails; beaks yellow, with horn colored stripe on upper bill; yellow skin and legs; the outer sides of shanks, and outer and middle toes heavily feathered. Light Brahmas are very popular with poultry keepers of all classes. Though considered a

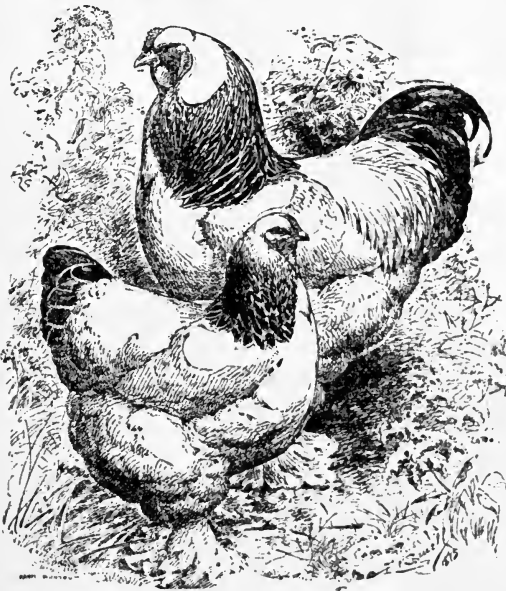

Fig. 56. Light Brahmas.

meat breed, they are good layers when handled properly, and they produce the most of their eggs when eggs bring the highest prices. If managed and fed right the chicks make good broilers or fries, and as large roasters the full-grown fowls are unsurpassed among pure bred fowls.

79. Dark Brahmas.—Fig. 57.—Hardy; meat breed; brown eggs; sitters. Except for their pea combs they would be classed by a novice as silver or gray Cochins. In shape they are between Light Brahmas and Cochins. Standard weights are: cock 11 lbs., cockerel 9 lbs.,

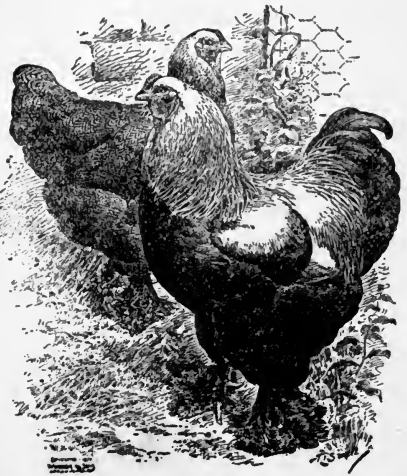

Fig. 57. Dark Brahmas.

hen $8\frac{1}{2}$ lbs., pullet 7 lbs., the same as for Buff, Partridge and White Cochins. In color they are white, gray and black combined as seen in the cut. Dark Brahmas are rather difficult to breed to color, and can hardly be considered popular, but are good and useful fowls.

80. Cochins. — *General Description.* — Very hardy; of all breeds the

least influenced by climatic or other changes, and least restive in confinement; brown eggs; very persistent sitters; combs single, serrated, small to medium in size; ear lobes red; plumage long, loose, fluffy; legs and toes heavily feathered. (On many of the heavily feathered exhibition Cochins the inner as well as the outer side of the shank is feathered). Cochins are generally considered inferior to Brahmas, both for eggs and meat. When bred to good breast development, fair specimens are quite the equals of the Brahmas as roasters. When bred for eggs they rival the best Brahmas as layers. As fanciers' fowls the Buff and Partridge varieties in



Fig. 58. Buff Cochins.

particular have many admirers. Probably the highest prices ever given for fowls in this country have been given for Buff Cochins. Breeding to excessive feathering has prejudiced practical breeders against all varieties of Cochins.

BUFF COCHINS.—Fig. 58.—Standard weights, cock 11 lbs., cockerel 9 lbs., hen $8\frac{1}{2}$ lbs., pullet 7 lbs.; color of skin and legs yellow; are the most popular variety. The prescribed color is a rich, deep, clear buff, uniform on each specimen. As there are differences of opinion as to what *buff* is, all shades are seen, from a pale lemon to



Fig. 59. Partridge Cochins.



Fig. 60. White Cochon Hen.

are common than the two foregoing. White Cochons have yellow legs and skin; Standard weights the same as for the Buff and Partridge. Black Cochons have yellow skin; and legs black or dark willow. The Standard weights are the same as for the other varieties, except cock $10\frac{1}{2}$ lbs.

a reddish brown; the lighter shades are generally preferred. Great skill in mating and handling is required to produce really fine specimens; but good birds are always salable at high figures.

PARTRIDGE COCHINS.—Fig. 59.—Weights, color of skin and legs same as for Buff Cochons. In color this variety shows the black red type, difficult to describe, but familiar to everyone in the Brown Leghorns. They are quite difficult to breed to Standard colors. Though not generally popular, they are in some localities quite extensively kept for practical purposes.

WHITE COCHINS.—Fig. 60.—**BLACK COCHINS.**—

81. Langshans.—*General Description.*—Fairly hardy; dark brown egg breed—eggs sometimes have a purplish tinge; sitters; large medium in size; Standard weights, cock 10 lbs., cockerel 8 lbs., hen 7 lbs., pullet 6 lbs.; medium sized single combs; red ear

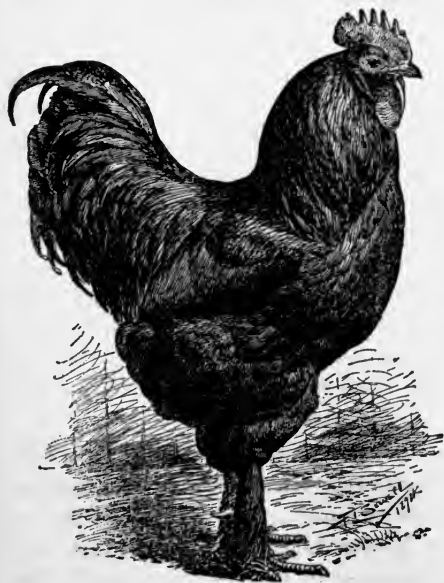

Fig. 61. Black Langshan Cock.

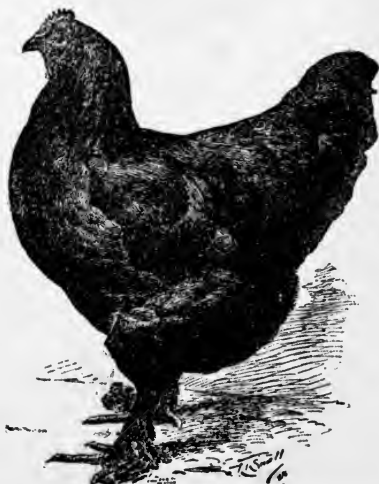

Fig. 62. Black Langshan Hen.

lobes; shanks and toes feathered, but not as heavily as shanks of Brahmas and Cochins. Beaks dark horn color; legs and toes bluish black; bottoms of the feet pink or pinkish white. (Yellow skin and yellow in the bottoms of the feet are considered indications of Cochin blood). Langshan tails are larger than those of Plymouth Rocks and Wyandottes, and carried well up.

BLACK LANGSHANS. — Figs. 61, 62. — Are popular among poultry keepers of all classes, except those making a specialty of market poultry. Their white skin and dark shanks are against them in American markets. They are particularly well suited to smoky towns where white and light colored birds soon become eye-sores to their owners. They are good winter layers, and make good poultry for home use.

WHITE LANGSHANS are not popular. They are useful and beautiful fowls, but the field for white fowls with their general characteristics has been occupied by other varieties.

MEDITERRANEAN CLASS.

82. Leghorns.—*General Description.*—Hardy; white egg breed; non-

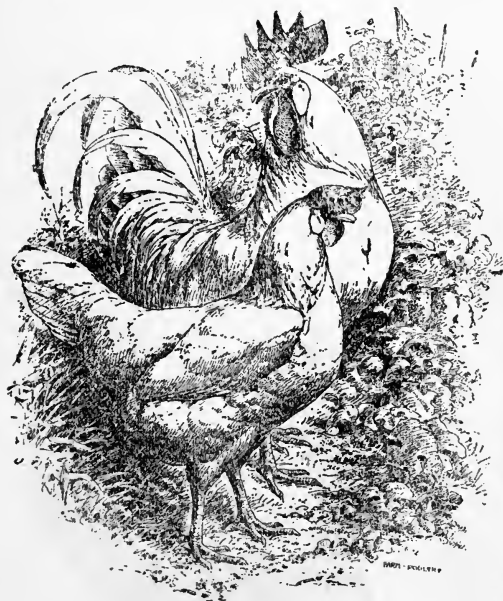

Fig. 63. Pair of White Leghorns.

sitters; small to small medium in size; no special weights required by the Standard; all varieties have white or creamy white ear lobes, smooth yellow legs, long and full tails. Leghorns are reputed the egg fowls *par excellence*. More people can get satisfactory egg yields from Leghorns than from any other breed. This is because Leghorns are generally hardier than the other white egg breeds, and are not so easily put out of condition by overfeeding as are fowls of heavier breeds. There is a strong tendency among Leghorn breeders to breed to a larger type than in the past. When bred to a good size, Leghorns make first class broilers, and very fair small roasters.

BROWN LEGHORNS. — Fig. 64. — There are two sub-varieties differing only in shape of comb and in popularity. The Single Combed Brown Leghorns are the most widely distributed of the Leghorn family. Rose Combed Brown Leghorns are not one-tenth as numerous. Brown Leghorns are the most common example of the black red color combination in fowls—colors so familiar everywhere that they need no general description. They are commonly rated



Fig. 64. Brown Leghorns.

WHITE LEGHORNS.—Fig. 63.—There are two sub-varieties, Single Combed and Rose Combed, having about the same relative popularity as corresponding sub-varieties of Brown Leghorns. Generally thought a little less hardy than the Browns. They average larger in size, and lay larger eggs. White Leghorns are extensively used on the large egg farms supplying the New York market.

BLACK LEGHORNS.—*Single Comb.* Not very commonly bred, because unable to compete with the Black Minorcas, which are in the same class, and are larger. The legs of Black Leghorns are not clear yellow, but a yellowish black or willow.

BUFF LEGHORNS.—*Single Comb.* Fig. 65.—The remarks regarding other new buff varieties apply to this one. The variety is still in process of making, and will not give satisfaction to those who want to produce a large proportion of high class birds, and know what a good bird should be. For all practical purposes they rival the best stocks of other varieties of Leghorns. They are not popular in the broad sense of the word, but in view of the increasing

better layers than the other Leghorns, though on the average their eggs are smaller than those of the White and Buff varieties. They may be said to be both easy and hard to breed. An inexperienced breeder, not versed in the fine points of the breed can produce stock much more satisfactory to himself than would come from his inexperienced matings of Barred Plymouth Rocks, or Silver Wyandottes. At the same time a trained fancier seeking to produce the finest Standard specimens finds his task hard enough to give zest to the work.

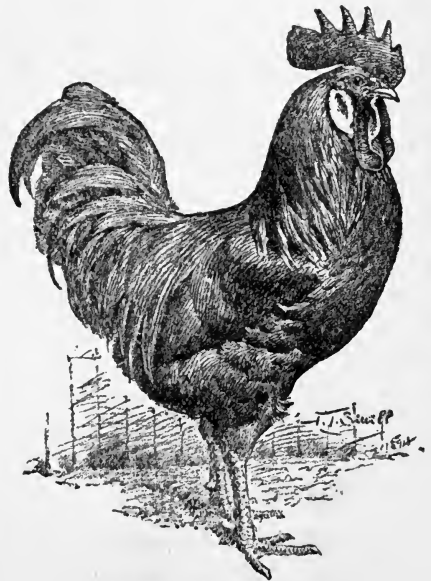

Fig. 65. Buff Leghorn Cock.

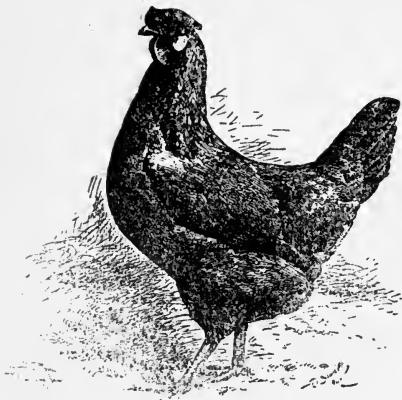

Fig. 66. S. C. Buff Leghorn Pullet.

83. Minorcas. — **BLACK MINORCAS.** — Fig. 67. — Fairly hardy; large white egg breed; non-sitters; medium in size; Standard weights, cock 8 lbs., cockerel $6\frac{1}{2}$ lbs., hen $6\frac{1}{2}$ lbs., pullet $5\frac{1}{2}$ lbs.; very large, single combs; white or creamy white ear lobes; white skin; slate colored legs; large, full tails. Minorcas are longer and deeper bodied than Leghorns, and have not the wild, nervous disposition of fowls of that breed. They are extra good layers of very large eggs, and make poultry choice for home use, but not marketable at best prices. They have their greatest popularity in the vicinity of New York and on the Pacific coast, and in these localities they are bred to equal or exceed Standard weights; but in many other sections the Minorcas generally are small, and not to be distinguished from Black Leghorns.



Fig. 67. Black Minorcas.

WHITE MINORCAS — are much less popular than the Black, which they resemble in every respect but color. With all white plumage they have beak and legs pinkish white.

84. Blue Andalusians. — Fairly hardy; large white egg breed; non-sitters; no Standard weights. In shape and size between Leghorns and

demand for buff fowls, a breeder planning for the future may find it profitable to develop a stock of Buff Leghorns.

OTHER VARIETIES OF LEGHORNS are: — *Dominique.* — (Non-Standard), rare; resembling Barred Plymouth Rocks in color. *Silver Duckwing.* — Not common; males look much like Brown Leghorns in which the red of the plumage is replaced by white; females are mostly light gray; light salmon in front of neck and breast; black or dark brown predominating in the tail.



Fig. 68. White Faced Black Spanish.

the abnormal development of the skin of the face, white in color. In general they resemble Black Minorcas. Were once quite popular; are now comparatively rare.

86. Polish.—Varieties: WHITE CRESTED BLACK, GOLDEN SPANGLED, (Fig. 69), GOLDEN PENCILED, SILVER SPANGLED, SILVER PENCILED, WHITE, BUFF LACED. With the

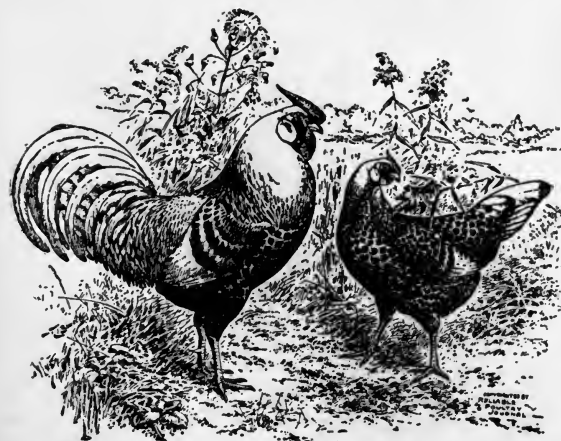

Fig. 70. Silver Spangled Hamburgs.

Minorcas. Color of plumage, light blue laced with darker blue, except that necks, backs, and tails in both sexes are dark blue, and in wings the flight feathers are light blue, the rest of the wing being darker blue. The legs are a slaty blue. Andalusians are not popular.

85. White Faced Black Spanish.— Fig. 68. — Very delicate as chicks, but fairly hardy after first few months; large white egg breed; non-sitters; peculiar characteristic,



Fig. 69. Spangled Polish.
(By courtesy of D. Lincoln Orr).

exception of the first and last mentioned these varieties are sub-divided into the *bearded* and *non-bearded*. Not one of these varieties is popular and common; all are regarded as distinctively fanciers' fowls. Even among fanciers the demand for them is small. Only a few breeders find it profitable to handle them. They are about the size of average Leghorns; delicate; white

egg breed; non-sitters; very large crests; small V-shaped combs; white ear lobes; slatish or willow legs; large, full tails. They are good layers, generally, and their flesh is of fine quality.

87. Hamburgs. — Varieties: GOLDEN SPANGLED, GOLDEN PENCILED, SILVER SPANGLED, (Fig. 70), SILVER PENCILED, (Fig. 71), WHITE, BLACK.

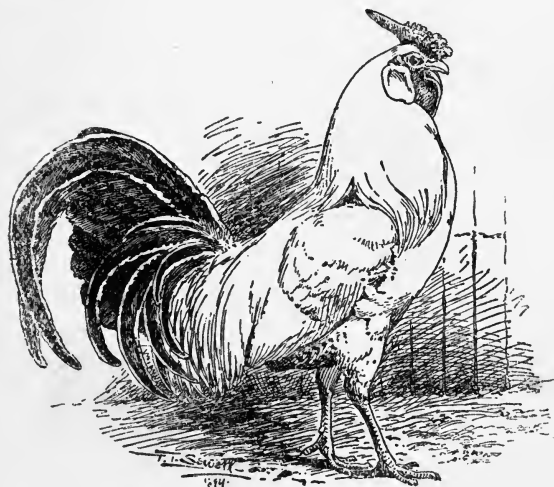

Fig. 71. Silver Penciled Hamburg Cock.

88. Redcaps. Rather delicate; white egg breed; non-sitters; have been aptly described as extra large, coarse Hamburgs with red ear lobes. Their colors are red brown and purple black distributed as in Spangled Hamburgs, except that the spangles of Redcaps are crescent shaped. Rare.

FRENCH CLASS.

89. Houdans. — Fig. 72. — The only breed in this class common enough in America to warrant description in a popular book. The other French breeds, LA FLECHE and CREVECŒUR, recognized by the Standard, are rarely seen here. Houdans, while not popular or numerous, are fairly well distributed, and are not unfamiliar in most sections; they are a rather delicate, white egg breed; non-sitters; colors black and white mottled, black predominating in the young fowls; large crests

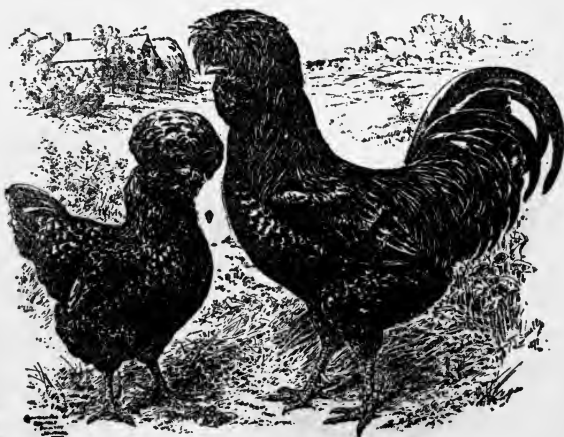

Fig. 72. Houdans.

Hamburgs do not greatly differ from the Polish except in furnishings of the head. They have neither crest nor beard; have rose combs like those of Rose Combed Leghorns; are rather delicate; a white egg breed; are non-sitters; more numerously bred than Polish, and considered better for practical purposes, but are altogether outclassed by the hardier Leghorns. Hamburgs are bred principally by those keeping fowls for pleasure.

and beards; V-shaped, leaf-like combs; white ear lobes; shanks pinkish white mottled with black, five toes on each foot; are good layers, equaling Leghorns in dry sunny situations; make good poultry, not suited to American markets because of its color. Standard weights, cock 7 lbs., cockerel 6 lbs., hen 6 lbs., pullet 5 lbs.

ENGLISH CLASS.

90. Dorkings.—A delicate (except on a large, well drained range) meat breed; inferior layers of eggs of medium color and size; sitters; bodies long, wide, deep; five toes on each foot.

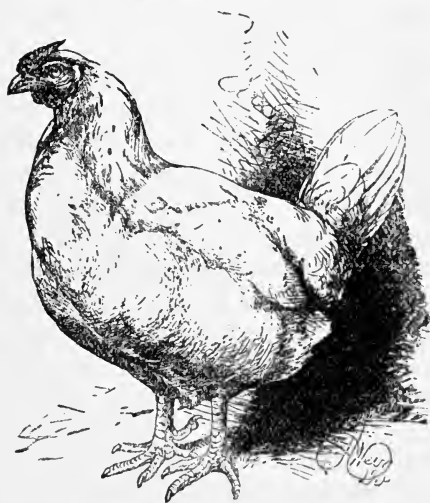

Fig. 73. White Dorking Hen.
(By courtesy of "Poultry," England).

WHITE DORKINGS.—Fig. 73.—The Standard weights are: cock $7\frac{1}{2}$ lbs., cockerel $6\frac{1}{2}$ lbs., hen 6 lbs., pullet 5 lbs.; rose comb; red ear lobes.

SILVER GRAY DORKINGS.—Fig. 74.—Standard weights, cock 8 lbs., cockerel 7 lbs., hen $6\frac{1}{2}$ lbs., pullet $5\frac{1}{2}$ lbs.; single combs; ear lobes, red preferred; in color resemble Duckwing Leghorns.

COLOR DORKINGS.—Standard weights, cock 9 lbs., cockerel 8 lbs., hen 7 lbs., pullet 6 lbs.; combs either single or rose; red ear lobes preferred; colors richer and deeper than in the last named variety, the white of which is black red. Colored Dorkings are bred to a fixed type only in shape.

91. Orpingtons.—A new English breed. Hardy; general purpose fowl. The breed was *made* especially for practical purposes, to produce eggs and meat. American breeders interested in fowls of that class, and disposed to experiment with Orpingtons are advised that such experiments are not apt to prove profitable. Without disparaging this breed at all it may be said that it cannot compete here with the American breeds of the same general class. Poultry keepers who want a good practical fowl *different* from anything their

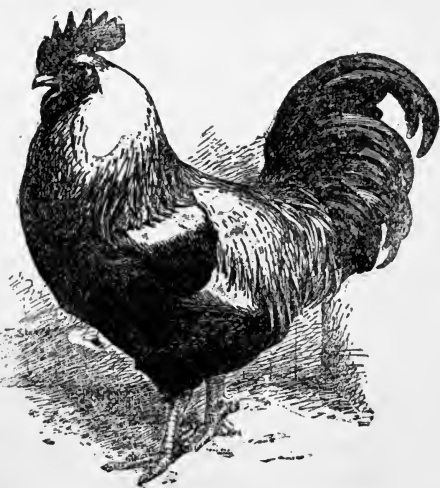

Fig. 74. Silver Gray Dorking Cock.

neighbors have, a consideration with some who keep poultry for pleasure, can get it in the Orpington. There are three established varieties: — **BLACK**, **WHITE**, and **BUFF**. In each variety there are single combed and rose combed sub-varieties.

GAMES.

92. Exhibition Games.— Fig. 75.— **Pit Games.**— There are two distinct types of Game fowls. The exhibition type is a bird very long in legs and neck, with stilted, crane-like carriage. The Pit Game is shorter in the leg, heavier in body, and a much better fowl for practical purposes. In sections where cock-fighting still prevails flocks of Games are kept for domestic purposes quite as often as flocks of any other breed. They are rated hardy; average layers of white or tinted eggs; are sitters; flesh makes fairly good poultry, but a trifle hard. Games cannot be considered as rivals of popular economic breeds. The color types in Pit Games are not well defined. They can hardly be classed as varieties. The Standard varieties of Exhibition Games are:



Fig. 75. Exhibition Game Cock.
(By courtesy of A. E. Blunck).

BLACK BREASTED RED, **BROWN RED**, **GOLDEN DUCKWING**, **SILVER DUCKWING**, **RED PYLE**, **WHITE**, **BLACK**, and **BIRCHEN**.

93. Cornish Indian Games.— Not very hardy; meat breed; they are ordinary to poor layers of tinted eggs; sitters; pea combs; red ear lobes; yellow skin and legs; Standard weights, cock 9 lbs., cockerel 7½ lbs., hen 6½ lbs., pullet 5½ lbs.; are very full in the breast, and broad at the shoulders; back, convex instead of flat or concave, as in most other breeds. There are two varieties, the **DARK**, (Fig. 76), and the **WHITE**, (Fig. 77); — the former, in color, a very dark black red (crimson); the Standard requires in the female plumage with bay ground double — or triple — laced with black. Usually these markings are not well defined.

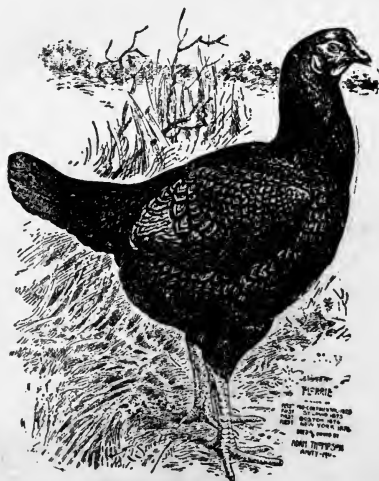

Fig. 76. Dark Indian Game Hen.
(By courtesy of Adam Thompson).

94. Malay Games.—Nearly as large as Indian Games; distinctive characteristics:—comb, a knob resembling a strawberry, dark red or purple in color; and fierce expression due to breadth of skull over the eyes; color black red, very dark; a fanciers' fowl; rare.



Fig. 77. White Indian Game Cock.
(By courtesy of E. M. & W. Ferguson).

95. Miscellaneous Breeds.—In this class the American Standard of Perfection places breeds prized mostly as novelties.

RUSSIANS.—Black; bearded, but not crested; medium size; rose comb without a spike.

SUMATRAS.—Black; heavy, drooping tails; dark red pea combs.

SILKIES.—Characteristic feature: webless, hair-like feathers.

SULTANS.—Resemble Bearded White Polish, but are smaller, and have feathered legs.

FRIZZLES.—Have feathers curled backwards at the ends.

RUMPLESS.—Tailless fowls.

96. Foreign Breeds. — New Breeds.—In nearly every foreign country there are distinct breeds, popular there, which have no particular interest for the American poultry keeper because not suited to any general demand in this country. New breeds and varieties are continually coming up here, most of them being boomed by the manufacturers for a little while, and then going to a deserved oblivion. Beginners and plain poultrymen should avoid new and rare breeds. Not one in ten will “go” with the buying public, and nearly always those who take them up lose money on them.

97. Complete Descriptions of nearly all varieties of fowls are given in the American Standard of Perfection, a book which ought to be in the hands of everyone who keeps pure bred fowls. Its descriptions are in skeleton form, but thoroughly cover the ground. Other books of great value to breeders are mentioned in the bibliography of poultry literature at the end of this volume. Complete descriptions cannot be given in a book like this, because in the first place they require a volume instead of a chapter; and, in the second place, the American Standard of Perfection, being the only general standard having the common indorsement, by usage, of poultrymen, complete descriptions would necessarily be based on it, and would have to be mere

juggles of words to avoid infringement of its copyright. While the Standard was subject to revision every five years, many small breeders felt it a hardship to buy a book which might soon be of no value. Now that the Standard is practically a permanent one, they may purchase it confident that changes made in future will not make obsolete the book they possess.

98. Abbreviations of Names of Varieties.— The abbreviations used in poultry papers and by poultrymen in correspondence often puzzle those not familiar with the names of varieties. Abbreviations are sometimes partial, sometimes complete. The most common are: Light Brahma, *Lt. Brahma*, or *L. B.*; Partridge Cochin, *P. Cochin*, or *P. C.* In names of Plymouth Rock varieties the *Plymouth* is often omitted, and sometimes the breed is spoken of simply as *Rocks*. Fully abbreviated, Barred Plymouth Rock becomes *B. P. R.*; White Plymouth Rock, *W. P. R.*; Buff Plymouth Rock, *Bf. P. R.* (The advent of some of the new buff breeds has caused confusion in some minds, as, for instance, whether *B. P. R.* referred to Barred or to Buff Plymouth Rocks; *B. Leghorn*, to Brown or to Buff Leghorn. In all cases of this kind, common usage gives the abbreviation to the name of the variety for which it was first used, and puts the distinguishing mark on the abbreviation of the new name). The word Wyandotte is abbreviated to *Wy.*, *W.*, or to '*Dottes*. Silver Wyandotte is abbreviated to *S. Wy.*; Golden Wyandotte, to *G. Wy.*; White Wyandotte, to *W. Wy.* *S. C. B. L.*, stands for Single Comb Brown Leghorn; *S. C. W. L.*, for Single Comb White Leghorn; *R. C.* stands for Rose Comb. *W. C. B. P.* is the abbreviation for White Crested Black Polish; *G. S. H.*, for Golden Spangled Hamburg; *S. P. H.*, for Silver Penciled Hamburg; *S. G. D.*, for Silver Gray Dorking; *B. B. R. G.*, for Black Breasted Red Game; *C. I. G.*, for Cornish Indian Game — usually applied only to the dark variety; *B. M.*, for Black Minorca, etc.



CHAPTER VI.

Choosing a Variety.—Buying Stock.

99. One Variety or More.—“For best results, keep but one variety,” say most experienced poultrymen. Few practice what they preach. It is not surprising, then, that their example has more weight than their precept. For most of those who keep fowls, one variety is *enough*. For many who want an income from poultry, one variety *is not enough*. “Circumstances alter cases.” The general rule should be:—*A flock (large or small) should not contain fowls of different varieties.* The application of this rule would settle the question for most poultry keepers. For the others, a good rule is:—*As many varieties should be kept as are needed to supply, to the limit of the capacity of a plant, the paying demand for its special products.* One may be enough. Even in an extreme case, it is not probable that more than three or four will be *needed*.

An error market poultrymen ought to avoid is:—keeping two or three varieties or breeds which, practically, fill the same bill. It does not often happen that more than one variety is needed for an exclusive market poultry plant. A market poultryman who sells some stock for breeding purposes does not always find the demand for stock of *his breeding*, of one variety, large enough to take all his surplus. By using two or more varieties, he can get the same results in the market branch of his business, and, being in a position to supply a more varied demand, may sell a larger proportion of his stock at the prices obtained for breeders. Thus his increased sales of breeding stock would justify the expense of maintaining breeding stocks of several varieties.

Except in the rare event of his having made a national reputation with a popular variety, a breeder-fancier needs several varieties. Even as a beginner, it is better that he should keep a varied stock. The results of his matings for the first few years are, if good, apt to be happy chances. Having several varieties, he will hardly fail to do fairly well with at least one of them. When a breeder's matings all disappoint him, his season's work is a total failure. Besides this, the beginner's position as a seller of good stock, is like that of the market poultryman who uses several varieties to better advantage than one. It would on the face of the matter seem wisest for the breeder to begin with one variety, adding others as he found demand for them, and as his skill in breeding increased; but, as a matter of fact, it takes less skill to breed several varieties to a fair degree of excellence than to breed one variety to very high excellence.

100. Testing Varieties.—How to Get Satisfactory Stock.—It is only when one is no longer a novice that he is able to see clearly the absurdity of a beginner keeping a number of varieties to test their merit, or to find out which he likes best. The general experience of poultry keepers is the best gauge of the relative merits of the breeds. The owner of several varieties usually comes to prefer that which is giving him best results. In buying stock of several varieties, one is not likely to get a uniform quality in all. It may easily happen that because he chanced to get extra good stock of an inferior, and poor stock of a superior variety, his short experience will lead him to prefer the one which in the long run gives poor results. Before deciding on a variety one should know its general character well enough to be sure that representative average specimens of that variety are fowls well suited to his purpose. Then if the fowls of the first purchase do not realize expectations, and it is evident that the fault is with the stock—not in his management—let him try again, *and again*. It is not the variety that is now on trial; it is the breeders of the variety. Stock of the kind wanted will be found more quickly and at less cost by limiting the search to the breeders of a single variety, than by extending it to the breeders of all varieties.

101. Breeds for the Market Poultryman.—The market poultryman must have the fowls that yield the largest, best distributed (through the year), and surest returns when the products are sold at market prices. Certain small “outs” in some varieties, of small moment to those who sell a considerable part of their stock at high prices for breeding or exhibition purposes, are not to be tolerated by the marketman. His business affords few opportunities for making large profits on a few sales compensate for small profits—or perhaps losses—on many sales. *Quick sales at living profits*, must be the market poultryman’s watchword. He must aim to have every article produced of a kind and grade always salable—convertible into cash at any time.

The first point to consider is the demand of the market to be supplied.

In most of the markets of this country strictly fresh eggs bring one price—regardless of color of the shell. In New York and vicinity white eggs; in Boston and vicinity, brown eggs are preferred. In nearly all American cities yellow legged, yellow skinned poultry finds readiest sale. Everywhere the most active demand for grown fowls calls for carcasses of four to five pounds each, and the demand for fowls dressing six pounds or over, or under four pounds, is comparatively light.*

A market poultryman sending produce to New York, will find that the trade wants large white eggs; is not particular about the color of the skin or legs of poultry. The popular varieties laying large white eggs are, Brown and White Leghorns, Black Minorcas, with Buff Leghorns and, possibly,

* NOTE.—This demand for medium sized fowls is not in any way dependent upon, or governed by, the quality of the meat. Medium sized fowls are in demand because they are of the *size* wanted by the greatest number of buyers.

Houdans, entitled to mention, (in that section). It will be found that these varieties are relatively more popular in the country tributary to New York city than elsewhere;—the three first named being those preferred by the large egg farmers. A beginner will do better to profit by their experience than to be governed by his personal preferences should they run counter to common experience.

A market poultryman locating near Boston, will find Barred Plymouth Rocks, White Wyandottes, and White Plymouth Rocks most popular among market poultrymen using thoroughbred fowls. These varieties best fill the requirements of:—brown eggs, fitness for market at any age, and ease of preparation for market. He will find other varieties of the American and Asiatic classes often used by poultrymen, but not to anything like the extent those especially mentioned are used.

The egg farmers of the Pacific coast seem to prefer hens of the Mediterranean class, saying their climate is particularly well suited to such fowls.

The poultryman who wishes to build up a profitable trade must cater to the special demands of his market. If it were not for these demands there would be no business for the special egg and poultry farmer. As has been said, there is more than enough stock produced to fill the demand for inferior poultry of all sizes, as well as for stock of good quality, but not of the sizes and colors in demand. Popular preferences for certain colors of skin and shell are mere prejudices; but it is the poultryman's business to supply what the people want, not to try to persuade them to want something else. When selecting his stock he must take varieties that will enable him to supply the demands most satisfactorily, and with greatest profit.

102. Breeds for Profit, (Economic), on a Small Scale.—While the varieties recommended in the preceding section are the best suited to exclusive market poultrying, many, even in the localities mentioned, who keep small flocks of poultry for profit (as an adjunct to another business) find other varieties just as profitable. Then if their taste prefers another variety it is a satisfaction to be able to gratify it without sacrificing profits. In a "brown egg" locality a poultry keeper whose fowls produce white eggs can easily find customers to take white eggs of best quality at the same price as brown eggs—but this trade is limited. The same thing is true of Langshan, Houdan, and Minorca poultry, and of the extra large carcasses of Brahmas and Cochins. In every line of poultry production it is a frequent occurrence that a man handling a small quantity of a certain kind of goods finds the trade satisfactory, which on increasing his stock he finds that he has passed the limit of the demand for his produce, and the surplus moves slowly in the open market. This phase of the subject is of most importance to those who, having been successful on a small scale, are about to give their whole time to poultry. If the stock they have been using is not adapted to the market to which their increased output must go, the stock should be changed.

103. Breeds for a Breeder.— One whose object is to do, ultimately, a general poultry business, a principal feature of which shall be the sale of exhibition and breeding stock, wishes, of course, to acquire special knowledge of the breeds he is to handle, at the same time that he is gaining practical general knowledge of the care of fowls, the principles of breeding, and building up his stock. Where there is already an established trade in high class stock it is easy to learn which varieties are readily salable, and it is well for the beginner, especially if his means are small, to select some of the varieties most popular in his vicinity. Under such conditions a man with enough knowledge of fowls to be able to keep them in health would, probably, find it best in the long run to begin with first class stock, and each year secure expert advice in selecting and mating his breeding pens — until the time comes when he can rely on his own judgment of the stock. All popular varieties are well adapted to this kind of poultry keeping; though because of differences in local popularity all are not equally suited to all localities. A very correct idea of the relative popularity of the varieties in any section may be had from the advertisements of breeders in that section, from the classes in the poultry shows, and from the statements of those familiar with the business.

Another point to consider in this connection is the basis of the popularity of a variety. *Permanent popularity is always based on economic merit.* If a popular variety fails there, avoid it. Its popularity is sure to be transient. In localities where thoroughbred fowls are not common, buyers are more eager to have stock of a kind different from that of their neighbors than to have better stock of the same kind. The spirit of rivalry and competition, which is the basis of high prices for thoroughbred stock, is not developed until people begin to be able to compare Standard merits. Under such circumstances the wisest plan is to begin with fairly good birds,—a good assortment of the varieties most universally popular,—and to sell this class of stock until it begins to appear what varieties are destined to attain local popularity; then the breeder should make a special study of those varieties, secure some first class stock, and prepare to meet the demand.

104. Non-Popular Fowls to be Avoided.— Beginners generally should avoid the non-popular varieties. For nearly all these fowls there is a limited demand, filled for the most part by a few breeders of long established reputation. A profitable trade in such varieties is very hard to build up. New breeders also need to guard against being influenced by *occasional* demands for varieties they do not keep. It has happened that two or three inquiries coming at about the same time have led new breeders to put in stocks of birds for which there was no sale. Most of the (apparent) demand for non-popular varieties is what may be called a “fictitious demand,” coming principally from persons who have no intention of buying.

105. What Most Breeders Can Do.— Extra fine exhibition stock always brings “big” prices, especially in the popular varieties difficult to breed to

Standard requirements. These prices have no relation to, are not at all dependent upon, the practical qualities of the fowls. To build up a large and permanent trade in stock of lower Standard merit, it is necessary that the stock should be useful as well as beautiful. There is a large class of buyers who select for superficial excellence, *first*, but are not long satisfied with such lack of useful qualities as is sometimes found in high class stock. This class of buyers is smaller than the next to be mentioned, but its members are willing to pay much better prices for what they buy, and their patronage is, volume for volume, more profitable. The largest demand is for fowls bred especially for practical purposes, yet not noticeably deficient in Standard shape and color requirements. Most of the buyers of such fowls cannot and will not pay "fancy" prices. It is this last demand that most poultrymen are capable of filling. The production of the finest Standard fowls requires a combination of artistic perception and knowledge of the laws of breeding comparatively rare. The production of fowls whose chief merits are measured by the dozen and the pound, does not require extraordinary artistic faculty. The mediocre talent which most of those who find fowls interesting possess, fits them to supply first the demand for good practical stock, afterwards the demand for fair exhibition stock of good practical worth,—and this last demand will bring them the cream of their profit.

106. Selecting a Breed for the Farm.—A farmer—or farmeress—keeping fowls under the conditions found on the ordinary farm, wants fowls that will *rustle*, will go out into the fields and meadows and pick a part of their living. He wants a breed that is not in any way an oddity. To him large crests, and heavily feathered legs, and monstrous combs are objectionable, because he does not see that they serve any useful purpose. He feels that such superfluities are out of place on the farm. As on most farms chickens are hatched and reared in the natural way, the farmer's hens must, usually, be sitters. It is generally of some importance, too, that the surplus poultry be of good market quality. So that of pure bred fowls, the varieties of Plymouth Rocks, and Wyandottes, and after them, White Wonders, and Rhode Island Reds, are the most suitable for general farm flocks.

On farms where poultry, without being a leading feature, is still a specialty, the nature of that specialty may lead to the selection of a variety not in the general purpose class. Asiatics are prime favorites on farms which make something of a specialty of large roasters. Many farmers whose poultry furnishes the greater part of their fresh meat in summer, prefer Asiatics, because no other fowl is large enough to "make a meal." On some farms Leghorns are preferred, because eggs are secured from them with less trouble than from any other breed, they continuing to lay well for three or four years, while heavier fowls, kept under the same conditions, would become overfat and unproductive after their first annual moult. Just because the Leghorns lay well for several years, it may be possible to keep a stock of several hundred layers on a farm, where if nearly the whole stock had to be renewed yearly,

not half that number could be kept. To many farmers the kind of poultry their stock makes is of little consequence, *provided the hens lay plenty of eggs*. For in many places where eggs are as good as cash at the grocery, marketing poultry profitably is, for a farmer who comes to town but once a week, and then has only a few hours in which to do a score of errands, a mighty troublesome problem.

107. Fowls for the Village.—When fowls are kept on large village lots, farm conditions are reproduced on a small scale, and the considerations affecting the choice of a breed are nearly the same. Fowls that roam widely are more objectionable in these relatively narrow quarters than on a large farm, for here they are continually trespassing. A right minded poultryman will not permit his fowls to annoy his neighbors. When it is desired to give the fowls liberty as long as they remain “at home,” the Asiatic and American varieties are preferable; an ordinary fence will keep them within bounds. If the fowls while confined can be given ample yard room, the additional cost of higher fences for the high flyers is not so great as to overbalance a possible preference of the poultryman for one of the smaller breeds.

108. Breeds for Close Quarters.—For a City Lot.—Nearly all varieties do well in confinement if well cared for. Because of their contented dispositions Asiatic are best adapted to close confinement. Nervous, restless fowls are more apt to acquire such vices as feather pulling and egg eating, and to cause trouble by frequently breaking bounds. Minorcas and Houdans will generally take more kindly to narrow yards than will Leghorns. Though contentment in confinement is to some degree a matter of training and habit, chicks that are reared in confinement are not fretted by it as are those which have had free range.

Black and dark fowls are best suited to city lots, where there is much smoke and soot.

109. Breeds for Fanciers.—The choice of a breed, or breeds, for a fancier must depend much on the nature of the pleasure sought. If it is the pleasure of possession of a uniform flock of handsome fowls, the novice-fancier should choose a well established variety easy to breed. He does not want to be obliged to rear a large flock in order to get a few that he will not be ashamed to show. The difficulties in breeding which made a variety objectionable to that one would make it suitable for another, who sought pleasure in the development of skill in producing rare specimens. A fancier who wants oddities can make choice of a variety much more easily than he can learn where to buy stock—so rarely are the oddities met in poultry yards. One who wishes a collection of a small number of each variety of a breed finds the breeds most numerous sub-divided just what he wants. Many find pleasure, and some profit, in the production and development of new breeds and varieties, or the development of new types of old varieties. This pleasure

of the fancier is only completely rounded out when he sees his creations becoming popular. For this it is necessary that he should not work at random, but with definite ends in view, and a full realization of the style and quality of fowl likely to please and gain favor. The maker of new breeds needs to be very familiar with the old ones, and also to have a comprehensive view of the conditions and tendencies of the poultry world.

110. Buying Stock.—Some General Observations.—It is presumed that one who has studied the subject thus far knows what kind of stock he *needs*. That is the kind of stock he should buy. If he wants to produce first rate stock of any kind he cannot do it from second rate (or worse) stock. It is folly in most cases to *grade up* inferior stock. It is to refuse to accept *in full* the results of the work of the best breeders. Most of those who do this make the plea that they cannot afford to buy better stock. *Whatever the object a poultryman has in view, he cannot afford to buy stock other than the best suited to that object.**

The trouble with most new breeders is, they are too eager to begin selling stock before they have produced it. They are not satisfied to begin with just enough breeding birds of best quality to hatch their own chicks. They must sell eggs for hatching from the start.

Suppose a man has ten passably good pullets of a popular variety—worth one dollar each. He wants to grade up his stock with the ultimate object of producing first class breeding and exhibition birds. He pays ten dollars for a male to mate with these ten females, expecting to get a number of chickens worth five to ten dollars each, few worth less than two dollars. He may raise three to four hundred chicks in a single season from that pen, and the probability is that after a season of hard work he will have not a single chick worth five dollars, very few worth as much as two dollars, and the most no better than the parent hens. If he has sold eggs from such a mating, he has done his prospective business more harm than good.

Now if, instead, he had sold the ten pullets for ten dollars, and invested that amount in two hens of good quality, and bred on the right lines to mate with the male, he could, with “good luck,” raise sixty to eighty chicks, more than half of which would be better than the best from the other mating. Just so in breeding for eggs, or meat, or any other feature. The beginner should always start with stock *best for his purpose*,—whatever that may be.

Except for those who wish to breed exhibition stock of finest quality, it is not necessary to pay long prices. Nor are the prices asked for the stock of fair to medium quality usually purchased by amateurs, market poultrymen, and farmers, as exorbitant as a novice is inclined to think them. The usual prices for such stock are *low*, rather than high, as one finds when he begins to sell stock. †

* NOTE.—This does not except the case of one beginning as described in ¶ 103. He buys mediocre stock to supply the first demand, and, later, higher class stock to prepare for the future demand.

† NOTE.—A novice is misled as to the profits on good breeding stock, because he does

Where competition is as active as among poultry breeders, the inexperienced buyer need not fear lest he pay too much for good stock; though it must be said that he sometimes pays a good price for poor stuff.—(Another condition not peculiar to the poultry business). One soon learns where to buy the stock he wants. Taken all in all, beginners lose more through their own blunders, many of them inexcusable, in selecting and ordering stock, than through the deceit and cupidity of dishonest breeders. All reputable breeders ship stock on approval. If not found as represented, it may be returned, and the money refunded, less express charges. Sometimes a breeder sending stock a short distance agrees to pay the return express in case the stock is not as represented. In general, the buyer pays express both ways: an arrangement not unfair to the buyer who risks only the amount of transportation, while the seller risks the full value of the fowls. The safest course for a beginner is to buy of well known breeders. He may pay a little more for the stock, but the reputation of the breeder affords a measure of protection to the buyer not versed in the points and qualities of different stocks. A breeder who has made a reputation does not knowingly risk it by misrepresenting his stock, or in any way defrauding his customers. It often happens that amateurs offer equally good stock at lower prices than the established breeder. One who is himself a judge of the stock may well take advantage of such opportunities. A novice runs more risk. Often when the amateur sells good stock cheap it is because he does not know its value, in which case it becomes simply a matter of chance whether the buyer gets what he pays for, or something better, or worse. In buying from a breeder of good repute, a beginner will be safer to take the breeder's word for the quality and value of the stock, than his own judgment or the expression of opinion of those no better informed than himself. (Especially is this true in buying breeds in which special matings are required to bring out the colors in perfection). A novice often gets the mistaken idea that a certain feature is a sort of breed birth mark, or trade mark,—none genuine without it. The experienced breeder's judgment of a fowl strikes the proper balance of defects and excellencies. He knows what is back of the birds he sells, and what kind of progeny they are likely to produce.

A common error of beginners is to buy males and females of different breeders, in order to be sure of unrelated stock; this almost uniformly gives poor results. (The reasons for this will be presented in the chapter on not know how large a portion of the stock is worth only market prices, and has no idea what it costs the breeder to advertise and sell stock. When one comes to sell his own stock he finds that prices are adjusted by the inexorable laws of supply and demand, and that a breeder must be able to raise a good percentage of stock of fair quality, and sell it seasonably at prices well up to the average, if his year's account is to show a balance on the right side of the ledger. It is worth noting here that the customary method of figuring profits on poultry includes in the cost only labor which has been paid for in cash. In most instances the statement of profit really includes the poultryman's time, and is not all *clear profit*.

breeding, therefore need not be introduced here). The best way is to buy both sexes of the same breeder, he mating the stock for the results desired by his customer.*

Another thing the inexperienced buyer needs to consider is, that if the produce of the stock does not come up to expectations; this may be due to the effect of a change of climate and treatment on the parent stock, or due to lack of skill in caring for young stock; that it is more likely to be due to the latter cause than to the other, and ten times more likely to be the fault of the buyer than due to any cause chargeable to the seller. Such statements are neither soothing nor flattering to those who, having failed to realize expectations in their first attempts to rear good stock, are disposed to blame everything but their own incapacity. They are true, none the less, as many will find if they will give the same stock another trial—more favorable because of their increasing experience. A good workman can do creditable work with poor tools and poor material; a poor workman bungles with good tools, and botches a job, no matter how good the material,—generally the better the material the worse it is botched. When it is clear that the fault is in the stock or in the mating, it is surely no more than fair to the seller of the stock to inform him of results, asking his advice and assistance in remedying matters. He will, doubtless, be found willing to do all that could reasonably be expected of any business man in a similar case, *if the matter is stated fairly and courteously*. A breeder is concerned for his customers' success. He will do everything in reason to assure it. It is his reputation—his bread and butter.

There are rare cases where buyers are deliberately swindled. To seek redress at law, is generally to throw good money after bad. The best thing to do is to file a complaint, stating the facts in the case, with the paper or papers in which the party advertised. Such complaints are carefully investigated, and though it is hard to obtain conclusive proof of fraud, no reputable paper will carry the advertisement of one against whom complaints are numerous and apparently well grounded.

111. When to Buy.—In the fall is the best time to buy stock. Good stock can be bought for less money then than at any other season. The early buyer gets the best selection. It is better too, for the fowls to be moved to their new quarters before the hens begin laying. It is a mistake to put off the purchase of breeding stock until just prior to the breeding season. One

* NOTE.—When an amateur, or even one who thinks he has passed that stage, buys stock of a better breeder than himself, who, knowing all about the stock, has mated it *for best results*, the buyer consults his own best interests by breeding the stock just as mated for him. Persons who have spoiled enough good stock to know better, will buy a pair, a trio, or a pen of fowls, which are sent them properly mated. A foolish prejudice—(it is mere prejudice)—against inbreeding leads them to mismate the birds, and virtually throw away what they paid for when buying them.

who does this pays more for his stock, and, in addition, runs the risk of losing the earlier and better part of the season — laying and hatching results alike being likely to be poor while the fowls are becoming accustomed to new conditions. After the first of June, each year, there are numerous opportunities to buy at very low prices some of the stock breeders have used in their breeding pens. These are bargains for those prepared to give the stock proper care — not for others.

112. Buying Old Stock.—There is very little difference in point of profitableness in buying young (breeding) stock, and buying stock in the second year. The older stock costs a little less, can be used, generally, only one season, but, is likely to throw better stock than younger fowls of the same quality. Fowls past two years old may be worth something as breeders to one to whom they no longer owe anything. For others they are risky investments. It is only in exceptional cases that a fowl past two years old is worth buying for breeding *at any price*. For laying stock, young hens ought always to be preferred, because of their longer period of usefulness.

113. Prices of Stock.—Prices of exhibition stock are always a matter of special correspondence between breeders and buyers. Fowls fit to win in the average show cost from \$10 or \$15 apiece, to double and treble those figures. What is called “number one breeding stock,” a grade of stock fit to produce fair Standard fowls, itself of a quality to rank well in the minor shows, can be bought at \$5 to \$15 each for males; \$3 to \$10 each for females. Fairly good breeding stock, satisfactory to all who do not value or cannot appreciate the fine points of a breed, can be had for \$2 to \$5 for males, and \$1 to \$3 for females. The prices of good thoroughbred stock bred for utility, run about the same, though extra good birds sometimes bring more. Those who cannot give fowls the care necessary to keep them up to the standard to which they have been bred, will find it better to buy such fowls as can be had at \$10 to \$15 a dozen, and to frequently renew their whole stock.*

114. Buying Eggs.—“Is it better to begin with eggs, or with stock?” is the query of every beginner. People have all sorts of results,—good, bad, and indifferent—from purchases both of eggs and stock. It may be said, however, that in buying stock both the risks of total loss and the chances of

* NOTE.—This does not mean that a farmer who wants to keep two hundred hens should buy them at those prices; but that he might find it on the whole more profitable to buy a breeding yard of good culls every other year from which to produce his laying and market stock, than to introduce new males to the old stock each year. People who keep a few hens, only for the eggs, would find the cheap grade of stock as good as any other; provided, always, it has been bred for eggs—cheaper at those prices than they could produce it for themselves, and cheaper, in the end, than the most of the stock offered at one-half to one-third the price.

getting fine stock very cheap, are less than in buying eggs. Buying matured stock is buying something tangible and real; buying eggs is buying chicks before they are hatched,—the eggs contain possibilities; the stock is a reality. Prices of eggs run from \$1 to \$5 — rarely higher, though \$10 or \$15 per sitting is sometimes charged. The common prices are \$3 to \$5 for eggs from high class exhibition stock; \$1.50 to \$3 for medium exhibition and good practical stock. Incubator eggs are sold by the hundred, at from \$4 to \$10, or \$12. At the former price they are generally from culls, and used mostly for hatching broilers. At the higher prices, eggs can be had from fairly good breeding stock. Packed in baskets or crates, eggs go everywhere by express. Long distance shipments seem to give good results quite as often as short ones.



CHAPTER VII.

Foods and Feeding.

115. Corn — is, of all grains used as poultry food, the cheapest and most generally available. It is probable that American fowls are fed more corn and corn products than of all other grain products combined. This is certainly true of the farm flocks and small flocks. In the area which produces a large surplus of poultry, corn is the almost exclusive grain food. In the practice of the best special poultry farmers it is not so much used, but still is fed more generously than the balance of published opinion against its use would indicate. It contains carbonaceous matter in excess of the requirements of all fowls in warm weather, of fowls in confinement with moderate exercise, and of fowls warmly housed in winter. Under the opposites of these conditions corn and corn products may be the principal part of the grain diet: *provided*, always, that the fowls have all the vegetable and animal food they need, and care is taken to prevent the over-eating of corn in warm weather. There is danger in feeding corn heavily. There is danger in heavy feeding of any grain palatable to fowls. With whole corn the danger is greatest, because the fowls get, with so little exercise, so much food of a kind which gives under ordinary conditions some surplus of heat — energy which, if not used in searching for more food, is stored up as fat: finally to the detriment of the fowl.

The greatest abuse of corn is in the failure of those who use it freely with good results in cold weather to reduce a *little* the amount of corn in the ration for hot weather. Knowledge of the widespread disorders growing out of this neglect, has led some authorities on feeding to place so much stress on the risks of feeding corn that many are afraid of it, and use so sparingly that they reduce their profits as much by over-caution as the others do by carelessness. From one extreme to the other is a “far cry.” It is as easy to learn to feed corn right as to learn to feed right. Considering that corn always must be a staple article of poultry food, it is as necessary for nine out of ten American poultry keepers to learn to feed corn right as it is that they should make poultry profitable.

The forms in which corn foods are on sale are :

WHOLE CORN — (generally shelled, but in some places also on the cob). May be fed freely as an evening meal to growing stock large enough to eat it; to fowls in cold quarters or on range; may be a part of the evening food

of fowls in confinement (comfortable quarters, with exercise); may be given as a light morning feed to fowls on a good range. For sitting hens and for ordinary fattening, it may be an exclusive food.

CRACKED CORN—if fed in litter, can be used much more freely and generally than whole corn, though corn that has been long cracked contains proportionately more carbon than whole corn.* Unless it is sifted before using there is some waste of the finer particles, which should be sifted out and thrown in with the meal. Fed with moderate exercise compulsory, cracked corn is under some conditions as good an egg producer as wheat—and much cheaper. When an abundance of carbon is needed, it is a better food than either wheat or barley. It may be the only food *fed* to growing chicks on a range where insects and green food are abundant. Such a diet is not the best, but will *do* when more varied diet cannot be obtained, or would be unprofitable.

CORN MEAL—(coarse, unbolted), forms generally one-fourth to one-half of the millstuffs used in a mash. For young chicks it is often used in much more generous proportion. Under similar circumstances it may be given moistened, uncooked, or scalded, half-cooked, as freely as cracked corn. As well baked johnnycake, it is often made the principal part of a ration for chicks however situated.

CORN CHOP—is finer than cracked corn, coarser than corn meal, and may be used in place of either.

CORN and COB MEAL—contains more indigestible matter than the other straight corn products, but still has digestible elements in nearly the same proportions. Cooked with clover or alfalfa, it makes an excellent mash for cold weather.

MIXTURES.—The most common commercial mixtures, composed largely of corn, are *Mixed Chop*, corn and oats equal parts, ground; and “*Pro-ender*,” a mixture of corn, oats and bran.

116. Wheat.—**WHEAT SCREENINGS, DAMAGED WHEAT.** Wheat is rated the best single grain for poultry. Principally in connection with the use of wheat has arisen a question of the relative values of sound and damaged grains as poultry food. Wheat being a staple of human food, the price of good wheat usually rules high as compared with other grains—especially corn, the only other grain of which fowls are fond as of wheat. Wheat of fair quality, broken (good) wheat, and good wheat screenings, are as good poultry food as the very finest milling wheats. No ordinary test will find them inferior. Poor wheat and dirty screenings can be fed to advantage only when bought very cheap. Wheat damaged by fire or water can also be fed to advantage, if not so much damaged that well conditioned fowls refuse it, and if the price is right. In buying such goods, it is a safe rule to buy

* **NOTE.**—Many poultrymen crack corn as needed, thus getting its full food value.

only when there can be no doubt of the advantage of using the lot in question. In wheat the food elements are combined in very nearly the proportions required by the system of the fowl. Under conditions of moderate temperature and exercise, it may be made almost an exclusive diet for a long time without perceptible harm to the fowls.*

In cold weather and cold quarters wheat alone fails to keep up the heat of the body. Fed freely without exercise, in warm and moderate weather, it fattens quite rapidly. It is good food for chicks at any age, and should form one-fifth to one-third of their diet whenever purchasable at a price that allows of feeding it with profit.†

WHEAT BRAN—is used in nearly all mashes, the proportion of bran to other ingredients varying with the composition of the bran. Weight is a fairly reliable index of quality. Light bran is *bran*—nothing else. Heavy bran contains more or less middlings. Bran alone is rarely fed to fowls, though some poultry keepers give their fowls free access to a dish of bran, wet or dry, and think it an advantage to supplement the regular meals of heavy laying hens in this way. The price of wheat bran seldom goes so high that there is anything to gain by using substitutes.

MIDLINGS and SHORTS are names for practically the same substance, the mill product between flour and bran. Quality varies as in bran. Both these by-products depend for quality on the processes used in the mills from which they come. Being rich in glutinous matter, middlings are most valuable to use with corn meal, and in the mashes of all rations containing much corn. A mash made largely of middlings is doughy, sticky, and not relished by fowls. One-fourth to one-third is the proportion of middlings commonly used.

117. Oats.—WHOLE OATS—contain nutritious matter in nearly the same proportions as wheat, but because of their coarse indigestible husk are not as well liked by fowls. The husk constitutes about one-tenth of the bulk in good oats, and in poor oats much more. It is commonly thought that heavy weight oats are the best. Analyses have shown that the contrary is true.‡

When buying oats the quality may be tested accurately enough by hulling a few sample grains. An ordinary inspection does not detect poor quality in

* NOTE.—The experiment was made with laying hens, (Brown Leghorns), and a sixty per cent egg yield secured in a month from hens fed whole wheat three times daily in close confinement, with very little exercise.

† NOTE.—Just how much more a poultryman can afford to pay for wheat than for corn, is an open question. Experiments with cattle indicate that the feeding value of wheat is not enough greater to justify the usual difference in prices of corn and the various grades of wheat on sale for poultry food. The results of these experiments give wheat a cash feeding value one-tenth to one-fourth above that of corn.

‡ U. S. Government Bulletin.

oats as readily as in wheat. It is important for the feeder to know the quality of the oats he is using. It is not an unusual thing for those who are careless about this to feed bushel after bushel of worthless oats—nothing but husks—and seeing them left by the fowls, conclude that the fowls are over-fed; then other feeds are reduced, and the fowls, possibly, half-starved before the error is detected. A very few poultry keepers have reported good results from a diet mainly of whole oats. By most they are fed as a light (noon) feed, or in a mixture of grains. Good oats are perhaps the best whole grain to balance a heavy corn ration. If steamed occasionally they can be fed oftener, for fowls eat them more readily; but when a mash is fed regularly, cooked grains should not often be given in addition. The feeder can save work and add variety by occasionally substituting steamed oats for the regular mash.

HULLED OATS—make a very good cheaper substitute for oat meal for those who like a good proportion of oat meal in a ration for chicks. They may also be used in mixtures of grain for old fowls.

GROUND OATS—(coarse, unsifted), are used in mashes and in cakes for chicks. When fed to very young chicks it is better to sift out the hulls.

OAT MEAL and ROLLED OATS—though sometimes highly recommended for young chicks, are little used by poultrymen. A few use one or other of them freely for the first week or ten days; and a very few continue their use occasionally after that period. They are costly foods. When fed freely oat meal often causes bowel disorders. The feeder who is after the most profit will hardly think of paying high prices for articles specially prepared for human food, when as good results can be (and are) obtained by the use of cheaper articles, and of oats in cheaper forms.

118. Barley—is not as generally kept in stock for poultry food as the grains previously mentioned, and is sometimes hard to get where the demand for “chicken feed” is light. Fowls do not like it as well as wheat. Its feeding value, as determined in practical use, and also by analysis, is nearly equal to that of wheat. It contains a little more fiber, and is therefore less palatable. The hull seems to be the objectionable feature—to the fowls—for hulled barley they eat freely. Barley contains a little more bone and muscle forming food than wheat, and is usually enough lower in price to be a much cheaper food.

BARLEY SCREENINGS—have a larger proportion of nutriment than well developed grains have.

BARLEY MEAL—has about the same properties as wheat middlings.

119. Rye.—The general condemnation of rye as a poultry food seems to be based on very limited experiences in feeding it. In some parts of Europe it is the “staff of life,” just as wheat is here and in England, and is used much

for domestic animals as well as for men. Here and there in this country is found a feeder who uses rye with good results. Its rank, as determined by chemical analysis, is between barley and corn. It is less fibrous than barley—a little more fattening. Rye is so cheap when obtainable that it is surely worth while for those who could use it if satisfactory to give it a thorough test.

RYE BRAN—is nearly identical in composition with wheat bran. A mixture of equal parts of rye, corn and oats, has the same feeding value as buckwheat.

120. Buckwheat—is very generally fed as a part of the whole grain ration, wherever it can be bought at a price that admits of its use as poultry food. In sections where little of it is grown it is rarely on sale except at seed stores, and at a rather high price. It is more fattening than wheat or barley, nearly as fibrous as oats; not a good grain to feed heavily.

BUCKWHEAT MIDDINGS are, of all mill stuffs from grains,* the richest in albuminous matter, therefore most valuable for balancing rations deficient in protein.

121. Sorghum Seed—available in sorghum growing districts, contains a little more heating, fattening matter than corn. Those who have used it say it is a good poultry food—good for egg production for hens on the farm.

122. Chicken Corn—(*sorghum vulgare*)—has about the same nutritive value as wheat, as much husk and fiber as whole oats.

KAFFIR CORN, MILLO MAIZE, DURRA, EGYPTIAN CORN—resemble chicken corn in food properties. The names of these grains are, in popular usage, rather indiscriminately applied. All make good poultry foods. They are particularly valuable for poultry keepers in dry regions who grow their own grains.

123. Broom Corn Seed,—hulled, makes a good food. (Tested in comparison with wheat, it gave equally good results). When not hulled fowls do not eat it freely enough to make it useful as a staple of diet.

124. Millet Seed—has relatively more flesh forming substance than any of the larger grains—more, even, than oat meal. It is often recommended for young chicks, but has too much fiber, and is too apt to cause bowel troubles, to be used as freely as is generally suggested. The best way to feed it to chicks is to scatter it where well fed chicks can get it, if they hunt or scratch for it, in addition to their regular meals. To old fowls it is generally given as a light meal, in litter, to compel exercise. The grains are so small that fowls cannot eat dry millet fast enough to make a good meal of it. When it is

* NOTE.—*Buckwheat is not a grain*, though always classed among grain foods.

cheap — (as it is in some places), — a good way to feed is to cook it and feed in troughs instead of mash. It should not be fed regularly in this way. There are numerous varieties. Those having the largest grains give best satisfaction as chicken feed.

125. Linseed Meal and Cotton Seed Meal — are very rich in albumen, and may be fed in small proportions in mash, though those who can get corn, wheat, and oat products in abundance have little need of either of these.

126. Other By-Products and Waste Products from Grain. — There are many of these — most of them available only in the vicinities of the factories from which they come, though some, extensively used in cattle feeding, are kept in stock by large feed dealers generally. Few have been practically tested as poultry foods. Trials of such food stuffs ought to be based on knowledge of their composition, and of the general laws of feeding, as given in the next chapter. Haphazard tests of food accomplish little.

127. Waste Bread. — Near large cities waste bread is an important item in the poultry food supply. Much of it is not broken at all — simply stale bread. A mixed lot of broken bread gives a very complete ration, for it contains a great variety, white, brown, graham, and corn breads, broken cakes, muffins, etc. It is fed in various ways: dry, crumbled; moist, crumbled; simply moistened with milk or water: soaked to a pulp in warm water, then thickened with meal and bran, or middlings. Some poultrymen use no other soft food. It is very cheap. Fed with whole corn to fowls on good range, it makes a most economical and satisfactory ration.

CRACKER CRUMBS, — stale and broken crackers, are also used as food for chicks.

128. Meat Foods. — **BEEF SCRAPS, DRIED BLOOD, ANIMAL MEAL, PORK SCRAPS, LARD CRACKLINGS** — are all used as poultry foods. An excess of animal food in a ration causes digestive troubles: it is not, therefore, advisable to feed the whole meat ration in the mash. If a part of it is fed separately, fowls are not likely to over-eat of it. Fowls over-fed with meat will at last refuse a mash containing it; but the mischief is done before the fowls are forced to refuse the food.

GREEN BONE — and many of the prepared meat foods contain much mineral matter — needed for bone and for shells.

RAW LEAN BEEF — is a good animal food when it can be had for little or nothing. As by far the greater part of its bulk is water, the feeder cannot afford to pay much for it, with prepared foods as cheap as they are.

HORSE MEAT. — The meat of a healthy horse killed for cause, can be used as poultry food; but ordinary "horse meat" is unfit for fowls.

FISH SCRAPS and DESICCATED FISH— are, near the sea coast, staple articles of animal food for poultry. Fish products impart a rather strong odor to eggs and flesh, and are often on that account objectionable.

CLAMS— are frequently fed to fowls; either raw, pounded up— shell and all— or cooked in the mash.

129. Eggs.— Infertile and very stale eggs are commonly used as poultry food (and are sometimes too abundant either for the credit of the poultry keeper or the good of the chicks, to which they are oftenest fed). The usual method is to hard boil them, chop fine and feed, either alone or with bread or cracker crumbs, to little chicks. A better way is to break them— shell and all, into the mash or the batter for the johnnycake; or soft boil, break and thicken with meal.

130. Vegetable Foods.— Nearly all common vegetables are eagerly eaten by fowls. Green vegetables and roots contain little nutriment as compared with grain— from 78 to 96 per cent of their bulk being water. With the exception of potatoes, they are hardly more than relishes in winter, but in summer are an important part of the ration.

POTATOES (WHITE) and SWEET POTATOES— which contain the most dry matter, are very carbonaceous, hence should be fed sparingly— better not at all to fowls which get much corn.

ONIONS— have a tonic and medicinal value. Fed raw, they impart their taste to the flesh and eggs of fowls. When cooked they can be fed more freely* without affecting the flavor of eggs or meat. The best way to feed onions is to slice them in a slaw cutter, and boil with the hay or vegetables for the mash; cut up fine in this way they are quickly and thoroughly cooked.

The profitableness of feeding vegetables depends much on their cost. To buy them at the prices they usually bring for human food, does not pay, for as good results can be had by using green grass in summer, and clover or alfalfa hay in winter. Vegetables that can be grown cheaply, as cabbages, mangels, etc., and waste vegetables of all kinds, can generally be bought at prices so low as to admit of feeding enough of them to give the ration variety; but, if they cannot, fowls which have plenty of good hay will not suffer for lack of them.

131. Hay.— The RED and WHITE CLOWERS, and ALFALFA,— not over-ripe, well cured, make the cheapest green foods for winter feeding. Finely cut hay can be fed as a separate feed, either dry or steamed; but it is better to feed it cooked in a mash. Where alfalfa is sold, baled, a common practice of poultrymen is to put a bale under a shed or in the scratching floor, the wires

* NOTE.— Five pounds of onions daily to every one hundred hens is feeding onions *freely*,— gives them all the onions they care to eat— and this amount of cooked onions can be fed without affecting the flavor of the products.

remaining fast, and allow the hens to help themselves at will. Finely cut clover in sacks is now on sale by leading supply houses. It is of little use to feed fowls woody stalks of hay, and if fine hay cannot be had otherwise it is worth while for a breeder who could use a considerably quantity of it, to pay a farmer to cut and cure for him a ton, or as much as he could use in a year, of clover or alfalfa in the right stage to make good poultry food. One who needed but a small quantity can often arrange to get a few bushels at a time of fine leaves from a neighbor's haymow; or may cure lawn clippings for himself, though that is for most people rather unsatisfactory, and if his time is worth anything, costs more than to buy vegetables. Hay is too bulky — contains too much fiber — to be used as a principal poultry food. In everyday use no difference is noted in feeding properties of the kinds named. Their rank as determined by analyses is: (1) white clover; (2) alfalfa; (3) red clover. Prepared clover finely cut for poultry food is kept in stock by large dealers in poultry supplies.

132. Milk. — SWEET SKIM MILK — is invaluable in poultry feeding. It can be given as a drink, or the mash can be wet with or cooked in milk. At the low price for which it can be bought at creameries, it is one of the most economical of foods.

SOUR MILK, CLABBER MILK, and BUTTER MILK — are all fed. For mixing mashes they are not as satisfactory as sweet milk, yet many use and like them. Cold clabber milk thickened with bran, middlings or corn meal, makes a side dish much relished by fowls in hot weather.

CURD — is a valuable food — more concentrated than milk; giving the fowls the solids of the milk without the water.

CHEESE — that has passed the last stage of fitness for human food, is often given to fowls, and is highly recommended as an egg producer.

WHEY — is used by many feeders to wet the mash. It contains so little solid matter that the advantage of using it, rather than water, to wet the mash, must be more fancied than real — especially as its solids are principally carbonaceous. If one has it, it will pay to use it — nothing should be wasted. It has not food value enough, however, to make it worth one's while to go to any trouble or expense to get it.

133. Egg Foods. — Condition Powders. — Tonics and Stimulants — of various kinds are in the debatable list between foods and medicines. Some use them for one, some for the other. The wisdom of using them depends on circumstances. It is certainly unwise for one whose fowls plainly need a tonic to neglect — *on principle* — to use one; and it is as certainly unwise to feed stimulants to fowls in the best of condition, and at the height of profitable productiveness without them. Nearly all fowls are better for the regular addition of a condition powder to their mash during the moulting period, and at times when colds are epidemic; as they often are at the same time among men and domestic animals.

134. Grit, Shell, Dry Bone, Charcoal—while, perhaps, not properly foods, are important accessories.

GRIT—is “hens’ teeth,” and is indispensable. A supply of grit of suitable size should be accessible to a fowl from the time it, a chick, leaves the nest or incubator.

CHARCOAL—aids digestion, and purifies the blood. It is fed either pulverized or finely cracked; sometimes in the mash, but often in a pan or box—as grit and shell are given. Fowls should have frequent opportunities to use it.

DRY BONE—is not so much used since bone cutters and the prepared animal foods containing bone have come into more general use.

OYSTER SHELLS—need not be furnished to chicks, but should be given to pullets as they show signs of laying, and should be always accessible to laying hens.

135. Buying Supplies in Quantity.—Few poultrymen have enough working capital to buy and store supplies for long periods. Those who indulge regrets because they have not, spend grief unnecessarily. Buying stocks of perishable goods subject to wide fluctuations in price is very much of a speculation. One may buy grain enough to last him six months, only to see the price go down within a week, and stay down. Besides, there is always some shrinkage and loss in storing food. The ordinary action of the air rapidly takes nitrogen from ground foods. Whole grains are more easily kept, but a few rats or mice, or a little dampness, may cause loss much greater than the original saving made by purchasing the larger quantity. Purchases of supplies should be according to size of the business. It will not often be an advantage to buy grain for more than two or three months at a time. In many cases not more than one month’s supplies can be managed with true economy. In buying imperishable goods, as grit, oyster shells, etc., the prices of which fluctuate hardly ever, the case is different. A small poultryman had best buy supplies of these to last a year or two. In buying damaged stuff, especially meats and vegetables, it is well to keep on the safe side, buying only as much as will be eaten while still fit for use.

136. Using Damaged Articles for Poultry Food.—Allusion has already been made to this matter, and also to the fact that fowls are gleaners and scavengers. The latter word may not sound nice—the fact is there, none the less. The treatment of this question,—the decision as to what to do and what not to do, requires, first of all, *common sense*. To go to the extreme limit of what fowls will endure in the way of decomposing and filthy food, is, from every point of view, a mistake. (Happily it is not a common one). To be over-nice, is to be altogether unreasonable. Food that has just passed the stage of fitness for human beings of somewhat refined tastes, is just as agreeable to fowls as if in perfect condition, and *just as good for them*. The

greatest danger in using such foods is that they are so cheap when they can be had in quantity that the feeder is tempted to use too large a proportion of them, — especially of meats and vegetables, — keeping the fowls short on grain to compel them to eat the other stuffs. As far as the effect of slightly damaged food on the health of fowls and the flavors of meat and eggs is concerned, if the food is such that a well fed fowl eats it well, no bad effects can be discerned. As a simple matter of fact, the most common unpleasant flavors of eggs and flesh are due to foods (as, say, onions), rightly considered particularly healthy; or (of eggs) to absorption of bad odors *after being laid*.

137. A Balanced Ration—is a complete ration, containing in proper proportion and in sufficient quantity all necessary food. The food eaten by a fowl goes:—to *growth*, including reproduction, egg production;—to *warmth*;—to *strength*. Nitrogenous elements are *built into* the body, replacing worn, and adding new, substance. Carbonaceous elements are *burned in* the body, giving warmth and energy—capacity for muscular action. The needs of the fowl's system are not always the same. It does not always use the different elements in the same proportions. It has in itself limited power to balance its ration, making a surplus of either class of food elements compensate for a deficit of the other. In the foods and combinations of foods used by expert feeders, the food elements are about right for average normal conditions. Observation and experience soon teach a feeder how to vary his ration to meet changes in the weather and apparent changes in the condition of the fowls. The commonest fault in the ration of well fed fowls is an excess of heat and fat producing matter. For this the feeder has an ever present remedy in the power of compelling the fowls to expend it in exercise.

138. The Need of a Variety of Foods.—A ration which is sufficient in quantity, and provides the variety of foods necessary to make it appetizing, will be on the whole a pretty well balanced ration. Such a ration for fowls in confinement would comprise two or more kinds of whole grain: a mash of vegetables— or hay— corn meal, wheat middlings, bran— or mill stuffs equivalent to these in feeding value— some kind of meat food, and a little green vegetables— a simple diet, yet varied enough to keep the digestive organs in good condition and the appetite normal. When fed grains of which they are fond, under conditions which invite gluttony, hens will over-eat, as they also will of a mash containing too much corn meal. If fed a little short on grain stuffs, fowls that get meat and vegetables regularly may be allowed to let their appetites regulate the quantities of them to be eaten.

Elaborate compounds of foods are not needed in mashes. In general a mash will be as well balanced— as complete— as a ration can be, with three or four ingredients. Good feeding is systematic. Large bills of fare make a system too cumbersome. That the fowls may be trained to eat what is **given**

them, the greatest possible variety should be introduced in feeding whole grain. (Not a great number of grains at the same time, but frequent changes made in the grains fed by way of variety). "Finickyness" in eating is a bad trait in a fowl. In different places the feeding problem deals with slightly different assortments of foods. Wherever located, one soon finds that the list of articles he can profitably use in large quantities is short.

139. Changing Rations. — Once found, the ration which gives satisfactory results should be used as long as prices allow. If a change must be made in a staple article of a ration, it should—when possible—be made gradually. Radical changes in diet always have some bad effects, and if fowls have not been taught to eat what is set before them, it may be some days before they eat a new food as freely as they should. In the meantime their light feeding will have played the mischief with the egg yield. Fowls accustomed to eat a variety of grains will, of course, have their preferences, but will rarely exercise them to the length of going hungry if a favorite food is not forthcoming. Neither the refusal, at first, of the fowls to eat, nor the slight bowel troubles incident to a change, should prevent the use of a food it is clearly to the advantage of the poultryman to use, and which he knows others are using with good results.

140. Feeding for Special Results. — Distinctions between "rations for eggs," "rations for growth," "maintenance rations," "fattening rations," are rather misleading. The differences are not so much in the proportions of the foods as in the methods of preparing them, the form in which the food is given, the number of daily feeds, the quantities fed, and—most important—*the conditions imposed on the fowls*. A ration which, fed five times a day gives good hardy growth to chicks at liberty, will force, or even fatten chicks in confinement, though for quick fattening it would be too narrow. The same (in composition) ration fed three times daily to hens with moderate exercise, would make a good laying ration; fed to the same hens without exercise, it would be a fattening ration. Some feeders do use a variety of rations, but, except for forcing, their extra work is labor lost.

141. Different Rations for Different Classes of Fowls.—Some experienced feeders can use the same ration for Leghorns, Plymouth Rocks, and Brahmas, and get uncommonly good results from all; some find it necessary to use quite different rations—more so than to make differences for the same breed for special purposes. Those mentioned first are more skillful feeders, have better judgment as to *how much* to feed. Beginners who keep several varieties will find it better, at least at first, to use a rather bulky, nitrogenous ration for fowls prone to lay on fat; a more carbonaceous ration for the active, energetic breeds. Many people—many good feeders—are a little too automatic in their work to handle several breeds, of different classes, at the same time with good results from all.

142. Methods of Feeding.—In feeding method and regularity are all important. There must be system. To the fowls it will make little difference which of the many good systems is used. To the feeder it may make much difference. One system will be *more convenient* for this man, another more convenient for that. The most common method—among those who have method—is to give a mash in the morning; vegetables, cut bone, or a light feed of grain at noon; a full feed of grain in the evening. It is a good system, though the fact that equally good results attend the use of other systems,—among them one just the reverse of this,—disproves the very plausible theory which persuaded so many to adopt it. The theory was that the fowls, after their night's fast, needed a meal that would be quickly assimilated, and that at night they needed a meal of hard grain slow of digestion. Grain in the morning and mash at night, give just as good results. Results as good as the best have also been obtained from grain mornings and evenings, and mash at noon. It is by no means certain that as good results cannot be obtained without a mash as with one; but general experience indicates that it is easier for most to get good results by using a mash feed *once* daily, than by omitting it. The great value of the mash lies in the opportunity it affords to more exactly regulate the ration. If the mash is not eaten eagerly, it is at once clear that the fowls are over-fed, or that the other food contains much too large a proportion of some substance prominent in the mash. To the trained feeder, the mash is a gauge of the condition of his flock. Whatever be the system adopted, it should be closely followed, and changed only for some very good reason. One of the common mistakes in amateur feeding is to make frequent radical changes of rations and of methods of feeding—a sure way to bring about digestive troubles, and ultimately destroy the usefulness of such fowls as are not killed outright.

143. Cooking Food.—Some feeders cook the mash, some scald (half-cook) it, some merely wet it. It is commonly supposed that cooked food is more digestible. As to that, there is no conclusive evidence. A significant pointer is that the leading duck raisers have changed from cooked to wet food for their ducklings. An objection to wet uncooked food is that it sours quickly. If given in the first stages of fermentation, it does no harm; but too often the feeder, unwilling to throw it out, takes long chances on very sour or mouldy food. Cooked food remains sweet much longer, and is therefore preferable when enough for several feeds is to be prepared at one time. While good results are undoubtedly obtained with raw and partly cooked foods, general opinion and practice favor the thorough cooking of mashes for both fowls and chicks, and of the baked cakes many use for chicks. Whole grains should be cooked only occasionally, by way of variety. For this a fibrous grain, as oats, not palatable in its natural state, should be selected. Cooked grain is, to all intents and purposes, a “soft” food. Too much soft food in a ration impairs, through partial disuse, the digestive organs, which

in the fowl are specially adapted to grinding *dry; whole* grain. When the digestion goes wrong everything begins to go wrong. Cooking is a part of the preparation of commercial meat foods. Fresh meat may be fed either cooked or raw; when cooked, the water in which it was cooked should be used in the mash. The notion that raw meat makes fowls vicious, is absurd.

144. How Often to Feed.— Unless the foraging ground is uncommonly good, fowls at liberty should be fed twice daily. Fowls in confinement should be fed two or three times, according to the manner of feeding the whole grain. When grain is fed on bare ground or scantily littered floors, it is better to give the grain for the day in two feeds. When floors are heavily littered, once feeding grain may be enough. Occasional light feeds between meals are good, but to regularly give four or five *meals* daily to adult fowls is poor method. Chicks should be fed from six to three times daily, according to age and circumstances. The length of interval between meals can be gauged by the appetites of the chicks.

145. How Much to Feed.— The common rule for a full feed of mash is: *All they will eat clean and quick.* If mash is left before fowls, they will after having satisfied their appetites once, go away, and a little later come back and eat more. It is better to give only what they will take at one "feed." Of a properly compounded mash as much as they will eat at one time can safely be given. When grain is fed in heavy litter, a quart gives a full feed to a dozen average fowls. A quart of grain fed thus in the evening is not all eaten that day. One-fifth to one-fourth of it will remain in the litter to be scratched out next morning, early — if the feeding of the mash is delayed; not till toward noon if a full feed of mash is given the first thing in the morning. Adult fowls, except when being fattened, should not be allowed to gorge themselves; growing chicks may safely be allowed to eat all they will of a fairly balanced ration, — and it will do no harm to encourage them to eat more.

146. Tested Rations.—REMARK.— Most of the rations described here have been many times in print, though not in the exact words here given. The arrangement, and to some extent the wording, is changed in the endeavor to make all conform to a common pattern. Comparison of some of the similar rations will show that some good feeders use unnecessary ingredients. The great variety of rations given here makes it very improbable that any inexperienced feeder will be unable to find at least one thoroughly tested ration suited to his circumstances.

(1). **Ration for Breeding Stock.**—(FELCH).—*Summer*—Morning,—mash of boiled vegetables, wheat bran and corn meal; meat in some form added three days in the week. **Mash** fed hot,—as much as will be eaten before 9 o'clock. **Afternoon**,—at 4 or 5 o'clock

a full feed of mixed small grains and a little corn. *Winter*—Wheat mash will be eaten up clean at the morning meal; at noon, small grains, sunflower seed, etc.; at night, all the corn they will eat.

(2). **Ration for Laying Hens.—Leghorns.**—(WYCKOFF).—Morning—Mash compounded as follows: 1 bu. corn, 2 bu. oats, ground fine; to each 200 lbs. of this mixture add 100 lbs. bran and 5 or 6 lbs. beef scraps; moisten with milk; feed in troughs, returning after ten or fifteen minutes to take up any feed that may be left, and give a second feeding where needed. At noon,—green food, mangels or cabbage in winter, clover or kale in summer; sometimes a light feed of mixed grain in litter. Night feed,—mixed grain, in winter 2 bu. each wheat, oats, buckwheat, and corn; in summer the corn in the mixture reduced one-half.

(3). **Ration for Twelve Fowls.**—(BOYER).—Dump all kitchen scraps into an old pot, and cook each evening; salt when cooking. In the morning heat up again. Scald 1 pint bran, 1 pint equal parts ground oats and corn meal; mix with the scraps. Twice a week add a little condition powder or charcoal and sulphur. Feed 2 qts., (less rather than more) to twelve hens. At noon feed 1 pt. of wheat or oats in litter; at night, 1 qt. of wheat, oats, or (in winter) cracked corn in litter, feeding the grains in regular rotation.

(4). **Ration for Fowls Kept on the Colony Plan.**—(WILBOUR).—Morning feed, —cooked vegetables and mixed meals; afternoon feed,—whole corn the year round.

(5). **Ration for Laying Hens.**—(DAWLEY).—Morning,—mash, clover hay or crimson clover steamed over night; in the morning stirred up with a mixed feed of 100 lbs. coarse wheat bran, 75 lbs. yellow corn meal, 100 lbs. ground oats, 50 to 75 lbs. linseed meal, a little charcoal, salt. Feed all they will eat clean. Noon,—green bone and vegetables. Night,—whole wheat and a little corn.

(6). **Ration for Fifty Laying Hens.**—(MRS. REED).—A little grain scattered over night for an early morning feed. Mash when the sun is about two hours high; take for fifty hens 8 qts. boiling water, 1 tablespoon fine salt, 1 teaspoon cayenne pepper, 1 teacup drippings or fat; into this stir corn meal 2 parts, wheat bran 1 part—to make a soft dough—not a batter. Feed very hot, in troughs, as much as they will eat up clean in one-half hour. Noon feed,—house scraps. Evening feed,—grain, principally corn on the cob; wheat, rye, oats, barley, and buckwheat used with corn in rotation.

(7). **Ration for Laying Breeding Stock.**—(NESMITH).—Morning,—a full feed of whole grain, principally wheat; but barley, oats, buckwheat used often. Noon,—a light feed of grain. Evening,—mash, of dried bread, cut clover, beef scraps and mixed meals, well cooked and fed warm—not hot—all they will eat.

(8). **Laying Ration for Twelve Wyandottes.**—(PATTON).—Morning, 1 qt. wheat in litter. Noon,—green food, clover, mangels or cabbage. Evening,—mash, 8 parts corn meal, 8 parts fine bran, 4 parts buckwheat middlings, 3 parts meat meal, 2 parts oil meal, a little salt; all mixed in warm water and fed crumbly, all they will eat clean.

(9). **Ration for Laying Hens.—Leghorns—in Cold House.**—(EWING & FOX).—Morning,—mash, 2 parts bran, 1 part corn meal, 1 qt. cut bone to 40 hens added every other day; condition powder once a week. Noon,—cabbage and a little grain, generally oats or barley. Night,—wheat and corn, alternating.

(10). **Ration for Adult Fowls.**—(CURTIS).—Morning,—mash one-half bran, the other half boiled potatoes, cracked corn, ground wheat, chopped oats, any special article at hand. Afternoon,—whole grain, in litter, corn and wheat, in summer equal parts; in winter two-thirds corn, one-third wheat.

(11). **Ration for Laying Breeding Stock.**—(BUFFINTON).—Morning,—mash, corn meal and middlings, equal parts, a little beef scrap and (in winter) boiled potatoes, a little salt, egg food; mixed with hot water and fed as soon as the fowls can see, except in the long summer days. Mash fed light, and a little dry grain, mixed, given after it. Afternoon feed,—dry grain, oats, corn and wheat, equal parts.

(12). **Ration for Thirteen Plymouth Rocks** (male and twelve females) **in Confinement.**—(LASH).—Morning and noon,—for pullets 1 pt. wheat, in litter; for hens three-quarters pt. Evening,—mash, 4 parts beans, 2 parts shorts, 3 parts ground oats, 1 part ground corn, one-third the whole cut clover; every third day one-quarter the whole green bone; 2 tablespoons pulverized charcoal to bucket of feed every third day; wet with hot water, and when cool feed until the crops are about two-thirds full.

(13). **Ration for Laying Stock.—A Three-Day Rotation.**—(HUNTER).—Morning,—mash, cooked vegetables mashed fine, or cut clover cooked by being brought to a boiling heat in water; to this add an equal amount of boiling water; to each bucket of feed use a tablespoon salt, and two days a heaping teaspoon condition powder, the third day of powdered charcoal. Make mash very stiff with mixed meal,—by measure, 1 part each corn meal, fine middlings, bran, ground oats, and animal meal,—the meal omitted or reduced in quantity when cut bone is fed. Mash omitted two days in each week. Noon,—light feed of grain. Evening,—full feed of grain. Grain fed in variety in rotation, thus:—

Monday — oats (or barley), wheat, whole corn.

Tuesday — mash, barley (or buckwheat), wheat.

Wednesday — mash, cut bone, wheat.

Cabbage, or split roots of beets, turnips, etc., fed often.

(14). **General Ration for Adult Fowls and for Chicks when given Three Meals a Day.**—Morning,—mash; by measure, 2 parts finely cut alfalfa, 2 parts heavy bran (bran and middlings), 1 part corn meal; cook alfalfa in as much water as will make the quantity of mash needed of proper consistency (about the proportion of 5 gals. water to each peck of the hay); when boiling stir in the corn meal, or chop, making a thick mash; add the bran, making a very stiff, almost crumbly dough. Feed either hot or cold, all they will eat clean in ten to fifteen minutes. If other green food is abundant the hay may be omitted, (in which case not so much mash should be fed, and the green food given an hour or two after the mash). With the proportion of hay specified in the mash fowls *need* no other green food. Noon,—a light feed of oats or millet, dry or steamed; or of wheat—about one-half pint to every ten hens. Noon feed omitted on Sundays. Evening,—at 4 or 5 o'clock wheat, about 1 pint to every ten hens, in litter; at dusk whole corn to fowls that are waiting for it. Two or three times a week cut bone at mid-afternoon, and on these days the evening feed slightly reduced.

(15). **Ration for Small Flock, in Confinement, with Exercise.**—Morning,—mashes; alternating, one day table scraps and slops mixed cold with corn meal, shorts and bran equal parts; next day, 2 parts corn meal, 1 part fine shorts, 3 parts bran, a little meat meal. Make a thin mush of the corn meal, and pour while boiling over the other ingredients previously mixed dry in a pail; stir thoroughly to a stiff, almost crumbly dough; feed when cool. (A mash made in this way needs time to cook by its own heat). At noon vegetables or steamed clover occasionally. Afternoon feed, 3 o'clock,—cracked corn in heavy litter, 1 qt. to twelve hens two days; the third day same amount wheat. On cold evenings give at dusk all the whole corn that will be eaten greedily.

(16). **Forcing Ration for Broilers.**—(DUSTON).—First feed,—rolled oats, warm skim milk. First week,—rolled oats, millet seed, cracked corn. Second week,—use a little of a mash made of one-third corn meal to two-thirds wheat bran, seasoned with

salt and red pepper. When chicks eat mash freely alternate hard and soft foods. Third week and after,—first feed in morning, hard grain; next chopped raw potatoes followed by a little cut cabbage or onions. At 9 and 11 A. M., 1 and 3 P. M., mash. At 5 P. M., cracked corn. Finish off at six to eight weeks by adding cotton seed meal and a little treacle to the mash.

(17). **Ration for Broilers.**—(PRESSEY).—First ten days,—baked cake, 3 qts. corn meal, 1 qt. wheat middlings, 1 cup meat meal; mix with water or skim milk, to which has been added 4 tablespoons vinegar, 2 teaspoons soda; mashed potato once a day. After ten days, take 2 parts corn, 1 part wheat, 1 part oats, ground fine; to each 10 qts. of this mixture 1 qt. bran, 1 pt. middlings, 1 pt. meat meal, one-half cup bone meal; mix stiff with warm water two hours before feeding. Fatten on a mixture of 2 parts corn, 1 part wheat, ground together, ground meat added; mix stiff with warm water two hours before feeding; feed three or four times a day.

(18). **Ration for Broilers.**—(HOWE).—First ten days,—johnnycake, 1 pt. corn meal, 1 teacup bran, 1 teaspoon ground meat, 1 raw egg, 1 teaspoon soda, 1 teacup cold water; bake two hours. After ten days,—ground wheat, oats and corn, moistened. Oyster shell, bone and charcoal before the chicks in separate dishes.

(19). **Ration for Broilers.**—(PETERSON).—First ten days,—stale bread crumbs moistened with milk, alternated with dry bread crumbs at two hour intervals; skim milk to drink. After ten days,—ground corn 1 part to ground wheat 2 parts, moistened.

(20). **Ration for Broilers.**—(WHITE).—First week,—plain johnnycake, baked without soda. After first week,—mash, equal parts corn meal, bran and middlings, with a little meat scraps. (Lessen middlings if chicks become costive; increase middlings if chicks show looseness). Scatter a little grain about to induce exercise between feeds. Have grit and charcoal constantly by them; if chicks do not voluntarily eat charcoal it is mixed in the mash.

(21). **Ration for Chicks.**—(HUNTER).—First feed,—hard boiled eggs, chopped fine 1 part, to dry bread crumbs 3 parts. First five or six weeks,—coarse oat meal moistened with skim milk alternated at two hour intervals with dry bread crumbs until 4 P. M., then feed cracked wheat or corn. Meat twice a week; green food often. From six to ten weeks old,—morning, bread crumbs; 10 A. M., oat meal; 1.30 P. M., cracked wheat; 5 P. M., whole wheat and cracked corn, alternately; vegetables and meat continued as before. After ten weeks,—rations as for adult fowls. (See ¶13).

(22). **Ration for Chicks for Stock Birds.**—(BOYER).—First week,—rolled oats or pin head oat meal fed in troughs, alternate with stale bread crumbs, dry; boiled milk to drink. After first week —mash, 2 parts bran, 1 part corn meal, (or 2 parts bran, 1 part corn meal, 1 part ground wheat), a handful of meat scraps to a pail of mash. After two weeks give also cracked wheat and corn. Keep grit, oyster shell, and powdered charcoal by them. Feed freely green tops; or, if these cannot be had, roast potatoes cut in halves.

(23). **Ration for Chicks for Stock Birds.**—(RUDD).—First two weeks,—crumbled johnnycake (from waste bread) and granulated oats, dry; green food and powdered charcoal constantly before them. After two weeks whole or broken wheat and cracked corn added. At three weeks begin to give moist food, stale bread soaked in sweet milk, thickened with corn meal,—meal about one-half of the whole. At four weeks discontinue granulated oats. Cracked corn always before the chicks until they are old enough to eat whole corn, then whole corn always before them until full grown.

(24). **Ration for Chicks for Stock Birds.**—(FELCH).—First meal,—boiled eggs chopped fine, shell and all, with baked corn cake, or excelsior meal cake, crumbled

with scalded milk; then, morning, excelsior meal bread and scalded milk; 10 A. M., granulated corn; 2 P. M., excelsior meal bread and scalded milk; 6 P. M., canary seed, millet seed, granulated corn. After two weeks a varied diet, two soft feeds alternating with two hard feeds, excelsior meal bread frequently given, and morning mash often mixed with meat or in broth of meat; green food fed regularly.

Excelsior Meal—grind together 20 lbs. corn, 15 lbs. oats, 10 lbs. barley; add 10 lbs. wheat bran. To make cakes: take,—one quart sour milk or buttermilk, add a little salt and molasses, a quart of water, a heaping teaspoon saleratus; thicken with the meal, a little thicker than batter for corn cakes; bake in shallow pans.

(25). **Ration for Chicks for Stock.**—(LAMBERT).—Corn, wheat, oats, equal parts, ground; mix with milk, bake; feed all they will eat five times a day, at three hour intervals. After four weeks alternate with cracked corn, crushed wheat, etc. Use whole corn and wheat as soon as it is eaten easily. If milk cannot be obtained for johnnycake, mix alternately with desiccated fish and animal meal.

(26). **Ration for Chicks on Range.**—(Mrs. THOMAS).—Warm mash (same as for old fowls), in the morning; millet where they can get it all day long; whole wheat at night; night feed varied occasionally by using other grains.

(27). **Rations for Chicks, for Stock Birds on Limited Range or in Roomy Yards.**—*Winter.*—Morning,—mash as for old fowls (§14); 9 A. M., baked cake of corn chop and house scraps, made as follows: add a little soda to sour milk; throw in the scraps, finely broken; stir in the chop to make a very stiff batter. (The stiffer the better. Thin batter takes longer to bake, and bakes with a thicker, tougher crust); bake in deep pans, well greased. Feed the heart of this cake in chunks, the crust crumbled or cut in a bone cutter. Feed cake again at 11.30 A. M. and 2.30 P. M. At dusk feed whole wheat. Give both milk and water to drink, boiling the milk if there are symptoms of looseness of the bowels. *Summer.*—5.30 A. M., mash; 7.30 A. M., green food, lettuce or cabbage; 9 A. M., corn cake; 11 A. M., millet; 2 P. M., corn cake; 4 P. M., corn cake, meat, or green food; 6 to 7 P. M., whole wheat, all they will eat, followed by corn either cracked or whole. (It will be found that chicks after eating their fill of one kind of food will shortly, if given the opportunity, stuff themselves on another. It will not hurt them in the least to do this in *the evening*, and this method of feeding can be made very effective in forcing growth).

(28). **Rations for Chicks on Good (Orchard) Range.**—Mash (as in (§15)), 5.30 A. M.; cracked corn, 9.30 A. M.; cracked corn, whole wheat, or mash, 2 P. M.; cracked corn, 6 P. M.

147. Good Feeding Requires Skill.—No matter how thorough a “book knowledge” one may have of the properties of foods and the principles of feeding, no matter how familiar he may be with accepted formulas for correct feeding, or how closely he may follow a good system of feeding, he finds that good feeding depends finally on SKILL. Skill is acquired only through practice. Skill in feeding is not merely mechanical. It depends on a judgment trained to observe, closely and without conscious effort, the appearances of fowls, to note beginnings of departures from normal growing or producing conditions, and to decide, as if by instinct, how to preserve or restore the health of the fowls.

CHAPTER VIII.

Science in Poultry Feeding.

148. Where Common Knowledge Fails.—Purely practical knowledge and skill, enough for ordinary use, can be acquired without study of the science of feeding. The simple instruction which helps to a common sense understanding of the needs of an animal organism and plain knowledge of the properties of the staple poultry foods, is enough for most poultry keepers — enough for all as long as only familiar articles are used in approved combinations. But when it is advisable to use other articles or untested combinations, this common knowledge fails. It has not equipped the feeder to work out feeding problems for himself. Work at them he may, through a tiresome and expensive course of haphazard experiments, but there is no need that he should follow such a course. An elementary knowledge of the science of feeding, and access to a table giving the analyses of the food stuffs he wishes to use, make it possible for him to formulate rations with absolute certainty as to their theoretic value, and reasonable expectation of their practical feeding value.

149. Food Requirements of Fowls.—The food which a fowl eats has three functions: (1). To develop and maintain its organic structure; (2). To keep it warm — to keep up heat *in* the body; (3). To furnish the strength — energy — which is expended in every movement. The chemical elements which maintain these functions are found in combination in every article of food, constituting its digestible matter; in the staple grains they occur in nearly the proportions required by fowls under average normal conditions.

150. Food Elements may be classed as: *Principal* and *Subordinate*.

PRINCIPAL FOOD ELEMENTS are:

(1). *Proteids* (or protein) albuminous, or nitrogenous matter; in grains, gluten; in milk, casein; in meat and blood, fibrin; in bones, gelatin. Protein is the nourishing matter, supplying material for bone, muscle, blood, feathers, eggs.

(2). *Carbohydrates* (technically, "nitrogen-free extract"), carbonaceous matter, principally starches. Carbohydrates form the bulk of the dry matter in nearly all foods, and are the principal sources of heat and energy, which, as is well known, are convertible.

(3). *Fats*.—Found to some extent in every article of food. Their function is to furnish heat and energy, on demand, in addition to the supply from the carbohydrates, to store up fat as a reserve of heat and energy within the body, and to furnish the material for elementary growth cells which are developed by the protein. Fat also enters largely into the composition of the egg, forming nearly one-half its solids.

As far as known these elements have the same properties, no matter what the form in which they occur. In the last effect, it makes no difference whether the sources of the protein, carbohydrates and fats assimilated were vegetable or animal. It is known, however, that in animal foods the elements are more completely digestible than in grains, and more digestible in grains than in vegetables and fruits; and it has been observed that of two foods, one animal, the other vegetable, containing large and nearly equal proportions of protein or of fat, the animal food is generally preferred—is more palatable. In formulating working standards and in making practical applications of the laws of foods, using the chemical analyses of articles, the principal elements are regarded as completely digestible. The subordinate elements are regarded as indigestible, and are omitted from calculations. The results thus obtained, while not strictly accurate, are sufficiently so for practical purposes.

SUBORDINATE FOOD ELEMENTS are :

(1). *Ash*—lime and other mineral matter, occurring generally in very small quantities, except in such articles as bone and shell—partly digestible.

(2). *Fiber*, husks or waste matter—mostly, if not completely indigestible.

151. Principal Elements Can Mutually Assist Each Other.—The principal food elements, though having each its special function, are not wholly independent. Within limits they may be said to be able, on occasion, to do each other's work. The relations of fats and carbohydrates have been indicated. Carbohydrates are cheap fuels for ordinary use. Fats are expensive fuels for emergency use. Any deficiency of carbohydrates and fats in a ration will be at least partially made up by the diversion of a part of the protein from its proper function. With a sufficiency of carbonaceous matter, the entire consumption of protein is available for growth and maintenance. Further than this, a deficiency of protein is not made up from the other elements. Scientific opinion as to the effects of feeding the various elements to excess is not unanimous, nor are any of its expressions decided enough to be taken as authoritative.

It is said that an excess of carbohydrates pours through the system undigested. That supposition is contrary to the known effects of feeding heavily of carbonaceous matter. The immediate consequence of feeding fat to excess is scouring. Some authorities on feeding say all the protein taken into the system is used: *i. e.* — an excess of protein is impossible. But this is not in accordance with practical experience in feeding “narrow” or highly nitrogenous rations. Experience teaches that such rations cause digestive troubles as surely, if not as quickly, as an excess of fats.

152. Food Values.— There are two standards of measurements of food values:

(1). The measurement of quality, of proportionate value of principal elements: — **NUTRITIVE RATIO.**

(2). The measure of bulk, of content, of degree of concentration, of total heating capacity: — **POTENTIAL ENERGY.**

The **NUTRITIVE RATIO** of a food (single article or mixture) is the ratio of its proteids to its carbohydrates and fats, reduced to terms of carbohydrates; — one part of fat by weight having a fuel value two and one-half times as great as an equal weight of carbohydrates. The chemical analysis of a food being known, the nutritive ratio is determined thus, taking corn as the example:

Corn (see table, ¶153) contains 10.4 parts protein, 70.3 parts carbohydrates, 5 parts fat: its nutritive ratio is:

$$10.4 : 70.3 + (5 \times 2.5) = 1 : 7.9.$$

The **POTENTIAL ENERGY** of a food is the gross fuel value of its digestible matter. It is expressed in *calories* per ounce. A *calory* is the amount of heat required to raise one gram of water one degree centigrade. One ounce of carbohydrates or protein has a potential energy of one hundred and sixteen *calories*. One ounce of fat has a potential energy of two hundred and sixty-four *calories*. The potential energy of any food substance of which the chemical composition is known is calculated thus, taking corn again as the example, and using the figures in the table as percentages of an ounce:

$$(264 \times .05) + (.703 + .104) 116 = 106.$$

The nutritive ratio and potential energy of each single article may, when computing values of compound foods, or of rations, be regarded as constant quantities. As a matter of fact, they vary greatly in different samples of the same article, but calculations from the figures in the table, which are averages of a large number of analyses, may properly be assumed to give the average and usual values of the different foods.

The values of a ration vary with its ingredients, and are calculated from averages of the values of the ingredients. (See ¶158).

153. Table of Analyses and Computed Values of Food Stuffs.*

FOODS.	Gross contents, percentages.		Composition of dry matter, in percentages of the whole.					Valuation.	
	Water.	Dry Matter.	Fiber.	Ash.	Protein.	Carbo- hydrates.	Fat.	Nutritive Ratio.	Potential Energy.†
<i>Corn (Maize) and Corn Products.</i>									
Field corn	10.9	89.1	1.9	1.5	10.4	70.3	5.0	1: 7.9	106
Sweet corn	8.8	91.2	2.8	1.9	11.6	66.8	8.1	1: 7.5	111
Pop corn	10.7	89.3	1.8	1.5	11.2	69.2	5.2	1: 7.3	107
Small and immature ears of field corn	35.7	64.3	1.0	0.9	7.3	50.7	3.5	1: 8.1	68
Cracked corn	12.3	87.7	1.3	8.6	73.9†	3.9	1: 9.5	103
Corn meal.....	15.0	85.0	1.9	1.4	9.2	68.7	3.8	1: 8.5	100
Corn and cob meal.....	15.1	84.9	6.6	1.5	8.5	64.8	3.5	1: 8.6	94
Corn germ	10.7	89.3	4.1	4.0	9.8	64.0	7.4	1: 8.4	105
Hominy chops §.....	11.1	88.9	3.8	2.5	9.3	64.5	8.3	1: 8.7	108
Gluten meal	9.6	90.4	1.6	0.7	29.4	52.4	6.3	1: 2.3	111
Starch feed (wet)	65.4	34.6	3.1	3.0	6.1	22.0	3.1	1: 4.8	30
<i>Wheat and Wheat Products.</i>									
Wheat	10.5	89.5	1.8	1.8	11.9	71.9	2.1	1: 6.3	102
Wheat screenings	11.6	88.4	4.9	2.9	12.5	65.1	3.0	1: 5.8	97
Low grade flour	12.4	87.6	0.9	0.7	10.0	75.0	1.0	1: 7.7	101
Wheat bran.....	11.9	88.1	0.9	5.8	15.4	53.9	4.0	1: 4.1	90
Wheat middlings	12.1	87.9	4.6	3.3	15.6	60.4	4.0	1: 4.7	98
Dry bread	31.2	68.8	6.9	44.2	0.5	1: 6.6	61
<i>Oats and Oat Products.</i>									
Oats	11.0	89.0	9.5	3.0	11.8	59.7	5.0	1: 6.1	96
Oat meal	7.9	92.1	0.9	2.0	14.7	67.4	7.1	1: 5.8	113
Oat bran	7.7	92.3	19.3	3.7	7.1	57.9	2.3	1: 8.9	81
Oat feed.....	8.2	91.8	12.5	4.2	12.6	56.3	6.2	1: 5.7	96
Oat middlings	9.2	90.8	3.8	3.2	20.0	56.2	7.6	1: 3.7	108
<i>Barley and Barley Products.</i>									
Barley	10.9	89.1	2.7	2.4	12.4	69.8	1.8	1: 6	100
Barley screenings	12.4	87.6	7.6	3.6	12.2	61.6	2.6	1: 5.5	92
Barley meal	11.9	88.1	6.5	2.6	10.5	66.3	2.2	1: 6.8	93
Malt sprouts.....	10.2	89.8	10.7	5.7	23.2	48.5	1.7	1: 2.3	87
Brewers' grains (wet).....	75.7	24.3	3.8	1.0	5.4	12.5	1.6	1: 3	24
Brewers' grains (dry)....	8.2	91.8	11.0	3.6	19.9	51.7	5.6	1: 3.3	97
Distillers' waste.....	5.0	95.0	8.0	11.3	27.4	36.1	12.2	1: 2.4	105
<i>Buckwheat and Buckwheat Products.</i>									
Buckwheat	12.6	87.4	8.7	2.0	10.0	64.5	2.2	1: 7	83
Buckwheat groats 	10.6	89.4	0.3	0.6	4.8	83.1	0.6	1: 17	103
Buckwheat bran.....	14.0	86.0	14.7	3.4	17.1	46.4	4.4	1: 3.3	85
Buckwheat middlings ...	13.2	86.8	4.1	4.8	28.9	41.9	7.1	1: 2.1	101
<i>Rye and Rye Products.</i>									
Rye	11.6	88.4	1.7	1.9	10.6	72.5	1.7	1: 7.2	100
Rye bran.....	11.6	88.4	3.5	3.6	14.7	63.8	2.8	1: 4.8	98

* The analyses here given are taken principally from United States Government Bulletins.

† Including fiber.

§ Baltimore meal.

|| Hulled or crushed buckwheat.

† In one ounce.

Analyses and Computed Values of Food Stuffs.—Continued.

Foods.	Gross contents, percentages.		Composition of dry matter, in percentages of the whole.					Valuation.	
	Water.	Dry matter.	Fiber.	Ash.	Protein.	Carbo-hydrates.	Fat.	Nutritive Ratio.	Potential Energy.*
<i>Mixed Feeds.</i>									
Ground corn and oats equal parts	11.9	88.1	2.2	9.6	71.9†	4.4	1: 8.6	106
Corn and bran feed, 8 parts corn, 5 parts bran	11.5	88.5	2.7	10.6	71.2†	4.0	1: 7.6	105
Corn, rye and oats	10.4	89.6	1.9	10.6	73.7†	3.4	1: 7.4	106
"Provender," 450 lbs. corn, 125 lbs. oats, 100 lbs. bran	9.4	90.6	10.4	3.1	13.0	58.8	5.3	1: 5.5	97
<i>Miscellaneous.</i>									
Sorghum seed	12.8	87.2	2.6	2.1	9.1	70.0	3.6	1: 8.6	102
Sorghum seed meal	13.2	86.8	1.8	1.6	8.3	71.3	3.8	1: 9.7	102
Broom corn seed	14.1	85.9	7.1	2.0	9.6	64.7	3.5	1: 7.6	95
Broom corn seed meal	13.5	86.5	6.9	2.1	9.7	64.2	3.6	1: 7.3	95
Sorghum, chicken corn	14.8	85.2	8.7	4.3	10.6	58.9	2.7	1: 6.2	87
Chinese corn	7.9	92.1	1.8	1.5	9.6	75.5	3.7	1: 8.8	108
Brown dhoura ‡	7.6	92.4	1.5	1.7	9.0	76.0	4.2	1: 9.6	110
Millet	13.5	86.5	9.5	3.0	12.7	58.0	3.3	1: 5.2	83
Hemp seed	8.0	92.0	14.0	2.0	10.0	45.0	21.0	1: 9.7	119
Rape seed	13.8	86.2	10.0	3.9	19.4	10.4	42.5	1: 6.3	147
Flaxseed	11.8	88.2	7.9	3.4	21.7	19.6	35.6	1: 5	141
Ground linseed	8.1	91.9	7.3	4.7	21.6	27.9	30.4	1: 4.8	137
Linseed meal, old process	9.2	91.8	8.9	5.7	32.9	35.4	7.9	1: 1.7	99
Linseed meal, new process	10.1	89.9	9.5	5.8	33.2	38.4	3.0	1: 1.4	91
Cotton seed meal	8.2	91.8	5.6	7.2	42.3	23.6	13.1	1: 1.3	111
Cotton seed hulls	10.4	89.6	44.4	2.6	4.0	36.6	2.0	1: 10.1	52
Sunflower seed	8.0	92.0	28.5	3.0	13.0	23.9	23.6	1: 6.3	105
Rice	12.4	87.6	0.2	0.4	7.4	79.2	0.4	1: 10.9	101
Rice bran	9.7	90.3	9.5	10.0	12.1	49.9	8.8	1: 5.9	95
Rice hulls	8.2	91.8	35.7	13.2	3.6	38.6	0.7	1: 11.2	48
Rice (flour) polish	10.0	90.0	6.3	6.7	11.7	58.0	7.3	1: 6.5	80
Cockle bran	11.1	88.9	9.2	3.2	10.6	63.5	2.5	1: 6.5	82
Cocoa dust	7.1	92.9	5.4	6.3	14.4	42.8	24.0	1: 7	129
<i>Dry Hay.</i>									
Red clover	15.3	84.7	24.8	6.2	12.3	38.1	3.3	1: 3.7	67
White clover	9.7	90.3	24.1	8.3	15.7	39.3	2.9	1: 2.9	71
Alfalfa	8.4	91.6	25.0	7.4	14.3	42.7	2.2	1: 3.4	71
Timothy	13.2	86.8	29.0	4.4	5.9	45.0	2.5	1: 8.7	66
<i>Grass and Tops.</i>									
Green grass, clippings	76.4	23.6	4.1	2.4	2.3	13.8	1.0	1: 7	15
Cabbage	90.5	9.5	1.5	1.4	2.4	3.9	0.4	1: 2	8
Dandelion tops	14.5	85.5	0.5	2.5	7.3	0.6	1: 3.5	13
Beet tops	90.0	10.0	0.1	1.3	2.3	0.3	1: 2.3	5
Onion tops	91.0	9.0	0.1	0.8	3.0	0.2	1: 2.7	8
Lettuce	95.9	4.1	0.5	0.8	1.0	1.6	0.2	1: 2.1	4
Spinach	92.4	7.6	0.7	1.9	2.1	2.4	0.5	1: 1.7	6

* In one ounce. † Including fiber. ‡ Also, durra and dari, akin to Kaffir corn and Millo maize.

Analyses and Computed Values of Food Stuffs.—Continued.

FOODS.	Gross contents, percentages.		Composition of dry matter, in percentages of the whole.					Valuation.	
	Water.	Dry matter.	Fiber.	Ash.	Protein.	Carbo-hydrates.	Fat.	Nutritive Ratio.	Potential Energy.*
<i>Vegetables — Seeds.</i>									
Peas	13.4	86.8	6.4	2.4	22.4	52.6	3.0	1: 2.4	85
Cow peas	14.8	85.2	4.1	3.2	20.8	55.7	1.4	1: 2.88	92
Pea meal	10.5	89.5	14.4	2.6	20.2	51.1	1.2	1: 2.6	85
White field beans	15.0	85.0	3.2	3.1	20.4	56.7	1.6	1: 3	93
Navy beans	12.4	87.6	7.2	3.7	22.2	53.1	1.4	1: 2.5	90
Soja beans	10.8	89.2	4.8	4.7	34.0	28.8	16.9	1: 2.1	117
<i>Vegetables — Fruits.</i>									
Tomatoes	91.3	8.7	0.7	0.7	1.0	5.8	0.5	1: 7	9
Apples	84.1	15.9	0.9	0.2	0.2	14.3	0.3	1: 75	17
Cucumbers	96.0	4.0	0.7	0.5	0.8	1.8	0.2	1: 2.8	3
Pumpkin, flesh	93.5	6.5	1.0	0.6	0.9	3.9	0.1	1: 4.6	6
Pumpkin, seeds and stringy part	76.9	23.1	3.9	1.5	6.0	4.8	6.9	1: 2	31
<i>Vegetables — Roots.</i>									
White potatoes	78.9	21.1	0.6	1.0	2.1	17.3	0.1	1: 8.3	22
Sweet potatoes	71.1	28.9	1.3	1.0	1.5	24.7	0.4	1: 17.1	31
Red beets	88.5	11.5	0.9	1.0	1.5	8.0	0.1	1: 5.5	11
Sugar beets	86.5	13.5	0.9	0.9	1.8	9.8	0.1	1: 5.5	13
Mangel wurzels	90.9	9.1	0.9	1.1	1.4	5.5	0.2	1: 4.3	8
Turnips	90.5	9.5	1.2	0.8	1.1	6.2	0.2	1: 6	8
Ruta bagas	88.6	11.4	1.3	1.2	1.2	7.5	0.2	1: 6.6	10
Carrots	88.6	11.4	1.3	1.0	1.1	7.6	0.4	1: 7.8	11
Parsnips	81.0	19.0	6.3	1.0	1.6	8.5	1.6	1: 7.8	15
Onions	87.6	12.4	0.7	0.6	1.4	9.4	0.3	1: 7.2	13
Peanuts, hulled	10.9	89.1	3.1	3.8	31.5	46.9	3.8	1: 1.4	100
<i>Milk.</i>									
Whole milk	87.2	12.8	3.5	4.8	3.7	1: 4	18
Skim milk, raised	90.4	9.6	3.1	4.7	0.8	1: 2	11
Skim milk, separated	90.6	9.4	2.9	5.2	0.3	1: 2	10
Buttermilk	90.1	9.9	3.9	4.0	1.0	1: 1.6	11
<i>Animal Food.</i>									
Beef scrap	1.3	98.7	8.0	58.0	32.9	1: 1.4	154
Pork scrap	0.8	99.2	2.2	57.4	39.6	1: 1.7	170
Dried blood	6.7	93.3	6.6	65.1	5.3	16.3	1: 0.6	124
Green bones	6.9	93.1	24.5	22.3	16.5	1: 1.8	69

* In one ounce.

154. Working Standards of Nutritive and Potential Values.—The feeding values, as determined by practical results, of the common articles and compounds of food being known; the average proportions and potencies of their parts, as determined by chemists, being also known; the determination of *working standards* of nutritive ratio and potential energy becomes a simple mathematical calculation.

The mash described in ¶146, (2), has — computing the values of its solids, the amount of beef scraps being doubled, as the weight of milk used is not known,— a nutritive ratio of 1:5.1; a potential energy of 99 calories per ounce. The mixed grain fed with this mash has, in summer, a nutritive ratio of 1:6.8; a potential energy of 95; in winter, a nutritive ratio of 1:6.8; a potential energy of 96. The means of these values may fairly be taken as the values of the complete ration, for the feed of green stuff given at noon is too light to materially affect the values of the ration as a whole, and its tendency to reduce these values is offset by the occasional noon feeds of grain with their tendency to increase the values. The mean values are for the summer ration nutritive ratio 1:5.9; potential energy 97; for the winter ration, nutritive ratio 1:6; potential energy 97.5.

Wheat, the best grain for poultry, itself a practically complete grain ration, has a nutritive ratio of 1:6.3; a potential energy of 102. Barley, the next best grain, has a nutritive ratio of 1:6; a potential energy of 100. A mixture of corn and wheat, equal parts, has a nutritive ratio of 1:7.1; a potential energy of 104. A mash of 3 parts corn meal to 1 part shorts, recommended by one of the highest authorities, on feeding (Rankin), to use with wheat and corn as a food for young chicks, has a nutritive ratio of 1:7; a potential energy of 100. (The green food used with that ration would slightly narrow the ratio and reduce the energy). *Germ meal*, a mixture of equal parts ground oats, corn, barley and wheat, has a nutritive ratio of 1:6.6; a potential energy of 101. A mixture of bran, corn meal and oat meal, equal parts, has a nutritive ratio of 1:5.5; a potential energy of 101. The mixture (see ¶146 (5)) of 100 lbs. bran, 75 lbs. corn, 100 lbs. oats, 50 lbs. linseed meal, has a nutritive ratio of 1:5.5; a potential energy of 100. "Excelsior Meal" (see ¶146 (24)) has a nutritive ratio of 1:6; a potential energy of 101.

The averages of these values give *for the standard of Nutritive Ratio, 1:6; for the standard of Potential Energy 100 calories per ounce.**

Computed values of approved fattening rations give a standard for nutritive ratio, 1:8; for potential energy, 108.

* NOTE.—The method which arrives at these standards is, perhaps, shirt-sleeves science. It is more accurate, none the less, than the more formal method of those who may rightly be called the founders of the science of poultry feeding. This practical tests will show. The trouble with students of the science of poultry feeding, has been that they were better scientists than poultry men, and have been establishing standards and deducing principles from the data of experiments, which, from a practical standpoint, were partial failures. Such standards as, *nutritive ratio 1:3.5 for young chicks; 1:4 for laying hens; 1:6 for special fattening*; with potential energies ranging from 50 to 90, are not practicable. The feeder learns this as soon as he begins to use them. They were suggested by false analogies from cattle feeding standards. Milk, which is a perfect food — for a young calf — has a nutritive ratio of 1:4. The chicks' digestive organs are adapted to a concentrated food: therefore — it was reasoned — the nutritive ratio for chicks must be narrower. The contrary of this proposition is true: *the nutritive ratio of a concentrated food must be wider than of a bulky food.* The reasons for this need not be given here. The fact can be verified by examining the table. It will appear that natural foods having

155. Use of Feeding Standards.—The practical value of a scientific knowledge of feeding is that it enables a feeder to make up his ration “in the rough” with absolute certainty that he has made no radical error—none that will not in the natural course of things soon be adjusted. A ration based on (not necessarily adhering rigidly to) a correct standard is, in the hands of a skillful feeder, practically self-adjusting. The calculations of values in approved rations show that for ordinary purposes variations from the standard, if made at all, need be but very slight; for the differences between supply and demand are not usually greater than will be controlled by the involuntary adjustments of the natural checks and balances, viz.:—the limited capacity of the digestive organs; the sense of taste, the instincts of hunger, the natural cravings of a healthy appetite for the food articles best suited to meet present requirements of the system; the convertibility of the principal food elements; the *tendency* of the fowl’s system to make the most of the food taken, expending some in egg production, using some for growth, storing some as fat, squandering some as exuberant energy—these are all constantly working to bring about a proper balance of means and results, and the feeder’s part must be very badly done, indeed, if they fail.

156. Extent of Actual Variations, from the Standards, in Complete Rations.—The system’s demands for material for growth, or maintenance, and strength, are, on the whole, very nearly constant for mature fowls, and uniformly increasing for chicks. Fluctuations in food requirements are due principally to variations in the amount of heat required to keep the body warm. The standards of ratio and energy ascertained are for average conditions, such as obtain generally in moderate weather, and in warm houses in cold weather. Under such conditions the values of the grain ration are the values of the whole ration, the small quantities of vegetables and meat eaten affecting it but little. In summer the food actually consumed by a properly fed fowl would have a narrower nutritive ratio than 1 : 6, and potential energy lower than 100. The reduction would follow reduction in the quantity of the grain ration, and large increase in the quantity of vegetables eaten, and would be governed solely by the appetites of the fowls. In winter the heat of the body is maintained partly by feeding more heating foods, but mostly by warm housing and by giving the food and drink *warm*. The actual variation of a ration from narrow nutritive ratios are bulky foods, diluted either with water or with fiber. Low potential energies are for hot-house conditions. Narrow nutritive ratios are extravagant. Protein is the rarest and most costly food element. If one feeder uses a ration with a nutritive ratio of 1 : 4, and another a ration with a nutritive ratio of 1 : 6, the general conditions and the results in both cases being alike, the inevitable conclusion is that the wider ratio furnished, at least, as much protein as the system needed, and that one-third of the protein of the narrower ration was used for fuel. It would be no easy matter to find a ration compounded with a view to cheapness and the best all round results, and proved by long practical tests, which would, when computed, show a nutritive ratio anything like as narrow as 1 : 4, or a potential energy lower than 90, except, possibly, in extremely hot weather.

the standard is much greater in warm weather than in cold. Computations for summer rations, in the hottest weather, would, without doubt, sometimes show nutritive ratio as narrow as 1:4, and potential energy as low as 50;—but not very often. Computations of good winter rations, for rather cold houses, would rarely show values exceeding those of the average fattening ration.

157. The Balance of the Ration.—It is clear that a ration can be exactly balanced only at rare intervals, and then, as it were, only for the instant. Then if the ration is sufficient in quantity, there must be excess of either one kind of elements or the other. For economic reasons it is desirable that the excess be of the cheaper elements—the carbohydrates. The ration should always be a little *wide*, rather than a little *narrow*.

158. Examples in Balancing Rations:—

(1). To compute the values of the ration described in ¶146 (2):

Corn contains (see table, ¶153) 10.4% protein, 70.3% carbohydrates, 5% fat; wheat, 11.9% protein, 71.9% carbohydrates, 2.1% fat; bran, 15.4% protein, 53.9% carbohydrates, 4% fat; beef scraps, 58% protein, 32.9% fat; then

	Protein lbs.	Carbohydrates lbs.	Fats lbs.
94 lbs. corn contain	9.77	66.08	4.7
106 lbs. oats contain	12.5	63.28	5.3
100 lbs. bran contain	15.4	53.9	4.
12 lbs. beef scraps contain	6.96	...	3.94
<hr/> 312 lbs. mixture contain	<hr/> 44.63	<hr/> 183.26	<hr/> 17.94

and the nutritive ratio of the mash is:

$$44.63 : (17.94 \times 2.5) + 183.26 = 1 : 5.1;$$

and potential energy for 312 lbs. is:

$$(17.94 \times 16 \times 264) + [(44.63 \times 183.26) 16 \times 116] = 494.208 \text{ calories,}$$

and potential energy per oz. is 99 calories.

The computation of the whole grain given in this ration gives:—

	Protein lbs.	Carbohydrates lbs.	Fats lbs.
120 lbs. wheat contain	14.28	86.40	2.52
64 lbs. oats contain	7.55	38.20	3.2
120 lbs. buckwheat contain	12.	77.40	2.64
56 lbs. corn contain	5.82	39.36	2.8
<hr/> 360 lbs. mixture contain	<hr/> 39.65	<hr/> 241.36	<hr/> 11.16

Nutritive ratio, 1 : 6.8; potential energy, 95 calories per ounce.

	Protein lbs.	Carbohydrates lbs.	Fats lbs.
(2).			
20 lbs. potatoes contain	.42	3.46	.02
10 lbs. oat middlings contain	2.	5.62	.76
10 lbs. corn meal contain	.92	6.87	.38
20 lbs. wheat bran contain	3.08	10.78	.8
3 lbs. pork scrap contain	1.72	1.18
<hr/> 63 lbs. mixture contain	<hr/> 8.14	<hr/> 26.73	<hr/> 3.14

Nutritive ratio, 1 : 4; potential energy, 75 calories per ounce.

Fed with whole corn, one feed mash one feed corn per day, the ration has a nutritive ratio of 1 : 5.9; a potential energy of 90 calories per ounce.

	Protein lbs.	Carbohydrates lbs.	Fats lbs.
(3).			
5 lbs. alfalfa hay contain	.71	2.13	.11
20 lbs. corn meal contain	1.84	13.74	.76
20 lbs. wheat bran contain	3.08	10.78	.8
2 lbs. dried blood contain	1.3	.1	.33
<hr/> 47 lbs. mixture contain	<hr/> 6.93	<hr/> 26.75	<hr/> 2.

Nutritive ratio, 1 : 4.6; potential energy, 94 calories per ounce.

This fed for one-third the whole ration, the other two-thirds being corn and oats equal parts, gives nutritive ratio, 1 : 6.1; potential energy, 101 calories per ounce. Fed with whole corn equal parts, it gives, nutritive ratio, 1 : 6.1; potential energy, 100 calories per ounce.

	Protein lbs.	Carbohydrates lbs.	Fats lbs.
(4).			
5 lbs. cut clover contain	.61	1.9	.16
5 lbs. cotton seed meal contain	2.11	1.18	.65
20 lbs. corn meal contain	1.84	13.74	.76
20 lbs. wheat bran contain	3.08	10.78	.8
<hr/> 50 lbs. mixture contain	<hr/> 7.64	<hr/> 27.60	<hr/> 2.37

Nutritive ratio, 1 : 4.4; potential energy, 94 calories per ounce.

Fed with corn equal parts, gives nutritive ratio, 1 : 6.1; potential energy, 100 calories per ounce.

Fed with grain one-third rice, two-thirds corn, gives nutritive ratio, 1 : 7.1; potential energy, 100 calories per ounce.

In making trial formulas for rations, the simplest method is to write the formula for parts, by weight; 1 part being always 1 ounce, as in the following examples:

(5).

	Protein ozs.	Carbohydrates ozs.	Fats ozs.
1 part buckwheat middlings contains	.289	.419	.071
1 part corn meal contains	.092	.687	.038
1 part wheat bran contains	.154	.539	.04
<hr/>			
3 ounces of mixture contain	.535	1.645	.149
<hr/>			
1 ounce of mixture contains	.178	.548	.049

Nutritive ratio, 1 : 3.8; potential energy, 97 calories per ounce.

With corn equal weight, nutritive ratio, 1 : 5.8; potential energy, 101 calories per ounce. .

(6).

	Protein ozs.	Carbohydrates ozs.	Fats ozs.
1 part buckwheat middlings contains	.289	.419	.071
2 parts corn meal contain	.184	1.374	.076
2 parts wheat bran contain	.308	1.078	.08
<hr/>			
5 ounces of mixture contain	.781	2.871	.227
<hr/>			
1 ounce of mixture contains	.26	.957	.075

Nutritive ratio, 1 : 4.4; potential energy, 97.5 calories per ounce.

With corn equal weights, nutritive ratio, 1 : 6.1; potential energy, 101 calories per ounce.

(7).

	Protein ozs.	Carbohydrates ozs.	Fats ozs.
1 part buckwheat middlings contains	.289	.419	.071
3 parts corn meal contain	.276	2.061	.114
2 parts wheat bran contain	.308	1.078	.08
<hr/>			
6 ounces of mixture contain	.873	3.558	.265
<hr/>			
1 ounce of mixture contains	.145	.593	.044

Nutritive ratio, 1 : 4.8; potential energy, 97 calories per ounce.

With whole corn, nutritive ratio, 1 : 6.3; potential energy, 101 calories per ounce.

(8).

	Protein ozs.	Carbohydrates ozs.	Fats ozs.
3 parts dry bread contain	.207	1.326	.01
1 part wheat middlings contains	.156	.604	.04
2 parts corn meal contain	.184	1.374	.076
<hr/>			
6 ounces of mixture contain	.547	3.304	.126
<hr/>			
1 ounce of mixture contains	.091	.55	.021

Nutritive ratio, 1 : 6.6; potential energy, 70 calories per ounce.

159. Hints as to Changing the Values of a Ration, the Bulk Remaining the Same:—

To reduce the potential energy of a ration without materially changing its nutritive ratio:— add substances having nearly standard nutritive ratios and low potential energies;—for slight reductions hard grains, buckwheat, oats, chicken corn, etc.; for considerable reductions, such vegetables as beets, turnips, carrots, etc.

To slightly reduce the potential energy, and make the nutritive ratio narrower:— add raw meat, green cut bone, peas, beans, hay (clover, alfalfa), having narrow nutritive ratios and low potential energies.

To considerably reduce the potential energy, and narrow the nutritive ratio:— add green vegetables—tops, skim milk, having narrow nutritive ratios and very low potential energies.

To reduce the potential energy while widening the nutritive ratio:— add potatoes, or apples; wide nutritive ratio with low potential energy.

To increase the potential energy, and narrow the nutritive ratio:— add dry animal foods, which have very narrow nutritive ratio with high potential energy.

To increase the potential energy, the nutritive ratio remaining fixed:— add substances rich in both protein and oil, nearly standard nutritive ratios with very high potential energies, as flaxseed, ground linseed.

The above propositions will be found useful guides in varying standard rations for special feeding, and also in bringing ill-balanced rations to the standard. They are stated with special reference to variety in rations. In general feeding the necessary changes can be made by varying the proportions of the articles used in a ration, as illustrated in some of the examples in ¶158; and in general, if the grain ration is nearly standard, and feeding regulated as suggested in ¶138, the ration as a whole will be as nearly balanced as it can be.

CHAPTER IX.

Egg Production.

160. Introductory.—The Objective Point in Egg Production.—

The final object of practical egg production is *profit*. A producer's profit is *the difference* between the cost of production and his selling price. As the difference between two small quantities may be greater than the difference between two larger quantities, so the profit on a comparatively small egg yield which costs little or nothing, may be greater than the profit on a large egg yield secured at considerable expense. Simple as this proposition is, and self-evident to everyone who stops to think about it, it needs to be emphasized here because of the prevalent mistaken notion that successful, profitable egg production depends on making hens lay as many eggs as possible in a short time; and, therefore, every poultry keeper should use all means to secure an extraordinarily large egg yield.

As stated in ¶ 18, the bulk of the egg supply in this country comes from hens kept under such conditions that the entire receipts for poultry products sold are profit,—the produce consumed at home fully paying for the salable food given the fowls and the little time spent in looking after them. Most of these small flocks of hens are productive only during the spring, summer, and early fall, when the conditions generally are favorable to egg production from hens kept in a semi-natural state—as they are on most farms and village lots. By giving them special care during the remainder of the year these flocks could be made almost constantly productive. Whether it would pay their keepers to give them the necessary extra care, is a question for individual decision. As it costs practically nothing to keep the hens, the loss when they are not productive is not an actual dead loss like the money one who has to buy food for his hens pays out on feed bills when the hens ought to be, and are not, laying. Nearly always those who do not give their fowls good care, just taking the egg yield as it comes, would find it more profitable to take some trouble, and, perhaps, go to a little extra expense for the sake of a possible considerable increase in the output of eggs when eggs are worth most; yet it is a good plan, before making arrangements on account of better laying, to reckon up and see whether it will really pay, and *how much* extra

work and cost the probable better results would justify. Once in a while an amateur poultry keeper allows his efforts to make a few hens lay to take time and create expense not warranted by the best possible results.

It is not good advice to every poultry keeper to urge him, by all means, to get the largest possible egg yield. Those who make a business of producing market eggs must, if the business is to pay its way and make the living, keep the flocks producing nearly all the time, and must secure high average yields of eggs; but even for such it is a question whether extraordinarily large egg yields will in every case be most profitable. It should be a part of a poultryman's business to determine this point in accordance with his circumstances, and he should work always for the most profitable egg yield — large or larger as the case may be — remembering that profit is measured in dollars and cents when the books are balanced, and remembering, too, that it is often easiest to increase profit by reducing expenses.

Of amateur poultry keepers whose interest centers in the production of eggs, there are many whose regular occupations leave them time to give a few hens as much care as will keep them laying fairly well under favorable conditions, but will not admit of their giving the fowls the careful regular attention necessary to secure particularly good results in eggs. There is a limit to what any person can do. A workingman, a business man, a professional man is not always able to give his hens the little extra attention required for a better egg yield: — even a farmer's ability to make the most of every opportunity afforded by the possession of land, is limited — though some people, not farmers, seem to think otherwise. It is the easiest thing in the world to *plan* all sorts of extra work — for other people. When it comes to *doing*, most people have to choose between one thing and another, and leave the less important thing undone, or do it indifferently. The latter course is the only one open to very many poultry keepers. Those who are wisest get what good they can out of their fowls, and are not disgusted because their hens do not lay as well as the best. Poultry keeping that yields profit with little trouble deserves consideration as well as that which is made profitable by great painstaking. Many who are not able to give hens the best care, are still concerned that what time they can give them shall be used to do the things it will pay best to do. Many whose fowls need little care want to know enough about what good care is to know what does and what does not constitute neglect under the conditions to which their fowls are subjected. However little time the reader is able to devote to his fowls, he is urged to study the chapter as a whole; for until one has a general knowledge of the ways and means of handling laying stock, he cannot determine how to handle his stock most satisfactorily.

To avoid repetitions the text of the chapter is adapted to business poultrymen making a specialty of market eggs. Information and suggestions for other classes of poultry keepers is placed in parentheses, or given in the foot notes.

161. What is a Good Egg Yield?—There are ordinary, *extraordinary*, and **VERY EXTRAORDINARY** egg yields.

An ordinary egg yield is from six to ten dozen eggs per hen per year. An extraordinary yield is from ten to fourteen dozen per hen. Anything over fourteen dozen eggs per hen is a very extraordinary egg yield.

Ordinary egg yields are obtained from average fowls under the general conditions found on most farms, and from small flocks not given special attention. Ordinary egg yields from flocks handled specially for heavy laying, are also quite common when unfavorable weather or other unavoidable contingency depresses the yield. The figures given for extraordinary egg yields indicate the normal fluctuations in the product from good stock well managed. Skill does not allow it to remain below the lower figure, and can rarely sustain it above the higher. Whatever may be said of the desirability of reaching an average of two hundred (or more) eggs per year per hen, the cold fact is that a twelve dozen per hen flock is an uncommonly good bunch of hens. Its record speaks well for its management.

162. The Early Winter Egg Crop.—Eggs in early winter are usually the feature of a large egg yield, though very prolific layers beginning to lay in mid-winter and continuing well into the fall can easily reach a high mark. In handling hens *for eggs only*, it is in every way desirable to get the hens to laying as early as possible, and take the chances of keeping them laying. (Some early winter layers lack staying qualities, and are poor layers). One who keeps fowls for eggs ought to do all in his power to get early winter eggs, but need not feel unduly discouraged if his best plans and efforts result sometimes in failure—total or partial—for here again the cold facts have consolation and encouragement for those that fail. The usual condition through November and December is that the hens are “getting ready to lay.” The beginning of the season of good laying is from December 15 to January 15, and, as has been said, hens beginning then can do highly satisfactory work. Beginners in egg farming commonly think that by selection, breeding for eggs, and feeding for eggs, they can establish a strain of hens that will begin laying as naturally in November as most hens do three or four months later. Selection and management *help* to get stock that can be put in condition to begin laying early in the winter; but there are some very potent factors working against early winter egg yields. These factors are: *unfavorable weather*, which may be expected about two years out of three; and the *natural reversionary tendency of hens not to lay in early winter*,—this tendency is always present, and acts with more or less strength, if given the least opportunity. Those two factors can put up a combination against which all the good breeding and skill in the world are powerless, unless resort is made to hot-house conditions for laying stock—a cure which, in the end, is worse than the disease. If this were not so very extraordinary egg yields and good egg yields in November and December would be the rule among

skilled poultrymen — not the exception, as they are now. When all is said and done, the condition of the egg crop in November and December is just as dependent on the weather as the condition of the wheat crop just previous to harvest. The weather can make or mar it.

163. The Factors of a Good Egg Yield are: *Good stock, comfortable quarters, proper food, sufficient exercise, reasonable cleanliness, favorable weather.*

164. Selecting Laying Stock.—The descriptions of fowls in Chapter V. indicated some varieties as good layers. It was also stated that hens of any variety might be made good layers. Selection of laying stock for immediate egg production must take account of stock more strictly than to accept general character or possible development. In selecting laying hens of unknown individual merit — as must nearly always be done — the only reliable guide is the laying capacity of the particular stock from which the hens come. Usually this mode of selection gives good average results. To select individual good layers by appearance — by points — is impossible. Prolificacy is entirely independent of physical structure, (barring some deformities), and also independent of temperament. If, as is nearly always the case, large eggs are desired, the hens selected should be: — if of a small breed, large of their kind; if of a medium sized breed, medium to large; for it is a physical impossibility for a small hen to be a very prolific layer of large eggs; and, besides, the tendency to lay eggs large out of proportion to her size is objectionable in a hen, because rendering her peculiarly subject to trouble in extruding her eggs. Moreover, hens small of their kind are usually runts, stunted, ill-developed. Medium to small hens of the large breeds lay eggs as large as need be; but hens that are much under size lack the staying qualities of better developed birds.

165. Exercise.*—What Kind? — Fowls at liberty take exercise principally by walking and by scratching. It may be observed that when they have a suitable place in which to scratch they pass much of the time there. This propensity to scratch, long reckoned the hen's peculiar vice, is turned to advantage by those keeping hens in confinement. Without the littered scratching-feeding floor, keeping hens healthy and productive in confinement is difficult. With this provision for exercise, hens are kept in perfect health, at the highest stage of productiveness, — not for a few weeks or months, but for two or three years, during which they may never once leave the house and small yard attached. Further, better results, in eggs, are obtained from hens in confinement than from hens at liberty. On most of the best poultry plants the littered scratching floors are considered indispensable.†

* NOTE.—House and yard accommodations and foods were considered at length in preceding chapters.

† NOTE.—For fowls on free range, or in good large yards — in addition to the regular

166. How Much Exercise?—Poultry keepers, being human, are prone to go to extremes. This is as true of plain poultrymen with their methods, ideas and theories, as it is of fanciers with their devotion to points of form and color, and perfection of development of non-essential features. Having tried for years to keep fowls in confinement without adequate provision for exercise, poultrymen are now, very generally, compelling too much exercise. To keep fowls scratching all day—scratching busily for *all* the grain they get, is carrying a good thing too far. As much exercise as will keep them in good condition is needed; more is superfluous, and, therefore, wasteful. Exercise has to be paid for if food is paid for. The amount of exercise needed will vary; it can easily be regulated by watching the condition of the hens. *At any age a fowl in good condition is plump.* A poor thin fowl has no reserve force. A fowl in good condition will be kept so if obliged to scratch about one-third of the day for one-third of its food. To bring a poor fowl up in condition, the proportion of food secured by exercise must be reduced. To reduce a fat fowl, compel more exercise—even going so far as for a while to oblige the fowl to exercise for all food, and to go hungry as long as it will not scratch.*

167. Exercise for Heavy Fowls.—What exercise suits a Leghorn does not suit a Brahma or Cochin. In the first place, the Asiatics do not need as much exercise as other varieties, and in just walking about they get much more of what exercise they need. Even in small, rather bare yards, they keep in pretty good condition without special exercise. As is well known, the Asiatics are both the hardiest of fowls and the best suited to close confinement. In the next place, scratching is harder work for them than for clean legged fowls. With their feathered feet and legs they do not work easily in heavy litter; so, while the rule of one-third of a day's work for one-third of a day's ration can be applied to Asiatics, it is necessary to so litter the floors that the rule will work right.

fowl-yard—the scratching floor is not absolutely necessary, and may even be superfluous if the hens have access constantly to a barnyard; but unless there is some other convenient sheltered place to which the hens can resort in all weathers, it is best to make regular provision for scratching exercise at the hen house.

* NOTE.—There need be no fear of injuring a fowl by this process. People are sometimes too tender hearted to compel a lazy fowl to work. If the hens miss one or two meals rather than work for their food, the owners take pity on them, and feed them as usual. This is a common case, and one in which pity needs to be diluted with common sense. The truest kindness to an animal is to keep it in such good condition that it will feel like working—taking exercise, and when it gets out of such condition to put it in condition again *at once*,—though stringent measures be required. The only case where an overfat fowl ought not to be compelled to exercise is when its feet are so sore (scaly leg) that it cannot use them. In this not uncommon case the foot disease must be treated first, and it will do no harm to diet to reduce fat at the same time.

168. What to Use for Scratching Litter.—Straw and cheap hay make the best scratching litter. Those who grow their own grain, and those who can get sheaf grain sometimes feed it unthreshed. Dry leaves, raked up in the fall and stored to be used as needed, make good litter, but break up quickly, and are not as easily handled as straw. On a large plant provision must be made for a regular supply of litter in quantity. Sometimes the rough manure, mostly soiled and broken straw from livery stables, can be had for the hauling. It usually contains more than enough grain to pay for hauling it. This can be used only in yards* or open sheds. Damp litter should never be allowed to remain in the poultry house,—much less be put there. A poultryman who can get the old bedding from a race track stable should consider himself in luck, for it is nearly all good clean straw, but little broken and soiled, and contains much good grain. In many places good straw is so cheap that it is the cheapest litter obtainable. When straw costs from five to eight dollars a ton it is time for those who use much to look for cheaper stuff. When only enough litter for a few pens is needed, baled straw, (even at the prices named) may be used. Shavings or other clean rubbish — almost anything that conceals the grain, and can be “*scratched,*” will do.

169. To Keep a Scratching Floor in Good Order—the litter must be often renewed, and yet be always in nearly the same condition. When litter is long and the floor thickly covered with it, it takes fowls too long to scratch out their grain — unless a considerable excess (over what is needed at the time) of grain is thrown into the litter. Fowls cannot be fed evenly in this way. If the litter is short it packs together, and the grain is not hidden when thrown on it. Then, unless the grain is raked or forked into the litter,—a tiresome and tedious process, and unnecessary when the floor is managed right—it is eaten rapidly, and the fowls take too little exercise. Beginning with a clean floor, as much litter should be put in as, when well scattered by the fowls, will cover the floor loosely to a depth of four or five inches. As soon as this is so broken that it packs, and does not conceal the grain scattered on it, a little more should be added, and more, and more at regular intervals,—the object being to keep four or five inches of litter of such length that grain thrown on it is nearly all hidden at once. After about a month from the time the first litter was put in, the coarser stuff on top should be raked to one side, and some of the finely broken, dusty stuff next the floor removed. Once the floor is filled up right—about an inch of fine— but not too finely broken—litter next the floor, and three or four inches of coarse, loose litter above it,—it can be kept right by adding long litter once a week and removing broken litter about once a month.†

* NOTE.—Where there is not too much wet and snowy weather the yard, or a part of it, can be used as the exercise-feeding ground.

† NOTE.—This will be about right when the floor space is five to six feet per hen. With

170. Cleanliness.— Everything about a poultry plant should be kept reasonably clean — so clean that there are no offensive sights or odors. As a rule the droppings should be removed daily. Where the quantity of droppings to be removed each day is small the common practice is to clean twice a week, or once a week, or once a month. This is not a good plan. It does no harm to let the droppings boards go uncleaned for a few days, *occasionally*, (at least it does no noticeable measurable harm) but it is not good for fowls to sleep nearly always with their heads only a few inches above an accumulation of their own excreta — and the lapse from daily cleaning ought not to be permitted to occur often. It should be the inviolable rule to take up the droppings daily, — *in winter*, when the hens are on the roosts for fourteen or fifteen hours of the twenty-four; *in damp weather*, and *whenever some of the droppings have the peculiarly offensive odor* that gives warning of something wrong in the digestive system. After being cleaned, the droppings boards should be sprinkled with land plaster, road dust, sifted coal ashes, or air-slaked lime to absorb the liquid manure. *

THE FLOOR of the roosting room, if not littered, should be raked or swept clean once a week or once a fortnight — the period between cleanings being regulated by the space per fowl and by the proportion of time the fowls spend in the roosting room. Small bare yards should be cared for in the same way. †

NESTS in which straw is used should be cleaned out, and new straw put in about once a month — oftener if the straw becomes damp or is fouled. In dry and sandy situations, bottomless nest boxes may be used on an earth floor without nesting material. These nests need no further care than they get when, in cleaning up the floor, they are set to one side, the floor beneath them raked smooth, the nest box replaced. The hens hollow the earth in the nest to suit themselves.

greater floor space the litter is not so soon broken; with less floor space it would be very difficult to keep a floor in good condition without doing too much work.

* NOTE.— If the droppings are saved to sell to tanneries, absorbents cannot be used on the boards. Near large tanneries there are generally men who make a business of collecting poultry manure. The price varies with the demand and supply, the average being about seventy-five cents per barrel. It is an open question with some poultrymen, who could use the manure on land, whether, all things considered, it does not pay better to use the manure than to sell it. When the hen manure is to be sold for tanning, the droppings boards cannot be kept in as nice condition; are more difficult to clean, and may be a menace to the health of the fowls. The droppings board saturated with urine is unsanitary, and though it may be used without bad consequences for a long time, it is unsafe, for unsanitary methods have a way of going back on a poultryman just as he begins to be sure that the opposition to them is all nonsense.

† NOTE.— These advices as to the frequency of the periodical cleanings are of course suggestive; still they indicate very nearly the limits of time between cleanings when the fowls' quarters are kept *reasonably clean*. A poultryman who works systematically, soon arranges a rotation of work which brings the regular cleanings near enough together to keep things looking respectable.

FEED TROUGHS should be *kept clean*. No sloppy food should be put in them, nor should water ever be given in the feed trough. If only dry and crumbly — non-sticky — foods are given in the troughs, it is little work to keep them clean.

DRINKING VESSELS should be rinsed as often as the water supply is renewed; and when rinsing with cold water fails to clean effectually, should be well scrubbed with scalding water.

Perfect dryness in a house is essential to the right kind of cleanliness. A damp house cannot be kept clean. Dirt that is harmless when dry becomes dangerously offensive when moist.

Whitewash sweetens and purifies a house, besides making the light inside much better on dark days. The usual practice is to whitewash once a year. Some whitewash twice, or even oftener, but there is certainly something wrong with the house or the poultryman if such frequent whitewashings are really necessary. Dry, well built houses, kept clean, ought not to need whitewashing oftener than once a year; and that is as often as most poultrymen can afford to do it. The most convenient time to whitewash is late in summer or early in the fall. Whitewash made after the common method: *i. e.* — lime slaked in boiling water, then thinned to the proper consistency for applying, is generally used, and is nearly always applied with a brush, though some use whitewash pumps. The disinfecting and purifying qualities of the wash are improved by adding a spoonful of crude carbolic acid, diluted in about a pint of water, to each pailful of wash. As an insecticide, whitewash has no permanent efficacy; it will kill what lice it reaches when first applied — that is all. *

* NOTE.—Those who wish to use a wash that will not rub off, will find the following recipes good. They have been long in use, and were published in the form in which they are given here in the *American Poultry Yard*:

(1). “Slake in boiling water one-half bushel of lime, keeping it just fairly covered with water during the process. Strain it to remove the sediment that will fall to the bottom, and add to it a peck of salt dissolved in warm water; three pounds of ground rice boiled in water to a thin paste; one-half pound powdered Spanish whiting, and a pound of clear glue dissolved in warm water. Mix the different ingredients thoroughly, and let the mixture stand for several days. When ready to use, apply it hot. If a less quantity is desired, use the same proportions.”

(2). “A good whitewash for use upon outside work may be prepared as follows: Slake in boiling water one-half bushel of lime, and strain as before. Add to this two pounds of sulphate of zinc and one pound of salt dissolved in water. If any color but white is desired, add about three pounds of the desired coloring matter, such as painters use in preparing their paints. Yellow ochre will make a beautiful cream color, and browns, reds, and various shades of green are equally easily obtained.”

[The coloring matter used for whitewash should be *dry*; colors mixed in oil cannot be used. The quantity of color needed would have to be ascertained by trial. The wash in the pail will have a much deeper, darker shade than when dry; so that to find out just what the color is it is necessary to allow a little of it to dry.]

(3). “Another excellent wash, lasting almost as well as ordinary paint, may be pre-

171. Fall Management of Laying Stock.—The established poultryman's year begins in the fall. The precise date is not a matter of consequence. Many like to place it at October 1st. It is really governed in individual cases by circumstances. It is not always possible to have everything in readiness for winter as early in the fall as one would wish. Every effort should, however, be made to have the laying stock in winter quarters—and not overcrowded—before the first cold rain storms or sharp cool nights come. The time for these varies with the latitude, and sometimes they are postponed until quite late; but it is the best policy to be prepared for them.

By early September pullets intended for early winter layers should be well grown, and beginning to show signs of approaching maturity. Unless there is room and to spare, all under-sized and poorly developed pullets should have been sold. [Late hatched pullets that will come to laying in mid-winter, it will pay to keep, if the stock of early birds is short, and there is abundance of room; otherwise, the sooner they are sold, after reaching a marketable age, the better. It never will pay to over-crowd stock that might lay early]. The hens reserved to keep through a second winter, should be about half through their moult; all others should have been disposed of. *

Both hens and pullets should be well fed. Whole corn may be used now at night quite as freely as in the coldest winter weather. It is a mistake to feed moulting hens short, and a mistake to feed them a too highly nitrogenous ration. Hens moult better on a carbonaceous ration, quite a fattening one, than on a narrower one, and will lay better afterwards. Moulting hens need nitrogenous matter for feathers; they also need additional heat producing food to keep them warm while growing new feathers. It is better that they should be fat than poor, and safer to keep them a trifle over-fat, rather than barely in good condition. If the weather continues fine, most good layers (non-sitters sometimes excepted) will, if well fed with an ordinary fattening ration, lay every third or fourth day while moulting. The pullets can stand high feeding, because only the most advanced are full-feathered. Few are full grown. In

pared for outside work as follows: Slake in boiling water one-half bushel of lime. Strain so as to remove all sediment. Add two pounds of sulphate of zinc and one pound of common salt, and one-half pound of whiting thoroughly dissolved. Mix to a proper consistency with skimmed milk, and apply hot. If white is not desired add enough coloring matter to produce the desired shade."

* NOTE.—Right here comes up a point in management which is of particular interest to farmers and to others who keep fair sized single flocks of poultry. It is a common practice with such, when selling poultry, or killing it for the table, to select the best and most salable birds, considering only the question of their immediate use, and not regarding at all the effect of this practice on the flock. The result is that nearly always the flock that is to furnish winter eggs—if winter eggs are obtained—is made up of the "rag, tag and bob-tail" of several seasons. To reverse this method of selection, and keep only the best for layers, would do as much as any other one thing to improve the general average of egg production. This is one of the ways in which those who have little time to give their fowls can secure an increase of profit without extra labor.

the earliest period of laying, a pullet is usually making growth of bone, muscle and feathers, and producing eggs at the same time. The eggs are of necessity small, and it is a good plan to postpone laying until the bird is well developed. This can be done by shifting the pullets frequently from pen to pen.

As the mean temperature of the atmosphere falls lower and lower, more and more of the food consumed goes to keep up the heat of the body. The mash should be a rich one, heavy in corn meal and meat—and fed warm. Corn can be fed quite freely, and provision made for a constant and liberal supply of cut bone or meat scraps. For feeding at this time no better vegetable than cabbage can be found, and split and damaged cabbage can be had at this season for the hauling, or for a merely nominal price. Sound cabbages are often very cheap, and if one who cannot grow them himself is prepared to buy what he needs for the winter now, cabbages may be about as cheap a green food as can be had; bought later, they will probably cost several times the fall price. It would, of course, be possible to keep the fowls comfortable in cool weather by giving less heating food, and closing the houses up more at night; but that system tends to keep fowls soft; while, as long as the weather is not too cold, heating food and a cool house harden, while keeping them comfortable.

Now as long as the weather continues fine and quite uniform, though slowly growing colder, both hens and pullets will do so well that the poultryman will begin to make estimates of what the egg yield will be by Thanksgiving Day, *at the present rate of increase.*

Then possibly there comes a sudden fall in the temperature—a fall of 50° to 60° Fahrenheit in a few hours, is not unusual at this season—and a change of 80° may occur inside of twenty-four hours. The demand of the body for heat is enormously increased. If the poultryman can now keep his fowls warm enough so that there is no sudden check to egg production, all is well. If the cold snap is of short duration, everything goes on as before. If the weather remains permanently cooler, one has only to take better care of the hens for a few days until they become accustomed to the change:—as healthy hens do very quickly; but if the poultryman fails to make such provision as is in his power to counteract the effect of the change in the weather; or, if the fall in temperature is so great as to check laying in spite of all that he can do, the effects of the change do not pass away with the return to settled warmer weather, and if changes follow each other rapidly, numerous slight shocks have sometimes a worse effect than one extreme shock. In many cases the shock to the system of the hen does not end with the stoppage of egg production. Consider what laying is—what an egg is. Consider how any shock to an animal organism acts upon the reproductive system, and this effect in turn reacts upon the whole system. Similar instances are numerous in other lines of animal life. When a change of weather causes a hen to stop laying, there will be no more eggs laid until the system has had time to recuperate. The time needed is long or short, as the shock to the system was more or less

severe, and varies in individual cases — some hens being much more susceptible to change than others, and some of those easily affected recuperating quickly, while others recover tone and vigor but slowly.

The foregoing statements give the problem of fall and early winter egg production quite fully, showing how important is skillful management, yet how impotent against extremely unfavorable changeable weather at this season. Occasionally it happens that the weather is continuously mild, or uniformly cool, then cold. In either case it is comparatively easy to get and keep hens laying. There is a great deal of chance in this matter of fall and early winter egg production; — there are many *ifs*; yet the man who intelligently does what man can do toward getting the early eggs, has by far the *best chance*. More than that, when good management misses the best, it catches the next best. Though it may fail to get eggs in November and December, it makes January eggs practically a certainty; while poor management in the fall is apt to result in no eggs before March.

172. Anticipating Weather Changes. — Some Little Things that Count. — Poultry keeping is essentially an occupation made up of trivialities. In poultry keeping it is the little things that count. In working for early winter eggs, some little things may have big results, determining whether it is to be *eggs*, or *no eggs*. The wide-awake poultryman is weather-wise. He anticipates the weather changes. He sees, or feels them coming, and takes measures against them. A keen, cutting, chilling wind, springing up on a warm day in the fall, will chill the hens through and through before they take shelter, * and will, of course, make an open house as cold as out-doors. Such cold storms, as also cold rain storms, an observant person can anticipate early enough to get the fowls into the house, and close doors and windows. This is a little trouble at first, but *it pays*. The house closed up with the fowls in it, is full of warm air *which cools gradually*. The fowls hardly feel the change. But there must be no coddling — no shutting up fowls for slight changes, no keeping them in the house when robust well fed fowls should be comfortable out-doors. Once a severe change has occurred, and what could be done to mitigate its effects has been done; things should proceed in the regular routine. On sharp frosty mornings, fowls may be kept in until they have had a meal, but should never be confined late when the cold is not severe enough to nip their combs. They should have the opportunity to go out-doors. Those that will not use it are good to kill. They are the ones easily affected by cold, and most subject to diseases emanating from colds. If the day is only raw and bleak, the open scratching shed, or the house with windows open, gives as much shelter as healthy fowls need. If it is stormy, without being very cold,

* NOTE.— Contrary to a common belief, hens, like other animals, most children, and some people, have not the instinct of doing what is best to do in any given circumstances. They learn by experience. After they have found out which is the most comfortable place to go to when a cold storm comes up, they will go there every time. It is easier to teach them what to do than to leave them to learn it for themselves — easier, and it comes cheaper.

it is best to leave the small doors to the yards open, letting the hens run out as they choose — which will be in every lull of the storm. There is nothing more objectionable in the management of poultry than shutting them into close houses when it is not extremely cold; it makes and keeps them soft, and after a time they become more susceptible to moderate changes than rugged fowls are to severe changes. There is a vast difference between coddling fowls and taking such ordinary precautions to keep them healthy and comfortable as sensible persons learn to take for their own personal welfare.

173. Late Culling of the Laying Stock. — It is a good plan, as intimated in the preceding paragraph, to watch the flocks closely during the fall, and cull out all birds easily affected by inclement weather. These should be put in condition to market for poultry. It is not worth while to nurse them along in the hope that they will eventually become profitable layers. The chances are against that; their presence in the flock is a standing invitation to diseases which, once having gained a foothold in a flock, are apt to become epidemic. Their room is worth more than the prospect of profit from them.

174. Distempers and Colds, Epidemic.—Changeable weather and continuous damp weather often make colds epidemic in the early fall. A common cause of colds and distempers is closing the houses too tight at night. Fowls that have been roosting in open sheds, or in the open air, are almost sure to take cold when moved into a warm, close house. When colds become thus epidemic, simple remedies should be used *at once*. A good condition powder, fed regularly in the daily mash, is often effective. Common hard soap, dissolved in water to the consistency of soft soap, a tablespoonful to a gallon of water, will clear the nostrils and throat, and also act as a mild purgative. Indeed, this hard soap remedy alone is one of the very best that can be used in mild forms of distemper. Colds may be partially prevented,—the system fortified against them,—by feeding onions liberally; also by feeding in the mash red peppers, dried, chopped fine. If these can be obtained they are to be preferred to ground red pepper (*capsicum*). It is of first importance to learn to what cause the colds are due, and, if possible, to remove the cause. (Often colds are due to preventable causes). Treatment cannot be thoroughly effective while the cause remains.

175. What to Do When it Snows.—No matter how good the in-door accommodations for the hens, it is best to get them out doors for at least a little while on every day when that is not utterly impossible. Except in extreme northern sections it is not very difficult when snow comes, to keep it cleared away from a strip six to eight or ten feet wide along the south side of each house. Where snow does not lie long there is a temptation to wait for the sun to take it off. Don't indulge the temptation. The less fowls are necessarily kept confined in winter the more urgent it is that they shall not be shut in longer than is needful. They feel and are affected more by restraint when it is of rare, than when it is of common occurrence. There is no need

of being over-careful to prevent laying hens walking on and eating snow. It is often said that either of these things will stop laying. To remain long standing on snow, or on wet frozen ground either, undoubtedly has that effect; so, apparently, has eating snow *under some circumstances*. Healthy fowls that have dry comfortable quarters to which they go at will, are not injured in the least by being on snow for a little while occasionally. Fowls that can have water to drink when they want it will not hurt themselves eating snow. Indeed, fowls provided with water do not voluntarily eat much snow except when it is thawing, wet; — then they seem to prefer it to water.

176. As the Days Grow Short — the old hens are getting well through their moult; the early pullets are completely feathered, full grown. The food eaten now goes to maintenance, warmth, and eggs; and, with the full coat of feathers on, the heat of the body is better retained. A given quantity of fuel food will go further in a given atmospheric temperature now than it did earlier; and if the weather is fine and warm in November, the food needs close watching; for it is very likely to prove that the hens need less food and less heating food now than they did early in the fall. Now, too, the days are growing so short that it begins to be difficult to get in three meals a day, even if the noon meal is a light one, with intervals between meals long enough to keep the fowls in good appetite. It would seem that fowls need to be up and about for a while before they are ready to eat a breakfast. If at all well fed at night they rarely eat a hearty meal until some little time after sunrise. If the hens will not eat heartily soon after sunrise, the evening feed should be reduced, little by little, until they do. A good way to feed in the short days is — when the mash is fed in the morning — to give all they will eat clean of a clover or vegetable mash, and scatter millet, or other small grain or broken grain, where they can get it by scratching at any time through the day; then about three o'clock in the afternoon give a feed of wheat, oats, barley, cracked corn,— any one, or a mixture — in litter, feeding a little light; at dusk give whole corn to hens that will leave the roost to get it. As to the quantity of corn to be given, learn to judge that by comparing the appearance of the crop at night and the appetite for mash next morning. When the mash is fed in the evening and vegetables at noon, it is easier to regulate three meals a day. Whether two or three meals are given, the feeder should learn to so regulate the quantity given at each meal that the hens will be ready and waiting for the next. If this is not done, hens soon go “off their feed,” though not over-fed. The trouble usually has its origin in allowing the fowls to get too hungry before the evening meal, making them so greedy that when given an opportunity to eat rapidly and heartily they swallow more than they can comfortably digest. By being observant and careful, one soon acquires a knack of feeding about right for quantity, and finds it a much simpler matter than the amount of explanation necessary to make the need of cautious feeding clear would indicate.

177. Importance of Closely Observing the Physical Condition of Hens.—In feeding for eggs it may be noticed, that, as in some breeds the tendency is to convert surplus food into eggs, and in some to convert a surplus into fat, and as similar differing tendencies are observed in different hens of the same breed, so *the same hen* will show at one time a tendency to fatten, and at another a tendency to turn all surplus into eggs—and this altogether apart from the influence of external conditions. When one function gets, as it were, the upper hand of the others, it seems to have power to appropriate a lion's share of the surplus food taken into the system. This matter requires watching, and sometimes makes it necessary to reassign a stock, putting hens of similar tendencies together, that they may be given required special treatment. One of the secrets, perhaps *the secret*, of getting big egg yields from fowls of the large breeds, is to get the hens in such condition, and *laying*, that they acquire a certain *momentum of egg production*—then feed heavily. For this one needs to be much among his fowls, watching them closely, and handling them often. The feathers make it difficult to accurately judge a hen's condition by observation. In the case of large fowls the difficulty is increased by the length and looseness of the plumage. Very docile hens can be picked up at any time; others, not so easily approached, but still not wild, may be caught at the feed trough, by lifting with the hand under the breast, without being at all alarmed. A close examination is not needed; all that is necessary is to get hold of the fowl in such a way that the weight rests easily on the hand, and the fingers learn by touch the condition of the flesh. Hens that would be too much disturbed by being caught by daylight, should be handled on the roosts at night. Beginners generally need to watch their hens' condition more closely than old breeders, because the old breeder's stock as a whole has become habituated to his system of handling, and by the inevitable process of natural selection fowls which do not do well under his system have been largely weeded out.

178. Gentleness in Handling Laying Hens Important.—Careless and rough handling of laying hens cause many bad breaks in egg yields. Occasions are constantly arising in the poultry yard when one needs to exercise all his powers of self-restraint to keep from doing things of which he will afterwards be ashamed. Hens can be very aggravating, and cannot be coerced with gentle force or mildly corrected as most domestic animals are. A threatening movement, though carried no further, will often put every hen in a pen in a bad state of fright; in a long continuous house the panic runs like wildfire from pen to pen. A disturbance of any kind measurably affects the egg yield. The poultry keeper who is most a novice knows that a dog or other unfamiliar animal, or a bevy of visitors is very objectionable near the quarters of laying hens. Not all poultry keepers know that they themselves often unknowingly cause bad disturbances. They see the disturbance, but are unable to account for it. To abruptly enter a pen, to run past it, to go

into it wearing clothes different from those usually worn, or carrying an unfamiliar object, will often send panic through a whole flock. *Changing the quarters of laying hens* is a thing to be avoided, if possible, unless it can be done without making a disturbance. The best way to move hens short distances is by driving. If this is done carefully, egg production may not be affected at all. If the hens must be carried, they should be very carefully handled, moved only at night; not caught or carried by the feet. Moving short distances, they can be carried in the hands, one at a time; or under the arms, two at a time. When this mode of handling is too tedious, the transfer should be made in coops. With gentle handling the bad effects of moving are diminished. During the natural laying season laying hens are less influenced by disturbances than at other times.

179. In Coldest Weather.—Extreme cold weather is no bar to good egg production if the hens come to it without having been suddenly checked. The weather condition favorable to winter laying is *uniformity*. It is often said that winter eggs depend on the poultryman's submitting his hens to counterfeit spring conditions. This is but partly true. Hens that are comfortably housed can be made to lay well in almost any kind of weather or climate, provided fluctuations in temperature and humidity are not too great or too numerous. In extreme cold weather a very carbonaceous ration may be the best laying ration. The most highly carbonaceous ration that a fowl can digest will fail to keep up the heat of the body and leave sufficient surplus for a goodly number of eggs. A warm house helps, but in addition, (to prevent unnecessary expenditure of food) the hens must be prevented from chilling themselves with icy water and ice cold grain. Warm water should be given. It ought not to be always warm. The hens want some cold water. The point is, to make sure that they cannot, when very thirsty, drink freely of water so cold that it chills them to the marrow. If the water is warm when put into the drinking pans that is all that is necessary. For fowls with crests and beards, and for males with long wattles, drinking fountains which prevent the head furnishings from getting wet, should be used. In cold weather wet damp crests are almost certain to cause roup. In a fairly comfortable house the wattles of hens and of short wattled males are rarely frost bitten; but the long wattles of Leghorn and Minorca males may be nipped while wet, when, in the same degree of cold, they would not be injured if dry. When there is danger of water freezing in the pans at night, the pans should be emptied every evening; otherwise valuable time may have to be given to removing the ice from them in the morning. It is of little use to warm small grain that is to be fed in litter; it remains warm only a few minutes, and the hens cannot eat it fast enough to be chilled by it, anyway. Grain that can be eaten quickly, it is an advantage to warm.

180. Ventilating in Cold Weather.—When it is so cold that the poultry house has to be closed during all but six or seven of the twenty-four

hours, ventilation requires close attention. Moisture rapidly collects on walls and ceilings. Damp walls are good conductors of heat, and too quickly equalize inside and outside temperatures. To keep the walls dry there must be good circulation of air through the house for some hours daily. This applies to clear cold as well as to wet cold weather. A house facing south is likely to become much too warm through the middle of the day if closed tight on a clear day, no matter how cold. Whenever the weather permits—that is, whenever a storm would not sweep in at open doors and windows—the poultry house should be well opened up, especially through the middle of the day. The windows of a house fronting south should be open as much and as long as the house can be kept comfortable with them open. They should be both opened and closed gradually; not opened wide all at once after the house has become over-warm, and closed tight all at once when it has turned cold after sundown. A house with two rows of pens, facing east and west, and with large doors at the north and south ends of the passage, and small doors in the east and west sides, is nicely aired by leaving the two large doors open; or by opening all the small doors, or one large door and the small doors on one side. The direction and force of the wind have to be considered.

A good general rule for cold weather ventilation, is to open the house as much as can be done, and still leave it at a comfortable temperature for the person doing the work in it.

181. In Warm Winter Weather, great caution needs to be observed in feeding. If corn has been fed generously the quantity given should be much reduced. Most cases of liver disease date from a warm spell in winter. Heavy feeding and highly carbonaceous rations are continued when, for the time, the hens need a narrower ration and much less food. In warm winter weather mashers should have the proportions of hay or vegetables and of bran somewhat increased; oats should be substituted for a part of the corn fed. It is the more needful to watch this point, because the bad effects of injudicious feeding at such seasons are rarely discerned, either in the condition of the fowl or in the egg yield, until disease is in an advanced stage. Most cases of liver disease do not develop outward symptoms for some weeks, or even months.

182. Care of Laying Stock in the Spring.—In the spring hens need and will stand very heavy feeding; though it takes less of the food to keep them warm, it takes considerably more for egg material. If fed no more than they were in the winter, most hens quickly “*lay themselves poor.*” The novice is not apt to discover this state of affairs until his hens begin to stop laying, exhausted, and not likely to again be reliably profitable layers. Many hens which should have been good layers for several years, are spoiled in this way; and it is the best hens that are most likely to suffer. Whoever will keep

such hens over and watch their later performance, will find that hens which have once gone badly out of condition are usually uncertain layers afterwards. The principal cause of all this trouble is, that, having worried over feeding problems all winter, the poultry keeper thinks when spring comes and the hens are laying well, that he has the feeding "down fine," when, in fact, the hens are laying well in spite of poor management. In the spring every hen that can lay will lay; fat hens lay themselves into good condition; sick hens lay themselves to death. The fact that a hen is laying, is not by any means a reliable indication that she is in perfect health and condition. A heavy egg yield in the spring is not particularly desirable. If the hens have laid well through the winter, they should be given a rest in anticipation of making them do as well as possible through the summer, summer eggs being more profitable than spring eggs. If the egg farmer rears his own laying stock, (as nearly all do), it will pay him to set as many of his hens as go broody in March and April, thus giving each a rest of about a month (if they only hatch the chicks) when eggs are cheapest. With the non-sitting breeds this course is out of the question. There will also be in nearly every large stock of laying hens of the sitting varieties some heavy layers that will not go broody until quite worn out with egg production. *

Such hens can sometimes be induced to sit by shutting them on a dark nest full of eggs. Hens that persist in laying heavily should be given the very best of care, and every effort made to keep them in tip-top condition; they will rest later while moulting. Too often it happens at this season that the poultryman's time and thought are so fully occupied with the care of the young stock and plans for the coming year, that his laying hens are more or less neglected.

183. Summer Management of Laying Stock.—With the first hot days of summer hens that have gone out of condition, and hens not bred for continuous laying, are apt to quit. Nearly all the hens will show a disposition to stop laying, but judicious care and feeding will keep those that are in condition, and have the staying qualities, laying fairly well all through the

* NOTE.—Some say that, *if fed properly*, a hen is not exhausted by long continued heavy laying. As well say that a man, *if fed properly*, cannot be overworked. Good feeding is a factor of good laying, but good laying is a drain on the vigor of the best nourished hens; they show it in the quality of the eggs, they show it in their late hatched chicks, and, nearly always, show it in their appearance. *Food*, though of the best, and abundant, *is not rest*—and cannot be a substitute for rest. Every animal, every part of an animal, every animal function, requires periods of complete or partial rest. Is it not absurd to suppose that the most delicate of all animal functions can be kept constantly working at high pressure? Is it not more than absurd, in the face of the fact, patent everywhere in nature, that an overworked reproductive system leads quickly to decay and degeneration, to assume that perpetual motion is successfully demonstrated in the hen bred for eggs and properly fed? Why, even machines of wood and iron need rest, and wear out with less actual work if they do not get it. Every analogy confirms the experience of the mass of practical poultrymen.

heated term; extra good laying except in a few rare individual cases is not to be expected. The hens need to be kept cool. The houses should be opened wide enough to be comfortably cool at night. There should be cool, shady loafing places in which they would pass the hottest hours of the day. Their exercise should be early in the morning and late in the evening. It is a good plan to feed grain mornings and evenings, and the mash at noon. Once a day—about the middle of the afternoon is the best time,—they should have all the green grass or vegetable tops they will eat. On excessively hot days, green stuff may be fed to advantage, twice—just after the morning feed, and just before the evening feed. They should have all the cold water they want, and may also be given all the milk they will drink. Milk is good at all times, but is most appreciated in warm weather. It does not wholly take the place of water. Fowls would not suffer much from thirst if given milk and no water; but they want water, and it should always be accessible, whether they have milk or not. If one has plenty of milk, and can give it constantly, the best way is to have two drinking pans in each pen, one for water, one for milk—and let the fowls drink as they please.

When the weather is extremely warm, the mash for fowls in confinement should contain but little corn meal, and no whole corn should be given. For ordinary summer weather, the mash need not be much varied from that used in winter, and the whole grain ration need differ only in the amount of corn fed. If given the opportunity to eat vegetables freely, the hens will balance the ration *for comfort*, not *for eggs*. Indeed, unless fed vegetables, as suggested, when they are not very hungry, the hens will eat a much larger proportion of bulky food than is consistent with good laying.*

184. When Hens Stop Laying Too Early in Summer.—There are always some hens, sometimes a large proportion of a flock, that cannot be kept laying through the summer when handled in the usual way; these it is not profitable to keep in idleness. (Too many poultry keepers do keep them along until fall). They should be culled out of the general flock, separated and fed differently;—the object being to put them in market condition. They should be fed a heavy laying ration, with little exercise. On this treatment many of them will begin laying again. Those which do not should be marketed as soon as fit, and those which lay for only a few weeks should also go to market, as they stop laying again. Those which show a disposition to keep right on laying should be given exercise to keep them in condition. An egg farmer should never sell a laying hen unless he has more eggs than he needs, or has another to take her place; as long as the hen

* NOTE.—Those whose hens are kept on a good grass range, would do well to watch this point. If the hens will not stop to eat grain in the morning, but go foraging, they may be let alone as long as they lay well. If they are not laying as well as they ought to be, it is worth while to try the experiment of keeping them in the yard attached to the poultry house until they have eaten a light feed of grain, which will often give them just the solid food they need to bring the egg yield where it should be.

lays, it pays to keep her. The first choice of hens to be kept over should be from those which began laying earliest, and were kept in laying condition with the least trouble, and for the longest time. If there are not as many of these as are needed, some of the hens that under special treatment laid through the summer should be reserved. *

185. Old Hens as Layers.—In connection with the question of how many and which old hens to keep over for laying, comes up the moot question, whether hens or pullets are better for egg production. Some authorities advise selling off all old hens, claiming that pullets are better layers, and therefore more profitable. Others say they get as good results in number of eggs from hens as from pullets, and the eggs of the hens are more uniformly of good size. There is much reason to think that these diverse results are not due entirely or primarily to age, but are according to treatment and selection for long lived layers. In truth, there is not much reason for thinking anything else. The fact that many poultry keepers do regularly get as good egg yields from hens in the second, third, and sometimes fourth years, as in the first, and as good as from good laying pullets kept beside them, is proof positive that old hens are not necessarily poorer layers than pullets, and that their capacity for producing eggs need not be impaired by the work of their first season. It is a general truth that old hens have a greater tendency to fatten. (A poultryman who understands his business can easily regulate that). In most cases where those who get good results from pullets do not get good results from hens, the trouble seem to be in such things as: breeding largely from immature stock, starting pullets to laying too early, allowing them to lay themselves out of condition, and not feeding heavily enough while moulting. Many poultry keepers are very careless about the old hens while moulting, though careful enough at other times; and some are too careful to feed nothing over and above what is needed to grow feathers. A better way than to make a low age limit when selecting laying stock, is, to make it a rule to keep through the moult all hens that began laying early, and after laying for eight or nine months are still in good condition, and to keep in addition to these, as many of the next best (according to the same standard of value) hens as are needed to keep the plant stocked to its full capacity with productive hens. A hen which lays an egg a week while moulting pays for her food, and most people find it easier to care for, say, a hundred moulting hens than to rear a hundred good pullets. A good layer that continues in good condition, is worth taking chances on until she is three or four years old. Time enough to dispose of her when she is known to be unprofitable.

* NOTE.—Many amateur poultry keepers whose hens stop laying in early summer, sell them off for whatever they will bring. This is poor policy. Four times out of five the hens are in poor condition, and the price obtained is the lowest going. Were the hens put in market condition before being offered for sale, those sold would bring a much better price; while those which resumed laying would give a profit in eggs while being kept in condition to market when they ceased laying.

186. About Broody Hens.—When hens are kept principally for egg production, frequent and persistent broodiness is a bad fault, and should be culled and bred out of the stock. Broodiness at long intervals and easily broken up, is rather an advantage than otherwise, for it gives the hens occasional short complete rests from laying. It is noticeable that hens of the non-sitting varieties lay less while moulting than hens of sitting varieties; the latter if well fed, are apt to lay (a from 20% to 40% yield) right through the moult. The non-sitters take one long rest; the sitters several short rests. If it is desired to keep the hens laying as steadily as possible, using none for incubation, they can be most easily broken of broodiness and most quickly brought to laying again by confining them with a reserve male in a pen from which the nests have been removed. On a large plant, one, two, or more pens are, during the spring and summer, needed for hens undergoing the process of breaking up. The broody hens should be well fed. To break up broodiness promptly, and bring them to laying without delay, two objects must be attained, viz.: the hens must forget about incubating; they must be kept in good condition. Confinement in coops, as described in ¶57, is, on the whole, slower and less effective than penning with other broody hens and a male. In the pens the hens can be got to laying again in four or five days, sometimes, and it rarely takes longer than ten days, unless they are badly out of condition. This method is not always practicable in small yards. Starving to break up broodiness, is a cruel remedy—not more effective than simple removal from nests, and certain to postpone much longer the resumption of laying.

187. The Cause of Broodiness.—Sick Hens Going Broody.—The condition of the hen is sometimes supposed to determine the time of broodiness—even to cause broodiness,—some asserting that whether hens are sitters or non-sitters, is merely a question of diet. Many think a fat hen goes broody. It is quite a common practice to feed grain heavily to induce broodiness. This method fails as often as it succeeds. There is nothing in the “fat hen theory” of broodiness further than that, if a hen has the sitting instinct well developed, she will, in the breeding season, go broody when she stops laying, whether she stops because:—*too fat, too poor, or sick*. Complaints of sitting hens dying on their nests are numerous every season. Sometimes a poultry keeper reports his sitting hens as nearly all dying mysteriously during the period of incubation. Such hens are mostly sick when set; though broody, their actions are so different from those of healthy broody hens, that after two or three experiences with them a poultry keeper who is as observant as he ought to be, will not make the error of setting them when they ought to go to the hospital. Broodiness is hereditary and constitutional. If a hen comes of non-sitting stock, heavy feeding will force egg production or will fatten—it will not cause broodiness.

188. About Eggs.—VERY SMALL EGGS are often laid regularly by hens so fat internally that there is not room in the egg passage for a normal sized egg to form. The remedies are: *reduced food*, and *exercise*.

SOFT SHELLED AND THIN SHELLED EGGS are due, sometimes, to a lack of lime in the food, sometimes to the hens being over-fat, but, perhaps, most often to inability to retain the egg until fully developed, its extrusion being premature, and due to the same causes as the dropping, at one time, of several eggs in different stages of development.

WHEN SEVERAL EGGS ARE DROPPED AT THE SAME TIME, it is because the hen is temporarily weak and unable to retain the weight of eggs she is carrying. The best treatment for such cases is to put the hen *alone* in a warm roomy coop, where she can take a little gentle exercise, and feed light—to retard egg production,—especially avoiding stimulants which act on the ovaries. A hen in general good condition recovers quickly from such a mishap (miscarriage). With the regular ration, she may lay a perfect egg the second day after dropping three or four partially formed ones. It is better that she should not lay so soon again. By postponing laying the risk of a second attack is diminished. A second attack is apt to have more serious consequences than the first. The hen should be kept away from the male for several weeks, as the attentions and weight of the male retard her complete recovery, even when not the direct cause of a second accident. The first causes of the weakness which leads to the dropping of several eggs at once, are obscure; (they might not be, if hens could talk). The accident happens to hens of all ages, and in all conditions. It is often preceded by bowel troubles, which cause extreme weakness; and there is little doubt that in some cases it results from abuse by the male or by other hens. Frights and injuries of which the keeper knows nothing, are other possible causes.

DOUBLE EGGS are generally attributed to over-fat hens. Clearly a mistake. Fat hens sometimes lay double eggs; so do hens in good condition, and hens in rather poor condition. A double egg is a twin egg. The tendency to produce twins, as observed in human beings and in farm stock other than fowls, seems to be hereditary. It is not known that twins are more often produced by fat than by lean mothers.

MISSHAPEN EGGS.—Some hens never lay an egg with a good shell. Such hens should be killed; their eggs spoil the appearance of a lot, and are, besides, most apt to be broken. When hens which have been laying perfectly formed eggs lay eggs with badly formed shells, the cause may be: for a single egg, a slight accident or fright; for a number of badly formed eggs laid consecutively, the commonest cause is rheumatism.

189. Egg Eating.—Its Cause, Prevention and Cure.—A soft or thin shelled egg broken in the nest, is the usual cause of egg eating. From eating broken eggs hens soon learn to break eggs. The vice is communicated to all

the hens in a flock in short order. Dark nests, as shown in Figs. 13, 16, 35, and 36, are the best preventive of egg eating. Once the vice becomes fixed in a flock, such dark nests in an ordinary well lighted pen do not stop it, for enough light finds its way into the nests to enable the hens to see to eat the eggs, if they are very eager to do so. To effect a cure, the pen itself must be so dark that the hens can just see to make their way to the nests. Then the nests are so dark that the hens cannot possibly see well enough to break and eat the eggs. The point is to prevent the hens breaking eggs until they have had time to forget about it. Fowls have short memories. From one to two weeks of complete prevention usually effects a lasting cure. Some poultrymen report having cured egg eating by giving the hens china nest eggs to pick at until they gave up in disgust. This may work sometimes;—it has been tried and failed. The pitch dark nest is a sure cure.

190. Condition and Food, and the Quality of Eggs.—Hens that are fat without being over-fat lay the best eggs. Generally the eggs of corn fed hens are richer than those of hens fed principally on other grains.

THIN, WATERY EGGS come from using too much sloppy food, or vegetable food, and from hens in poor condition generally, no matter what the kind or quality of the food.

PALE YOLKS result from lack of green food, and of *fat*, oil. It is rarely possible to have anything like as good color in the yolks of winter eggs as in eggs laid in May and June; but by using hay cured green, and by feeding corn quite freely, much better color is obtained than when root vegetables only are fed, and corn almost excluded from the ration.

191. Nest Eggs.—The use of nest eggs for laying hens is unnecessary. One may as well save the few dollars—or few cents—they would cost. Hens in confinement have no opportunity to hide their nests. Most of them go to the nests provided for them, and when hens show partiality for a particular nest, the use of nest eggs in all the nests will rarely prevent their crowding to the nest they favor. Hens which have opportunity and the disposition to hide their nests, will do so though the nests provided for them be filled with nest eggs.

192. Practical Every Day Use of an Egg Record.—In every pen of laying hens there should be tacked up a sheet, ruled one way for the months, and the other for the days of the month, on which to record the number of eggs laid each day. A record of diet and weather is valuable, but that can be kept on one sheet for many pens. The egg record sheet in each pen furnishes a good guide in feeding; is almost indispensable when one person does the feeding and another collects the eggs, and is most useful always, for memories are treacherous. The egg record shows the exact nature and extent of fluctuations in the egg yield, and shows at once when something is

going wrong. In using the egg record as an index of the condition of the flock, the feeder should keep in mind that a falling off in the egg yield for one or two days may be due to the mere coincidence of the "off days" of an unusually large number of hens; but, after a shortage which cannot be accounted for by change of weather or a serious disturbance in the flock, on two successive days, he should begin to handle the hens to exactly ascertain their conditions. Nine times out of ten he will find that he has been feeding too light.



CHAPTER X.

Principles of Breeding,— Selection and Care of Breeding Stock.

193. The Law of Inheritance.—The principles of breeding being based on one universal law, the law of inheritance, the transmission of qualities in generation, a correct appreciation of this law is essential to a right understanding of the principles of poultry breeding. In its operation the law of inheritance shows, always, two phases which appear to result from conflicting laws. Thus while fowls of the same pure breed produce offspring unmistakably like themselves, the offspring are never exactly like either parent, or like each other, so that it is commonly said that there are two laws: (1) *The law of heredity*; of family, or race, likeness; and (2) *The law of variation*, of individual diversity, and it is considered that “heredity” and “variation” are visible effects of opposing forces, the first working to preserve a race as it has existed, the second to produce change; and that these forces, especially that which controls variation, work in some mysterious capricious way which the breeder cannot fathom.

There are not two laws. There is but one:—the law of inheritance. “Heredity” is the inheritance of *like* qualities; “variation” the inheritance of *unlike* qualities,* and it is as strictly in accordance with the law of inheritance that the unlike characteristics, the individual differences, should pass from generation to generation with changing kaleidoscopic effects as that the like qualities should be transmitted practically unchanged.

194. One Law Explains All the Phenomena of Reproduction.—Congenital, or inherited, variations may be divided into three classes: (1) Slight variations, differences in degree of like qualities; (2) Considerable variations—either extraordinary development or degeneracy of a race quality, or, a new quality which is at once recognized as resulting from a union of ancestral qualities; (3) Variations, which constitute new qualities not traceable to known ancestors, or to supposedly possible combinations. It was only necessary to make such a classification of congenital variations to show

*NOTE.—In this generalization acquired variations must be excepted. Acquired variations which are directly due to external causes are the initial variations, the beginnings of differences between individuals, and are inheritable.

that all variations except the small number coming in class 3, are due to inheritance; for it is a matter of common information that offspring do not inherit equally from both parents; that offspring of the same parents do not inherit alike; and that inheritance is not the transmittance of qualities from one generation to the next in a lump, — but goes back, “takes back” through several of the nearest generations, and in less degree to more remote generations. Now if the law of inheritance accounts for likenesses, slight differences, and a part of the greater differences, including some unusual, new, qualities, it is to be expected that it can account for so-called “spontaneous” variations, which are simply variations of which the causes are not immediately apparent. Further, the law of inheritance requires that such phenomena of heredity as these spontaneous variations shall occur from time to time, just as imperatively as it requires that they shall take place only at long intervals. There is no place in this work for an extended demonstration of this proposition. It can, perhaps, be made sufficiently clear in a few words.

Some observed facts of heredity, observations of the number of generations required to establish, “breed in,” a desirable trait, or to “breed out” an undesirable one, give the general rule:—*A descendant inherits one-fourth of the total of his qualities from each parent, one-sixteenth from each grandparent, one-sixty-fourth from each great-grandparent, one-two hundred and fifty-sixth from each great-great-grandparent.* To put it another way: an individual, a fowl, may inherit an appreciable fraction of its qualities from each and every one of thirty ancestors, representing possibly the extremes of divergence from the breed type in a dozen different respects. The number of inheritable qualities is very great. The number of possible variations due to inheritance is enormous, practically infinite. The mathematical rule based on a few facts of inheritance teaches that slight variations should be very numerous, considerable variations more rare, and that at long intervals remarkable variations due to a fortuitous combination of two obsolete qualities, or of known and obsolete qualities, should occur. And since the law of inheritance, of the transmission of qualities, *can* explain the transmission of unlike as well as of like qualities, it is neither sensible nor scientific to attribute a few phenomena to some other mysterious cause. The breeders’ maxim, “*Like begets like,*” is literally true, and applies to differences as well as to resemblances. Every principle of breeding must conform to the law of inheritance. Every phenomenon of reproduction can be explained in accordance with the law, when *all* the the facts are known.

195. What the Law of Inheritance Is, and What It Means to the Poultry Breeder.—The law of inheritance is a *natural law*; it simply expresses the relation between descendant and ancestors. It does not, and cannot show how heredity can be so controlled as to effect the direct transmission of such particular qualities as the breeder esteems, and the immediate suppression of all others. As this is precisely what the poultry breeder would like to learn how to do, of what value is such a law to him? Just this: the

demonstration of *one* law of inheritance to account for *all* the phenomena of likeness and unlikeness in fowls of the same blood and breeding should show him that he can have virtually complete control of his stock, if only he will breed in conformity to principles proved by the law of inheritance, rejecting such so-called principles as will not stand the test. The right interpretation of the facts of inheritance should show him that the uncertainty of results in breeding, which he so often deplures, is not due to a conflict of mysterious forces, but to his own avoidable mistakes. The law of inheritance shows that by continued selection of the specimens most alike, the number and extent of possible differences in the offspring are constantly reduced. There is nothing new in this teaching. Successful breeders have followed it for years. But that there is one law, *and only one*, which applies to *all* the phenomena of reproduction, is the thing which, more than all others, the great mass of those who are trying to breed poultry need to know. When once they get firm hold of that fact, and form the habit of testing their methods by it, they will discard some fallacies that now stand in the way of better general progress in the improvement of domestic poultry.

196. Selection.—Inheritance perpetuates undesirable, as well as desirable, qualities. Its variations are as apt to be toward deterioration as toward improvement. Among animals in a state of nature, *natural selection*, the “survival of the fittest,” constantly operates to maintain the old features, and preserve and establish the new ones most beneficial to the race. In the breeding of domestic animals natural selection necessarily plays a part, but the chief factor is *artificial selection*, the “separation of the choicest,” in accordance with the interests or whims of the breeder. As an artificial standard seeks to secure exact similarity in many details, or, very superior excellence in one or more qualities, it is only by the most rigid selection of the individuals allowed to propagate their kind that a high stage of improvement can be reached and maintained. Rigid, severe selection is the key to success in poultry breeding. If a breeder desires uniformity in his stock, the breeding birds must be as nearly alike as can be had, and bred from *like* birds for many generations. If he wishes to secure high excellence in a particular quality, he must breed consecutively from the individuals in which that quality is best developed — *without detriment* to other qualities.*

* **NOTE.**—While a breeder should always select *the best*, he must expect that if a *best* bird is so much better than the type in any particular that it is markedly *unlike* the type, its progeny will not (unless it happens to be strongly prepotent with regard to the feature which constitutes its excellence) show an equal excellence. On the contrary, it is in accordance with the law that only a small proportion should do so, and that an equal number should be as much worse than the poorest progeny of the mediocre stock as the best are better than their best. So that, on the whole, the immediate progeny of phenomenally good birds may be disappointing. But by breeding from *the best* again and again, the marked advance made in any feature by an individual can be established as a race feature,—provided always that it can exist without detriment to other qualities.

Good food and good care are not less important than good stock, but come later in order of time; and to justify their use one must give them to good stock. Food and care, though of the best, cannot make a good layer of a hen that is constitutionally a poor layer; or put a round full breast on the descendant of a line of flat breasted fowls; or clean color on the offspring of a race weak in color. It is in the failure to carefully select the specimens used in the breeding pens that most breeders,—not merely most breeders of Standard fowls, but *most breeders*, most people who hatch and rear fowls,—fail to make their work pay.

197. The Common Mistake.—One who keeps a dozen hens in his back yard and rears annually sixty to seventy chicks, selects a good male bird, perhaps paying a good price for him, then hatches from the eggs of the entire flock. His hens are a fair average of their kind, not uniform either in appearance or quality, some fairly good, some poor. That is about as such flocks run. According to the common theory, as the best hens lay the most eggs, and throw the strongest chicks, the greater proportion of the chicks reared will be from those best hens. That theory takes for granted several things that may not be so. The result desired is not impossible; it is improbable, if the eggs are hatched, as they usually are in such cases, by hens. See how it works. One point of improvement is to be prolificacy. The best and earliest layers are not always the first to go broody, but they are very likely to be. They are set on eggs *from the flock*. If any of their own eggs happen to be in the lot, such eggs are the poorest they had laid. These hens incubate for three weeks, remain with the broods for six or eight weeks more. So it happens that nearly all the chicks reared are from the poorer hens. Is it any wonder that results in grading up scrub stock and improving stock of poor quality are not always satisfactory? Selection implies separation. *Separation is the object of selection*. If two or three or more of the best of a dozen hens are separated from the flock, the poultry keeper can know that he is breeding from those hens, and no others.

198. The Farmer's Mistake.—It is a very usual practice for a farmer having a flock of, say, one hundred hens, when buying blood to improve his stock, to buy six or eight males of the dollar-and-a-half to two-dollar kind to run with the flock; then use for hatching eggs collected from the flock. The chances are against any considerable number of the few hundreds of chicks reared being from the best hens. If twelve or fifteen of the best had been separated from the general flock for the breeding season, and mated with a male worth two of the kind used, the eggs from these hens only could have been set, and more improvement made in the stock in one year than by following the hit *and* miss method for three.

199. The Breeder's Mistake.—Many breeders of pure bred stock, who breed from a single pen, will use in that pen anything they may happen to

have in the way of a hen, that is not so poor that for very shame they cannot use her, trusting to a good male to stamp his quality on all the offspring. Thus they lumber their premises with a lot of cull chicks, which over-crowd the better ones, and prevent the few good ones from developing into what they might become if given more room and better care. Others, who breed from several pens, instead of mating best males to best females, make compromise matings * in order to get more and larger breeding yards; sacrificing quality to quantity at every point. This is not good breeding, neither is it good business policy. Good breeders breed only from the best of their good birds.

200. One Law for Fancier and Farmer. — The wisdom of close culling in breeding fancy stock is generally admitted, but many amateurs still insist that for them such close culling is impracticable. Most practical breeders, also, do not cull as closely as they should. One who has not much room will say that it is not worth while to take such pains for a few chicks. He ought, rather, to think it most important that none of his limited space be wasted on poor chicks. If he has room to rear chicks, he certainly has room to separate as many of his best hens as are needed to lay the eggs from which to hatch the chicks. One who must rear a large number of chicks will say that if he culls as closely as he knows he ought to, he will not have hens enough to lay the eggs he needs for hatching. That by no means follows. What is more likely to happen is, that with better average breeding stock, less crowded and better cared for, he will rear more and better chicks, though not as many eggs are set.

201. The Points to be Considered in Selecting, are: *Pedigree, Appearance, Performance, Condition.*

202. Pedigree.— Good fowls from poor stock are worth little as breeders. Good fowls of unknown ancestry are to be used with extreme caution. Good fowls of known good ancestry are valuable in the breeding yard in proportion as their ancestry was continuously uniformly good, when measured by the standard by which the progeny are to be measured. The mere fact that a fowl is "pedigreed," the names, or band numbers of its ancestors known, is worth nothing at all in breeding. The important thing to know is, how like they were to the desired type, and in what they differed.

203. Appearance includes *Shape, Size and Weight,* and *Color.*— Typical shapes of pure bred fowls are shown in the illustrations in Chapter V. In selecting for breeding, the breed type should be followed closely; departures from it should be made only for the purpose of strengthening a feature in

* NOTE.—Every mating is to some extent a compromise, a balancing of merits and defects. The reference here, however, is to the practice of using birds that for the good of the breed should go to the pot, in extreme matings which produce many birds that look all right, but are of little value as breeders.

which specimens of the breed are generally weak. As a rule, deformities are to be avoided. It will occasionally happen that a deformed fowl is of such uncommon general or special excellence that the breeder will profit more by using it, breeding its excellence into and its defects out of his stock, than by rejecting it. These cases are rare, and before using a disqualified bird a novice should make sure that it really has the excellence he supposes it to have. In any case, it should be used in a special mating, and not allowed to communicate its defects to the general stock. A male and female having a deformity in common should not be mated together; nor should fowls having the same defect, not amounting to a deformity, be mated together. Shape is universally recognized as more important than color, yet in judging and in breeding, shape is too often sacrificed to color. The trouble is that color defects are, to most people, more conspicuous than shape defects. Many cannot distinguish between the different types of form; but nearly everyone can appreciate a color fault when once attention has been called to it. Besides this, there is a mercenary side to the question. When rigid selection is made for both shape and color, the breeder finds only one good bird where, if shape defects are overlooked he would have two or three.

Fowls lacking in size and weight should be rejected as breeders; or, at most, used with great caution. Lack of size is a common fault in all breeds. Of the thoroughbred fowls for which the Standard has weight requirements, the greater number produced never attain Standard weight when in breeding condition. Some breeders advocate breeding from "medium sized" * males and large females, claiming that the female gives size and shape, the male color; or that the female gives size and practical qualities, the male shape and color.† Unless the size of the large females is objectionable, to make such matings a system is bad business. It will take only a few experiments in crossing males of small breeds on females of large breeds to convince anyone that the greater part of the progeny will come intermediate in size, a few being as small as the sire, a few as large as the dam. The prevalence of the intermediate size may not at first be noticeable in the offspring of small males and large females of the same breed, but a second medium sized male mated to large pullets from the first will get so few large chicks of either sex that the breeder will begin to know where he is "at."

* NOTE.—With some few *medium-sized* means, of Standard weight *or a little more*; but more often the "medium sized" males are below Standard weight, and very much smaller than the best developed males of their kind;—and in speaking of *best developed* males, excessively large, *coarse specimens are barred*.

† NOTE.—In the face of facts accessible to anyone who opens his eyes to see them, such broad generalizations are absurd. The most frequently recurring case of the commonest form (offspring resembling one parent more than the other) of direct heredity, is that daughters resemble the sire, sons the dam. This is known as "cross heredity." Though the most common case, it is not by any means a rule, for cases where sons most closely resemble the sire, daughters the dam, and cases where offspring of both sexes inherit quite equally from sire and dam, are numerous.

Excessively large males should be discarded. They are rarely good in shape, and not infrequently the excessive growth of bone and muscle is correlative with defective generative organs. In all breeds having Standard weight, best results, as far as results depend on size, are obtained by using birds whose weight, in good breeding condition equals or slightly exceeds the requirements of the Standard. In the smaller breeds most satisfactory results are obtained by using the largest birds having typical shape.

In selecting breeding fowls of cross bred, grade, or mongrel stock, selection for uniformity in shape, size, and color is advisable, the type used in each quality being that most desirable for the breeder's immediate purpose. In breeding thoroughbred fowls uniformity of color is imperative. Color matings for Standard fowls are described in ¶215 — 226.

204. Performance.—Under this head prolificacy is considered from a little different point of view than in treating of egg production. A hen may be a great layer and a poor breeder. The points most valued in a breeder are : (1) Ability to produce numerously vigorous offspring of the general type ; and (2) Prepotency, breeding power, ability to stamp individual qualities on offspring. The combination of marked prepotency and great excellence is rare. It would, perhaps, be discovered oftener if more accurate records of matings and results were kept. The distinction between prepotency and prolificacy should be observed. In breeding high class stock a very prepotent fowl may be valuable as a breeder, though not specially prolific ; but generally birds low in prolificacy cannot be profitably used.

205. Condition.—Fowls selected for breeding should have strong constitutions, should be in perfect health when put in the breeding pen, and should never have been seriously sick or badly out of condition. Fowls which as chicks were puny or backward, though finally nursed into good condition, are not desirable breeders ; nor are those which though never seriously sick, have been marked as subject to slight disorders. *Condition* of the breeders is of greatest importance. Hundreds of thousands of chicks are hatched, weak in constitution, predisposed to certain disorders, destined to die prematurely in spite of all that can be done for them.

206. Selecting Breeders to Produce Laying Stock.—The male should be from good laying stock : the females selected for individual performance in egg production, and when possible, according to the laying qualities of their daughters. One who is much among his fowls, observing them closely, can form a pretty good idea of the relative laying capacities of the hens. If the hens cannot be watched quite closely, trap nests should be used. In selecting young hens for breeders, pedigree counts most, for the performance observed can only be for a few weeks or months prior to the time of mating. In selecting hens, judgment can take account of a year's

work, a season's breeding, and a short period of the laying of pullets from them. For this reason, if for no other, hens are more desirable breeders than pullets. Shape and size of eggs laid by each hen must be considered, and sometimes color of eggs also. The laying-breeding hen should be well built, symmetrical. Defective shape may be tolerated in an individual, but ought not to be perpetuated.

In breeding from extraordinary layers, particular attention should be given to condition. To the statement in ¶196, that a breeder should select those specimens in which desired qualities were best developed, the proviso, "without detriment to other qualities," was added because artificial standards sometimes require things which are incompatible; but more particularly because in breeding practical poultry the development of laying or table qualities is easily brought to the point where further development is at the expense of other qualities, and thus detrimental to the stock. Chicks from eggs laid in the first two months of a mature hen's laying, are, on the whole, better than those from eggs produced when the hen has been laying continuously for three or four months. The best layers should be *tried* as breeders if they are in good condition at the season. There are some big layers that are uncommonly good breeders; but in general, a hen that lays a hundred and fifty eggs a year is worth more as a breeder than one which lays several dozen more.

207. Selecting Breeders to Produce Market Poultry.—In selecting stock for this purpose shape is most important. Figs. 47-54 show good types for broilers and small roasters. Figs, 56-62, 73, 74, show good types for general market fowls. In selecting from common stock preference should be given to specimens approaching one of the good meat types. Stock for breeding broilers should be quick maturing, early laying, and generally good laying stock. Quick growth is an important point in broiler production. Only hens that lay early and well can be depended on to produce market poultry, roasters as well as broilers, for the earliest demand. The early roaster is, as a rule, just a broiler grown older. For large roasters, slow maturing stock is best, as the meat of the young males remains soft much longer. A point of much importance is how the fowl fattens. Fowls which are prone to put on internal fat do not make good breeders.

208. Age of Breeding Stock.—Fowls should be at their best their second season, at the beginning of which they are generally twenty to twenty-four months old. If they are not then in tip-top condition, more "fit" for breeding than in the previous year, the breeder should look for something wrong in his method of handling breeding stock. A hen coming two years old, if not forced as a pullet, and if properly handled between seasons, will lay as well the second year as the first, and lay larger eggs, which will hatch stronger and better chicks. A cock of the same age that has not been over-

worked as a cockerel, and neglected between seasons, that is, as he should be, *in his prime*, will get better chicks than it was possible for him to get as a cockerel. The mating of males and females of this age will, other things equal, give better results than any other age or combination of ages. Well grown young fowls make better breeders than two-year-olds not in prime condition. A method favored by many breeders is to mate a cock bird to pullets, and a cockerel to hens. Generally these matings give better results than matings of cockerels and pullets not as good as matings of two-year-olds. Fowls in their third season will often get as good chicks at the height of the breeding season as they did the previous year. Old fowls, however, are not reliable breeders early in the season.

209. How Many Hens to a Male?—The general rule is:—for Asiatics, 6 to 10; for Americans, 8 to 12; for Mediterraneans, 10 to 15. A great deal depends on the male, and whether his attentions are well distributed. Sometimes good results in fertility are obtained from a male with twenty, twenty-five or thirty hens; but the quality of the chicks from such matings is rarely what it should be. Even in using the smaller numbers suggested in the rule, it is better to keep low rather than high. Small matings of one, two, or several hens with a male, are sometimes desired. Some males worry the hens when confined with so small a number. In that case the usual method is to introduce hens, as many as needed to keep the male peaceable, of a breed which lays eggs easily distinguished from those of the breeding hens. When more hens are kept together than one male can take care of, various expedients are resorted to to prevent males interfering with each other, or exhausting their power. When two males are used, the commonest practice is to run them with the hens on alternate days, though some make the periods several days or a week; and some think they get better results by using one male as long as he keeps in condition, then substituting one held in reserve for that purpose. A favorite method with larger flocks is to use three males, giving each two days work and a day's rest alternately. It is, perhaps, needless to say that these methods are not used by good breeders for good stock. For market poultry and laying stock, they answer; but unless the hens are all *good* of their kind, it is better to reduce their number to as many as can be kept with one male. Sometimes a male is given too many or too few hens, for the purpose of influencing the transmission of the qualities of sire and dam, it being known that the parent in best condition is most potent. This practice is a questionable one, for it really amounts to deliberately putting one side or the other out of condition.

210. Can Sex be Controlled?—No one has yet succeeded in demonstrating that it can—not in fowls. The numerous *recipes* given do not prove at all reliable.

211. Contamination.—It is sometimes asserted that a hen once served

by a male of another variety cannot be depended on to breed true. It is only in rare instances that eggs laid ten days after contamination hatch chicks which show in any way the influence of the foreign male. Few, perhaps none, of the reported cases of the influence of a male of another breed persisting for months or years, rest on indisputable evidence. The same thing may be said of alleged cases of "mental impressions."

212. Introducing New Blood.—Inbreeding.—It is commonly believed by poultrymen that to maintain the vigor of a stock new blood must be frequently introduced. Many go so far as to say that any inbreeding at all is bad; that it is from the outset the beginning of deterioration. If a man inbreeds, and his stock is weak, the weakness is invariably attributed to inbreeding. Most of the evils assigned to inbreeding are not due to inbreeding, but to careless selection. There is no evidence that the breeding of males and females of the nearest kin necessarily initiates degeneracy. There is abundant evidence that with proper selection for stamina, and to avoid common defects, very close inbreeding can be followed for a long time without injuring the stock. There is also abundant evidence that breeding unrelated fowls without careful attention to vigor, and avoidance of common defects, is at once attended with precisely the same results as breeding fowls of near kin under the same conditions. The prejudice (for it is nothing else) against inbreeding, is one of the serious drawbacks to general improvement of poultry. A breeder who does not confine his matings within narrow blood lines slips back about as fast as he crawls forward. Nearly every new breeder wastes a number of years trying to breed good stock without inbreeding. Practical poultrymen will notably improve their stock by inbreeding, then throw away results by bringing in new blood because of the fear that they may carry inbreeding too far. In time nearly all breeders come to admit that inbreeding is absolutely necessary (in breeding fancy fowls) in color breeding, yet few can be found who do not think it unquestionably bad for the practical breeder. As has already been said, there is not one law of breeding for one class of breeders and another for another class. If inbreeding is necessary to fix superiority in color, it is necessary to fix it in shape; if it is necessary to fix it in shape, it is necessary to fix superior laying capacity or rapid growth, *or vigor*. Inbreeding is necessary because there cannot be intelligent breeding without inbreeding. One who does not breed within close lines cannot *know* his stock as far back as he must know it if it is to be mated with reasonable assurance that the matings will produce the desired results. To secure uniformity inbreeding is necessary, because the number of inheritable differences must be kept as low as possible, and this can only be done by close inbreeding. The vigor of a flock is sustained not by regularly introducing new blood, but by selecting breeding birds for vigor. Vigorous birds generally beget vigorous offspring; weak birds weak offspring, whether akin or not.

Let it be fully understood that to breed from birds *because* they are related, without making selection for points desired, is as wrong as to refuse to mate related birds. The whole matter is well put, in a nutshell, by a writer on cattle breeding when he advises to ignore the fact of relationship altogether, and breed from the best individuals obtainable. Then the question for the poultry breeder is whether he can get, or can afford to get, better birds than he has. By breeding only from vigorous selected stock, and observing the rule not to mate fowls having bad defects in common, mating together only fowls which in individual merit and in pedigree — whether akin or no kin — are what they should be for the purpose of the mating, a breeder may be sure that he is avoiding the mistakes of those who miss it when they inbreed, and also of those who miss it when they do not.

213. Cross Breeding.—To breed crosses regularly, is not good policy for any poultry keeper. *It is not a rule* that crosses are harder or better layers than fowls of pure blood. Some crosses give good results, others do not. As to comparing all crosses with all pure bred fowls: the breeder of crosses generally, very soon leaves them for thoroughbreds. In crossing, the breeds selected should have such unlike qualities as when combined to form an intermediate type, would give the result sought. The cross of two breeds having a bad fault in common, should never be made. Crossing to give stock vigor, is not better than using vigorous blood of the same variety; it is not as good. Crossing two weak stocks in the hope of producing a strong one, will give satisfactory results in very very few instances. Some good crosses are White, Brown, or Buff, Leghorn and Light Brahma, or Buff, or White, Cochin; Brown Leghorn and Partridge Cochin; White Plymouth Rock, or Wyandotte and Light Brahma; Golden, or Buff, Wyandotte and Buff Cochin; Indian Game and Light Brahma, or Buff, or Partridge, Cochin, or Plymouth Rock, or Wyandotte: all these give yellow skin and legs. Good crosses, not right in color for “yellow” poultry, are Indian Game and Langshan; Black Minorca, or Houdan, and Langshan; Houdan and Brahma. In crossing birds differing much in size, males of the small breeds and females of the large should be used. In color, cross bred pullets most often resemble the sire, cockerels the dam; though the likeness is not very complete, and often quite different colors result. In shape and size, the progeny of both sexes is mostly intermediate. Occasionally the cross offspring are larger than either parent.

214. Mating Standard Fowls.—With a copy of the Standard and an illustration of his variety before him, a novice who has studied the remarks on selecting for shape (§203), will not need to have the points of shape desired explicitly set forth in the directions for mating each variety. The matings as described in the following paragraphs are mostly color matings; but a few points on shape which need special mention are introduced, and in

a few cases representing quite different types of fowls, fuller suggestions about shape are given. The particulars of shape to which attention is called are those requiring most attention. The beginner usually needs to be advised where to look for the weak points in his stock; for some of the most troublesome are overlooked unless attention is especially directed to them. Above all else, a novice needs to guard against being carried away by admiration for uncommon excellence in any one particular. It is the all around good birds that make the best breeders. In most of the varieties good Standard birds of both sexes are produced from a mating of Standard birds; but, in a few, distinctly different matings are required to produce first class specimens of each sex. In many varieties for which a single, Standard mating is used, it is sometimes necessary to use birds rather *strong* in color to restore color lost in breeding continuously from Standard birds.

It must be kept in mind that often the Standard allows considerable latitude in the matter of color, and in such cases it may happen that a breeder who follows the Standard as he interprets it, will fail to produce stock that comes well up to the Standard as interpreted by other breeders and the judges. Thus, in breeding Light Brahmas, one might breed pullets with wing flights (primaries) nearly half white, but when he comes to show or sell his birds, he would find that such wings are considered faulty, nearly black primaries being preferred. And, in breeding buff varieties, one might get what he considered the correct shade, only to find quite a different color in vogue. The only way a breeder can learn what the public wants, is by keeping in touch with other breeders of his variety, visiting accessible shows, and examining all reputed good specimens he has opportunity to handle. In mating birds of varieties for which both double and single matings are used, the system by which the stock was produced should be followed.

215. Mating Barred Plymouth Rocks. — A. C. Hawkins' rules (adapted from the *American Plymouth Rock Club Catalogue*).

“To produce both sexes of Standard color from the same mating, has been the study of thousands of breeders for the last thirty years. That some fine specimens have been produced by the single mating system, is true; but, unquestionably, more than ninety per cent of the winning Barred Plymouth Rocks in the country for the last twenty years, have been the product of the special mating system; and it is no doubt the surest and safest method of producing the highest scoring specimens of the breed.

“TO PRODUCE STANDARD FEMALES, use in the breeding pen only females of the highest type of color and form, with the qualities desired in the female progeny; or in other words, the very highest scoring specimens that have no (bad) defects. To these females mate a male bird of medium light color, and evenly barred all over, including wings and tail; and whose *dam* and *sire's dam* were of the same high standard in form and color desired in the female progeny.

“The male should have the blood in his veins of the same general character as that in the females he is mated with. He should have a deep full breast, broad concave back, small well serrated comb, orange yellow legs,—all important and desirable qualities in his produce.

"Such a mating can be depended on to produce ninety-five per cent of first class breeding and exhibition females. The males from it will be of the same color as their sire—not exhibition birds, but useful for breeding choice females.

"Do not use males with *very* light necks and tails in these pullet breeding pens, as these defects will be reproduced in the progeny in pullets with *splashed light necks*, and *blurred poorly barred tails*.

"Pullets of even color, and distinctly barred all over, are what is desired; and with careful selection of the breeding stock, it is not difficult to get them. Such pullets are rarely, if ever, produced from Standard colored males—and, if they look well, are not reliable breeders.

"TO PRODUCE MEDIUM DARK BLUE BARRED MALES AS REQUIRED BY THE STANDARD:—put at the head of the breeding pen the very finest exhibition male of Standard color, even serrated comb, broad concave back, deep full breast, small spreading tail, orange yellow legs, evenly barred all over and to the skin. Do not use a male with any *serious defect*, even if he scores high.

"With this male mate females of the same line of breeding as himself; not necessarily akin to him, but females whose *sire* and *dam's sire* were high scoring Standard colored birds. These females should be medium dark in color, *not smutty*; but evenly barred all over and to the skin, with good combs, forms and legs. From such a mating ninety-five per cent finely colored males suitable for breeding and exhibition can be produced. The females will be of the same general character and color as their dams, too dark for exhibition, but useful for breeding choice males.

"By this special mating system, and by careful selection of the breeding stock, the Barred Plymouth Rock is sure to improve each season, and the longer they are bred in line the more perfectly will their Standard qualities be brought out."

216. Mating Brown Leghorns.—A. C. Smith's rules (specially contributed for this book).

The methods and means that must be employed to mate Brown Leghorns successfully for exhibition specimens of both sexes, vary with the style of bird the breeder desires to produce. Most breeders use what is known as the double mating system—that is, a separate mating for the production of each sex. Some breeders use the single mating system, depending upon one mating to produce exhibition males and females. But the growing tendency in this, as in almost all varieties of fancy fowl, is toward the double system. The single mating may be used in this variety with far more success than in most others.

While it can hardly be said that each system has its advantages, it can be said that each system has its place. The best system is certainly the one that will produce the greater per cent of exhibition birds. Which system will do that, depends upon the style of male and female described in the Standard extant. The present demand is for what may, in general, be described as a dark male and light female. Such birds are, from a breeder's standpoint, direct opposites. Far better results may be obtained in seeking these diametrically opposite types by making a distinct mating for each sex.

The Double Mating System.

Mating for Exhibition Males.—[THE MALE]. The mating for exhibition males should, first of all, contain as fine an exhibition specimen as can be reared, bought, or borrowed—and I am inclined to say, *stolen*. The most important feature of this bird (if one feature is more important than others) are, undercolor, which should be dark and deep; a good metallic stripe in hackle and saddle; a concave shaped back, giving the graceful touch to every part of the bird; an even plumage, *i. e.*, showing the same shade of red in all sections that call for that color; and sufficient station to infuse the bird with

style and life. These are qualities that a flock takes generally from the male. The other sections should, of course, be as near Standard requirements as possible; but the writer believes that more improvement can be made in comb, eyes, wattles, lobes, color of legs, and many minor points with the female, than in color of plumage, length of leg, and general appearance.

[THE FEMALE].—The females selected for this mating should be dark in color of back and wing, with dark undercolor throughout. The color of the neck should be as near red as possible, and the stripe as near a metallic black as can be had with the other requisites. The comb should be small, and very evenly serrated. If it stands erect it is rather an advantage than otherwise. Such females are prone to have pale or black legs. In this case they should not be used if others with the same general characteristics can be procured; and while a pale leg may be tolerated, a black, or dark colored leg should never be used. Should either male or female fail in this respect, the breeder should see that it is strongly offset in the opposite sex.

Mating for Exhibition Females.—[THE MALE].—The mating for exhibition females should first of all possess a male bird that is the son of a splendid female, and was sired by the son of a splendid female. The further this line can be followed back the more certain the breeder may feel of a large percentage of exhibition females in the flock reared from this mating. This male should have a five pointed comb, smooth and straight over the beak; a light orange hackle, with a fairly good black stripe. His saddle should be the same shade of color as the hackle; but the black stripe is not wanted in the saddle of a pullet breeding male. The wing bow should be about the same shade of orange as the back, and should be large, running well down into the wing bars.

[THE FEMALE].—The females should be the best exhibition specimens procurable. Far better to breed from a single pair or trio than to use inferior females in this mating. The female of the present Standard is a rather light colored specimen as Brown Leghorn females run. She should have a nicely lopped comb, standing straight in front, and gradually drooping to one side, and a small, smooth, white or creamy white lobe.

The style of female just described, and the male, which is very clearly described in the Standard, can be bred successfully only by the double mating system.

The Single Mating System.

The single mating system might, *by chance*, produce fairly good specimens of the types; but even so, the blood must be properly balanced, and who is to foretell that such is the case? The single mating is one in which the best exhibition male and the best exhibition females are mated together to produce exhibition birds of both sexes. Its merit is not known under the present Standard. Its fault is that it seldom produces a bird of either sex of exhibition merit. It has for a recommendation only the beauty of its simplicity. It will become of use only when males and females of a medium shade of color are in vogue.

The Intermediate Mating.

A plan of mating that advocates of a single mating very often use, and, no doubt, think is a single mating,—though it is not, but may be called an intermediate mating—will succeed very well, but not as well as the double and separate matings. This plan involves the selection of a male mid-way between the types described for breeding exhibition males and for breeding exhibition females. That is, select a medium colored male, and mate him to females of both types.

These are the methods employed, given in a general way. The details must be observed and studied by the individual breeder.

217. Mating Silver and Golden Wyandottes.—These varieties being alike except in ground color of plumage, the rule for mating to get correct markings is the same for both. The breeder of Golden Wyandottes has an added difficulty in the task of getting the desired shade of golden bay in the ground color. The methods of mating to establish a good ground color are similar to those used to produce a uniform buff. (See ¶ 226). To produce the finest Standard specimens of both sexes a mating of exhibition males and females is the best that can be made. The rule as given specially for Silvers, by A. C. Hawkins, in *Farm-Poultry*, is:—

“Mate a male of good size, fine in form; medium short legs, giving a blocky appearance; medium sized comb, even and well pebbled on top, and curving with the head; breast medium dark, with no edging on the feathers; a strongly striped hackle and saddle; white wing bow, clearly defined double bar on wing, flights free from extra white; with females of full or over weight, good combs, clear open laced centers on breast and back; well striped hackles, white wing tips, tails not too high; both males and females with good legs.”

The females with *large* open centers all over, favored by some judges and breeders, are not Standard birds. (The Standard requires *medium*, not *large* centers in back). Still, the method of producing them is of interest to Wyandotte breeders, for if large open centers all over are demanded, notwithstanding the Standard, breeders must produce them, and if the fad persists, the Standard will eventually be changed to conform to it. It should be noted that the rules given below do not properly constitute a system like the double mating systems used for Barred Plymouth Rocks and Brown Leghorns.

Ira C. Kellar's rules (condensed and arranged from a series of articles on Golden Wyandottes, in *Reliable Poultry Journal*):

(1). *To Produce Large Centers on Cushion.*—In breeding for large centers of cushion, depth of breast lacing in the female is lost. To produce these large centers, mate females that have them with a male that has a strong well laced breast, with not too large centers, with neck, beak, back, saddle, and wing coverts well *laced*. Such a mating should produce a fair per cent of pullets with good sized centers all over, and nice very open laced cockerels.

(2). *To Produce Strongly Laced Males,*—mate cockerels from above mating with fairly heavily laced females.

(3). *If Females are so Open as to Grow Weak in Breast,*—mate with a Standard male. Some of the pullets from such a mating will be well laced all over, with quite heavy lacing. These mated to a male well laced *in every section* will produce some pullets up to Standard, and a good per cent of Standard marked cockerels.

(4). *To Produce Pullets with Clear Open Large Centers all over, a fair Per Cent of which will Mould into Clear Centered Hens,*—breed year after year from males well laced all over. Clear centered hens cannot be obtained by breeding Wyandottes heavily laced.

218. Mating Light Brahmas.—The mating of Standard exhibition birds, *as bred by the best breeders*, is the best that can be made, and will produce a very small per cent of inferior specimens of either sex. In shape

the Cochin type on the one hand, and the Langshan type on the other, are to be avoided. The comb should be well developed, but firm, well set, the three divisions and the serrations well defined. Particular attention should be given to the combs of females. These are so small that inconspicuous irregularities in them are often overlooked. These same inconspicuous irregularities, wrinkles and poorly marked divisions and serrations, are very unsightly when they reappear much magnified in the male offspring. The head should be broad and strong, with projecting, beetle brows. The neck neither so long as to give the bird a gawky look, nor so short as to make it look dumpy; the breast broad, full, well rounded; the back broad, narrower across the saddle than at the shoulders, but not conspicuously so, flat across the shoulders, medium in length; deep bodies, well spread tails; legs to correspond with neck in length, set well apart; shanks well feathered on the outside, and outer and middle toes well feathered.

The common color fault is weakness in black points, too little black, and that not of good quality. The black should be clear and bright, with metallic sheen; the hackle striped *exactly* as described in the Standard; the primaries black in the male, nearly black in the female. [The Standard allows a *nearly* black wing in males, and a wing just *more than half* black in females,— but to produce first class specimens of the type popular, black wings in males and in females nearly black must be used]. The main tail feathers and inner row of coverts should be free from white, the outer coverts edged with white. Black may be conspicuous in the foot feathering, but is discredited in the back. The under color should be an even bluish white. Old fowls that lose little black in moulting are especially valuable as breeders.

219. Mating Dark Brahmas.—A double mating system, in which both matings are “Standard” matings, is used. The Standard calls for a breast, “black or black slightly frosted with white,” in males. Males with black breasts are used with Standard females for the cockerel mating, and males with frosted breasts with Standard pullets for the pullet mating.

220. Mating Partridge Cochins.—Both systems of mating are used; the single mating of Standard birds; the special cockerel mating Standard males to females as dark as the Standard allows; the pullet mating light colored males with brown or red in breast to light colored Standard females. The remarks on Light Brahma shape apply generally to Cochins. The Cochin has not the broad skull and overhanging brows; but aside from that, the differences in form are chiefly due to differences in length and density of plumage.

221. Mating Colored Indian Games.—Double matings are used: for cockerels, Standard males with dark females, not well penciled; for pullets, laced males (the Standard male is not laced) with Standard females.

222. Mating Houdans. — Houdans lose black very rapidly in each succeeding moult, and in mating the age of the specimen has to be considered. Young birds of either sex in which the black does not largely predominate, should not be used. Good matings are: (1) A cock a little darker than Standard, with Standard hens. (2) Cock as above, with pullets a little too dark for exhibition. (3) Cockerel nearly black, with Standard pullets. (4) Cockerel as in (3), with light colored hens. Special attention should be given to the crest of the male. It is never as good as in the best females, but unless it is fairly developed and good in form, the greater part of the offspring are likely to have very poor crests.

223. Mating Spangled and Penciled Hamburgs and Polish. — For all these varieties, single matings of Standard birds are used. Experts in these varieties advise that a mating which gives good results be kept unchanged as long as the birds comprising it can be used for breeders.

224. Mating White Varieties. — In those white varieties for which the Standard requires *pure white* plumage and bright yellow legs and skin, the best mating is of fowls with shanks and skin a good yellow, and just the faintest creamy tint in the plumage, a little stronger on the backs of the males than elsewhere, and generally a little stronger next the skin than on the surface, but not anywhere approaching a straw color. The backs of young males should be quite white. As a rule a cock will show more color than he did as a cockerel. Those which at two years old show little color are most desirable breeders. In breeding the white varieties which do not have yellow skin and legs, the pure white plumage is less difficult to get.

225. Mating Black Varieties. — The *correct* black is a brilliant black with greenish luster; the faulty black has a dead rusty look or a purplish cast. The commonest color defect in black fowls is white, or gray, in the flights,— often only a mere tip of grayish white. Breeders have found it difficult to breed this entirely out, and the usual practice is to tolerate it in all round good specimens, at the same time avoiding mating together males and females having the fault in common. In black fowls with yellow skin and legs:— Cochins, Wyandottes, Leghorns,— clean yellow shanks are rarely produced. In Black Langshans yellow in the feet generally indicates the presence of Cochin blood. Breeding from birds having the fault not only retains the objectionable color, but makes it harder to maintain the true Langshan shape.

226. Mating Buff Varieties. — The buff varieties, with the exception of Cochins, are all new, and the up-to-date Cochin might without great impropriety be styled a new variety. Though buff is called a “solid” color, it is by no means an easy color to handle. Breeders find it quite as difficult to get one uniform shade of buff in all sections *and keep it*, as to get any combination of colors and markings described in the Standard. At present

the popular shade is a golden buff, between the reddish buff and the pale yellow, which were the extremes of color which different breeders have been calling buff. In mating buff fowls, the best method is to use birds of both sexes as near the desired golden buff as can be obtained, avoiding the mating of birds having color defects in the same section, *whether the defects are similar or opposite*. The common color faults in buff fowls are white, or black, in wings and tails; red on the backs and shoulders of males; very light breasts on females; black ticks or lacing on necks and backs; mottled plumage, slaty under color, white under color — no under color. Black or gray in any part of the plumage except the primaries and main tail feathers, should cause a bird to be rejected, no matter how good otherwise. In the sections excepted, a little dark color may be admitted if the mate of the bird is good buff in them. In any case it is not advisable to breed from a specimen in which the foreign color is distinct. Birds with positive white in wings and tails should be rejected; also those in which the upper and lower webs of the feathers are of distinctly different shades. Faded, and slightly mealy wings and tails, may be admitted if the bird is pretty good all round, and can be mated with one good in wing and tail. A bird extra good in wing and tail can generally be used to advantage, though rather weak in other sections. In breeding to get the red out of the backs of males, the lightest females that can be found that are a good bright even surface color, the same on back and breast, should be mated to males as free from red as they can be had, and fairly uniform in all sections. Specimens with pale eyes should be rejected. In an exhibition bird surface color is worth more than under color; but in breeding, a bird good in under color will get more good even colored chicks than one better on the surface and not so good in under color.

227. The Breeding Season is early or late, long or short, according to the purpose and progress of the breeder. For breeding early market poultry stock should be mated late in the fall. In producing laying stock the chicks of different breeds should be hatched at such times that the pullets will come to laying maturity tolerably early in the fall, yet not so early that after laying a few eggs they moult like old hens. Brahma and Cochin pullets begin to lay at seven to nine months; Langshans, six to eight months; American breeds, five to seven months; Leghorns and the smaller breeds generally, four to six months. Very precocious stock may lay earlier, very backward pullets later, than the periods specified. If it is desired to have pullets coming to laying maturity from September first to November first, hatches should be: — for Brahmas and Cochins, February and March; for Langshans, March and April; for Plymouth Rocks, March fifteenth to May fifteenth; for Wyandottes, April first to June first; for smaller varieties, May first to July first. The breeding pens should be mated up at least five or six weeks previous to the earliest date given for hatching each class of fowls. When breeding fowls are shipped from a distance, it is best to buy so early that the birds have several months in which to become acclimated before the beginning of the breeding season.

Large breeders of exhibition and stock birds try to have stock ready to sell for exhibition at any and all times, from the earliest fair to the latest poultry show. A few hatch practically the year round. It is always better to be a little in advance of the season, than to run the chance of a set-back which will put operations so far behind that the loss cannot be recovered that season.

228. Care of Breeding Stock. — Many breeders try to discourage their breeding hens from laying in the winter; not merely that they may lay *more eggs* when eggs for hatching are wanted, but because they wish to have them in tip-top physical condition during the breeding season. They are not always entirely successful in this, but by keeping them a little fat, generally keep egg production below the point where it begins to tell on vitality. Those who use the same hens for laying and breeding should, if the hens lay early in the winter, give them a few weeks rest just before the breeding season. (If only *the best* hens are used for breeding, this need not cause a break in the total yield of eggs. Sometimes the rest will come about naturally; the hens after some weeks or months of laying going broody. They may then be allowed to hatch a brood of chicks (to be reared by another hen or in a brooder) or, if chicks are not wanted* at that season may be allowed to sit for a while on nest eggs. In either case they should be well fed.

If the breeding stock can be given range, well and good. If that cannot be, it will be found that with exercise, green food, and meat furnished as needed, as good chicks can be obtained from fowls in confinement as from fowls at liberty — by far the larger number of good fowls are from yarded stock. † The stock should not, however, be crowded; considerably more space per hen should be allowed than is generally given laying hens.

The food need not be different from that of the laying stock, except that if the layers are given stimulants of any kind, it is better to leave them out of the food for the breeders. A very gallant male is sometimes so solicitous that the hens shall get all the food they can eat, that he neglects to eat himself. When this is the case the male must have extra food to keep him in condition. A tame bird may be fed from the hand when the others are fed; a shy bird should be removed from the pen in the evening, fed by lantern light, and given a good feed again next morning before being returned to the pen. If at any time a bird in the breeding pen seems dull, though not downright sick, it should be removed until in good condition. The males need such attention most.

* NOTE. — Early chicks hatched in this way generally come in very acceptably for market or for the table. They need not be from the breeding stock, and can be eaten and out of the way before the later better chicks are crowded by them.

† NOTE. — There is a great deal of nonsense talked and written about free range and unlimited range. The truth is, our American improved varieties of domestic fowls are pre-eminently domestic in their habits, and confine themselves to quite narrow limits unless literally starved into extending them. A man *can* take as much exercise in a garden plot as on a ten thousand acre ranch.

Slight disorders, which would quickly pass off were the bird isolated, may develop serious trouble if he is continued in service when not in condition. A hen out of condition, and moping, is likely to be injured by the male, or worried by other hens unless removed from the pen. Hens that go broody should be broken of the fever, and kept laying as long as their eggs are needed for hatching. After that it is better to allow them to hatch and rear a brood. Whenever it is feasible, a breeder, though using but one mating, should have a good male in reserve, in case the one he has put in the breeding yard prove impotent, or meet with an accident, or prove in any way unsatisfactory. Breeders who use many matings always hold a number of good birds in reserve. Unless one does so, he may lose a season's work from a good pen of hens. When eggs are no longer needed for hatching, it is better to remove the males from the pens, and not allow them to run with the hens again until the next breeding season. They only worry the hens, and retard their own moult. Often the old males show no attention to the hens except to viciously drive them about.

229. About Eggs for Hatching. — The eggs should be gathered daily — oftener if there is danger of their becoming chilled — and given a distinguishing mark, or marks, which will identify them as from a particular pen. If one has more than one mating of a variety, the name, or initials of the name, of the variety is not enough; the number of the pen or mating should be added. The need of this is obvious. If the breeder does not accurately mark all eggs when taken from the nests, he never knows what he is hatching himself, and his customers buying eggs, as they suppose, from several matings, and wishing to keep account of the chicks from each, are not at all favorably impressed if the eggs sent them are all marked alike, or not marked at all. Who can blame them, in such a case, if they are a little skeptical as to the shipper knowing as much as he ought to about his stock? There cannot be intelligent selection without accurate knowledge of the results of matings; there cannot be such knowledge without proper identification of eggs and chicks from each mating.

In sorting, culling the eggs, the rule should be to reject imperfect eggs, small eggs, and very large eggs; but the rule must be applied with judgment, allowing exceptions in some circumstances. A hen which it is most desirable to breed from may lay a poor egg; and it may be more advantageous to breed her good qualities into the stock — and this fault, if it appears, out — than to reject her eggs. Many eggs with imperfect shells, which would quite certainly be broken if given hens to incubate, can be hatched in a machine. Extra large eggs, which in most incubators could not be hatched with smaller eggs, can be hatched under hens if there is an object in hatching them.

Eggs for hatching should be kept in a cool dry place; — a temperature of 40° to 50° F. is best. They do not need to be turned at all while thus kept, nor is it necessary that they should be placed in any particular position. This

statement is contrary to advice commonly given, but is in accordance with general practice: — few breeders turn the eggs, and it has not been observed that turned eggs hatch better — and is confirmed by the highest authority on artificial incubation. (See Cyphers' "Incubation and Its Natural Laws," p. 53).



CHAPTER XI.

Hatching and Rearing Chicks.

230. The Two Systems.—There are two methods of hatching and brooding chicks: the *natural*, in which the chicks are hatched and brooded by hens; and the *artificial*, in which they are hatched in incubators and brooded in houses, as described in ¶¶46–48, or in separate out-door brooders. The conditions which would determine the choice of method were stated in ¶¶60. The natural method is still in most general use. The other is oftener used by those operating on a large scale, and is coming, year by year, into more general use. As to results,—that depends more on the operator than on the method. * As good chicks can be reared without hens as with them. In using the natural method, the operator divides the responsibility with the hens; in using the artificial method, he assumes it all. After weaning, the treatment of the chicks is essentially the same, no matter which method had been previously employed.

THE NATURAL METHOD.

231. Remarks.—The sitting hen's reputation for fickleness and perversity is not deserved. The trials of those who find the care of sitting hens and hens with chicks too troublesome, are mostly due to the failure to furnish proper facilities for the work, and to handle the stock systematically. It is easy to handle hens and chicks in large numbers if one goes about it in the right way. The complaints against hens are: they do not persist in broodiness; they will not sit elsewhere than on their laying nests; after being set, they desert the eggs; they remain too long away from the nests, allowing eggs to become chilled; they quarrel among themselves, and break eggs; they trample chicks in the nests; they kill each other's chicks; their chicks are lousy, etc. These are preventable evils.

* NOTE.—That those who fail with one method often succeed with the other, is to be attributed to personal differences in taste and temperament, and in the *bent* of talent. It seems to be impossible for some persons to acquire the little, elementary, engineering skill required to successfully operate an incubator; yet these same persons may be very expert in the use of the natural method. And there are many people who will never force themselves to do the routine work of caring for sitting hens in such a way that good results are a practical certainty; but will take pleasure in working with machines, and will be very successful with them. Many poultry keepers work equally well with either method; and not a few people who try to raise fowls fail, no matter which method they try.

232. Selecting Hens for Sitters. — As has been said, results in general, depend on the operator more than on the method. In using the natural method, the operator has an early opportunity to display good judgment in the selection of the hens to be used for sitters. Not all hens make good sitters. Not all that have done well through the period of incubation, can be trusted to bring out the chicks and nurse the broods. A hen that is not in fair condition — neither thin nor grossly fat, — or that does not feel hot to the hand when handled (with the hand under the body, and the fingers touching the skin), or that will not allow herself to be handled freely, after dark, at least, should not be used.* Nor should a hen with a vicious disposition be used; a point of prime importance in this method is to use hens that are easily managed.

There is a general prejudice against large heavy hens as sitters, because eggs are so often broken by them. It is, to say the least, questionable whether that prejudice is well founded. The large hens are usually very gentle and quiet, deliberate in their movements. When they break eggs with good shells, it is because they are lousy, or because suitable nests have not been provided for them. If their nests are roomy, easy to walk into and from, there will be little trouble with *clean* hens breaking *good* eggs. There are some hens of all sizes that are nervous, excitable, and break eggs constantly. Very small hens are not desirable sitters in cold weather.

233. Where to Set the Hens. — When only a few hens are set each year, the nests can be placed almost anywhere that the hens will be free from annoyances. When more than three or four are to be sitting at one time, it is best to provide special quarters for them. Fig. 39, shows a good arrangement for a small plant, one which relieves the operator of the trouble of moving the hens to new nests. On large plants, where hens are used for hatching, the usual arrangement is to set them in the surplus stock pens, or in pens from which the laying stock has been removed. Whatever plan is adopted, it is important to have the sitters at one of the most accessible parts of the plant, and all near together.

234. The Nests — should be like those shown in Figs. 37 and 38. (This is not absolutely necessary, but a nest with a front just high enough to retain

* **NOTE.** — Some shy hens lose their shyness when broody. Others cannot at first be touched by daylight. If their services are needed for hatching, it is quite an easy matter to win the confidence of such hens, and make them quiet enough to handle. All that is necessary is to approach them cautiously, coming near and putting the hand as close as they will allow without leaving the nest, then withdrawing it before they have quite made up their minds to fly. Continue this at convenient intervals until, finding they are not to be hurt, they remain quiet, and at length allow themselves to be handled. It takes a little patience, and a few minutes daily for several days. Too many poultry keepers try to subdue their hens by main strength and awkwardness — principally awkwardness. In no case should a hen that cannot be handled, be set, — not if the keeper wants to manage things himself.

the nesting material is most convenient for examining the eggs, if necessary, when the hen is on the nest, and is about the only style of handy nest in which a hen can be confined). If only two, four, or six hens are set in the same apartment, open nests may be used—though even for that small number, the closed nest is safer and surer;—but where many hens are set together nests that can be closed are indispensable. The nest boxes may be with or without bottoms. They should be placed with backs to the walls, all facing the center of the pen. If with board bottoms, a few inches of earth should be put in each nest, slightly hollowed, and the corners of the nest filled up high (that if eggs are accidentally pushed toward them there may be no depression into which they can slip, remain and get cold), before the nest material proper is put in. Bottomless nests are more convenient, and more easily kept clean. They are, however, hardly suitable to use on a board floor. On an earth floor the bottomless nest is by all odds the best. The floor where the nest is to go should be raked smooth, and after the nest is in place the earth under it should be formed and firmed as described for the other nests.

For nesting material, straw, hay, or excelsior may be used. Very long coarse hay or straw is not suitable. Soft hay or straw of medium length is better than cut stuff;—the nest made of it keeps its shape better. Just enough material should be used to make a good firm mat over the earth. Unless there is to be a period of probation, on china eggs, for the hens, each nest should be shaped and well *firmed* with the hand before eggs are placed in it; or the hen in trying to shape the nest with eggs in it will break some of them. It is a good plan to thoroughly dust the nest with insect powder before placing the hen on it. If this is done, and the hens were quite free from lice, they need not be powdered again for eleven or twelve days.

235. Setting the Hens.—It is a good plan to have regular days—once a week is often enough—for setting hens, and to set as many as possible each time, that if there are many infertile eggs the sittings may be *doubled up*, and that the broods hatched may be equally distributed to just as many hens as are needed to take care of them. If open nests are used the hens are often given a few days probation on nest eggs, before being trusted with the eggs which they are to incubate. If closed nests are used, such probation is unnecessary, and a distinct gain of several days for each hen is made. (Those who use the open nests find it necessary to close in some hens at first, using a board or box for that purpose. The movable cover is handier, though used only for a few days).

The hens should be moved at night, carried gently, one or two at a time. One who is about the poultry houses much in the daytime can generally do such work without a light much more quickly and with less annoyance to the hens, than if a lantern is carried. If a light must be used, and any of the hens are at all shy, it is best to place the lantern where it will throw just

enough light into the sitters' pen to enable one to see his way to the nests. The hens placed on the eggs in the dark will immediately settle down. The cover should be fastened in place, and, if there is any uncertainty as to how a hen will behave on finding herself in a strange place in the morning, a piece of burlap should be thrown over the nest to keep her quiet. If this is not done she may struggle to get out, and in her struggles break many eggs. The burlap need rarely be used longer than one or two days.

236. The Eggs Set should be quite fresh,—the fresher the better. Eggs three weeks or more old, will hatch well sometimes, but the chicks will be longer in coming out, and be less vigorous than chicks from the fresher eggs from the same breeding pens. If it is desired to set eggs of different varieties under the same hen, and one kind of eggs is a little slower hatching than the other, the slowest eggs can be given the hen first, and the others put in a day later.

237. Keeping a Record of Hatches.—The simplest way to keep account of the hens and eggs set is to tack on or above the nests, where they can be easily read, cards numbered consecutively, beginning with No. 1, for the first hen set, and having on them: (1) The date when set; (2) The number of eggs set; (3) Variety or kind; (4) Date of first test, number fertile,—infertile,—dead; (5) Second test and notes; (6) Hatch,—number of live chicks taken from nest,—number killed or dying after hatching,—number failing to break the shell,—to get out after pipping. Such cards can be preserved, and will furnish complete data of all hatches. If it is preferred, the records can be kept in a note book, the nests being identified by numbers, or by descriptions of the hens; but the card method works better,—is more economical of time.

238. Food and Care of Sitting Hens — The best food for sitting hens is whole corn. When open nests are used, a dish of corn, a pan of water, a box of grit, and a dust bath are provided, and the hens left very much to themselves. With the covered nests, food, water, etc., are provided just the same. The hens are let out two or four at a time, and the nests closed again after the hens go back, which they should do in about twenty to thirty minutes, remaining off longer, as a rule, in warm weather than in cold. This work can be looked after by the attendant as he passes and repasses the sitters' pens through the day. Pens eight to ten feet square accommodate twelve to twenty sitting hens. They can usually be let out four at a time; so that it is a simple matter to get the hens all fed, watered and shut into their nests comfortable and safe for another twenty-four hours without taking an appreciable amount of time for the work. The nests should be opened in the same order, and at about the same time day after day. Hens that do not return of their own accord within a reasonable time, should be driven back. Any that are too

wild to do this with, should be fed late in the evening. As hens come off, the condition of each nest should be noted. If any contain broken eggs they should be cleaned at once, if still moist; if dry, it is as well to mark the nest, and clean all such at the earliest convenient time. Hens will be more content, keep in better condition, and hatch better and stronger chicks if allowed to go out doors every time they leave the nest. They should be well powdered with insect powder about the eleventh or twelfth day of incubation, and again a week later.

239. Testing the Eggs.—The eggs incubated ought always to be tested as early as fertility can be certainly determined—that is, about the fourth or fifth day for white shelled eggs, and two to four days later for eggs with dark thick shells. The removal of the infertile eggs gives those left a better chance. If there are many infertile eggs a part of the hens can be reset. If the plan is to set hens once a week the test of the eggs last set may be made early the same day, and hens reset with the new lot. Testing ought not to be neglected. It is not to the breeder's interest—unless he merely wants to rest his hens from laying—to allow hens to devote their time to eggs that will not hatch. During the season he needs to get chicks out as rapidly as possible, and it is poor policy to “go it blind,” as they do who do not test the eggs. Even if eggs are running high in fertility, it is better to test, for there may be some dead germs, rotting. A rotten egg breaks easily, and when one does break in a nest the chances of a good hatch are reduced—besides, there is the nasty job of cleaning the nest and eggs.

Egg Testers—are sold by incubator manufacturers and dealers in poultry supplies. A home made tester can be made in a few minutes of a small box of such size and dimensions that a common hand lamp or a lantern can be set in it. If a lamp is to be used, one side of the box should be hinged, or slide in grooves; a hole should be cut in the top directly over the flame, another in one side opposite the flame. Over this last hole a piece of felt or of an old rubber boot leg, having in it a hole a little smaller than an egg will pass through, should be tacked. If a lantern is used all that is necessary is to knock one end out of the box, that the lantern may be put down in it, and fix the hole opposite the flame as described above.

The testing should be done in a dark room. If the pen in which the hens are set cannot be made dark enough by covering up the windows, it is best to test after dark. The quickest and easiest way is to place the tester on top of the nest box, stoop down, take all the eggs from under a hen, putting them on the floor in front of the nest. As the eggs are examined replace the fertile ones under the hen, and throw the infertiles aside; then go on to the next hen.

In testing, the light shining through the egg held against the hole in the side of the chimney or box shows the condition of the egg. An infertile egg is clear. An egg containing a live germ, after being incubated for a week, is

quite evenly clouded, but lightest at the small end; has the air space at the large end clearly defined, and the line marking the air space remains fixed as the egg is turned before the light. An egg containing a dead germ may show more faintly clouded than a fertile egg, as if less advanced; or the germ may be discernible, black and unstable — not dark red and in a fixed position, as in the live egg. As decomposition proceeds and the egg becomes decidedly rotten, it appears more unevenly clouded, and the line of the air space tends to remain level as the egg is turned before the light. The infertile eggs may be fed to chicks and fowls.

The novice must expect to make some mistakes in testing. Give the egg the benefit of the doubt; mark it, and test again a few days later.

240. Moistening Eggs during incubation is not necessary. In a dry climate, if the heat is intense, or a dry wind is blowing while the eggs are hatching, it may be necessary to dampen the nest and the earth about it to prevent drying of the membrane *after the shell is pipped*; but sprinkling before the shell is broken can hardly have any effect on the contents of the egg.

241. Chilled Eggs. — If hens are set in covered nests, and the keeper sees that they go back in time and shuts them in, there will be no cold eggs. If eggs do get cold, it is as well to continue incubation, and note results. In the early part of the period their condition can be determined by testing; later one must wait until the time is up; then, if chicks are hatched, judge from the chicks themselves whether they are worth keeping. Eggs under hens will stand much more cooling than in an incubator. Many instances have been known of eggs exposed to an almost freezing temperature for some time hatching good strong chicks. Chilling seems to be less injurious during the second week of incubation than earlier or later.

242. When the Chicks are Hatching — it is best to watch them quite closely. Some hens become excited when the chicks begin to “cheep,” and in their restlessness crush eggs, so that the chicks cannot turn in the shells.* If possible, such hens should be changed with hens that have been sitting for a shorter period. A few hens, perhaps one in a hundred, will kill chicks as fast as they hatch, and one must be on the lookout for these. Trampling chicks in the nests after hatching, is as often due to weak chicks as to clumsy hens; but there are some hens not to be trusted, and some that will get along very well if the nests are not too full, but not so well with a full nest. When there are many hens available, it is not hard to so shift them around that the losses of chicks in the nests are kept low.

243. Helping Chicks Out of the Shell. — If chicks are alive, and seem

* NOTE.—Such restlessness is not due to annoyance at being disturbed by the attendant examining the eggs. These restless hens will fuss and crush the eggs though left entirely to themselves,— and the same is true of many hens that trample chicks.

to be strong, though apparently unable to get out of the shells after pipping, they should be let alone until all that can get out by themselves are out; then the shell may be gently broken, and the cap removed. If the membrane is not dried to the chick, it should be left to help itself out. If the membrane adheres to the down, it should be moistened with warm water—or saliva, which is better—and carefully detached. If this can be done without causing bleeding, the chick is likely to come on all right; if it bleeds, it will probably die.

244. After Hatching.—When the chicks are hatched and dry, they should be removed from the nests and distributed among the best of the hens, each medium sized hen being given from ten to twelve chicks in cold weather, and eighteen or twenty in warm weather. Larger broods are sometimes given, and hens may do well with them; but the chicks do not often make as good growth as when less crowded. It is better to limit the number to as many as the hen can keep warm the coolest nights she has to brood them. It must be remembered that the chicks constantly increase in size, while the hen remains the same. A hen that has made a poor hatch, for which her condition seems to be responsible, ought not to be given a brood. It is likely that her vitality is low, and that instead of nourishing the chicks, she will rob them of vitality when she broods them, and they will in consequence dwindle and die, seemingly without cause. A scaly legged hen ought never to be used as a mother—though if not too bad, she may be used to incubate eggs.

245. Puny and Deformed Chicks should be killed at once. It is neither kindness nor policy to keep them. This is one of the hardest lessons for the poultry keeper to learn. The weaklings appeal to his sympathies. He cannot find it in his heart to take away their slender chances of life, and he is averse to voluntarily giving up any results of his labor except for value received. If one will make a practice of killing every weakling as he takes the chicks from the nests, he will see the general condition of his young stock much improved, and will be far less troubled with the common ills of chickhood.

246. Marking Chicks.—If the chicks are to be marked, it should be done by making punch marks in the webs of the feet as they are removed from the nests, using one of the markers made especially for the purpose. Marking can be done at any time, but chicks may become mixed after being taken from the nests; and further, if the marking is done when they are but a few hours old, the cut will bleed but little, and there is not the danger of chicks picking each other's feet as they often do when marking is postponed until they are older, and the cut bleeds more freely. As there are two webs in each foot, it is possible so to mark the chicks that the offspring of sixteen different matings of each breed or variety can be readily identified by the

absence of a mark for mating No. 1, and the positions of the punch marks for Nos. 2 to 16, inclusive.

247. Keeping Chicks Free from Lice. — If the sitting hens have been treated to prevent the rapid increase of lice while they are incubating, the chicks should be quite free from lice when taken from the nests; but, as lice are elusive creatures, and not always found when wanted, and as a very few of them can do a great deal of damage to a young chick in a short time, it is best to powder all the young chicks when taken from the nest, and at intervals of about a week, until three or four weeks old. After that they need not be powdered unless unmistakable indications of the presence of lice are observed.

The easiest, quickest, and surest way to treat chicks for lice, is to powder them in the coops in the evening or early in the morning, using a large powder gun, which can be bought at any store; or a box with a perforated cover, giving the chicks a good sprinkling of it — the hen being meantime held in one hand, — working it well into the feathers of the hen, held head downward, and puffing it into every corner of the coop, which should then be closed. If the work is done at night, it should be left closed; if in the morning, it should be kept closed for half an hour or so. When coops like that in Fig. 44 are used, the coop is tipped back during the operation of powdering. At first thought this may seem an awkward way to go at it, but it will be found that neither hens nor chicks can get out through the slide door as they can through a hinged top when it is moved. Some poultrymen use lard on the heads, under the wings, and at the vents of young chicks, to kill lice. This mode is effective, but too slow, as it necessitates the handling of each and every chick. With the powder twelve or twenty chicks are treated as quickly as one, and with fresh strong powder the treatment is effective every time.

248. Colors of Chicks When Hatched. — Those not familiar with the appearance of chicks of the various pure breeds when first hatched, are often disappointed when they see the color of the chicks in the down so different from that of the mature fowl, and imagine that there is something wrong with the stock. Chicks of white varieties are generally canary colored when hatched; but White Plymouth Rock and Wyandotte chicks are often quite dark gray. Light Brahma chicks are mostly canary colored, or canary colored with one or two small irregular black spots on head and back. A few are

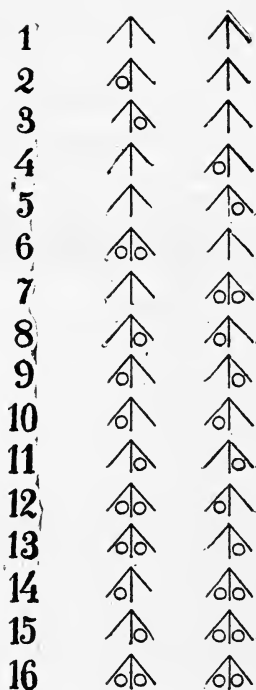

Fig. 78. Punch Marks for Chicks.

quite gray. Chicks of black varieties are mostly black on the backs; canary colored on the breasts. Barred Plymouth Rock chicks are gray on the backs, lighter underneath, with generally a light splash on top of the head. The cockerels are much lighter colored than pullets from the same matings. In nearly all varieties there is more diversity in the color of the chicks when hatched than when feathered.

249. The First Feed for the Chicks need not be essentially different from those which are to follow; nor need the food given the first few weeks be different in kind from that given later. The young chick needs precisely the same kinds of food that the older chick and the mature fowl need; but it needs it in form adapted to smaller digestive organs, and needs food oftener. The matter of feeding has been so fully covered in ¶ 137—146, special rations for young chicks being given in ¶ 146, 21—28, that the same ground need not be gone over here. Chicks may be fed as soon as they will eat. There is not the slightest danger of their injuring themselves by eating before their systems are ready for food.*

250. Water for Young Chicks.—It is possible to grow young chicks up to four or five weeks of age without giving them water. Nearly all expert poultry keepers are agreed, however, that the chicks ought to have water from the start. They should have constant access to it, and if by any chance they are deprived of it long enough to become very thirsty, they ought not to be allowed to drink freely of *cold* water immediately. By giving the water warm at first, cramps and chills are prevented.

251. About Cooping.—For the first few days the chicks are as well off indoors in a box just large enough for the hen to move about comfortably. If the weather is cold and wet, they should be kept in still longer; but not in too close quarters. A good plan is to confine the hens in small coops—boxes with slats across the fronts will do—and allow the broods of several hens to run on the same pen floor. When the time comes to put them outdoors, the hens should still be confined. Many promising broods are ruined by the hens running the chicks “off their legs,” wearing them out completely. Even after the chicks are strong enough to keep up with a foraging hen, it is better to place the hen under restraint; then each chick can run just as much or as little as it pleases, and those that are weaker than the others—yet not *weaklings*—have a better chance than when compelled to keep the pace set by the hen or the strongest chicks.

Many hens which are themselves model mothers, are vicious toward the

* NOTE.—It is often stated that chicks are injured by being fed before the yolk absorbed previous to exclusion is assimilated, and that they should not be fed until twenty-four hours old. Some chicks will eat within twelve hours of being hatched, and some will not eat for thirty-six hours or more, though food is frequently before them and the hen inviting them to eat.

chicks of other hens, picking and worrying them whenever they come near. This can only be prevented by making it impossible for the hens to get at strange chicks; or, making it easy for the chicks to escape from angry hens. With coops as shown in Fig. 44, having the slats of the coop pens perpendicular, the chick which wanders into a strange coop will almost invariably get away before being hurt. The coop shown in Fig. 45, gives still more complete protection, but is too expensive to use unless it is necessary to protect from hawks and cats, for which purpose that coop was specially constructed.

With a coop that is tightly built, and can be closed tight, chicks can be reared outdoors in winter when the thermometer ranges to 20° below zero. (Chicks hatched in winter stand cold much better than late chicks—early summer chicks—stand extreme heat). This, of course, cannot be done when there is much snow, but in a snowy country such coops can be set under a rough shed where the ground is tolerably dry, and good chicks reared; not on a commercial scale for market,—but for hardy stock birds of the large breeds.

Sometimes hens do not brood their chicks as much as they should on cold bleak days. In that case they should be shut into the coop house, and the door left open just enough to let the chicks pass in and out. The coop should be made quite dark. In the dark the hens will brood the chicks whenever they come to them.

When coops with perpendicular sides are used, shade can be given by spreading pieces of burlap over the tops of the runs. A grain sack, which gives two thicknesses of burlap, will keep the ground inside the pen dry through quite a long shower, and dry all day through a drizzling rain.

Coops placed on grass should be moved every few days. When coops are kept permanently in one spot, the ground under the coop pen should be frequently cleaned of droppings. The coop houses need cleaning about twice a week while the chicks are small. As soon as the chicks are so large that one night's use of the coop leaves it *dirty*, coops should be cleaned daily.

If the coop floors become damp, and there is not sunshine to dry them, a few handfuls of dry chaff, or a little dry road dust or coal ashes, should be spread over them.

252. Making Hens Lay While Brooding Chicks, and keeping them brooding chicks after commencing to lay, relieves the poultry keeper at the same time of two of the most objectionable features of the natural method. Generally the hens wean their chicks shortly after beginning to lay. If they continue brooding the chicks they rarely lay. In coops with roomy pens the hens can be got to laying in about a fortnight after the chicks are hatched, and will continue laying and brooding the chicks as long as is desirable. The hens are put in laying condition by being fed only three times a day, instead of five or six times, as when fed with the chicks; all but three of the feeds

given the chicks being placed away from the coops out of the reach of the hens. Then after the hen has laid for a few days, she stops clucking to the chicks; but as hen and chicks use the same coop, she cannot help brooding them. Often hens will go broody while laying in the coops, and after sitting on the floor for a few days come out as attentive to the old brood as when it was hatched. Not one hen in fifty will drive her chicks from her after she begins laying if she has no chance to associate with other fowls.

THE ARTIFICIAL METHOD.

253. Remarks.—The circumstances to which this method is best adapted, the choice and placing of incubators, and the different arrangements for brooding, were considered in ¶ 60, 61, and ¶ 45—48. The use of machines to take the place of hens does not relieve the operator of the necessity of giving continuous close attention to the details of incubation. On the contrary, his work becomes, in a way, more exacting. Machines do not run themselves, nor can a child run them. Purchasers of incubators and brooders get with their machines the manufacturers' directions for running them. These are not always fully adequate; they cannot apply exactly in all cases; there is always something left to the judgment of the operator. More new operators, however, make mistakes in disregarding or misinterpreting instructions than in following them too closely. Radical changes from prescribed methods are almost certain to be wrong. In departing from instructions—(a course to be taken only when he is fully convinced of its necessity, and has a clear idea of what he expects to accomplish by the change)—the operator should feel his way as cautiously as one balancing scales when weighing out a costly article.

While there are differences in the methods of running different machines, and like machines in different places, there are certain general facts of universal application, and it is by these that the operator must be guided in adjusting instructions to suit his circumstances. In the following paragraphs the statements of noted experts and authorities have been arranged to give in condensed form the latest and best opinions and advices on the principal points in artificial hatching and brooding.*

254. The Care of the Lamp.—

“The lamp should be trimmed every day. I prefer morning to any other time. The charred portion of the wick can be cut off with a pocket knife. Turn the wick down just a little, to make sure there is no sound wick above the burner tube. Then place the heel of the knife on a level with the top of the tube, and draw the full length of the blade while crossing the tube. This will make a clean cut. Be very careful to hold the knife

* NOTE.—Most of the statements credited to Mr. Cyphers, in subsequent paragraphs, are from “Incubation and Its Natural Laws.” Those credited to Mr. McPetridge, are from “Poultry.” Others are from contributed articles in *Farm-Poultry*, and from earlier books by Mr. Boyer, in this series.

at a true level, so that one cut will do. Then turn wick down so as to preserve its smoothness while cleaning the tubes. Wipe all bits of loose charred wick off. Then with a small piece of sandpaper make the burner bright. The sandpaper should be very fine, so as not to scar the burner. * * *

"Always wipe all oil from the top of the lamp. Never fill quite full. Now and then lift the screen that is around the burner, and thoroughly clean all dust from it. Should the light flicker, see if the screen is not filled up with dust. *The dust absorbs oil from the wick, and should the burner ever get hot enough to form gas it will explode.* * * *

"It is a good plan to turn on a low flame at first after trimming, and in the course of twenty minutes go back and see if the flame is sufficient; if not it can then be safely turned to the desired point. Remember that the flame increases, instead of diminishing, after being trimmed. This alone causes serious trouble sometimes, as some operators when they have trimmed their lamps turn the flame on full, thus heating the burner, and increasing the flame till the lamp begins to smoke, and the chimney fills with soot. As a consequence the lamp goes out. * * *

"The lamp should have flame enough at all times to keep the regulator in operation, but not to excess. Keep all draft from the lamp. The flame should be steady, and should never 'flick up.'" (McFetridge).

255. Temperature.—

"The bulb of the thermometer should be placed on a fertile egg, and its temperature maintained as nearly uniform as possible at 102 degrees during warm weather, and 102 1-2 degrees during the colder. * * * Eggs will stand considerable variation in temperature before the lives of the germs are destroyed. During the earlier stages of incubation the development will proceed slowly under a temperature of 98 or 99 degrees; no more dying, if as many, as when incubating at a temperature of 101; and if the heat is gradually raised the chicks grow quite rapidly during the last stages, and are excluded on time. A high temperature during earlier stages of incubation, however, is usually fatal. * * * After the eleventh day a temperature of 110 or 112 degrees, if not too prolonged, is not necessarily fatal. The greatest excess of heat can probably be withstood after the sixteenth day." (Cyphers).

"If the egg chamber is 104 or 106 degrees, which is the extreme limit without injury to the embryo, taking the temperature from dead eggs, the heat of the live ones may be as high as 110 or 112 degrees. If the temperature is taken from the eggs (which is the only proper method) the heat should be either 102 or 103 degrees at the start, and never exceed 105 degrees — 106 being the extreme limit of safety. Eggs which have been heated to 110 degrees may hatch out, but nine times out of ten the chicks are not worth raising." (Campbell).

"When a maker tells you his incubator is self-regulating, and will hold the correct temperature, he does not mean it will do your thinking for you, predict weather changes, etc. When he tells you to keep the temperature at a certain degree, you are certainly making a mistake and wasting your energies if they are devoted to preventing the interior of the egg chamber showing any variation from the degree mentioned. A good regulator is one which maintains a proper equipoise, and if from any cause whatever the interior temperature changes, it will automatically and gradually bring the temperature back to the proper point without permitting it to reach a dangerous point on either side of the hatching degree. A very little patience, and a knowledge of the fact that a fluctuation of several degrees, (if not too long maintained), will not injure the hatch in the least, will save you a great deal of annoyance on that score." (Homan).

"If at any time before the tenth day you find the thermometer registering 101 1-2 or 102 degrees, say in three hours after you have attended to the machine, it is all right.

Don't try to force the temperature up, as it will incline to raise rather than lower, unless the room in which you have the machine is very cold; but on the contrary, if the machine goes up to 103 degrees, and is going over that point, you will have to adjust the regulator *a little*." (McFetridge).

256. Ventilation and Moisture.—The egg chamber requires to be ventilated, that the gases generated in the eggs may be promptly thrown off. The currents of air created by ventilation may cause a more rapid evaporation of the fluids of the egg than takes place in natural incubation. Some operators use no moisture, some none until the seventeenth or eighteenth day, some *a little* throughout the hatch. The principle upon which the application of moisture depends is thus lucidly explained by Cyphers :

"Evaporation from the egg must be held at such a point that the fluids in the embryonic structures are ample to keep the membranes moist up to the time of exclusion, and the rate of evaporation is not the same under any two degrees of temperature. Eggs may be successfully incubated under a temperature that will exclude the chick by the beginning of the nineteenth day, or under one that will not exclude the chick until the twenty-second. The most vigorous chicks will be produced when the eggs are incubated under a temperature that will ripen the embryo by the close of the twentieth day; and any variation from this temperature will proportionately affect the vitality of the chicks and lower the percentage of the hatch. If we have a rate of evaporation to balance the temperature for a twenty-day exclusion, this rate of evaporation will not answer for a nineteen or a twenty-one-day — there being too great an amount of evaporation for a nineteen-day, and too little for a twenty-one-day. In neither case will many of the eggs hatch, but if we supply more humidity (the rate of movement of the air remaining the same) for a nineteen-day, and less for a twenty-one-day exclusion, we will have a chance for a fair hatch. If we have a degree of humidity to balance a twenty-day exclusion, and then raise or lower the temperature half a degree, it will injuriously affect the hatch, while a greater variation will ruin it. A constant variation of a degree in temperature will have no injurious effect, but if the temperature is permanently raised or lowered a degree, the atmospheric conditions for a twenty-day exclusion will not answer.

"It has been universally believed that evaporation from the eggs could only be controlled by controlling the humidity of the air in the hatching chamber. The humidity of the air is but one controlling factor, however, as with the same degree of humidity evaporation will be slow or rapid according to the rate of movement of the air, while it is not the same under any two degrees of temperature; and the constant variation in these two factors is the cause of the extremely varying results. With a due appreciation of these facts, artificial incubation should be more successfully prosecuted in the future than it has been in the past.

"Evaporation is mainly influenced by the rate of movement of the air within the hatching chamber, and secondarily by the degree of humidity. The rate of movement of the air is controlled by the area and location of the ventilating openings and temperature of the outer atmosphere. The degree of humidity cannot be maintained constant when maintaining a constant movement of the air, and it is not necessary that it should be. The first consideration is to secure a constant rate of movement, and then keep the air from becoming too dry. This is practically all that is necessary in supplying humidity when the rate of movement of the air is maintained constant."

Cyphers' rules for ventilating, applying specially to bottom ventilation, will not be given here. His method is to adjust the ventilation to keep the air

pure, then ascertain by experiment the amount of moisture needed to maintain proper evaporation. The simplest method of determining the exact quantity of moisture necessary is by testing the eggs. According to Boyer :

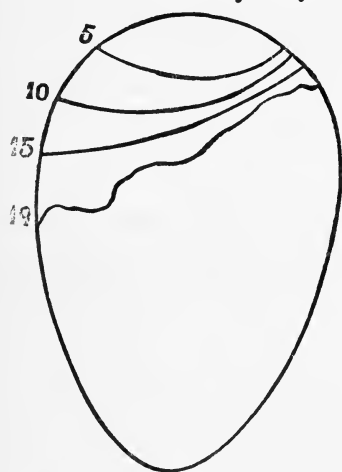

Fig. 79. Diagram Showing Correct Proportions of Air Space at Different Stages of Incubation.

(By courtesy of Prairie State Incu. Co.)

When turning the eggs during cold weather it should be done as quickly as possible, so that eggs and chamber lose but little warmth. The position of the trays should be shifted at least once a day, so as to equalize the heat, as in no large machine can the eggs be heated sufficiently near a uniform temperature to warrant leaving them in the same relative position throughout the hatch."—(Cyphers).

258. Cooling, or Airing, the Eggs.—Some of the highest authorities disagree on this point. The disagreement when analyzed, seems to be more a matter of form than of fact. Cyphers maintains that cooling is unnecessary, and seems to leave the reader to infer that it is objectionable. Campbell and McFetridge, while admitting that good hatches may be made without cooling the eggs, assert that better, more vigorous chicks are hatched when the eggs are properly aired. Campbell's rule for airing is: "None at all in cold weather; a great deal in hot weather, with variations to suit between." The directions for cooling given by McFetridge are :

WITH A HOT WATER MACHINE.—Commence to cool on the fourth day. Keep them out for a few minutes only at first. Always close the doors of a hot water machine, and cool the eggs outside. (If the doors of a hot water machine are left open, the water in the tank, which is the source of heat, is cooled). Do this every morning. Toward the last part of the hatch,—about the seventeenth day,—let them cool twenty minutes with the temperature of the room about 60 degrees.†

* NOTE.—Some operators do not begin turning until after the fourth day, but all authorities are agreed as to the necessity of turning from that time up to the nineteenth day, and that after the nineteenth day they should not be turned.

† NOTE.—As to the rate at which eggs will cool, Cyphers says:—"Under the influence of an atmosphere

"The air cell on the fifth day should measure about a quarter of an inch; on the tenth day, a half an inch; on the fifteenth day, about five-eighths of an inch; and about three-quarters of an inch on the nineteenth day,—the measurement taken in the middle of the egg. Such air cells indicate the proper amount of moisture; if less than that, too much moisture is given; if more, there is a lack of moisture."

257. Turning the Eggs.—

"The eggs should be turned twice a day up to the nineteenth day.* If this is not done, many of the germs will dry fast to the shell during the early stages, owing to the influence of a high temperature and the breaking up of the arrangement of the albumen, which then allows the germ to be pressed upward with some force. * * *

When the egg is not turned during the later stages of incubation, the embryo does not attain a natural position, and has little chance of being excluded.

WITH A HOT AIR MACHINE.—Cool the eggs by leaving the doors open with the eggs in the machine. Never cool below 85 degrees. Don't cool down to 85 degrees every time—in general to 90 or 92 degrees. * * * With the hot air machine I cool the eggs in the evening; and in a room where the temperature is about 60 degrees, on the sixteenth day and after, leave the door open as long as twenty minutes. Sometimes on the nineteenth day I leave the door open for nearly an hour. * * The proper time to cool eggs is when they are turned. In cooling a hot air machine, say for instance, twenty minutes, always open the door for ten minutes before and ten minutes after turning.

Testing Eggs—see ¶ 239.

259. When the Chicks are Hatching.—Instructions which state that a machine is to be kept closed while a hatch is in progress, are not to be understood as meaning that under no circumstances is the door to be opened;—only that the door is not to be opened unnecessarily—out of mere idle curiosity. Most machines have glass doors, through which the progress of the hatch may be watched, and the need, if such exist, of intervention from the operator, be discovered. What to do when chicks are hatching, is thus briefly and fully stated by Campbell:

“To get out the largest possible number of chicks, I wait until quite a lot of the shells are pipped; then I open the machine, and as rapidly as possible turn all the pips up, and place the eggs as close to the door as possible. Those which pip in the air cell, are safe; those which pip below, very often choke at once if not turned up; prompt turning up will save most of them. If the weather is cold this turning up process is done only twice; if hot, it can be done as often as desired. Then when they begin to come out keep an eye on them, and all that can turn around and break through both shell and membrane will get out best if let alone. Those which turn and do not break through every time they move, are very apt to smother. All such need help by simply pulling off the top part of the shell to give them air, and then let them come out. This must never be done until the chick is struggling to get out; neither must the trays be pulled out. Open the door and reach in, and work as quickly as possible. * * * Many operators make mistakes in removing the chicks from the egg chamber. If the day is hot and close the chicks will suffer very much after they become dry if too many are out at once. If they are all removed in a cold day the heat will drop too suddenly for what are still to come out. My rule is to remove them as soon as dry if they pant; but if it is cold I only remove a few at a time, as they become too much crowded for comfort.”

260. Brooding Young Chicks.—It is often said that hatching chicks is comparatively easy; to successfully rear them, is the difficult thing. There might be less seeming foundation in fact for this statement if a larger per cent of the chicks hatched artificially were really *fit* to live when taken from the machine. There are chickens and chickens.

The chicks are generally left in the incubators for from fifteen to twenty-four hours after hatching. They are then removed to brooders, as described in ¶ 46—48. Points on feeding brooder chicks are given in ¶ 146, 16—20.

temperature of 65 degrees, the eggs, during the early stages of incubation, will lose one degree each two minutes. Under an atmospheric temperature of 35 degrees, they will lose more than a degree a minute. In the latter stage of incubation, when the egg has in itself a source of heat, the rate of loss is lower, and consequently the egg cools more slowly in a given temperature.”

The impression is gaining ground among experts that the most important thing in brooding chicks, is the temperature; that a wrong temperature has been responsible for many troubles attributed to food or other causes. The mistake most often made has been, keeping the brooders too warm. On this point Boyer says:

“Begin the heat at 90 degrees, and keep it as near that as possible for the first week or ten days. Then gradually reduce until (after the chicks are removed to the large brooder) they become accustomed to a temperature of 70 degrees, which should be when about three weeks of age. What a mistake to begin at 100 degrees, and thus compel the little ones to endure torture, instead of comfort. This high temperature is what makes weak and delicate chicks. * * * Thermometers can and should be used to determine the heat; but after the chicks are made to ‘feel at home,’ a better sign that all is well is the manner in which the chicks act. If, when closing up the house for the night, it will be seen that the little ones are stretched out on their brooder floor, with their bills buried in the sand, we know that nothing more can be done for them; everything is right. If, on the other hand, they crowd up together, unsettled, there is not enough warmth. Or, if they sit with their mouths open, the heat is too great.”

Brooder chicks must be confined more closely than chicks with hens, but should still have fresh air and outdoor exercise, especially if they are to be reared for stock birds.

The brooder house, of whatever style, must be ventilated. In this the same principles apply as in ventilating houses for adult fowls, with the difference that the amount of cold air admitted to the house must be very much less, because it is necessary to keep the house for young chicks warmer. The rule in this, as in determining the temperature in nursery brooders and under hovers, must be the condition and conduct of the chicks — the house must be kept comfortable for them to run about in, and warm enough to keep the temperature under the hovers up to the required degree.

261. Preventing the Common Ailments of Chicks.—The ailments most common to young chicks under both systems of management, are “bowel trouble,” “cramps,” “roup,” “drooping wings,” which terms cover a multitude of greater and lesser ills. Sometimes the real origin of a trouble is in the condition of the parent stock. Sometimes the keeper is directly at fault. Often a poultryman uses a *dangerous* diet or method for years without bad results — if his treatment is on the whole good; but eventually it is going to cause trouble. When “bowel trouble,”* “roup,” or “drooping wings” prevail in a flock in a mild form, they should yield to good care, proper food, and simple remedies. If they have become acute, it is better to kill chicks affected — though in doing so the entire lot be cleaned out.

“BOWEL TROUBLE” is due to sloppy foods, some kinds of rich foods, chills, colds, over-heating, etc. It can be checked in the beginning by keeping the chicks warm — *not hot* — in dry quarters, at a uniform temperature, giving

*NOTE.—For more correct descriptions of all these complaints, see the chapter on diseases.

rather dry food, and boiled milk to drink. The chicks ought not to be allowed to reach the stage of being "gummed up behind" before treatment is begun; nor should the treatment be carried so far that it will bring on the opposite evil — constipation. Even in the best lots there will be from time to time isolated cases of this; but with right conditions it cannot become epidemic.

"ROUP," colds, and kindred ailments, are due to dampness, exposure, filthy quarters, over-crowding. Wrong conditions should be corrected, and such remedies used as are prescribed for hens in ¶ 174.

"CRAMPS" are often nothing more than the death struggles of chicks that have been ailing for some time. The cramps which kill healthy chicks in a short time are mostly caused by drinking too heartily of very cold water, by choking, or by extreme heat of the sun when the chicks are not hardened to it.

"DROOPING WINGS" are due to general debility, which may result from any one, or from several of a great variety of causes. The chick simply lacks strength to hold itself together properly, *erect* would be said of a human being. The fault is most noticeable in Leghorn chicks, but is common in poor conditioned chicks of all varieties. Prevention must begin in the condition of the parents, and continue in the management of the chicks. Proper food and care will correct the trouble if not of too long standing. Chicks which have been going about long with drooping wings, are not worth trying to cure or rear.

262. Keeping the Chicks Growing.—Success with chicks requires that they be kept constantly growing from the shell to maturity. The slightest check is a loss that cannot be made good. Growing chicks is exacting work. One must get up early in the morning (unless he adopts the method of the breeder who said it was not necessary to get up early, if one sat up late enough planning how to get the work done without early rising). The beginner cannot expect to do uniformly good work. With the best of instruction, advice, and attention, mistakes will sometimes occur. To do everything *as* and *when* it ought to be done, requires greater familiarity with the work than any one can reach in one or two seasons.

263. Weaning Chicks.—No definite age can be given as the right one at which to wean chicks. The condition of the stock and of the weather must guide. Chicks should remain with hens or in brooders as long as they need or are likely to need heat in addition to that generated in their own bodies. Early in the season they need some heat until ten or twelve weeks old. They may not die without it, but exposure to a temperature so low that they huddle together, will always retard growth. Chicks reared by hens may be left in the coops, only the hen being removed, as long as they are not too crowded at night. In coops as shown in Fig. 44, they will generally roost on top of the coop or lie outside on the ground as soon as it becomes uncomfortable inside. One of the best methods of handling weaned chicks is in coops of the

style shown in Fig. 46. In these they can be colonized until the time comes for putting them into winter quarters. When removed to these coops, they should be confined to, and fed in them, for a few days, until they will return to them when let out. Directions for feeding are giving in ¶ 146, 21—28. Beyond keeping the coops clean, supplying food and water regularly, closing the coops at night, and opening them in the morning, the chicks now should need no care—even the closing and opening of coops may be omitted if there is no danger of their being molested at night.

264. Teaching Chicks to Roost.—Chicks of Leghorn and other light weight breeds will begin roosting of their own accord when six or eight weeks old. Chicks of the heavier breeds often do not roost until taught to do so by the keeper. The general practice is to keep chicks of medium sized breeds on the floor until about three months old, and chicks of the largest breeds for a month or two longer. Unless the floor is kept clean and the chicks well bedded, it is better to teach all to roost early. If suitable wide roosts are used there is no more danger of crooked breasts than on the floor, and many poultrymen think the general advantages of getting the youngsters on the roosts where they cannot crowd and huddle in corners, and are not soiled by their own and each other's droppings, more than compensate for what keel bones are twisted.

Often chicks can be taught to roost by putting in low roosts and placing with them one or two old hens or chicks that are in the habit of roosting. If this plan cannot be tried, or does not work, a wide board should be placed close to the wall, about a foot from the ground, and the chicks placed on it after dark, night after night, until they will go to it of their own accord. After that, a wide roost the regulation distance from the wall, may be substituted for the board.

265. Separating the Sexes.—When the chicks are weaned the cockerels and pullets of the more precocious breeds should be separated. The slow maturing breeds may be allowed to run together for four or five months if it is not convenient to keep them apart; but in any case the separation should be made at a relatively early age—before the cockerels begin to annoy the pullets. If the young males can be put where they never see a fowl of the opposite sex, they live together more peaceably, and develop better. There is not often any difficulty in distinguishing the sexes when the time comes for separating them. Once in a while there is a cockerel which looks more like a female than a male at that age; but such a bird is not likely to annoy the pullets, and if put with the cockerels may be buffeted about a great deal.

266. Rearing Chicks in Confinement.—Chicks reared specially for market are always kept quite closely confined, that all food eaten may go to the production of flesh; but there is a feeling among poultry raisers that stock

chicks should be given range while growing. The bald fact that chicks are confined, or not confined, counts for nothing either way. Unquestionably the most favorable condition for obtaining the best development at least expense, is found where the chicks have a range which furnishes them a considerable part of their food — all green food and insect food, and seeds in variety — without their foraging so far that too much of what is eaten is expended in muscular energy. This condition depends on quite small flocks being widely separated, and is found much less often than is generally supposed; for most people who give their chicks range expect them to forage over a considerable area, and, indeed, compel them to do so; sometimes intentionally by withholding food; sometimes unintentionally by neglecting to give a variety of food. The method of colonizing the growing stock generally gives range only in name, for there are so many placed on so small an area (and often so little forage on the ground) that the amount of food each chick gets by foraging is insignificant. It is, therefore, necessary to feed quite as much and as often as if they were confined in bare yards. The real advantage of the method is its cheapness and convenience, not the superiority of the stock produced by it. The coops cost little. No fences are used. The chicks are reared outside of the winter quarters (occupied by adult stock the year round) and thus the old stock is not crowded out at sacrifice prices to make room for the young ones — and can be worked off seasonably, gradually, and profitably.

Not all poultry keepers are so situated that they can give their young stock range even by colonizing. This need not deter them from rearing chicks, nor need they think it impossible to rear as good chicks as those who give the youngsters range. Just as good chicks can be reared in confinement (rather close confinement, at that) — as on the best range; — if the keeper will avoid crowding, keep them free from lice, keep their quarters clean, feed a liberal well balanced ration judiciously, and give opportunity for such exercise as is given laying hens and breeding stock in confinement — but less of it compulsory. Indeed, when the stock runs well up in the hundreds, confinement is a much better plan than colonizing with the flocks so near together that they can — and consequently do — feed as one flock; for in large flocks the chicks are crowded, (crowd each other), no matter how much room they have. The question of giving the growing stock range is just a question of opportunity and convenience. If one can give them the right kind of range, that is a very great advantage *to him*. If one must keep them confined, he is handicapped to some extent, but not so badly that he cannot get results as good as the best, — only he must work harder for it.

267. Culling the Growing Stock. — In breeding poultry for market exclusively, culling proper is not practiced. The chicks are merely sorted, the marketable ones taken as needed — the others left until better grown. In breeding laying stock, a very few of the choicest cockerels may be reserved for breeding purposes; the rest should be marketed at the age when they will bring most profit. The culling of the pullets extends only to marketing poorly

developed specimens and those showing defects likely to diminish their future usefulness. In breeding thoroughbred stock, proper culling is of great importance. It is not often that a poultryman has such superabundance of room that it will pay him to keep inferior specimens until grown. The economic aspects of the question will be considered in the next chapter. Here comment will be limited to suggestions as to the selection of the poorer specimens.

There are five classes of defects to be considered in culling : —

(1). **DEFORMITIES**, which are constitutional and ineradicable. These are not always noticeable in very young chicks, and those that are noticed then may be of such character that they do not affect table qualities. Chicks so deformed, should be allowed to live until large enough to be eaten, and no longer.

(2). **GENERAL WEAKNESS AND WORTHLESSNESS**, which may be constitutional, or may be due to mismanagement affecting particular chicks more than others. These chicks are simply spoiled in the growing. It is useless to try to make good stock of them.

(3). **BLEMISHES (according to the Standard) WHICH ARE IRREMIEDIABLE.** Of this class are such faults as feathered legs on chicks of clean legged breeds, scantily feathered legs in full feathered varieties, color faults that will not be outgrown, radical departures from typical shape. Birds thus defective are not worth keeping for stock birds; but many of the pullets may be reserved for layers *if there is room for them*, and if they can be used or sold as such; otherwise, the quicker they go to market the more profitable they are.

(4). **BLEMISHES WHICH MAY BE OUTGROWN**—such color defects as white in the flights of black chicks, red in white ear lobes,—or the reverse,—poor muscular development on big framed chicks, scant plumage on chicks with good bone and muscle, etc.

(5). **FAULTS WHICH (to the uneducated taste) APPEAR TO BE EXCELLENCIES.** The most conspicuous example of this kind,—really the only one of importance,—is premature attainment of the symmetry of a mature fowl. This fault is frequently met in all varieties. It is an accompaniment of precocity. The symmetrical chicks are at first much more attractive than their less precocious companions, and the novice is apt to think he has a “world beater,” when he has only a miserable runt, as he finds when all are matured.

The beginner cannot practice very close culling, for it requires a few years of watching chicks as they grow, and noting the changes as they approach maturity, to enable him to know the defects which will be outgrown, and those which will increase. Each year, however, he should cull closer and closer, both in selecting for the breeding yard, and in handling the growing stock.

268. Caponizing.—The question of the profitableness of caponizing cannot be settled for all classes of poultry keepers, in all sections of the country, on the same basis. Such matters have a way of gradually adjusting themselves to conditions. There can be no doubt that the practice of caponizing is growing. It seems at present equally clear that caponizing is being found profitable mostly in sections where grain is cheap, and is gaining favor more among farmers than among poultrymen. The reasons for this seem clear. The special poultry farmer, with limited accommodations, and under the necessity of buying food for his stock, cannot afford to keep on hand any considerable quantity of stock that is not *earning* something to swell his current income. He makes more by devoting his space and time to laying hens than he could by buying grain to feed to capons; but with the general farmer it is otherwise. He has not the special facilities needed to handle many early chicks, and therefore cannot always get his surplus cockerels to market while they will bring good prices as broilers or soft roasters. The food consumed by a fowl costs him comparatively little, even when he feeds salable grain. If instead of marketing his cockerels when, at five or six pounds each, they would bring him only a few dollars a dozen, he can caponize them, and with twenty or thirty cents worth of corn, (or, even using a more costly grain), he can produce capons which will weigh ten or twelve pounds when the market is at its best, and may then net him twelve to sixteen cents a pound, he can make cockerels every bit as profitable as pullets.

The demand for nice large capons is constantly increasing—small ones are salable, but do not bring the best prices. The supply now comes chiefly from Indiana, Illinois, and Iowa,—all great grain growing and poultry producing states.

The operation of caponizing is not particularly difficult. To perform it, instruments specially made for the purpose are required. These can be found advertised in poultry journals, and as full instructions for operating, and for the care of the birds before and after the operation, are furnished with each set of instruments, the details of the operation need not be given here. The operation, of course, requires skill, which comes only with practice. The per cent of loss of birds caponized by a skilled operator, is small. The large breeds make the best capons. Chicks not capable of making large growth are hardly worth caponizing. The operation is performed at two or three months—preferably before the comb begins to develop.

CHAPTER XII.

Selling Poultry and Eggs.

SELLING MARKET EGGS AND TABLE POULTRY.

269. The Poultry Crop Does Not Move Itself.—The saying: “Good poultry sells itself,” originated among the marketmen, the *middlemen*. It may be true for dealers who display their wares daily in public places. It is not always true for the ordinary producer:—not without qualifications, and, especially, not in the beginning. To sell to best advantage; to dispose of different products at just the right time; to get the best possible returns for everything produced, usually requires thought, foresight, and some energetic hustling for custom. The instances where a poultry keeper’s product, however small, is well sold with little effort on his part, are comparatively rare. Even when his surplus is sold *at the door*, he needs to give some thought to market conditions, and keep informed of fluctuations in prices; for however honest the buyer may be, the interests of buyer and seller in the same transaction cannot be identical, and the buyer, as is natural and right, looks after his own interest *first*.

270. From Producer to Consumer.—There are several ways of disposing of goods. They may go from producer to consumer direct, at first hand; or, by longer and more devious channels, through many hands. The farmers’ wives sell their eggs and fowls to collectors going about the country with wagons, or trade them for supplies at the grocery store or meat market, or sell them to families in the nearest town. The keepers of a few dozen hens sell their small surpluses to neighbors, or barter them at the stores. The business poultryman sells direct to private families, or to hotels, or to retailers who want choice stock; or, if he has not succeeded in getting such customers for his products, or finds it more to his interest to give all his time to producing, and let others sell for him—for some good poultrymen are very poor salesmen; and sometimes a commission house can handle a poultryman’s product more profitably for him than he can for himself,—ships all his stuff to a commission merchant. The producer has to settle for himself which way of disposing of goods will pay him best. It is a question of local market conditions, personal circumstances, and the kind of business done,—whether large or small, and what special combination of the different branches of poultry culture has been made.

271. Good Stock is Sometimes Hard to Sell.—This, those who have something to sell only at irregular intervals soon find out. A man may go into the best market in the world with a first class article in good demand at the time, and experience some difficulty in getting rid of it; because while the supply as a whole is unequal to the demand, very many buyers will have all they need, and no sale will be made until a consumer is found who has not been supplied. One condition of selling to the best trade is to be able to supply stuff regularly. The producer who can do that, having sold one lot that gives satisfaction, finds that this sale brings him a standing order.

272. When to Sell Eggs.—As a rule, producers realize most on eggs by selling them while strictly fresh. Not one in a thousand is in a position to preserve eggs, or could make anything by doing so if he were. The profit on preserved eggs is for those able to handle them in large quantities, by the best cold storage methods. Perhaps the only time it is to the producer's interest to hold eggs for higher prices, is when prices are rapidly going up. Then it may be worth while to hold any not needed for a regular trade for a week or so—not so long that they cannot be honestly sold as fresh eggs—to get the few cents per dozen he would gain by holding them. One who is supplying a regular trade, especially family trade, should give his customers all they want at current prices, regardless of the few dollars possible profit to be made by holding them back. It pays to favor good customers a little when eggs are high. There comes a season, every year, when eggs are plenty and cheap, and what favors are going come from the customer.

273. How Eggs are Sent to Market.—Eggs in quantity are shipped mostly in thirty-dozen cases, (though thirty-six dozen cases are sometime used). Such cases are put up for sale in knock-down bundles. There are several styles. The cheaper ones, with pasteboard fillers, are most used. For small lots of eggs, half-cases, or cases holding ten dozen each, are often used. For the family trade, which takes only two or three dozen eggs at a time, pasteboard boxes of suitable sizes are desirable. Such boxes can be purchased of paper box manufacturers, or of dealers in poultrymen's supplies. They are very convenient for delivering eggs from wagons; are sometimes used to deliver market eggs by express, though the proportion of transportation to value on such small packages is too large for the practice to become general. However sold, eggs should be *clean*, and *assorted* according to size and color. One should never attempt to work off the small eggs with the others. If there are more than can be used at home, they should be sold for what they are—cull eggs. Everywhere medium to large eggs sell best. The preferences of different localities for eggs of different colors, were given in ¶ 101.

274. Shipping Eggs to Commission Merchants.—There are many

poultry keepers, farmers especially, who could ship one or more cases of eggs weekly, and would like to send them to one of the larger markets, and get a little better price than they can from local buyers, if they could sell through a reliable commission house. Small shippers, who cannot make personal investigation of the standing of the parties to whom they consign goods, are inclined to be shy of commission merchants; and not without reason, for they and their neighbors have lost again and again through commission merchants of the here today and there tomorrow variety, who offer them big inducements to ship goods, and then fail to make returns on shipments received; but there are plenty of reliable commission merchants, and in all the large cities there are firms well known by reputation to all readers of poultry papers, to which the small shipper may send his goods with full confidence that he will be treated fairly, and receive every cent due him. Nearly always the large houses are glad to get even small shipments of first class stock, if they are sent regularly — irregular consignments they do not care so much about. In establishing relations with such houses, the best method is to send a sample shipment, at the same time stating the quantity that could be shipped regularly. The best time to begin doing business with these firms is when eggs are not very plentiful. Having eggs to ship when eggs are scarce is, in the eyes of the commission man, one of the best recommendations the shipper can have. He feels from the first that this man is to be depended on for regular shipments; while he is always uncertain about those who are ready to begin when eggs are plenty, for his experience has been that in a very short time most of them fail him.

275. When to Sell Poultry.—In producing poultry specially for market, one ought to aim to have as much as possible of the product marketable when prices are best, and to have everything sold before prices reach a point too low for profit. There is some demand for poultry throughout the year; but the demand for *chickens* is so much lighter between August and February than during the remainder of the year, that the producer's profit, on stuff sold in the fall and early winter, (except on extra choice stock), is small.

The *broiler season* is from February to September, prices being good throughout that period, and at their best in April and May. Many of the broilers shipped in September, October, and November, are put in cold storage and held until the beginning of the next season. The market for roasters is most active throughout December, January, and February; but better prices are obtained in May, June, and July, when, though the demand is more limited, the supply is much more limited. Capons are in demand from December to May, inclusive, and bring best prices at the close of the season.

The egg farmer marketing his cockerels and cull pullets, and the breeder of pure-bred poultry disposing of his culls, can hardly — if their chicks are seasonably hatched *for their purposes* — get the top prices for much of what

poultry they have to market, but still can get very good prices. One of the worst mistakes in marketing poultry is made by those who hold their stuff until cold weather, selling it about the holiday season, after having fed it several months longer, for less than it would have brought in July and August. That practice is a relic of a by-gone age is poultry culture. If it will not pay to caponize the cockerels they should be sold as well as possible while the prices are still fairly good.

276. What the Market Wants, and What It Does Not Want.—

“*Now by first class stock we mean well fattened, so that the breast bone does not stick out like the keel to a boat; yellow meated, well dressed, cleanly picked, not roughed all up or torn, no pin-feathers left in, nor the legs and feet left dirty.* Such stock, if packed to present a neat and inviting appearance, will command good prices nine or ten months in the year.”

“*We call particular attention to the fact that our quotations are for first quality, quick grown, straight breasted, yellow meated, plump stock.* Stunted chickens several months (too) old, hump-backed, white meated, and crooked breasted, are not wanted. We have very little call for such stock at any price * * * and the returns made for it will be discouraging to the shipper.” (W. H. Rudd, Son & Co.’s circular).

277. Sizes and Weights Preferred.—*Broilers* should weigh from one and one-fourth to two pounds each, the lighter weights being in demand from January to July, the heavier for the remainder of the year. *Broilers* weighing three-fourths of a pound each, called “squab broilers,” have for some time been used in parts of Europe, to take the place of small game, and there is a growing, though still limited, demand for them in this country. They are in demand only through January, February, and the early part of March. *Roasters* range from five pounds per pair early in the season to ten and twelve pounds per pair in the fall and early winter; quality being equal, the largest birds bring the best prices per pound.

In *capons* birds weighing about six pounds each command readiest sale; but larger birds, nine, ten pounds and more, bring better prices.

Hens weighing four to five pounds each, sell better than either larger or smaller stock.

N. B.—The above weights are all for dressed poultry.

278. Selling Poultry Through Commission Merchants. — The large commission houses in the cities furnish shippers full instructions for dressing, packing, and shipping poultry to their market, and also keep large shippers informed of the fluctuations in prices and condition of the market. The requirements for different markets vary; some cities use proportionately much more live poultry than others; capons bring relatively better prices in some cities than in others, etc. If a poultryman had located with reference

to a particular market, he would, of course, have produced as nearly as he could to meet the demand in that market. When it is a question of one already located finding the best market, he needs to study markets thoroughly, and, perhaps, send trial shipments to several different places before he decides where to sell. Transportation facilities decide the shipping question for many producers.

In shipping to commission houses, in the smaller cities, which do not furnish instructions to shippers; and to provision dealers; and in preparing poultry for special family or hotel trade, the *local* requirements of the leading markets in the vicinity should be observed. It is especially for this class of shippers that complete instructions for marketing are given here.

279. Shipping Live Poultry.—Poultry of all kinds can be shipped alive during about half the year, from April to October, and, for short distance shipments, will net the shipper quite as much as if dressed. In fact, if he is inexpert in preparing fowls for market, good live fowls would bring him more than he would get for the same fowls, poorly dressed. Through the late fall and winter months, when dressed poultry is easily kept, live fowls are not much in demand. Commission men strictly warn their shippers against sending live fowls at winter holiday seasons, as at such times they have to be sold on the market for whatever they will bring, and may not realize enough to pay expenses of transportation and sale.

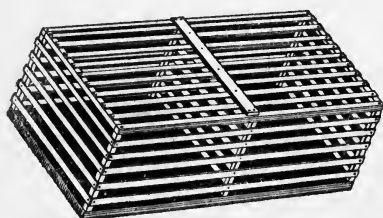

Fig. 80. Slatted Coop for Shipping Live Poultry to Market.

Live fowls are shipped mostly by express, in slatted coops, each holding from one to two dozen grown fowls, and of chickens a larger number, according to size. Overcrowding is to be avoided, both because of its inhumanity, and for economical reasons; it is not right, and it does not pay. Crowded fowls lose in weight, and also in quality of flesh.

280. Dressing Poultry.—There are two methods of dressing poultry: *dry picking*, and *scalding*. The first is used generally in the east, and used everywhere in dressing poultry specially for the best trade in the eastern markets; the second is used generally throughout the west and south, in preparing poultry for the markets of those sections. A few dealers in some of the eastern cities will not receive scalded poultry at all. In some places it is hard to sell, but in most places, even when the dry picked stock is given preference, scalded stock of good quality finds ready sale at satisfactory prices. In western markets scalded stock sells best for the home trade; yet the large commission houses prefer dry picked stock; for, as a very large part of the poultry sent to market must be shipped east to find consumers, the dry picked stock can be handled to best advantage.

281. Fowls Must Fast Before Being Killed—that when killed the crop and intestines may be empty. No food should be given for at least twelve hours previous to killing, and a longer fast—eighteen to twenty-four hours—is desirable.

282. The Killing is Done by Bleeding in the mouth or neck with a sharp knife. (Knives made specially for poultry killing can be procured). It used to be the practice to stun the bird by striking on the head or back with a stick before bleeding. This was discontinued because when stunned the birds did not always bleed properly. Bleeding in the mouth is the method most favored, because the cut is hidden, and thus the carcass is more sightly. As it is the more difficult way, one who is uncertain of his ability to do it right, should bleed in the neck the fowls he kills to sell until by practice on fowls to be used at home, he has become expert in bleeding in the mouth.

The method of making the cut, is thus described by Boyer :—

“The bird's legs are fastened to a stout cord suspended from the ceiling, and a hog-head or barrel is placed underneath to catch the blood and feathers. Then the operator gets in front of the bird, placing it under his left arm; * * runs the knife back in the mouth, and then bringing it a little forward, cuts crosswise, severing an artery. The mouth, during the operation, is held open with the fingers of the left hand. Great care is taken not to cut too much, for fear of the bird dying before the feathers are all removed, in which case it would be difficult to pick.”

All operators do not make the cut in the same way. Cooper says :

“Make a sharp cut *lengthwise* in the mouth, to make them bleed; then a slot upwards, which penetrates the brain.”

McFetridge :

“Have a weight, say two pounds, with hook attached, to fasten in the chicken's lower beak to keep the head steady, and over the barrel. With a sharp knife make a cut *crossing* at the base of the brain inside the mouth; then turn the knife blade and make a deep cut in the roof of the mouth into the brain.”

Novices can take their choice of these methods. Each will settle on that which comes handiest to him.

283. Dry Picking.—In dry picking the feathers are removed while the bird is still alive (though paralyzed). The success of picking by this method depends on removing *all the feathers while the bird is bleeding*. In dressing broilers, the pin-feathers and stubs must be removed afterwards with the fingers and a small knife. When the bird is perfectly clean, the blood is washed from the mouth and throat, and the carcass is placed in cold water, to which a little salt has been added, and allowed to remain there for several hours, until thoroughly cooled. It is then taken from the water and hung up to dry before being packed.

284. Scalding.—In scalding the success of the operation depends on having the water at the right temperature— as near boiling as it can be— and yet not boil,—and getting all the feathers to be removed thoroughly and

quickly wet. If the water is not hot enough the feathers are not loosened, and are removed with difficulty; if it is too hot, the skin is partly cooked, and the carcass when cold is blotched and discolored. The legs are dry picked before scalding. The bird, held by the legs *and head*, that the comb may not be discolored and the eyes shrunk by the scalding water—is plunged into the water several times (*soused*) that the water may thoroughly saturate the feathers. Then the feathers are removed as quickly as possible. When clean, the carcass is plumped by being plunged for a few seconds in very hot water, then, immediately in cold water. In warm weather it should be cooled as described for dry picked fowls, in water; in cold weather it may be hung up to cool.

285. A Few Important Points.—Whichever method is used, the appearance of the carcass is improved by scalding and skinning the feet.

If the skin is torn in picking, it should be sewed up with common white thread.

The general rule is to leave heads on and entrails in, but sometimes fowls shipped in cold weather are headed and drawn—except broilers, which are never sent to market drawn and headed.

In dressing capons the feathers are left on the neck, tail, wings, and thighs.

The object of cooling is to get the animal heat out of the body as quickly as possible. Putrefaction begins very early in a warm carcass.

286. Packing Poultry for Shipment.—Poultry should be packed in boxes or barrels *lined with paper*, but should not be wrapped in paper; nor should straw be used in the packing. The packing should be done in such manner that the carcasses will retain their shape, and will not shift in the package. The method of packing fowls is shown in Fig. 81. Some packers pack broilers also in this way; others pack them with breasts down on the bottom layer, and up on the top layer. Commission men advise shippers to use boxes in preference to barrels for shipping poultry, and recommend using neat boxes of clean, planed lumber, uniform in size, because attractive packages sell better. Boxes should be made of five-eighths inch lumber, and made deep enough

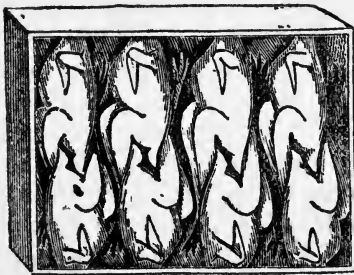

Fig 81. Method of Packing Fowls.
(By courtesy of W. H. Rudd, Son & Co.)

to contain two layers of carcasses. The dimensions of the boxes vary with the sizes of the fowls, and the number to be placed in each. As giving a general idea of the proportions to be observed:—one commission house recommends using boxes 8 x 16 x 22 inches; another, boxes 10 x 20 x 30 inches. Not more than one kind of poultry should be put in a package. The kind and weight of poultry in the package, and full shipping directions, should be marked on it.

287. Packing Iced Poultry in Warm Weather.—

“Leave heads on and entrails in. Strong sound barrels (sugar barrels preferred) are best for ice packing, and the ice should be washed before using. Place a good layer of broken ice on the bottom of the barrel, then a layer of poultry, commencing in the middle and packing in a circle, with heads down, backs up, and feet toward the center; then alternate layers of ice and poultry, filling the barrel to within six inches of the top, taking care to have ice between the poultry and the staves of the barrel; top off with large pieces of ice, and cover the barrel with bagging, (which insures its being kept right side up), and mark with brush or stencil. If shipped from any considerable distance, put an extra large piece of ice on top, and if properly packed, the poultry can be on the road fifty hours without injury; and if heavily iced and shipped in refrigerator car, can safely be four or five days in transit; but even for short distances, it is better to use ice, as poultry, especially if not drawn, packed without it in warm weather, if only for an hour or two, will turn green across the back, and become almost worthless.” (W. H. Rudd, Son & Co.’s instructions to shippers).

288. Shipping Dressed Poultry in Cold Weather. — In cold weather a great deal of dressed poultry is shipped by freight. Shippers are usually advised to send small lots going a considerable distance by express, especially if transfers are to be made en route, because under such conditions small lots are often delayed, and arrive in poor condition. The greater cost of transportation by express is more than offset by the better returns received for the shipment.

289. Hints on Selling Poultry and Eggs to Family Trade. —

Establishing a Route. — A poultryman producing choice goods, can get better prices by selling direct to the best family trade than a provision dealer could get from the same people for the same goods. If located near enough to a large city or town to make regular deliveries, weekly or bi-weekly, one will often find it most profitable to retail his own produce. A good route is not established in a day. Into whatever territory one goes, he finds the field already partially occupied. He has to work for what trade he gets. The quality which most appeals to the largest number of consumers is *cheapness*. The only object a poultryman can have in selling direct to consumers, is to get the highest price obtainable. He finds some customers “ready made;” but while building up trade, his work is largely in the line of educating buyers’ tastes to the point where the cheapness of eggs and poultry no longer appeals to them. This process takes time. The work of building up a good route of desirable customers whose requirements can be calculated to a nicety in advance, who buy freely and pay promptly, is not often completed in less than two or three years.

Regular Deliveries cannot be profitably made oftener than twice a week when poultry products alone are handled; nor is it to the interest of the producer to make them less often. Eggs a week old are too old for this class of trade. Tuesdays and Fridays — the days *before* baking-days — are the best for delivering eggs, — especially if one has more eggs than his established trade takes, and desires to extend his route. Most people — when they want

poultry—want it on Saturday (for Sunday), but not nearly all want it every Saturday—and occasionally they like to vary things by using poultry in the middle of the week. A few customers will take poultry regularly twice a week the year round. A good arrangement is to deliver eggs on Friday, at the same time taking orders for poultry for both Saturday and Tuesday delivery; make a special delivery of poultry on Saturday; and on Tuesday a regular delivery, covering the entire route, of eggs and poultry.

Eggs may be packed in large shipping cases, and counted out as wanted, or put up in small pasteboard boxes made specially for this trade, and often used also by grocers.

Poultry should be dressed the day before delivering. When cool it should be weighed, and a small tag with weight marked on it attached to each carcass. Each order may be separately wrapped in paper, or a covered box can be used for carrying poultry in the wagon, and the fowls delivered unwrapped. (This is the better way, for customers generally like to see their poultry when delivered, and it is easier to keep a damp cloth in the box, and if carcasses are at all soiled wipe them clean as taken out—than to handle them done up in paper).

Fowls should be killed only on order:—except that it is a good plan to have a few extra for possible new customers or for increased orders. Orders should be for so many fowls of definite weights, and fowls that will make these weights should be selected for killing. A fowl shrinks, according to size, about one-fourth to one-half, (or a little over), pound in dressing.

Carcasses should be cooled as thoroughly as if for shipment, that if properly kept the meat may be at its best when used. It is coming to be better understood that fresh killed poultry lacks the flavor and delicacy of properly ripened poultry, and it is to the producer's interest to have the stuff at its best when eaten.

All goods should be sold for cash on delivery, or cash on presentation of monthly bills. A poultryman cannot afford to do a credit business.

Selling the Inferior Stock.—The poultry product is never entirely uniform in quality; there is always some that cannot be sold to the best trade. The producer should aim to get proportionately as good a price for his poorer stock as for his good stock. He cannot afford to let it go for less than the best price obtainable. Paradoxical as the statement may seem, it is none the less true that, while a first class family trade must be built up by selling to that trade only good stock, no small part of the poultryman's profit depends on his success in selling his poorer stock. It is often said that anyone at all can sell good goods, but selling poor goods tests a salesman.

To dispose of *all* his product to *best* advantage, the producer, while catering specially to the best trade, must establish a sort of complementary trade that will take his inferior stock. This trade, by itself, would not be desirable or profitable, but as accessory to the other, it is worth a great many dollars in the course of a year. It does not injure the better trade in the least as

long as all poultry is sold for exactly what it is, and every transaction is open and above board. If one tries to work off poor stock at the price of good, or sells the same grade of stock at several prices—according to what buyers are willing to pay, trouble is sure to come of it.

SELLING BREEDING STOCK AND EGGS FOR HATCHING.

290. Advertising is the first step toward making sales of eggs or stock of pure bred poultry. Without advertising, only a few neighborhood sales can be made. Advertising in local newspapers does not often pay. The consensus of opinion among successful advertisers of poultry, is that advertising in other than poultry papers does not pay, though sometimes advertisements in agricultural papers with good poultry departments, bring good returns.*

How Much to Spend in Advertising—is a perplexing question. It is sometimes said that an advertiser ought to be satisfied for some time if his sales from advertising are paying his advertising bills. Not many people, however, can long afford to pay out good money for advertising which does not result more substantially than that. If advertising is not bringing in substantial returns, the advertiser who is in the business for a living must look for the reason, and find a remedy; for there is no way in which money can be thrown away faster, and with less hope of its ever coming back again, than in advertising wrong.

The first thing for a man to do when placing his advertising on a business basis, is to decide how much he can afford to spend for advertising. If he has income from other sources, it might pay him to spend for advertising in the first season 25%, or even 50%, of what he estimates his produce would bring if fairly well sold; † but if he has no income other than from his poultry, he cannot afford to plan for an expenditure for advertising to exceed 10% of his most judicious estimate of sales resulting from advertising. The amount thus appropriated may seem small; it is the more needful that it be invested wisely. *Slow and sure* is as good a rule now as it was when he began to build, and to buy and breed stock.

The next step is to find out what poultry papers have the best circulation

* NOTE.—Some very notable exceptions to the statement that general advertising does not pay poultrymen, are worthy of mention. There are a few poultrymen who are both extensive breeders of and dealers in poultry at popular prices, and these use the leading magazines, and make it pay.

† NOTE.—Even conservative methods of “counting chickens before they are hatched,” are apt to result in excessive estimates. An expenditure for advertising of 50 per cent of estimated possible sales, would be likely to turn out 100 per cent of the actual sales; but if the advertising appropriation had been made on the basis of 100 per cent of estimated receipts, the poultryman would come out away behind.

in the territory in which one is located. It makes no difference to the advertiser where the paper is published. The circulation is what interests him, and circulation in territory adjacent to him is what he must value, for he cannot at first make more than an occasional sale of birds or eggs to be shipped to a distance.

If it is decided to use a single paper, the wisest move at this stage is to write the business manager of the paper, stating the amount available for advertising, and asking advice in placing the sum most advantageously. Managers of papers of standing and influence willingly give sound advice to advertisers regarding the kind of advertisement to be used, relative amounts of space to be used at different seasons of the year, etc.; and the new advertiser is more likely to be satisfied in the end if he follows the suggestions given, than if he follows his own ideas. If advertising is to be placed in several papers, the same course should be taken for each as has been outlined for one.

If having taken the advice given him, the advertiser does not get the returns he might reasonably expect, he ought not to find fault with the paper as an advertising medium, and change at once. The mere insertion of an advertisement in a good medium does not guarantee sales. There is art in advertising. An advertisement must attract attention. It is not enough to have for sale an article buyers want; one must tell them so in language which attracts favorable notice, without in any way conveying a wrong impression of either the breeder or his stock. Often advertisers complain that their advertisements bring plenty of inquiries, but they make no sales. In that case the fault is usually with the advertiser; either he has so worded an advertisement that it attracts a class of buyers whose orders he cannot fill, or he is unable to sell stock by correspondence. This last is the trouble with a great many who are unsuccessful advertisers. Some people can write letters that will drive custom away as fast as "ads." in a dozen papers bring it to them.

In general, a well worded, well placed advertisement in any poultry paper having a good circulation in his section, will bring a breeder numerous letters of inquiry; and, though he cannot expect every inquiry to result in a sale, if he is prompt in attending to correspondence, writes a fair business letter, and has the stock to justify his advertising, he will get his share of orders. If results are unsatisfactory, he cannot justly find fault with the advertising medium used, unless he finds that its circulation has been misrepresented to him, or his advertisement has not been well placed.

When more than one paper is used, advertisements should be "keyed," a little different address given in the advertisement in each paper.

In addition to and in connection with his advertising in the poultry papers, a breeder of Standard stock should aim to exhibit at at least one poultry show each year. Advertising premiums won is a drawing card. Even though at first one may miss the premiums, as an exhibitor and regular attendant at shows, he has a better standing as a breeder than he would otherwise have.

291. The Breeder's Stationery and Correspondence. —

Circulars. — It is customary for breeders to issue circulars, describing their stock more fully than is possible in an advertisement or convenient in a letter, giving directions for ordering, prices, stating terms, etc. Such a circular is almost a necessity. A few well known breeders who sell stock of exceptional quality do not issue circulars, because sales of stock of that class cannot be made on general descriptions and general statements of prices. The breeder of ordinary stock who has any considerable amount of it to sell, and can fully inform possible purchasers of its merits without issuing a circular, is the exception — the thousandth man. The expense of printing from three to five hundred circulars (which will be enough for the small breeder to begin with), is small. If there is not a first class job printing office in the vicinity, it is better to send the work to one of the offices advertising poultrymen's printing as a speciality.

Correspondence Paper and Envelopes should be of good quality, with neat letter heads and requests to return. Some breeders print their circulars on the backs of their letter paper, — or, write letters on the backs of their circulars. This does not look well, nor does it create a good impression. It is never possible to trace the sales due to neat stationery, but one can easily judge something of its influence by comparing the impressions made on himself by the receipt of letters and circulars of varying neatness and quality. The use of poor, unattractive stationery is the worst recommendation in the world for a poultryman whose work is supposed to demand in large measure the possession of genuine good taste.

Circulars should be sent free to all applicants. Each year the custom of asking stamps for circulars falls more into disuse. It is not bad policy for a new advertiser to enclose with each circular sent in response to an application, a brief and courteous letter soliciting patronage.

All correspondents should be promptly and courteously answered; postal cards treated as respectfully as sealed letters.

292. Terms of Sales — should be, cash with the order for mail trade; cash on delivery for local trade. Exceptions should be made only in case of a customer well known to the breeder, and of whose ability and willingness to pay he is sure. A poultryman cannot afford to do a credit business. His business is carried on under such conditions that the common evils of the credit system are many times increased, and general credit giving would break him in a very short time. A beginner whose stock is selling slowly is often tempted to give credit rather than lose a sale. If he does so, he is likely to regret it. If he cannot carry the stock he had better sell it as market poultry. Shipping poultry and eggs C. O. D., is quite as risky as crediting, for a customer cannot be compelled to take the goods, and if he refuses the shipper must stand transportation charges both ways, or lose the stock.

293. Selling Stock. — Parts of the observations on buying stock and on prices of eggs and stock, in ¶110, 113 — 114, are so easily adapted to selling,

that their substance need not be repeated here. Those paragraphs should be re-read in connection with the following remarks, which are more specially pertinent to the new breeder as a seller of stock.

The beginner, generally, is a poor judge of stock—though generally he does not thus think of himself. He can make broad distinctions between his best and his worst, but when it comes to accurately placing values on his mediocre stock, he is most apt to make mistakes, and in consequence make some bad blunders in filling orders. Mistakes due to ignorance are often aggravated by one's carelessness—pricing or shipping stock without carefully examining it; sometimes catching birds in the dark, and cooping them almost without looking at them,—filling orders by the catch-as-catch-can method. If one is frank and straightforward with his customer, such blunders are easily rectified without injury to either party, and without ill-feeling on either side.

Some breeders prefer to have their stock scored, and sell by the score. It is questionable whether there is any real advantage in this. Private scoring is so open to abuses that private scores are generally discredited. The full responsibility of filling orders educates a seller in values more quickly than anything else.

One of the most serious mistakes of beginners is selling their best birds. A breeder—no matter how low down in the ranks—ought never to sell his best birds, unless he is sure he can replace as many as he needs of them for less money than these bring him. If he does not keep a little in advance of his customers, he cannot long hold their trade.

Nearly all new breeders carry too many low class males through the winter. Males of the quality sold for crossing or grading rarely bring over \$1.50 to \$2 each. At such prices it does not pay to carry them until the beginning of the breeding season, when they will be in demand. Some old breeders say that it does not pay to winter a male that cannot be sold in the spring for \$5. The new breeder cannot place his limit quite as high as that, for he cannot at any time get the prices the older breeders get; but if he will make it a rule to keep over no male which he cannot sell for \$2.50 or \$3, one of the worst leaks in his business will be stopped. Pullets of like inferior quality can be made to pay their way.

An unknown breeder cannot expect to get the prices a breeder of wide reputation gets for stock of the same quality, as far as appearances show. At the same time, he ought not to make the mistake of cheapening his stock and himself by offering goods for less than the ordinary small breeder gets for similar stock. At first glance it would appear that if one cannot dispose of most of his eggs for hatching at \$2 or \$1.50 per sitting, it is better to sell for 75 cents or even 50 cents, than to eat them; or if he cannot get \$3 or \$2 for birds well worth those prices, it is better to let them go at \$1 for breeding, than at 50 cents as poultry. Every dime saved this way is a dollar lost in future sales. The beginner who has good stock should keep his prices at a fair medium.

Orders should be promptly acknowledged, and also promptly filled.

Every customer should be given good value for his money. It is better to err a little on the side of good measure than to give scant value; but, even in giving good measure, it is best not to go too far — you cannot afford it.

In quoting prices stock should be honestly described, and faults as well as excellencies mentioned: they are equally important to the breeder, and it is only fair to the customer who cannot personally examine birds before ordering. The breeder who does this, competing with those who do not accurately describe their stock, is sure to lose some sales. It is much better to have a correspondent buy of the other fellow and wish he had bought of you, than buy of you and wish he had placed his order elsewhere.

In selling stock on approval, the usual understanding is that it may be returned if not as represented; that is, if it does not answer the description given, and the buyer can fairly claim he has not been sent what he ordered. Sometimes the special arrangement is that if the stock *does not suit* the purchaser it may be returned.

294. Shipping High Class Fowls. — Breeding and exhibition fowls are shipped by express in light coops made of wood, or of wood and canvas.

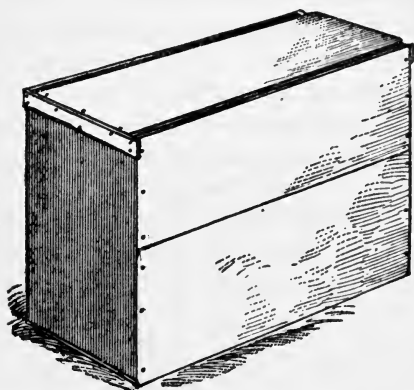

Fig. 82. Box Coop for Shipping Thoroughbred Fowls.

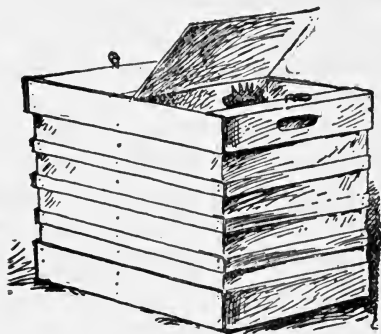

Fig. 83. Coop for Shipping Fowls to Exhibition. Same Coop with ordinary Slat Top is often used for Shipping Fowls to Customers. (By courtesy of F. L. Sewell).

If properly cooped, and provided with food and a cup for water, they can be safely shipped any distance. Expressmen feed and water fancy fowls in transit. Some of the companies are very strict in their requirements in this matter, obliging their employees to mark the fact and time of each feeding on the shipping bill. For fowls in all wood coops, and in coops of wood and canvas, so constructed that were the canvas removed the fowls would still be securely confined, the express rate is the regular merchandise rate, known as the "first class" rate. For fowls in canvas covered coops, so constructed that the canvas is required to confine them, the express rate is "double first class," just twice as much as in the other style of coop. Figs. 82—83 show

styles of coops commonly used. All wood coops can be bought in knock down bundles, ready to nail together. In making the slat coops with canvas lining lath, empty grocery boxes of light wood and cheap muslin can be used, and the cash cost of a coop for four or five fowls need not exceed fifteen cents. If many coops are needed, it is better to buy new lumber, which can easily be cut to the dimensions required, than to take the time to work up scrappy stuff.

A little chopped straw or hay, or some chaff, should be placed in the bottom of the coop. Before the fowls are placed in it their legs should be cleaned, and combs, wattles, and faces wiped clean of dust and soot, and rubbed with vaseline, which not only brings out the color of the comb, but protects the parts treated from the cold, and prevents swelling and puffing of the face should the birds be exposed to a draft. The breeder should be very particular that no lousy bird is shipped from his yards, and if lice have been giving him trouble, should coop the birds—in exhibition coops—for some days before shipping, and treat for lice. The top of the coop, whether in one piece or in several, should be so securely nailed that the coop can be lifted by any one slat. Coops are not supposed to be lifted that way, but the precaution is a wise one, none the less.

A bag containing sufficient grain for the fowls for the journey, should be tied to the coop in such a way that the grain can be easily got at. A few pieces of bone with some meat adhering to them, and a large piece of mangel wurzel put in the coop before nailing the slats down, help to keep the fowls contented. The drinking cup should be fastened in one corner, high enough up to prevent it being filled with dirt from the bottom of the coop, and in such position that water can be poured into it through the space between the slat and the side of the coop. The address of the consignee, very plainly written on a tag, should be affixed to the coop, and unless the tag bears the shipper's name he should tack one of his cards conspicuously on the coop.

The purchaser should be notified of the shipment of his birds—time of leaving, and by what express—even though previously informed of the date when shipment would be made.

If the shipper desires the coop returned to him he should so state when sending notice of shipment, and should enclose ten cents for return charges, which must be prepaid on "empties."

295. Selling Eggs for Hatching—is, in general, considered less satisfactory to both buyer and seller than dealings in fowls. Still, while there are a few who do not sell eggs for hatching, the vast majority do sell them, either because it is the general custom, or because they make it pay, and think that on the whole the advantages of that method of selling pure bred stock more than compensate for its drawbacks.

Advertisements of eggs for hatching should be started in January—certainly not later than February. Few high priced eggs are shipped

while there is danger of their being chilled in transit, but intending buyers begin making inquiries early, and many orders are placed in January and February for March and April delivery.

As with fowls, the price should not be put too low. If the stock is of quality to justify the price, a breeder is quite likely to sell as many eggs at \$2 as at a lower price, and sell to a better class of customers, better informed of the ups and downs of buying eggs for hatching, and consequently more reasonable and more agreeable to deal with. Nearly all breeders make reductions in prices for several sittings ordered at one time. This one can well afford to do, for the work of selling and handling one sitting costs quite as much as for two or three.

It is quite a common practice to reduce the price of eggs for hatching late in the season. Those who do this think the eggs, while worth less than earlier in the season, are still well worth the price asked for them, and that the reduction extends their trade and the general interest in pure bred poultry by giving an opportunity to those least able to buy to start with good stock. Those who hold to one uniform price throughout the season, think it, in the long run, to their own best interest, and for the good of the varieties they breed, *not* to encourage people to hatch late chicks from stock more or less debilitated by a season's producing.

The practice in regard to guaranteeing hatches, is divided. The breeder's usual guaranty is that the eggs shipped are true to name, from the stock described in his advertisements and circular, fresh, and running high in fertility; — just such eggs as he sets to hatch his own stock; carefully packed and delivered to the express company in good condition. Not many breeders guarantee more than this. All honest breeders, however, replace eggs if their own hatches and general reports of customers indicate that their stock is not breeding right. Some guarantee six, seven, nine, or ten chicks from each sitting of eggs; some replace eggs that gave poor hatches at half-price, and duplicate very poor hatches and total failures free. If a breeder has fulfilled the conditions of such a guaranty as is outlined above, he is under no obligation to do more, for a good hatch depends on too many contingencies altogether beyond his control

296. Packing and Shipping Eggs for Hatching.—Eggs are shipped by express, always. Small lots of one, two, or three sittings, are packed in baskets specially made in various sizes for this purpose, or in common splint baskets, or in fruit (grape) baskets. Often a shipper can get other baskets more conveniently and at less cost than the special egg baskets, and many prefer them, irrespective of cost. With the regular egg baskets, pasteboard boxes having compartments for each egg are used. In packing, a little chaff, or fine excelsior is first put in the bottom of each compartment, then the eggs are put in, small end down; the spaces around them filled up with chaff, and the cover of the box securely tied. Excelsior is packed under, around, and

over those boxes when placed in the baskets; then the basket covers are very securely tied with strong twine. The covers furnished with the baskets have printed on them the notice, "EGGS FOR HATCHING — *Handle with care.*" The consignee's name and address, plainly written, should be placed on a tag attached to the handle of the basket.

In using the ordinary oblong, flat bottomed, splint baskets, a mat of excelsior from one to two inches thick, is spread evenly in the bottom of the basket; similar mats are placed around the sides; then the eggs, each carefully wrapped in newspaper, or in a wisp of excelsior, are packed in close, and the interstices filled with excelsior. If more than one layer of eggs is put in a basket, a thin mat of excelsior should be placed between layers. When all the eggs are in, cover them with excelsior to the thickness of several inches; sew on a cover of muslin, drawing it tight over the excelsior, and sewing to the edges of the basket. Paste on this cover a printed label with description of contents, and warning against rough handling, address and tag, as above.

To pack in grape baskets, use either excelsior, chaff, or cut hay; wrap eggs in paper or excelsior, and pack as firmly as possible without crowding too much. (The secret of packing eggs to go safely, is to have the package firm enough to prevent shifting, yet elastic enough to protect the eggs from jolts and jarring). The bottom, sides, and cover of a grape basket being much stronger than of the common splint basket, less packing material is needed between the eggs and the sides of the basket. Tie the cover on strongly, and label and tag as directed above. If a breeder will save his empty fruit baskets each year, and ask a few of his neighbors to do the same, he can get baskets for several hundred sittings of eggs at no cost beyond the trouble of collecting and storing them.



CHAPTER XIII.

Exhibiting Poultry.

297. The Business Breeder Should Be an Exhibitor.—The educational and advertising advantages which a breeder may get from poultry shows, have been mentioned more than once in preceding pages. There is another and a stronger reason why every business breeder of thoroughbred fowls ought to do all that he can do in reason to make a poultry show in his section a success and a permanent thing. A live poultry show extends the interest in poultry as few other agencies do—increasing the demand for the poultryman's goods, and thus affording a better market for what he has to sell. In this way the show benefits him, though he shows and fails to win, and even though he does not show at all. (If he never goes near the show, he still is indirectly benefited by it).

The breeders' duty on this point is, when the matter is looked at in the right light, clear. Poultry associations are not money making affairs. Those who promote them often have to go down in their own pockets to pay deficits. It does not often happen that there is a balance on hand when the bills are paid. With the simple fancier, maintaining a local poultry show is only a matter of pride; with the breeder it is a matter of profit as well. While he ought not to put himself in a position where the support of a show would fall too heavily on him, he is much at fault if he allows the benefits, direct and indirect, which a live show gives him, to be withdrawn or reduced for lack of his support. Where the interest in poultry is already strong, the support of one breeder does not often matter greatly; but in the many sections where the pure bred poultry industry is still in its infancy, the support of one breeder may mean a great deal to a show.

A fancier to whom poultry breeding is recreation, the competition of the show room "sport," is not in any way under obligation to support shows unless he chooses to make such obligation his. The breeder, as a business man, owes it to himself, to those dependent on him, to his community,—to all interested in his success or affected by his failure,—to use every means in his power to make the business successful. Of aids to the breeders' success, there are not many more efficient than a live nearby poultry show.

298. General Care of Exhibition Stock.—The general preparation of birds bred specially for exhibition, begins from the time when they leave the shell. The chicks are given every opportunity to make the best development of which they are capable. Nothing that would hurt them is permitted;

nothing which will help them neglected. They are not handled in a specifically different way from other good stock, well cared for. It is only that the breeder uses every means to assure the best development, and does not resort to the narrow balancing of cost and profit which must be followed in rearing lower priced poultry. That one way which is better than others, he follows regardless of trouble; that food which gives best results, he uses regardless of cost.

299. Special Selection of Specimens for a Particular Show—should be made about two months before that show occurs. The birds on which the breeder has had his eye, looking at them as possible winners, ought then to be separated from the rest, and thoroughly inspected in every section to see just what shape they are in, and what individual treatment each requires to put it in the best possible condition for the show room.

The novice in exhibiting is apt to rely too much on the general appearance of the fowl. The veteran exhibitor never takes a bird at his face value as he runs in the yard or stands in the coop. As soon as the specimen is in his hands he makes a thorough search for hidden defects and faults only found by close inspection. A bird having bad faults which cannot be remedied, is rejected; blemishes which can be removed by legitimate means, are corrected. In selecting specimens for the show room, it is looks that count; looks count for everything. Blemishes which might be passed over in a breeding bird are inadmissible in a show bird. The smallest positive disqualification immediately throws it out of the category of exhibition birds. As disqualifications are distinctly specified in the Standard, there is little excuse for even the greenest exhibitor entering a bird which will be debarred from competition. One has simply to take each bird in hand, and with a list of disqualifications before him, make sure that the specimen is free from each and every one of them.

The selecting process must proceed still further. Not every bird that is free from disqualifications is capable of winning, even in weak competition. A bird that is very faulty in several sections has little chance of winning. The all around good bird is the exhibitor's reliance. Once in a long time a bird is found fit to go from the yard to the show room (and in that case the exhibitor's effort is directed to preventing injury, and keeping it in good condition), but in most cases a great deal needs to be done before the bird is ready to show. To show to advantage, birds must be in perfect condition, and must have been so handled that they are not "coop shy," are not disturbed by the inspection of visitors or the handling of the judges, but will pose and show themselves to best advantage.

300. While Being Prepared for Showing—fowls are best kept in small pens, in which they are easily caught and handled. If there is no such provision for them, they may be kept for a few days in exhibition coops, then in the pen with yard, then in the coop again, etc. —the object being to have

them easy to get at when it is necessary to handle them, to accustom them to being handled, and at the same time not keep them too closely confined.

No males should be allowed to run with females which are to be exhibited, nor should two males be allowed to get together. Extraordinary precautions must be taken to keep males from fighting, or a good bird may easily be spoiled for showing, and weeks of painstaking work gone for nothing.

301. Care of the Plumage.—One of the first things to be done in fitting the specimen is to pluck out all broken, stained, and foul* feathers, that new ones may grow out in their places. Old birds need to be very carefully looked over for dead stubs of feathers that failed to moult out. The backs of hens often contain feathers broken by the feet of the male; and there are nearly always some worn and broken feathers on the feet of Asiatics.

The plumage can be cleaned and polished by compelling the birds to exercise in *clean* straw, and by furnishing a dust bath containing a liberal proportion of clean fine sand. The plumage of white fowls, if not made clean enough by these means, can be washed.

Washing Show Birds.—Use Pear's or Ivory soap, as soap with rosin in it will ruin all chances of a successful washing. Thoroughly soap and lather to the skin, and leave it on long enough to cut all dirt, or any gummy or adhering substance in the plumage. Then remove to a second tub of clean lukewarm water, deep enough to submerge the fowls, and by gently rubbing with a large sponge *with* the feathers, remove every bit of soap. Then shake the plumage in the water thoroughly, and rub it to the usual smooth condition. At last plunge in a tub of cold water that has been blued as the housewife blues the water for the linen in her wash. By gentle manipulation of the plumage thoroughly rinse it with this blue water, and take the bird out into a wire bottom dripping cage, allowing the specimen himself to shake the water out, and then he may be removed to either of two rooms.

“Now the best in the world is a room the floor of which is covered four inches deep with sea beach sand, and the atmosphere heated to 100 degrees, having been warm long enough to heat the sand to 100 degrees. Then allow the room to cool to 70 degrees

* NOTE.—If false colored feathers grow in off-color again, they must be again removed *if the bird is to be exhibited*. Their removal is *wrong*, in that poultry associations have a rule prohibiting it. Like all rules and laws, this is effective only as far as it can be enforced—and can be enforced only when infringements are detected, and public opinion sustains those who attempt to enforce the law. The removal of a few feathers from the soft plumage of a fowl could only be detected after a most searching examination. If there were a disposition to enforce the rule, the removal of foul feathers could only be proved in the case of one caught in the act *by some one interested in furnishing such proof*. Notwithstanding the rule, the plucking of a few foul feathers will never be regarded, by those who know how rarely birds are produced without them, as a flagrant sin. Indeed, the more general opinion is that it is the rule that is wrong—in not making sensible exceptions,—and that the practice is justifiable, if not absolutely right. Inasmuch as feather plucking is done openly and universally, it does not really constitute a deception except on those who wish to feel themselves deceived. The matter is one that causes new exhibitors a great deal of concern. Unless one can satisfy himself that “plucking” is excusable, he will feel more comfortable if he leaves his birds at home.

at the height of a man's waist. This will cause the heat to rise from the sand, and the fowls will, with the water in the plumage, secure a steam or Turkish bath that will make the plumage spread out to its fullest extent, and be immaculately white.

"Or, put the bird in a cage with a wire bottom and cut straw that is absolutely clean, and set this cage over a register so as to heat the straw to 100 degrees in a room of 70 degrees; and in this let the bird steam dry. When washing brush the black dirt out from under the scales of the legs and toes, as one cleans one's finger nails." [I. K. FELCH, in *Reliable Poultry Journal*.]

If a bird does not carry its wings right; if the tail is too fan-like, or too pinched; if the sickles do not set right; if anything of this kind is wrong, it can and should be made right by frequently stroking, shaping, and manipulating the feathers with the hands, until at last they take proper positions.

302. Care of the Head. — If a comb does not set quite right, it can often be adjusted by a little manipulation with the fingers. The comb of a Leghorn hen that does not lop nicely can be formed in a very short time to shape just as desired, *and will stay that way* through the show and afterwards. The comb of a male that does not stand true, or bulges over the beak, can be very much improved by simply working it as near what it should be as possible with the fingers. The wattles, too, yield to treatment;— and all such methods are perfectly legitimate.

Just previous to the show the head, comb, and wattles should be sponged clean, to free them from dirt and dandruff, then rubbed (not smeared) with vaseline.

303. Care of the Feet. — If the feet are at all scaly, the thing first in order is to get rid of the parasites, (§ 315); afterwards the shanks and toes can be well rubbed with vaseline or olive oil. A sound foot once lost can never be restored, but if the bird is otherwise good, and the company he is going into not too hot, it is worth while to put the bad feet in condition—they ought to be taken care of, whether the bird is to be shown or not.

304. The Food Previous to Exhibition need not vary from the regular diet, unless it is necessary to force a fowl to bring it up to weight. If a fowl in good condition is much short in weight, forcing is very likely to impair its future usefulness in the breeding pen. If the fowl is in poor condition, judicious heavy feeding will do it good, aside from increasing its chances of winning. For rapid forcing Felch recommends a diet of whole corn, grit, and raw beef. On this diet, he states, from seven to fourteen ounces can be put on a bird in a week. Some breeders use bread and milk and sugar for forcing.

A few exhibitors make a practice — and it is surely a good one — of feeding the birds to be exhibited, for some days prior to sending them to a show, on a diet as nearly as possible like what they will get at the show. Thus the birds are not subjected to an abrupt change of diet as well as of other conditions when sent to the show room.

305. Leg Bands are nearly always needed. A few shows do not allow them. It depends on the systems of cooping and judging used. The show premium list furnishes explicit instructions. If bands are used, they ought to be removed when the birds return. The feet are often badly hurt by bands left on too long.

306. Exhibition Coops.—When the show association furnishes coops, the birds may be shipped in common shipping coops, illustrated in Figs. 82—83. When the exhibitor is required to furnish his own coops, combined shipping and exhibition coops (see Fig. 84), should be used. Often the associations suggest certain sizes of coops, that the display may be more uniform, and neater in appearance. If the dimensions of the coop are left to the exhibitor, he ought always to be sure to give his birds plenty of room, and never make the

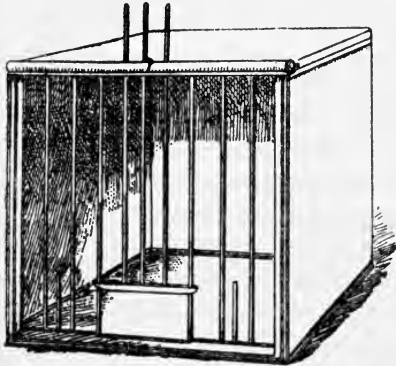

Fig. 84. A Combined Exhibition and Shipping Coop.

mistake of sending birds in a low coop. The dimensions of the coop illustrated are: height, 30 in.; width, 30 in.; depth, 24 in. Whether birds are sent in a shipping or in a shipping-exhibition coop, a neat, clean coop should be used. It is not at all creditable to a breeder to send out his fowls in a rough, dirty coop.

In shipping exhibition birds which are to be returned to the same owner, it makes no difference in cost of transportation which style of shipping coop is used. If birds are sent in a coop that takes them at single rate, the express companies charge for returning them; if they go at double rate, they are returned free.

307. Ought an Exhibitor to Accompany His Birds?—It is better that he should, but it is not really necessary. Many poultry men will not show unless they can go with their birds. It is, of course, a matter in which each must judge for himself. If all followed that course many persons would be unable to exhibit, and there would be fewer and poorer shows. The absent exhibitor's stock is not always looked after as he would look after it himself. On the whole, however, it is pretty carefully handled.

308. After the Show—the returned fowls should be kept quiet, and fed rather light for a few days. It frequently happens that fowls coming out of a winter show strike weather much colder than any they had experienced before going into it—weather so severe that the change from the warm show

room to any ordinary poultry house would be too great for safety. In that case it is better to keep them in the coops, and the coops in a warm place for a day or two.

309. Exhibiting Dressed Poultry and Eggs. — Though there are, as yet, only a few poultry shows having dressed poultry and egg departments, it is probable that, before long, practical exhibits will be a feature of every show room. Fowls are dressed for exhibition in exactly the same way as for market. A poultryman who has fine market poultry to sell cannot advertise it better than by exhibiting some of his best. A breeder whose fancy stock possesses good practical qualities, finds it well worth while to make a reputation as an exhibitor of dressed poultry and “most fancy fresh” eggs. Eggs packed in small lots for exhibition go best in such boxes or baskets as are used for packing hatching eggs. In making an exhibit of a dozen eggs, it is advisable to use, if possible, eggs laid by one hen.



CHAPTER XIV.

Diseases, Parasites, and Enemies of Fowls.

310. The Unprofitableness of Doctoring.—To succeed in “doctoring” a stubborn case of sickness or a persistent epidemic in his flock, is one of the worst misfortunes that can befall a poultry keeper. It puts him on a wrong course—his stock on a bad footing. It gets him into the habit of fussing with and dosing his birds, and, in consequence, his place is soon stocked with fowls of enfeebled constitutions, predisposed to disease. The greater one’s success in treating well developed disease the more sick fowls he will have.

Still, the poultryman needs to know enough of the symptoms of different diseases to be able to detect each at an early stage; enough of the causes of particular diseases to enable him to take efficient preventive measures for the well fowls when sickness does appear in his flock; and something of the modes and effects of using the simple remedies which, if used in time, will often check a disease before it has reached a danger point. He needs to learn in which diseases (and at what stages) it will *pay*—both immediately and in the long run—to use drugs, and when it is best to resort to the hatchet and the spade; and he needs to get firm hold of the fact that when once disease has become established in a flock, a good sharp hatchet, vigorously used, will do more for him than all the medical knowledge and all the drugs in the world.

On the whole, diseases of fowls closely resemble human diseases. No doubt they are in many cases identical. If correctly diagnosed a case of sickness in the poultry yard can often be identified as *like* some common human malady, and may be successfully treated in the same way. This is a good thing to remember, because in an emergency one may have in the house a “family” remedy which will be effective if immediately applied to a sick fowl, while if no remedy were given until a regular poultry medicine could be obtained, the fowl would be lost. A considerable proportion of the cases of sickness in the fowl yard yield to very simple treatment if taken in time; the great trouble is that they are not observed soon enough, or there is nothing at hand to give the sick bird. It is possible to cure many bad cases; but—the life of a well fowl is not as a rule worth much in dollars and cents, and the life of a sick fowl is worth so much less that a poultryman ought not to begin a course of doctoring when circumstances call for individual treatment for many fowls, or for a long course of treatment for one or several individual birds. It is not only the cost of the medicines and the value of the time spent in administering them, and

in giving the fowl the special care demanded by its condition, that have to be taken into account. The cost of feeding and housing and caring for the convalesced fowl until again productive, must be reckoned up against doctoring. When to this is added the well established fact that a fowl once dangerously sick with an organic disease is afterwards worse than worthless* as a breeder, the poultry keeper should have no difficulty in making his estimate of the *ins* and *outs* of physicking fowls show that unless an epidemic is so mild that it yields readily to simple remedies, applied in the ordinary food and drink, and corrected sanitary conditions;—or an individual case not yet past the stage when a very few treatments could be expected to prove effective, it is better to kill than to try to cure.

311. Some General Rules for Preventing Diseases.

(1). By good care — with all that that includes : correct sanitary conditions, good houses, well sunned, aired or closed, according to weather and temperature ; proper food, exercise, cleanliness.

(2). By quarantining all new fowls as long as there is danger of their contracting diseases from or transmitting them to old stock.

This is a matter of very great importance. The germs of some diseases to which acclimated fowls have been immune often infect unacclimated fowls, which are for the time less able to resist, and having thus gained a foothold will successfully attack the acclimated fowls. The contrary also often happens. The new fowls bring with them the germs of disease which in their old home they had successfully resisted, but to which they now succumb, and if the breeder is at all careless the whole stock may be affected.

(3). By preventing fowls from outside flocks from coming in contact with members of the flock, or even feeding on the same ground. Pigeons, also, should be kept away ; they are the worst disease mongers of all domestic birds.

(4). By promptly caring for fowls which seem the least indisposed, and correcting wrong conditions as soon as their effects are noted. Too often such measures are neglected until disease has positively developed.

* NOTE.—Such fowls are *worse than worthless* as breeders, because there is born in their offspring a strong tendency to contract the same disease at the age at which the parents had it. It happens so often as to justify saying that it is the rule, that among the offspring of fowls recovered from a severe attack of diphtheritic roup, that disease will become epidemic, when the offspring of fowls which had never had the disease are not at all affected, though kept under the same conditions, and sometimes in the same house, unless the disease is literally forced on them by constant contact with sick fowls. The loss of a single bird is at most a loss of only a few dollars. An outbreak of disease among the descendants of a fowl debilitated by that disease, may cause a loss of hundreds of dollars, for under such circumstances the disease is apt to be so virulent, its course so rapid, that such treatment as would ordinarily succeed in the early stages of the malady, proves ineffective.

Entire prevention of disease is not possible when any considerable stock of poultry is kept; nor is it continuously possible under any conditions. In a small flock of fowls, healthy and well cared for, one, two or three seasons may pass without a sick fowl, even though the *rate of loss*, as finally determined is *greater* than in a large stock in which there are deaths every month in the year. There are people who claim to breed poultry on quite an extensive scale without losses from disease; but such statements are not credited by persons who have had experience in handling fowls in large numbers.

312. Hints to Guide in the Diagnosis of the Ailments of Fowls.—

The common diseases of poultry, their causes, symptoms and simplest remedies, are given in the next paragraph. The hints given in this are to help the reader to go as quickly as possible to the information he needs. Such hints cannot be infallible, but will be found right in the great majority of cases.

When a fowl sneezes, wats slightly at the nostrils and eyes, the face puffs up—any or all of these symptoms indicate a *common cold*.

When it rattles in the throat, it has a *cold with bronchitis*.

When it experiences great difficulty in breathing, it has, probably, *pneumonia*.

When cankers form in the mouth and throat, it has *diphtheria* or *diphtheritic roup*.

When discharges from the nostrils are profuse and ill-smelling, it has *common roup, influenza*. Looseness of the bowels accompanies many diseases, and if there are symptoms indictating the presence of another disease (not intestinal), that should be treated first.

Looseness of the bowels, the feathers around the vent smeared and gummed with the discharges, is *diarrhœa*.

A bloody diarrhœa may be either *dysentery* or *enteritis*.

Greenish discharges, turning to frothy white, are given as a symptom of *cholera*; but greenish yellow, frothy white discharges frequently accompany *roup*, and are often found under such conditions that it is impossible to suppose cholera.

A dark purplish comb and face, generally ruffled appearance, and brownish, watery discharge, indicate *congestion of the liver*.

Symptoms as above, but more pronounced, and with yellowish discharges, indicate that the disease has developed into *inflammation of the liver*.

Small hard lumps under the skin of the face, occur in *roup*.

Ulcers about the head and face are generally *chicken pox*.

A yellowish looking head and face, indicate *general debility, anæmia*, or *consumption*.

General listlessness without symptoms of specific disease, indicates *indigestion*.

Lameness is generally the result of an accident, or of *rheumatism*.

Twisting of the head and neck is due to *cramps, rheumatism, giddiness*.

Jerking of the head is due to pressure of blood on the brain, that is, to headache.

Fowls dying suddenly had *apoplexy*; *heart failure*; *choked*. Many so-called sudden deaths are sudden only because the keeper failed to note plain symptoms.

313. Diseases of Poultry. — In the following list of diseases no special effort has been made to have descriptions and terms technically correct. The object is to describe the diseases for those who have neither time nor inclination to give such matters more study than is required to learn when to *physic* and when to kill. Those who wish to look into the subject more fully, or who prefer to doctor whenever a cure is possible, should get a more extended work on poultry diseases. Neither space nor the plan of this book would admit full descriptions here.

Anæmia, — a condition of the blood, *poor* blood, due generally to lack of proper food, fresh air, or sunshine. Remedied by correcting conditions.

Apoplexy, — rush of blood to the head, caused by over-eating, violent exercise, fright, extreme heat; rarely observed until the victim is too far gone for treatment. Bleed from vein in under side of wing; if possible, give two drops of croton oil.

Bowel Trouble — see *Diarrhœa*; also ¶ 261.

Break Down Behind — if simply due to over-fat, may be remedied by putting hen on light diet; if the disorder is due to derangement of the oviduct, it is generally incurable.

Broken Bones — easily treated if the break is in the shank; put on light splints, and wrap firmly. If the break is anywhere else, the fowl should be killed.

Bronchitis — a catarrh, a bad cold accompanied by coughing or rattling in the throat: give aconite, as for a cold; or use any convenient remedy suitable for coughs and colds.

Bumble-foot — an abscess on the sole of the foot, caused by bruising by jumping from the roost: treatment, if taken early, wash with strong vinegar, and apply tincture of cocaine; if the abscess is well developed, open by making two cuts, crossing thus, X; wash out all matter with warm water containing carbolic acid; apply nitrate of silver, ten grains to one ounce of distilled water.

Canker — see *Roup*.

Chicken Pox — small ulcers on the head and face: wash with carbolic soapsuds; anoint with vaseline or fresh lard.

Cholera — a contagious disease of the bowels, caused by combined conditions of filthy quarters, improper food, and extreme heat. Most so-called cases of cholera are dysentery. Treatment of sick birds generally useless; apparently well birds should be given sulpho-carbolate of zinc in the drinking water, one-eighth of an ounce of the drug to a quart of water.

Colds — affect fowls variously, and if neglected, often lead to something serious; — give aconite in the drinking water, a dozen homœopathic pellets to a quart of water. A good remedy to keep on hand to use for colds, bronchitis, etc., is: equal parts cayenne pepper, ginger and mustard, mixed as stiffly as possible in lard, then flour worked in to make a stiff dough; form in slugs or pellets about the size of a small hazel nut; give by opening the mouth and dropping down the throat. A single treatment often cures; if it does not, it should be followed by another dose in twenty-four hours.

If the cold is accompanied by puffing of the skin of the face, bathe the parts affected every two or three hours with warm water containing about 1 per cent carbolic acid; keep in a warm dry place; at night rub with vaseline.

For treatment of colds, see also ¶ 174.

Constipation — caused by lack of exercise and of green food; in young chicks by too

much boiled milk or "binding" food. Correct conditions for chicks: for adult fowls give castor oil, castoria, etc.; any laxative that happens to be convenient will do.

Consumption—follows colds, pneumonia, etc.; bird grows thin and weak, "goes light;" sometimes has good appetite, but passes food from the bowel undigested. In early stages this disease may easily be confounded with anæmia. Treatment useless.

Cramp—see Rheumatism.

Crop Bound—give castor oil, or warm water; knead contents of crop, and try to force them out gradually through the mouth of the bird, held head down; if this fails, open the crop, removing a few feathers and making a short incision through the breast, at the top of the crop; remove contents, and sew up, taking care not to sew skins together.

Crop, enlarged—can be treated by cutting out a part of the skin and sewing up; not often worth the trouble.

Crop, Inflammation of—generally due to eating a poisonous or irritating substance; not likely to be correctly diagnosed, and in most cases useless to treat when discovered. Keep such substances away from fowls.

Debility—general weakness, without indications of organic disease; give good care, and start on the up grade with tonics or stimulants.

Diarrhœa—check by giving boiled milk to drink and dry food.

Diphtheria—see Roup.

Distemper—a term loosely applied to a variety of diseases, generally a mild cold or fever.

Dysentery—an acute bloody diarrhœa, mostly incurable.

Egg Bound—treatment not often permanently successful; give dose of castor oil; if this fails wash the vent with warm water, and pass in a feather dipped in sweet oil.

Egg Broken in Body—hen will die.

Enteritis—a non-contagious, acute diarrhœa, due to poison or irritants, or to the presence of worms.

Feather Eating—probably originates in an abnormal appetite. Nearly always the spread of the vice can be prevented by killing the guilty bird. Watch for it.

Frost Bite—to combs apply two or three times a day a mixture of vaseline, five table-spoons; glycerine, two table-spoons; spirits of turpentine, one teaspoon. When feet are badly frosted kill the bird.

Gapes—gape worms in the windpipe. Place the birds, a few at a time, in a large box covered with a coarse cloth, and having a door in the side; dust air-slaked lime on the cloth. The lime breathed in by the birds causes the worms to relax their hold, and they are coughed up.

Giddiness—a mild form of apoplexy; can often be relieved by bleeding under the wing.

Indigestion—generally due to over-feeding; correct the diet, give abundance of green food, compel exercise, avoid stimulants.

Itch—a warm weather eruption on the skin, often followed by loss of feathers: anoint with mixture one part carbolic acid, two parts lard.

Lameness—due to accident or rheumatism.

Leg Weakness—generally due to forcing, or to lack of bone forming material in the food: discontinue high feeding, but still feed well, giving cut bone or bone meal liberally.

Liver Disease—due to over-feeding; begins in congestion of the liver: if allowed to reach the stage when inflammation sets in, does not yield to treatment. Use a good liver pill, and, of course, correct wrong conditions.

Pip—a condition of the tongue accompanying diseases when the bird is obliged to breathe through the mouth; treat the disease; wet the tongue frequently with glycerine.

Pneumonia—brought on by exposure to extreme heat or cold, and by sudden change, dampness, etc.; generally incurable.

Rattling in the Throat—see Bronchitis.

Roup.—The term is used to apply to a variety of diseases affecting the head and throat. The present tendency is to limit the use of the word roup to diphtheria, or diphtheritic roup, and to call ordinary roup not seriously affecting the throat, influenza. Influenza can be treated as a cold. For diphtheria a number of different treatments have been successful at one time, and failed at another. Whether or not a cure can be effected, probably depends as much on the constitution and antecedents of the fowl as a treatment. Most of the roup remedies advertised have been successfully used in many cases. *Experienced practical poultrymen do not doctor fowls which have diphtheria*. They kill and bury, or burn them. For those who wish to try to save their birds, the following remedies are given :

One ounce oil of sassafras, one ounce best Jamaica ginger, one ounce tincture of iron, one ounce alcohol, a half-ounce prickly ash fluid extract, one-fourth ounce oil of anise. Dose, fifteen drops to one teaspoonful to each gallon drinking water.

The following treatment, suggested by A. V. Meersch, has been successfully used in many cases :— Clean out the pus, if in the mouth, with a little wooden spatula ; if you make it bleed a little, don't be alarmed. When this is done, wash the mouth with cotton wadding, attached to a little stick of wood, saturated in peroxide of hydrogen, then drop a little aristol on each sore place ; repeat this operation morning and evening for three days.

Dr. H. A. Stevenson reports having both cured sick birds, and immunized others by injecting antitoxine.

Worms are properly parasites. Two kinds affect fowls. *Round worms* are quite common ; tape worms rare. The presence of worms is not often detected except by examination after death. If a bird dying is found to have had worms, give well members of the flock turpentine in the soft food in proportion of two or three drops of turpentine to each fowl.

White Comb—a scurfy condition of the comb, due to unsanitary surroundings ; use an ointment— heaping teaspoon oleate of zinc to half-teacup of vaseline— wash the comb and head with carbolic soap and warm water before applying.

Wind Puffs— due to injury to lung tissue ; relieved by pricking, but not always curable.

314. Hospital and Medicine Chest.—For the simple treatment, of which the object is to check incipient, rather than cure established disease, the poultryman should have an isolated building, small, but comfortable, and should keep on hand a few of the remedies most efficacious in checking common diseases. It is prompt work that counts.

315. Parasites.—

Lice probably exist in small numbers wherever there are fowls ; but as long as fowls are healthy and active cannot increase rapidly enough to seriously annoy the birds. On sick and injured fowls, scaly legged fowls, sitting hens, and very young chicks, they thrive when the general stock is comparatively free from them. Frequently they come in in force on new fowls. It should be an inviolable rule to treat new fowls thoroughly for lice before permitting them to mingle with the flock, for the lice not only annoy fowls, they carry the germs of infectious diseases from fowl to fowl. The most effective means of ridding fowls of lice are given below, quoted from Wood. (See also ¶ 234 and 247) :

“FUMIGATION—Use ordinary sulphur candles: one candle will serve for an ordinary poultry house having about one hundred and fifty square feet of floor space. Drive the fowls from the house, and carefully close all doors and windows before lighting the candle, which should be put on an old tin can cover placed on a pan of wet ashes. After lighting the sulphur shut the house up tightly, and keep it so for four or five hours. Air the building thoroughly before allowing the fowls to return. Treat the fowls for lice at the same time.

“INSECT POWDERS—most of the insect powders in the market are good. *Those lice powders containing tobacco dust are best.* Dusting with insect powder is of no value unless *thoroughly done, and repeated at least three times*, at intervals of a week or ten days. The best way to dust a fowl is to hold it by the legs, head down, over a box or some receptacle to catch the surplus powder, and then, with the free hand, work the powder *thoroughly into the feathers and down to the skin.*

“KEROSENE—is one of the most common, cheapest, and best insecticides for use in the poultry house. Kerosene applied every month to the roosts is a good remedy against mites. It may also be applied with a brush to the walls and all cracks in the poultry house.

“KEROSENE EMULSION—is effective in place of whitewash for ridding the house of vermin. It is made by dissolving a pound of hard soap in a gallon of boiling water, remove from the fire and, while hot, add two gallons of kerosene. Churn or agitate briskly for ten or fifteen minutes, or until the mixture becomes thick and creamy. Then add about twenty gallons of cold water, and stir in thoroughly. It can be applied to the coop by a sprayer, a watering pot, or an old broom. It should be driven well into all cracks.

“LIME AND SULPHUR—a disinfecting powder is made of lime and sulphur as follows:—To half a bushel of fresh, thoroughly air-slaked lime add ten pounds of powdered sulphur and a fluid ounce of carbolic acid; mix thoroughly by stirring with a stick. This powder is harmless to fowls, and may be used freely about the house, and in nests and dust boxes.

“TOBACCO STEMS and sweepings are excellent addition to nest material as a vermin preventive.

“Carry on the warfare against vermin *in the poultry house, and on the fowls at the same time*, and you will get results.”

Besides the common hen lice, fowls suffer from attacks of other insects:

Mosquitos often bite combs, faces, and wattles; apply a little carbolated vaseline.

Buffalo or *Turkey Gnats* in swarms attack fowls along river bottoms, especially in Mississippi valley states. Preventive measures are: building smudge fires, and smearing exposed parts with carbolated vaseline, or some stinking oil.

Chiggers, Harvest Mites are common in the Mississippi valley as far north as Iowa. They harbor in weeds and bushes, and the only known preventive is to keep the fowls out of such places.

Fleas sometimes infest poultry houses. They are destroyed by usual treatments for lice.

Bedbugs can be exterminated by using whitewash, to which turpentine has been added, or by applying to the spots they haunt: “Half-pint each of

turpentine, ammonia, and kerosene, with four ounces of camphor. Dissolve the camphor in the turpentine, then add the others; apply with a brush freely."

Scaly Leg is caused by a mite which burrows under the scales of the feet and shanks. The crusts can be loosened by soaking in warm, soapy water, or by vigorous brushing with an old tooth or nail brush. When they have been removed, apply sulphur ointment, or a mixture of lard and kerosene.

Depluming Scab Mites often damage feathers. Woods suggests as remedies sulphur ointment or carbolized vaseline locally applied, adding that large areas ought not to be covered at one time, as the effect on the fowl is injurious: dusting with carbolized lime is also recommended.

316. Enemies of Fowls. — Domestic fowls have a host of feathered and four-footed enemies, against which the poultry keeper must be continually on his guard. Preventive measures are surest and best. Secure houses and coops to prevent night raids of cats, dogs, skunks, and other vermin. For those which molest the fowls in the daytime, a shot-gun is the best thing when circumstances admit of using it. The poultry keeper is wisest when he is always prepared for marauders. A good dog can be trained to keep cats, hawks, and other dogs away from the fowls in daytime, and to keep watch against chicken thieves at night. If properly trained and kept about the fowl yards the dog will not molest, annoy, or frighten the chickens. Electric burglar alarms are sometimes used by poultrymen in cities. When it is found that a dog, cat, skunk, weasel, hawk, or anything else, is carrying off fowls, chicks, or eggs, the keeper should give himself no rest until he has put a stop to the proceeding. It has to be done sooner or later, and it is better to sit up all night after the first raid, than to permit a second. Poison is one of the most effective means of ridding a place of pests, but must be handled with the greatest caution.



CHAPTER XV.

BANTAMS.

317. Bantams May Be Made Profitable.—Breeder of thoroughbred fowls often find the popular varieties of bantams quite as profitable to handle as most varieties of large fowls, and though bantams are not suited to market poultry keeping they can often be used to furnish eggs and some poultry for a small family living where large fowls cannot be kept. The hardier breeds of bantams will thrive in very close quarters, and bantams of any kind can be kept on a lawn or in a garden, without fear of their damaging it as large fowls would. As layers, bantams are like other fowls—good, indifferent, and bad. One who keeps them for the eggs must select and breed for eggs, and if he favors birds large for bantams, can get very fair sized eggs. For poultry, bantams can hardly be used until well grown; then, weight for weight, they are equal to any fowls. Indeed, there are few varieties of large fowls that make as plump carcasses as bantams do.

318. Management of Bantams.—In a general way the methods of caring for large fowls are applied also to bantams but in a few particulars—to which attention will be called in the proper connection—some of them have to be considerably modified. Bantams ought not to be kept with other fowls. Even when there is no danger of contamination, the bantams suffer when obliged to compete for food with larger, heavier fowls, and very often the other birds are spiteful toward and abuse the bantams. The rules for mating bantams are except in one or two cases the same as for large fowls. In general matings of Standard birds produce a good percentage of Standard chicks.

The prominent characteristic of the bantam is, of course, its diminutive size. In the exhibition room the smallest bird, *other things being equal*, wins. It is thus an advantage to an exhibitor to have his birds below Standard weights—*provided other things are equal*;—that is if, though under-weight, they are in good condition, of typical shape, and have perfectly developed plumage. Many bantam breeders in their eagerness to get light weight specimens, produce birds which fail in these most essential points. To get small bantams various means, such as late hatching, semi-starving, are frequently resorted to; but such methods do not produce fine, well developed specimens. The principal factor in producing small bantams is *selection* for the breeding pen of the smallest obtainable specimens that are

good in form and color. A breeder will rarely find that he has many such birds under Standard weights; the light weight birds nearly always failing in shape. Late hatching is not desirable. Early hatched chicks are likely to be better than those hatched late; but chicks hatched in late May or early June generally turn out best. Hens of the large breeds are not suitable for hatching and rearing bantam chicks. The best results are obtained when bantam hens are used. If it is not practicable to use bantam hens, "scrub" hens of three and four pounds weight should be used. The bantam chicks being so small, there is special need of guarding them from accidents, and the chicks of the less hardy varieties need to be carefully kept from cold and damp. They can be fed much as other chicks are, though they cannot eat

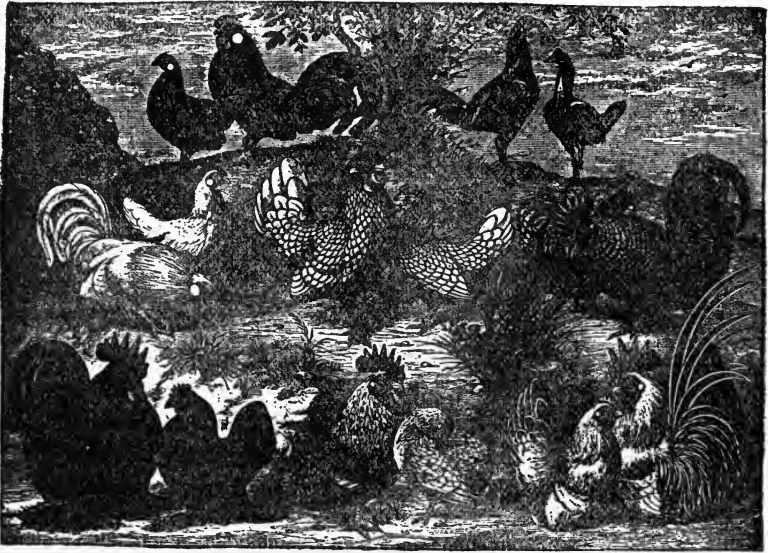

Fig. 85. Bantams.

Rose Combed Black.	Sebright.	Exhibition Game.
Rose Combed White.	Rumpless.	Cuckoo.
Cochin.		Japanese.

(By courtesy of W. W. Clough).

large grains at an early age. The best developed bantam chicks are obtained by giving as much liberty as possible, and feeding no more than is necessary to keep them growing, avoiding forcing on the one hand, and stunting on the other. Forcing makes coarse specimens; stunting makes peaked, scrawny ones.

VARIETIES OF BANTAMS DESCRIBED.

319. Game Bantams.—Of these there are eight Standard varieties: *Black Breasted Red*, *Brown Red*, *Golden Duckwing*, *Silver Duckwing*, *Red Pyle*, *White*, *Black*, and *Birchen*, corresponding respectively in form

and color to the Standard Exhibition Games of the same names. The Standard weights for Game Bantams are:—cocks, 22 ozs.; cockerels, 20 ozs.; hens, 20 ozs.; pullets, 18 ozs. Game Bantams are generally hardy, fair layers, fond of being handled and petted. The Black Breasted Red is the most common and popular variety, though all the varieties mentioned are so generally bred that they are not anywhere unfamiliar to persons interested in fancy fowls.

Malay Game Bantams, which resemble Malay Games, are rare.

320. Sebright Bantams.— There are two varieties, the *Golden* and the *Silver*, differing only in the ground color of the plumage, which is in the former a golden yellow, and in the latter a silvery white. Each feather is laced with a narrow edge of black. Sebright Bantams have rose combs, slate colored legs and toes. A peculiarity of the breed is that the males are “hen feathered;”—that is, instead of having the flowing hackle and saddle feathers and abundant tails, as is usual in male fowls, the Standard Sebright Bantam male has plumage differing from that of the female only in that the two upper tail feathers may be slightly curved at the ends. The production of such plumage on males is abnormal, and, as is usually the case when individuals of one sex assume characters of the opposite

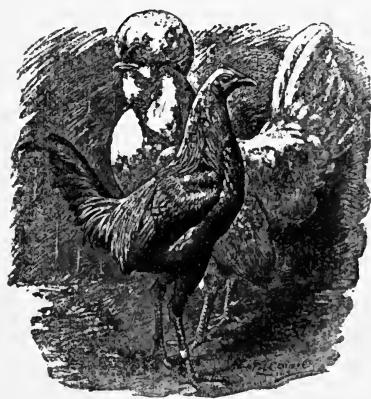

Fig. 86. Exhibition Game and White Crested White Polish Bantams.

sex, the “best” *Standard* males are often partly or wholly infertile and worthless as breeders. Consequently the breeders of Sebright Bantams often find it necessary to use in the breeding pens males having plumage too much like that common to male fowls to admit of their being shown in the exhibition room. Sebrights are among the most popular varieties of bantams, and are fairly hardy.

321. Rose Combed Bantams.— Of these there are two varieties, the *White* and the *Black*, the Whites pure white, with white or yellow legs; the Blacks brilliant black, with black or dark lead colored legs. Both varieties are quite common, and fairly hardy. The Standard weights are the same as for Sebrights.

322. Booted White Bantams.— All white, single combed, shanks and outer toes heavily feathered, prominent vulture hocks; weights as for Sebrights. This variety might be mistaken by one not familiar with the different breeds,

for the White Cochin. The two have some general resemblances, but differ essentially in size, shape, texture of plumage, and color of legs.

323. Brahma Bantams.—Two varieties, *Light* and *Dark*, resembling respectively the large fowls of the same names. These are newly made varieties, not yet extensively bred. Standard weights are—cock, 30 ozs.; cockerel, 26 ozs.; hen, 26 ozs.; pullet, 24 ozs.

324. Cochin Bantams.—Four varieties: *Buff*, *Partridge*, *White* and *Black*, miniatures of the large Cochins. The Standard weights are—cock, 30 ozs.; cockerel, 26 ozs.; hen, 26 ozs.; pullet, 24 ozs. Cochin Bantams are very hardy. The Buff variety is most popular, but all are common enough to be well known. In breeding these bantams—more perhaps than in any others—the breeder ought not to try to keep his birds below Standard weights, for in the very small birds it is hardly possible to get good Cochin shape.

325. Japanese Bantams.—Three varieties—the *Black Tailed*, which are white except the tail and flights; the *White*, and the *Black*. Standard weights are the same as given for Sebrights. Japanese Bantams are delicate and rare as compared with some of the other breeds.

326. Polish Bantams.—Two varieties—the *White Crested White*, and the *Buff Laced*, which resemble the Buff Laced Polish fowls. Both varieties are delicate and rare. Standard weights are the same as for Sebrights.



CHAPTER XVI.

Turkeys.

327. The Turkey — the Farmers' Fowl. — The turkey is peculiarly a fowl for the general farm. Market conditions and the characteristics of the fowl combine to confine profitable turkey growing on a business scale to farms where the birds can have an extensive foraging ground. Turkeys can be, and are, grown on small places, but in very limited numbers. The turkeys produced elsewhere than on large farms hardly affect the trade either in market or breeding stock.

The heaviest demand and best prices for turkeys come seasonably for the farm poultry keeper. The poults can be hatched at the "natural" season, and grown to a salable maturity in time to get the best prices of the year. This feature of turkey growing is one of its strongest recommendations to farmers' wives and daughters, who are usually the poultry keepers. Though it is open to question whether there is really as much to be made from turkeys as from chickens on the farm, it seems plain that the women on farms usually think turkey growing more profitable than any other branch of poultry culture, and it is probably true that the income from turkeys comes easier than that from chickens. There is greater satisfaction in producing something that is marketable when the market is at its best, and will bring in a large lump sum, as a flock of turkeys will. Then the receipts from the turkeys are a distinct addition to receipts from other poultry products. Turkey growing need not interfere with or curtail operations with poultry. Turkeys forage further than chickens, and thus the two kinds of fowl are kept on the same farm with little interference, the turkeys ranging mostly over an area outside of that used by the hens. In growing turkeys, as in growing chickens on the farm, the flock can be of a size proportionate to the foraging ground, and the turkeys may be, after the first few weeks, reared — and sometimes fattened for market — on what they pick for themselves. Even when they require regular feeding and heavy feeding to fatten, there is at least as much profit in feeding grain to them as to any stock produced on the farm. The production of exhibition and fine breeding stock is also limited mostly to farmers who are fanciers, and to some special poultry breeders occupying large farms. The few prominent turkey breeders located on quite small farms farm out most of their stock.

328. Turkeys Can Be Grown in All Sections,—but not in every situation. Low, damp places and cold, heavy soils do not suit them. They are healthiest and develop best on rather high ground, and soils from which the water drains quickly. The bulk of the turkey crop—as of the crop of chicken products—is produced in the central west, where the large grain, grass, and stock farms furnish unrivalled foraging grounds; but there is no section of the country where turkeys are not profitably raised by those situated favorably for handling them. Exclusive turkey farms, on the lines of chicken and duck farms, are unknown. The nearest approach to anything of the kind is found in Rhode Island, where on some farms three hundred, four hundred, —or even more— turkeys are produced annually.

329. Profit in Turkeys.—It is not easy to make a satisfactory estimate of the profit from market turkeys. Very few growers keep accounts. From the few accounts and close estimates which have been made public, it would appear that the average profit is about a dollar per head—rather less than more—and that the profit in most sections where turkey growing is carried on extensively does not often vary much—either way—from the average. Reports of the amounts “made” on flocks in different sections indicate no great differences in net profits on Connecticut, Rhode Island, or Vermont turkeys, which bring the highest prices in the eastern markets, and western turkeys, for which the grower receives, possibly, only half as much per pound.

The profits on high class stock are proportionate to the reputation of the breeder and the volume of his trade. It is commonly considered that the production of turkeys of fine exhibition and breeding quality is less profitable than the breeding of chickens of similar quality.

330. Houses for Turkeys.—Perhaps the commonest practice among turkey growers is to allow—or compel—their stock to roost outdoors in all seasons, and through all weathers. This practice is not limited to those who are indifferent to the welfare of their fowls. It obtains among progressive breeders, and is even approved and recommended by some authorities on turkey growing. The reasons given for continuing and sanctioning a practice condemned in every other line of stock keeping, are various, but are in general much the same as those once used by writers who advocated making hens “rough it.”* But though all too common, this practice is by no means

* NOTE.—In comparison with the methods of up to date *hen men*, some of the methods common among successful turkey growers seem thriftless—not to say barbarous. As compared with current instruction relating to chickens, much of the teaching of authorities on turkey culture seems antiquated. One at all familiar with the recent progress of poultry culture can hardly fail to have observed the striking similarity between present general teachings about turkeys and the kind of instruction on matters relating to chickens which was most in vogue twelve or fifteen years ago: nor can he fail to have noticed

universal. Many growers provide suitable buildings for both old and young turkeys; some turn them out in summer, and house in winter; some, while leaving the turkeys free to roost outdoors, provide, near the usual roosting places, sheltered perches to which the fowls may go in severe weather. This latter method is unsatisfactory, — is in fact quite useless, (except as a sop to the conscience of the keeper), because it is only when a storm is uncommonly rough at roosting time that turkeys will desert their usual perches for shelter. Some will not do it voluntarily under any circumstances.

Turkeys certainly need shelter *sometimes*. (This most of the advocates of the open air method admit). To suppose that they do not, is to assume that the laws of nutrition are reversed when applied to turkeys — in bad weather. Young turkeys in preparation for market, exposed to the cold storms of fall and early winter, *cannot* make the weights they would if protected; — it is not possible. If breeding stock subjected to the rigors of a northern winter, attains the development or keeps the condition it would if sheltered — which is, to say the least, very doubtful — it is at increased cost for maintenance. Now it is a principle — and a fundamental one — of profitable poultry culture, that the poultryman ought always to be prepared for those contingencies, which, though the exact time of their occurrence is uncertain, he knows are sure to happen. In the matter of shelter, for instance, the wise poultryman provides such accommodations, and so habituates his fowls to use them, that when the weather is worst the fowls can be kept comfortable, and that without the keeper being obliged to do extra work under disagreeable conditions. And it is surely no more than common prudence for a turkey grower who wants to make the most of his opportunities, to provide suitable quarters and train the birds to roost under cover, at least through that portion of the year when cold rough weather prevails.

Turkeys do not need as warm houses as chickens. Wherever the winter is not severe, a shed with front of slats or strong wire netting is sufficient. Even

that the trend of progress and of some of the best teachings on turkey topics is *toward* the best methods of the chicken keepers. That the precise methods used for chickens will ever be applied to turkeys, does not appear at all probable; but in whatever respects popular methods of handling turkeys are not truly economical and humane to the fowls *and to the keeper*, the changes already made by a few growers are sure to be more widely adopted. Much of the close adherence to old methods has been due to the prevalent belief that as turkeys are not as completely domesticated as other fowls, they cannot thrive unless allowed to continue many of the habits of their wild ancestors. Treatment of them has proceeded on the assumption that they are essentially different, *in nature*, from other domestic fowls. This assumption is correct in so far as it asserts that turkeys generally *now* have certain habits, different from those of thoroughly domesticated fowls, which habits render them less amenable to methods which suit the keeper; but it is wrong in that it presumes that these habits cannot be modified. The turkey is undoubtedly capable of becoming as completely domesticated as the hen (chicken), and it is highly probable that such modification of habits would be followed by increased prolificacy — a most desirable improvement.

in the coldest parts of this country, they will be contentedly comfortable in a fairly tight, but unlined building. A shed or house for turkeys should be somewhat higher than for chickens. The roost should be placed further from the ground. The droppings should not be allowed to accumulate beneath the roosts.

331. Yards for Turkeys.—As may be inferred from what has been said of the conditions of profitable turkey growing, turkeys are rarely yarded. Some breeders yard the breeding stock during the breeding season; some confine the laying hens until after the eggs have been laid each day, thus preventing them from laying in hidden or distant nests. This latter method recommends itself to those so situated that the breeding stock can have liberty. It is absurd that so many turkey keepers should spend hour after hour and trudge many rough miles in locating the nests of hen turkeys at liberty to nest where they please. The enclosure for laying turkeys shut up only a part of each day, need not be large. A yard fifty by one hundred feet will do for a flock of a dozen to twenty hens. A five-foot fence of woven wire or wire netting will keep the hens in bounds. Indeed, heavy hens will hesitate long before attempting a four-foot picket fence, and often refuse to try it.

332. Keeping Turkeys in Confinement.—While for business turkey keeping fairly large range must be considered a necessity, a person who wishes to keep and rear a very few turkeys for pleasure, may do so on quite a small piece of ground—on a village lot of, say, an acre. The semi-confinement is not necessarily injurious. The task of keeping them within bounds will be easy, or difficult, according to the individual dispositions of the fowls and the relative force of attractions inside and outside of the home grounds. Keeping them healthy is principally a matter of keeping their quarters clean, and using good judgment in feeding. Old birds are much easier to handle than young ones. If there is nothing special to induce the old ones to leave home, they remain there apparently well contented. The young ones, unless prevented, will wander off as soon as they are able. They can, however, be kept yarded, fed about as chickens are, and make good growth, develop into really fine specimens.

Handling turkeys under such conditions furnishes amusement until the novelty wears off. To one interested in such matters, the experiment is interesting as showing how far and in how short a time, the habits of the fowls can be modified. But not many who may try this kind of turkey keeping will continue it beyond a second season, for it would hardly be possible to undertake anything in the poultry keeping line that would give as meager results for the expense and trouble incurred.

333. Kinds of Turkeys.—The Standard recognizes six varieties of turkeys, classifying them as sub-divisions of one breed. The so-called

common turkeys are mostly mixtures of the varieties, or stock of pure varieties so much deteriorated that the variety characteristics are no longer distinctive. The wild turkeys still found in some parts of the country are of the same species as the domestic birds, breed quite freely with them, and the introduction of wild blood has been a favored method of restoring vigor of degenerate stock.

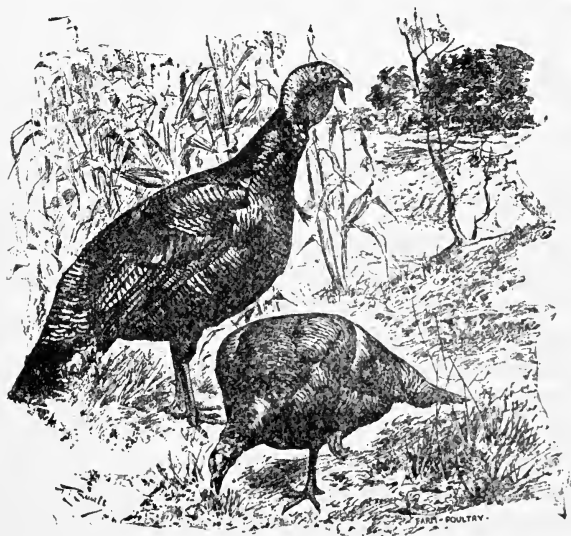

Fig. 87. Bronze Turkeys.

NARRAGANSETT TURKEYS—are second in size, and, probably, in popularity. The Standard weights are: cock, 30 lbs.; cockerel, 20 lbs.; hen, 18 lbs.; pullet, 12 lbs. In color they are *gray*—the ground of the plumage being black, and each feather ending in a steel gray band edged with black.

SLATE, BUFF AND BLACK TURKEYS—should be uniformly of the colors which give the varieties their names, but in the first two, specimens good in color are quite rare. Standard weights are: cock, 27 lbs.; cockerel, 18 lbs.; hen, 18 lbs.; pullet, 12 lbs. These varieties are not popular, but are pretty well distributed.

WHITE HOLLAND TURKEYS—are the smallest variety. Standard weights are: cock, 26 lbs.; cockerel, 16 lbs.; hen, 16 lbs.; pullet, 10 lbs. In some sections they rank next the Bronze in popularity. Turkeys called “Mammoth White” have been exhibited and advertised. These are generally supposed to have been produced by breeding White Hollands to white sports of the Bronze variety.



Fig. 88. White Holland Turkeys.

BRONZE TURKEYS—are the largest, hardiest, most popular, and most profitable variety. Standard weights are: adult cock, 36 lbs.; yearling cock, 33 lbs.; cockerel, 25 lbs.; hen, 20 lbs.; pullet, 16 lbs. Specimens exceeding these weights are not uncommon, but the heavy weight birds are bred mostly by and for fanciers. Bronze hens are reputed poorer layers than those of the other varieties and common hens.

334. About Breeding Stock. — The principles of breeding as given in Chapter X., ¶ 193—213, apply generally to turkeys. A few points, however, require special mention here. In breeding exhibition stock size is of first importance, markings next: big framed birds as near Standard in color as they can be got, are most desirable. To produce quick growing market turkeys small boned plump specimens are used. Old birds, if in good condition, — not too fat, — are the best for breeding. The male turkey does not attain full growth until his third year. Birds of either sex may be used for breeding until eight or ten years old.

One male to ten or twelve females, is the usual rule, though a male is sometimes used with twenty or more females with most satisfactory results as to fertility of eggs and vigor of offspring. A single impregnation generally fertilizes all the eggs in a litter, and sometimes all laid during a season.

335. Management of Laying Turkeys. — The hen turkeys usually begin laying in March or April, the period varying with the latitude, and, to some extent, according to the season. If the hens are yarded, nests are distributed about the enclosure, sometimes in coops,* boxes or barrels; sometimes heaps of straw or hay are placed in convenient half-concealed places in corners or among shrubbery. When the turkeys are not confined at all it is still a good plan to place nests near the dwelling house, and, if the hens are disposed to wander off, prevent it until they have laid in one of the nests provided. Having used a nest once, they rarely desert it.

If at liberty the breeding turkeys find a variety of food, and need be fed only with grain. Many growers feed corn only, but wheat and oats, or a mixture of corn, wheat, and oats, is considered better. Some soak the grain thoroughly before feeding. Some feed a mash † in the morning and hard grain at night. If turkeys are yarded during the laying period, a variety of food must be furnished — mixed grains, green stuff, animal food, shell, grit, and *plenty of water*.

As a rule turkeys are not very prolific. Many hens lay not more than eight or ten eggs before going broody. Not many lay more than seventeen or eighteen in the first litter. Eighteen or twenty eggs in the season is probably the average, though an uncommonly good layer may lay twice as many. As

* NOTE. — A grower who uses coops in preference to either barrels or boxes makes the coops three feet square on the ground, two and one-half feet high in front, and one and one-half feet high in the back, with board roof, and a good sized opening in the front for a door.

† NOTE. — In regard to feeding mashes to turkeys, it should be said that authorities are mostly against it. Nevertheless, many people do feed mashes with the best of results. The trouble with those whose birds go out of condition when fed mashes, is that their mash feeds are wrong either in composition, consistency, or quantity fed, — sometimes in all. It is worth noting that one authority, while roundly condemning mashes, highly commends soaked grain, which is to all intents and purposes a soft — or mash — food.

the hens lay so few eggs, it is the common practice not to allow them to sit until they have laid two litters of eggs. To avoid breaking or chilling, and also to induce the hens to lay longer, the eggs are removed from the nests daily, and if there is danger of the hens deserting their nests because of the removal of the eggs, a few chicken hens' eggs are placed in the nest.

336. Hatching Turkeys.—The natural methods of hatching and brooding are used almost exclusively in turkey culture. A few growers hatch the first eggs in incubators, and brood the poults in brooder houses (with large runs) or in outdoor brooders. Though those who have tried this have been fairly successful, artificial methods, as applied to turkey growing, must be considered as still in the early experimental stage.

Many turkeys are hatched and brooded by chicken hens, (most growers use them to hatch the eggs laid first), but the general opinion is that the young turkeys never do so well as when reared by turkey hens.*

When chicken hens are used to incubate the turkey eggs, the nests are made and the hens handled just as if for hatching chickens. Nine to eleven turkey eggs are enough for a hen. When turkey hens are used, they must, if wild, be set on the nests where they had laid. If gentle they can be moved if the keeper so desires, the same precautions being taken as are described for chickens in ¶235. A turkey hen can cover fifteen to twenty eggs.

The period of incubation for turkey eggs is twenty-eight days. It is sometimes prolonged to thirty days. As the eggs are almost uniformly fertile, testing is not as necessary as with chicken eggs, and as a rule the only test made is three or four days prior to hatching, when the eggs are put in warm water, and only those that "kick," which contain live poults, returned to the nests.

When the poults are hatching, the commonest practice is to remove the first hatched, wrap them in flannel, and keep in a warm place, and thus relieve

*NOTE.—The relative advantages of using chicken and turkey hens, are thus neatly summed up by Mrs. Hargrave, in the *Reliable Poultry Journal*:—"I have found the advantages of turkey hens as mothers as follows: They are more quiet with little ones; are better protectors from hawks and animals; will not wean the turkeys so soon as chicken hens; are kinder to little turkeys other than their own broods; are better foragers; will take their little ones to the range where they can pick insects, grass seeds, etc.; the little ones are not subject to so many lice as when running with a chicken hen. The main objection to turkey hens is, they are troublesome about coming to the accustomed roosting place with the brood and getting them sheltered for the night.

"Advantages of a chicken hen are that the little turkeys will be more tame as a rule than when mothered by the turkey, and the hen always takes her brood to the coop in the evening and puts them to roost; but as a hen is more restless, she keeps the little ones on the move the first few days, when they ought to be very quiet. This can be overcome by tying her or fastening her in the coop. * * * I endeavor to set eggs under a turkey hen, and some chicken hens at the same time, so when the chicken hen weans her brood they will, with a little effort on your part, take up with the turkey hen and her brood, and all go on the range together."

the crowded condition of the nest, and prevent the little ones being trampled. Some of the best growers, however, advise letting the turkey hen alone until she brings the brood from the nest. This method is probably the better one to use with hens not accustomed to being handled, or of vicious dispositions.

337. The Care of Young Poults.—The young turkeys will not eat for twenty-four to thirty-six hours after hatching; hence no food need be offered them the first day. The mother should be fed. If the nest in which the poults were hatched is such and so situated that a small pen can be made in front of it, the brood can remain there for some days; if not, they should be removed to a suitable coop—one with board bottom being preferable—with pen attached. The pen for a brood of turkeys should be made of boards twelve to sixteen inches wide, set on edge, and enclosing a space about eight feet one way by twelve to sixteen the other. To this pen they should be confined for a week or ten days—until they are strong enough to run about. If the pen cannot be placed on grass land, green food should be provided from the start, for little turkeys seem to need green food about as soon as they need anything, and suffer if they do not get it. Grit and charcoal should be provided. Lice must be fought just as on little chicks. Dampness is to be avoided by keeping the coop dry, by keeping the poults in the pen,—or if the pen is on grass, in the coops—while the dew is on the grass, and by getting them under cover before rain storms.

While the young turkeys are confined to the pens, these should be moved as often as necessary to new ground. The coops should be kept scrupulously clean. When five or six weeks old they may be allowed to range freely, but still need watching when severe storms threaten, and to insure their being home at night. A great advantage in giving an evening feed, even when it is not really needed, is that it induces the turkeys to come home regularly, and saves the trouble of hunting them up. At six to eight weeks of age the poults begin to roost, and roosts placed three or four feet from the ground should be provided, either under cover or where they have the partial protection of trees or buildings.

From the time they “shoot the red,” that is, from the time that color begins to develop on the head and throat, turkeys become hardier, and if their range is good, need little care beyond what is necessary to protect them from their natural enemies, and to prevent their becoming too wild.

338. Feeding Turkeys from Shell to Market.—REMARK.—The rations given here are those used by successful turkey growers. It will be observed that good results are secured from quite different systems of feeding. Differences in systems may be due sometimes to differences in circumstances; but as a rule they depend more on the keeper than on conditions. The fact that some growers are successful with very simple rations, shows that much of the work done by those who furnish more elaborate bills of fare is super-

fluous. At the same time, it is to be observed that not a few who succeed when they *fuss* a great deal with chickens or turkeys, fail utterly if they attempt more economical methods.

(1). **Ration for Young Turkeys.**—(CRANGLE).—“After about thirty-six hours old, or after the hen leaves her nest, we feed for three or four meals, equal parts of hard boiled eggs and stale bread. After that mostly stale bread moistened with milk. For two or three weeks we give curdled milk to drink. After two weeks we mix a little red pepper with the bread twice a week.”

(2). **Ration for Young Turkeys.**—(CURTISS).—“Our first feed is bread and milk, with the milk so pressed out that the bread will crumble. This is fed for the first two weeks, after which the feed is gradually changed to milk curd and meal, one-half part each, and a little cracked corn is given at night.”

(3). **Ration for Young Turkeys on Good Range.**—(MRS. MACKEY).—“The first feed I give is milk curd, with onion tops and tongue or pepper grass cut very fine seasoned with black pepper. I give this morning, noon, and night. It is a mistake to feed very often or too much while they are young. If poults are fed three times a day from the time they are hatched until they are grown, they are fed often enough. Yet they must have something to pick all the time, hence I would advise that they be kept in a grass yard where the grass is kept low.

“As they grow older I add other things to the food. Table scraps are splendid for them. If I have infertile incubator eggs I boil them and mix with the other food, but never use fresh eggs, simply because I do not consider it necessary. I give milk instead of drinking water when it is plentiful. I keep grit constantly before them. Wheat is one of the finest feeds for young turkeys. Cracked corn is splendid when they are older. My rule has been to mix grains of wheat in the food from the first, so that when they are old enough to change from curd to grain it will not be so hard to change foods.”

(4). **Rations From Shell to Market.**—(MRS. HARGRAVE).—“I feed poults every two hours until about ten days old, giving stale light bread softened in sweet milk (or water), squeezed dry, mixed with hard boiled eggs, including shells, finely broken. This food is alternated with bread and clabber cheese, oat flake and egg, or cheese seasoned with a little salt and pepper. After the little ones are about a week old I begin mixing a little whole or cracked wheat, Indian corn, Kaffir corn, or millet with the cooked food, and thus they learn to eat grain. Always try to feed no more than they will eat up clean each time. When they are about a week old I begin to drop the white bread, and give them instead what I call a brown light bread made the same as white bread, using one-half white flour (a cheap grade will do) and the other half about equal parts of shorts and bran, with a handful or two of corn meal. The meal makes it crumble easily. The bread should be allowed to dry for a day or two before feeding; if fed fresh it may choke the poults. I gradually drop the white bread and eggs, and feed instead the brown bread and cheese. When about six weeks old they have become accustomed to the grain food, which since they were three weeks old has been kept by them in troughs, in coops so constructed that the little turkeys can get in and the older fowls are kept out. By the time the poults are nine or ten weeks old I have dropped the soft or cooked feed to once or twice per day. By September the older poults are dependent upon grain food and range. For fattening I had good results with a mixture of grains proportioned as follows:—two bushels whole corn, two bushels cracked corn, one bushel oats, one bushel Kaffir corn.”

(5). **An All Corn Ration.**—(CUSHMAN).—“Successful Rhode Island growers as a rule feed their turkeys from start to finish on northern white flint corn, which they grow themselves. They take great pains to feed nothing but well seasoned old corn, because they have found that new corn causes bowel trouble. Turkeys not only like northern flint corn best, and fatten best on it, but it makes their flesh more tender, juicy and delicious. That given the little ones is coarsely ground, and mixed with sweet or sour milk, or made into bread that is moistened with milk. This is gradually mixed with cracked corn, which when they are about eight weeks old, is fed clear or mixed with sour milk. In the fall whole corn is given. After June 1st those at full liberty are usually fed but twice daily. They are hunted up and fed in the fields, that they may stay away from the farmyard, and outbuildings. Many give the turkeys no food from August 1st until cool weather. They get their own living until they come up from the fields in September or October. Upon the approach of cold weather they come to the house to be fed, and thereafter roam but little.

“To fatten them for Thanksgiving, they are fed in November all the whole corn they will eat three times per day. It is not necessary to coop them. The full feeding causes them to rest and sun themselves. Dough is not much used for fattening in Rhode Island. One grower who gives it every morning, and whole corn at night, mixes condition powder with the dough, and finds it causes them to eat more and gain faster. Some raisers give a little new corn mixed with the old at this time, but most consider it safer to feed clear old corn. It is not best to heavily feed turkeys that are to be held for a later market, or those to be kept over for breeding.”

339. The Market for Turkeys.—The heaviest demand for turkeys comes at the winter holiday season. The bulk of the crop is marketed in about two months. Usually the best prices of the year are obtained for “Thanksgiving turkeys.” Through the remainder of the year there is a limited demand, and it will happen once in a while that prices are as good in the late winter as at any earlier time. It would be no object for the grower to hold marketable turkeys over the period of best demand, in expectation of better prices; but good prices in February and March may give him better profit on any late turkeys he may happen to have.

At some of the eastern summer resorts there has lately arisen a demand for *turkey broilers*, ten or twelve weeks old. At the prices obtained, growers near these resorts may find it as profitable to sell the turkeys at that age as to mature them for the winter trade. This demand is confined to a very few places, and it is as yet impossible to say whether it is likely to continue and become more general.

The description given in ¶ 276 of the kind of chickens in demand, applies also (with some slight changes which immediately suggest themselves), to turkeys. The popular demand is for medium to small turkeys. During Thanksgiving week twelve to fifteen pound turkeys command the best prices; but good stock of ten pounds (or even less; the buyer finds) weight brings good prices. Very large birds—as is the case in all kinds of poultry—go mostly to the hotel and restaurant trade, and do not bring as good prices as stock of the same quality in the weights required for the family trade.

340. Preparing for Market and Selling.—The information given in Chapter XII., in regard to marketing poultry, (see ¶¶ 269—271, 278—289), applies generally to turkeys. There are, however, a few points deserving special mention.

The turkey grower ought always to reserve as many of his best developed birds as he needs to replace breeding stock, or for his trade in breeding stock, if he carries on that trade. There is often a strong temptation to market the best birds when prices are best, and trust to the later birds developing in time to be sold or used as breeders. This is bad policy, and has doubtless done more than any other one thing to deteriorate flocks of turkeys.

It is very important to prevent the turkeys being frightened or bruised when caught for killing. A bruised carcass does not bring the price a perfect one does. The method of catching birds that have not been sheltered is thus described by Cushman:—

“The usual plan is to get the birds into a barn or carriage shed, and shut them in. In order to do this, they are fed for a long time in front of, or just within the place where they are to be caught. Later, the feed is placed within the building, and they become so familiar with it that they are unsuspecting when within. When they are to be caught, the doors of the building are suddenly closed; or a covered yard of wire netting is built in front of the building and closed when all are in. Usually when they find they are confined they become frightened, and fly back and forth, or huddle up in corners. * * * To overcome this drawback, certain raisers have improved the usual makeshift catching place by building a long, low, dark pen back of the barn or shed. This pen extends alongside of the building, and is at right angles with the entrance to it, and at the extreme end is about two feet high. Up to the time of their being caught, the end is left open, and the birds frequently find their way through it. When they are to be caught, only what the pen will comfortably take are driven in. They do not discover that the end is closed until it is too late to turn back. The turkeys that are not to be caught, are first driven away; otherwise they may be alarmed, and become unmanageable. No turkey that is thus caught, and has learned the mysteries of the trap is ever allowed to escape, or its suspicions would be communicated to the others. When shut in this pen they are quiet, and when a man goes to catch them, there is no struggle; he simply reaches out and takes them by the legs. The pen is too dark and narrow for them to fly, and too low for them to crowd one upon another.”

341. Selling Exhibition and Breeding Stock.—Preparing for Exhibition.—A breeder of fine turkeys who does not also breed other fine poultry, is likely to find it hard to sell them profitably, except what a local trade will take. Ordinarily the trade will not be large enough, or the prices obtained high enough to warrant advertising for turkeys exclusively.

With many exhibitors preparation for exhibition consists simply in taking the bird from the range to the exhibition coop. If the birds are to show themselves to advantage, though, they should be accustomed to the coop and to being handled and inspected before going to the show room.

342. Diseases of Turkeys.—Doctoring sick turkeys is mostly unprofitable business. It does not pay to attempt it except under conditions as stated

for chickens in ¶ 310. Turkeys are affected by many of the same diseases as chickens, and by a few which are either peculiar to the turkey or attack it in a different form.

Diseases most prevalent among and disastrous to turkeys, are:—

Blackhead—which has been long common and troublesome in the east, and frequently appears in other sections. According to Cushman:

“It is an infectious liver disease, similar in its nature to human dysentery. The disease takes its name from the fact that turkeys of a certain age, when affected, look shrunken, pinched, and purple about the head. Turkeys having the disease probably affect the land they run upon. The organisms are present in their excrement, and if taken in with food or water, may produce the disease in other turkeys. Sick birds should be killed and burned or deeply buried. Buildings, coops and feeding and drinking vessels which they may have contaminated, should be disinfected. Birds once having this trouble, even if they have apparently recovered, may still not be free from it, and be able to scatter infecting material. It is therefore not best to keep specimens that have ever been affected. Take great pains to clear out the sick from both young and old, and then if it is possible, change the well ones to new ground. Some turkeys resist infection where others succumb to it. Doubtless some have such vigor and power that they overcome or destroy infection if it reaches them.

“Little turkeys are most susceptible. They are infected early in life, and the disease develops fast or slow according to how numerous the organisms are, or to the strength of the turkey. Wet, stormy weather aggravates the disease. Their feathers look rough; they have diarrhœa, with bright yellow excrement; and they weakly drag one foot after the other for some time before they die. Here (in Rhode Island) they usually die in the latter part of July, early in August, and at the beginning of cold weather.

“In some cases both cœca are affected, in others but one, or a part of one. Those having but a small part of the liver invaded may live through the winter, and not die until spring.

“Prevention is possible, but cure is difficult. By breeding them to secure great vigor, by feeding to counteract any tendency to diarrhœa, and by giving preventive treatment upon the slightest symptoms of abnormal looseness, much may be done to help them resist this disease if they are exposed to it.

“A tonic and stimulant for the liver and bowels will help prevent the disease; confinement and over-feeding favor it. Pepper and ginger, and something sour are indicated as well as an astringent. Sick turkeys sometimes recover after they can eat all the acorns they want; they administer the astringent themselves. One beginner, after losing many little turkeys, reports that he cured a lot in two weeks by giving them a saturated solution of epsom salts in milk to drink, and nothing but grass to eat.”

Colds and Roup—see ¶ 313.

Gape Worms—see ¶ 313.

Rheumatism—see ¶ 313.

Tapeworms—are very common in turkeys, and often kill whole flocks of young ones. Freshly powdered kuosso is a highly recommended remedy. Tansy and pumpkin seeds are also recommended. See also ¶ 313.

CHAPTER XVII.

DUCKS.

343. Introductory.—The duck business as carried on by “duck farmers,” usually combines the growing of “green”* ducks for market, of stock for exhibition and breeding, and the production of eggs for hatching. Eggs are not produced specially for table use, as hen eggs are, and only a small per cent of duck eggs go to market. A few duck farmers confine operations to the growing of market ducks.

The duck business presents several features worth special mention:—Duck growing for profit really has to do with only one of the numerous varieties of ducks, that one being for the purpose far superior to all others. In striking contrast to the turkey—the general farmers’ fowl—the duck is a fowl for the specialist, peculiarly suited to intensive poultry keeping. Ducks are remarkably free from disease and vermin. They grow twice as fast as chickens and turkeys. Of all fowls they are most easily managed in close quarters. Some of their bad points—as well as the good ones—are to the advantage of the specialist. They are of all fowls the most difficult to dress properly, and the most unsalable when not marketed in nice condition. Thus in handling them skilled labor with convenient appliances has greater advantages over make-shift arrangements and unskilled or half-skilled labor than in any other branch of poultry keeping.

Until a few years ago the growing of green ducks for market, which is the principal branch of the business, was carried on only in a few localities within easy reach of New York and Boston; but of late, poultry keepers all over the country, excited by stories of large profits from ducks, have *tried* duck growing. Some large farms have been established at interior points, and thousands of poultry keepers have been producing ducks in quantities ranging from a few dozens to as many hundreds. Very few of those thus engaging in duck growing had any knowledge of the real condition of the duck market—further than that ducks were generally bringing much better prices than other poultry,—or realized how very limited was the demand for green ducks outside of the large eastern cities. The duck, has been, as a recent writer justly

* NOTE.—“Green” ducks:—quick grown ducks marketed at between two and three months of age—corresponding to soft roasters in chickens.

says: "more the food of the clubman and the epicure than the staple dish of the family." This was the case where the edible qualities of quick grown, grain fed ducks were pretty well known. Elsewhere the reputation of "duck" as a food was about as unsavory as the flesh of the common puddle duck, the only kind of which people generally knew anything. Consumers of poultry were apt to look askance at their poultryman when he tried to sell them duck as a delicacy, and at a higher price than chicken. Thus the growth of a popular taste and demand for ducks is necessarily slow, the more so because so many regular consumers of good poultry can eat duck only occasionally, or only in cool weather; or, perhaps, not at all. Under the circumstances, the first who tried ducks in each locality usually found it much easier to produce duck meat than to sell it profitably. The natural result was the congestion of the surpluses from all quarters in the few markets where the demand had been good. Following this came demoralization of prices, particularly in the latter part of each season.

Though the business has been temporarily overdone, well established farms are able to make a very fair profit; and duck growing still offers opportunity for a living or a part of a living according as one engages in it extensively and exclusively, or on a smaller scale in connection with other branches of poultry culture, or with some other business. Wherever good ducks are produced, the demand for them will steadily increase, and though it is neither likely nor — for the best good of the industry — desirable, that there should be a return to the high prices of earlier years, the inevitable adjustment of supply to demand will hold prices high enough generally to give the grower a living profit.

344. Profit From Ducks.—On large plants the estimated total cost of producing ducks is 6 to 8 cts. per pound. At the lowest prices yet reached this gives the grower a net profit of 15 to 20 cts. on each duck. As a large part of the product is marketed before very low prices are reached, the average net profit, at prevailing prices, should be about 25 cts. or more, per duck. At that figure a plant producing ten thousand to fifteen thousand ducks annually yields a substantial profit. A plant of such capacity, however, is not built in a season, nor is it every man who tries duck growing that can successfully manage such a plant. It represents a total investment of hardly less than \$10,000, and the ability to produce ducks at the cost figures given is gained only with years of practical experience. In a business conducted on a smaller scale the cost of production is greater, and the profit less. A plant which one man could manage, with a little assistance during the marketing season, would hardly do more nowadays than give him fair remuneration for his own labor. His net income would probably be about the same as that for the *one man* poultry business described in ¶ 4. The amounts credited to different items would differ; the totals would be nearly the same. This estimate, however, is merely suggestive. As a matter of fact, but one duck grower in a hundred

would find it advisable to run a duck business on a one man scale. Where an exclusive duck farm will pay it must be on a larger scale; elsewhere generally duck growing must be carried on as one branch of a combination.*

345. Ducks Adapted to All Sections.—Sites for Duck Plants and Houses.—The information given in Chap. II., ¶¶ 18, 20, 21, 23—26, applies generally to duck culture. Exclusive duck farming can be made profitable only near a large city, where there is good demand for ducks. A few ducks can be profitably grown almost anywhere. As has been intimated, the duck growers, like the breeder of high class chickens (¶ 19), awakens interest in and creates an ever-increasing demand for his product.

Though water fowls, ducks need a well drained soil and dry houses. For breeding ducks a pond or stream of water is an advantage, but not absolutely necessary. Natural shade is desirable. If there is none, artificial shade must be provided, for ducks are extremely sensitive to the heat of the sun.

346. Houses and Yards.

FOR BREEDING DUCKS.—Duck houses are built on the same general plans as houses for chickens. Either of the houses shown in Figs. 1 and 4, would make a good house for a small flock of ducks. For a very small flock a good sized coop may be used. The coop shown in Fig. 46, would do very well for a few ducks and a drake. On large plants the houses are usually built on the continuous plan, (see Figs. 11 and 12), modified to suit the ducks and the methods of duck keeping. The pens for ducks are generally larger than for chickens, and as it is desirable to have them as nearly square as it is practicable, most duck houses are wider, though some narrow houses are in use.

On one of the largest duck farms the pens are 15 x 20 ft., in houses 18 ft. wide, and of such lengths as are desired and the "lay of the land" permits. These houses are 6 ft. high at the back, where the walk is, and four feet high in front; with double pitched roof 12 ft. to the peak. In the south side (front) of each pen are two half-windows and a door to give the ducks access to the outside runs. In the north wall, opposite the middle of each pen, is a half-window for ventilation in warm weather. The partitions between the pens and between pens and walk are of boards, and are about 30 in. high. In the partition between each pen and the walk is a gate wide enough to admit a wheelbarrow when the pens are to be cleaned. In feeding, gathering eggs, etc., the gates are not used; the attendant easily stepping over the partitions. About forty breeding ducks are kept in each pen. The yards connecting with the pens are 20 ft. wide by 100 ft. long.

* **NOTE.**—In most places poultrymen growing both chickens and ducks, will usually find the latter more profitable as long as their home market is not over-stocked; especially is this true of those producing for a family trade. To illustrate:—A plant having an annual capacity of three thousand table chickens, old and young, may have trade that will take only twenty-five hundred fowls at profitable prices. There is then no object

On another farm the houses are built without walks; are 15 ft. wide, 8 ft. high in front, 5 ft. 4 in. high at the back, with shed roof. In the front are the doors to outside runs, and half-windows every ten feet. In the back, at the middle of each pen, is a half-window through which bedding is renewed and litter removed. For economy of construction and convenience in working, this style of house is hard to excel.

On still another plant thirty-five breeding ducks are kept in each 13 x 13 ft. pen, connected with which is a yard 26 x 125 ft., of which 26 x 36 ft. is water.

Fixtures.—The necessary interior furnishing of the duck house is of the simplest. When the ducks are fed and watered indoors, drinking fountains, feed troughs, and boxes for shell and grit, complete the furnishing. Some breeders feed outside. Nest boxes are not needed; duck keepers agree that fewer eggs are broken or lost when the ducks scoop out nests in the litter or earth, each one as it suits her.

Fences.—The yard fences, like the inside partitions, are low, 2 ft., 2½ ft., sometimes 3 ft. high. Wire netting attached to stakes driven into the ground, is used for fencing.

Brooder Houses, as described in ¶¶ 46, 47, and illustrated in Figs. 29—32, are used for ducklings.—Separate brooders are also used.—The partitions, both in the houses and outside, need be only 1 ft. high for the small ducklings.

DUCKS DESCRIBED.

347. Kinds of Ducks.—Fowls were described in ¶ 68 as:—*common*, or *mongrel*; *cross bred*; *grade*; *pure bred*, and *Standard bred*. These terms apply to ducks also, though crosses are much rarer than among chickens. Many flocks of so-called Pekins are grades produced by the systematic use of Pekin drakes on white ducks starting from common white ducks. Common ducks are often very good layers, but grow slowly, and their meat is inferior to that of the improved varieties.

348. Pekin Ducks.—Though White Pekin ducks may not merit all that is said of them by enthusiastic breeders, it is certain that without the Pekin duck the business could not have grown to its present proportions, and that as a market duck this breed has no rival. They are hardy, quick growers,

in producing to the full capacity of the plant. But, if without any diminution of sales of other poultry, five hundred ducks can be profitably sold—as in many cases they could be,—it would pay to raise that many ducks, and the ducks would probably pay proportionately better than the chickens. At the same time, it might be a bad mistake to suppose that because the ducks were paying better it would be wise to reduce the production of other stock, and increase the number of ducks grown.

prolific layers of large white * eggs, and thrive in close confinement. Standard

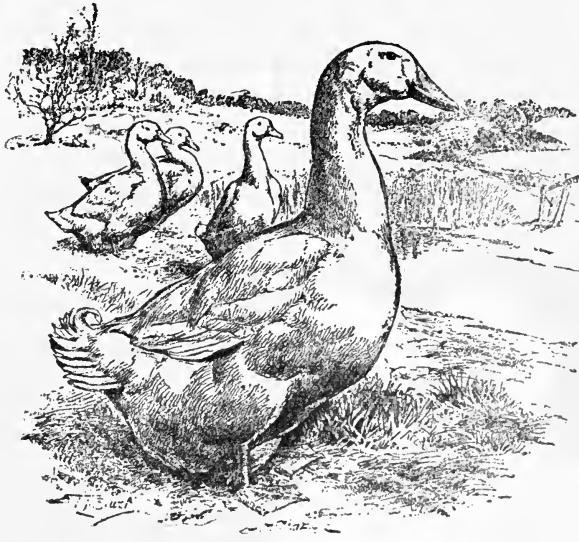

Fig. 89. Pekin Drake. (By courtesy of A. J. Hallock).

weights are: adult drake, 8 lbs.; young drake, 7 lbs.; adult duck, 7 lbs.; young duck, 6 lbs. The body of the Pekin duck is very long and deep, well rounded and full, both in breast and in the rear. The plumage, which is softer and more downy than that of other varieties, is of a faint creamy white surface color, with yellow sometimes quite strong in the under color. The beak is deep yellow, and

according to the Standard should be free from black marks. In adult drakes, black streaks and black knobs (at the end of the upper mandible), are rarely absent. Many breeders affirm that the most vigorous drakes usually show some dark color in the beak. The legs and toes should be of a reddish orange color. The principal faults are an exceedingly timid disposition, and the coarse strident voice of the female.

349. Aylesbury Ducks resemble the Pekins in a general way—they are large white ducks,—but have bodies more oval shaped; whiter, harder plumage; flesh colored beaks, and light yellow feet.

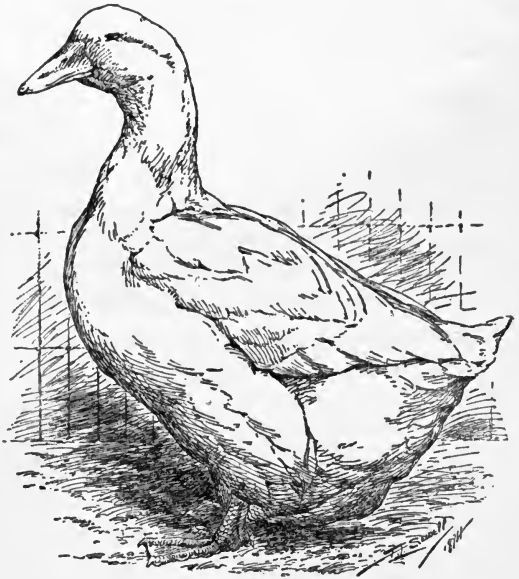

Fig. 90. Pekin Duck.

* NOTE.—From every large flock of Pekins, some green eggs are gathered. These are usually rejected for incubating. The birds producing them are supposed to have a taint of foreign blood.

According to the descriptions of this breed as grown near the English town from which it takes its name, Aylesbury ducks should be quite the equals of the Pekins in market quality and in capacity for quick growth. In the hands of the American growers they have so far been decidedly inferior. Standard weights are: adult drake, 9 lbs.; young drake, 8 lbs.; adult duck, 8 lbs.; young duck, 7 lbs.

350. Rouen Ducks have the same Standard weights as Aylesburys. In color they resemble the common colored ducks, though in well bred stock the

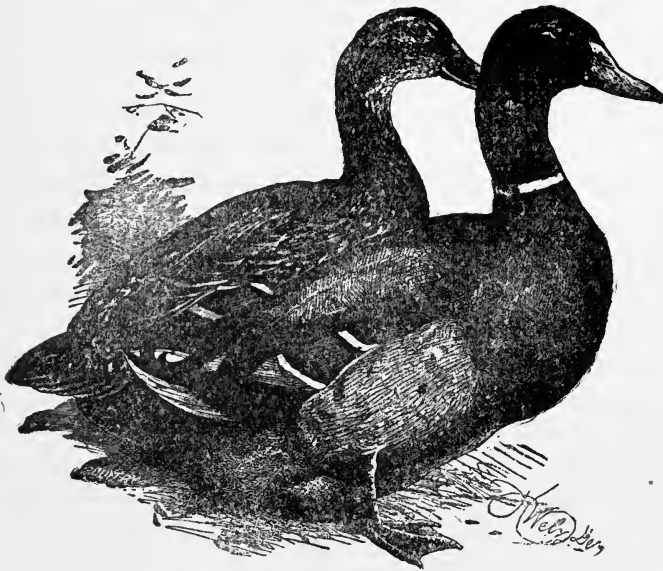

Fig. 91. Rouen Ducks. (By courtesy of "Poultry," England).

colors of the plumage are clearer, and in the male more brilliant than is usual in common ducks.* Considerable differences of opinion exist as to the merits of the Rouen duck. A result of the acknowledged superiority of the Pekins for the purposes of the duck farmer, has been to throw other varieties — no matter how many good qualities they possess — into the

shade. That good Rouen ducks are inferior to Pekins in vigor, prolificacy, capacity for rapid growth, or actual quality of meat, remains to be proved. The color of the Rouen is against it as a table duck. As the duck industry is principally the growing of ducks for the table and of stock from which to produce table ducks, the Rouen never can be seriously considered a competitor of the Pekin ducks in economical duck growing. It is a duck for the fancier and for those who keep ducks for home use, and do not object to the dark pinfeathers.

351. Cayuga Ducks have the same standard weights as Pekins, but probably average much lighter. They are classed as hardy, early maturing birds,

* NOTE.—Wright supposes the common colored ducks to be degenerate Rouens. It would be more natural to think the Rouen a vastly improved common duck.

and good layers. In color they are a lustrous greenish black,—the flight feathers of the females sometimes brownish. In most sections of the country they are rare.

352. Call Ducks are bantam ducks. There are two varieties: the *Gray*, in color resembling Rouens, and the *White*. They are kept only by fanciers, and as ornamental fowls.

353. Black East Indian Ducks are small black ducks, not common, and kept mostly for ornamental purposes.

354. Crested White Ducks are almost sufficiently described by their name: they are of medium size, and quite rare.

355. Muscovy Ducks are specially distinguished by the bare face with much carunculated skin, giving them a savage appearance, and a reputation for viciousness which the males, at least, richly deserve. Standard weights are: adult drake, 10 lbs.; young drake, 8 lbs.; adult duck, 8 lbs.; young duck, 7 lbs. They are reputed very poor layers. Before the advent of the Pekin the White variety of this breed was used by Long Island duck growers. There are two varieties: *Colored Muscovy Ducks* are black and white, irregularly marked, the black generally predominating; with dark colored bills, and legs ranging from yellow to black. *White Muscovy Ducks* have pure white plumage, flesh colored beaks, and yellow legs.

356. Indian Runner Ducks were but recently introduced into this country. They are small; Standard weights: males, 4½ lbs.; females, 4 lbs. Their color is a light fawn (or gray). They are valued chiefly for laying qualities. Rare, and not likely to become popular.

357. Buying Stock.—The remarks on buying stock, ¶¶ 111, 112, apply to ducks as well as to chickens. Prices of ducks and of duck eggs, while ruling about the same as prices of chickens, for good breeding and ordinary exhibition stock, (¶ 113), never reach the extreme high prices mentioned for chickens. As to starting with eggs or with stock, the remarks in ¶ 114 apply, except that Pekin duck breeders sometimes advise starting with eggs rather than stock when the shipment has a long distance to go. The ducks go off badly on a long journey, and are not likely to be worth much as breeders the first season in their new home.

358. Points on Breeding.—As much of the information contained in Chap. X., ¶¶ 193—214, as is of general application, applies to duck breeding. Points requiring special mention are:—

Selecting Breeding Stock.—

In mating ducks to produce high class stock, standard specimens of both sexes are in every variety used to produce exhibition specimens of both sexes; there are no double matings.

In mating ducks to produce market stock, deep keeled, meaty specimens, strong (not *coarse*) in bone, should be selected. They should have been hatched in April, May or June.* If rapid growth is desired in the offspring, it is advisable that the breeding birds selected should be known to have made quick growth; but table quality ought not to be sacrificed to quick growth, for the worst fault of ducks generally is that they carry too little meat for their weight.

If very early ducklings are wanted, young ducks must be kept to lay the eggs from which to hatch them. The young ducks lay a month or more earlier than the yearlings and two year olds. The older birds throw better ducklings. Most large operators have breeding birds of different ages, depend on the younger birds for early eggs, and use only eggs from older stock for hatching ducklings for breeding stock.

Number of females to a male.—The usual rule is *five* until June, after that *ten*. The birds are kept in flocks of twenty-five to forty of both sexes. Some breeders who have good water range, say that with it they can run one drake to seven, nine, or even twelve ducks throughout the season.

The breeding season covers as much of the laying season as the grower wishes. Some breeders hatch nearly every egg laid, continuing operations until late in summer; some hatch only for the period of good prices. The pens should be mated up early. If forced for eggs, some ducks begin laying about January 1st, (a few, perhaps, earlier); many will be quite a month later. Under ordinary conditions, the ducks in flocks not managed for eggs rarely begin laying before March. The laying season lasts until June, July, or August, varying for individual ducks, and depending much on the care and general condition of the flock. As to the average number of eggs laid, there are wide differences of opinion. Estimates placing the average at 160, 150, 140, have been given, but one well informed duck grower thinks the average for large flocks nearer to 100 than to any of those figures; and another states that in his own flocks the yearly product per duck varies from 100 to 135.

CARE OF BREEDING STOCK.

359. About Water Range.—Though some of the largest growers give their breeding ducks no water except for drinking, there are few who do not think access to a pond or stream of water, or a range on marshy ground a

*NOTE.—Some breeders use only April or May hatched birds; some say the June birds are just as good; all agree that very early and very late hatched ducks are not desirable as breeders.

decided benefit to the breeding stock. As is often said, they can *do* without it; they will *do better* with it. Swimming, paddling about in marshy places and along margins of streams, is to the duck what scratching is to the hen—a natural and favorite *exercise*. Ducks in all dry yards are in the condition of hens in bare yards and on bare floors—they have nothing to do between meals. The benefits of such exercise as can be secured in even a little pool just large enough for a few ducks to paddle in at once, are immediately noticeable when such a pool is furnished ducks which had been kept without water.* Water for bathing ought to be considered as necessary for ducks, as the dust bath is for hens. The important results of giving breeding ducks water range, are: greater fertility of eggs, more vigorous ducklings, and the birds themselves always looking *well groomed*.

360. Cleanliness is important. Feed troughs and drinking vessels should be kept clean. The floors of the pens are generally littered with cheap hay, shavings, or similar material, and cleaned out and the bedding renewed as often as is necessary to give the ducks reasonably clean dry bedding at all times. The yards need to be swept or scraped occasionally, and the accumulation of droppings removed. Many breeders so arrange that the yards can be disinfected by plowing up in the fall and sowing to rye. This serves the double purpose of purifying the soil, and furnishing green food for the ducks in winter and spring.

361. Gentleness and Quietness—are all-important in the duck yard. Pekin ducks are absolutely fearless until it has been necessary to catch some of them when they have grown too large to be taken easily by the body in the hand. After some of a flock have been caught by the neck, all become shy of the keeper, and if an attendant is hurried and reckless when moving among them, or if they are disturbed by visitors or dogs, the egg yield usually falls off. The breeding pens once made up, no birds should be removed. Stock for sale ought never to be kept with breeding stock.

362. About the Eggs.—When the ducks have access to water, it is necessary to keep them from it until all have laid in the morning. Usually

* NOTE.—Without doubt some ducks kept without water do better than some given constant access to water;—there may be differences in breed, feed, and general care; but as between water for swimming, or at least for bathing, and water for drinking only, it seems incredible that any one who has tried both *with the same ducks* could have any other opinion than that enough water for bathing is a necessity, and that more is desirable. Pekin ducks which have not been accustomed to water may seem shy of it if an attempt is made to drive them to water away from their quarters, and may hesitate, but not for long,—to plunge into a pool prepared for them in a yard where there had been none.

all will have laid by eight o'clock. (Ducks generally lay at night or very early in the morning). In cold weather eggs should be gathered as early as possible to prevent their becoming chilled. Soiled eggs should be washed at once, and in cold weather should be wiped dry after being washed. The eggs should be kept in a cool place. (See ¶ 229).

363. Feeding Breeding Ducks.—Ducks are fed mostly on mixtures of mill stuffs wet with cold water. Very few large duck growers cook the food, though some scald it in winter. Cooked food can be used if convenient, but unless the food must be cooked for other stock, there is no object in cooking it for the ducks. The common experience of breeders is that they do just as well on raw food. Many feed the ducks no whole grain at all. Their digestive apparatus is not suited to a diet composed largely of whole grain; still they appreciate a little of it occasionally. *There must always be water near the feeding troughs at feeding times*, and except in freezing weather, the ducks should have drinking water always accessible. Ducks are greedy, dirty feeders. They will consume a larger proportion of coarse bulky food than hens will; yet they are not as heavy feeders as is commonly supposed.* In general it is both economy and good feeding to give ducks fed a pretty good meal of grain stuffs morning and evening; all the green food they will eat during the day. Where ducks are kept in rather close confinement, the most common error in feeding is giving grain food too often, and not providing green stuff in abundance. Ducks need grit, shell, and charcoal.

Ducks ranging as many small flocks do, often find food which imparts a strong flavor to eggs and flesh. If the eggs are used only for hatching this is immaterial; if some of them are wanted for cooking, the ducks must be kept from the objectionable food. The rations given below are from well known duck growers. They present less variety than the rations given for hens and chickens (¶ 146), but the ingredients used are mostly such as may be obtained anywhere.

(1). **Ration for Breeding Ducks.**—(HALLOCK).—Four pails corn meal, 2 pails bran, 1 of middlings, 1 of oats, 1 of wheat, mixed with 2 bu. chopped grass or greens or chopped clover used when greens cannot be had.

(2). **Rations for Breeding Ducks.**—(RANKIN).—*During the fall* feed to both old and young stock 3 parts wheat bran, 1 part Quaker oat feed, 1 part corn meal, 5 per

* NOTE.—It is often said, even by those who should know better, that it is impossible to satisfy the appetite of a duck. Such statements lead people to think it much more expensive to feed ducks than to feed other fowls. A flock of grown ducks will not eat more than an equal number of average chickens; nor does it require more food to grow a duck than to grow a chicken of the same weight.

cent beef scraps, 5 per cent grit, and all the green stuff they will eat* in the shape of corn fodder cut fine, clover or oat fodder, etc. Feed this mixture twice a day, all they will eat.

For laying birds—5 parts wheat bran, 5 parts corn meal, 4 parts Quaker oat feed, 2 parts boiled potatoes or turnips, 3 parts of clover rowen, 1 of grit; add green rye or refuse clover cut fine. Feed twice a day all they will eat, with a lunch of corn and oats at noon.

(3). **Ration for Breeding Ducks on Grass Range.**—(POLLARD).—Feed night and morning what they will eat of a mixture of 3 parts Indian meal, 3 parts wheat bran, 1 part low grade flour, 1 part beef scraps; the whole salted slightly, and thoroughly mixed, not too wet, with cold water. Never cook the food except in winter, when it may be mixed with hot water. *In winter* give a liberal allowance of boiled turnips mashed in with the grain, say one-third turnips every other morning, and give cabbage or any other green food obtainable at noon.

(4). **Rations for Breeding Ducks.**—(WEBER BROS.)—In fall keep on grass range, and feed light. From the middle of November, when put in laying houses, until December 15th, feed equal parts shorts and ground oats, to which add five per cent beef scraps; give this twice a day, morning and evening; give green food at noon. After December 15th give full laying ration: equal parts corn meal and shorts, with ten per cent beef scraps added. If green food is not available add one-fifth cooked vegetables to the mash. Give raw vegetables at noon two or three times a week.

HATCHING AND REARING.

364. Which Method?—In duck growing on a large scale, only artificial methods of hatching and brooding are used; small growers frequently use hens. (Ducks are rarely used to incubate their own eggs. The Pekins are non-sitters). If one has the hens, it may pay better to hatch with them when not more than a few hundred ducks are reared; but to get or keep hens expressly to hatch ducklings, would be very poor policy. In any case when more than two or three hundred ducks are to be hatched, artificial methods should be used.

365. Hatching in Incubators.—The artificial method as described in Chapter XI., ¶¶ 253—259, applies to duck eggs, except in the few points noted below:—

The period of incubation for duck eggs is twenty-eight days.

They require more ventilation than hen eggs, because the egg is larger, and therefore more difficult to dry down, and because it has to be dried down to an air space proportionately larger than in the hen egg, (see Fig. 79). A larger air space is needed to give the larger head and bill of the duckling room to work.

Operators advise cooling duck eggs longer than hen eggs.

* NOTE.—If the food contains too much green stuff, the ducks eat the grain and as much green food as they want, leaving the remainder in the troughs.

Ducklings generally pip the shells thirty-six to forty-eight hours before leaving them. If unable to get out themselves after the twenty-eighth day, they may be helped out, and will generally "make a live of it."

366. Brooding Ducklings.—The ducklings are usually left in the machines for twenty-four hours, or longer, before being removed to the brooders. In small brooders not more than fifty ducklings should be kept together; as many as one hundred and fifty may be started in each pen of a large brooder house. Temperature and ventilation should be according to instructions for chicks in ¶ 260. For the first few days the ducklings must be confined quite near the heat, not allowed to get far from it. In the piped brooder houses they are kept near the hover by boards just long enough to reach across the pens placed at the desired distance from the front of the house, about a foot from it at first, the distance increased a little each day, until at four or five days the ducklings are allowed full run of the pens. Ducklings do not need heat as long as chickens, and at three to six weeks of age, according to the season, are able to do without artificial heat, and may be removed to cold houses.

367. Feeding Ducklings.—The instructions as to methods of feeding incorporated with some of the rations given below, cover the ground quite fully. It is well, however, to impress it on the novice that ducklings must always have water near their food when eating, and that sand or fine grit with the first feeds is essential.

(1). **Rations for Ducklings.**—(RANKIN).—First three or four days:—1 part hard boiled egg, 3 parts stale bread crumbs; after that equal parts of corn meal and wheat bran, with boiled potatoes and a little beef scrap.

(2). **Rations for Ducklings.**—(HALLOCK).—*First week*—equal parts of corn meal, middlings, crackers or stale bread, and green stuff; mix in a small handful of sand to each quart of food. Give occasionally bread soaked with milk for a change. *Second week*—4 parts corn meal, 2 parts wheat bran, 2 parts middlings, 1 part beef scraps,—sand; mix with about one-third the quantity of green stuff. *At about six weeks* put ducks in fattening pens, and feed $\frac{2}{3}$ meal, the remainder about equal parts of bran, middlings, and greens; add about 12 per cent of the whole beef scraps.

(3). **Rations for Ducklings.**—(COOPER).—First three or four days—soaked bread, or cracker dust, and hard boiled eggs chopped fine, mixed and fed moist. Then feed bran, corn meal, shorts, and a little beef scrap—increasing the amount of beef scrap as the ducks grow older—mix well and feed moist. Gradually add vegetable food, consisting of boiled roots, turnips, potatoes, etc., or green oats, rye, corn fodder, or clover cut fine as possible in a feed cutter; mix the roots and grass with the feed. A growing duck may be fed one part green food to two parts grain mixture to get a large frame. The last two weeks before marketing shorten up the green food, and give more corn. Too much green food makes the duck soft and flabby, and injures its sale. By fattening on

grain the flesh is made firm, and will "stand up," as the dealers say. Fish is an excellent food for young ducks, but if very much is fed it taints the meat. The "beef scrap" duck is the best flavored, and will bring the best price.

(4). **Rations for Ducklings.**—(POLLARD).—At first feed— $\frac{3}{4}$ wheat bran, $\frac{1}{4}$ Indian meal, wet to a crumbly mass with milk, either skimmed or whole, but not cooked. Cover floor in front of hover for some distance with fine gravel or sand; six or eight inches from the hover place small dishes containing food slightly sprinkled with sand the first time, and a fountain of lukewarm water. After all this simply keep the ducklings warm, and let nature work. If worth rearing they gradually get out from under the hover, and it is astonishing how quickly they will begin to stow away the food and water. Keep food before them all the time for the first three days, and water all night. After this they may be fed every three hours, till seven or eight days old. After the fifth day they may be fed 5 per cent of beef scrap instead of milk, or both may be given. *At two weeks* make the food $\frac{1}{2}$ meal, $\frac{1}{2}$ bran, and add 10 per cent beef scraps. *At three weeks*—3 parts each of bran and meal, with 1 part low grade flour, and 15 per cent beef scraps; continue this food until killing time, not changing for any heavier or more fattening food. After the fifth week feed only three times a day. Feed green food, or not, as convenient; it is good for those intended for fattening, but not necessary for market ducks.

368. Hatching and Brooding With Hens.—For the management of sitting hens see ¶¶ 232—235, 238—244. The principal faults of hens as duck mothers are that they usually trample too many ducklings in the nests—more ducklings than they would chicks; and that hen brooded ducklings are apt to be affected with lice. The first fault may be partially remedied by removing the ducklings as fast as hatched, returning them when the hatch is complete, and they are stronger. For the other the hen should be treated with insect powder, and the ducks provided with drinking pans deep enough to allow them to get their heads entirely under water. The hens must be kept confined to coops, such as are used for hens with chicks, and the ducklings to pens built around or adjoining the coops. If the coops are reasonably tight and warm, the ducklings require brooding only about three weeks in moderate weather. In warm weather they pay little attention to the hen after the first few days. If the grower is raising chicks and scalding or baking food for them, it can be used for the ducklings as well; it will not be necessary to prepare food specially for them. Some authorities say food for ducklings must be *wet* (besides there being water to drink at hand) or they cannot swallow it. In that they are wrong. Coops and pens should be kept clean.

369. Management of Ducklings After Weaning is the same, whether previously kept in brooders or with hens. Those intended for market will be grown quicker and at less cost if given only as much yard room as they need to keep themselves and their yard decently clean,—when the keeper does his part at regular and not too long intervals. The flocks should not be too large; one of the best authorities on the subject gives fifty as the largest number that should be kept together. The market ducks grow faster if not given water for swimming.

Ducks designed for breeding are better if given more liberty from the time they are weaned; but the usual practice is to run all the ducklings together in close quarters until they are of an age for marketing, then sort out those wanted for breeding, give them more liberty, a grass, and, if possible, a water range. In sorting stock novices are often at a loss to know how to distinguish the sexes. After they are about five or six weeks old the ducks "quack" loudly when caught; the drakes give a low sound between a quack and a hiss; or sometimes make no noise at all.

370. Selling Ducks.—The ducks produced on large farms are always sold dressed, and go mostly to wholesale dealers. Small growers, remote from the large markets, must be governed by the conditions of their markets. In some places it pays better to sell the ducks alive, in others to dress them; generally the best profit is obtained by selling direct to consumers. Green ducks are marketed at nine to twelve weeks old, and should weigh nine to twelve pounds to the pair; the average weight is rather more than ten pounds per pair. The demand for them begins in April (a little) and May, and the highest prices are obtained in those months. Early in the season, when prices are high, with a tendency to take big drops, many ducks are marketed at nine weeks old; later they are held longer. If not killed before the pin-feathers of the adult plumage start, (at eleven to fourteen weeks, the exact time being determined by inspection, and, by the expert, quite accurately by the general appearance of the ducks), they must be held for a month or more longer, until the plumage has grown enough to make clean picking possible. At this time they weigh heavier and are really much better ducks, their flesh being firmer and better distributed; but, if from large stock, they will be too large for the general trade, and growers try to get all ducks marketed at the earlier age. The ducks of an age for market are sorted the day before the killing. In catching they are taken by the neck. If caught by the feet, there is danger of dislocating the legs. Those to be killed are kept without food.

371. Killing and Dressing Ducks.—If the feathers are to be sold, the ducks must be dry picked. The feathers will very nearly pay the cost of picking. For the eastern markets only dry picked stock is wanted. As experts say that while it requires more experience to properly dry pick a duck, that method, once learned, is easier and quicker, it will pay one who is dressing many ducks to learn and use that method, even though his market does not require it. Cushman thus describes the methods of killing and dry picking:—

They are stabbed in the back of the roof of the mouth,* after which they are stunned by a blow with a club, or by striking the head against a post. The latter is said to be

* NOTE.—As to the manner of holding the bird when making the cut, Rankin says:—"The bird should be held between the knees, the bill held open with the left hand, and a cut made across the roof of the mouth just below the eyes." McPetridge's method is:—"Take the duck under the left arm with its head in your left hand, etc."

less apt to disfigure them.* The picker sits beside a box (for the feathers) about level with his knees, with the duck across his lap. He holds its head between his knee and the box to prevent its fluttering and soiling the feathers with blood. In removing them his hand is frequently wet in a dish of water. This causes the feathers to stick to it, and enables him to grasp and pluck them with little effort. The wing, tail, and hard feathers are thrown out; the others are saved. They are usually removed by a sharp jerk in the opposite direction from which they lie, the skin meanwhile being drawn taut. If very tender the skin at the roots of the feathers is held between the fingers, and they are pulled out straight a few at a time. The pin-feathers are wet down to cause them to stick to the hand, and then caught between the thumb and the blade of a knife held in the hand. The soft feathers are left on the wings, and the head and neck are not plucked. The ducks are not drawn or headed. The wings are held in place by a string tied about the body. The legs are washed, and the blood washed from the mouth and head. The ducks are soaked in fresh water for a time, then put in ice water. If placed breast down the abdomen will look more plump and attractive in shape after they harden. The small stern bones which otherwise would stick out, are previously bent down.

Scalding Ducks.—Ducks are killed for scalding as described for chickens, in ¶ 282. The method of scalding is described in ¶ 284. The plumage of the duck being more dense, the scalding takes a little longer. Some pickers wrap the scalded duck in a blanket, and let it steam a few minutes; but this practice is condemned because it partially cooks the skin, thus spoiling the appearance of the duck.

372. Packing and Shipping instructions are the same as given in ¶¶ 286—288, but in packing ducks they should be placed breast down, in barrels; and in boxes, breast down in the bottom layer, and up in the top layer.

373. Exhibiting Ducks.—Ducks should require little preparation for the show room. Here is where the superiority of a water range is undeniably evident. Ducks which have always had the opportunity to keep clean are brighter, more sprightly, firm in plumage. Showing is very hard on ducks, especially on the timid Pekins. They lose weight rapidly. Some breeders will not show the same ducks twice in a season, and will not show at all except at shows early enough to leave them time to get the birds in breeding condition again early in the season.

374. Diseases of Ducks.—Ducks that are at all well cared for are rarely sick. Sick ones are *better dead*. There are no diseases peculiar to ducks, but ducks which run with other fowls sometimes contract diseases from them. Damp quarters often cause lameness. Occasionally a duck will show slight symptoms of cold—a frothy scum covering the eyes. They should be washed clean with warm water containing a little carbolic acid, and the bird treated for a cold (¶ 313). If the cold is at all severe, it is better to kill the duck.

* NOTE.— By preventing proper bleeding.

375. Feather Pulling is a common vice among ducklings kept in large numbers in small yards, and a difficult one to deal with. There is no sure cure. It begins when the large quill feathers of the wings are coming through the skin. They often cause bleeding, and curiosity and the taste of blood develops the vice. If taken in time, much may be done to stamp it out. At first both victims and offenders are few in number, and if they are removed, or even if the offenders only are removed, there is no further trouble. If the vice becomes general, about all that can be done is to feed heavier of meat, and try to keep the ducks busy. A few large bones with a little raw meat adhering, placed about the yard, will help in this.



CHAPTER XVIII.

Geese.

376. Conditions of Profitable Goose Culture.—The goose, like the turkey, is a fowl for those who can give it *room*, and is generally made profitable only where it can pick the most of its living. While geese cannot be advantageously kept in close confinement, they are not rovers—like turkeys. They are contented on a comparatively small range, and easily kept within the bounds allotted them. Geese are grazers. Grass and weeds, when they can be had, form the greater part of their food. Given a dry place to sleep in, they can live and thrive on low marshy ground suitable only for water fowls.

Goose growing is nowhere in this country carried on as an exclusive business; nor is it carried on extensively except in a few localities near New York and Boston, and by a few large breeders of thoroughbred poultry. In most places geese are rare in comparison with other fowls, and though they come in large quantities to some of the big western cities, the demand for them is relatively light. The fact is that outside of the eastern localities alluded to, most of the geese sent to market are of rather inferior quality, and the reputation of “goose” meat is about on a par with that of “duck” where really good ducks are unknown. Even in the cities where the supply of first class geese is best, the demand for them is small as compared with the demand for chickens, turkeys, or even ducks. Still the present supply of good stock does not equal the demand, and one situated favorably for raising geese near one of these markets would, if reasonably successful, make a very good profit on as many as he could conveniently manage. Even in favored localities growers generally do not think it advisable or practicable to attempt growing geese on such a scale as chickens and ducks are produced. In most places growing geese for market ought to be undertaken only when the conditions are such that, whatever the income from them, it is nearly all profit.*

* **NOTE.**—It may be said here, as was said of ducks, that a good product will gradually create a better demand;—but geese cannot be successfully grown in confinement, as ducks are, and one who could give them room for exercise but not for pasture, and was therefore at expense in feeding them, would introduce and create a demand for good geese only to find that as soon as there was an evident demand, persons conveniently situated for keeping geese without cost would supply it at prices with which he could not compete. It will undoubtedly pay those who now keep poor geese anywhere with some profit, to get better geese; and many people who do not keep geese at all could do so with profit. The poultryman who is crowded for room had better let geese alone.

377. Profit in Geese. Growers say that geese are more profitable than ducks, but cannot be grown in such quantities. Goslings—green geese—are produced at about the same cost as ducks (6 cts. to 8 cts. per pound) when they are fed heavily; at less cost when they have good pasture. The prices for good stock range from 35 cts. per pound at the beginning of the season, in June, down to 15 cts. later. Some growers sell the goslings at five or six weeks of age to fatteners. It is reported that in a series of years, one, perhaps the largest grower in New England, received for goslings at this age an average price for each year not lower than \$1.09, and from that up to \$1.17. In this case the cost of raising the goslings, aside from the labor, was not great; but it is to be observed that the breeding stock from which he produced in one season nearly eleven hundred goslings, represented an investment of about \$500,—possibly more. In sections where there is not much demand for geese, the profit is never large, even when the expense of growing them is small, for prices are usually low. Growing mongrel geese—hybrids of the wild and domestic goose—is for those who have skill and facilities for it, the most profitable kind of goose raising. Mongrel geese of 12 to 14 lbs. weight sell readily at the holiday season for double the price of other geese.

378. Shelters and Fences.—Geese need little shelter, a low shed to protect them in bad weather being sufficient. A fence of almost any kind, wire, boards, or pickets, will do for geese. The height for the heavier breeds need not be greater than two or three feet. For those better able to fly, the fences should be higher. It is sometimes necessary to clip one wing of each bird.

379. Kinds of Geese.—The kinds of geese are:—*common*, *cross bred*, *grade*, *pure bred*, *Standard bred*, and *mongrel*. As applied to geese, some of these terms are not used in the same sense as when applied to chickens (¶ 68).

Common geese are—presumably—descendants of early importations brought from Europe by settlers. They are usually rather small, hardly larger than good sized ducks of the Pekin, Aylesbury, or Rouen breeds.

Cross bred is applied by goose breeders to the offspring of cross matings of pure breeds, and also to the offspring of thoroughbreds mated with common geese.

Pure bred, thoroughbred, and *Standard bred* have the same signification as in ¶ 68.

Mongrel geese are true hybrids, and sterile. They are produced by crossing wild and domestic geese.

BREEDS OF GEESE DESCRIBED.

380. Toulouse Geese attain the greatest size, often exceeding the Standard weights, which are :—adult gander, 20 lbs. ; young gander, 18 lbs. ; adult goose, 18 lbs. ; young goose, 15 lbs. In color they are *gray*, upper surfaces dark gray, shading to lighter gray on the breast, body, and thighs, with white

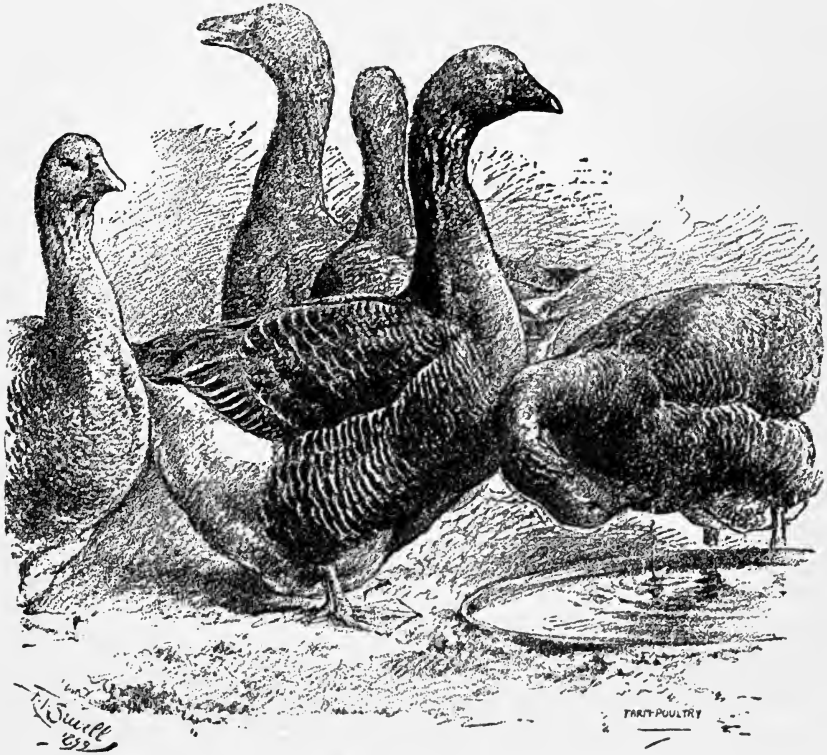

Fig. 92. Toulouse Geese.

on the belly. Bill and legs are a reddish orange. The females are good layers, young geese laying 18 to 24 eggs in the season, and old ones 30 to 36 or 40. This breed is by far the most popular, though for the market it is considered inferior to some others. They are quiet, and the best suited to range without water.

381. Embden Geese have the same standards for weight as the Toulouse, but run smaller. In color they are white, with bill and legs orange yellow. They are less widely distributed than the Toulouse, and many of the Embdens in this country are very poor specimens. As layers they are rather poor. They dress better for the market than any other breed.

382. African Geese.—Rare in most sections, but some large flocks kept. Weights same as for Toulouse. Color *gray*; upper surfaces dark gray, under surfaces lighter; neck light gray, with longitudinal dark stripe on back; bill black, with large knob at the base of the upper mandible; prominent dew-lap under the throat on exhibition birds, inconspicuous or absent in many

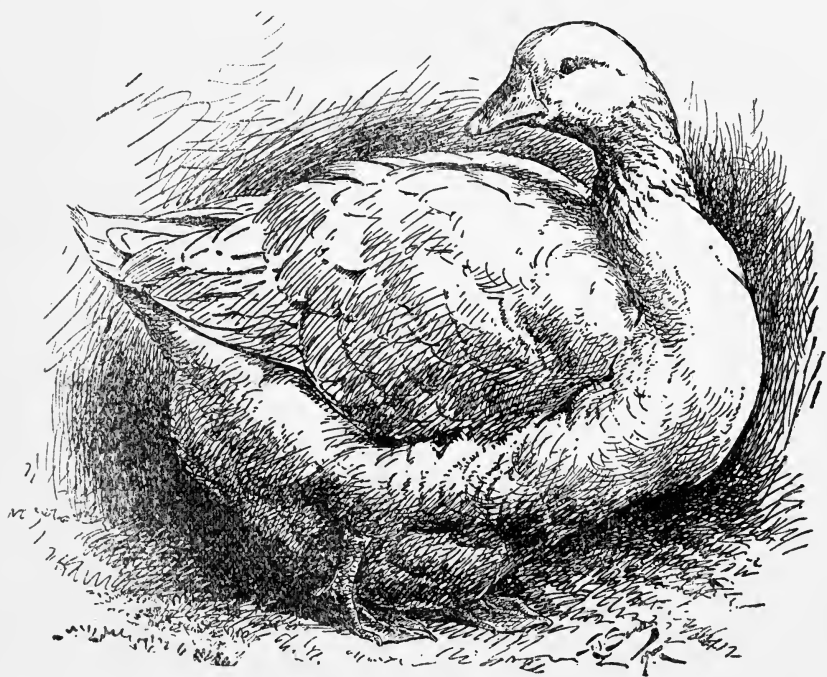

Fig. 93. Embden Goose.

specimens; legs dark orange. Better layers than Embdens; not as good as Toulouse. Very difficult to dress, adult birds especially so. Having dark pin-feathers and down and a dark skin, do not make as attractive a carcass as the white breeds.

383. Chinese Geese in shape resemble the African, and have also the knob on the beak, but are smaller. Standard weights: adult gander, 14 lbs.; young gander, 10 lbs.; adult goose, 12 lbs.; young goose, 8 lbs. There are two varieties:—

BROWN CHINESE GEESSE—resemble Africans in color as well as other points mentioned. They are the most prolific of all varieties. The females generally lay forty to fifty eggs each in a season, and the eggs are remarkably fertile. It has been said that of all breeds they pluck hardest, and look worst when dressed.

WHITE CHINESE GEESE—are usually smaller than the Brown. In color they are pure white, with orange yellow bill and legs. As layers the females equal those of the other variety, but their eggs are apt to be infertile. When dressed they rank next to the Embdens.

384. Wild or Canada Geese—are of a different species from the domestic goose, and in structure and habits more resemble swans. Standard weights are the same as for the Chinese. Color very dark gray; bill and legs black. They are often kept in captivity as ornamental fowl, and in such circumstances rarely breed. When bred to produce birds for breeding mongrels they are given more liberty. One wing is crippled to prevent flight.

385. Egyptian Geese.—Standard weights: adult gander, 10 lbs.; young gander, 8 lbs.; adult goose, 8 lbs.; young goose, 6 lbs. Purely ornamental fowls, handsomely colored with black, gray, and buff; bills purplish, legs reddish yellow.

386. Buying Stock.—For the goose breeder it is particularly desirable that stock should be purchased early in the fall. If purchased near the beginning of the breeding season, the birds may not mate satisfactorily; and as the female is not likely to lay well until acclimated and accustomed to new surroundings, the better part of the season is lost even when the birds do mate. Old birds are more desirable as breeders than young ones. Females are said to be profitable up to ten or twelve years of age, and males to the age of six or seven years. Thus when once one has secured a flock of mated birds of such numbers as he requires, he may if so disposed, sell his entire product each year for a number of years, retaining only his original stock birds. Prices for ordinary good breeding stock are from \$3 to \$5 per bird. Eggs are sold generally at so much apiece, — 25 cts. to 50 cts., — or at so much a dozen — \$2.50 to \$5.

387. Mating — Points for the Breeder.—(See also ¶¶ 193—214). Standard specimens of both sexes are used in matings to produce exhibition stock, in all varieties of geese, and generally by growers using thoroughbreds to produce market stock, most of whom sell as many as possible of their best birds for breeding.

In breeding geese for market only, cross breeding is usual in the localities where geese are grown most extensively. A mating preferred by one of the best growers in Rhode Island is:—African ganders with common white or gray geese. This mating gives goslings larger than common stock, less difficult to pick, and more attractive when dressed than the African.*

* NOTE.—Numerous crosses have been made on an experimental scale at the Rhode Island Agricultural Experiment Station. The results are of great interest, indicating

The mongrel, hybrid, geese so famous in the markets, are usually produced by mating wild males with domestic females, preferably dark ones,—African, Toulouse, or Brown Chinese. The reverse mating,—domestic male with wild females—is sometimes used, but the other is better, as the wild females lay few eggs. The wild ganders do not mate until two or three years old, and often will not mate the first year in captivity. Usually they mate with but one goose.

How Many Females to a Male?—From one to four. Geese are disposed to pair. Young ganders often take up with only one goose. Older birds will generally mate with more. One breeder of Toulouse geese allows two geese to each gander. A breeder who gives his numerous matings a common range, mates four geese with one gander; yards them by themselves the first season, and puts two or three extra ganders with the large flock.

388. Care of Breeding Geese.—Geese at pasture require little attention. If kept in confinement, they must be provided with green food, not fed too heavily on grain, and care taken to prevent their becoming too fat, and unfit for breeding. They should always have water for drinking, and frequently for bathing. If shut up at night, the place must be cleaned at regular intervals. Geese do not generally lay until near spring, though occasionally some lay in January. Boxes or barrels containing straw, hay, or suitable litter, are placed in corners and out of the way places for nests. In cold weather the eggs must be removed to prevent their being chilled. It is advisable always to have a nest egg—not necessarily a goose egg—any kind will do. To break up broody geese they should be removed for four or five days, and the nest in which they have been laying destroyed or removed to a new position before they are returned. Methods of feeding do not differ much, variations being due mostly to differences in pasture.

how by crossing a market breed superior to any of the established breeds might be produced. For the ordinary breeder the wisdom of crossing except under conditions as stated in ¶ 69, or to produce something exceptional, as the mongrel goose, is questionable. For those who may find it advantageous to make crosses, results of a few of the best crosses made at the experiment station are quoted from its report:—

“The Embden-Toulouse * * * would appear to be the best all around cross for general purposes, for both early and late markets, and especially for the production of large geese for the Christmas and New Year’s markets. They are large, hardy, and when dressed present a fine appearance.”

“Of those here compared (African-Toulouse, Toulouse-Emdben, Emdben-African) the Emdben-African seems to be next in desirability, and if goslings are sold early in the summer, or before they are eight weeks old, this cross would be preferable to all others.”

“The Emdben-White China cross picked the easiest of these crosses, were white when dressed, and although small, presented the most attractive appearance.”

(1). **Feeding Breeding Geese.**—(WILBUR).—Turn out on pasture from June until fall; feed no grain while grass is available, then feed lightly of oats and whole corn. After February 1, give full ration:—a mixture of corn meal, shorts, beef scraps, boiled potatoes or turnips in the morning; whole grain in the afternoon.

(2). **Feeding Breeding Geese.**—(NEWMAN).—They must have a pasture where from early spring they will live almost exclusively on green rye, clover or grass, needing but little grain, and thriving well. Do not feed much corn in winter, as it is apt to get them too fat for breeders. Oats and barley are better. The way I feed is this:—I take some boxes about eight inches deep, and put the grain in them. These are placed in the pasture away from other fowls. One need not be careful in feeding them as in feeding other poultry. You cannot spoil their appetites, and by putting boxes of grain in the runs, they get a good run, and a light feed, and are in no danger of overfeeding. Give corn only in the hardest weather — when it is storming, or there is so much snow they cannot go foraging.

(3). **Feeding Breeding Geese.**—(RUDD).—Adult geese can be turned out to pasture precisely the same as cattle, and in this latitude (Massachusetts) will obtain their own living more than six months of the year, during which the cost of keeping them is simply the value of the grass consumed. Through the laying and breeding season, in addition to grass they should be fed twice a day with shorts and Indian meal, equal parts, thoroughly moistened with cold water, but not too wet, lest it produce diarrhœa; the mass should be dry enough to crumble. (If stale bread can be had at reasonable prices, soak it and use instead of shorts). Add ten per cent of beef scraps or its equivalent. Feed all they will immediately eat up clean. Supply shell liberally, and abundance of water to drink.

389. Hatching Goslings.—As geese lay so few eggs, breeders usually keep the geese laying as long as possible, and hatch most of the eggs with hens. So far, hatching goose eggs in incubators has not been satisfactory. The hens are given five, six, or seven eggs each, according to size. After five or six days the eggs can be tested, and infertiles removed. The period of incubation is usually thirty days. It may be a little longer. When the eggs are hatching the hens should be closely watched to prevent the goslings being trampled upon or killed by hens that will not own them. The goslings, as hatched, should be given to quiet, gentle hens, or wrapped in flannel and kept in a warm place.

When geese are used to hatch the eggs, they may be given about fifteen each. Usually they must be set where they have been laying. They will bear little interference when incubating.

390. Rearing Goslings.—The goslings should be allowed to remain warm and quiet for at least twenty-four hours after hatching, and for the first few days every precaution must be taken to prevent their being chilled. By the time they are a week old they need no artificial heat if the weather is at all moderate. They do not require much care. Until strong enough to have full liberty they should be confined to small movable pens, which can be moved to new grass each day. With each pen some sort of shelter must be

provided to protect them from sun and storm. Their sleeping places must be kept clean. Other items of management requiring special mention will be found included in the methods of feeding given below :

(1). **Feeding Goslings.**—(NEWMAN).—The first two or three days keep them in a warm place, and give them a little soaked bread and water. In nice weather, turn them out in small inclosures which can be moved every day. After a week, let them go. The first four or five weeks, give nothing but stale bread occasionally; but always leave them at liberty to get all the grass or clover they want. Do not soak the bread, as they do not like it so well. After five weeks, give a mash of $\frac{3}{8}$ bran and $\frac{1}{8}$ corn meal. *To fatten* — after six weeks, feed $\frac{1}{2}$ bran, $\frac{1}{2}$ corn meal; do not feed it sloppy. Never allow goslings to go to the water until fully feathered, and then only let those go which are to be kept for breeders.

(2). **Feeding Early Goslings.**—(RUDD).—They can be fed at first on $\frac{1}{2}$ Indian meal and $\frac{3}{8}$ shorts, wet cold, and squeezed almost entirely dry. Sloppy food must be avoided. They should be fed as often as hungry, which will be at least every two hours — perhaps oftener. The important points at this stage are to keep them warm, dry, and supplied with food. As they grow older they need outdoor air and exercise. As spring advances and grass begins to grow, they can be put in movable pens on the grass. When three or four weeks old (depending on the weather, condition of grass, etc.), they should if possible be given a wide range — turned out to pasture; but the enclosure, of whatever size, should be fenced gosling proof. They should be fed twice a day with $\frac{3}{4}$ shorts, $\frac{1}{4}$ Indian meal, thoroughly wet, then squeezed or pressed dry — all they will immediately eat up clean. The drinking vessels should never be empty. *If they are to be fattened*, they should be confined and fed less shorts and more meal, adding some beef scraps; gradually increasing the proportion of meal and beef scraps until shorts are discontinued, and the food is about 10 per cent beef scraps and 90 per cent meal.

(3). **Feeding Goslings.**—(CUSHMAN).—Goslings are better off if they get nothing but tender grass and water the first day they are put out, or before they are 48 hours old. The next day they should be fed two or three times, but very lightly, with scalded cracked corn. This is probably as good food as can be given from then on, provided they have at all times an abundance of tender grass to eat, and the amount of cracked corn fed is such as will always leave them hungry for grass. An exclusive diet of grain or dough, without plenty of grass, or too great a quantity even with grass, will spoil them — cause them to lose the use of their legs, and die. If grain is fed sparingly while they are young, grass being three-fourths of the food, few will be lost. To make the best growth they should have succulent green food before them while they can see to eat. If shut in for a short time morning or evening, or on a stormy day, they should have a continual supply of freshly mown rye, oats, clover, or corn fodder. Otherwise they will fret and lose much in weight. When the object is to raise show birds of great size and frame at maturity, it may be best to feed oat meal, gluten feed and bran liberally, as well as corn and grass or clover; but there will be less uniformity under this feeding, and more will be lost.

391. Marketing Geese.—Goslings of the large breeds should weigh 9 lbs. to 12 lbs. each at ten weeks of age; some may weigh more. As a rule it pays better to market them at that age than to hold them until mature. Mongrels are reserved for the holiday trade, for at that time they bring more per pound

than any green geese but the earliest on the market bring in summer. The demand for green geese begins about June 1st, and geese are in demand from then until March.

Methods of KILLING, DRESSING, PACKING, and SHIPPING, are practically the same as for ducks, and do not require special description. Remarks on EXHIBITING ducks apply also to geese.

392. About Plucking Geese for the Feathers.—Whatever may be said in justification of this practice, the fact remains that it is cruel. It is also questionable whether on the whole it is profitable. To the frequent plucking of geese it is no doubt largely due that so many of those sent to market are of very poor quality. A goose which goes through an enforced moult four or five or more times (some authorities (?) advise plucking every six or seven weeks) cannot produce meat of fine quality;—the flesh is sure to be tough and stringy. As to the effect of plucking on breeding stock, Newman says: “Their feathers are an item worth considering, but do not pluck your geese twice a year and expect them to be good breeders. A goose so treated will not lay as early, nor as many, nor as fertile eggs, as one that is left to go through the changes naturally.”



APPENDIX.

A Little General Information Concerning the Poultry and Allied Industries.

In the first edition of this work, published the year before the last census (1900), the writer gave some of the figures of estimates of values of poultry products at the time of the preceding census, and offered a few estimates of probable figures of the census of 1900. On the supposition that the rate of increase in poultry products kept pace with the rate of increase of population—the *per capita* production remaining constant—it appeared that the census of 1900 would show poultry products to the value of \$350,000,000. As, however, the decade from 1890 to 1900 witnessed a most remarkable and widespread development of interest in poultry culture, it was assumed that there had probably been a greater increase in production, and this statement was made:—"It need surprise no one if the coming census shows an annual production of eggs and poultry approaching \$400,000,000 in value."

When the census figures appeared the amount *was actually nearly ten millions less than in 1890*. No one at all conversant with the facts in regard to the production of poultry could come to any other conclusions than that either the census of 1890 or that of 1900, or both, were so far wrong as to be utterly unreliable, and that as exact statistics their figures were probably without value. Only on the supposition that the errors of enumeration probably had like results in all places, was it possible to imagine that the work of enumerating the fowls of the country and collecting statistics of the value of their produce served any useful purpose. Assuming that the errors were the same and had practically the same effects everywhere, the figures are useful as data for comparisons of the relative production in the various states and territories, but as exact information they are of no value whatever. They merely indicate that the total value of the poultry products of the country is enormous, while their unreliability furnishes a striking illustration of the lack of information among poultry keepers on matters of vital importance to them and of the failure of the census bureau to adequately provide for the collecting of statistics regarded as of great importance.

In the opinion of the writer the census of 1890 was probably more accurate than that of 1900. This opinion is based on the fact that numerous local or state enumerations between 1890 and 1900 seemed to confirm the 1890 estimates, while the plan adopted for 1900 census was very faulty, and did not provide for anything like a full enumeration of poultry stocks. The figures—correct or not—are so large that the mind fails to get any adequate conception of what they represent, but it is possible to put them in a light that will give the reader some idea of the volume of the produce of the domestic fowls of the country, and also enable him to form an independent opinion as to the accuracy of the census figures.

There are some five and three-quarter millions of farms in the United States, and on nearly all of these fowls are kept. A farm where there is not a flock of fowls sufficient to provide eggs and poultry for home consumption is a rarity, and on the average farm

the eggs and poultry sold amount each year to enough to be an item of some importance. The figures of the last census allow an average value of less than one dollar per week for each farm in the United States—this for both eggs and poultry. Large figures do not always seem so large when analyzed. It doesn't take a very large flock—or a very productive one—to produce that much.

The census figures take no account of poultry not on farms—except where fowls enough are kept to require one man's time, or its equivalent. Yet there are millions of small flocks, and many thousands of large ones, in cities, towns, and villages which cannot properly be excluded from any enumeration of our poultry resources. Indeed, it is well known to those engaged in the various occupations which have developed out of the necessities of poultry culture that it is upon the town and village poultry keepers rather than upon the more numerous poultry keepers on farms that these allied occupations and industries depend for sustenance.

As a rule it is not the farmers who read papers, who buy supplies of various kinds,—incubators, brooders, bone cutters, feed troughs, drinking fountains, meat scraps, oyster shell, charcoal, grit, cut clover, etc., who support the hundreds of poultry shows and the scores of poultry journals with their thousands of advertisers. A few farmers are interested in these things—the many are not. They get their support from the city and town poultry keepers, and from only a fraction of these, the greater number being quite indifferent. In short, the shows, the journals, and the allied industries depend for support principally upon that small proportion of town poultry keepers, and still smaller proportion of farm poultry keepers which takes an active, intelligent, and progressive interest in deriving pleasure or profit, or pleasure and profit from poultry.

For these people is provided a literature which discusses the subjects of interest to them in detail and more exhaustively than any other branch of agriculture or stock interest, or any recreation having its own special literature. They support nearly four hundred special poultry shows each year. Their requirements for the animal food which forms but a small percentage of the diet of their fowls create a demand to which large packing companies find it worth while to cater, because it furnishes a market for some most important by-products which otherwise would be sold as fertilizer, and it is a cash market, while fertilizers are sold on long credit.

Within a few years there have sprung up several scores of incubator manufactories, and though it would seem that the business must inevitably soon be overdone, so far the demand has been such that it has absorbed practically everything offered it. There may—there probably will come a time when the supply will exceed the demand, and when the concerns that lack financial stability will be shaken down, but the number of poultry keepers not yet interested in efforts to make poultry pay as well as possible is so great, and the rate of increase in interest so rapid that he would be a rash man who would venture to mark bounds for the development of these great industries which have grown up with the general improvement of the condition of small stocks of poultry.

In writing of the subject of profits in poultry in the paragraph devoted to that matter in the first chapter of this book the writer purposely refrained from saying anything of the volume of business done by or of the probable annual net incomes of the most successful poultry keepers, because these exceptional cases should not be used in making estimates of probable returns from poultry, and it was thought best not to introduce anything there that would divert the mind of the reader from the statements made about usual—probable results and returns. Beginners are always apt at making estimates on the supposition that they will do at least nearly as well as the best, and the beginners' estimates are almost always away beyond his actual results. However, it is natural that everyone interested in making poultry profitable should want to know something of how much the most successful poultrymen make, and right that the information should be given them.

The largest business in fancy poultry in this country brings its owner a gross income approaching \$25,000 a year. Probably no other breeder does a business much more than half as large as this, though there are several selling more than \$12,000 worth of fowls and eggs a year. The figures representing the net income — the actual profits — in these cases are not given out, but without doubt in some years the profits amount to fully 25 per cent of the gross sales. In other years the profits on this large volume of business may be much smaller. The average is probably considerably less than 25 per cent of sales.

The gross sales on some of the largest practical poultry plants are very much greater. There are at least several farms which sell more than \$50,000 of produce annually, and which in the best years probably net the owners \$12,000 to \$15,000.

From such results as these we have all grades downward to the man who makes a bare living, and the other who makes less than a living and plods along, going deeper and deeper in debt until credit and courage are both exhausted.

It is plainly evident to anyone in touch with the industry, however, that the proportion of those who go into the business and stay is steadily increasing, and that gradually the business is being placed on a better basis. Indeed the proportion of persons whose interest in poultry is a serious and dignified interest has so much increased that the whole tone of the poultry press is changed, and where a dozen years ago many poultry journals contained a good many articles which were hardly more than frivolous, that class of matter is now rarely met with in their columns. Much that is of little value is still published, but with serious purpose.

The general public, unfortunately, is in somewhat of the same mind about interest in poultry that the cheerful chicken crank of years ago displayed. Still the public, like the poultrymen, makes progress, and it is not too much to expect that another decade of such progress as the last has seen will make a radical difference in the attitude of the general public toward those who are interested in domestic poultry. This is to be desired not so much on account of the poultrymen who are but little concerned as to what others may think about their interest in fowls, as because failing to appreciate the extent of the industry and the demands which it makes on the brains of those who engage in it, the average outsider is apt, when he refers to it, to do so in terms which do his intelligence no credit, and often make him ridiculous in the eyes of well informed persons.



AUTHOR'S NOTE.

When this book was written five years ago each chapter was put in type as soon as written, and the pages plated. Thus there was no opportunity for a general revision of the work, and at that time, and for several years following, I thought that when the time came to get out a new edition of the book I would make many minor alterations in it and perhaps omit one chapter and substitute other matter for it. But as time went by and the book made some reputation on such merit as it possessed, I became more and more disinclined to make such alterations, and finally concluded to make none but a few insignificant and unessential ones made necessary by the different mechanical make up of this edition.

This conclusion was reached because I did not want to have in the hands of poultry keepers two editions of the book, the same in general features and treatment, but differing in many places, and I may say here for the information of any readers of this edition disposed to write me, as many of the readers of the first edition have, asking whether I proposed to change certain things in the book, or what changes would be made in a new edition, that it is altogether improbable that any changes in the text of the book will ever be made by me.

To say that I think I could take the same plan today and write a better book is merely to say that I think I have in five years of exceptional opportunity grown a little in knowledge of poultry culture and in ability to impart it. But there have been no such radical changes either in my views or in poultry conditions as to require any substantial changes in the work, and so I prefer to let "Poultry-Craft" remain practically unchanged as long as it can fill the demand which called it into existence. By the time it shall have become a back number I hope to have substituted for it several other books which together will cover the same ground in much the same way, but more fully, extending as much as any reader could desire many points which the limits of this work made it necessary to treat very briefly.

There is still, and probably will be for many years, a good demand for a book of this kind. There is also a growing demand for a work—too large for the compass of a single volume—which will treat the whole list of poultry topics at such length as is necessary to give full instruction to those who are seeking to make books supplement the practical teachings of experience in the poultry yard. While to meet the latter demand we have only a few loosely compiled pamphlets which, however good in parts, lack the unity of purpose and systematic treatment of topics without which no book can make a permanent impression, it seems to me that it would be a mistake to give time to the rewriting of a book which has the hold on the public to which the volume of the sales of "Poultry-Craft" bear witness, and not rather to devote all time available for such work to a series of supplementary books which will meet the demand for greater detail.

INDEX.

- Abbreviations of names of varieties, 80.
 Accompanying exhibits, 207.
 Adapting business to location, 19.
 Advertising, 195.
 African geese, 251.
 Age for weaning chicks, 181.
 of breeding stock :
 chickens, 151.
 ducks, 240.
 geese, 253.
 turkeys, 226.
 eggs for hatching, 168.
 Ailments of chicks, preventing, 180.
 Airing eggs in incubators, 178.
 Alfalfa, 98.
 Alternate yards, 21.
 American Dominiques, 68.
 Poultry Association, 12.
 Standard of Perfection, 79.
 Anæmia, 212.
 Analysis of foods (table), 112.
 Andalusians, 74.
 Animal meal, 97.
 Anticipating weather changes, 131.
 Apoplexy, 212.
 Approval, selling stock on, 199.
 Artificial methods, general remarks on, 175.
 Ash, 110.
 Ashes, using, on droppings boards, 127.
 Aylesbury ducks, 237.
- Balanced ration, a, 101.
 Balancing rations, examples, 117.
 use of mash in, 103.
 Bantams, care of, 217.
 description of varieties of, 220.
 profit in, 217.
 Barley, 95.
 screenings, 95.
- Barred Plymouth Rocks, description, 65.
 mating, 155.
 Bed bugs, 215.
 Beef, raw, 97.
 scraps, 97.
 Beginning with eggs or stock, 90.
 small capital, 13.
 without capital, 13.
 Black R. C. Bantams, 219.
 Cayuga ducks, 238.
 Cochin Bantams, 220.
 Cochins, 71.
 East Indian ducks, 239.
 Hamburgs, 76.
 Javas, 68.
 Langshans, 72.
 Leghorns, 73.
 Minorcas, 74.
 Orpingtons, 78.
 Polish, W. C., 75.
 Spanish, 75.
 turkeys, 225.
 varieties, mating, 160.
 Wyandottes, 67.
- Blackhead, 232.
 Blood, dried, 97.
 Blue Andalusians, 74.
 Bone cutters, 60.
 Bones, dry, 100.
 green, 97.
 Boxes for droppings, 45.
 grit and shell, 56.
 nest, see *Nests*.
 Bowel trouble, 212, 180.
 Brahma Bantams, 220.
 Brahmas, Dark, description, 69.
 mating, 158.
 Light, description, 69.
 mating, 158.

- Bran, wheat, 94.
 rye, 96.
 Bread, waste, 97.
 Breakdown behind, 212.
 Breeding ducks, points on, 239.
 geese, care of, 254.
 season for chickens, 161.
 ducks, 240.
 stock, care of, 162.
 selling, 197.
 Breeds, comparison of, 62, 63.
 description of:
 Bantams, 218.
 chickens, 64.
 ducks, 236.
 geese, 251.
 turkeys, 224.
 for a breeder, 84.
 city lot, 86.
 fancier, 86.
 farmer, 85.
 village lot, 86.
 to be avoided, 84.
 Brick poultry house, a, 27.
 Broiler raising not profitable as an exclusive business, 10.
 Broilers, market for, 189.
 packing for shipment, 192.
 profit in, 9.
 rations for, 106—7.
 weights of, 189.
 Broken bones, 212.
 feathers, plucking before exhibition, 205.
 Bronchitis, 212.
 Bronze turkeys, 225.
 Brooder houses for pipe system, 46.
 separate brooders, 49.
 Brooders, 59.
 care of chicks in, 179.
 ducklings in, 244.
 for young turkeys, 225.
 nursery, 47.
 temperature in, 180.
 Broodiness, causing, 137.
 Broody hens, breaking up, 140.
 coops for, 56.
 sick, 140.
 Broom corn seed, 96.
 Brown eggs — where in demand, 82.
 Leghorns, description, 72.
 mating, 156.
 Buckwheat, 96.
 middlings, 96.
 Buff Cochin Bantams, 220.
 Cochins, 70.
 Laced Polish, 75.
 Leghorns, 73.
 Orpingtons, 78.
 P. Rocks, 66.
 turkeys, 225.
 varieties mating, 160.
 Wyandottes, 67.
 Buffalo or turkey gnats, 215.
 Builders, hints to, 50.
 Bumble foot, 212.
 Business, adapting to location, 19.
 duck keeping, 233.
 locating for, 17, 18.
 poultry keeping as a, 7.
 risks in poultry keeping, 8.
 the poultry, not overdone, 5.
 as an investment, 11.
 Buying breeding ducks, 239.
 geese, 253.
 stock, general remarks on, 87, 89.
 building materials, 51.
 eggs for hatching, 90.
 land for a poultry plant, 19.
 old stock, 90.
 supplies in quantity, 100.
 Call ducks, 238.
 Calory, definition, 111.
 Canada geese, 253.
 Canker, 212.
 Capital, beginning with small, 13.
 how much, 9.
 Caponizing, 185.
 Capons, dressing, 192.
 weights of, 189.
 Carbohydrates, 110.
 Carbonaceous foods, definition, 110.
 Catching ducks, 246.
 turkeys, 231.
 Cat proof coop, 58.
 Cats, to keep away, 216.
 Cayuga ducks, 238.
 Cellars, incubator, 46.
 Charcoal, 100.
 Cheese, 99.
 Chicken corn, 96.
 pox, 212.

- Chicks, colors of when hatched, 172.
 cooping, 173.
 coops for, 56.
 deformed and puny — should be killed, 171.
 in brooders, care of, 179.
 keeping free from lice, 172.
 marking, 171.
 preventing ailments of, 180.
 rations for, 106—8.
 rearing in confinement, 182.
 roosting coops for, 58.
 teaching to roost, 182.
 water for, 173.
 weaning, 181.
 what to do when they are hatching in incubators, 179.
 under hens, 170.
- Chiggers, 215.
- Children, poultry keeping for, 15.
- Chilling, effects of—on incubated eggs, 170.
- Cholera, 212.
- Chop, corn, 93.
 mixed, 93.
- City poultry keeping, breeds for, 86.
- Clams, 97.
- Classification of poultry keepers, 7.
- Cleanliness, general remarks on, 127, 241.
 (see also, *How often to clean*).
- Clover, 98.
- Cob and corn meal, 93.
- Cochin Bantams, 220.
- Cochins, 70.
- C. O. D., shipping poultry, 197.
- Colds, 132, 212.
- Colony plan, 26.
- Color of market eggs, 82.
 Pekin duck eggs, 237.
- Colored Dorkings, 73.
- Colors of chicks when hatched, 172.
- Combination of fancy and market poultry, 18.
 the profitable, in poultry keeping, 9.
- Combining poultry keeping with other business, 10.
- Commission merchants, selling to, 188—9.
- Common chickens, 61—2.
 ducks, 236.
 geese, 250.
 turkeys, 225.
- Comparison of branches of poultry keeping, 10.
- Comparison of breeds, general remarks, 62, 63.
 (see also remarks in descriptions of varieties of fowls).
 of methods of feeding, 103.
- Complete plant under cover, 42.
- Compromise matings, 148.
- Condition and egg production, 134.
 of breeding stock, 150.
 powders, 99.
- Confinement, care of breeding geese in, 254.
 ducks adapted to, 233.
 keeping breeding stock (hens) in, 162.
 turkeys in, 224.
 rearing chicks in, 182.
 market ducks in, 245.
- Constipation, 212.
- Consumption, 212.
- Contamination, 152.
- Continuous, or sectional, houses, 29.
- Control of sex, 152.
- Cookers, feed, 60.
- Cooking food, 103.
- Cooling dressed poultry, 192.
 duck eggs, 243.
 eggs in incubators, 178.
- Coop, cat and hawk proof, 58.
 exhibition, 207.
 roosting, for weaned chicks, 58.
- Cooping young chicks, 173.
 ducklings, 245.
 goslings, 255.
 turkeys, 228.
- Coops for broody hens, 56.
 little chicks, 56.
 shipping, exhibition and breeding stock, 199.
 live poultry to market, 190.
- Corn, 92.
 an all corn ration for turkeys, 230.
 broom, 96.
 chicken, 96.
 chop, 93.
 Egyptian, 96.
 fed hens lay best eggs, 142.
 Kaffir, 96.
 meal, 92.
- Cornish Indian Games, 78.
- Correspondence, 197.
- Cotton seed meal, 97.
- Cracked corn, 93.
- Cracker crumbs, 97.

- Cracklings, 97.
 Cramp, 212.
 Crested White ducks, 239.
 Creveccœur, 76.
 Crop bound, 213.
 enlarged, 213.
 inflammation of, 213.
 Cross bred, definition, 61.
 geese, 250, 253.
 breeding, 62, 154.
 Cull stock, selling, 194.
 Culling growing chicks, 183.
 in fall, 132.
 laying hens in summer, 138.
 Curd, 99.
 Damaged food, 93, 100.
 Dampness objectionable, 21, 127, 128, 222, 235.
 Dark Brahmas — description, 69.
 mating, 159.
 nests, 54.
 Debility, general, 213.
 in growing chicks, 184.
 Debt, importance of keeping out of, 13, 19.
 Deformed chicks, 171.
 Depluming scab mites, 216.
 Desiccated fish, 98.
 Diarrhœa, 213.
 Diphtheria, 213.
 Diphtheritic roup, note, 210.
 Diseases, descriptions and remedies of, 211.
 general rules for preventing, 210.
 hints to guide in diagnosing, 211.
 of ducks, 247.
 turkeys, 231.
 Distemper, 213, 132.
 Doctoring, unprofitableness of, 209.
 Dominique Leghorns, 74.
 Dominiques, American, 68.
 Dorkings, 77.
 Double matings, 155—6. (Note 61, 65).
 Drainage, 21.
 Dressed poultry, exhibiting, 208.
 packing, 192.
 in warm weather, 193.
 shipping in cold weather, 193.
 Dressing chickens, 191.
 ducks, 246.
 geese, 257.
 turkeys, 231.
 Dried blood, 97.
 Drinking vessels, 55.
 cleaning, 128.
 water, warming, 135.
 Drooping wings in young chicks, 181.
 Droppings boards, 53.
 boxes for, 45.
 how often to remove, 127.
 selling, 127. (Note).
 Dry picking poultry, 191.
 Duck eggs, care of, 241.
 growing adapted to all sections, 235.
 general remarks on, 233.
 Ducklings, brooding artificially, 244.
 with hens, 245.
 care of after weaning, 245.
 feather pulling in, 248.
 feeding, 244.
 hatching in incubators, 243.
 with hens, 245.
 Ducks, descriptions of breeds of, 236.
 diseases of, 247.
 dressing, 246.
 exhibiting, 247.
 houses and yards for, 235.
 packing and shipping to market, 247.
 profit in, 234.
 to tell sex of, 246.
 when to market, 246.
 Durra, 96.
 Earth floor, best, 24.
 renewing, 39.
 East Indian ducks, 239.
 Eaves, to make joints at, wind-tight, 39.
 Egg bound, 213.
 Egg breed, what is an, 63.
 broken in body, 213.
 eating, 141.
 foods, 99.
 production, average of, 123.
 effect of condition on, 134.
 weather on, 123.
 general remarks on, 121.
 record, keeping an, 142.
 testers, 169.
 type, 124.
 yield, factors of a good, 124.
 what is a good, 63.
 Eggs, care of duck, 241.
 chilled during incubation, 170.
 double, 141.
 exhibiting, 208.

- Eggs, for hatching, age of, 168.
 buying, 90.
 care of, 163.
 packing for shipment, 201.
 selling, 200.
 marketing, 187.
 miscarriage of, 141.
 misshapen, 141.
 moistening, during incubation, 170.
 nest, not necessary, 142.
 pale-yolked, 142.
 quality of, affected by food and condition, 142.
 shipping, to commission merchants, 188.
 small, 141.
 soft shelled, 141.
 testing, 169.
 watery, 142.
 winter, 123.
- Egyptian corn, 96.
 geese, 253.
- Elements, food, 109.
- Embden geese, 251.
- Enlarged crop, 213.
- Enteritis, 213.
- Excelsior meal bread, 108.
- Exercise for heavy fowls, 125.
 how much, 125.
 what kind of, 124.
- Exhibiting poultry, general remarks on, 203.
- Exhibition coops, 207.
 Games, 78.
 stock, general care of, 203.
 special preparation of, 204.
- Fall management of laying stock, 129.
- False or foul feathers, plucking, 205.
- Family poultry, 13.
 trade, hints on selling to, 193.
- Fanciers, breeds for, 86.
- Fancy, keeping poultry for, 14.
 poultry, combining with market, 18.
- Farm, breeds for, 85.
 flock, continuous house for, 30.
- Farmers' mistake in breeding, 147.
- Farming, duck, 233.
 poultry, 17.
- Fat, effect of feeding to excess, 111.
 how to reduce, 125.
- Fats, 110.
- Fattening affected by conditions, 102.
 for methods of fattening, see *Rations*.
- Feather eating, 213.
 in ducklings, 248.
- Feathers, plucking foul, 205.
 geese for, 257.
- Feed cookers, 60.
 how much to, 104.
 often to, 104.
 mixers, 60.
 troughs, 54.
 keeping clean, 128.
- Feeding breeding ducks, 242.
 geese, 255.
 damaged foods, 93, 100.
 for special results, 102.
 grain in litter, 126.
 laying hens in extreme cold weather, 135.
 warm winter weather, 136.
 spring, 136.
 summer, 138.
- turkeys, 226.
 little chickens, 173.
 methods compared, 103.
 moulting hens, 129.
 onions, 98.
 potatoes, 98.
 requires skill, 108.
 science in, 109.
 sitting hens, 168.
 special — before exhibition, 206.
 standards, use of, 116.
 stimulants, 99.
 turkeys from shell to market, 228.
 when the days are short, 133.
- Fiber, digestibility of, 110.
- Fish, desiccated, 98.
 feeding to ducks, 245.
 scrap, 98.
- Fleas, 215.
- Floor, earth—best, 24.
 keeping clean, 127.
 renewing earth, 39.
 to keep scratching in order, 126.
- Food, cooking, 103.
 elements, 109.
 need of variety of, 101.
 requirements of fowls, 101, 109.
 value, 111.
- Foods, analysis of, (table), 112.
 changing, 102.

- Foods, using damaged, 93, 100.
 Foreign breeds, 79.
 Fowls, kinds of described, 61.
 compared, 62.
 Frizzles, 79.
 Frost-bite, 213.
 Fumigating, 215.

 Game Bantams, 218.
 Games, Cornish Indian, 78.
 Exhibition, 78.
 Malay, 79.
 Pit, 78.
 Gapes, 213.
 Geese, descriptions of varieties, 251.
 houses and fences for, 250.
 kinds of, 250.
 mating, 253.
 profit in, 250.
 General purpose fowls, 63.
 Gentleness in handling ducks, 241.
 hens, 134.
 Giddiness, 213.
 Gnats, 215.
 Golden Hamburgs, 76.
 Polish, 75.
 Wyandottes, description, 67.
 mating, 158.
 Goose culture, general remarks on, 249.
 Grade, definition, 61.
 Grading, advantage of, 62.
 Green bone, 97.
 ducks, 233.
 geese, 250.
 Grit, 100.
 boxes for, 56.
 crushers, 60.

 Hamburgs, description, 76.
 mating, 160.
 Hatching, care of chicks after, 171.
 chicks in incubators, 175—179.
 with hens, 165—171.
 ducklings in incubators, 243.
 with hens, 245.
 goslings, 255.
 turkeys, 227.
 Hawk proof coop, 58.
 Hay, 98.
 cutters, 60.
 Helping chicks out of shell, 170.
 ducklings out of shell, 244.

 Heredity, 144.
 Horse meat as poultry food, 97.
 Hospital for fowls, need of, 214.
 Houdans, description, 78.
 mating, 160.
 House, a two pen, 28.
 continuous for farm flock, 29.
 with walk, 30.
 without walk, 29, 39.
 for town lot, 24.
 monitor top, 32.
 scratching shed with walk, 37.
 without walk, 34.
 semi-monitor top, 34.
 with scratching shed underneath, 25.
 two rows of pens and passage in
 the middle, 32.
 Houses, brooder, 46.
 colony plan, 27.
 duck, 235.
 for complete plant under cover, 42.
 geese, 250.
 turkeys, 222.
 keeping clean, 127.
 How eggs are sent to market, 187.
 many breeds should a poultryman keep,
 81.
 many females to a male :
 chickens, 152.
 ducks, 240.
 geese, 254.
 turkeys, 226.
 many eggs does a fowl lay :
 duck, 240.
 hen, 123.
 goose, in descriptions of
 breeds, 251.
 turkey, 226.
 much exercise, 125.
 income, 8.
 land, 19.
 room per fowl, 50.
 to feed, 104.
 to spend in advertising, 195.
 often to feed, 104, 133, (see also
 Rations).
 to get satisfactory stock, 80.
 learn poultry keeping, 12.
 Hulled oats, 95.

 Iced poultry, packing, 193.
 Inbreeding, 153.

- Income from poultry, 4.
 Incubation, period of:
 duck eggs, 243.
 hen eggs, 177.
 goose eggs, 255.
 turkey eggs, 227.
 Incubator cellars, 46.
 Incubators, 58.
 management of, 175.
 Indian Runner ducks, 239.
 Games, description, 78.
 mating, 159.
 Indigestion, 213.
 Inflammation of crop, 213.
 liver, 213.
 Inheritance, law of, 144.
 Introducing new blood, 153.
 Insect powders, 215.
 Invalids, poultry keeping for, 15.
 Investment, poultry keeping for, 11.
 Itch, 213.
- Japanese Bantams, 220.
 Javas, 68.
 Johnnycake, directions for making, 107.
 Joints at eaves, to make wind tight, 39.
- Kaffir corn, 96.
 Keeping chicks growing, 181.
 Kerosene emulsion, 215.
 for lice, 215.
 Killing poultry, methods of, 191, 246.
- Land, buying for poultry plant, 19.
 how much, 19.
 La Fleche, 76.
 Lameness, 213.
 Lamp, care of, 175.
 Langshans, 71.
 Lard cracklings, 97.
 Late hatched pullets, when does it pay to
 keep them, 129.
 Law of inheritance, 144.
 Lay, to make hens while brooding chicks,
 174.
 Laying hens, fall management of, 129.
 late culling of, 132.
 selecting, 124.
 spring care of, 136.
 summer care of, 137.
 qualities and size, 124.
 stock, selecting breeders to produce, 150.
- Laying, to postpone, 130.
 Learning poultry keeping, 12.
 Leg bands, 207.
 Lice, 172, 214.
 Light Brahmas, description, 69.
 mating, 158.
 Lime, air-slaked on droppings boards, 127.
 and sulphur for lice, 215.
 Linseed meal, 97.
 Litter, feeding grain in, 126.
 for scratching floor, 126.
 Liver disease, 213.
 Localities suited to chickens, 17.
 ducks, 235.
 geese, 249.
 turkeys, 222.
- Locating for business, 17.
 Location, adapting business to, 19.
- Malay Games, 79.
 Mammoth White turkeys, 225.
 Market, consideration of in selecting loca-
 tion, 17.
 eggs, profit in, 9.
 poultryman, breeds for, 82.
 stock, selecting breeders to produce,
 151.
- Marketing ducks, 246.
 eggs, 187.
 poultry:
 chickens, 188.
 ducks, 246.
 geese, 256.
 turkeys, 230.
- Marking chicks, 171.
 Mash, value of, 103.
 Mash, directions for making—see *Rations*,
 105, etc.
 elaborate compounds not necessary in,
 101.
- Materials for building, buying, 51.
 lists of for buildings, 28, 31, 34, 36, 39,
 41.
- Mating Barred P. Rocks, 155.
 black varieties, 160.
 Brown Leghorns, 156.
 buff varieties, 160.
 Colored Indian Games, 159.
 Dark Brahmas, 158.
 ducks, 239.
 geese, 253.
 general remarks on, 154.

- Mating Golden Wyandottes, 158.
 Hamburgs, 160.
 Houdans, 160.
 Light Brahmas, 158.
 Partridge Cochins, 159.
 Polish, 160.
 Silver Wyandottes, 158.
 Standard fowls, 154.
 turkeys, 226.
 white varieties, 160.
 Matings, compromise, 148.
 Meal, animal, 97.
 barley, 95.
 corn, 93.
 cotton seed, 97.
 linseed, 97.
 oat, 95.
 Meat breeds, definition, 63.
 foods, 97.
 horse, for poultry food, 97.
 Medicines, keeping supply of, 214.
 Methods of feeding, 103.
 making cut in killing, 191.
 Middlings, buckwheat, 96.
 wheat, 94.
 Milk, 99.
 Millet seed, 96.
 Milled maize, 96.
 Minorcas, 74.
 Mistakes, common in breeding, 147.
 Mixed chop, 93.
 feed, 60.
 Moistening eggs during incubation, 170.
 Moisture in incubators, 177.
 Mongrel geese, 250, 254.
 hens, 61, 62.
 Monitor top house, 32.
 Mosquitos, 215.
 Mottled Javas, 68.
 Moulting hens, feeding, 129.
 Moving laying hens, 135.
 sitting hens, 167.
 Muscovy ducks, 239.

 Names of varieties, abbreviations of, 80.
 Narragansett turkeys, 225.
 Nest boxes, 53.
 eggs, 142.
 Nests for ducks, 236.
 geese, 254.
 turkeys, 226.
 keeping clean, 127.

 New blood, introducing, 153.
 breeds, 64.
 Nitrogenous food, definition, 109.
 Non-popular varieties to be avoided by business breeders, 84.
 Non-sitters, 64.
 Nursery brooders, 47.
 Nutritive ratio, 111.

 Oat meal, 95.
 Oats, 94.
 Old fowls as breeders, 90, 151.
 hens as layers, 139.
 which to keep, 139.
 stock, buying, 90.
 Onions, 98.
 Orpingtons, 77.
 Oyster shells, 100.

 Packing dressed poultry, 192.
 ducks for shipping, 247.
 eggs for hatching, 201.
 iced poultry in warm weather, 193.
 Paint, 52.
 Partridge Cochins, description, 71.
 mating, 159.
 Pedigree, importance of in breeding, 148.
 Pekin Bantams, see *Cochin Bantams*.
 ducks, 236.
 Picking, dry picking, 191.
 scalded poultry, 191.
 Pip, 213.
 Pit Games, 78.
 Plucking false or foul feathers, 205. (Note).
 geese for the feathers, 257.
 Plymouth Rocks, description, 64.
 mating Barred, 155.
 Pneumonia, 213.
 Polish, 75.
 Bantams, 220.
 Pork scraps, 97.
 Potatoes, 98.
 Potential energy, 111.
 Poultry business as an investment, 11.
 farming, 17.
 keeping as a business, 7.
 as an adjunct, 10.
 employment, 11.
 for pleasure, 13.
 children, 15.
 invalids, 15.
 women, 14.

- Poultry keeping, how to learn, 12.
 selling through commission merchants,
 189.
- Prepotency, 150.
- Preserving eggs not advisable, 187.
- Preventing common ailments of young
 chicks, 180.
 disease, general rules for, 210.
- Prices of (chicken) eggs and stock, 9, 98,
 198.
 ducks, and duck eggs, 239.
 geese, and goose eggs, 253.
- Profit in bantams, 217.
 ducks, 234.
 geese, 250.
 hens, 9.
 turkeys, 222.
- Profitable combination in poultry keeping,
 9.
- Prolificacy, consideration of in selecting
 breeding stock, 150.
- Proteids, 109.
- Protein, 109.
- Provender, 93.
- Puny chicks should be killed, 171.
- Pure bred, definition, 61.
 fowls, relative merits of, 63.
- Quarantining fowls, 210.
- Range for breeding stock :
 ducks, 240.
 geese, 254.
 hens, 162.
 turkeys, 227.
 young chickens, 183.
 ducks, 246.
 geese, 255.
 turkeys, 228.
- Ration, a balanced, 101.
 changing value of, 120.
 narrow, definition, 111.
 wide, preferable, 117.
- Rations, changing, 102.
 different for different kinds of fowls,
 102.
 examples in balancing, 117.
 tested for breeding stock :
 ducks, 242.
 geese, 255.
 hens, 104.
 turkeys, 229.
- Rations, tested for young chicks, 106.
 ducklings, 244.
 goslings, 256.
 turkeys, 229.
- Rattling in the throat, 213.
- Record, keeping an egg, 142.
 of hatches, 168.
- Redcaps, 76.
- Relative merits of breeds, 63.
- Renting, 19.
- Risks in poultry keeping, 8.
- Rhode Island Reds, 69.
- Rolled oats, 95.
- Roofing papers, 51.
- Roost, teaching chicks to, 182.
- Roosting coop for chicks, 58.
- Roosts, 53.
 for young turkeys, 228.
 on warm side of house, 39.
- Rose Combed Bantams, 219.
- Rouen ducks, 238.
- Round worm, 214.
- Roup, 214.
- Rumpless fowls, 79.
- Russians, 79.
- Rye, 95.
 bran, 96.
- Scalding ducks, 247.
 poultry, 191.
- Scaly legs, 216.
- Scratching, see *Exercise*.
 litter, what to use, 126.
 floor, how to manage, 126.
 shed house, 34.
 with a walk, 37.
 houses, suggestions for, 36.
 in front of house, 28.
 under house, 25.
- Screenings, barley, 95.
 wheat, 93.
- Sebright Bantams, 219.
- Second floor space, use of, 51.
- Selecting breeders to produce laying stock,
 150.
 market stock, 151.
 breeding stock, points to consider, 148.
 ducks for breeding, 240.
 geese for breeding, 253.
 turkeys for breeding, 226.
 hens for sitters, 166.
 laying stock, 124.

- Selection the first principle in breeding, 146, 153.
 of fowls for exhibition, 204.
- Selling breeding and exhibition stock, 197.
 eggs and poultry, general remarks, 186.
 for hatching, 200.
- ducks, 246.
 exhibition and breeding turkeys, 233.
 geese, 256.
 inferior poultry, 194.
 market turkeys, 239.
 poultry and eggs to family trade, 193.
 stock by the score, 198.
 C. O. D., 197.
 on approval, 199.
- Semi-monitor top house, 34.
- Separating the sexes while growing, 182.
- Separation the object of selection, 147.
- Setting hens, 167.
- Sex, control of, 152.
- Sexes, separating, 182.
- Shape, importance of, 148.
- Shell, boxes for, 56.
 oyster, 100.
- Shelter for:
 geese, 250.
 goslings, 255.
 poultry house, 21.
 turkeys, 222.
- Shingles, 51.
- Shipping dressed poultry to market, 190.
 eggs for hatching, 201.
 to market, 187.
 fowls to shows, 207.
 high class fowls, 199.
 live poultry to market, 190.
- Short days, difficulty in feeding on, 133.
- Shorts, 94.
- Sick hens going broody, 140.
- Silkies, 79.
- Silver Duckwing Leghorns, 74.
 Gray Dorkings, 77.
 Penciled Hamburgs, 75.
 Polish, 75.
 Spangled Hamburgs, 75.
 Polish, 75.
 Wyandottes, description, 67.
 mating, 158.
- Sites for duck houses, 235.
 goose growing, 249.
- Sitting hens, care and food of, 168.
- Situation, general remarks on, 20.
- Size and laying qualities, 124.
 importance of, in breeding stock, 149.
- Slate turkeys, 224.
- Snow, effects on fowls, 132.
- Soils suited for poultry keeping, 21.
- Sorghum seed, 96.
- Spanish, White Faced Black, 75.
- Squab broilers, 189.
- Standard fowls, mating, 154.
 of food values, 115.
 Perfection, 79.
- Standard bred, definition, 61.
- Stationery, the breeders', 197.
- Stimulants, 99, 116.
- Sulphur and lime for lice, 215.
- Sultans, 79.
- Sumatras, 79.
- Sunlight, importance of, 21.
- Surplus stock house, 49.
- Sweet potatoes, 98.
- Tape worms, 214.
 in turkeys, 232.
- Temperature of brooder, 180.
 egg chamber, 176.
- Tested rations, see *Rations*.
- Testers, egg, 169.
- Testing eggs, 169.
 foods, 97.
 varieties, 82.
- Thoroughbred, definition, 61.
- Tobacco for lice, 215.
- Tonics, 99.
- Toulouse geese, 254.
- Town lot, breeds for, 86.
 cheap house for, 24.
- Troughs, feed, 54.
- Turkeys adapted to all sections, 222.
 care of laying, 226.
 young, 228.
 catching, 231.
 diseases of, 231.
 dressing for market, 231.
 feeding from shell to market, 228.
 ground suitable for, 222.
 hatching, 227.
 houses for, 222.
 keeping in confinement, 224.
 market for, 230.
 mating, 226.
 profit in, 222.
 raising artificially, 227.

- Turkeys, varieties described, 224.
yards for, 224.
- Turning eggs in incubators, 178.
- Two-pen poultry house, 28.
- Values of food stuffs (table), 112.
- Variety of food needed, 101.
- Variation, law of, 144.
- Variation from feeding standards, 116.
- Vegetable foods, 98.
- Ventilating duck eggs, 243.
in cold weather, 135.
- Ventilation in incubators, 177.
of incubator cellar, 46.
- Ventilators, 51.
- Wages on poultry plants, 11.
- Walk, continuous house with a, 30.
plan for doing work from, 32.
scratching shed house with a, 37.
- Warming drinking water, 135.
grain, 135.
- Washing show birds, 205.
- Waste bread, 97.
- Water for ducks, 240, 242.
geese, 254.
young chicks, 173.
supply for large plant, 45.
- Weaning chicks, 181.
- Weather changes, anticipating, 131.
effect of on egg production, 123.
- Weight of breeding stock, 149.
- Weights preferred for market poultry, 189.
- What most breeders can do, 84.
the markets want:
ducks, 240, 246.
chickens, 189.
geese, 249, 254.
turkeys, 230.
to do when it snows, 132.
- Wheat, 92.
- Wheat, damaged, 92.
screenings, 92.
- When to buy breeding geese, 253.
stock, 89.
- Whey, 99.
- White Bantams, 219.
Crested Black Polish, 75.
Cochins, 71.
Dorkings, 77.
eggs, where in demand, 82.
Faced Black Spanish, 75.
Hamburgs, 76.
Holland turkeys, 224.
Langshans, 72.
Leghorns, 73.
Minorcas, 74.
Muscovy ducks, 236.
Orpingtons, 78.
Plymouth Rocks, 65.
Polish, 75.
varieties, mating, 160.
Wonders, 68.
Wyandottes, 67.
- Whitewash, 128.
- Wild geese, 253.
- Wind puffs, 214.
- Winter eggs, 123, 131.
- Worms, 214.
- Women as poultry keepers, 14.
- Wyandottes, descriptions, 67.
mating, 158.
- Yard room, 50.
- Yards, alternate, 21.
cleaning, 127.
colony plan with, 26.
for ducks, 235.
geese, 249.
goslings, 256.
turkeys, 224.
- Yolks, pale, 142.

"Hope" to force Winter Laying.

5 # THIS BOOK IS DUE ON THE LAST DATE
1 # STAMPED BELOW

1 # AN INITIAL FINE OF 25 CENTS
1 # WILL BE ASSESSED FOR FAILURE TO RETURN
1 # THIS BOOK ON THE DATE DUE. THE PENALTY
1 # WILL INCREASE TO 50 CENTS ON THE FOURTH
1 # DAY AND TO \$1.00 ON THE SEVENTH DAY
1 # OVERDUE.

MAR 7 1933

MAR 8 1933

OCT 20 1937

LD 21-50m-1, '38

445127

SF487

R59

UNIVERSITY OF CALIFORNIA LIBRARY

