

EX LIBRIS

POWER ALCOHOL

OXFORD TECHNICAL PUBLICATIONS

POWER ALCOHOL

ITS PRODUCTION AND UTILISATION

BY

G. W. MONIER-WILLIAMS, O.B.E., M.C.

M.A. (Oxon.), Ph.D. (Freiburg i/B.)

FELLOW AND MEMBER OF COUNCIL OF THE INSTITUTE OF CHEMISTRY



LONDON

HENRY FROWDE AND HODDER & STOUGHTON

THE *LANCET* BUILDING

1 & 2 BEDFORD STREET, STRAND, W.C. 2

TP593
M6

First Printed 1922

TO THE
ABBOTTS

P R E F A C E

THE use of alcohol as a fuel for internal combustion engines is by no means a new development. Since the beginning of the present century it has been employed to a limited extent in farm engines, more especially in the neighbourhood of agricultural distilleries on the Continent. Alcohol engines have also been used successfully in some of the chief sugar-producing countries of the tropics, the fuel being derived from the fermentation of molasses. It is only within recent years, owing to the shortage and high price of petrol following on the war, that the employment of alcohol as a fuel for light motor transport has been seriously advocated.

Although at the present moment there would seem to be an over-supply of petrol, and consequently little inducement to explore the possibilities of a substitute, we have no assurance that this is likely to be a permanent condition of affairs. On the contrary, there are many indications that, with the revival of industrial prosperity, the demand for motor fuel will again tend to outstrip the supply. Opinions are somewhat sharply divided as to the extent of the world's petroleum reserves, and in default of some definite evidence as to the sufficiency of future supplies, it is clearly of importance to investigate the possible alternatives. It is with this object in view that I have endeavoured to present, in a connected and readily accessible form, the arguments for and against the employment of alcohol as a motor fuel, together with the theoretical and practical considerations governing its production and utilisation.

Owing to limitations of space, methods of analysis of fuel mixtures containing alcohol have not been included. The investiga-

tion of the more common liquid fuels in the laboratory is already dealt with in detail in existing text-books. The inclusion of alcohol, and possibly ether or other bodies, in fuel mixtures, will undoubtedly introduce many difficulties in the way of analytical procedure, and the subject is clearly too extensive to be susceptible of adequate treatment in a book of this character.

I am indebted to Mr. W. A. Godby for valuable assistance in connection with the transcription of the manuscript and the reading of the proof-sheets.

G. W. M.-W.

LONDON,
December 1921.

CONTENTS

CHAPTER I

	PAGE
INTRODUCTORY: THE MOTOR FUEL QUESTION	I

CHAPTER II

THE PLANT AS A SOURCE OF ALCOHOL	II
The Formation of Carbohydrates in Plants: Respiration and Photosynthesis—Enzymes—Germination of Barley—Fungi—Yeasts—Alcoholic Fermentation: Pasteur's and Liebig's Views—Adrian Brown's Work—Slator's Work on Rate of Fermentation—Buchner's Researches—Harden's Theory of Fermentation—Neuberg's Theory—Later Developments—Ehrlich's Work: Formation of Fusel Oil.	

CHAPTER III

PRODUCTION OF ALCOHOL FROM STARCH AND SUGAR	31
Raw Materials—Barley Malt—Other Cereal Malts—Conversion of Starch into Fermentable Sugars—Mashing: British and Continental Practice—Starch Conversion under Pressure—Starch Conversion without Pressure—Saccharification—Saccharification without Malt—Fermentation—Yeast "Bub"—Souring of "Bub" Mash—Bacterial Antiseptics—Fermentation of Bub Mash—Fermentation of Main Wort—Aeration—Acidity—Attenuation—Yield of Alcohol—Pressed Yeast.	
The "Amylo" Process—Alcoholic Fermentation by Bacteria.	
Alcohol from Beets—Pressing—Maceration—Diffusion—Champonnois' Process—Continuous Fermentation.	
Fermentation of Molasses.	
Distillation—Distillation of Aqueous Alcohol—Simple Distilling Columns—Bohm's Still—Ilge's Column—Guillaume's Sloping Column—Rectification—Values of k for Secondary Constituents—Coffey Still—Dephlegmators—Modern Continuous Stills—Guillaume's Rectifying Still.	

CHAPTER IV

	PAGE
THE ECONOMICS OF ALCOHOL PRODUCTION FROM CROPS	86
Cereals — Wheat — Barley — Rye — Oats—Buckwheat—Maize— Sorghum Grain—Rice—Tubers : Potatoes—Development of the Potato-Spirit Industry in Germany—Conditions in Great Britain as regards Potato Spirit—Cassava—Artichokes—Sweet Potatoes —Yams.	
Roots : Beets—Mangolds.	
Sugar Cane—Sorghum Cane.	
Molasses.	
Trees : Mowra Flowers—Nipa Palm—Prickly Pear—Zamia Palm—Sago Palm—Grass Tree.	
Lichens—Seaweeds—Various Plants—Tabular Summary of Yields—Cost of Cultivation—Alcohol and Petrol : Comparison of Costs—Use of Food Stuffs for Alcohol Production—Chief Factors affecting Alcohol Production in the Tropics—Cellulose Materials.	

CHAPTER V

ALCOHOL FROM CELLULOSE MATERIALS	129
The Constituents of Wood—Cellulose—Pentosans and Hexosans —Lignin—Sawdust and Wood Waste—Classen's Sulphurous Acid Process—Ewen and Tomlinson's Improvements—Sulphuric Acid Process—Comparison of Different Methods of Hydrolysis— Economic Considerations.	
Straw—Peat.	
Waste Sulphite Liquor—Sulphite Liquor as a Source of Alcohol —Processes of Wallin, Ekström, and Landmark—Recent Swedish Developments—Cost of Sulphite Alcohol—Statistics.	
Nature of the Sugars formed by Hydrolysis of Wood.	

CHAPTER VI

SYNTHETIC ALCOHOL	171
Synthesis from Ethylene—Synthesis from Acetylene—Conversion of Acetylene into Acetaldehyde—Reduction of Acetaldehyde to Ethyl Alcohol—Economic Considerations.	

CHAPTER VII

EXCISE SUPERVISION AND DENATURATION	188
Alcoholometry—"Proof Spirit"—Sikes' Hydrometer—Foreign Systems—Excise Regulations—Denaturation—Surtax on Im- ported Alcohol—Requirements of a Denaturant—Special Pro- visions for Denaturing Power Alcohol—Denaturation in Other Countries—Alternative Denaturants.	

CONTENTS

ix

CHAPTER VIII

	PAGE
OUTLINE OF THE PRINCIPLES OF THE INTERNAL COMBUSTION ENGINE	211

Four-Stroke Engine—Two-Stroke Engine—Diesel Engine—The Unit of Heat—The Unit of Power—The Gas Laws—Specific Heats at Constant Volume and Constant Pressure—Ratio of Specific Heats—Isothermal and Adiabatic Expansion—The Indicator Diagram—Volumetric Efficiency—Thermal Efficiency—“Air Standard” Efficiency—Overall Thermal Efficiency—Control of Speed—Ricardo’s Variable Compression Engine.

CHAPTER IX

THE CHEMICAL AND PHYSICAL PROPERTIES OF ALCOHOL FROM THE MOTOR-FUEL STANDPOINT	232
--	-----

Ultimate Composition—Calorific Value—Gross and Net Calorific Values—Air required for Combustion—Latent Heat of Vaporisation—Rate of Flame and Temperature of Explosion—Temperature of Spontaneous Ignition—Explosive Range—Miscibility with Other Liquids—Vapour Tension—Corrosion—Specific Gravity and Viscosity—Flash Points of Alcohol and Alcohol Mixtures.

CHAPTER X

RESULTS OF ENGINE TESTS	274
-----------------------------------	-----

Meyer’s Tests—Lucke and Woodward’s Tests—Strong and Stone’s Experiments—French War Office Road Trials—Ormandy’s Tests—Watson’s Tests—Melbourne University Experiments—London General Omnibus Company’s Tests—Donath and Gröger’s Figures—Ricardo’s Experiments.

CHAPTER XI

FUEL MIXTURES CONTAINING ALCOHOL	305
--	-----

Carburetted Alcohol—Ether Mixtures: Natalite—Alcohol containing Acetylene or Other Gases—Oxidising Agents and Explosives.

INDEX	313
-----------------	-----

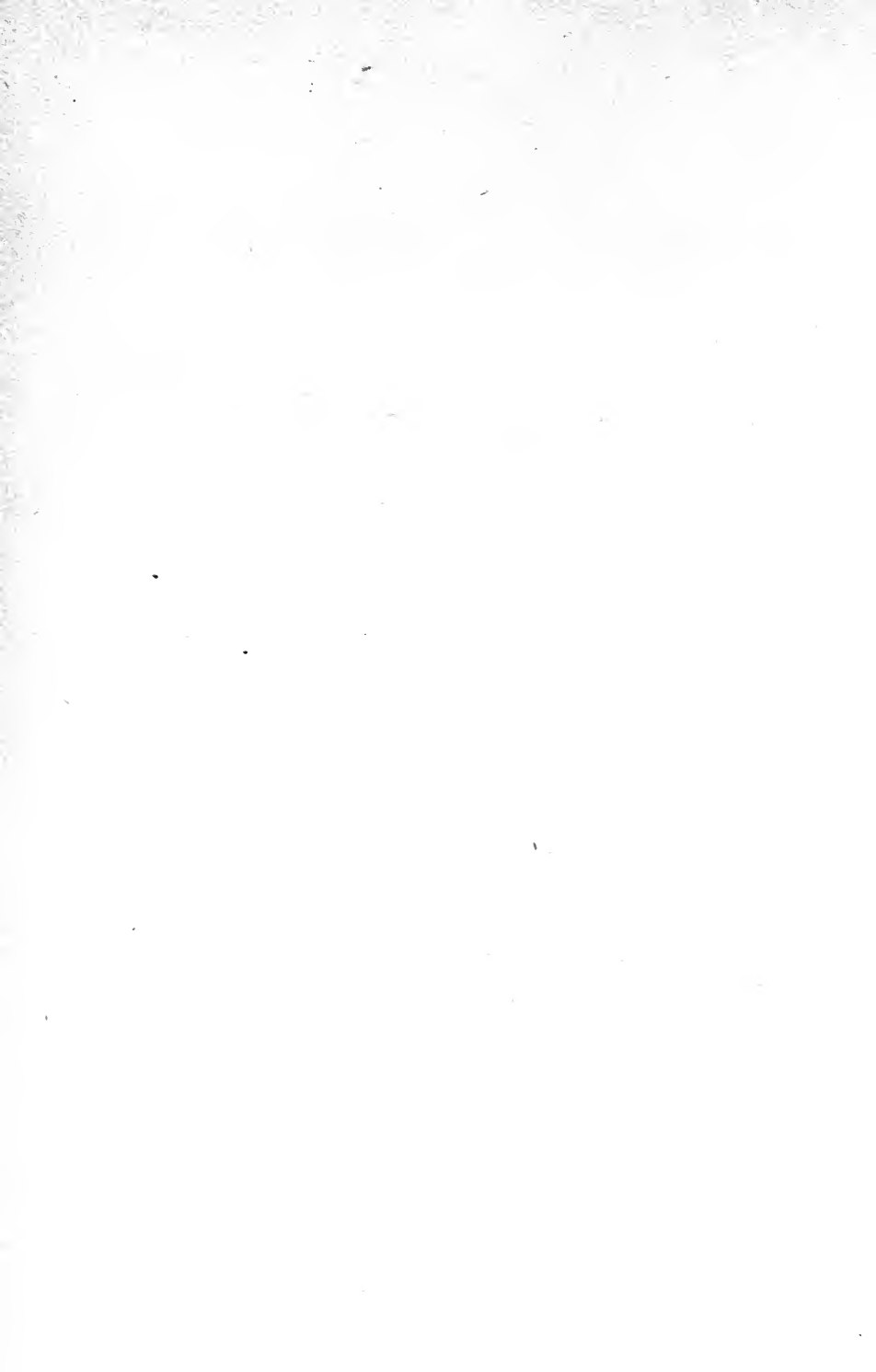

LIST OF ILLUSTRATIONS

FIG.	PAGE
1. Section of a Grain of Barley (diagrammatic)	16
2. Diagram of Yeast Growth	21
3. Henze Converter	41
4. "Amylo" Process Fermentation Vessel	55
5. Continuous Fermentation	62
6. Variation in Composition of Vapour and Liquid with Boiling-points of Dilute Alcohol. (Sorel.)	66
7. Plate Distilling Column	67
8. Bohm's Still	69
9. Plates of Ilge's Column for Thick Mashcs	70
10. Guillaume's Sloping Column Still for Thick Mashcs	71
11. Values of Coefficient k for Alcohol and Secondary Products	73
12. Coffey Still	76
13. Gazagne's Dephlegmator	79
14. Continuous Distilling and Rectifying Apparatus	80
15. Guillaume's Rectifying Still. (Sidersky.)	83
16. Cost of Raw Material necessary for the Manufacture of One Gallon of 95 per cent. Alcohol	119
17. Arrangement of Plant for Treatment of Wood Waste	141
18. Triple Effect Evaporator in conjunction with Sulphite Liquor Still	155
19. Concrete Neutralisation Tower for Sulphite Liquor. (E. Haegglund.)	156
20. Approximate B.Th.U. required for Production of One Gallon 80 per cent. Alcohol from Wash of Different Strengths	162
21. Removal of Acetaldehyde from Reaction Vessel under Reduced Pressure	179
22. Diagram of Plant for Production of Acetaldehyde from Acetylene	180
23. Chart showing Synthesis of Alcohol from Ethylene and Acetylene	184

FIG.	PAGE
24. Sikes's Hydrometer	192
25. Diagram of Four-stroke Engine	212
26. Diagram of Two-stroke Engine	213
27. Isothermal and Adiabatic Compression of 1 Litre of Gas to a Volume of 200 c.c.	219
28. Typical Four-stroke Indicator Diagram	223
29. Relation between "Ideal" Thermal Efficiency and Compression Ratio	227
30. Internal Combustion Engine with Variable Compression	230
31. Composition of Exhaust Gas. Single-cylinder Knight Sleeve- valve Engine	239
32. Thermal Efficiency of Four-cylinder Clement-Talbot Engine with Petrol	240
33. Mean Effective Pressure in Four-cylinder Clement-Talbot Engine with Petrol. (Watson.)	240
33A. Power Output and Fuel Consumption. (Ricardo.)	243
34. Temperatures during Expansion Stroke with Different Fuels	248
35. Separation Temperatures of Alcohol-benzene and Alcohol- hexane Mixtures on Addition of Water. (H. B. Dixon.)	257
36. Isotherm for Mixtures of Alcohol, Water, and Ether at 15° C. (Boutin and Sanfourche.)	258
37. Isotherms for Mixtures of Alcohol, Water, and Benzene at 25° C. and -5° C. (Sidgwick and Spurrell.)	259
38. Isotherm for Mixtures of Alcohol, Water, and Hexane at 0° C. (Bonner.)	260
39. Vapour Tension of Alcohol-benzol Mixtures	261
40. Vapour Tension of Alcohol-petrol Mixtures	262
41. Vapour Tension of Petrol, Benzol, and Benzol-alcohol Mixtures	263
42. Formation of Explosive Mixtures at Different Pressures	264
43. Relative "Fluidity" of Different Fuels. (Sorel.)	270
44. Power developed at Different Engine Speeds	288
45. Thermal Efficiency at Different Engine Speeds	289
46. Fuel Consumption at Different Engine Speeds	290
47. Thermal Efficiency. Knight Single-cylinder Sleeve-valve Engine	292
48. Mean Effective Pressure. Knight Single-cylinder Sleeve-valve Engine	292

POWER ALCOHOL

CHAPTER I

INTRODUCTORY: THE MOTOR FUEL QUESTION

THE progress of civilisation during the last century seems to have been in great measure dependent on the extent to which manual labour has been supplanted by power derived from natural sources. In the Middle Ages the only "prime movers" known derived their energy from water and wind. It was not until a comparatively recent period in the history of mankind that engines were invented capable of converting heat into work, and thus of utilising the vast stores of bituminous fuel which had gradually accumulated in the form of coal and mineral oil.

As long as the requirements of industry were of moderate dimensions the output of mineral fuels was quite equal to the demand, and the cost remained at a figure which supplied little incentive to economy in fuel consumption. Within recent years the demands of industry have increased enormously. The older and more accessible coal and oil fields are gradually becoming depleted and the development of new areas of supply, more especially of mineral oil, has barely kept pace with the demand. The inevitable consequence has been a considerable increase in the cost of fuel, and this has emphasised the necessity of improving the efficiency of heat engines and of obtaining the utmost value from the fuel consumed.

For the conversion of heat into work there exist, broadly speaking, two essentially different types of engine. In the steam engine the motive power is derived from the expansion of steam supplied under pressure, and the rôle of the fuel is to generate this steam from a boiler which may be situated at some distance from the engine. Any kind of combustible material can be used as fuel, provided that it can be conveniently applied to the raising of steam. In the internal combustion engine the fuel is mixed with the approximate amount of air required for complete combustion and the mixture

is then burnt inside the engine itself. The rapid combustion of the fuel in a confined space generates a large quantity of gas, which by its expansion supplies motive power to the engine. The action of the engine requires that the combustion of the fuel shall be extremely rapid, and to this end the air and fuel must form an intimate mixture. The available fuels are therefore restricted to those which can be used in the form of gas or vapour, or as a fine spray. There is no reason, *a priori*, why solid fuels reduced to a fine powder should not be successfully employed in internal combustion engines, but the mechanical difficulties encountered are so great that no advance has been made in this direction.

The factors which determine the type of power plant most suitable for any given purpose include the following :

- (a) Cost of installation and maintenance.
- (b) Cost of fuel per unit of heat.
- (c) Amount of labour required for attendance.
- (d) Size and weight of plant.
- (e) Thermal and mechanical efficiency.
- (f) Storage and handling of fuel.
- (g) Continuous or intermittent operation of plant and variations in load.

In factories and stationary power plants the cost of fuel per unit of horse-power developed is all-important. It is not a disadvantage if the plant be large and heavy—in fact, the larger the plant the higher, as a general rule, is the efficiency and the greater the economy in labour and maintenance. There is usually plenty of room for storage and handling of solid fuel. As coal is by far the cheapest fuel obtainable it is almost universally employed, in some form or other, for stationary power plants. Unfortunately the potential thermal units of raw coal are not present in a high state of availability—that is to say, the steam engine and boiler do not constitute an efficient means of converting heat into work. A power plant consisting of boiler and reciprocating steam engine will not convert into work much more than 10 to 12 per cent. of the heat it receives, and a turbine engine about 18 to 19 per cent. Moreover, the economical production of steam power requires that the plant be not too small and that it be operated more or less continuously at a heavy load. Intermittent working at varying loads leads to waste of fuel. It takes a considerable time to raise steam in a boiler, and to bring a steam engine into operation, and the dangers attendant upon high pressure steam plants necessitate constant and skilled supervision.

Internal combustion engines are free from many of these disadvantages and convert into work a greater portion of the heat

which they receive. Under certain conditions, therefore, it is preferable to employ large internal combustion engines utilising gaseous and volatile fuels derived from coal. Thus in many power plants at the present day are installed heavy gas engines working on coal gas, producer gas, and waste gases derived from the coal used in certain industrial processes, such as blast furnaces. The thermal efficiency of these engines is much higher than that of a steam plant, approximating to 40 per cent. in the large gas engine. Such engines running upon blast furnace gas or producer gas from low grade fuel provide an extremely cheap source of power.

There is a second type of heavy internal combustion engine, the Diesel engine, which utilises oil fuel. The use of Diesel engines is greatly on the increase, and they are particularly suited for conditions under which facilities for storage and transport of fuel are limited, and where supplies of cheap oil fuel are available. The Diesel engine operates at extremely high compressions (p. 214), so that it must be massively built and possess a heavy flywheel. Its employment is therefore restricted to conditions under which size and weight are not of prime importance.

Light motor transport is far more exacting in its requirements. It is essential that the engine be small, compact, light, flexible under varying loads and easy to operate, and, further, that the fuel be easily stored and transported. In face of these considerations, cost of fuel is of secondary importance. The petrol engine fulfils these requirements to a high degree, and its use for the lighter forms of transport has developed enormously in recent years in spite of the high cost of volatile liquid fuels.

When compared with other fuels the price of motor spirit is out of all proportion to the work actually obtained from it. With petrol at 3s. a gallon, fuel oil at £4, 10s. per ton, and coal at 40s. per ton, the cost of 100,000 B.Th.U. in the form of petrol works out at about 2s. 2d., as compared with 2½d. for fuel oil, and 1¾d. for coal. The cost of fuel for one horse-power hour is roughly 0·24d. for a large steam plant run on coal, 0·14d. for a Diesel engine working on heavy oil, and 3·3d. for a petrol engine.

Within the last few years the scarcity and rising price of motor spirit has become a serious problem and has directed attention to the whole question of the future development of mechanical road transport.

Makers and users of power units either for factory or transport purposes are often deeply committed to particular types of engines and it is difficult to change over from one fuel to another according to fluctuations in price. It is true that in steam plants temporary alterations can readily be made to admit of the burning of

oil in place of coal, or *vice versa*. But in the case of engines dependent upon special types of fuel it is of paramount importance, as affecting future design and construction, to form some estimate as to the probable trend of the fuel supply. The question is whether the increase in price of certain fuels is the result of a temporary excess of demand over supply, which will readjust itself as new fields are developed and become productive; or whether it is the first symptom of a permanent shortage, becoming more accentuated as the existing reserves of fuel are gradually depleted.

The world's annual output of coal at the present day is estimated to be of the order of 1500 million tons, and of petroleum about 75 million tons or 18,000 million gallons. The reserves of coal known to exist are probably sufficient for over three thousand years at the present rate of consumption, which might be held to indicate that the supply is practically inexhaustible. Against this must be set the certainty of a progressive increase in demand, and the probability of a continual rise in price as the accessibility of the material diminishes. But if the estimate of the reserves be correct, an actual shortage of coal within a reasonable period is an extremely improbable contingency, and the price of this fuel is more likely to be affected by cost of labour and materials than by actual scarcity or depletion of reserves.

The world's reserves of petroleum do not admit of even an approximate estimate. Notwithstanding the various theories advanced to account for the formation of this substance, its origin and the conditions which determine its occurrence in quantity sufficient for commercial exploitation are still obscure. On the one hand, it is held that the existing oil wells have only touched the fringe of the available supplies, and on the other, that the world's reserves of petroleum will not last more than fifty or a hundred years, possibly less. One thing, however, is certain, that the United States, which in 1919 produced 74 per cent. of the world's total output, itself consumed more than this quantity and was importing oil from Mexico and other fields.¹ It was estimated in 1917² that during the period from 1859 to 1917 the oil-fields of the United States had produced a total of 4200 million barrels of crude petroleum, and that the quantity still available underground amounted to 7000 million barrels. As the yearly output was at that time 340 million barrels, this estimate would seem to indicate that the total exhaustion of the United States fields is only a matter of a few years.

There is little doubt that the output of other countries, which in 1919 contributed 26 per cent. of the total production, is capable

of being greatly increased, but such increase has not yet made itself felt. The development of new oil-fields is a slow operation. They are situated in great part in undeveloped countries, and often a long way from the coast. Wells must be drilled, pipe lines laid, storage tanks and refineries erected, and tank steamers built to convey the oil to the points of consumption. In 1913 the world's output of crude petroleum was roughly 13,500 million gallons, of which 4700 million, or about one-third, came from countries outside the United States. In 1919 the figures were 17,500 and 4500 million gallons respectively. Thus the total increase during the period was only 30 per cent. of the 1913 production, and was due solely to the United States, largely on account of the diminished output from the Russian and Roumanian fields. On the other hand, the consumption of petroleum spirit rose greatly during this period, as is indicated by the figures given for the import of petrol into the United Kingdom. In 1913 we imported 101 million gallons of petroleum spirit and in 1920 over 200 million gallons, 40 per cent. of which came from the United States, or from Mexico *via* the United States. In the latter country the consumption of petrol rose from 1200 million gallons in 1914 to 2680 million in 1918. This increased demand has been met largely by widening the "cut" in the distillation and refining of the crude oil with the production of a heavier spirit, and also by "cracking" the higher boiling portions and by recovering the lighter constituents or "casing-head" spirit.

The yield of motor spirit from crude petroleum varies greatly in different localities. Alsatian oil contains very little petrol, while Pennsylvanian crude may yield 20 per cent. or even more. A fair average figure is 6 to 8 per cent., and this may be more than doubled by the adoption of the above expedients. With further developments in carburettor design it will no doubt be possible to utilise in motor-car engines still more of the kerosene fractions of petroleum which at present are employed largely for heavy transport and agricultural engines.

The first half of 1921 has witnessed a decline in the demand for petrol. Stocks accumulated, and production and price have fallen in consequence. It would seem that this is largely a result of general trade depression and cannot be taken as an indication that a shortage is no longer to be feared. The recent correspondence of H.M. Government with the United States on the subject of the Mesopotamian oil-fields³ provides an interesting commentary on the conflicting views held in regard to probable oil supplies of the future.

One is led to the conclusion that a complete solution of the

motor fuel problem can only be found in the opening up of extensive, and as yet unproved, new areas of supply, together with the introduction of fuels derived from sources other than petroleum. Unless the results obtained from existing oil-fields and from new ones now being explored exceed all expectations it is tolerably certain, with the present rate of development of motor transport, that every possible source of liquid fuel will have to be developed to the utmost.

In view of the comparative cheapness and accessibility of coal and the fact that volatile products can be obtained from it by destructive distillation, it is natural to look first to this material as a possible source of motor fuel. Bituminous coal yields on carbonisation at a high temperature 14 to 17 per cent. by weight of gas, 4 to 10 per cent. of tar, and 60 to 75 per cent. of coke. From the tar on further distillation there is obtained from 0.5 to 2 per cent. (0.02 to 0.2 per cent. on the original coal) of a mixture of volatile hydrocarbons eminently suitable for use as a motor fuel. The nature of the light oils and the yields obtained vary greatly according to the type of coal carbonised, and the temperature at which the process is conducted. Broadly speaking, cannel coal carbonised at a low temperature gives about 10 per cent. of a tar rich in aliphatic hydrocarbons, and the tar on distillation gives a high yield of light oils hardly distinguishable from certain kinds of petroleum spirit. Caking coals carbonised at a high temperature give a smaller yield, 4 to 6 per cent., of tar, which on distillation yields a light oil consisting mainly of benzene and its homologues.

In the carbonisation of coal for the production of gas or of hard metallurgical coke only a small proportion of the volatile hydrocarbon oils is condensed with the tar. The greater part remains in the gas and can be recovered by "scrubbing" or washing the gas with oil. Assuming a yield from gas tar of 0.4 lb. benzene and 0.13 lb. toluene per ton of coal carbonised, this can be raised to approximately 10 lb. benzene and 3.5 lb. toluene by washing and oil stripping. Prior to the war the demand for benzol was not sufficiently great to render the stripping of the gas remunerative, and, moreover, the high standard of illuminating power laid down for public supplies of coal gas prevented the removal of more than a small proportion of hydrocarbon oils. During the war efforts were made to recover as much benzene and toluene as possible, and in 1918 the total output of benzol in the United Kingdom was about 42 million gallons, three-fourths of which were produced from coke ovens.⁴ In 1919 to 1920 this had fallen again to 20 million gallons. It has been estimated that the complete extraction of volatile hydrocarbons from the whole of the gas produced in this

country from gas works and coke ovens would produce annually 80 million gallons of motor spirit (Taylor).

The extraction of benzol does not by any means exhaust the possibilities of the application of coal products to motor transport. Light cars have been run successfully on coal gas, but this involves the use either of extremely bulky and inconvenient containers for the fuel, or of heavy cylinders of compressed gas. For the heavier kinds of road transport, steam-propelled vehicles are extensively used and are capable of much further development, while portable gas producers have recently been advocated as a cheap source of motive power. It is stated that the weight of a gas producer specially designed for this purpose is from 3 to 4 cwt., and that its performance compares favourably with that of a steam lorry burning the same type of fuel. A great disadvantage, however, is that it takes fifteen to twenty minutes to start the vehicle from cold, and three to four minutes to start after a short stop.⁵

At the Research Station of the Fuel Research Board⁶ extensive investigations are being conducted on the carbonisation of various kinds of coal under different conditions, special attention being paid to the subject of low temperature carbonisation. There is little doubt that the possibilities of coal as a source of motor fuel are capable of great development, but this is likely to be an extremely slow process. Even if 80 million gallons of benzol were immediately available as a result of the universal adoption of oil stripping at gas works and coke-oven plants, this would only represent about one-third of this country's present estimated requirements in motor fuel. We should still be dependent chiefly upon petroleum. Any further expansion of supplies from coal must wait upon the advent of a complete revolution in our methods of fuel utilisation, when factory and household coal is replaced by a smokeless fuel from which the volatile oils have been extracted, and when practically the whole of the raw coal raised is dealt with in central carbonising plants and there "sorted out" into different fuels each suited to special purposes.

Coal and possibly petroleum may be regarded as originating from the solar energy of prehistoric times and as representing a form of capital which is being depleted at a vastly greater rate than it is being replenished. The realisation that this capital is not unlimited, but may be exhausted within a reasonable time, has directed attention to the possibility of utilising more fully the solar energy of to-day and of obtaining from contemporary vegetation a liquid fuel, such as alcohol, which can be used in place of fuels derived from mineral sources. It has been demonstrated by repeated trials that alcohol can be used successfully as a fuel for

internal combustion engines. Being derived by fermentation from sugar, and thus indirectly from starch and cellulose, three of the chief constituents of plants, alcohol should be capable of being produced annually in quantities limited only by the acreage available for cultivation. It is urged that the development of alcohol as a motor fuel would make this country less dependent upon supplies drawn from restricted areas, mostly at a considerable distance, that production could be expanded almost indefinitely without any danger of exhausting the available reserves, and that agriculture and the food supply would benefit greatly from the increased acreage which would be brought under cultivation.

If one excludes the possibility of a liquid fuel being produced by inorganic agency from the hydrogen of water and the carbon of carbonic acid or carbonates, contemporary vegetation constitutes the only alternative to bituminous mineral deposits as a source of motor spirit, and it would seem that it must eventually supply a large proportion of the world's requirements of liquid fuel. But at the present day the most important factor is the relative cost of alcohol as compared with petrol, and it is here that one of the chief difficulties is encountered.

When a hexose sugar, such as dextrose, is fermented, not more than half of it can be obtained in the form of alcohol. If the equation



be taken as representing approximately the sum of the rather complicated reactions which take place, calculation shows that the utmost yield of alcohol theoretically obtainable corresponds to 51.1 per cent. of the sugar. Expressed in terms of carbon, the most important constituent from the fuel standpoint, the proportion converted into alcohol is two-thirds, or 66.6 per cent. The remaining third is lost as carbonic acid gas, which has only a limited value as a by-product. Further, the quantity of fermentable carbohydrate contained in a given weight of vegetable matter is comparatively small. Whatever the raw material employed, be it grain, potatoes, beet, or wood, the total weight which must be grown, harvested, and transported to the factory is considerably greater than the weight of fermentable constituents. Thus potatoes contain on an average 16 to 18 per cent. of fermentable carbohydrates, and the weight of 95 per cent. alcohol obtainable in practice is not more than 7 per cent. of the total weight of the crop. Cereals contain from 60 to 75 per cent. of fermentable carbohydrates, and the yield of 95 per cent. alcohol is from 26 to 32 per cent. of the total weight of the grain. If the straw which

forms part of the crop, and which must be harvested and transported with it, is also considered, the percentage yield of alcohol is reduced to approximately half of this figure. In the case of wood, the yield of alcohol obtained on a manufacturing scale represents not more than 5 to 7 per cent. on the timber as felled.

Apart from the cost of cultivating and delivering to the factory this mass of raw material, there must be taken into consideration the actual cost of manufacture of 95 per cent. alcohol. This is estimated to be about 9d. per gallon including depreciation on plant.⁷

Petroleum, on the other hand, is a naturally occurring product, and when once wells have been sunk and refineries erected, the raw material is not burdened by recurrent expenses of cultivation and harvesting. The yield of motor spirit from the crude oil is, it is true, not much higher than the average yield of alcohol calculated on the raw material, but the heavier constituents of crude oil are all available for use in some form or other as fuel. The costs of refining are low, and compare favourably with the cost of manufacture of alcohol. It may be urged that with alcohol the by-products remaining after extraction of the fermentable carbohydrates have in many cases a considerable value as feeding stuffs or manures, and also that certain raw materials, such as molasses, sawdust, and rice straw, are waste products costing little or nothing. These factors must be taken into consideration when comparing the cost of alcohol with that of other fuels. But it stands to reason that the residues after extraction of carbohydrates cannot possess more than a fraction of the feeding value possessed by the original raw material. The difference must be charged to the alcohol. The use of the residues for manure simply amounts to returning to the soil the nitrogen, phosphorus, and potash taken out of it by the crop. Waste cellulose materials, such as sawdust and straw, are bulky and difficult to transport, and the costs of handling are high in comparison to the weight of the material and the yield of alcohol obtained. It is obvious, therefore, that alcohol is placed at a disadvantage compared with petrol as long as the supply of the latter is equal to the demand. However high the present price of petrol, distillers will not undertake the erection of expensive plant for the production of alcohol if they are liable at any time to be put out of business by petrol prices falling to a figure more closely approximating to the actual cost of production and distribution.

Owing to the prevailing uncertainty as to the world's reserves of mineral oil it would be unwise to assert that power alcohol offers an immediate solution of the motor fuel problem. The balance of evidence, however, certainly appears to favour the view that before

many years have elapsed the supply of petrol will be permanently unequal to the demand, and that power alcohol, considered from the standpoint of a supplementary and not necessarily a competitive fuel, has an undoubted future before it, provided that the industry is organised and developed on sound lines.

REFERENCES

¹ Standing Committee on Investigation of Prices. Second Report on Motor Fuels. Cmd. 1119 (1921). Also Department of Scientific and Industrial Research: Fuel Research Board. Fuel for Motor Transport, 1920.

² *Engineering*, 1918, **106**, 633.

³ Cmd. 1226 (1921).

⁴ Department of Scientific and Industrial Research. Fuel Research Board. Fuel for Motor Transport, 1920.

⁵ D. J. Smith, *Inst. Automobile Engineers*, Jan. 8, 1920. *Engineering*, 1920, **109**, 59, 92.

⁶ Report of the Fuel Research Board for 1918 and 1919.

⁷ A. P. H. Desborough, *Journ. Soc. Chem. Ind.*, 1920, **39**, 302R.

CHAPTER II

THE PLANT AS A SOURCE OF ALCOHOL

The Formation of Carbohydrates in Plants: Respiration and Photosynthesis.—The growth of plants, like that of almost all living organisms, is dependent upon two main processes, respiration and nutrition. The energy required by the plant for growth and development is derived from the oxidation of its tissues by atmospheric oxygen with the production of carbon dioxide and water. Oxygen is continually being absorbed from the air over the whole surface of the plant and carbon dioxide and water are given off. There are no special respiratory organs, the absorption of oxygen taking place chiefly at the points where the processes of growth are most active, such as leaves, growing points, and germinating seeds.

The green plant obtains its food supply in two different ways—by photosynthesis or carbon assimilation, and by absorption of water and salts from the soil through the roots. Photosynthesis is effected through the medium of chlorophyll, the pigment existing in the chloroplast cells of the leaves and other green parts. Chlorophyll is a substance of complex constitution which has the property of absorbing certain of the red rays of the light spectrum and transmitting most of the rays from yellow to violet. The energy of the light absorbed is in some way utilised to promote the synthesis of carbohydrates from water and atmospheric carbon dioxide. This process is quite distinct from respiration. Whereas the latter involves absorption of oxygen and evolution of carbon dioxide and has, as its sole function, the supply of energy, photosynthesis is the reverse process, carbon dioxide being absorbed for the nutrition of the plant and oxygen evolved. The two processes occur simultaneously and there is no constant relationship between the volumes of each gas absorbed and exhaled. Photosynthesis varies with light intensity, being most active in bright sunlight and suppressed at night.

The absorption of carbon dioxide takes place through the "stomata" or pores of the leaf, the diffusion of this gas into the cell sap being extremely rapid. When one considers that practically the whole of the carbon of the plant is derived in this way from the

atmosphere, which itself contains only 0.03 per cent. by volume of carbon dioxide, and that the stomata represent not more than 1 to 3 per cent. of the total surface area of the leaf, it is evident that the absorptive capacity of these minute pores must be of a high order. H. T. Brown,¹ in an investigation of the laws of gaseous diffusion through small apertures and multiperforate septa, has shown that the stomata must have the power of absorbing atmospheric carbon dioxide at a rate about fifty times greater than apertures of similar dimensions would do if they were completely filled with a constantly renewed solution of alkali hydroxide.

The building up of starch and sugars by the agency of chlorophyll was held by Baeyer to be dependent upon the intermediate formation of formaldehyde and the subsequent polymerisation of this substance to a hexose sugar



Several attempts have been made² to show that formaldehyde is actually formed as an intermediate product, but it cannot be said that its existence in the growing plant has yet been satisfactorily demonstrated. H. Wager³ and C. H. Warner⁴ showed that preparations of chlorophyll when exposed to light and oxygen become bleached, and that traces of aldehydes, including formaldehyde, are produced. Wager suggested that the formation of sugars and starch in the plant may be due to photo-oxidation of chlorophyll and subsequent polymerisation of the aldehydes thus formed, rather than to direct synthesis from carbon dioxide and water. That formaldehyde is in fact formed by the action of ultra-violet light on carbon dioxide and water under certain conditions, and that it can also be polymerised to reducing sugars in ultra-violet light, was shown by Moore and Webster.⁵ But it is extremely improbable that the plant itself utilises ultra-violet light, since these rays would be more or less completely absorbed by the epidermis before reaching the chloroplasts, and, moreover, plants can grow normally under glass, which is opaque to ultra-violet rays. Baly⁶ and his co-workers have shown that while the formation of formaldehyde from carbon dioxide and water, and its subsequent polymerisation to reducing sugars are effected, in pure aqueous solutions, only by the action of ultra-violet light of definite and very short wave-length, yet in the presence of certain coloured substances both these processes can be "photocatalysed," in that they can be actuated by visible light of longer wave-length. It would seem that the function of chlorophyll may be that of a photocatalyst of both processes simultaneously, and that its presence in the leaf may enable the synthesis of carbohydrates from

carbon dioxide and water to take place under the influence of visible light, without the free existence of formaldehyde as an intermediate product.

The carbohydrates elaborated by the plant vary progressively in complexity from the simple hexose sugars to starch and cellulose. Apparently, cane sugar is the first product of the condensation of formaldehyde in the chloroplasts, and this sugar is partly utilised direct in the metabolism of the growing cells and partly conveyed, as hexose sugar, to other parts of the plant where condensation to sucrose and starch takes place. The chief hexose sugars formed are dextrose, lævulose, mannose, and galactose, all possessing the empirical formula $C_6H_{12}O_6$. Maltose and sucrose, $C_{12}H_{22}O_{11}$, may be regarded as being formed from two molecules of a hexose sugar by elimination of one molecule of water. Starch $(C_6H_{10}O_5)_n$ may similarly be looked upon as a condensation product of several molecules of a hexose sugar with the loss of an equal number of molecules of water. Cellulose possesses approximately the same empirical formula as starch and appears to be built up mainly of dextrose units, but its composition varies somewhat according to the source from which it is obtained. Inulin, a constituent of certain tubers, yields lævulose on hydrolysis, and the mannans and galactans give the hexose sugars mannose and galactose. Lignin, which is a constituent of the lignocellulose of woody plants, appears to be produced partly by the condensation of pentose sugars, of which arabinose and xylose are the most important.

The mechanism by which the countless other organic constituents of the plant are elaborated is quite unknown. The simple substances synthesised in the chloroplast cells undergo varied transformations and condensations with nitrates, sulphates, and phosphates derived from the soil, producing the different proteins which are essential constituents of the living cell. Oils and fats, secretory substances such as organic acids, colouring matters, and "ferments" and excretory products, resins, gums, alkaloids, etc., are also formed in great variety. Potash, silica, lime, and other inorganic materials derived from the soil are found in varying proportions in the ash of all plants.

Enzymes.—In the early stages of growth, from the germination of the seed until the appearance of leaves, no chlorophyll is present and no photosynthesis can take place. The plant at this stage is dependent for its supply of carbon upon reserve material previously stored up in the seed. Thus it is found that according to the species and habit of growth of the plant, some of the carbohydrates elaborated in the leaf have been transferred to seeds, roots, tubers, or stems, according as these are destined to serve as

the starting-points for new growth in the following season. It is only in certain plants that carbohydrates form the chief reserve material. In many plants such as peas and beans the seeds contain a high proportion of protein, while in others oil or fat is the main constituent.

As stored in the seed or root these reserve materials are to a great extent insoluble in the cell sap. Before they can be made available for the metabolism of the growing plant they must be broken down into simpler bodies and brought into solution for transference to the growing points. This breaking down is effected by the agency of unorganised ferments or "enzymes," substances of unknown constitution secreted by the protoplasm of all living cells.

The most important properties of enzymes as a class are as follows :

(i) They are colloidal in nature, *i.e.* they do not diffuse through parchment paper or similar membranes.

(ii) They act as catalysts in that they increase the velocity of a reaction which normally proceeds at a slow rate. A minute quantity of an enzyme is able to transform a large amount of the substance upon which it acts.

(iii) They are specific in their action, that is, a particular enzyme will act only upon one compound or group of compounds. For instance, the enzyme amylase converts starch into maltose, invertase accelerates the hydrolysis of sucrose to dextrose and lævulose, and pepsin converts proteins into peptones. It is probable that enzymes act by "adsorption," or by combination with the substances which they attack, and their specific action is possibly due to the configuration of the respective molecules, much in the same way as a key is fitted to a lock (Emil Fischer).

(iv) Enzyme action is largely dependent upon the maintenance of certain temperature conditions. Like catalysts, enzymes act more rapidly the higher the temperature, but at temperatures between 60° and 100° C. they are rapidly destroyed. The optimum temperature, *i.e.* that at which the rate of reaction reaches a maximum before yielding to the rate of destruction, varies with different enzymes and usually lies between 37° and 55° C. At 0° C. enzyme action is barely perceptible.

(v) The reaction of the liquid is an important factor in determining the rate of action of enzymes. Most of them will act only within definite limits of acidity or alkalinity, and are sensitive to changes in the hydrogen-ion concentration of the solution.

(vi) It appears probable that enzymes are able to synthesise the same compounds which they split up, but at a much slower

rate. It would seem that a state of equilibrium is set up in which the amount of the original substance is extremely small compared with that of the hydrolytic products.

As the different enzymes can only be differentiated by their specific action on certain substances, their names are derived from those of the substances attacked, with the addition of the suffix "-ase," and in the case of the adjective the termination "-clastic."⁷ Thus the enzyme which hydrolyses starch to maltose is termed "amylase" and is an "amylolytic" enzyme, while those attacking fats are termed "lipases" or "lipolytic" enzymes. This nomenclature is not universal, as it is convenient to retain many of the old-established names, such as the "diastase" or starch-hydrolysing enzyme of malt, the "pepsin" of the gastric juice, and the "zymase" of yeast. The substance attacked by the enzyme is termed the "substrate."

The functions of the enzymes secreted by plant protoplasm are well illustrated in the germination of barley, a process which, owing to its importance in brewing and distilling, has been studied in great detail.

Germination of Barley.—The barley grain consists essentially of two main portions, the germ and the endosperm, separated from each other by a layer of epithelial cells termed the "secretory" layer (Fig. 1). The endosperm consists of a mass of large thin-walled cells packed with granules of starch and protein, and bordered, in the upper portion of the grain, by three or four rows of square-shaped cells, the "aleurone" layer, filled with protein granules. When the grain is placed under suitable conditions of temperature, moisture, and air supply, it germinates, and the plumule and rootlet begin to develop. Enzymes, principally diastase and proteolytic enzymes, are formed in the secretory layer and to a less extent in the aleurone layer, and penetrate the endosperm, partially breaking down the reserve starch and proteins into sugars and amino-acids.

Enzymes, being essentially colloidal in character, cannot penetrate the cell walls of the endosperm unless these are either dissolved or rendered permeable. It was formerly supposed that the first enzyme to be secreted was a "cellulase" capable of hydrolysing cellulose, and that the process of germination was accompanied by solution of the cell walls. A. R. Ling⁸ has shown that the cell walls remain intact, at any rate during the preliminary stages of the conversion of the cell contents into sugars, which indicates that the enzymes secreted have the power of rendering the cell-walls permeable to colloids, but not of dissolving them. The cell-wall appears to consist largely of hemicelluloses yielding pentose

sugars on hydrolysis (Schulze) and the enzyme concerned in rendering them permeable is termed "cytase."

The sugars formed by the action of diastase on the starch granules are conveyed by the cell-sap through the epithelial layer into the cells of the "scutellum," where they are partly utilised in the metabolism of the cell protoplasm and partly redeposited

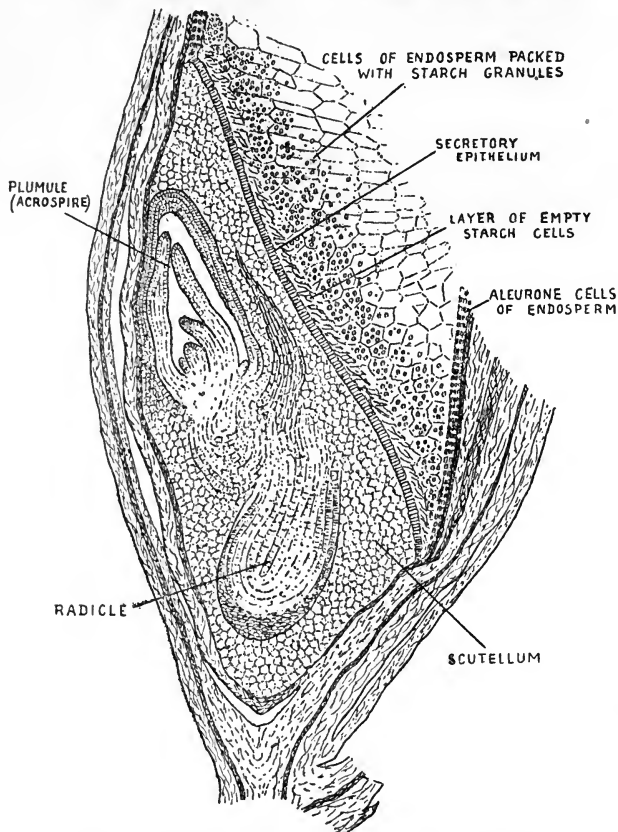

FIG. 1.—Section of a Grain of Barley (diagrammatic).

as starch. Under normal conditions of uninterrupted growth the transference of carbohydrates and other food material from the endosperm to the scutellum continues until the appearance of leaves enables the plant to draw its supplies of carbon from the atmosphere. When this stage is reached the endosperm has been completely emptied of its reserve food material.

Fungi.—Chlorophyll is present in the great majority of plants, and is even found in unicellular algæ and in certain organisms

closely allied to the bacteria. There are, however, many plants such as the "mycetes," or fungi, and certain of the higher plants, which contain no chlorophyll. They cannot therefore assimilate the carbon dioxide of the air and must depend upon other sources for their supply of carbon. Some of these plants are parasites, obtaining their nutriment from living organisms, others which are able to assimilate non-living organic matter are termed "saprophytes," and to this class belong the yeasts, moulds, and bacteria.

It has already been noted that respiration and nutrition are essential processes in plant life, and that as a result of cell metabolism various secretions and excretory products are produced. In principle these characteristics persist in the lower fungi and bacteria. These organisms can grow only in media which contain the necessary nutriment in the form of organic carbon compounds, combined nitrogen and mineral salts, and it would seem that all of them, with the exception of certain anaerobic bacteria, require a supply of oxygen for their development. But the most striking characteristic of some of the lower fungi is the manner in which the secretory functions are developed and the magnitude and variety of the chemical changes which can be brought about by the secretions. The best known and most widely studied of these chemical changes is the conversion of hexose sugars into alcohol and carbon dioxide by the enzymes secreted by yeast :



Yeasts.—The yeasts or *Saccharomycetes* are minute unicellular organisms belonging to the family of so-called "budding fungi." The latter term has reference to the mode of reproduction by vegetative budding, a process which may be regarded as a modification of ordinary cell division. During its growth the yeast cell gives rise to a small outgrowth which gradually increases in size, and is finally detached as a separate yeast cell. These new cells, even before they are separated from the parent cells, may repeat the process of budding, thus giving rise to cell groups. The term *Saccharomyces* is, strictly speaking, confined to those budding fungi which can under certain conditions reproduce themselves in another manner, namely, by spore formation. When yeast is grown on solid media with consequent restriction of available food material, the process of budding ceases, and the yeast cell forms internal spores or "ascospores" (endospores). The spores probably represent a resting stage of the yeast. On the return of favourable conditions, with a sufficiency of nutriment, the outer casing enclosing the spores is burst, and each of the spores becomes a new cell which commences to bud.

The yeast employed in breweries and distilleries is the species *S. cerevisiæ*. Owing to the high fermentative activity of this species in malt infusions, and the comparatively small amount of unpalatable by-products in the resulting fermented liquor, *S. cerevisiæ* has become, in course of centuries, the "cultivated" species, as opposed to the so-called "wild" yeasts which occur widely distributed in the air and on the surface of ripe fruit.

The term "wild yeasts" is often somewhat loosely used to cover a large variety of budding fungi capable of decomposing sugars into alcohol and carbon dioxide. Many of these organisms can form ascospores and are therefore true *Saccharomycetes*, others, such as *Torulâ*, *Mycoderma*, and *Monilia*, do not form ascospores, although in many other respects they resemble the true yeasts. Wild yeasts differ among themselves in their capacity for fermenting different sugars and in the amount and character of the products other than alcohol formed by them during fermentation. A further characteristic often made use of in differentiating the various species is the formation of tough films of interlacing "mycelium," or stem-like structure, upon the surface of the liquid.

S. cerevisiæ is often contaminated with air-borne wild yeasts which are liable to cause irregular fermentation and to give rise to by-products affecting the appearance and taste of the resulting beverage. This was a cause of constant trouble in breweries and distilleries until Hansen in 1879 showed that it was possible, by starting from a single yeast cell, to obtain a supply of a pure yeast in any desired quantity. A small quantity of a liquid containing a few yeast cells in suspension is added to a sterilised nutrient solution containing sufficient gelatine to cause it to set when cold. The mixture is transferred to shallow glass dishes and kept at a temperature favourable to the growth of the yeast. If the number of cells originally present in the liquid was small, they will be sufficiently widely separated on the surface of the gelatine for the cell colonies to develop without touching or growing into each other, until they become easily visible to the naked eye. It is then possible to remove a few cells from a selected colony by means of a platinum wire and cultivate them progressively in vessels containing sterile nutrient solutions, until a large yeast crop is obtained. This yeast can then be used in brewing operations, and the trouble which may arise from the presence of wild yeasts can be avoided.

The various species of *Saccharomyces* thus isolated by Hansen from yeast mixtures were differentiated by the length of time taken to form ascospores when kept under standardised conditions at definite temperatures. Hansen's work led further to the recogni-

tion of several types or races of *Saccharomyces cerevisiæ*, exhibiting well-marked differences in the extent to which they could ferment different sugars and in the character of the fermentation induced. These distinctive characters were found often to persist unchanged through many generations, indicating that certain of the types might be not merely varieties, but distinct species.

Some of the types possess a low "attenuating" power. When grown in a solution containing hexose sugars or polysaccharides the "attenuation" or reduction in the specific gravity of the liquid, owing to production of alcohol, is comparatively small, indicating that some of the carbohydrate remains unfermented. Others possess a high attenuating power, the conversion of fermentable matter into alcohol being nearly complete. In practice the former are often termed "Saaz" type, and the latter "Frohberg" type yeasts, after the breweries where the most characteristic of them were first isolated.

Another practical classification is that of "top" and "bottom" yeasts, the latter of which form a sediment on the bottom of the vessel during fermentation, while the former collect partly at the bottom and partly at the top of the liquid. Distillery yeasts belong mainly to the top fermentation Frohberg type. This type is subdivided into races differing from each other in rate of growth, rate of fermentation, amount of foam produced in the fermenting liquid, resistance to toxic influences, optimum temperature of growth, and other characteristics.

While the *Saccharomycetes* and associated budding fungi are the main organisms concerned in the fermentation of sugars, there are a number of moulds and bacteria which are of importance in the distillery owing to their power of secreting amyloclastic and sacroclastic enzymes. These will be referred to more fully in connection with the special processes in which they are employed.

Alcoholic Fermentation.—Pasteur's and Liebig's Views.—The factors influencing the fermentation of sugars by yeast were for many years the subject of acute controversy between Pasteur and Liebig. Pasteur maintained that fermentation by yeast was a direct consequence of the processes of nutrition, assimilation, and growth, when these are carried on without the agency of free oxygen. If the yeast were supplied with a sufficiency of air for respiration, fermentation was reduced and the yeast developed after the manner of an ordinary fungus. If the supply of oxygen were cut off, the yeast was able to effect the decomposition of sugar into alcohol and carbon dioxide, and to utilise the heat energy thereby set free for cell metabolism and growth. The decom-

position of a hexose sugar into alcohol and carbon dioxide may be expressed by the equation



an equation which represents the summation of a series of complex chemical reactions. Nothing appears to be gained or lost by the yeast in this process except energy, and in thermochemical notation the above equation may be written



indicating that a molecular weight in grams of sugar on being split up into alcohol and carbon dioxide sets free 28 Calories of energy in the form of heat.

When yeast is grown in a saccharine solution, it assimilates for its nutrition a certain proportion of the carbohydrate, but a far larger proportion is simply split up by fermentation into alcohol and carbon dioxide. Pasteur maintained that fermentation, apart from carbohydrate assimilation, was only exhibited when yeast was grown under more or less anaerobic conditions and that its function was to replace respiration as a source of energy. In other words, fermentation was "life without air." Liebig, on the other hand, held that fermentation was purely a chemical phenomenon. The decomposition of sugar into alcohol and carbon dioxide he considered to be an ordinary chemical process which was catalysed or accelerated by a minute quantity of a ferment or catalyst. Ferments were unstable nitrogenous substances formed by the oxidation of plant juices containing sugar. Yeast was able to act as an organic catalyst, and its action in inducing the decomposition of sugar was analogous to that of platinum and other inorganic catalysts in accelerating chemical reactions. The growth of yeast and the metabolism of the cell were, in Liebig's view, in no way connected with the process of fermentation, which was an accidental phenomenon quite apart from the respiration and nutrition of the yeast plant.

Adrian Brown's Work.—Pasteur's theory that fermentation was life without air was critically examined by Adrian Brown in 1892 to 1894, who carried out an extensive series of experiments on the growth of yeast under different conditions of aeration and sugar supply, and introduced improved methods of assessing the "fermenting power" of yeast. Brown concluded that "yeast cells can use oxygen in the manner of ordinary aerobic fungi, and probably do require it for the full completion of their life-history, but the exhibition of their fermentative function is independent of their requirement with regard to free oxygen." In a later

paper he claimed to have established definitely the fact that yeast growth increases proportionately with the amount of dissolved oxygen initially present in the liquid, and that in the absence of oxygen the reproduction of yeast cells could not take place. These experiments appeared to lend additional support to Liebig's view that fermentation was not an essential part of the vital processes of the yeast cell.

Slator's Work on Rate of Fermentation.—A. Slator,⁹ as a result of his researches on the rate of fermentation by yeast, has advanced a theory which in some respects resembles that originally put forward by Pasteur, *i.e.* that yeast is an organism

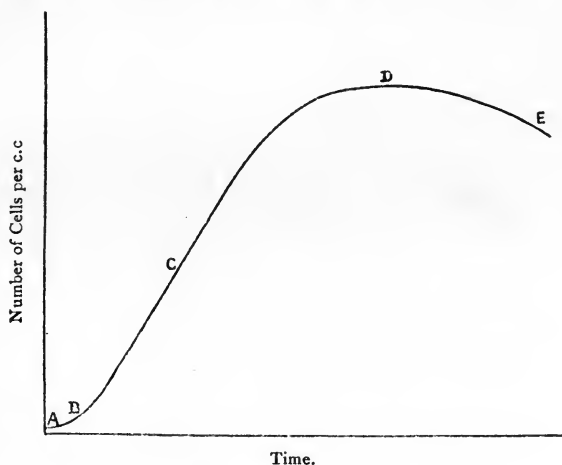

FIG. 2.—Diagram of Yeast Growth.

(A. Slator, *Journ. Soc. Chem. Ind.*, 1919, **38**, 391R.)

A = Lag phase in growth.

C = Retarded growth.

B = Logarithmic phase.

D = Yeast crop.

E = Death of yeast cells.

endowed with two modes of life—aerobic and anaerobic. Slator considers that each of these two modes of growth involves a different set of chemical reactions. The growth of yeast in a nutrient solution is marked by five distinct stages. When yeast cells are introduced into the solution there is at first a period of quiescence, termed the "lag-phase" in growth, before any budding takes place (A, Fig. 2). This is followed by a period of vigorous growth (B) during which the multiplication of cells takes place at a logarithmic rate. The third stage (C) is characterised by a decrease in the rate of multiplication owing to retarding influences, the chief of these being the accumulation of carbon dioxide. Final cessation of yeast growth is brought about by lack of fermentable

sugar and accumulation of alcohol, the relative extent to which each of these factors is responsible varying according to the conditions under which the fermentation is carried out. The number of yeast cells in the liquid is now at a maximum (D), and the fifth stage (E) in the process is marked by the death of the cells at a rate which has not yet been fully investigated.

It was formerly held, in the light of Adrian Brown's work, that these different rates of growth at various stages in the fermentation were conditioned largely by the supply of oxygen, and that the initial development of yeast under apparently anaerobic conditions in non-aerated malt wort was due either to oxygen initially dissolved in the wort or to the presence of a substance which readily gave up its oxygen to the yeast. Sclator considers that oxygen, either free or combined, plays no part in the process of budding, the energy necessary for growth being obtained from the fermentation of the sugar. The reason that oxygen appears, under ordinary conditions, to accelerate the growth of yeast, is that it assists in removing carbon dioxide, which is one of the main inhibiting factors. If the fermentation be carried out under conditions which permit of the removal of carbon dioxide as fast as it is formed, the rate of cell multiplication is just as great when oxygen is completely absent as when it is present—in fact, free oxygen slightly retards the initial rate of growth. The later stages are favourably influenced by the presence of air, and aerobic vegetative growth then comes into consideration.

Buchner's Researches.—As the outcome of Pasteur's and Liebig's work it was recognised that alcoholic fermentation, whether essential or not to the vital processes of the yeast cell, must be caused by some substance elaborated by the cell and capable of acting as a ferment or catalyst in promoting the decomposition of the sugar. In 1878 Kühne suggested the name "enzyme" (ἐν ζύμῃ: in yeast) for the so-called "unformed ferments" secreted by living organisms. No proof, however, was forthcoming that an enzyme causing fermentation was capable of separate existence apart from the living cell, until the discoveries of E. Buchner in 1897 threw an entirely new light on the whole subject.

Buchner was engaged in the preparation of yeast juice for therapeutical purposes by grinding up the cells with sand and squeezing out the juice in a hydraulic press. It was found that if the mass were mixed with kieselguhr before pressing, the necessary porosity was obtained, and the choking of the filter pores by the broken cell membranes was avoided. The yeast juice thus obtained rapidly underwent change, and sugar was added with a view to preserving

it.¹⁰ Buchner found that under these conditions the sugar was fermented, although no yeast cells were present, and that the fermenting power of the juice was not destroyed by the addition of small quantities of protoplasmic poisons such as chloroform and sodium arsenite nor by precipitation with alcohol. He concluded therefore that alcoholic fermentation must be due to a soluble enzyme present in the yeast, to which he gave the name of "zymase."

The fermentation of sugar solutions by the zymase of yeast juice is exactly similar in kind though not in intensity to the action of the living yeast, alcohol and carbon dioxide being produced in the same ratio. The four hexose sugars fermented by living yeast, dextrose, lævulose, mannose, and galactose, are also fermented by yeast juice. Fresh yeast juice is rapidly autolysed,—that is, it undergoes a loss of fermenting power,—and this was ascribed by Buchner to the presence of a proteoclastic enzyme which destroyed not only the protein of the juice but also the zymase.

Harden's Theory of Fermentation.—The property exhibited by yeast of digesting itself was utilised later on as a means of testing for the presence of "antiferments" in the blood serum of animals. If such an antiferment were present the autolysis of the yeast juice should be suppressed. In the course of these experiments Harden found that when blood serum was added to a mixture of yeast juice and sugar, 60 to 80 per cent. more sugar was fermented than in the absence of the serum. The same effect was produced when either boiled fresh yeast juice or boiled autolysed yeast juice was added in place of blood serum.¹¹ The acceleration of fermentation thus brought about was ultimately found by Harden and Young¹² to be mainly due, not to the action of an antiferment in preventing the destruction of the zymase, but to two independent factors, namely, the presence of phosphates in the liquid and the existence in the boiled yeast juice of a co-ferment or co-enzyme the presence of which was indispensable for fermentation.¹³

On adding a soluble phosphate to a fermenting mixture of yeast juice and a hexose sugar, the rate of fermentation was greatly accelerated. During this period of enhanced fermentation the amounts of additional carbon dioxide and alcohol formed were exactly in the ratio CO_2 or $\text{C}_2\text{H}_5\text{O} : \text{R}'_2\text{HPO}_4$.¹⁴ This fact indicated that a definite chemical reaction occurred between the sugar and the phosphate, and Harden put forward the following equation as representing the rôle of phosphates in alcoholic fermentation :

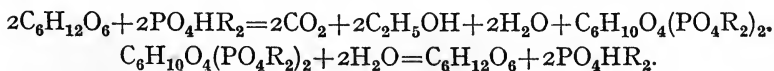

Several metallic salts of hexose diphosphoric acid were obtained in the form of amorphous precipitates, but the free acid was capable of existence only in dilute solution. The decomposition of hexose phosphates into hexose and phosphate appeared to be due to the action of an enzyme which Harden provisionally termed "hexose-phosphatase." Whatever the hexose sugar originally present, whether dextrose, lævulose, or mannose, the same hexose phosphate is obtained, and on hydrolysis this always yields lævulose. It is remarkable that the hexose phosphate is not fermented or hydrolysed by living yeast, a fact which has been cited as an argument against this theory of fermentation, but as F. G. Hopkins¹⁵ points out, this would appear to be largely a question of cell permeability. The above reactions may be considered as taking place inside the yeast cell, while added hexose phosphate is not able to diffuse into the cell.¹⁶

The fact that hexose phosphate, whether derived from dextrose, lævulose, or mannose, yields on hydrolysis always the same sugar, lævulose, can be explained on the assumption that all three sugars can exist in solution in a common enolic form¹⁷ which is the form actually combining with phosphate and entering into fermentation. In neutral solutions the change to the enolic form is slow but in presence of alkalis equilibrium is rapidly established.

If boiled yeast juice be dialysed, the substance which accelerates fermentation passes into the dialysate. Harden and Young found that if fresh yeast juice were dialysed, or better filtered under high pressure through porous earthenware impregnated with gelatine (Martin filter), the juice could be divided into a residue and a filtrate, each of which by itself was incapable of fermenting sugar solutions. When the residue and filtrate were reunited, the mixture produced almost as active a fermentation as the original juice. It was clear, therefore, that alcoholic fermentation is caused by the simultaneous presence of two substances, one a colloid which cannot pass through a gelatine filter, and the other a body of much simpler constitution. This latter substance is not destroyed by heat, but is capable of being decomposed by a variety of reagents. Harden and Young¹⁸ showed that it is not a phosphate, and its identity is still in doubt, though recent work has afforded indications that it may be acetaldehyde or pyruvic acid (p. 28).¹⁹

While it is certain that phosphates play a fundamental part in the mechanism of fermentation, the equation given above does not fully elucidate the actual steps by which the hexose molecule is broken down into alcohol and carbon dioxide. Harden suggested that in the presence of phosphate and enzyme two molecules of hexose are each decomposed primarily into two groups. Of the four

groups thus produced two go to form alcohol and carbon dioxide, while two are recombined to a new chain of six carbon atoms which forms the carbohydrate residue of the hexose phosphate. When one considers that there are twenty-nine possible hydroxyl substitution products of propane $\text{CH}_3\text{CH}_2\text{CH}_3$, twenty of which are known, it is obvious that a great variety of schemes might be conceived as representing the progressive decomposition of the hexose molecule into alcohol and carbon dioxide. Several theories have been advanced, but some of them fail in that they are not supported by sufficient evidence either that the intermediate compound postulated is actually formed, or that when formed it can be broken down by yeast into alcohol and carbon dioxide. Thus Buchner and Meissenheimer considered that lactic acid $\text{CH}_3\text{CHOH.COOH}$ was an intermediate product. This acid is frequently present in yeast juice in small quantities, but Slator showed that lactic acid could not be split up by yeast into alcohol and carbon dioxide, a fact which was subsequently confirmed by Buchner and Meissenheimer themselves.

Slator pointed out that before any particular substance could be admitted as being a probable intermediate product in alcoholic fermentation, it must be shown that the reaction by which it is fermented must proceed at least as rapidly as that by which it is formed. Otherwise there would be an accumulation of the intermediate substance in the liquid. This argument would appear to weigh against the probability of methyl-glyoxal $\text{CH}_3\text{CO.CHO}$, glyceraldehyde $\text{CH}_2\text{OH.CHOH.CHO}$, or dihydroxy-acetone $\text{CH}_2\text{OH.CO.CH}_2\text{OH}$, being intermediate products, since they are either unfermentable by yeast or only broken down at a comparatively slow rate. The experimental data on these points, however, are uncertain owing to the multiplicity of the factors involved, and Lebedeff considered that both glyceraldehyde and dihydroxyacetone could be regarded as intermediate products of fermentation.

Neuberg's Theory.—The view most generally held is that advanced by Neuberg, according to which pyruvic acid, $\text{CH}_3\text{CO.COOH}$, is the intermediate product. In 1911 Neuberg and his co-workers found that yeast was able rapidly to decompose several α -keto acids with evolution of carbon dioxide and formation of the corresponding aldehyde

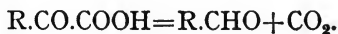

Pyruvic acid is fermented at approximately the same rate as is dextrose, with the production of acetaldehyde and carbon dioxide. The yeast enzyme which is assumed to be the active agent in this decomposition is termed "carboxylase." The subsequent reduction

of acetaldehyde to alcohol is possibly due to a "reductase," but Schade has advanced a theory that it may be due to the interaction of acetaldehyde with formic acid, which was found by Harden to be a regular product of the action of many bacteria on dextrose—

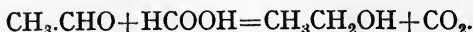

A. Fernbach²⁰ showed that if the fermentation was carried out in the presence of calcium carbonate the pyruvic acid was neutralised as it was formed, and the yield of calcium pyruvate amounted to nearly one-fourth of the weight of sugar fermented. Some calcium lactate was also produced, the lactic acid being formed possibly by the reduction of pyruvic acid.

The complete scheme of reactions suggested by Neuberg and Kerb²¹ is as follows :

Dextrose is first split up into two molecules of methyl-glyoxal, one of which is oxidised to pyruvic acid while the other is reduced to glycerol :

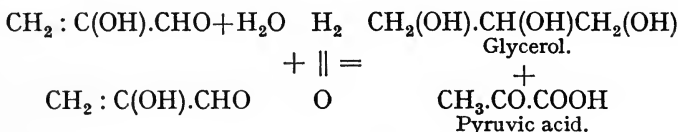

The pyruvic acid is then decomposed by carboxylase yielding acetaldehyde and carbon dioxide

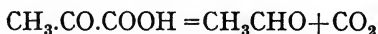

Of the acetaldehyde produced part is reduced direct to alcohol and part reacts with a further molecule of methyl-glyoxal yielding pyruvic acid and alcohol—

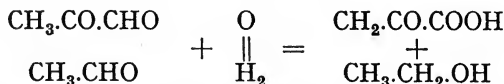

The pyruvic acid then again undergoes decarboxylation to acetaldehyde.

According to this scheme glycerol and acetaldehyde should appear as by-products of the fermentation process, which is in fact the case. Glycerol is always produced to the extent of approximately 3.8 per cent. of the sugar decomposed,²² and Ashdown and Hewitt²³ have shown that acetaldehyde is a regular product of alcoholic fermentation, although they considered it to be formed in a somewhat different manner.

Neuberg's theory has led to a remarkable technical development in the application of fermentation. It was found²⁴ that by carrying

out the fermentation in the presence of calcium or sodium sulphite the acetaldehyde was fixed in the form of its addition compound



and was not reduced to alcohol. The "hydrogen of fermentation," instead of reducing the acetaldehyde to alcohol, was used up in producing more glycerol from methyl-glyoxal. The quantity of aldehyde thus fixed and the corresponding yield of glycerol amounted in each case to 70 per cent. of the quantities which might conceivably be formed according to the above equations. This process was developed industrially during the war by W. Connstein and K. Lüdecke²⁵ and eventually the monthly output of glycerol amounted to 1000 tons.

It would appear that many alkaline salts such as sodium carbonate, bicarbonate, phosphate, etc., can be used in place of sulphite, but the main products of the fermentation are then glycerol and alcohol, together with some acetic acid. Addition of alkaline sulphite increases the yield of aldehyde at the expense of the alcohol. The practical yield under the conditions adopted in Germany is stated to have been 20 parts of purified glycerine, 27 parts of alcohol and 3 parts of aldehyde from 100 parts of sugar.²⁶

Later Developments.—Neuberg²⁷ has recently developed his theory in the light of the results obtained from fermentations carried out in presence of alkalis and alkaline sulphites. He assumes that yeast is normally able to effect three forms of fermentation, all of which occur simultaneously in a fermenting liquid, but that the relative predominance of each form is determined by the conditions under which the fermentation is conducted.

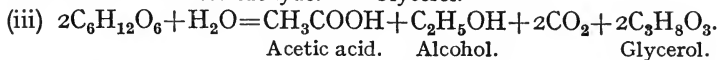
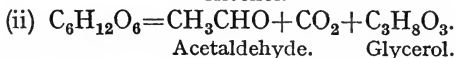
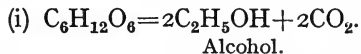

Pyruvic acid is an intermediate product in all these reactions, and from it aldehyde is produced by decarboxylation. In acid solutions the greater part of the aldehyde is reduced to alcohol. In presence of alkaline sulphites the aldehyde is fixed and the second form of fermentation becomes the main reaction. If sodium carbonate or other alkalis are substituted for sodium sulphite the aldehyde is not fixed, but two molecules of aldehyde react with one molecule of water to form acetic acid and alcohol, in a manner analogous to the reaction which was assumed above to occur between acetaldehyde and methyl-glyoxal.

It is evident that the formation of pyruvic acid from sugar involves the removal of hydrogen, and in order that this reaction may proceed unchanged, some substance must be present which can act as an "acceptor" for hydrogen. In a normal fermentation, acetaldehyde appears to be the hydrogen acceptor, and is reduced to alcohol. If the aldehyde be fixed with sodium sulphite, it would seem, according to Neuberg, that methyl-glyoxal becomes the hydrogen acceptor, and is reduced to glycerol. The induction period, or delay in the commencement of fermentation which is always apparent when yeast juice is added to a sugar solution, appears to be due to the fact that the amount of aldehyde initially present is not sufficient to promote the formation of pyruvic acid from methyl-glyoxal at the normal rate. If acetaldehyde or pyruvic acid are added to the yeast juice the fermentation is accelerated. Other substances, such as methylene-blue, which are easily reducible by yeast, show the same activating effect.²⁸ The presence of a sufficiency of potassium or ammonium phosphates is essential before the activating effect of acetaldehyde can be exercised. If dried yeast or "zymin" (yeast in which the reproductive functions have been destroyed by extraction with acetone) be inactivated by thorough washing with water, it can be reactivated by the addition of a pyruvate or acetaldehyde provided potassium phosphate is also present.²⁹ It would seem that the "co-ferment" of Harden and Young may be acetaldehyde or pyruvic acid, and possibly that many other substances capable of "accepting" hydrogen and being thereby reduced, may act in the same way.³⁰

Gowland Hopkins³¹ has recently isolated from yeast and from animal tissues a dipeptide yielding on hydrolysis cysteine $\text{CH}_2(\text{SH})\text{CH}(\text{NH}_2)\cdot\text{COOH}$ and glutamic acid



in which the —SH group is readily oxidised with the formation of a compound containing an —S—S— linking. The latter substance can be as readily reduced to the original dipeptide



Both the oxidation and reduction can be influenced by factors shown to be present in the tissues themselves. It is possible that this substance, or one closely allied to it, may play an important part in alcoholic fermentation.

Ehrlich's Work: Formation of Fusel Oil.—In fermentation as carried out in distilleries, there is always formed a small quantity of "fusel oil" amounting to 0.1 to 0.7 per cent. of the alcohol produced. Fusel oil consists essentially of a mixture of the higher

homologues of ethyl alcohol together with traces of fatty acids, esters, furfural, and other substances. The nature and relative proportion of the higher alcohols varies somewhat with the source from which the alcohol is obtained. The fusel oil from potato and grain spirit consists chiefly of a mixture of iso-amyl alcohol $(\text{CH}_3)_2\text{CH}.\text{CH}_2.\text{CH}_2.\text{OH}$, and *d*-amyl alcohol $\text{CH}_3.\text{CH}(\text{C}_2\text{H}_5).\text{CH}_2.\text{OH}$, together with 15 to 20 per cent. of isobutyl alcohol $(\text{CH}_3)_2\text{CH}.\text{CH}_2.\text{OH}$, and 4 to 7 per cent. of normal propyl alcohol $\text{CH}_3\text{CH}_2\text{CH}_2.\text{OH}$. In the fusel oil from grape spirit the amount of propyl alcohol is somewhat higher, about 12 per cent., and some analyses show a high content of normal butyl alcohol. This is also the case with the oil obtained from beetroot alcohol. In the fusel oil from cane molasses the proportions of iso-amyl and *d*-amyl alcohol are approximately equal, while in potato and grain fusel oils iso-amyl alcohol is the chief constituent.

Ehrlich³² has shown that these alcohols are derived from the amino-acids formed by the hydrolysis of proteins. Living yeast is able to decompose amino-acids into carbon dioxide and the alcohol containing one carbon atom less, the nitrogen of the amino-acid being at the same time assimilated. Thus iso-amyl alcohol and *d*-amyl alcohol are derived from leucine and isoleucine respectively :

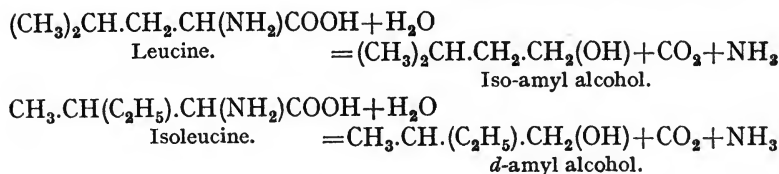

It would appear from the researches of Neubauer and Frommherz³³ that the decomposition is not quite so simple as the above reactions would indicate. A more likely explanation of the reaction is that an α -ketonic acid is produced by removal of the $-\text{NH}_2$ group and simultaneous oxidation of the amino-acid

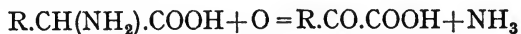

and that the α -ketonic acid then undergoes decomposition into aldehyde, and eventually alcohol, a reaction which has already been shown to occur with pyruvic acid. Some of the aldehyde may also be oxidised to the corresponding acid, which would account for the observed formation of succinic acid $\text{COOH}.\text{CH}_2.\text{CH}_2.\text{COOH}$ from glutamic acid $\text{COOH}.\text{CH}_2.\text{CH}_2.\text{CH}(\text{NH}_2).\text{COOH}$. Traces of succinic acid are nearly always present among the products of alcoholic fermentation.

The character of the fusel oil, therefore, depends largely on the

nature of the proteins present in the raw material, but is also affected by the species of yeast employed. Amino-acids are not decomposed by yeast juice, but only by living yeast, and the reaction appears to be intimately connected with the nitrogenous metabolism of the cell.

REFERENCES

- ¹ H. T. Brown, *Trans. Chem. Soc.*, 1918, **113**, 559.
- ² F. L. Usher and J. H. Priestley, *Proc. Roy. Soc.*, 1906, **78**, [B], 318.
- S. B. Schryver, *Proc. Roy. Soc.*, 1910, **82**, [B], 226.
- ³ H. Wager, *Proc. Roy. Soc.*, 1914, **87**, [B], 386.
- ⁴ C. H. Warner, *Proc. Roy. Soc.*, 1914, **87**, [B], 378.
- ⁵ B. Moore and T. A. Webster, *Proc. Roy. Soc.*, 1918, **90**, [B], 168.
- ⁶ E. C. Baly, I. M. Heilbron, and W. F. Barker, *Trans. Chem. Soc.*, 1921, **119**, 1025.
- ⁷ H. E. Armstrong, *Trans. Chem. Soc.*, 1890, **57**, 528.
- ⁸ A. R. Ling, *Brewers' Journal*, 1904, **40**, 741.
- ⁹ A. Slator, *Trans. Chem. Soc.*, 1921, **119**, 115. *Journ. Soc. Chem. Ind.*, 1919, **38**, 391R.
- ¹⁰ A. Harden, *Alcoholic Fermentation*, London, 1914.
- ¹¹ A. Harden, *Berichte*, 1903, **36**, 715.
- ¹² A. Harden and W. J. Young, *Journ. Physiol.*, 1905, **32**.
- ¹³ A. Harden, *Alcoholic Fermentation*, 1914, p. 42.
- ¹⁴ A. Harden and W. J. Young, *Proc. Roy. Soc.*, 1906, **77**, [B], 405.
- ¹⁵ F. G. Hopkins, *Chem. Soc. Ann. Reports*, 1918, xv, 164.
- ¹⁶ A. Slator and H. J. S. Sand, *Journ. Chem. Soc.*, 1910, **97**, 922.
- ¹⁷ E. F. Armstrong, *Proc. Roy. Soc.*, 1904, **73**, 516.
- ¹⁸ A. Harden and W. J. Young, *Proc. Roy. Soc.*, 1906, **78**, [B], 369.
- ¹⁹ F. G. Hopkins, *Chem. Soc. Ann. Reports*, 1918, xv, pp. 165-169.
- ²⁰ A. Fernbach, *Journ. Inst. Brewing*, 1916, **22**, 354.
- ²¹ C. Neuberg and J. Kerb, *Biochem. Zeitsch.*, 1913, **58**, 158.
- ²² E. Buchner and J. Meissenheimer, *Berichte*, 1906, **39**, 3201.
- ²³ O. E. Ashdown and J. T. Hewitt, *Trans. Chem. Soc.*, 1910, **97**, 1636.
- ²⁴ C. Neuberg and E. Reinfurth, *Biochem. Zeitsch.*, 1918, **89**, 365.
- ²⁵ W. Connstein and K. Lüdecke, *Berichte*, 1919, **52**, [B], 1385.
- ²⁶ *Journ. Soc. Chem. Ind.*, 1919, **38**, 175R, 287R.
- ²⁷ C. Neuberg and J. Hirsch, *Biochem. Zeitsch.*, 1919, **100**, 304.
- ²⁸ A. Harden and F. R. Henley, *Biochem. Journ.*, 1920, **14**, 643.
- ²⁹ A. Harden, *Biochem. Journ.*, 1917, **11**, 64.
- ³⁰ A. Harden and F. R. Henley, *loc. cit.*
- ³¹ F. Gowland Hopkins, *Biochem. Journ.*, 1921, **15**, 286.
- ³² F. Ehrlich, *Berichte*, 1907, **40**, 1027.
- ³³ O. Neubauer and K. Frommherz, *Zeitsch. Physiol. Chem.*, 1911, **70**, 326.

CHAPTER III

PRODUCTION OF ALCOHOL FROM STARCH AND SUGAR

Raw Materials.—The raw materials from which fermentation alcohol can be obtained fall into three main groups :

(i) Materials containing starch, such as cereals, potatoes, and cassava. In this group may be included artichokes, the tubers of which contain a small proportion of inulin in place of starch.

(ii) Plants and residues containing ready formed sugars. This group comprises sugar cane and sugar beet, together with the residual molasses from the manufacture of cane and beet sugar, mangolds, fruits of various kinds, and the sap of many different species of trees.

(iii) Cellulose, including wood and straw of all kinds.

The dividing lines between these groups are not sharp, since many starchy and cellulosic materials frequently contain a certain proportion of sugars which account for some of the alcohol produced.

In this country the chief raw materials used are maize, rye, barley, and oats. Much of the spirit destined for methylation is produced from molasses, on account of its relative cheapness as compared with grain. Potatoes are not used at all in Great Britain for the manufacture of alcohol. In Germany, potatoes are the main raw material, but maize and other grains and also beet molasses are extensively used in the larger distilleries. In Eastern Europe, rye and maize are used, and in France the greater part of the industrial alcohol is made from beets and beet molasses. In the United States maize is the chief raw material, and in the tropics cane molasses and other residues from cane sugar manufacture.

The average percentages of starch and sugar in the various raw materials used are given on pp. 87 to 114, and are summarised in the table on p. 115.

Among the naturally occurring carbohydrates it is only the hexose sugars, dextrose, lævulose, and mannose, that can readily be converted into alcohol by the zymase of yeast. Galactose is

met with among the products of hydrolysis of many plant tissues, but it is doubtful whether it occurs in the free state in nature. It is only fermented with difficulty, and not by all species of *Saccharomyces*. Thus *S. apiculatus*, one of the so-called "wild yeasts," will ferment dextrose but not galactose, and this affords a method of separating galactose from dextrose. The disaccharides sucrose and maltose, and the trisaccharide raffinose occurring in sugar beet are not fermentable direct, but only after hydrolysis to hexose sugars. This hydrolysis can be effected by enzymes present in yeast, so that to all intents and purposes these sugars are fermentable. Raffinose exhibits a varying degree of resistance according to whether top or bottom fermentation yeasts are employed (p. 64).

Starch cannot be hydrolysed or fermented by the *Saccharomycetes* since they do not secrete amylolytic enzymes, and it is therefore necessary to break down the starch molecule into simple carbohydrates preparatory to fermentation. This can be effected in various ways:

- (i) By the amylase (diastase) formed during the germination of barley and other grains.
- (ii) By the use of certain amylase-producing moulds, belonging to the genera *Aspergillus* and *Mucor*.
- (iii) By heating with mineral acids.

Barley Malt.—The formation of diastase during the fermentation of the barley grain has already been briefly discussed (p. 15). During germination the diastase content of the grain increases greatly and the hard starchy endosperm is gradually converted by partial hydrolysis of starch and proteins into a friable condition. If the further growth of the grain is checked when this change in the condition of the endosperm, or "modification," is complete, the resulting product is termed "malt." By virtue of its high content of diastase malt is capable of transforming a large additional quantity of starch into soluble and fermentable carbohydrates.

There are several different species of barley in cultivation, each possessing certain characteristics which determine its relative value for either brewing or distilling. The species are distinguished by the way the grains are developed on the main axis or "rachis" of the inflorescence. The rachis is divided up into short sections by a number of nodes, each of which bears three single-flowered spikelets. The spikelets springing from one node are on the opposite side to those from the next succeeding node, so that the complete inflorescence presents the appearance of having six vertical rows of flowers. In the six-rowed barley, *Hordeum hexastichum*, all three flowers on each node are fertile and the resulting

ear bears six rows of fully developed grains. In the two-rowed barleys *H. distichum* and *H. zeocritum* only the middle one of the three flower spikelets is perfect, the two lateral ones being barren. Sometimes the outer or lateral spikelets on alternate nodes of six-rowed barley overlap, and the ear presents the appearance of having only four rows instead of six (*H. vulgare*). This type is often termed four-rowed barley.

The two chief varieties of English malting barley, "Goldthorpe" and "Chevalier," belong to the two-rowed type. The former, a variety of *H. zeocritum*, is wide-eared, and the latter (*H. distichum* var. *mutans*) is narrow-eared. Six-rowed barleys are also grown in this country and abroad, and are widely used for brewing and distilling.¹

Barleys vary to some extent in size and weight of grain and in their relative content of starch and protein. The best brewing barleys are characterised by fineness of skin, well developed, starchy, and "mealy" endosperm, and low content of protein. They are usually large-grained and heavy, weighing from 54 to 56 lb. to the bushel. The brewer requires a barley which on malting will give him the highest extract. A high content of diastase is not required, in fact it may be a disadvantage, since the flavour and "body" of the resulting beer depends to a large extent on the presence of intermediate starch conversion products which remain unfermented by yeast. Moreover, brewer's malt is dried or "cured" at a comparatively high temperature, which has the effect of destroying much of the diastase and at the same time producing the distinctive flavours required. For distilling, more especially in the case of industrial alcohol, the diastase content of the malt is all-important. The distiller's object is to convert a maximum quantity of starchy material into soluble and fermentable carbohydrates, with a minimum amount of malt, the latter being the more expensive ingredient of the two. The higher the protein content of the barley, the greater, as a rule, is the quantity of diastase produced. The smaller the grains the greater the number of germinating and diastase-producing units in a given weight of the barley. In the manufacture of industrial alcohol, therefore, relatively small-grained barleys rich in protein are to be preferred to the plumper and more starchy varieties which would be selected by the brewer.

The most essential characteristic of barley destined for malting is its vitality or germinating power—that is, the percentage of grains which will germinate when placed under suitable conditions. This is usually determined experimentally on a hundred of the grains by steeping them in water for twenty-four hours,

draining off the water, and keeping them at a temperature of 10° to 12° C. until they show signs of germination. In a good sample 90 per cent. of the grains should germinate within three days, and 95 per cent. should be capable of doing so irrespective of time.

For the preparation of malt the barley after being cleaned and graded is first steeped in water at a temperature of 10° to 14° C. for fifty to seventy hours, during which time it absorbs about 50 per cent. of its weight of water. This process is analogous to that which occurs naturally in the soil as a preliminary to the sprouting of the grain. Aeration at intervals during the steeping is of advantage in promoting subsequent germination of the grains,² and for distillery malts a small proportion of calcium bisulphite or other antiseptic is often added to inhibit the growth of moulds and bacteria. The grain during steeping becomes soft, and a certain proportion of the more soluble constituents, amounting to about 1 per cent. of the total weight of grain, is dissolved out by the steep water. The barley is then spread out or "couched" on the malting floor to a depth of about 12 inches, and kept under carefully controlled conditions of temperature, ventilation, and moisture. Oxygen respiration takes place, and in consequence the temperature gradually rises. Temperature and aeration are regulated by turning over the heap on the malting floor and gradually reducing its thickness, the grain being kept sufficiently moist by occasional sprinkling with water, and the temperature not allowed to exceed 63° F. (17° C.).

About twenty-four hours after couching, the grain commences to "chit," a small protuberance showing itself at the base of the germ. This develops further into four or five short bushy rootlets. At the same time the embryo shoot or "acrosipre" moves up the back of the grain. In brewing malt, or short malt, growth is stopped by gradual loss of water and cessation of respiration when the acrosipre has grown about two-thirds up the back of the grain, the rootlets being then about one and a half times the length of the grain. This usually takes about nine or ten days on the malting floor. At this stage diastatic activity has not reached its maximum, but the starchy endosperm is completely "modified," or converted into a friable condition, which from the brewer's point of view is more important than highly developed diastatic power.

In distiller's malt, germination is allowed to proceed for about three weeks, until the acrosipre has grown right out, and the rootlets are more than twice the length of the grain. The malt thus produced is termed "long" malt, and possesses the maximum of

diastatic power.³ The development of the acrospire is not necessarily an indication of the relative diastatic activity, but is unavoidable when malting is continued for a long period. It is the aim of the maltster to suppress excessive growth as far as is consistent with the attainment of a maximum diastase content. This is largely a question of temperature. Germination proceeds most quickly at 25° C. or over, but the growth is rank and the resulting malt low in diastase. The most favourable temperature for diastase development is 15° C., the growth of the acrospire being then much slower. The use of long malt has the disadvantage that a considerable proportion of carbohydrate is lost in the process of respiration and in the development of acrospire and rootlets, but this is more than counterbalanced by the gain in diastatic activity.

Malting is now conducted extensively on the "pneumatic" system, which has the advantage of saving floor space and labour, and of rendering the process independent of variable weather conditions. The barley is introduced into a large drum which slowly revolves upon its axis, thus keeping the grain in constant movement and preventing the rootlets from interlacing and matting or felting together. A current of air previously passed through a water spray is led continuously through the drum, and the maltster is thus able to regulate the temperature and moisture of the air supply as required. Pneumatic malting is particularly suited to hot climates where difficulty would otherwise be experienced in regulating the temperature of the malting floor.

When the development of the grain has reached the desired stage, the malt is gradually dried off and the rootlets allowed to wither on the floor. The secretion of enzymes ceases, but as drying proceeds the diastase already formed continues to act upon the starch of the grains and completes the "modification" of the endosperm. At this stage the product is termed "green" malt. If destined for use in brewing or for the distillation of potable spirit the malt is further dried or "cured" on a drying kiln, at a temperature of 50° C. to 100° C. or over, according to the type of malt required. While kilning gives flavour and colour to the malt, the high temperature involves destruction of some of the diastase. Distillery malt is therefore either used in the green condition, or else cured at as low a temperature as possible. When dried in a rapid

³ The diastatic power of malt is determined by C. J. Lintner's method, in which a definite quantity of the cold water extract of the malt is allowed to act on a solution of soluble starch under standard conditions, the amount of sugar formed being estimated by means of Fehling's solution. The diastatic power of English brewing malt is usually between 20° and 40° on Lintner's scale, while that of green malt may be as high as 110° to 125°.

current of air, not above 50° C., the resulting product retains 85 per cent. of the original diastatic power of the green malt.

Other Cereal Malts.—Malt prepared from rye and other cereal grains is sometimes used in distilleries, generally mixed with barley malt. According to Maercker, rye and wheat both give malts of a diastatic power approximately equal to that of barley malt. The richer the grain in protein the higher, as a rule, will be the diastase content of the resulting malt. Rye does not require such a long steep as barley. On the malting floor rye is liable to become matted and to overheat, and is therefore best malted in admixture with an equal quantity of barley. Such mixtures are not adapted for the production of short malt owing to the difficulty of securing even germination, but for long malt this is not of great consequence.

Wheat must not be steeped too long, otherwise it is easily attacked by moulds on the malting floor. The moisture is kept up to the required point by subsequent sprinkling. Both rye and wheat, like barley, are malted at a low temperature. On the Continent, malted rye is sometimes used in distilleries without any admixture of barley malt, and in British whisky distilleries it is sometimes used in conjunction with barley malt.

The diastatic power of oat malt is only 30 per cent. of that of barley malt, but it has been stated that when used in conjunction with barley malt it often gives a better attenuation in potato and maize mashes than barley malt alone, possibly owing to the greater persistence of the diastase during fermentation. Oats can be malted at a higher temperature than barley without fear of mould infection, and a fully modified malt can be produced in five days.

Maize malt is low in diastatic power, being somewhat inferior to oats in this respect. It requires a high temperature, 20° to 30° C., for germination. As maize usually shows a high proportion of broken and damaged corns, its germinating power is often inferior, and at the high malting temperature the broken corns are a fertile source of mould infection. Maize must therefore be carefully washed prior to malting with the addition of antiseptics, such as calcium bisulphite, to the steep water. On the malting floor it requires frequent turning and sprinkling. In former years malted maize was often used in Hungarian distilleries without the addition of any unmalted grain, owing largely to the cheapness of maize as compared with barley. The loss of fermentable carbohydrates during germination was considerable, and the process appears to have given place to more modern methods of converting maize starch into a form in which it can be readily acted upon by barley malt.

Sorghum grain (great millet, Guinea corn) is stated to produce a malt rich in diastase (p. 90).

Although malts made from grain other than barley are not much used in temperate climates, they may conceivably assume some importance in connection with the production of power alcohol in the tropics. Barley, although it possesses a wide range of cultivation, is not well suited to tropical climates. Moreover, the successful malting of barley requires careful control of temperature, and a rise in temperature much beyond 65° F. during germination has a prejudicial effect on the resulting malt. Where it is necessary to use cereal malts in tropical distilleries, it would seem that materials such as maize, which is more suited to the climate and can be malted at a comparatively high temperature, may be preferable to barley as a source of diastase.

Conversion of Starch into Fermentable Sugars.—The finished malt can now be utilised for the conversion of the main bulk of starchy raw material into fermentable carbohydrates. Starch as it exists in nature is in the form of small grains which are more or less resistant to the action of amylolytic enzymes. A cold extract of barley malt is entirely without action on the grains of potato starch, but if the grains are ruptured by being ground up with sand the starch is readily attacked. The grains of cereal starches, on the other hand, are stated to be attacked in the unruptured state by malt extract.⁴

In the preparation of starchy materials for treatment with malt the starch is always gelatinised by heating, in which state it is readily hydrolysed to fermentable sugars by a malt infusion. The action of diastase upon gelatinised starch takes place in several stages. The end products are maltose $C_{12}H_{22}O_{11}$, together with some dextrose $C_6H_{12}O_6$. The intermediate products, or dextrans, are unfermentable uncrystallisable substances which exhibit a gradually decreasing specific rotation and a gradually increasing copper-reducing power, as they become further removed in composition from the original starch molecule.

Brown and Heron⁵ found that a well-defined resting stage occurred in the hydrolysis of potato starch by malt diastase, a stage at which the specific rotation or copper-reducing power of the mixed reaction products indicated that 80.9 per cent. of the original starch had been transformed into maltose and 19.1 per cent. into a dextrin, or approximately in the ratio of four parts of maltose to one of dextrin. Further hydrolysis of this "stable dextrin" took place more slowly than the main reaction. Brown and Morris⁶ further extended these investigations, and by using the cryoscopic method for the determination of the molecular weight of the stable

dextrin obtained indications which pointed to its possessing the formula $(C_{12}H_{20}O_{10})_{20}$. They looked upon starch as being made up of five of these complexes, one of the five corresponding to the stable dextrin, while the other four, termed "amylin" groups, were capable of progressive hydrolysis by diastase to maltodextrins and eventually to maltose.

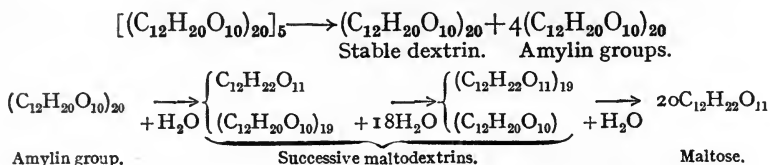

The stable dextrin on being further hydrolysed by malt diastase is eventually broken down into approximately equal parts of dextrose and maltose. This, together with the fact that it shows a definite though small copper-reducing power, led Brown and Millar⁷ to suggest that this dextrin is built up, at any rate partially, of dextrose units condensed together with loss of water. They assigned to it the formula

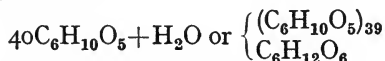

The constitution of the starch molecule is in all probability somewhat more complicated than the above equations indicate. A. R. Ling and B. F. Davis⁸ have shown that several of the maltodextrins when isolated and subjected to the prolonged action of diastase yield small quantities of dextrose, the diastase used being incapable of converting maltose itself into dextrose. J. L. Baker and H. F. E. Hulton⁹ by acting upon ungelatinised barley starch with a purified preparation of diastase were able to isolate two dextrins, one possessing a high molecular weight and the other a molecular weight approximately equal to that of maltose, together with crystalline maltose, and they further obtained evidence of the production of dextrose in small amount.

Malt diastase appears to consist of more than one specific enzyme, as evidenced by the varying power possessed by different malts of liquefying starch paste and of saccharifying soluble starch. The diastase existing in ungerminated barley possesses a comparatively low liquefying power, but is able rapidly to saccharify soluble starch. Green malt shows high liquefying and saccharifying power, but the latter property is affected by heat to a much greater extent than the liquefying power, so that highly cured malts are often better able to liquefy starch than to convert it subsequently into fermentable sugars.

Mashing : British and Continental Practice.—The mashing process as carried out in most distilleries involves two distinct operations : firstly, the gelatinisation and liquefaction of the starch, and secondly, the saccharification by malt of the thick mash thus prepared. The resulting saccharine liquid, when separated from the "spent grains," is termed "wort."

Many different methods are adopted for the preparation of the mash from starchy materials and for obtaining the wort in a condition suitable for fermentation by yeast. In some cases the saccharified mash is fermented direct and in others the wort is separated from the grains before fermentation. As a general rule, patent still distilleries in this country work on a system which involves the fermentation of weak clear worts of specific gravity 1·030 to 1·040, or occasionally up to 1·060.¹⁰ Many of them produce pressed yeast commercially in addition to alcohol, the latter being regarded more or less in the light of a by-product. Continental pressed yeast distilleries also work on the same system, although in the so-called "Vienna" process for yeast recovery the mash is more concentrated and is fermented whole, without separation from the grains (p. 52).

Most of the German agricultural distilleries work with concentrated mashes of specific gravity 1·110 to 1·120 without complete separation of the wort from the grains. The main reason for this is to be found in the method of assessing the duty payable on spirits, which was in force in that country prior to the year 1909. In the agricultural distilleries a tax was levied on the actual capacity of the fermenting vat, irrespective of the quantity of alcohol which could be obtained in the fermentation (p. 93). It was therefore greatly to the advantage of the distiller to prepare as thick a wort as possible which would give him the utmost quantity of alcohol per unit volume. Although the methods of taxation have now been revised, many distilleries continue to use the thick mash process, owing to the value set upon the spent wash for feeding stock. The residue from the still contains the greater part of the non-fermentable constituents of the raw material, both soluble and insoluble, in sufficiently concentrated form for use as a feeding stuff, whereas in the thin mash system it is only the grains which can be so used,

¹⁰ In Great Britain the term "pounds per barrel" is frequently used in place of specific gravity. A barrel of 36 gallons will hold 360 lb. of water, but if filled with a wort of specific gravity 1·040, the weight of the contents will be $360 \times 1·040$, or 374·4 lb. The difference between 374·4 and 360, *i.e.* 14·4, is termed "pounds of extract per barrel." Similarly, if one quarter of malt (8 bushels of 40 to 44 lb. each) will produce on mashing six barrels of wort at a gravity of 1·040, the "extract per quarter" yielded by the malt is $6 \times 14·4$, or 86·4 lb.

and the spent wash containing all the soluble constituents must either be evaporated down or run to waste. Apart from this it does not appear that the thick mash system offers any material advantages either in yield or economy over British methods. In most other countries where the tax is levied on the finished product, comparatively dilute worts of specific gravity not higher than 1.060 to 1.070 are the rule. In the larger German "industrial" distilleries, which were not subject to the vat-capacity tax, the gravity of potato mashes, when these are used, varies from 1.074 to 1.083, and of maize mashes from 1.066 to 1.074. It is, however, undoubtedly the fact that the thick mash process, originally introduced from force of circumstances, has been directly responsible for many important developments in the technology of fermentation, owing largely to the difficulty experienced at first in securing full conversion of the starch and complete fermentation of the sugars.

Starch Conversion under Pressure.—When working with thick mashes it is necessary to effect the conversion or gelatinisation of potatoes and maize with the minimum amount of water, so as to avoid excessive dilution of the mash prior to fermentation.

The potatoes after being washed are introduced into a conical iron vessel, termed a "Henze" convertor (Fig. 3) capable of holding two or three tons, and of withstanding a pressure of several atmospheres. The convertor is furnished with steam inlets at top and bottom, a drainage cock, and a valve through which the contents can be blown off when the conversion is complete. Dry steam is introduced at the top and fills the vessel in fifteen to twenty minutes, the condensed water escaping through the drainage cock. This cock is then shut and the steam pressure allowed to rise to two atmospheres. The upper steam inlet is then closed and the lower one opened until the pressure has risen to three atmospheres, which takes about forty-five minutes from the completion of the preliminary warming-up. The contents are allowed to remain at this pressure for a further fifteen minutes before blowing off. At this stage the potatoes still retain their shape, but owing to the complete gelatinisation of the starch they are so soft that they can readily be blown out through the valve at the base of the convertor. The conical shape of the vessel ensures that the whole of the mass can be blown out completely without any of it remaining in corners or angles. The discharge cock and pipe are of small diameter (the blowing off takes forty-five to fifty minutes) and are furnished with sharp cutting edges or grids which serve to break up the mass as it is driven past them. The sudden reduction of pressure from three atmospheres to normal also assists disintegration of the

potatoes. The pulp produced contains almost as high a percentage of starch as the original raw material, *i.e.* 17 to 20 per cent. It is blown from the convertor straight into a mash tun furnished with stirring gear and attemperating coils, and is mixed with 2 to 3 per cent. of its weight of malt, previously ground up and mixed with a small quantity of water. The speed of blowing off and mixing is so regulated that the temperature of the mash tun contents does not rise above 55° C. In some cases the convertor pulp is blown off first into an overhead vat where it is stirred and cooled before entering the main mash tun.

Unground maize is a somewhat more refractory material, and does not undergo gelatinisation quite so easily. Its starch content is much higher and its moisture content lower than that of potatoes, so that water must be added in order to obtain a fluid product. Owing to the smallness of the grain, uniform distribution of steam is not so readily obtained, and special arrangement of the steam jets is required. The grain is frequently steeped beforehand in water to effect partial softening, and a small proportion of sulphuric or hydrochloric acid may be added to the water to assist in liquefaction. The addition of acid is found to result in the production of a

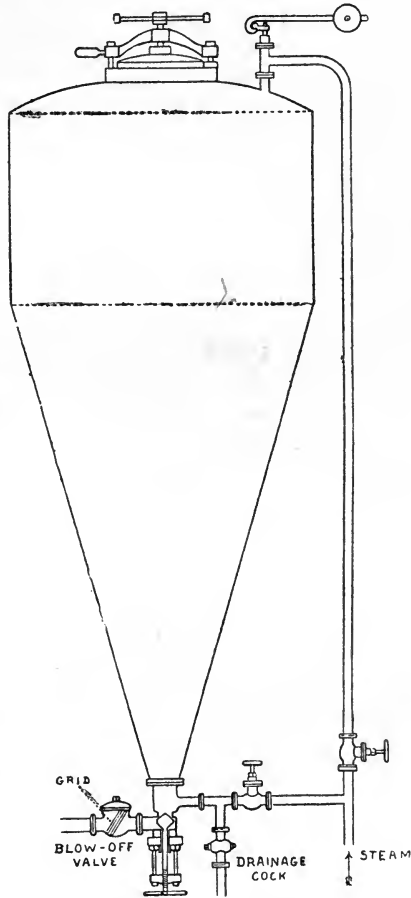

FIG. 3.—Henze Convertor.

thinner paste, possibly owing to the conversion of the alkaline carbonates of the water and the basic phosphates of the grain into sulphates and acid phosphates respectively. Maize requires for conversion a higher pressure, up to four atmospheres, and must be blown out at maximum pressure, so as to obtain the greatest possible disruptive effect on the grains.

The high pressure process as applied to unground maize possesses certain disadvantages. It requires more time and greater steam consumption than is the case with potatoes, and there is a not inconsiderable loss of fermentable material owing to caramelisation. The oil contained in the maize appears to be partially hydrolysed to fatty acids, which are liable to exert a toxic action on yeast during subsequent fermentation. Moreover, the spirit obtained is stated to be of inferior quality and the spent mash to be not so readily consumed by stock as that obtained by other conversion processes. In most distilleries, therefore, it is customary to work with ground maize, maize "grits" or flaked maize, at a lower pressure.

If ground maize is steamed direct under pressure it forms an extremely thick viscous mass which obstructs the even distribution of the steam. This can be partially overcome by the provision of stirring gear, but even then it is difficult to secure even mixing and uniform gelatinisation. It is therefore usual to add a small proportion, 1 to 1.5 per cent., of green malt emulsion to the contents of the convertor prior to steaming, so that during the preliminary warming-up period the starch of the maize may be partially liquefied and a thinner mash be obtained. During the steaming the mass is continually stirred and the steam supply so regulated that the pressure rises to three atmospheres in about one hour.

The conversion of finely ground maize is somewhat more costly than the treatment of unbroken grain. Although the steam consumption in the convertor is less, the preliminary grinding of the corn and the necessity of providing powerful stirring gear involve an expenditure of power and labour which is avoided when the whole grain is treated direct. A compromise between the two methods is frequently adopted, in which the grain is roughly broken by passage through rollers which split each corn into three or four pieces. The broken grain is filled direct into the convertor, and steamed for a shorter time and at a lower pressure than when whole grain is treated.

Starch Conversion without Pressure.—In British distilleries, where more dilute mashes are the rule, the high pressure convertor is not so widely employed. The maize convertor is frequently a strong covered wooden vessel, provided with powerful stirring gear, but not designed to stand a high pressure. The maize grist is mixed in the convertor with 3 to 4.5 times its weight of water, and either sulphuric acid or green malt emulsion added.

In the acid process from 1 to 1.5 lb. of concentrated sulphuric acid is used for each hundredweight of grist, the acid being largely diluted before being run into the convertor. The temperature of the

mash is then gradually raised by the injection of live steam with continual stirring. When the starch has been completely gelatinised and the mash has become a uniform fluid, the acid is partly neutralised with finely powdered quicklime or milk of lime, and the neutralisation then completed with powdered carbonate of lime. The mash is diluted with water, cooled to 63° C., and run off into the main mash tun. The acid process has the disadvantage of producing a considerable quantity of insoluble calcium sulphate in the mash tun, and there are several modifications of the process having for their object the reduction of the amount of sulphuric acid used. Hydrochloric acid is occasionally employed, but it is more usual to effect preliminary liquefaction of the starch by the addition of an emulsion of green malt. About 2 to 4 per cent. of green malt, calculated on the weight of grist, is added to the mixture of maize grist and water in the convertor and the whole kept at 55° C. for a short time with thorough stirring. The temperature is then gradually raised to 74°–77° C., when a reduced quantity of acid is added and the process completed by further injection of steam. Sometimes acid is added at the commencement (about $\frac{1}{2}$ lb. of sulphuric to 1 cwt. of grist), and the green malt at a later stage after neutralisation and cooling, or the use of acid may be entirely dispensed with, and a larger proportion of malt employed.

When rice is used, it is converted in much the same way as maize.

Saccharification.—The converted grain has now to be saccharified by mashing with a larger quantity of malt. In British distilleries the following is one of the processes commonly adopted: The main quantity of malt, varying from 10 to 25 per cent. of the total material, is mixed with water in the mash tun, sometimes together with a proportion of grist prepared from other cereals, and the mixture brought to a temperature of 52° to 54° C., or in some cases 40° C. After thirty to forty-five minutes the maize or rice conversion is run in, and the temperature so regulated by means of the stirring gear and attemperating coils that it does not rise above 57° to 59° C. Saccharification of the starch proceeds rapidly and is complete in about 1½ hours. Hotter liquor is introduced or “underlet” near the bottom of the mash tun towards the end of the saccharification, and the temperature thereby brought up to 65°–66° C. This raising of the temperature serves to inhibit the development of bacteria while not destroying too much of the diastase. It is important that diastatic action should continue during the subsequent fermentation, so as to secure more perfect conversion of maltodextrins into fermentable sugars. In brewing, on the other hand, the wort is boiled after mashing and the diastase

destroyed, while a considerable portion of the maltodextrins still remains unhydrolysed.

After the mash has settled, the wort is drawn off, usually from the bottom of the tun, and the residual grains extracted two or three times with hotter water, the weak wort thus obtained being set aside for use in subsequent mashings. The hot liquor is generally "underlet" below the mass of grains and the whole mixed up by the stirring gear, but sometimes it is "sparged" or sprinkled on the surface. The mash tun is provided with a false bottom which facilitates the underletting and drawing off of liquor. The exhausted grains are then conveyed to draining tanks. In many distilleries, more particularly those producing yeast by the aeration process (p. 53), the grains are separated from the wort in filter presses, which effect a more complete extraction and give a clearer wort.

In continental distilleries, working on the thick mash system, the saccharification of the concentrated potato or maize mashes is carried out on much the same principles, but instead of running off the wort and subsequently washing the residual grains with hot liquor, the whole mash is fermented after removal of as much of the solid matter as possible by mechanical means. This is done either by passing the saccharified mash through a centrifuge or by means of a helical screw conveyor working inside a perforated casing. It is found that fermentation in concentrated worts is assisted by the presence of a certain amount of solid matter, but that if this is present in excess the free escape of carbon dioxide is interfered with, resulting in too great an increase in volume in the fermenting vat. In the days of the mash capacity tax the German distiller endeavoured to reduce to the lowest possible limits that portion of the vat, the so-called "Steigraum," which must be left unfilled to allow for the increase in volume during fermentation.

Saccharification without Malt.—Two processes which dispense altogether with the use of barley malt are occasionally used in continental distilleries. In one of these the raw grain after grinding is heated under two to three atmospheres pressure in a copper vessel for six to eight hours with dilute sulphuric or hydrochloric acid. The quantity of acid used is such that the liquor contains from 1 to 1.5 per cent. of sulphuric or hydrochloric acid. The starch is almost completely hydrolysed to fermentable sugars by this treatment. The resulting mash is neutralised with milk of lime and calcium carbonate, cooled, strained, and fermented with yeast. This process is analogous to the acid processes for the hydrolysis of wood waste which are dealt with in detail in Chapter V. The disadvantages of this method are, firstly, a considerable loss of fermentable sugars through caramelisation under

the combined influence of acid and high temperature, and secondly, the unsuitability of the residual grains and spent wash for use as feeding stuffs. Certain modifications of the process, however, using hydrochloric acid and heating under pressure for only half an hour, are stated to yield a press cake suitable for feeding stock, provided it is well washed in the press. The acid saccharification process was originally introduced for use in hot climates, under conditions which were unfavourable for the preparation of malt. These difficulties have been largely removed by the introduction of pneumatic malting, and the acid process has not developed to any great extent.

Another process, in which neither malt nor acid is used, is stated by Windisch and Jetter¹¹ to be used in a few small distilleries in south Germany. It consists in making use of the diastase which is present in raw unmalted rye. Rye grist is mashed alone at a temperature of 64° to 66° C. for about two hours, by which time the starch has been converted by the diastase of the grain into fermentable sugars. The mash is cooled and subjected to a slow fermentation with yeast, lasting five days. Rye appears to be the only cereal which contains sufficient diastase for the conversion of the whole of its starch into sugars without the addition of malt.

Boidin and Effront¹² have recently proposed a method whereby the preliminary liquefaction of starch is effected by bacterial enzymes. Certain species of *Bacillus mesentericus*, when cultivated in a nitrogenous medium, secrete an enzyme capable of converting starch into achroodextrin—that is, of hydrolysing it to the point at which it no longer gives a blue colour with iodine. The proportion of maltose produced is not much more than half of the quantity obtained in an ordinary diastase conversion. The enzyme secreted by the bacillus is termed “achroodextrinase.” Its optimum temperature is about 40° C., and the solution should be slightly alkaline or neutral to methyl-orange. In solutions containing 0.01 per cent. of hydrochloric acid the activity of the enzyme is completely inhibited. After liquefaction the starch can then be further saccharified by the use of a small proportion (1 to 2 per cent.) of malt, and the fermentation process carried out in the ordinary way. The advantages of this method of working are two-fold. The heating of the starchy raw material under pressure involves the use of a large quantity of fuel, which is avoided when the preliminary liquefaction is carried out by bacterial agency. Furthermore, in the cooking of grain at a high temperature a comparatively large proportion of the nitrogenous matter present is rendered soluble, in excess of that required for the nutrition of the

yeast. This soluble nitrogen, passing into the wash, reduces the value of the spent grains as a feeding stuff. Whereas the treatment of grain at a high temperature may give rise to a wort containing more than 1 gram of soluble nitrogen per litre, this is reduced in the bacterial process to 0.1-0.3 gram.^{12a}

Certain moulds, especially those belonging to the *Mucor* group, secrete amyloclastic enzymes, and are able to convert starch into fermentable sugars. This method of saccharification has been highly developed on the Continent, under the name of the "amylo" process, and is dealt with in detail in a later section (p. 53).

Fermentation.—In the fermentation of the sweet wort by yeast there are two main conditions to be observed, namely, that the yeast employed is of the right type for the purpose in view, and that the conditions as regards composition, temperature, and acidity of the wort are such as to promote the growth and fermentative activity of the yeast and to suppress the development of bacteria and other organisms.

The use of pure culture yeasts prepared according to Hansen's method has not been developed in this country to the same extent as in Germany, where the successful fermentation of thick worts requires yeasts possessing special characteristics, such as great attenuating capacity, ability to withstand high concentrations of alcohol, vigorous fermentative power without production of excessive foam, etc. Certain races of top-fermentation Froberg yeasts (Races II. and XII.) particularly suited to thick heavy worts have been developed in Germany, and operations are usually started with a pure culture at the commencement of the distilling season.

Yeast "Bub."—The yeast, whether derived from a pure culture or consisting of the ordinary pressed yeast of the distillery, is generally grown in a small quantity of a specially prepared mash or "bub" mash before being used for "pitching" the main wort. The yeast can thus be acclimatised to the particular surroundings which it will encounter in the main wort, and can be brought into a state of vigorous growth and fermentative activity under conditions which are easily controlled. A further advantage gained by the use of a yeast bub over the method sometimes adopted of pitching direct with pressed yeast is that the preliminary stage of fermentation is shortened.

The "bub" mash, which in Germany is restricted by Excise regulations to 10 per cent., and in this country to 6 per cent. of the volume of the main wort, is a concentrated malt or malt and rye mash. Such a mash contains, in a form readily assimilable by yeast, an ample supply of nitrogen, phosphorus, and potash,

which constitute the chief food requirements of the yeast plant. This mash is normally of a higher strength than the main mash, partly in order to provide an abundance of nutriment for the yeast, and partly because a high concentration of alcohol in the fermenting bub serves to inhibit the growth of bacteria. The bub mash is prepared at as high a temperature as possible (about 65° C.), consistent with the maintenance of diastatic activity, and after saccharification is heated to 75° C. in order to eliminate bacteria.

Souring of "Bub" Mash.—If the mash were cooled at this stage to 25°–30° C. and seeded with yeast, a vigorous fermentation would ensue, but there would be grave danger of infection by foreign organisms, resulting in excessive production of acids and other by-products and disturbance of the normal course of fermentation when the yeast bub is added to the main wort. Bacterial infection is one of the greatest sources of trouble in distilleries owing largely to the fact that the wort is not boiled and hopped as it is in breweries, and special methods must be adopted in order to secure a pure fermentation.

Bacteria are, as a rule, far more sensitive than yeast to the presence of acids. Lactic acid in particular, if present to the extent of 0.1 to 0.2 per cent., will almost completely inhibit the development of bacteria, while exerting a comparatively slight effect on the rate of yeast growth. In former years the method commonly adopted for souring the bub mash was to allow it to undergo a lactic acid fermentation at a comparatively high temperature, 50° C., and this method is still in use in the greater number of continental distilleries. The mash after saccharification and heating is cooled to 50° C., and inoculated with a pure culture of one of the many lactic acid-producing organisms.

B. acidificans longissimus (Lafar) or *B. Delbrücki* (Leichmann) is the organism generally used. It differs from the lactic acid organism of milk in being unable to ferment lactose. The temperature must not be allowed to fall much below 50° C. during the lactic acid fermentation, otherwise the conditions may become favourable for the development of organisms producing butyric acid, which is highly toxic to yeast. Before the introduction into distillery practice of pure cultures of the lactic acid bacillus, the bub mash was allowed to undergo a spontaneous lactic fermentation, and the simultaneous production of volatile acids, butyric and acetic, was one of the chief sources of trouble. When the acidity has reached a point corresponding to 0.5–1.0 per cent. of lactic acid, the mash is heated to 75° C. to destroy the organisms. Otherwise they would continue to develop in the main wort and the degree of acidity produced would be too great.

Bacterial Antiseptics.—The souring of the mash by lactic acid organisms is an operation requiring great care and experience. The temperature must be continually watched, and it is difficult to exclude foreign organisms from gaining access to the mash. Attempts have therefore been made to utilise, in place of lactic acid, certain antiseptics which can be added direct to the bub mash. The most useful of these is hydrofluoric acid, introduced into distillery practice by Effront. This acid is a powerful bacterial poison, and bacteria do not become acclimatised to it in the same way as they do to lactic acid. Yeasts, on the other hand, can be accustomed to tolerate a concentration of 0·1 to 0·2 per cent. HF, by successive cultivation in gradually increasing strengths of the acid. The strength of hydrofluoric acid in the bub mash is usually 0·01 per cent., and in the main wort 0·005 per cent., but the quantities used vary considerably for different conditions of working, and as much as 0·04 to 0·05 per cent. hydrofluoric acid is sometimes added to the bub mash. The use of hydrofluoric acid or ammonium fluoride at an early stage in the bub-mashing process renders it possible to prepare the mash at the optimum temperature for diastatic action (55° to 60° C.) instead of at 65° C., without danger of bacterial infection, with a consequent saving of malt. Yeast which has been acclimatised to hydrofluoric acid suffers a slight loss of reproductive capacity, but its fermentative power is correspondingly greater.

There are, however, certain disadvantages in the use of hydrofluoric acid and fluorides. Unless the yeast has been specially acclimatised to the acid, a process which takes some time, the preliminary stage of fermentation is delayed, and this involves loss of time in the operations of the distillery. This inhibiting action becomes considerable if too much hydrofluoric acid is used, and it is a difficult matter to judge the right amount of acid to be used in any particular case. If aluminium fluoride is substituted, yeast reproduction is not interfered with to the same extent, but in order to obtain with this substance a toxic effect on bacteria equivalent to that of the free acid, it must be used in from two to four times the quantity. The whole of the fluorine added eventually finds its way into the spent wash. In the thick mash process as worked in Germany the spent wash is an important cattle food, containing 8 to 10 per cent. or more of dissolved and suspended solids. Although the fate of fluorine in the body is not known with certainty, it would appear from the experiments carried out by H. Tappeiner¹³ on dogs, that it is absorbed by the bones and brings about certain changes in their structure. Maercker¹⁴ refers to swelling of the leg bones of cattle as having been ascribed to the

consumption of spent wash containing fluorides. This objection would not apply to British distilleries, where the spent wash, owing to its dilution (2 or 3 per cent. of total solids) is commonly run to waste.

Mineral acids are sometimes used in small quantities as bacterial antiseptics. Sulphuric acid is added in quantity sufficient to liberate a portion of the organic acids existing as alkaline salts in the wort. The success of this method depends on the accurate estimation of the quantity of acid to be added (0.03 to 0.1 per cent. H_2SO_4), so that no free mineral acid remains in the wort.

In recent years the technical production of pure lactic acid by fermentation of a malt wort with *B. Delbrücki* in the presence of calcium carbonate has been greatly developed,¹⁵ and it would appear that equally good results can be obtained with this acid as with the older and more troublesome method of souring by fermentation. The high price and doubtful purity of commercial lactic acid discouraged for some time its use in distilleries, but there would seem to be no reason why it should not eventually be used in preference to all other bacterial antiseptics.

Fermentation of Bub Mash.—The bub mash after souring is rapidly cooled to 28° C., seeded with yeast, and further cooled to 14°–15° C. The yeast, after a short lag phase (p. 21) commences to bud, and soon sets up a vigorous fermentation in the mash, the temperature gradually rising to 27°–30° C. The seeding of the mash with yeast must be so arranged that by the time that the main wort is ready for pitching the fermenting bub has attained the requisite condition of “ripeness,” *i.e.* that the yeast has developed the maximum degree of reproductive and fermentative energy and power of resistance. In the comparatively weak bub mashes (sp. gr. 1.055 to 1.060) prepared at pressed yeast distilleries this stage is reached in eight or nine hours after seeding, but thick mashes require to be fermented for twenty to twenty-four hours before the yeast is ripe for adding to the main wort. The rate of cell reproduction falls off considerably when the quantity of alcohol in the wort has risen to 5 per cent., but the yeast continues after this point to gain in fermentative energy and resisting power, and some pure cultures of distillery yeast will continue to ferment sugar until the alcohol concentration is as high as 18 per cent.

Fermentation of Main Wort.—The main fermentation of the wort is carried out as far as possible at the optimum temperature for yeast growth, 28° to 30° C. In British distilleries it is usual to add the yeast bub to the wort at 25° C., and to allow the temperature to rise gradually during fermentation to 33° C. Thick mashes are pitched at 17° to 21° C. and the temperature not allowed to rise

above 30° C., control being exercised by means of attemperating coils in the vat. These temperatures are considerably higher than those obtaining in brewing operations. Light beers are commonly fermented at 15° to 21° C., and stronger beers up to 24° C., the conditions being chosen with a view to securing flavour, stability, and retention of carbon dioxide. The distiller's aim is to produce a vigorous fermentation, and to promote the continued action of the diastase on the maltodextrins of the wort.

The fermentation is roughly marked by three stages. During the first stage, cell reproduction occurs, but comparatively little carbon dioxide is evolved. This is followed by the main or primary fermentation, and during this stage most of the ready formed maltose of the wort is transformed into alcohol and carbon dioxide. The last stage or secondary fermentation is marked by greatly reduced evolution of carbon dioxide and gradual hydrolysis of the maltodextrins. The latter is effected mainly by the diastase still present in the wort, but also partly by yeast enzymes. Certain top-fermentation "Frohberg" yeasts are able slowly to hydrolyse the lower maltodextrins. An organism belonging to the genus *Schizosaccharomyces* (*S. Pombe*), originally isolated from "Pombe" or Kaffir millet beer, is distinguished by its ability to hydrolyse and ferment the higher maltodextrins, and has been employed successfully in several distilleries. The optimum temperature for this organism lies higher than that of ordinary yeast (31° to 38° C.), and although it effects a higher attenuation of the wort, it has the disadvantage of producing a relatively large amount of acid.

Aeration.—The influence of oxygen upon the rate of yeast reproduction has already been referred to (p. 20). Aeration of the wort during fermentation stimulates the growth of the yeast, causing a more rapid fermentation and a heavier yeast crop, and assisting in the removal of carbon dioxide. These advantages are gained, however, at the expense of the fermentative capacity of the yeast and the yield of alcohol.

If a vigorous current of air be passed through the fermenting wort the weight of yeast obtained may be as much as 20 to 25 per cent. of that of the original mashing materials,¹⁶ but the yeast, although suitable for baking purposes, is low in protein and zymase. The loss of alcohol owing to entrainment of vapour by the air current may be considerable, amounting in some cases to as much as 14 or 15 per cent. of the total quantity. Forced aeration is therefore confined in the main to the manufacture of pressed yeast.

¹⁶ The dry weight is much less than this, since pressed yeast contains 60 to 70 per cent. of moisture, while the raw materials may not contain more than 6 to 10 per cent.

In ordinary distilling practice the wort as prepared for fermentation contains dissolved oxygen in sufficient quantity to promote a vigorous fermentation. As the fermentation proceeds, aeration and escape of carbon dioxide are assisted by mechanical rousing, which also has the effect of keeping the yeast well distributed throughout the wort and of equalising the temperature in different parts of the vat.

Acidity.—The extent to which acidity develops in the wort affords an indication of the purity of the fermentation. The acidity immediately after pitching is generally from 0·2 to 0·3 per cent. calculated as lactic acid, much of which is due to the lactic acid of the soured bub mash. The acidity of the fully fermented wash should not be greater than 0·3 to 0·4 per cent. calculated as lactic acid, indicating an increase during fermentation of 0·1 per cent. If it be much higher than this, it points to excessive development of organisms producing butyric, acetic, and other organic acids.

The duration of the fermentation process varies considerably under different conditions. Highly aerated weak worts are completely fermented in ten to thirty hours, while without aeration the time is lengthened to forty-eight hours. In the German thick mash process fermentation takes three days, or even in some cases four days.

Attenuation.—During the progress of the fermentation the specific gravity of the wort gradually falls owing to the conversion of soluble carbohydrates into alcohol. The difference between the original gravity of the wort and the lowest gravity after fermentation is called "attenuation," and the aim of the distiller is to get as high an attenuation of his fermented wort or "wash" as possible. Attenuation is expressed in degrees, thus a reduction in gravity from 1·040 to 1·035 corresponds to 5° of attenuation. A fully attenuated distillery wash shows approximately the same specific gravity as that of water, the effect of the alcohol present in reducing the gravity being compensated for by the residual non-fermentable substances in solution.

For Excise purposes, it is assumed that every 5° of attenuation should correspond to the production of 1 per cent. of proof spirit in the wash, or that 8·8° correspond to 1 per cent. of absolute alcohol. Thus a wort of original gravity 1·040 if attenuated down to the water point should contain $\frac{4\cdot0}{8\cdot8}$ or 4·55 per cent. of alcohol by volume. One of the statutory methods of assessing the duty charge is based on the degree of attenuation. As a matter of fact the attenuation charge rarely becomes the actual charge, since the yield of alcohol is about 7 per cent. greater than that calculated from the attenuation, and the duty is then assessed on

the actual quantity of spirit produced and not upon the attenuation. In this country the alcohol content of the fermented wash in patent still distilleries is usually from 3 to $4\frac{1}{2}$ per cent., but in the thick mash system it may be as high as 12 or 13 per cent. by volume calculated as absolute alcohol.

Yield of Alcohol.—The yield of alcohol calculated on the raw material falls short of the theoretical quantity by roughly 15 per cent. This is due to various causes. A certain proportion, from 6 to 10 per cent., of the carbohydrates remains unfermented, some of the sugar is used by the yeast for its development, a small proportion (2 to 3 per cent.) of glycerol and other by-products is formed, and a small amount of alcohol is lost by evaporation. The yields obtainable in practice from different raw materials vary considerably (p. 87 et seq.), but as a general rule it may be taken that under good working conditions 84 to 85 per cent. of the original starch is converted into alcohol, corresponding to a yield of about 60 gallons of absolute alcohol per 1000 lb. of starch or 134 gallons per ton.

Pressed Yeast.—Many of the patent still distilleries in this country are more concerned with the manufacture of pressed yeast than with the attainment of a high yield of alcohol. The importance of yeast as a by-product is shown by a comparison of the relative prices of alcohol and yeast during the years 1905 to 1913. During this period the price of yeast fell from 8d. to 3d. a pound, and the price of alcohol had therefore to be gradually raised from 10d. to 1s. 4d. per proof gallon. In 1912 to 1913 two-fifths of the total production of alcohol in Great Britain was accounted for by pressed yeast factories. During the war the production of yeast was greatly increased owing to the curtailment of supplies from the Continent.

Ordinary distillery yeast is generally too exhausted for use in baking, and a strong yeast possessing high reproductive energy and resisting power is required. Brewer's yeast is unsuitable for the purpose owing to its colour, its bitter hop flavour, its inferior keeping qualities, and the comparative slowness with which it ferments when mixed with flour. J. L. Baker and H. F. E. Hulton¹⁷ have suggested that unboiled distiller's wort and wheat flour both contain a yeast toxin which is absent from boiled brewer's wort. Distiller's yeast as supplied to bakers is the outcome of reproduction in a medium in which only those cells that are immune to the toxicity of the wort can survive and reproduce.

The raw materials employed in the manufacture of pressed yeast are malt and grain, usually with a high proportion of maize. Two methods are adopted, the Vienna process and the aeration process. In the former, the mash has a gravity when filtered of 1.060 to 1.080

and is fermented whole, as in the continental thick mash process. The fermentation is conducted without forced aeration, and the yeast skimmings are strained to remove the grains and allowed to settle. This process gives high yields of alcohol, but the yield of yeast is low and it is often of poor quality. In the aeration process the wort is separated from the grains, preferably in filter presses, and is collected at a gravity of 1.030 to 1.040. Air is pumped through the liquor during the whole period of fermentation, and the temperature is controlled by powerful attemperating coils. This method gives a low yield of alcohol, but the yeast crop is large (20 to 25 per cent. on the weight of the raw materials) and of good quality.¹⁸

The manufacture of pressed yeast must be looked upon as in some ways a specialised development of the distilling industry. The demand for this product is not likely to increase to any great extent, and the manufacture of power alcohol would be conducted on lines designed to give the highest possible yield of alcohol irrespective of the amount and quality of the yeast produced. Very few distilleries in this country work primarily for plain or industrial spirit, and the methods employed are those best adapted for the production either of a spirit suitable for blending with pot still whisky, or of a high yield of yeast of the quality required for baking purposes. It by no means follows that similar methods will be the most economical for the production of power alcohol. Where cost of production is the controlling factor, it is more likely that the process next to be described will eventually supersede all older methods of obtaining alcohol from starchy materials.

The Amylo Process.—One of the disadvantages of the ordinary processes of mashing and fermentation is the liability of the liquor to become contaminated with foreign organisms which decrease both the yield and quality of the alcohol obtained. The mash as it leaves the convertor is sterile, but malt is always more or less contaminated with moulds and bacteria, and cannot be sterilised by heat without destruction of the diastase. The brewer can boil his wort after saccharification and thus ensure relative freedom from bacteria during the fermentation process, but the distiller cannot do this without sacrificing the diastase upon which he depends for high attenuation at a later period. He therefore adopts the middle course of heating his saccharified mash to 65°–66° C., a temperature high enough to effect partial pasteurisation while not destroying too much of the diastase, and he further has recourse to lactic acid or other bacterial antiseptics.

In the "amylo" process the main saccharification is effected not by malt, but by certain diastase-producing moulds which can

be cultivated under aseptic conditions and which can be introduced into a sterilised mash and allowed to develop therein, without danger of infection by other organisms. This results not only in a great saving of malt but in a higher yield of alcohol and greater purity of the product. Many species of moulds, belonging to the genera *Mucor* and *Aspergillus*, are able not only to hydrolyse starch to sugar, but also to effect alcoholic fermentation of the sugar formed. These moulds were discovered in Japan and China in the ferments employed for preparing alcoholic beverages from rice.

Aspergillus oryzae is the organism contained in "koji," which consists of an approximately pure culture of the mould on moist rice. When the organism is grown on wheat bran instead of rice, the product is termed "taka-koji," and from it a very active preparation "taka-diastrase" can be prepared by precipitation with alcohol. Many attempts have been made to develop the use of *A. oryzae* for the production of industrial alcohol, but so far without success, owing apparently to the fact that the action of this organism is too energetic and leads to the destruction of a great part of the alcohol formed.

The Chinese method of fermenting rice differs from that adopted in Japan. Dough made from rice flour is formed into cakes, mixed with aromatic herbs, and the whole covered over with rice husks and allowed to undergo spontaneous fermentation at a moderate heat. A white mould grows on the cakes, which are then dried in the sun, and form the product known as "Chinese yeast." Calmette found that Chinese yeast contained a large variety of organisms, differing in number and species in different preparations, but always including a high proportion of a mould which he termed *Amylomyces Rouxii*. This mould belongs to the group of *Mucors*, and was found to possess the property of saccharifying starch and of slowly converting sugar into alcohol. The amylo process was developed by Calmette and Boidin at Seclin, near Lille, and at Antwerp, using pure cultures of *A. Rouxii*, but later on this organism was replaced by other moulds (*Mucor* β , *Mucor* γ , and *Rhizopus Delemar*), also isolated either from Japanese "koji" or Chinese yeast. These species were found to produce less acid than *A. Rouxii*, and they further possessed the advantage of being able to exert their saccharifying power in presence of a higher concentration of alcohol. Whereas with *A. Rouxii* the gravity of the mash must not exceed 1.028 to 1.032, *Mucor* β is able to saccharify mashes of 1.070 to 1.075.

In practice it is the saccharifying power of the mould of which use is made. The conversion of the sugar into alcohol takes place too slowly, so that a pure culture of yeast is added to complete

the fermentation. The main saccharification and fermentation of the mash is carried out in vertical air-tight cylinders with domed ends, of a capacity of 20,000 to 40,000 gallons or even more. The arrangement of the fittings of these fermentation vessels is shown in Fig. 4. The starch of the maize or other

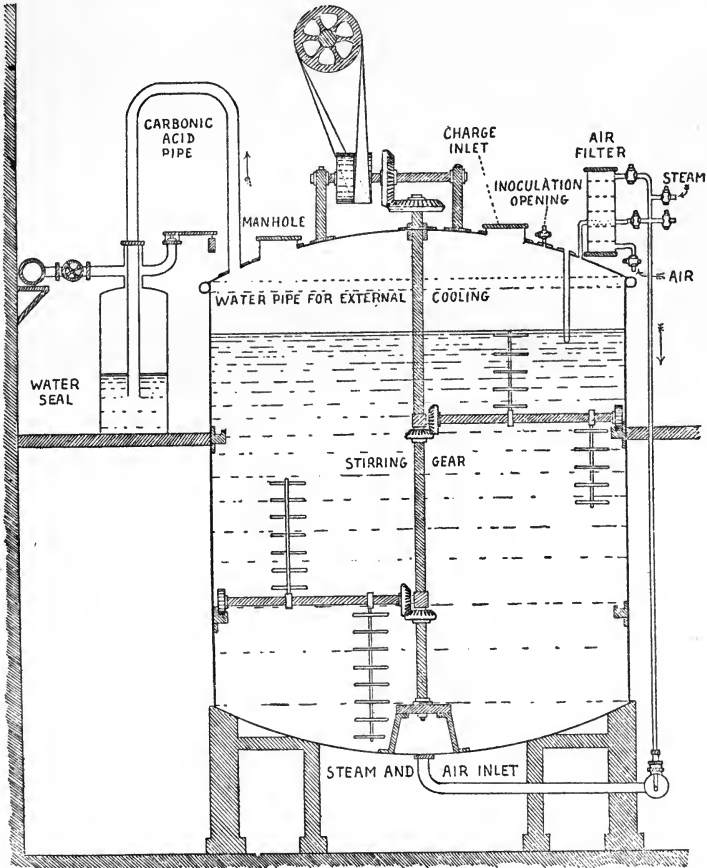

FIG. 4.—“Amylo” Process Fermentation Vessel.

grain is first gelatinised at four atmospheres pressure in a converter, substantially as already described on p. 40. In the earlier forms of the process liquefaction of the gelatinised starch was effected with 2 per cent. of green malt, but this was later superseded by hydrochloric acid in amount sufficient to convert the monohydrogen phosphates present into dihydrogen phosphates, leaving the mixture neutral to methyl-orange.

The coarsely crushed maize is agitated for one hour with two parts of water containing 0.6 to 0.8 parts concentrated hydrochloric acid per 100 parts of grain, and the whole is then gelatinised and liquefied in the convertor. The hot mash is blown from the convertor through an intermediate vessel into the fermenting vat through the charging opening. This is then closed, and the whole contents of the vat boiled for a short time, steam being passed through the air inlet and allowed to issue from the carbonic acid escape pipe and the inoculation opening. The interior of the vat, with its contents and the various connections, is thus completely sterilised. When the boiling is finished the vat is cooled by running water over the outside, filtered sterile air being blown in meanwhile. It is important that a plus pressure be maintained during the cooling, otherwise there would be danger of infected air being drawn in through possible leaks in the joints or connections of the vessel. In some systems the cooling is accelerated by stirring gear, in others the air current is relied upon to keep the contents in motion. When the temperature has fallen to 40° C. the mash is inoculated with a small quantity (about 1 gram) of the mould culture. In the earlier days of the process this culture was prepared by growing the mould upon moist sterilised rice, the spores produced being suspended in a little sterile wort and introduced direct into the vat. It was found later that in submerged cultures of the mould sections of the mycelium become detached in the form of oval yeast-like cells (*gemmæ*) which develop more rapidly than the true spores. A "bub" of the mould is therefore usually employed for inoculation of the main mash, and saccharification is thereby greatly accelerated. After inoculation the current of air is continued while the mould is developing, and after about twenty hours the whole of the mash is permeated with mould. The mash must be kept in motion by the air current, assisted if necessary by stirring gear, so as to prevent formation of a spore-forming film on the surface. This would result in an excessive production of interlaced mycelium with relatively little saccharifying or fermenting power, whereas, if the growth takes place below the surface of the liquid, the mycelium appears to assume quite a different character. If a spore culture be used for inoculating the mash, saccharification is not apparent for the first twenty hours. During the next eight hours it proceeds rapidly, and at the end of this time the yeast is added and fermentation commences.

A yeast often employed is the so-called *Saccharomyces anamensis*, isolated from a mixture of wild yeasts found on the sugar cane in Cochin-China. This yeast is particularly useful because its optimum temperature is the same as that of the

mould (35° to 38° C.), whereas ordinary yeast grows best at 28° to 30° C.

After the addition of yeast the fermentation follows the normal course, the air current being discontinued when cell reproduction is sufficiently far advanced. The carbon dioxide produced escapes through the water seal, and can be collected and compressed into cylinders. Under ordinary conditions the quantity of sugar present is at its maximum (about 11.4 per cent.) fifty-three hours after the introduction of the mould. It then falls rapidly and the fermentation is complete within four days from inoculation.

According to Delemar,¹⁹ the use of a bub of the mould permits of the yeast being added at the same time as the mould, and thus shortens considerably the time required. The bub is equal to one-tenth of the volume of the mash, and is prepared in a similar but smaller air-tight vessel.

The fermented mash is distilled in the usual manner, and the residue from the still filtered hot to remove the spent grains. The latter constitute a valuable feeding stuff, and moreover contain 20 per cent. of oil which can be recovered by extraction with petroleum spirit.

The amylo process has not been applied to any extent to the production of potato spirit. According to Henneberg,²⁰ potato mashes prepared at a high temperature contain substances which inhibit the action of the mould, but this difficulty would appear to have been overcome in recent years, and Grove²¹ states that potatoes and cassava can both be used. The process has not been introduced in this country, partly owing to the fact that it does not admit of the manufacture of yeast and partly owing to Excise restrictions. It is a statutory requirement that the gravity of distiller's wort before fermentation shall be determined by means of the prescribed saccharometer, and this is impracticable in a process in which the saccharification and fermentation of the thick and viscid starch mash proceed to a large extent concurrently in a closed vat. It would appear, however, that the Excise objections, at any rate as far as the closed vat is concerned, are partly removed by more recent developments of the process. In 1913 a new mould, *Mucor Boulard No. 5*, was discovered on plants in the Far East, and is stated to be so robust that saccharification can be carried out in open vats within a wide range of temperature.²² From a pure culture of the mould a bub is prepared about one-sixth of the volume of the main mash, in a closed vessel. The bub is then added to the main mash contained in an open wooden or iron vat. A rapidly acting yeast (yeast *Boulard Nos. 21 to 30*) is added a few hours later, and both saccharification and fermenta-

tion are complete in forty-eight hours. Foreign organisms are not able to develop to a serious extent within this period, the alcohol produced serving to keep them in check. The use of *Mucor Boulard No. 5* would appear also to remove another serious objection to the original process, namely, the length of time required as compared with ordinary fermentation methods. As originally worked, the amylo process was estimated to take some forty-eight to fifty hours longer than the usual British method.²³

Nettleton calculated in 1913 that, owing to the saving of malt, the raw materials for one gallon of 95 per cent. alcohol by the amylo process using maize would cost only 11¼d. as against 1s. 6½d. for the same amount of alcohol by the British method. The yield of alcohol is 97.5 per cent. of the theoretical, *i.e.* about 10 per cent. higher than is obtained from the ordinary process, owing to the more complete conversion of starch and dextrins and the greater purity of the fermentation. The process is well adapted for use in hot climates as the fermentation proceeds at the comparatively high temperature of 35° to 38° C. (95° to 100° F.). Large plants working on this system have been installed in several countries where Excise regulations admit of its being used.

Alcoholic Fermentation by Bacteria.—Many species of bacteria are able to ferment sugar solutions with production of a certain quantity of alcohol, but in practically every case large quantities of organic acids and other products are produced as well. Attempts have been made to utilise *Bacillus aceto-ethylicus* on an industrial scale, but so far with only moderate success.²⁴ This organism ferments dilute sugar solutions with the production of approximately 9 per cent. of acetone and 22 per cent. of alcohol calculated on the weight of the sugar. Special precautions have to be taken to prevent it from settling out as a slimy mass at the bottom of the vessel. This bacillus is stated to ferment pentose sugars as well as hexoses, with the production of a small amount of alcohol among other products.

The fermentation of pentoses has been observed with several other species of bacteria, and may eventually be of some importance in connection with the production of alcohol from sulphite pulp liquors and waste wood, both of which contain large quantities of pentose sugars.

Alcohol from Beets.—In the manufacture of alcohol from beets, as carried out chiefly in France and Austria (p. 103), the methods adopted are in many respects different from those already described for potatoes and grain. Owing to the relatively high proportion of non-fermentable solids in beet, the pulped roots cannot be conveniently fermented unless the pulp is largely diluted.

During the war beets were treated in German agricultural distilleries in much the same way as potatoes (p. 40), but difficulties were met with in dealing with the thick pulp produced in the Henze convertor. Filter presses were not usually available and the pulp could not be pumped from one vessel to another, nor could it be distilled after fermentation in continuous stills, as it was liable to clog the plates. Too great a dilution, on the other hand, rendered the spent mash too watery for use as a feeding stuff.

The methods used in France all depend upon the separation of the clear juice from the pulp in as concentrated a form as possible. Three processes, pressing, maceration, and diffusion, have at various times been adopted for the extraction of the juice. They have been developed primarily from the standpoint of the beet-sugar manufacturer, and have been adapted with the necessary modifications to the requirements of the distillery.

Pressing.—The oldest method is extraction by simple pressing, a process still used in a few small agricultural distilleries. The pulped beet is passed between two powerful hollow steel rollers rotating in opposite directions (the Dujardin press). The juice is squeezed out and passes away through a number of small perforations in the roller surface, while the residue, containing 22 to 23 per cent. of dry matter, is removed from the roller by a scraper. The advantage of the Dujardin press from the point of view of the small agricultural distiller is that the residue, without further treatment, constitutes a valuable feeding stuff capable of being stored without deterioration. The yield of sugar on the first pressing is comparatively low, but may be raised by mixing the residue with a small quantity of water and passing it through a second press.

Maceration.—In the maceration process the beets are rasped or pulped and placed in open wooden vats each holding about 2 tons, where they are systematically extracted with hot water. The fresh pulp is first extracted with the strong liquor from previous extractions. This liquor is then drawn off, and the partially exhausted pulp stirred up with weaker liquor. This liquor in its turn flows to another vat containing fresh pulp, and the residue is again extracted with still weaker liquor. Eventually the pulp arrives at a stage at which the remaining sugar can only be extracted with fresh water. The pulp thus passes through a series of progressively weaker liquors, and the solution becomes continually richer in sugar until it leaves the final vat.

The liquor obtained by the maceration process is not so concentrated as that given by the Dujardin press. It amounts to about 130 to 140 per cent. of the weight of the beets, so that from beets containing 15 per cent. of sucrose the concentration of sugar in the

liquor is not more than 10 to 11 per cent. The residue amounts to about 70 per cent. of the weight of the beets and contains nearly 90 per cent. of water. It is mixed with chaff and bran or other dry fodder, and allowed to ferment for twenty-four hours. In this state it can be kept without deterioration for several months and is a valuable feeding stuff. The disadvantage of the maceration process from the sugar manufacturer's standpoint lies in the difficulty of obtaining the juice free from fibre, and in the relatively large proportion of non-sugars dissolved out from the broken cells of the pulp.

Diffusion.—In the diffusion process the beets are cut into thin slices and progressively extracted with water in a series of vertical cylindrical vessels, constituting the diffusion battery. Each vessel is about 5 feet in diameter and of a capacity of about 2000 gallons. It is connected with a heater and is furnished with inlet and outlet for juice and water. The system of extraction is the same as in the maceration process, fresh water entering the top of the first vessel, containing the most nearly exhausted chips, and passing from this to the top of the second vessel until it eventually arrives as strong liquor at the last vessel containing the fresh chips. It then flows away as raw diffusion juice from the bottom of this vessel. The temperature of the liquor is regulated by the heater, and varies in the different vessels of the battery according to the nature of the beets under treatment. The usual temperature of extraction is 75° to 80° C., resulting in a modification of the cell walls so that they become permeable to the simpler constituents of the juice including sucrose, while retaining the more viscous and pectin-like substances. The diffusion juice contains about 97 per cent. of the total sugar of the beets, and is approximately of the same strength as that obtained by maceration, but the proportion of non-sugars is much less than in maceration juice.

Champonnois' Process.—In the application of these processes to the distillery the most important modification is that introduced in the middle of the last century by Champonnois, namely, the use of the hot spent wash from the still instead of water for the extraction of the chips. This process effects a great saving of fuel and ensures the eventual fermentation of any sugar which has remained unfermented in the wash. More important still, the yeast residues and nitrogenous substances in the spent wash constitute a valuable yeast food during the subsequent fermentation of the juice. The spent wash cannot, however, be used indefinitely, otherwise there would be too great an accumulation of toxic fermentation products and salts. It must be diluted from time to time with a certain proportion of fresh water.

A further modification is the addition of 0·1 to 0·2 per cent. of

sulphuric acid to the beet chips before extraction. Beet pulp is liable to undergo bacterial fermentation due largely to the development of an organism known as *Leuconostoc mesenteroides* and resulting in the production of a slimy and "ropy" mass. A small amount of free sulphuric acid constitutes an effective bacterial antiseptic, and it is noteworthy that while the presence of more than a trace of free mineral acid is inadmissible in the fermentation of starchy materials, it is indispensable in the fermentation of beet juice.

A number of the smaller distilleries in France employ the maceration process with beet chips instead of pulp. The method is essentially the same as the diffusion process used in the larger distilleries, but with open vats instead of closed diffusion batteries.

Continuous Fermentation.—In large distilleries the method of continuous fermentation is practised. This can be carried out in three different ways (Fig. 5). In the overflow method a number of fermentation vats are arranged in series so that the overflow from each can be led to the bottom of the next succeeding one in the series. A small quantity of wort, usually at a gravity of 1.035 to 1.040, is first introduced into vat A, pitched with yeast and brought into a state of vigorous fermentation. Fresh wort is then slowly introduced at the bottom until the vat is full. When this happens, the fermenting wort is allowed to overflow into vat B, and so on until vats C and D are also full. The incoming stream of fresh wort is then shut off from A and transferred to B, A being left until secondary fermentation has subsided. The fully fermented wash is pumped up to the wash charger of the still, the vat is cleaned out, and it is then ready to receive the overflow from the last vat of the series. The wort feed is in turn shut off from B and transferred to C and so on, each vat in succession being left to undergo secondary fermentation. The disadvantage of this method of working is that the wort is fed only into one vat at a time. The interval of time between the filling of vat C and the introduction into it of fresh wort is so great that the main fermentation in C has already largely subsided when it starts to receive fresh wort.

In the second method the vats are connected by wide pipes so that part of the contents of one vat can be distributed among the others in the space of a few minutes. When vat A is in full fermentation the connection to one or more of the other vats is opened, and they are in consequence partially filled with the fermenting wort in a short time, while vat A becomes partially emptied. Fresh wort is then introduced simultaneously into all of them. When they are full, vat A is cut off and left to undergo secondary fermentation, while part of the contents of the other

vat or vats is allowed to flow rapidly into another empty vat. This vat then joins the others in receiving fresh wort. When fermentation in A is complete, the contents are sent to the wash charger and the empty vat receives its share of fermenting wort

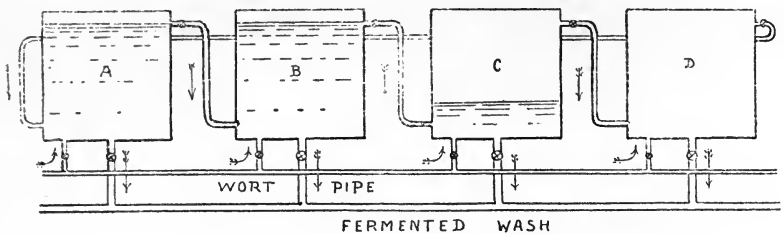

2

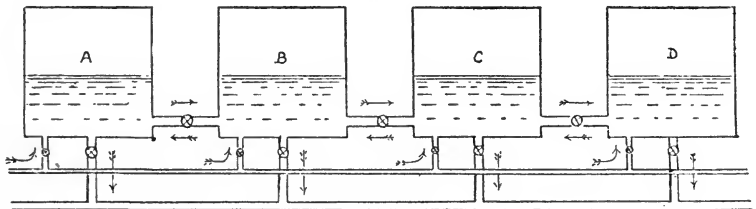

3

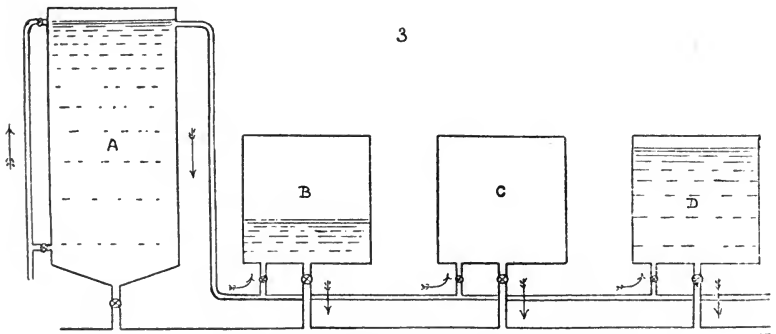

FIG. 5.—Continuous Fermentation.

from the others in the series. In this process, therefore, all the vats except those shut off for secondary fermentation contain wort in the same stage of fermentation, and they are all continually receiving a feed of fresh wort. This method of procedure is termed in Germany "verschneiden" and in France "coupage" of the vats.

The third system, introduced by Guillaume, consists in carrying out the main fermentation continuously in one large vat only (A). This vat is provided with an overflow leading to a number of smaller vessels (B, C, and D) in which the secondary fermentation takes place. The large vat is continually fed with fresh wort and is continually overflowing into one or other of the smaller vats, the number of which is sufficient to allow of one being always empty and ready to receive the overflow. The gravity of the wort in the main vat remains unaltered, the rate of flow being so adjusted that the attenuation is compensated for by the higher gravity of the incoming liquor. The vat must also, of course, be of such a size that the rate of flow through it, while maintaining constant gravity, is exactly equal to the demands of the still. The advantage of this method lies in the relative ease with which fermentation conditions are controlled and bacterial infection avoided by working with a large volume of wort in one vat. In practice a second main vat is usually installed to provide against accidental disturbances in the course of the fermentation.

The use of pure culture yeasts grown in a separate bub mash has not been developed to any great extent in French beet distilleries. The worts are dilute, and there is usually no difficulty in securing complete attenuation in a short time with an ordinary pitching of pressed yeast. The use of sulphuric acid and occasionally fluorides, colophony, or other bacterial antiseptics is relied upon as a means of securing a pure fermentation.

Fermentation of Molasses.—Molasses is the residue remaining in the manufacture of sucrose from sugar cane and beet juice, and contains about 50 per cent. of sucrose which cannot be further extracted by simple crystallisation (p. 108).

Cane molasses is largely used in the West Indies for the production of rum, being allowed to undergo a more or less impure fermentation, in which several varieties of wild yeasts are concerned. Kayser²⁵ and others have investigated some of these organisms, and have identified several species of *Saccharomyces*, mainly bottom fermentation and "film" yeasts, together with fission yeasts, or *Schizo-saccharomycetes*. They show wide variations in the degree of attenuation produced and in their capacity for forming higher alcohols and other secondary products to which the flavour and aroma of rum are due.

Magne²⁶ and also Peck and Deerr²⁷ have drawn attention to the great increase in yield of alcohol obtained when pressed yeast or pure cultures are substituted for wild yeasts, and when the fermentation is carried out in the presence of bacterial antiseptics. Galle²⁸ states that the most suitable bacterial antiseptic is hydro-

fluoric acid, and that in Austrian distilleries the best results are obtained with a yeast which has been acclimatised to this acid.

Some molasses, notably the residues from beet molasses treated by the strontia process for sugar recovery, contain considerable quantities of the trisaccharide raffinose. This sugar on hydrolysis yields lævulose and melebiose, the latter on further hydrolysis giving dextrose and galactose. Raffinose is completely fermented by bottom-fermentation yeasts. Top-fermentation yeasts are able to ferment it only to the extent of one-third, corresponding to the lævulose component. In many molasses distilleries bottom-fermentation beer yeasts are used successfully, with the additional advantage that the hop resins present act to some extent as bacterial antiseptics.

By cultivating certain types of yeast in molasses solutions of continually increasing strength, it has been found possible so to acclimatise the yeast that it will ferment liquors of gravities 1.125 to 1.130.²⁹ This corresponds to a sugar concentration of 20 to 22 per cent., the high gravity being due partly to the relatively large proportion of non-sugars in solution. For the same reason it is not possible to ferment molasses washes down to the "water-point." The gravity of the wort as set for fermentation in continental distilleries is usually 1.090 to 1.100. In this country molasses worts are usually fermented at gravities of 1.030 to 1.040.³⁰

Owing to the use of lime for "defecation" which forms part of the process of sugar manufacture, molasses is always alkaline and contains varying amounts of sodium and potassium carbonates. These are neutralised with sulphuric or hydrochloric acid before fermentation, the quantity of acid added being so adjusted by titration that the wort contains about 0.1 per cent. of free sulphuric acid. It is found that in most cases the presence of free mineral acid is necessary to suppress bacterial action and secure a pure fermentation. In some types of molasses fermentation proceeds with great difficulty unless the liquor is boiled for some time after acidification with sulphuric acid. This appears to be due to the development of bacteria from spores originally present in the molasses.³¹ During fermentation they produce volatile fatty acids, and in some cases nitrous acid by reduction of nitrates, all of which are highly toxic to yeast.

The sucrose contained in molasses is not directly fermentable by yeast, but only after "inversion," or hydrolysis to a mixture of dextrose and lævulose. Inversion is gradually effected by the invertase of the yeast itself during fermentation, but the period required for fermentation is shortened if the sucrose is inverted beforehand. This can be done either by heating with mineral acids

and subsequent neutralisation, or by treating the diluted molasses with pressed yeast at a temperature of 50° C. for four or five hours.

The methods outlined above for the treatment of such diverse materials as potatoes, grain, beetroots, and molasses are applicable in their essential details to all materials containing starch and sugar. The yield of alcohol under the best conditions of working rarely falls below 85 per cent. of the theoretical quantity calculated on the carbohydrate present, and in some cases reaches 90 per cent. The hydrolysis of cellulose to fermentable sugars is a more difficult matter and special methods of treatment are necessary. These are dealt with in detail in a subsequent chapter.

DISTILLATION

The fermented wash contains a comparatively small percentage of alcohol, together with the non-fermentable constituents of the mash or wort, yeast cells, and fermentation by-products. In order to obtain a spirit of higher strength and purity the wash must be distilled.

Distillation of Aqueous Alcohol.—If a mixture of alcohol and water be boiled, the proportion of alcohol to water in the vapour is always higher than it is in the liquid. The relative distribution of alcohol in vapour and liquid varies according to the alcoholic strength of the latter. The following table and Fig. 6 show the

Alcohol Content of Boiling Liquid. Per cent. by Vol.	Boiling-point of Liquid. Degrees C.	Alcohol Content of Vapour.	Ratio (<i>h</i>) of Alcohol Content of Vapour to that of Liquid.
0	100	0	0
5	95·90	35·75	7·15
10	92·60	51·00	5·10
15	90·20	61·50	4·10
20	88·30	66·20	3·30
25	86·90	67·95	2·70
30	85·56	69·26	2·40
35	84·80	70·60	2·02
40	84·08	71·95	1·80
45	83·40	73·45	1·63
50	82·82	74·95	1·50
55	82·30	76·54	1·39
60	81·70	78·17	1·30
65	81·20	79·92	1·23
70	80·80	81·85	1·17
75	80·40	84·10	1·12
80	79·92	86·49	1·08
85	79·50	89·05	1·05
90	79·12	91·80	1·02
95	78·75	95·05	1·0037
97·6	78·55	97·60	1·00

results obtained by Sorel³² for different mixtures of alcohol and water. The last column of the table gives the ratio (k) between the percentage of alcohol in the vapour and that in the liquid. From the figures given it is evident that by a process of repeated distillation and condensation it should be possible gradually to raise the alcoholic strength of the distillate until a point is reached at which the product contains 97.6, or according to more recent determinations 97.2 per cent. of alcohol by volume. A mixture of this

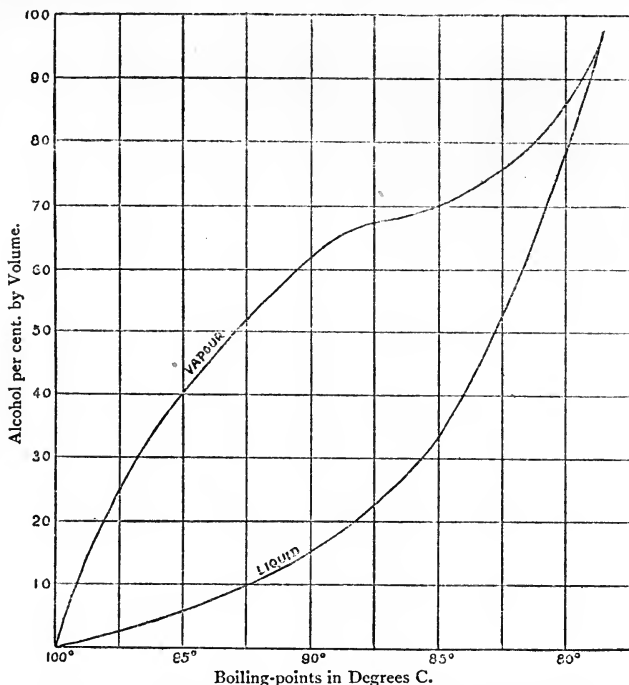

FIG. 6.—Variation in Composition of Vapour and Liquid with Boiling-points of Dilute Alcohol. (Sorel.)

strength boils at a lower temperature than absolute alcohol, and it is therefore impossible to effect a further separation by distillation alone. Absolute alcohol can be prepared only by redistilling the strong spirit thus obtained with the addition of a dehydrating agent such as calcium oxide. Repeated condensation and redistillation in a simple pot still is an operation involving considerable expenditure of fuel, time, and labour, and in the modern still these processes are so combined that a spirit of 97 per cent. strength is obtained without interrupting the distillation.

Simple Distilling Columns.—In the earliest type of still for the production of strong alcohol in one operation, the vapour from the still was made to bubble through one or more smaller vessels containing alcoholic wash. The liquor in the first of these vessels became enriched with alcohol and furnished a more concentrated alcoholic vapour to the second vessel. This in its turn became still more strongly charged with alcohol, and the vapour issuing from it was then condensed. The liquor in the two vessels was allowed to flow back continuously into the main still. In the modern

column still the principle is the same. The column contains a succession of perforated plates, upon which the vapour is partially condensed. The perforations allow of the passage of vapour upwards through the column, but are so constructed that the plates retain a certain amount of condensed liquid, through which the alcoholic vapour must pass on its way to the top of the column. In place of perforated plates, the holes of which are liable to become enlarged after a time, an arrangement similar to that shown in Fig. 7 is usually adopted. Each of the plates contains a central opening A covered by a cap B, the lower edge of which dips under the surface of the condensed liquid on the plate. Thus the vapour ascending through A must bubble through the liquid before passing on to the next plate. The height of the liquid on the plate is regulated by the overflow pipe C. As more liquid is formed by condensation, it flows down to the next lower plate and eventually finds its way back to the still. Each plate in the column can be looked upon as a small still. The vapour as it ascends becomes continually richer in alcohol and the liquid in the course of its descent to the still gradually becomes weaker. From the figures given in the table on page 65 it is evident that the separation of alcohol from water will be relatively greatest on the lowest plates where the ratio k is highest, and that

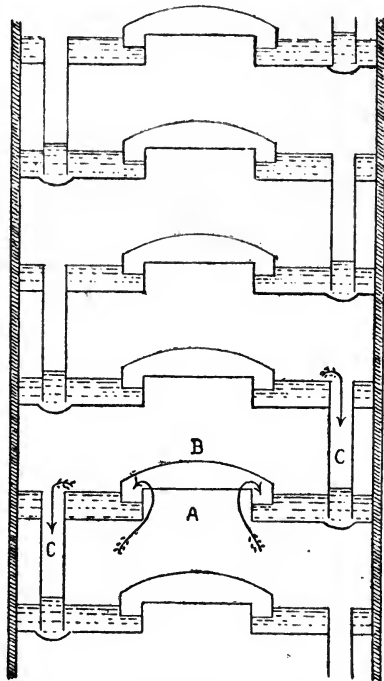

FIG. 7.—Plate Distilling Column.

in the upper part of the column, where both vapour and liquid are much richer in alcohol, the relative degree of separation on each plate will become progressively smaller. While comparatively few plates are required to produce a spirit of moderate strength, the number must be greatly increased before alcohol of a strength higher than 90 per cent. can be obtained.

In continuous distillation the alcoholic wash is introduced at a point near the top of the column, and steam is blown in at the bottom. The ascending steam carries up with it the whole of the alcohol, and the wash containing all the non-volatile constituents passes away at the bottom completely free from alcohol.

Simple distilling columns of this kind are frequently met with in the smaller agricultural distilleries on the Continent, where a crude spirit of 75 to 80 per cent. strength by volume is produced. Usually, however, spirit of a higher strength, 90 to 92 per cent., is required, and for this purpose an additional concentrating column is provided above the point of entry of the alcoholic wash.

Bohm's Still.—Fig. 8 shows a form of still (Bohm's still) which has been in use in agricultural distilleries on the Continent for many years, and which can be considered as the type from which many of the more modern forms have been developed. This still consists essentially of a distilling column A, a concentrating or rectifying column B, a preheater C, and a condenser D. The alcoholic wash enters at S and circulates through the coils of the preheater C. These coils are contained within an annular space through which passes the alcohol vapour from the still, and the wash is thereby heated while the vapour is partially condensed. From the preheater coils the wash passes to the top of the distilling column A. In its descent from plate to plate it meets with an ascending current of steam, and passes away through the spent wash regulator E completely free from alcohol. The steam may either be direct or exhaust steam according as these are available at the requisite pressure. The alcohol-laden steam passes up into the concentrating or rectifying column B, which is furnished with perforated plates and overflow pipes, and from there to the preheater. In the annular space of the preheater the vapour is exposed to the cooling influence of the wash on its way to the still and of the water with which the vessel is filled. Partial condensation occurs with consequent separation of a liquid relatively weak in alcohol, which flows back through the pipe F into the distilling column, and a vapour rich in alcohol which passes through the pipe G into the annular condenser D. Alcohol of high strength flows off continuously at H.

Ilge's Column.—When working with thick mashes the plates of a column still are liable to become choked with sediment and the

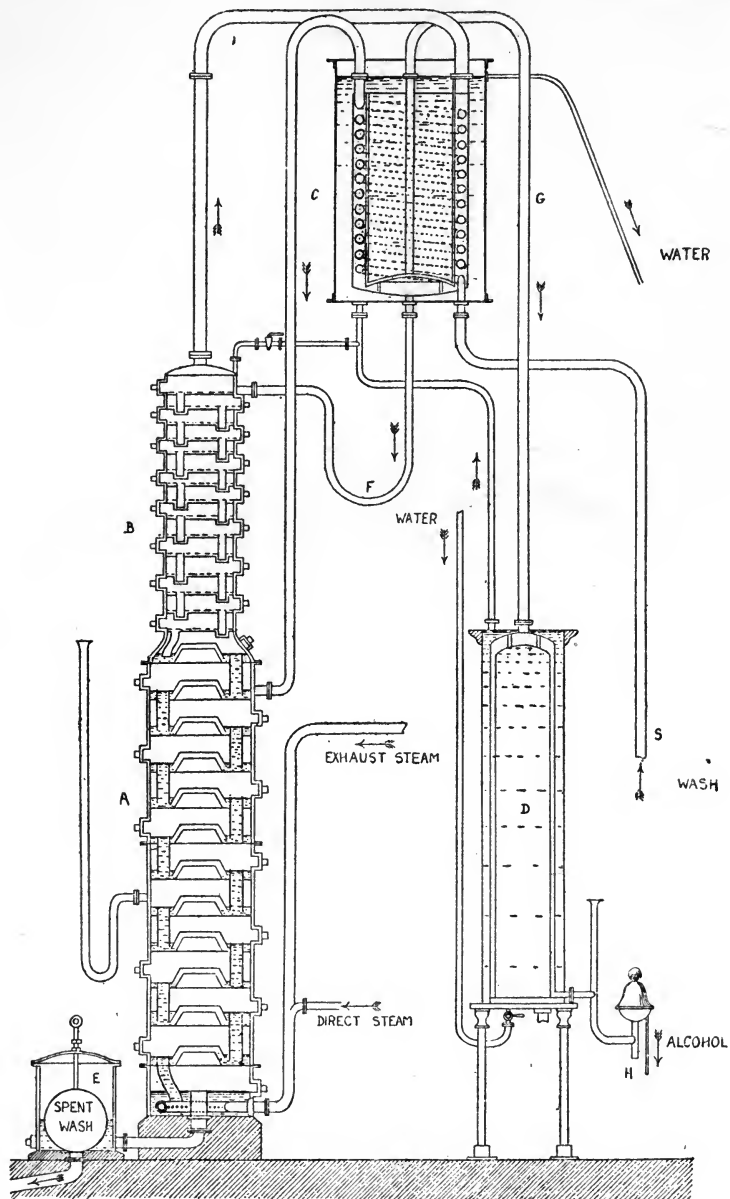

FIG. 8.—Bohm's Still.

still has frequently to be cleaned out. With a view to obviating this, special types of distilling columns have been designed for thick mashes. In Ilge's still, the whole column is filled with liquid, and steam is forced up through it from the base of the column. The column contains a series of plates of the form shown in Fig. 9. Plate A is a cone with projecting ribs arranged excentrically on its outer surface. Plate B has the form of an inverted hollow truncated cone with projecting ribs on its inner surface also arranged excentrically. The liquid, as it descends the column, is rotated first in one direction and then in the other by the ribs of succeeding

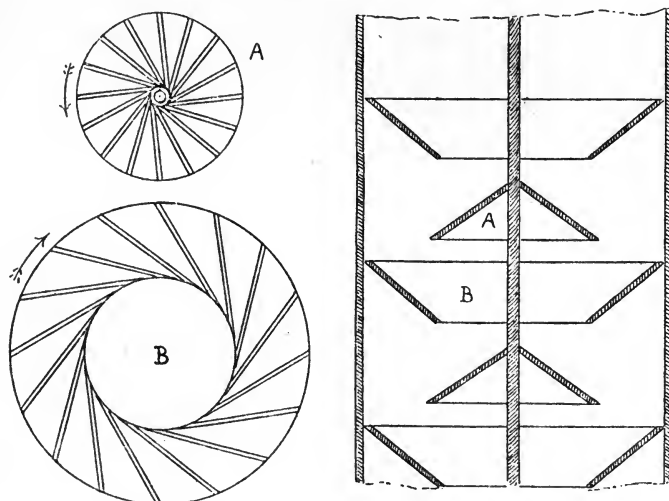

FIG. 9.—Plates of Ilge's Column for Thick Mashes.

plates, while the ascending steam is likewise deflected in the reverse direction. This results in increased agitation of the contents of the column, and liquid and steam are brought into intimate contact with each other. This type of still is built much lower than the plate type, otherwise the column of liquid would offer too great a resistance to the passage of the steam. In any case, it requires steam at a higher pressure than is the case with a plate column.

Guillaume's Sloping Column.—Guillaume's sloping column still (Fig. 10) combines the advantages of the plate column with free movement of the thick mash. It consists of two large rectangular cast-iron or copper plates, bolted to one another and inclined at an angle to the horizontal. The lower plate is fitted with ribs so arranged that the wash flows in a zigzag direction from side to

side across the whole width of the plate. The upper plate is furnished with transverse partitions, dipping into the liquid on the lower plate between the ribs. Steam is introduced at the lower

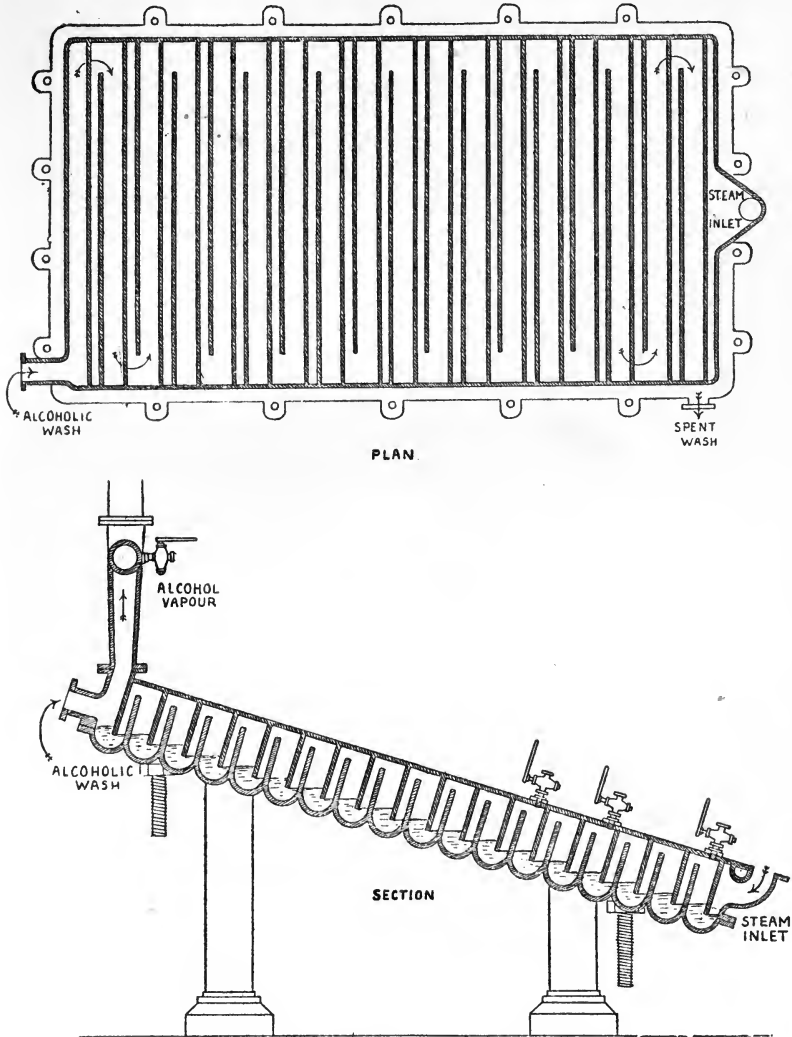

FIG. 10.—Guillaume's Sloping Column Still for Thick Mash.

end, and in passing from one partition to the next must bubble through the liquid on the lower plate.

For the purpose of cleaning, the two plates can easily be separated from each other by loosening the bolts in the flanged edge.

Rectification.—If alcohol were the only volatile constituent of the wash, the preparation of pure 97 per cent. spirit would be comparatively easy. A still of the above type with a sufficient number of plates and with one of the modern forms of “dephlegmator” in place of the preheater would be capable of giving pure 97 per cent. alcohol continuously. The matter is, however, complicated by the presence of volatile fermentation by-products consisting of acetaldehyde, esters, and higher alcohols with smaller quantities of volatile fatty acids. From these the alcohol can only be separated by a process of fractional distillation or “rectification.” The volatile by-products of fermentation vary greatly in boiling-point, from acetaldehyde (B.Pt. 21° C.) to amyl alcohol (B.Pt. 131° C.), and fatty acid esters of amyl alcohol boiling at still higher temperatures.

When a weak alcoholic wash is distilled, the volatile by-products are carried over with the steam and appear together with the alcohol in the distillate. When crude spirit of high strength is distilled, only those bodies of relatively low boiling-point pass over with the alcohol, while the higher boiling constituents, the so-called “fusel oil,” remain for the most part in the liquid.

In the pot still, which is widely used for the production of potable spirits, a comparatively crude fractional distillation is effected. The first distillate, or “low wines,” being produced from a weak alcoholic wash, contains all those constituents, including the higher alcohols or fusel oil, which are volatile in steam. On redistillation of the “low wines” the lower boiling constituents pass over with the first runnings (“foreshots”), the next fraction is the clean spirit, and the last runnings or “feints” contain the amyl alcohol and allied bodies of high boiling-point. The foreshots and feints are redistilled with the succeeding charge of low wines, and the first and last runnings again collected separately. It is generally undesirable, in the case of a potable spirit, to effect a more perfect separation of the volatile secondary constituents upon which the character and flavour of the product depend. Moreover, there is no object in producing an alcohol of higher strength than 80 to 85 per cent. by volume, as it has in any case to be largely diluted before consumption.

Values of k for Secondary Constituents.—When a crude spirit is rectified continuously in a column still with a large number of plates, a curious phenomenon is observed. At the top of the column pure spirit of approximately 96 to 97 per cent. strength collects on the plates, while the more volatile constituents pass on and are condensed separately. At the base of the column the spent wash runs off completely free from both alcohol and fusel oil. The

fusel oil tends to collect at a point in the column where the alcohol on the plates is of 40 to 45 per cent. strength by volume. Both above and below this point the ratio of fusel oil to alcohol is lower, and the alcohol, apart from its water content, is purer.

It is evident that in a strongly alcoholic solution fusel oil is less volatile than ethyl alcohol, while in a more aqueous solution ethyl alcohol is the less volatile of the two. At an alcoholic strength of 40 to 45 per cent. by volume amyl alcohol and ethyl alcohol

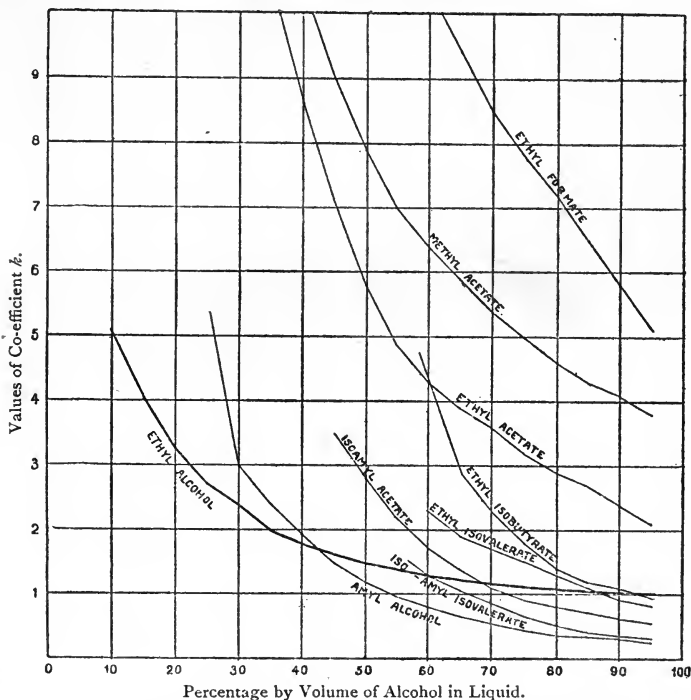

FIG. 11.—Values of Coefficient k for Alcohol and Secondary Products.

volatilise in the same proportions as those in which they exist in the liquid—that is to say, the values of k at this point for both amyl alcohol and ethyl alcohol are the same. In alcohol of a higher strength the value of k for amyl alcohol, or the ratio between its concentration in the vapour and the liquid respectively, must be smaller than for ethyl alcohol, and at low alcoholic strengths the reverse must be the case. Sorel has investigated the values of k for a number of different substances in solutions of varying alcoholic strengths. His results are given in the following table, and in the form of curves (Guillaume ; Barbet) in Fig. 11.

SOREL'S VALUES FOR COEFFICIENT k .

Alcohol per cent. by Volume in Boiling Liquid.	Values of k for Different Substances.										Values of k for Ethyl Alcohol, B.Pt. 78°.
	Fermentation Amyl Alcohol, B.Pt. 132°.	Ethyl Formate, B.Pt. 54.3°.	Methyl Acetate, B.Pt. 56°.	Ethyl Acetate, B.Pt. 77.1°.	Ethyl Isobutyrate, B.Pt. 110.1°.	Ethyl Isovalerate, B.Pt. 134.3°.	Iso-amyl Acetate, B.Pt. 137°.	Iso-amyl Isovalerate, B.Pt. 196°.			
95	0.23	5.1	3.8	2.1	0.95	0.8	0.55	0.30	1.0037		
90	0.30	5.8	4.1	2.4	1.1	0.9	0.6	0.35	1.02		
85	0.32	6.5	4.3	2.7	1.2	1.1	0.7	0.40	1.05		
80	0.34	7.2	4.6	2.9	1.4	1.3	0.8	0.50	1.08		
75	0.44	7.8	5.0	3.2	1.8	1.5	0.9	0.65	1.12		
70	0.54	8.5	5.4	3.6	2.3	1.7	1.1	0.82	1.17		
65	0.65	9.4	5.9	3.9	2.9	1.9	1.4	1.05	1.23		
60	0.80	10.4	6.4	4.3	4.2	2.3	1.7	1.30	1.30		
55	0.98	12.0	7.0	4.9	2.2	..	1.39		
50	1.20	..	7.9	5.8	2.8	..	1.50		
45	1.50	..	9.0	7.1	3.5	..	1.63		
40	1.92	..	10.5	8.6	1.86		
35	2.45	..	12.5	10.5	2.02		
30	3.00	12.6	2.40		
25	5.55	15.2	2.70		
20	18.0	3.30		
15	21.5	4.10		
10	29.0	5.10		

If k represents the concentration ratio for ethyl alcohol and k^1 that for the secondary product under consideration, the expression

$$\frac{k^1}{k}$$

is termed by Barbet the "coefficient of purification." The points of intersection of the curves in Fig. 11 indicate those alcoholic strengths at which the various secondary constituents accumulate in the liquid. At these points

$$\frac{k^1}{k} = 1.$$

To take a particular case, if a crude spirit containing 30 per cent. by volume of ethyl alcohol be boiled, the vapour will contain three times as much amyl alcohol and 2.4 times as much ethyl alcohol as the liquid. The ratio

$$\frac{k^1}{k} = \frac{3}{2.4}$$

i.e. greater than unity, and the amyl alcohol tends to accumulate in the more volatile fractions, corresponding to the "foreshots" of the pot still. In a liquid containing 43 per cent. of alcohol by volume,

$$\frac{k^1}{k} = \frac{1.7}{1.7} = 1$$

and no separation of amyl alcohol from ethyl alcohol takes place. At an alcoholic strength of 70 per cent. by volume,

$$\frac{k^1}{k} = \frac{0.54}{1.17}$$

i.e. less than unity, and amyl alcohol will accumulate in the less volatile fractions, or "feints." Similarly in the case of ethyl acetate the vapour at all alcoholic concentrations will contain more ethyl acetate than the liquid, and this substance will therefore always appear in the first runnings.

The rate of distillation of different alcohols from solutions of varying strength has recently been investigated by Reilly and Hickinbottom,^{32a} whose results confirm the earlier work of Sorel.

Coffey Still.—In Bohm's still (Fig. 8), the fusel oil collects either at some point in the rectifying column or in the condensed liquid from the preheater C, and is carried down mechanically to the base of the distilling column, where it flows away with the spent wash. In the Coffey still (Fig. 12), largely used in this country, the rectifying column or "rectifier" is separate from the distilling column or "analyser," an arrangement which renders

it possible to recover both the fusel oil and the lighter boiling constituents, and at the same time greatly reduces the height of the

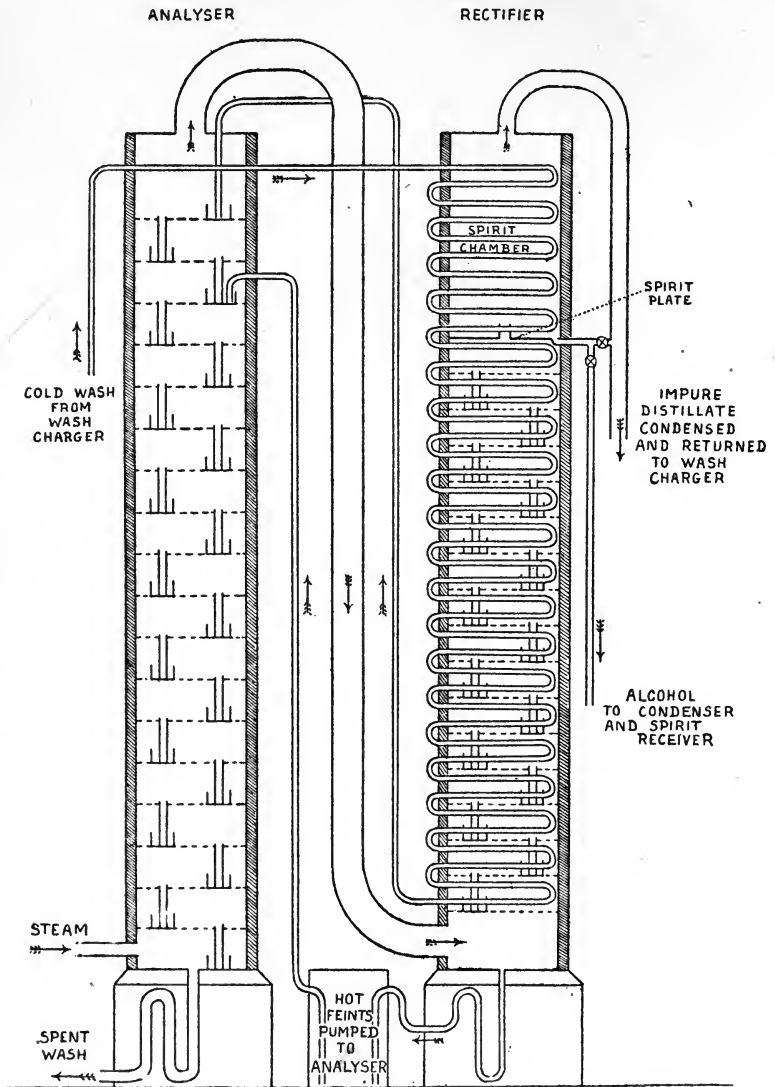

FIG. 12.—Coffey Still.

apparatus. The "analyser" is essentially the same as the distilling column of Bohm's still, except that the plates are generally perforated instead of being fitted with caps. The rectifying column

is also divided up into sections by perforated plates, and each of these sections is traversed by a pipe leading the alcoholic wash to the analyser. The rectifying column thus serves the double purpose of preheater and rectifier. The wash-pipe enters the top of the rectifier, and the wash in its downward passage becomes heated almost to boiling-point before being discharged into the top of the analyser. In the latter it flows down from plate to plate and loses the whole of its alcohol to the ascending current of steam. The spent wash, free from alcohol, flows out at the base of the analyser. The alcoholic vapours from the top of the analyser are led by a wide pipe to the base of the rectifier, and are further concentrated in their passage up through this column. The fusel oil fractions collect as "hot feints" at the base of the rectifier and flow away to the hot feints receiver, whence they are pumped up again to the top of the analyser and mixed with the wash for distillation. The hot feints receiver is provided with an oil discharge pipe, by means of which the fusel oil collecting on the surface of the liquid can be removed. The top plate in the rectifier, situated about three-quarters of the way up, is known as the "spirit plate." It is not perforated, but is provided with an opening which allows the vapour to pass through into the upper quarter of the column, or "spirit chamber." The alcohol condensing on the cold wash-pipe in the spirit chamber collects on the spirit plate and flows off continuously through the condensing worm at a strength of 94 to 96 per cent. by volume.

The lighter boiling constituents, or "ether vapour," pass out at the top of the rectifier and are condensed in the "feints-worm," whence they are either collected separately, or pumped back to the wash charger for redistillation.

In order to withstand the corrosive action of the hot crude spirit, the body of the Coffey still is usually constructed of wood, the sections being held together on the outside by wrought iron tie-rods. The pipes and other metallic parts which come into contact with the liquor are of cast iron or copper. Stills constructed of enamelled cast iron are sometimes used on the Continent for the treatment of sulphite liquor washes, as such washes are apt to be more than usually corrosive.

The Coffey still yields a spirit of 94 to 96 per cent. strength by volume, known as "silent" or "neutral" spirit. This spirit is not absolutely pure, but contains appreciable amounts of secondary products. In the case of alcohol destined for use as a motor fuel, it would appear unnecessary to subject it to a further rectification, as this must necessarily mean an increase both in prime cost and maintenance of plant, and also in steam consumption, together with

a diminished yield of alcohol. Against this must be set the possibility that alcohol, unless it is completely freed from volatile acids, esters, and aldehydes, may cause corrosion of fuel tanks and metal fittings³³ (p. 267). Again, certain by-products, such as fusel oil and the methyl alcohol contained in sulphite spirit, are commercially valuable, and it would probably be remunerative to recover these in as pure a state as possible. Whether it is preferable to produce a "silent spirit" of fair purity, or to employ a still giving a more highly rectified product with complete separation of volatile by-products, would depend largely on the size of the distillery, the nature of the wash to be distilled, and the value of the by-products.

Dephlegmators.—In the modern forms of rectifying still, the rectifying column is generally surmounted by a "dephlegmator." The dephlegmator is, in effect, an additional rectifying column, where further condensation and re-evaporation of alcohol takes place. It serves to economise space and enables the height of the rectifying column to be greatly reduced. In some dephlegmators, overflow plates are used, but usually they are replaced by a system of vertical or horizontal tubes through which water or alcoholic wash is passed at the required temperature.

The difference in temperature between the vapour and the liquid employed as condensing agent is small and the dephlegmator is so constructed as to provide a large condensing surface, whereby a rapid heat exchange between vapour and liquid may be secured. The working of the dephlegmator differs only in degree from the action of the preheater in Bohm's still and the wash-pipe coils in the rectifier of the Coffey still. The temperature gradient and the extent of cooling surface are so adjusted that the alcohol is concentrated and purified by repeated condensation and re-evaporation.

Among the large number of types of dephlegmator in use, reference may be made to that of Gazagne (Fig. 13). The vapour from the rectifier enters at A and passes up through a perforated plate into the tubes B. These tubes are lined on the inside with metal lattice work and are packed with small porcelain balls, with a view to securing intimate contact between the ascending vapour and the condensed liquid. The alcohol vapour passes out through the pipe C, while the feints flow back through D to the rectifying column. The cooling water surrounding the pipes circulates on the thermo-syphon system. From the dephlegmator it rises through E into the expansion chamber F, and from here flows down into the cooler G, to re-enter the dephlegmator at H. The temperature in the cooler is lower than in the dephlegmator, thus ensuring constant circulation of the water. By the repeated use of the same

cooling water the formation of a deposit on the tubes of the main vessel is avoided.

Vessels constructed on this principle are used for purifying alcohol either from fusel oil or from light boiling constituents. In

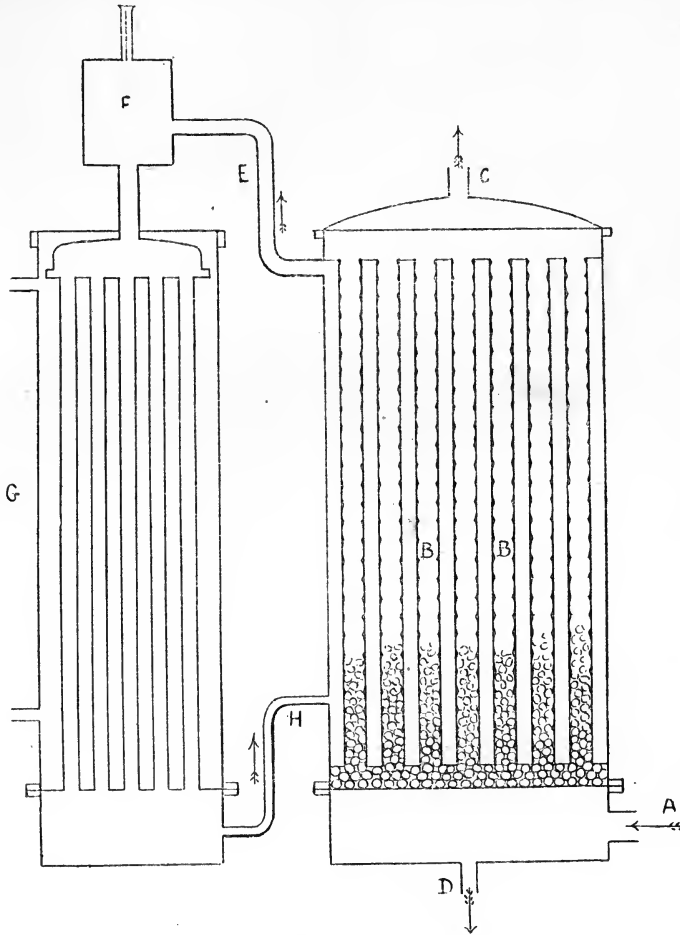

FIG. 13.—Gazagne's Dephlegmator.

(D. Sidersky, *Brennereifragen*, 1914.)

the former case, the pure spirit leaves the dephlegmator as vapour, while in the latter the vapour consists of esters and aldehydes, and the alcohol is condensed.

Modern Continuous Stills.—Continuous distilling and rectifying stills are often of complex construction, as will be seen on

reference to Fig. 14, which shows a type of still suitable for dealing with the weak washes from the fermentation of waste sulphite liquors. The following description of the working of this still is given by Kiby: ³⁴

The wash for distillation is contained in the reservoir A placed above the apparatus. From this reservoir it flows at a regulated rate by way of the preheater X and the dephlegmator E to the

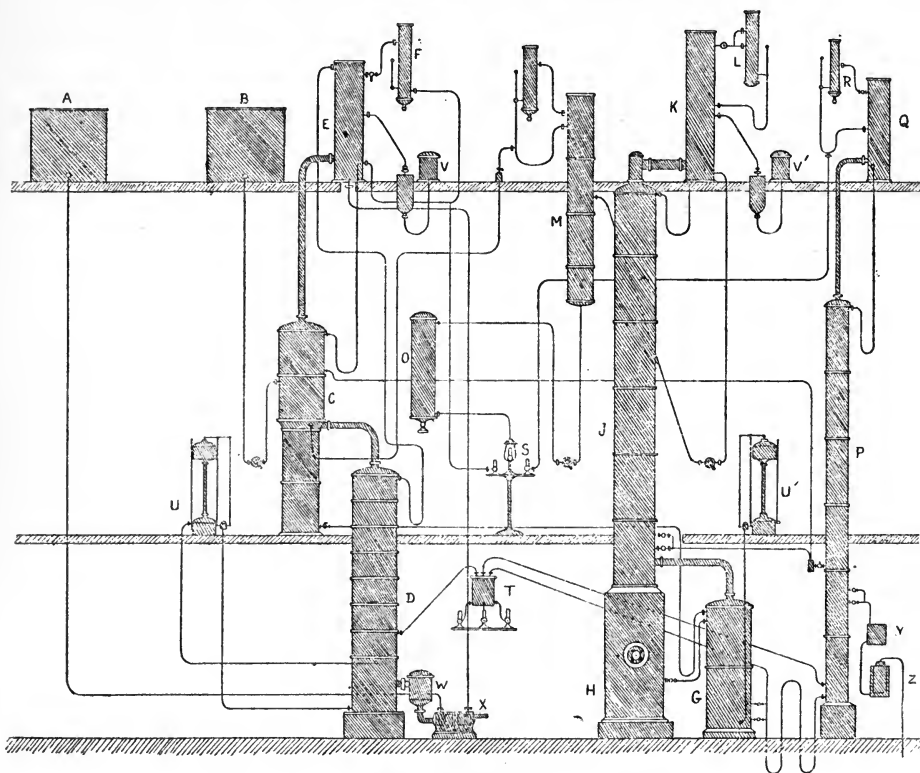

FIG. 14.—Continuous Distilling and Rectifying Apparatus.

(W. Kiby, *Chem. Zeitung*, 1915, 39, 307.)

distilling column D. The spent wash leaves this column by the regulator W and passes through the preheater X, where it gives up its heat to the alcoholic wash on the way to the column. The distilling column consists of a series of overflow plates one above the other, and the wash as it descends the column meets with a current of steam controlled by the steam regulator U.

The steam, charged with alcohol vapour, passes on to the column C. The temperature of this column is so regulated that the more

volatile aldehydic compounds pass up as vapour into the dephlegmator E and the condenser F, where they are separately recovered, while the alcohol, now free from the more volatile impurities, is condensed and passes out at the bottom of the column. The regulation of the temperature in C is effected by means of hot water from the tank B and by the introduction of a small quantity of steam at the lower part of the column. At a certain point in the column the vapours of methyl alcohol, present as an impurity in the crude spirit, are drawn off and recovered separately. The condensed alcoholic liquid passes from the bottom of the column C to a short distillation column G in which the alcohol is completely driven off by a counter-current of steam from the regulator U', the spent liquor passing out from the bottom through a syphon tube.

Control over the working of both the columns G and D is facilitated by the examination of samples condensed at intervals in the test condenser T. The alcoholic vapours from G pass upwards into the rectifying column J, the function of which is to separate them into alcohol to be further purified in the dephlegmator K and condenser L, and higher boiling constituents which collect together with some alcohol in the accumulator H. This liquor corresponds to the "hot feints" of the Coffey still. The alcohol flows from K to a purifying column M, where it is further separated from volatile impurities, and from there passes by way of the cooler O to the test-glass S.

The higher boiling fractions are further dealt with in the column P which receives liquor partly from the lower part of J and partly from the upper part of C. The alcohol passes up into the dephlegmator Q and condenser R, whence it flows to a test-glass at S, while the fusel oil collects and is run off at Y and Z. The working pressure of the apparatus is controlled by the two automatic steam regulators UU', connected with the lower parts of the columns D and G. If the pressure in the column falls below a certain point, the float of the steam regulator sinks and opens a steam valve. If the pressure gets too high, the float rises and shuts the valve. VV' are water regulators which act automatically on much the same principle, and control the supply of water to the condensers. To avoid undue complication several of the steam and water pipes have been omitted from the figure. The details of the dephlegmators and condensers are more clearly seen in Fig. 15 (p. 83).

An actual test of a still similar to the one described was carried out by the Institut für Gärungsgewerbe in Berlin, and the following data were obtained:

In the first test 115,420 litres of wash were distilled in $7\frac{1}{2}$ hours with a consumption of 16,200 kgm. of steam. This corresponds to

15,430 litres of wash per hour and a consumption of 14.03 kgm. steam per 100 litres of wash. The pressure in the still was only 0.180 to 0.185 atm. (2.65 to 2.72 lb. per square inch gauge). The alcohol content of the wash ranged from 0.77 to 1.05 per cent. by volume, which is the average strength of sulphite liquor washes. The spent wash was free from alcohol and 990.6 litres of neutral spirit were produced at a strength of between 96.5 and 97 per cent. alcohol by volume. In addition 17.12 litres of fusel oil (=1.73 per cent. on the yield of alcohol) were obtained.

In the second test the consumption of steam was 14.7 kgm. per 100 litres of wash. The spirit obtained was of 97 per cent. strength by volume, and the yield of fusel oil 1.45 per cent. of the yield of alcohol.

In a third test the rectifying columns were cut out and the apparatus worked for crude spirit only. The consumption of steam was 11.5 kgm. per 100 litres of wash.

This represents a great advance on the distilling practice of former years, when a consumption of 18 to 20 kgm. steam per 100 litres of wash was considered quite good. The yield of pure spirit was about 80 per cent. of the crude spirit.

In the ordinary rectification of alcohol with separation of first runnings and feints it is sometimes difficult, according to Sorel, to get a pure neutral spirit, owing to secondary reactions occurring between the various constituents during the process of distillation. In some stills purification is effected by the use of marble chips, volatile acids being thus removed as calcium salts and the continuous formation of traces of volatile esters checked.

Guillaume's Rectifying Still.—A rectifying still designed on rather different lines is that of Guillaume (Fig. 15). In this still advantage is taken of the fact, already referred to, that when alcohol of low strength is distilled the fusel oil goes over in the first runnings. By controlling the dilution of the alcohol, the whole of the volatile impurities are recovered at the top of the still, and the dilute alcohol thus freed from fusel oil can be subsequently concentrated.

The crude spirit suitably diluted is introduced at the top of the column A by the pipe O, and is heated by means of a closed steam coil entering the column at D. Water or dilute spirit is also introduced at E into the top of the section B, in order to keep the alcohol in B down to the required strength. The two thermometers T and T' serve to regulate the strength of the liquor, and the temperature recorded should be approximately the same at both points. In A and B the higher alcohols behave as foreshots, but in the top section C of the column, where the alcohol becomes more con-

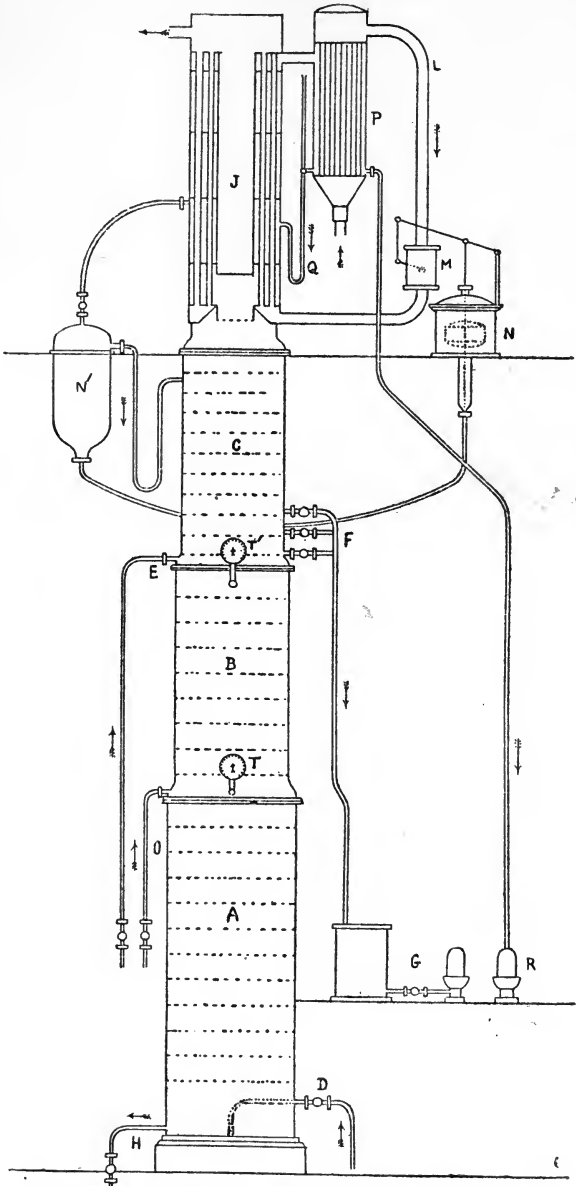

FIG. 15.—Guillaume's Rectifying Still. (Sidersky.)

centrated, fusel oil tends to accumulate as feints and is run off through one of the cocks at F to the condenser and test-glass at G. The purified dilute alcohol flows off continuously at H and is sent to another column for concentration. The flow of spirit and steam and the rate at which the feints are taken off at F are so regulated that no fusel oil appears in the liquid at H, and that the alcohol content of the feints is kept as low as possible.

The lighter boiling constituents, *i.e.* those that still behave as foreshots when the alcohol becomes more concentrated in C, rise into the dephlegmator J. In the dephlegmator the vapours are deflected by the closed central water vessel into an annular tube system, where partial condensation occurs, intimate contact with the condensed liquid being assisted by perforated metallic plates placed at different levels. Water enters at the bottom of the condenser P and flows to the dephlegmator by way of the pipe L and the valve M, the latter being automatically controlled by the pressure regulator NN'. The water outlet is shown at the top of the vessel J. The ester and aldehyde vapours from the dephlegmator are condensed in P, whence they are partly returned to the distilling column through the pipe Q and partly run off to the test-glass R. The part of the pipe Q which projects above the junction with the condenser P is an air tube designed to allow of the escape of gases contained in the wash.

It is claimed that this type of still allows of easy and complete purification of crude spirit with the production of a minimum of intermediate grades. The dilute alcohol flowing away at the base of the column can be concentrated to any desired strength. The still can be used for the distillation of alcoholic wash as well as for the rectification of crude spirit.

REFERENCES

- ¹ E. S. Beaven, *Journ. Inst. Brewing*, 1902, **8**, 542.
- ² J. L. Baker and W. D. Dick, *Journ. Inst. Brewing*, 1905, **11**, 380.
- ⁴ A. R. Ling, *Journ. Fed. Inst. Brewing*, 1903, **9**, 446.
- ⁵ H. T. Brown and J. Heron, *Trans. Chem. Soc.*, 1879, **35**, 596.
- ⁶ H. T. Brown and G. H. Morris, *Trans. Chem. Soc.*, 1885, **47**, 52, and 1889, **55**, 449, and 462.
- ⁷ H. T. Brown and J. H. Millar, *Trans. Chem. Soc.*, 1899, **75**, 333.
- ⁸ A. R. Ling and B. F. Davis, *Journ. Fed. Inst. Brewing*, 1902, **8**, 475; 1903, **9**, 446. *Trans. Chem. Soc.*, 1904, **85**, 16.
- ⁹ J. L. Baker and H. F. E. Hulton, *Trans. Chem. Soc.*, 1914, **105**, 1529.
- ¹¹ K. Windisch and W. Jetter, *Zeitsch. für Spiritus Industrie*, 1907, **30**, 541, 552.
- ¹² A. Boidin and J. Efront, Fr. Pat., 461,853, Nov. 7, 1912. J. Efront, *Compt. Rend.*, 1917, **164**, 415.
- ^{12a} A. C. Chapman, *Journ. Roy. Soc. Arts*, 1921, **69**, 597.

- ¹³ H. Tappeiner, *Münch. med. Woch.*, 1892, No. 23, 505.
- ¹⁴ M. Maercker, *Handbuch der Spiritus Fabrikation (Maercker-Delbrück)*, Berlin, 1908.
- ¹⁵ W. Hoffmann, *Chem. Zeitung*, 1915, **39**, 525.
- ¹⁷ J. L. Baker and H. F. E. Hulton, *Seventh Internat. Congress of Applied Chemistry, London*, 1909, Section VI.B., p. 132.
- ¹⁸ A. C. Reavenall, *Journ. Inst. Brewing*, 1915, **21**, 97-110.
- ¹⁹ A. Delemar, *Chim. et Ind.*, 1919, **2**, 892.
- ²⁰ W. Henneberg, *Zeitsch. für Spiritus Industrie*, 1902, No. 19.
- ²¹ O. Grove, *Journ. Inst. Brewing*, 1914, **20**, 248.
- ²² *Société d'Exploit. des Procédés H. Boulard*, Fr. Pat., 464,601, Oct. 29, 1913; Eng. Pat., 102,945, Dec. 7, 1916.
- ²³ J. A. Nettleton, *The Manufacture of Whisky and Plain Spirit*, Aberdeen, 1913.
- ²⁴ J. H. Northrop, L. H. Ashe, and R. R. Morgan, *Journ. Ind. Eng. Chem.*, 1919, **11**, 723.
- ²⁵ E. Kayser, *Compt. Rend.*, 1915, **161**, 181.
- ²⁶ J. Magne, *Louisiana Planter*, 1917, **59**, 13.
- ²⁷ S. S. Peck and N. Deerr, *Hawaiian Sugar Planters' Assoc.*, Bull. No. 28, Department of Agriculture and Chemistry, 1-54 (1909).
- ²⁸ E. Galle, *Zeitsch. für angew. Chemie*, 1918, **31**, 3, 6.
- ²⁹ M. Maercker, *Spiritus Fabrikation*, Berlin, 1908.
- ³⁰ J. A. Nettleton, *The Manufacture of Whisky and Plain Spirit*, Aberdeen, 1913.
- ³¹ M. Maercker, *Spiritus Fabrikation*, Berlin, 1908.
- ³² E. Sorel, *La Distillation*, Paris, 1895.
- ^{32a} J. Reilly and W. J. Hickinbottom, *Sci. Proc. Roy. Dublin Soc.*, 1921, **16**, 233.
- ³³ R. P. Duchemin, *Seventh Internat. Congress of Applied Chem., London*, Section VI.B., p. 91; and M. Heinzelmann, *Zeitsch. für Spiritus Industrie*, Sept. 28, 1905.
- ³⁴ W. Kiby, *Chem. Zeitung*, 1915, **39**, 307.

CHAPTER IV

THE ECONOMICS OF ALCOHOL PRODUCTION FROM CROPS

It should be emphasised from the outset that the suitability of any particular raw material for the production on a large scale of industrial alcohol is primarily dependent upon cost—that is to say, the price at which the material required for 1 gallon of alcohol can be delivered at the distillery. This cost is largely governed by three factors :

- (i) Content of fermentable carbohydrates.
- (ii) Yield of crop per acre.
- (iii) Availability of raw material, *i.e.* the relative labour involved in cultivation and the ease and certainty with which a constant annual supply can be maintained.

Thus certain of the cereals, although they contain a high content of starch, give a low yield per acre, and would not always be available, being too valuable as food stuffs and commanding a high price for this purpose. In case of a partial failure of the cereal crop, supplies would be diverted from the distillery for use as food.

Certain root crops such as beets and mangolds, which are comparatively poor in sugar content, give high yields per acre. Their cultivation, however, makes heavier demands upon labour than is the case with cereals, and transport and storage are more difficult. They are therefore confined, for the most part, to areas which are highly developed agriculturally.

Cellulose and the by-products from the wood pulp and timber industries are readily available in certain localities, but the content of fermentable matter obtainable from these materials by existing processes is comparatively small.

Before discussing the general economic aspects of the power alcohol question, a comparative survey may be made of the more important raw materials from the point of view of yield and availability.

Cereals.—The most important of the cereals, or grasses grown for the sake of their edible grain, are wheat, barley, oats, rye, maize, and rice. Millet, or sorghum grain, is also extensively

grown in Africa and southern Asia. Barley, maize, oats, and rye are at present largely used in this country for the production of potable and industrial spirit. Roughly two-fifths of the total cereals used for this purpose consist of malted barley, the remainder being given in the Excise returns as unmalted grain, without further differentiation. In the manufacture of pot still whisky, barley, oats, and rye are the chief materials used, and for patent still spirit these are largely replaced by maize. Wheat is not used to any considerable extent. In 1913, before the abnormal conditions caused by the war, the total quantity of malt used in the United Kingdom was roughly 20,000 tons, and of unmalted grain 30,000 tons. In the same year the total quantity of alcohol produced in this country from all materials including molasses was about 26½ million gallons, calculated as absolute alcohol, of which the greater part was retained for home consumption as potable spirits. In 1916 the quantity distilled was 28 million gallons.

Wheat contains from 65 to 66 per cent. of fermentable carbohydrates, of which 2 to 3 per cent. consist of sugars, and the quantity of 95 per cent. alcohol obtainable from 1 ton is given by various authorities as from 78 to 88 gallons, or about 83 gallons as an average. Wheat has a wide area of distribution. While adaptable to hot climates such as those of Egypt, India, and California, the greater part is grown in northern latitudes, in regions of cold winters, and its successful culture seems to be constantly extending northwards.¹

The yield of wheat per acre varies considerably in different countries, the average for Great Britain being about 1 ton, and for the United States less than half of this quantity. The yield per acre in Russia is stated to be not more than a quarter of a ton.² A mean figure based on the relative production of each country and the average yields, would be roughly 0·5 ton per acre.

Barley has a wider range of cultivation than any other cereal, from the northern latitudes to subtropical countries, but is best adapted to a warm, dry climate. The grain contains 57 to 66 per cent. of fermentable carbohydrates, and the yield of 95 per cent. alcohol is 70 to 80 gallons per ton. The average yield per acre in the United Kingdom is much the same as that of wheat, the latter being perhaps slightly the heavier crop, but the ratio between the two varies considerably in different localities. In the chief grain-producing countries the yield of barley is roughly 30 per cent. greater than that of wheat, so that the average may be taken as 0·65 ton per acre.

Rye is a cereal closely related to wheat, but is better adapted than wheat to cold climates. It is mainly grown in Russia and

Germany, and is not of much importance as a cereal crop in other countries. Rye contains from 59 to 68 per cent. of fermentable carbohydrates, of which 4 to 5 per cent. consist of sugars. The weight of grain per acre may be taken as 0.4 ton on the average, and the yield of 95 per cent. alcohol from 1 ton is given by various authorities as from 75 to 85 gallons. The average would be about 80 gallons.

Oats contain less starch than the other cereals, and the yield per acre in this country is about 0.7 to 0.8 ton. The alcohol obtained from 1 ton of oats varies from 65 to 75 gallons. In the United States, which is the largest producer of oats, the average yield is 0.4 ton per acre, although much heavier crops are grown in the Northern States.

Buckwheat is grown to some extent in North America, but is only of local importance.

Regarded as possible sources of industrial alcohol on a large scale, cereals such as wheat and barley can hardly be considered as offering great possibilities. Wheat is far too valuable as a food stuff. The existing wheat areas of the world are barely sufficient to meet the present demand, and it is unlikely that further extension of these areas can be undertaken on a scale sufficiently large to give any considerable surplus over food requirements. The same may be said, in less degree, of barley, oats, and rye. Moreover, the average amount of alcohol which can be obtained per acre from these crops is comparatively low, varying from about 30 gallons from oats to 50 gallons from barley, which compares unfavourably with the amount obtained per acre of potatoes or root crops. These figures are calculated for average harvests in the main grain-producing countries. In the United Kingdom, where the weight of the crop is heavier, the yield of 95 per cent. alcohol per acre would be nearer 70 to 80 gallons, but even this is far below the corresponding yield for root crops. At the same time the appliances for sowing and harvesting grain on a large scale have been brought to such a high state of perfection that the cost of cultivation per acre is comparatively small. It may therefore happen that grain spirit may be actually cheaper than potato spirit. Thus at prices ruling in December 1920, the raw material for a gallon of grain spirit cost from 4s. to 5s., and for potato spirit 8s. to 9s. At 1913 prices the corresponding figures were about 1s. 8d. and 2s. respectively.

A cereal such as **Maize**, which as a food stuff is not so valuable as wheat and barley, and which gives a heavier crop, has greater possibilities as a source of industrial alcohol. Maize contains from 65 to 68 per cent. of fermentable carbohydrates, and 1 ton will

yield from 84 to 87 gallons of 95 per cent. alcohol. In the United States maize is largely used in distilleries. It is easily grown in that country and constitutes by far the larger proportion of the total cereal crop. Maize is commonly credited with a much larger yield per acre than the other cereals, but this is true only for certain areas and certain climates. The crop is more dependent upon correct climatic conditions than are wheat and barley, and the successful cultivation of maize is limited to certain areas, such as the "corn-belt" of the central States of North America, where the right conditions of rainfall, temperature, and soil exist. In such areas the yield of maize per acre may be as high as $2\frac{1}{2}$ tons, while in several of the more southern States it is barely $\frac{1}{4}$ ton per acre. The crop is, however, stated to be successful in certain tropical climates.³ The average yield for the United States of America is about 0.7 ton per acre. This figure also represents the average yield in Australia over the ten years from 1905 to 1915. Rainfall is all-important during the "tasselling" stage of the crop, and experience in the United States has shown that irrigation is not a satisfactory substitute. Maize possesses the advantage from the distiller's point of view that it withstands transport and storage without deterioration, and is considerably cheaper than wheat and barley. The price in this country in 1913 was £5, 10s. per ton, as against £8 for imported American wheat. In 1905 the price in America at the farm varied in different States from £2, 11s. to £7, 18s. per ton, with an average of £3, 8s.,⁴ corresponding to 9½d. as the cost of the raw material for 1 gallon of 95 per cent. alcohol. In 1919 the average price paid to producers was equivalent to £15, 5s. per ton calculated at par of exchange, but this was an abnormal figure due to the war. Breckler gives the wholesale price of maize alcohol in America in 1917 as 2s. 4d. per Imperial gallon (par of exchange).

It is estimated (Desborough) that at the present day it might be possible to produce maize in certain South American countries such as Peru, where two or three crops may be harvested yearly, at as low a figure as £2 per ton. On this basis the raw material for 1 gallon of 95 per cent. alcohol would cost about 6d., but whether maize could be produced continuously over a series of years at this price is doubtful. With maize at £4 per ton the raw material for 1 gallon would cost about 1s., and allowing 2s. to 2s. 6d. for cost of manufacture, freight, and distribution charges, it might be possible to retail 95 per cent. alcohol in this country at 3s. to 3s. 6d. per gallon.

It has been proposed to utilise the stalks of immature maize as a source of alcohol. Normally the stalks contain no sucrose

and very little dextrose, but if the ears are removed when the grain begins to be milky, the stems accumulate sugars. The total yield of sugars varies from 7.25 to 10.27 per cent. of sucrose, and from 1.33 to 3.11 per cent. of dextrose, and the yield of absolute alcohol per acre is estimated at 130 gallons. The characteristics of this material would seem, therefore, to be somewhat similar to those of sorghum cane (p. 107).^{4a}

Sorghum grain, *Andropogon Sorghum* or *S. vulgare*, also known as Kaffir corn, "dari," millet, or Guinea corn, is a cereal which is widely used as a food stuff in Africa and the East. The plant in some respects resembles maize, but the grain is smaller and rounder. There are several different varieties of sorghum, some of which are cultivated for their grain (non-saccharine varieties) while others yield a juice rich in sugar and are grown for this purpose alone (saccharine sorghum). The name "millet" is also applied to cereals of other genera, e.g., *Panicum*, but for practical purposes these may all be grouped together with sorghum grain. The grain contains practically the same amount of fermentable carbohydrates as maize, and yields 84 to 87 gallons of 95 per cent. alcohol per ton. Sorghum grain is characterised by the formation of an active diastase on germination. The extract from sorghum malt hydrolyses starch at a greater rate than barley malt, but the conversion is not so complete.⁵ Sorghum can be successfully grown under the same conditions as maize, but is specially suited to hot dry climates, where the yield is somewhat higher than that of maize. The average yield is about 0.7 ton per acre.

The only other cereal of importance is **Rice**, which is extensively grown as a food stuff in India, China, and Japan. Of the total production, excluding that of China, India contributed in 1916 to 1917 more than half. The cultivation of rice is, in general, restricted to moist, even swampy, areas of tropical or subtropical countries, and when grown on upland soils the success of the crop is largely dependent on efficient irrigation.

As harvested, rice contains about 65 per cent. of carbohydrates, and the yield of rough rice or "paddy" averages 0.7 ton per acre. Cleaned rice freed from the husk and outer skin represents 62 per cent. of the original weight of "paddy," so that an acre only yields 0.43 ton. The content of fermentable carbohydrates in cleaned rice is approximately 76 per cent., and the yield of alcohol 85 gallons per ton.

Owing to the particular conditions required for the cultivation of rice, and its great value as a food stuff in the East, it cannot be considered as a likely source of industrial alcohol in any considerable quantity.

The utilisation of rice straw has recently been the subject of investigation, and is dealt with on p. 147.

Tubers.—The production of alcohol from **Potatoes** has been highly developed in Germany, but not, so far, to any great extent in other countries. Potatoes contain on the average about 19 per cent. of starch, but by careful selection and breeding, varieties have been produced containing a much higher percentage, up to 27 or 28 per cent. in warm and dry seasons. The yield per acre varies greatly in different soils and climates. In 1918 the average for England was 6·6 tons, for Scotland 6·8 tons, and for Ireland 5·5 tons per acre, but under favourable conditions with good cultivation yields of as much as 16 tons per acre, and over, have been obtained.

In Germany the average yield on the sandy soil of the eastern provinces is stated to have increased under cultivation by 50 per cent. during the period from 1896 to 1913. It is a curious fact that the yield of potatoes per acre appears to vary with the relative density of the population. The highest yield per acre is obtained in Belgium, with a population of 658 to the square mile, while the lowest is given by the United States, with only thirty-one people to the square mile.⁶

DENSITY OF POPULATION AND INTENSITY OF POTATO PRODUCTION

Country.	Density of Population. Persons per Sq. Mile.	Yield in Tons per Acre (less Seed). Average, 1911-1913.
U.S.A.	31	1·3
France	193	2·2
Germany	311	3·9
United Kingdom	374	4·3
England and Wales	550	5·0
Belgium	658	6·04

Potatoes containing 20 per cent. of starch yield on an average 27 gallons of 95 per cent. alcohol per ton, but it is usually reckoned that the starch content is about 17 to 18 per cent. and the alcohol yield 20 to 22 gallons per ton. The quantity of alcohol obtainable per acre would thus be about 137 gallons.

In 1904 the price of potatoes in Germany was £1, 7s. per ton, and the normal price at that period is stated to have been £1 to £1, 3s. per ton. At 21s. per ton the cost of raw material for one gallon of 95 per cent. alcohol would be 1s. In this country the present value of potatoes on the farm as a feeding stuff is estimated to be about £2, 5s. per ton (*Journal of Ministry of Agriculture,*

October 1921), which would correspond to nearly 2s. 3d. for the raw material for one gallon of alcohol.

Development of the Potato-Spirit Industry in Germany.—

The success attained in Germany in the production of alcohol from potatoes has often been quoted as an example of what can be done by scientific methods of agriculture fostered and assisted by the State.

The conditions existing to-day in this and other countries are very different from those obtaining in Germany during the latter part of the last century. Nevertheless, the course of development of this industry provides valuable object-lessons as to the practicability of establishing the production of power alcohol on an agricultural basis. The alcohol industry in Germany was not originally the outcome of a desire to find a cheap substitute for petrol, but was one of the consequences of a policy primarily directed toward the extension and improvement of agriculture.⁷ Certain parts of east Germany (Brandenburg, Posen, and Silesia) possess large tracts of poor sandy soil, and the cultivation of potatoes, promoted during the latter half of the eighteenth century by Frederick the Great, afforded a means of bringing these sandy tracts into profitable cultivation. Potatoes introduced as a rotation crop, owing to the deep cultivation and heavy manuring required and the suppression of weeds, greatly increase the fertility of a light sandy soil. The districts in which this system was introduced soon became capable of supporting a much larger agricultural population than had previously been the case. The prosecution of this policy on an extensive scale implied a production of potatoes greatly in excess of the normal food requirements of the population. The surplus was utilised mainly for feeding stock, especially pigs, and to a less extent for the production of alcohol.

Potatoes are an exhausting crop, and if grown for food alone remove much material from the soil which has to be replaced by heavy applications of manure. If grown for alcohol, the distillery residues, which contain practically the whole of the nitrogen, phosphorus, and potash of the potatoes, can either be returned direct to the soil, or be utilised for the feeding of stock on the farm. The resultant economy in feeding stuffs enables the farmer to maintain a greater head of stock with the attendant advantage of abundant farmyard manure. Further, the distillery enables him to avoid any loss consequent on the inferior keeping qualities of some kinds of potatoes, by converting them into a product which may be stored indefinitely.

The methods by which the production of potato spirit was encouraged consisted for the most part of a complicated system of

differential taxation. The aim throughout was to encourage the smaller agricultural distillery rather than the larger industrial concern using molasses and grain as raw materials. In 1820 the tax, which had up to that time been levied on the still, was replaced by a tax on fermenting-vat or wash-back capacity ("Maischraum-" or "Maischbottichsteuer"). For this purpose the yield of alcohol was assumed to be 2.5 per cent. of the volume of the mash. The imposition of this tax had an extraordinary effect in stimulating the technical development of the distilling industry. It was obviously to the advantage of the distiller to obtain as much alcohol as possible from a given fermenting-vat capacity, and to improve the technology of the process so as to allow of the use of concentrated mashes. As a result, the yield of alcohol gradually rose from 2.5 per cent. of the mash up to 12 or even 14 per cent., and the tax on fermenting-vat capacity was progressively increased.

Potatoes proved to be more suitable in many ways than grain for thick mashes, and this, combined with the higher yield of starch per acre, favoured their use in preference to grain for alcohol production. Thus, in 1855, 855,000 tons of potatoes and 138,000 tons of grain were used in Prussian distilleries, and in 1905 these quantities had risen to over 2 million tons of potatoes and 231,000 of grain. Up to the year 1879 no differentiation in the way of tax was made between industrial and potable spirit, but in this year the North German States introduced legislation permitting the refund of taxes on industrial alcohol. As a consequence the consumption of alcohol for industrial purposes increased from an insignificant amount to 4 million gallons in 1886 to 1887.

In 1887 a new system of taxation was introduced. In addition to the fermenting-vat capacity tax, a "consumption tax" was levied upon the finished product when disposed of ("Verbrauchsabgabe"). The object being to limit the consumption of duty-paid potable spirits, the new tax was graduated according to production. Each distillery was allotted a certain output termed the "Contingent," which was supposed to represent its share of the total amount of potable spirit consumed. The latter was estimated at about 4.5 litres per head of the population. Tax was levied on the "Contingent" at the rate of 2s. 4d. per gallon of absolute alcohol, but on any alcohol produced in excess of this quantity the duty was 3s. 3d. per gallon. As far as potable spirit was concerned, therefore, any tendency to increased consumption was counteracted by a corresponding increase in duty. The "Verbrauchsabgabe" was a much heavier duty than the "Maischraumsteuer," and had the immediate effect of reducing the total consumption of alcohol by

17½ million gallons. Industrial alcohol was not affected by the increased duties, as the tax paid was refunded. Moreover, the 1887 legislation removed several of the inconveniences which had hampered the free use of duty-free alcohol granted in principle by the law of 1879. As a result, the use of industrial alcohol almost immediately rose from 4 million to approximately 8 million gallons. This, however, was not nearly sufficient to offset the fall of 17½ million gallons in total consumption due to the heavier duties on potable spirit, and for several years the alcohol industry was in a state of depression due to reduced demand and falling prices. Owing to the relatively high price of even the duty-free industrial alcohol, as compared with mineral illuminants and fuels, the outlet in this direction, upon which the future of the potato-spirit industry depended, was still limited.

Co-operative organisations were established for the sale of the alcohol produced, and every effort was made to develop the use of alcohol industrially for lighting, heating, and power. It was recognised, however, that these efforts would be only partially successful unless some means were found for reducing the cost of alcohol to a figure more closely approximating to that of mineral fuels.

In 1895 a system was introduced whereby the revenue from potable spirits was partly devoted to paying a bonus on alcohol used for industrial purposes. An additional duty ("Zuschlag") varying from 5½d. to 11d. per gallon of absolute alcohol, together with a distillation tax ("Brennsteuer") of from ½d. to 3½d. per gallon was imposed, and the revenues from this source were utilised for paying the refund or bonus ("Rückvergütung") on industrial alcohol. The incidence of these taxes and the amount of the bonus repayable varied according to the production of the distillery. As a general rule the agricultural distilleries paid only the "Maischraumsteuer," or in place of this a modified "Zuschlag" and "Brennsteuer." The larger industrial distilleries paid both the latter taxes at higher rates but not the "Maischraumsteuer." The maximum refund which could be secured in respect of any spirits, approximating to 1s. 7½d. per bulk gallon of absolute alcohol, was obtainable only in respect of the "Contingent" output. On output in excess of the contingent the maximum bonus amounted to 8¼d. per bulk gallon. The system was so adjusted that the smaller agricultural distilleries were enabled to sell industrial alcohol at a price low enough to compete with other fuels, while the grading of the bonus discouraged over-production. The fundamental principle of the scheme was to make those interested in the production of alcohol sharers with the State in the revenue

collected on potable spirits, and the money necessary for the cheapening of industrial alcohol was raised within the industry itself.

The legislation of 1895 gave a powerful stimulus to the use of industrial alcohol, and the sales rose from 17·8 million Imperial gallons in 1895-1896 to 32·6 million in 1905-1906. This was partly due to the success of co-operative organisations having for their object the disposal of the alcohol produced. Two main organisations were formed, one consisting mainly of producers and the other of rectifiers. The association representing the producers contracted with the rectifiers' association ("Centrale für Spiritus-Verwertung") for the disposal of all their alcohol in the best possible manner, and mutual agreements were made regarding supplies and prices. The "Centrale" created a technical section with the following main objects :

- (a) To test and develop methods of using alcohol for production of heat, light, and power.
- (b) To establish depôts for the sale of alcohol motors, lamps, and heating appliances.
- (c) To conduct a literary campaign for the application of alcohol to household purposes.
- (d) To promote exhibitions at various centres.
- (e) To organise the retail trade in denatured alcohol of the required strength and at a stable price.

By this time the cultivation of potatoes had become an integral part of agricultural practice in east Germany, and production was constantly increasing. In spite of the check to over-production of alcohol which the graduated bonus system sought to impose, potatoes poured into the distilleries, and it became more and more difficult to establish equilibrium between production and consumption. The increased demand for industrial alcohol, due to the efforts of the "Centrale," could not keep pace with the supply, and the surplus of alcohol carried over became larger from year to year.

In October 1902 the surplus for which no use could be found amounted to 22 million Imperial gallons, and an agreement was concluded with the greater number of the agricultural distilleries to curtail their production by 18 per cent. This had the effect of reducing the surplus carried over to about 6·6 million gallons, and voluntary restriction of output henceforth became a standing feature of the distilling industry.

From 1905 to 1914 the total production of alcohol in Germany remained fairly stationary at approximately 80 million gallons, of which 33 to 35 million were used for industrial purposes.

In 1909 the tax on fermenting-vat capacity was removed, as many of the agricultural distilleries had taken up the manufacture of pressed yeast and were no longer working with such thick mashes. Moreover, the introduction of improvements, such as continuous fermentation, was rendered impossible by the restrictions hitherto imposed upon mashing and fermenting operations. In place of the "Maischraumsteuer" and other taxes assessed upon raw materials and processes, the duty on the finished product ("Verbrauchsabgabe") was increased. The "Contingent" was calculated on a somewhat different basis, each distillery being allotted a certain proportion ("Brennrecht") of the total alcohol production, upon which it was taxed at the rate of 4s. 8d. per bulk gallon, while upon any alcohol produced in excess of this quantity ("Ueberbrand") the duty was 5s. 7d. per gallon, unless it was completely denatured. Agricultural distilleries continued to receive preferential treatment as before in the matter of bonus, provided that the raw material used was produced on the owner's farm, and that the whole of the spent grains and wash was utilised either as feeding stuff or manure on the same farm.

It is apparent from the foregoing outline of the development of industrial alcohol in Germany prior to the war that the success attained was due not so much to actual cheapness of production as to the effect of the State subsidies. The normal price in Germany of denatured alcohol in 1903 to 1906 was 1s. per bulk gallon. Since production was as far as possible limited to the amount required for home consumption, a partial failure of the potato crop, which provided four-fifths of the raw material, was liable to force up the price of alcohol. This occurred in the year 1904, and the price of denatured spirit accordingly rose to 1s. 9½d. per bulk gallon. But taking 1s. as the normal selling price, it was only possible to sell at this low figure by reason of the bonuses paid to the producer. The maximum bonus payable on the amount represented by the "Contingent" would amount to about 1s. 5d. per bulk gallon of 90 per cent. spirit. Without the bonus this spirit would therefore have cost the consumer 2s. 5d. per gallon. Assuming an average rate of bonus the economic price of the spirit would work out at slightly less than 2s. The corresponding price of methylated spirit in this country at the same date was 2s. to 2s. 6d. per gallon. These figures bear, of course, little relation to present-day conditions, but they serve to indicate the extent to which the policy of State subsidies has been responsible for the development of the German alcohol industry. The price of alcohol was brought down by subsidy to a point at which it could with advantage be used as a source of light and heat in country districts where petroleum was not so

readily obtainable as in the larger towns. A further inducement was provided in the shape of an import duty of 2½d. per gallon on petroleum. Although used extensively in farm engines of the stationary and locomobile types, working at high compression and slow speed, alcohol never replaced petrol to any extent as a fuel for motor transport until the advent of abnormal war conditions. This seems to have been due partly to the cheapness of imported petrol before the war and partly to the reluctance of manufacturers and designers to spend time and money on developing an engine which would be useless for export to countries where power alcohol was unknown. The experience gained during the war, when much of the German motor transport was run on fuel mixtures containing a high proportion of alcohol, is likely to lead to great developments in this direction, but it seems doubtful whether potatoes will in the long-run constitute a sufficiently cheap raw material. The production of alcohol from sulphite liquor and from wood waste, and of synthetic alcohol from calcium carbide, is already making considerable progress, and it is significant that the German Government have found it necessary to take steps to control these manufactures in order to safeguard agricultural interests.

Under the Spirit Monopoly Act of 1918 the whole of the alcohol produced in Germany was taken charge of by the State and distributed under official supervision. Distilleries producing alcohol from sulphite liquor, wood, and calcium carbide were brought completely under State control ("Verschlussbrennereien"), but agricultural distilleries, provided that they gave certain undertakings regarding the materials employed and the disposal of the by-products, enjoyed a greater measure of freedom ("Abfindungsbrennereien"). The object of the Act was apparently twofold. On the one hand it sought to relieve the shortage of alcohol by fostering the production of spirit from wood and carbide, and on the other to protect agricultural distilleries from the unrestricted competition of these new industries, which had developed considerably during the war under a policy of State subsidies. The output of alcohol by the State distilleries was limited, for a certain period, to one-tenth of the total quantity of alcohol produced.

When the 1918 Act was passed, the agricultural distilleries had suffered heavily as a result of the war, and it soon became evident that it would be many years before they would be capable of an output even approximately equal to that of pre-war days. A considerable portion of the potato land of east Germany was lost under the frontier readjustments of the peace treaty, and practically the whole of the remaining potato crop was required for human food, only damaged and unsound produce being available for distilling.

The condition of affairs is illustrated by the following figures :

Years.	Number of Potato Distilleries.	Potato Spirit. Millions of Gallons.	Total Alcohol from all Sources. Millions of Gallons.	Potato Spirit per cent. of Total Alcohol produced.
1913-14	6000	66	81.4	80
1918-19	2300	17.6	28.6	60
1919-20	1500	6.6	13.2	50

Renewed efforts were made at the beginning of 1920 to relieve the situation by increasing the output of alcohol from sources other than potatoes and grain, but the amount produced so far from sulphite pulp, wood, and carbide has been comparatively insignificant. Notwithstanding this, a certain degree of anxiety is apparent on the part of German agricultural distillers lest they should eventually be driven to the wall by the competition of carbide spirit. They urge unceasingly the agricultural importance of the potato distilleries and the essential part played by the spent mash as a feeding stuff in the farming system of the eastern provinces.

Conditions in Great Britain as regards Potato Spirit.—In considering the possibilities of developing the alcohol industry in the United Kingdom on lines similar to those followed in Germany, it is instructive to compare the relative extent to which potatoes are cultivated in the two countries.

The total crop of potatoes in Germany in 1914 was, in round figures, 47.5 million tons. Of this 11.6 million tons were used for human food, 6.8 million were reserved for seed, and 27.1 million were used as feeding stuff for stock and for industrial purposes. Of the latter amount only 2 to 2.25 million tons were used for distilling, by far the greater portion being fed to live stock. Thus only a very small proportion of the total potato crop was converted into alcohol. The system of agriculture practised in Germany before the war was so adjusted that not more than 5 to 6 per cent. of all the potatoes found their way to the distilleries. About one-third of the population of Germany is agricultural, and potatoes occupy a comparatively important position in the dietary of the people, the annual consumption being equivalent to 3.8 cwt. per head. In the United Kingdom the total potato crop may be taken roughly as 6 million tons, of which 1 million tons are fed to live stock, 1 million reserved for seed, and 4 million used as food. Only 13 per cent. of the population is agricultural, and potatoes do not constitute a relatively important article of diet, the consumption being only

1.75 cwt. per head. Over 10 per cent. of the total cultivated acreage in Germany is devoted to potatoes, while the corresponding figure for the United Kingdom is $2\frac{1}{2}$ per cent.

It would appear from these figures that the distilleries of Germany taken as a whole occupy only a secondary position in a highly developed agricultural system which depends upon the potato as the most important crop. The growth of the potato spirit industry has been intimately bound up with the agricultural methods and dietetic habits of the people.

The possibilities of developing the cultivation of potatoes and the production of industrial alcohol in Ireland under a co-operative system are discussed at length by R. N. Tweedy in a pamphlet published in 1917.⁸ The total production of potatoes in Ireland in 1914, in round figures, was 3.4 million tons. This represented an area of approximately 580,000 acres. The whole of the potato crop, if converted into alcohol, would have yielded 75 million gallons, equivalent to roughly one-third of the petrol at present imported into the United Kingdom, or to the annual pre-war production of alcohol in Germany. As none of the existing potato crop can possibly be spared for this purpose, a very large additional acreage would have to be brought under cultivation to supply even a fraction of the motor-fuel requirements of this country. Moreover, this acreage must be from three to four times larger than that required for the potatoes if the usual crop rotation is to be allowed for.

An extension of arable cultivation in the United Kingdom is greatly to be desired in the interests of agriculture and of the general welfare of the country, and the organisation of an alcohol industry on co-operative lines similar to those suggested by Tweedy would undoubtedly be of the greatest assistance in promoting this object. But such an industry must be considered as forming an integral part of a comprehensive and far-reaching scheme for agricultural development, implying the resettlement on the land of a large proportion of the population. If one can draw conclusions from continental experience the cultivation of potatoes in this country on a large scale with the primary object of producing power alcohol would undoubtedly demand heavy State subvention, and would not, under present conditions, be commercially practicable.

Cassava⁹ (*Manihot utilissima* and *M. palmata*) is a branched shrub which reaches a height of 6 to 12 feet, and forms large root tubers from $1\frac{1}{2}$ to 4 feet long and $1\frac{1}{2}$ to $2\frac{1}{2}$ inches in diameter. The fresh tubers contain from 21 to 30 per cent. of starch and 5 per cent. of sugar, and are the source of the tapioca of commerce. *M. utilis-*
sima or "bitter" cassava is the species most widely grown through-

out the tropics, and is characterised by a high content of prussic acid (up to 0.03 per cent.) in all parts of the root. *M. palmata* or "sweet" cassava contains prussic acid only in the outer cortical layer, and is possibly merely a variety of the bitter form evolved by cultivation. The plant is sensitive to cold and is easily killed by slight frost. The area over which it can be grown is therefore restricted to tropical districts. It succeeds best in dry sandy soils with little rainfall and will withstand prolonged and extreme drought without injury, properties which render it a valuable food stuff in many localities. The yield of roots varies with the character of the soil. On poor soils it may not be more than 2 to 2½ tons per acre, while in the United States as much as 15 tons has been obtained on an exceptionally good soil. An average yield would be about 9 tons per acre, or half as much again as that of potatoes in this country. The plant is propagated by cuttings and the crop is ready for harvesting at from eight to fifteen months after planting. On good land several successive crops may be grown, but after this the soil deteriorates rapidly unless a proper system of crop rotation is practised. In West Africa, maize or sorghum and leguminous crops are grown in rotation with cassava. In countries where sugar cane is cultivated, this may with advantage be introduced into the rotation. Thus at least two-thirds of the cultivated area would be constantly under a starch- or sugar-yielding crop, the remaining third being occupied by ground-nuts or beans. The yield of 95 per cent. alcohol from 1 ton of roots would be from 35 to 40 gallons, as compared with 21 gallons from a ton of potatoes. Per acre of land the yield would be about 330 gallons, the corresponding figure for potatoes being 137 gallons.

Cassava possesses the disadvantage, common to many root crops, of requiring considerable manual labour for cultivation and harvesting. The tubers are long and spreading, and can only be ploughed out with difficulty. Usually it is necessary to pull them up by hand or dig them out. They quickly decay after harvesting, and cannot be stored for subsequent distillation unless thoroughly dried. In 1913, dried cassava roots exported to France from the French colonies were valued at about £5 to £6 per ton. This would correspond to approximately £1, 10s. to £1, 16s. per ton for the fresh roots. At this figure the raw material for one gallon of 95 per cent. alcohol would cost about 1s., corresponding with maize at £4, 6s. per ton.

The **Jerusalem Artichoke** (*Helianthus tuberosus*) forms elongated tubers in size about equal to potatoes. The tubers contain on an average 15 per cent. of reducing sugars and 2 per cent. of inulin, a starch-like body which is hydrolysed to lævulose by dilute acids. The yield of alcohol from fresh tubers varies from 15 to 22

gallons per ton. The weight of crop per acre is approximately equal to that of potatoes, varying from 5 up to 15 tons, according to soil and method of cultivation. Some estimates are as high as 30 tons per acre (Desborough). The artichoke possesses distinct advantages over the potato in that it is not, as far as is known, so liable to disease. It can therefore be grown on the same ground for several years in succession, and the tubers can be left in the ground for several months after maturity until required.

The cost of manufacture of alcohol from artichokes should prove distinctly less than from starchy materials. According to Windisch,¹⁰ the mash can be fermented with yeast without previous acid conversion or treatment with malt. The tubers are finely pulped and mixed with water to form a somewhat fluid mash. This mash can then be pitched direct with 0.5 kgm. of pressed yeast per 100 kgm. of artichokes, and the fermentation proceeds smoothly at a temperature not exceeding 30° C. Unless the artichokes are steamed before mashing or the mash heated, it would seem that the inulin is only partially hydrolysed to fermentable sugars. According to Maercker they should be steamed in a Henze digester for 2½ hours, but Rüdiger¹¹ found that the yield was reduced by heating the mash to 75°–100° C. On the other hand, the yield of alcohol was increased by about 6 per cent. by heating the mash to 55° C. for one hour, and still more by heating with dilute mineral acids. In certain distilleries where artichokes have been used it is customary to treat them in exactly the same way as sugar beets—either pulping them and pressing out the juice or cutting them into chips and extracting the juice in diffusion batteries. Dieck and Tollens found that acidification with sulphuric acid before pressing increased the yield of alcohol by 10 per cent.

Desborough¹² gives £28 per acre as the cost in 1920 of mass cultivation of artichokes. At 5 tons per acre the cost of raw material for 1 gallon of 95 per cent. alcohol would, therefore, be about 6s., and at 25 tons to the acre about 1s. 2½d. He quotes the case of a small holder who has grown an average of 14 tons of artichokes per acre on reclaimed sandy land for five years. Taking the above figure for the cost of mass cultivation, this would correspond to 2s. 2d. as the cost of raw material for 1 gallon of alcohol.

Another species of *Helianthus* (*Polymnia edulis*) is now the subject of experiment in this country and in France.¹³ This plant grows in the Andes at an altitude of 6000 feet. It is said to produce tubers of from 0.5 to 2 lb. weight, and to have a sugar content of over 10 per cent.

The **Sweet Potato** (*Ipomœa Batatas*) is a small climbing plant with tuberous roots and is largely grown in the Azores, where it is used for making an alcohol of fine quality, said to be employed for fortifying Spanish and Portuguese wines. It is also cultivated in the Southern States, where a yield of 5 tons per acre is sometimes obtained. The average yield is given as somewhat less than 4 tons per acre.¹⁴ The content of fermentable carbohydrates is about 27 per cent., of which approximately one-fifth consists of sugars. A ton of sweet potatoes should therefore yield about 35 gallons of 95 per cent. alcohol, and the yield of spirit per acre would be approximately 140 gallons, or about the same as potatoes. The tubers are somewhat more fibrous than the ordinary potato, but experiments carried out in the United States indicate that both can be mashed in the same way for the production of alcohol.

Sweet potatoes contain a certain amount of diastase, and it is possible to convert nearly all of the starch into soluble carbohydrates by mashing with water.¹⁵

The **Yams** are species of *Dioscorea*, climbing plants with underground tubers like potatoes. There are a large number of species, the tubers varying from a few ounces up to 40 lb. in weight. The average weight of crop per acre is 4 to 5 tons, and the yield of alcohol may be taken as approximately the same as from potatoes. Yams are used as a food stuff in many tropical countries, but are grown on a comparatively small scale, and few data are available as to the possibility of cultivating them extensively for alcohol production.

Roots.—The **Sugar Beet** is grown mainly in Germany, Austria, Russia, France, and the United States. Before the war, beet sugar formed very nearly half of the world's sugar supply, and of the total output of beet sugar 30 per cent. was contributed by Germany. Attempts are now being made to found a beet sugar industry in this country, and it has been proved that British-grown beets are equal both in cropping power and in sugar content to those produced on the Continent.

The sugar beet contains about 14 to 17 per cent. of sucrose, and the yield of topped and washed roots per acre is 10 to 20 tons. Beets grown on an experimental scale in the West of England¹⁶ have given an average of 18 per cent. sucrose, with a yield per acre of 11 to 15 tons, but in the eastern counties the crop, although of equal or even higher sugar content up to 20 per cent., is not so heavy. In the Midlands, yields of over 18 tons per acre have been obtained.¹⁷

In general, sugar beets succeed best on a fairly heavy loam. The root must be kept well earthed up to the crown during growth

and not allowed to protrude from the earth and become green from exposure to light, otherwise the sugar content is adversely affected. Moreover, the better and more uniform the shape of the roots, the higher is the yield of sugar and the easier the manipulation of the beets in the factory. Stony or compact soil interferes with the penetration of the taproot and leads to malformed roots. It is obvious, therefore, that deep cultivation is essential. For this reason the beet crop is beneficial to the land and brings it into excellent condition for other crops. In the western districts of Germany the sugar beet and the sugar factory occupy much the same place in the agricultural system as do the potato and the distillery in the eastern provinces. Although it is stated that it occupies less than 2 per cent. of the cultivated ground, it is considered by some that the present high efficiency of agriculture in western Germany would not have been attained without it.

The production of alcohol from beets has not been developed to any considerable extent in Germany, owing largely to the tax on fermenting-vat capacity which was in operation until the year 1909. The ratio of non-sugars to fermentable matter is high compared with starchy materials such as grain and potatoes, and the yield of alcohol from a given vat capacity was too low to allow of beets competing with potatoes in the distillery. It is true that during the war, owing to the shortage of potatoes, the agricultural distilleries were forced to use beets, but with the return to peace conditions, preferential treatment has been reintroduced for potato spirit, and similar concessions can only be obtained for beet provided that the crops used are surplus to sugar requirements.¹⁸

In France, on the other hand, by far the greater portion of the industrial alcohol produced is derived from beets. For this purpose roots can be used which give a high yield per acre, and a correspondingly greater proportion of non-sugars. These non-sugars, while they would interfere with the extraction of crystallisable sugar, do not affect the value of the beet for fermentation purposes, and have the advantage of producing a larger quantity of residuals for use as feeding stuffs, for which purpose the extracted pulp is largely used. The yield of alcohol obtained from beets in the most efficient French distilleries averages 134 gallons of absolute alcohol per ton of fermentable carbohydrates,¹⁹ corresponding to 88 per cent. of the theoretical yield. Taking the average sugar content of beets as 15 per cent. and the yield per acre 14 tons, this would correspond to 21 gallons of 95 per cent. alcohol per ton and 294 gallons per acre.

If the value of sugar beet be taken as £1 per ton at the distillery, the cost of the raw material for 1 gallon of 95 per cent. alcohol

would be approximately 1s. In 1912 the average price of beet in France was somewhat higher than this, about 32 fr. per ton, the pulp being valued at 3 fr. per ton as feeding stuff. In 1917 the price of sugar beet at one of the Australian Government sugar factories was £1, 7s. 6d. per ton, which would be equivalent to 1s. 3½d. for the raw material necessary for 1 gallon of alcohol.

In the Midland counties of England beets are now being grown on quite a considerable scale for the production of sugar. The cost per acre of 12 tons, with an average sugar content as high as 20 per cent., is given as £29, 3s. 4d., which would correspond to 1s. 8½d. as the cost of the raw material required for 1 gallon of 95 per cent. alcohol.²⁰

The cultivation of beet for alcohol has had very much the same effect on agriculture in France as has that of the potato in Germany. The improved methods of sugar extraction and fermentation introduced by Champonnois in 1854 led to the establishment of a large number of agricultural distilleries and to largely increased beet cultivation. In 1864 the Association of French Agricultural Distillers obtained data regarding the agricultural development of 500 farms for ten years subsequent to the installation of beet distilleries.²¹ The results, although no doubt influenced by other factors besides the increased cultivation of beet, indicated clearly that the growth of the distilling industry had coincided with a remarkable increase in agricultural prosperity.

DEVELOPMENT OF AGRICULTURE ON FIVE HUNDRED
SELECTED FRENCH FARMS

	Acres under Beet.	Acres under Wheat.	Yield of Wheat per Acre in Tons.	Number of Store and Dairy Cattle.	Number of Fat Stock.	Total Number of Agricultural Workers.	
						Summer.	Winter.
Period up to 1854—no Beet Distilleries	4,816	54,130	0.60	25,386	6,955	9,851	767 4,
Year 1864—ten years after establishment of Beet Distilleries	52,890	68,130	0.85	51,449	46,645	25,735	14,718

The French beet distilleries are run largely on the co-operative principle, the farmers having a pecuniary interest in the distillery and entering into an undertaking to cultivate a certain minimum acreage of beet, but in spite of a bounty of approximately 4d. per gallon on denatured alcohol, the industry has not developed to the same extent as has the German potato spirit industry. The average

production of industrial alcohol in France from all sources for the five years 1909 to 1913 was 14.7 million gallons as against 34.9 million in Germany.

Mangolds are a variety of beet (*Beta vulgaris*) and are grown extensively in this country as a fodder crop. They differ from sugar beet in having a much smaller sugar content while giving a heavier yield per acre. The percentage of sugar in the topped and washed roots averages 5 per cent., while the variety termed "sugar mangold" contains 8 to 9 per cent. The average yield per acre for the United Kingdom in 1918 was 20 tons, but in many localities much heavier crops, up to 60 to 90 tons per acre, are often obtained. Thus one acre of mangolds would produce upwards of 140 gallons of 95 per cent. alcohol.

While a beet-root weighs on an average 2 lb., mangolds run from 4 to 7 lb. or more. When grown for fodder, the cultivation is not so deep as that usual for sugar beet, and the upper part of the root is not covered with soil. There is no doubt that by careful selection of varieties and deeper cultivation the content of sugar could be greatly increased. At the pre-war price of 11s. per ton the raw material for 1 gallon of alcohol would cost approximately 1s. 7d., but the low percentage of sugar compared with beet would mean a higher cost of manufacture, owing to the much greater weight of material to be dealt with per gallon of alcohol.

In the sugar beet the non-saccharine constituents amount to about two-fifths of the total solids of the root, the remainder being sucrose, and in mangolds the non-fermentable constituents usually amount to about half of the dry matter. There is therefore a considerable weight of residuals to be dealt with for a given quantity of alcohol. The economic utilisation of root crops, and especially mangolds, on a large scale as a source of alcohol would depend very largely upon the outlets for these residuals and the extent to which they could be disposed of as feeding stuffs or returned to the soil as manure.

Sugar Cane.—The sugar cane is widely cultivated in the tropics, mainly in Cuba, India, Java, and the British West India Islands. It grows to a height of 6 to 12 feet, and matures in from twelve to eighteen months from the time of planting, or in countries with a cold season, in eight to nine months. The canes are then cut close to the ground and the stumps are left in the ground to sprout and form new shoots termed "ratoons." The ratoons are again cut and produce second ratoons, and so on. Canes are replanted, according to soil and climate, every two to seven or more years. Occasionally, as in Venezuela, ratooning goes on for as long as fifty years. It is therefore difficult to arrive at an estimate

of the yield per acre, as the ratoon crop gives a much lower yield of sugar than the original cane. The first crop represents a total weight of 30 to 40 tons per acre, containing 11 to 16 per cent. of sugar. Taking 35 tons as the average, containing 13 per cent. of extractable sugar, this would correspond to 4.55 tons of sugar per acre, equivalent to a yield of 17 gallons of 95 per cent. alcohol per ton of cane or 595 gallons per acre. In Java and Hawaii average yields of 4 to 5 tons of sugar per acre, or even more, are stated to be obtained. In practice, however, over a period of years, there must be taken into consideration the length of time which the cane takes to mature, and the inclusion of one or more ratoon crops, so that the average annual yield of sugar, including that of molasses, is about 2 tons per acre, corresponding to 255 gallons of alcohol.

In Cuba, Java, and Hawaii the sugar cane is cultivated on a large scale, the factories being of considerable size and containing the most modern machinery. In the British West Indies the industry is largely in the hands of small proprietors and the factories are smaller and more numerous.²² The industry in the British West Indies had sunk to a low level of prosperity prior to the war, owing largely to the competition of beet sugar and to the lack of centralisation of the factories.

The utilisation of sugar cane as a source of alcohol except as regards molasses is not at present practicable, owing to the demand for cane sugar as a food stuff. This demand has been accentuated in recent years in consequence of the reduced supplies of continental beet sugar. There would seem to be no reason, however, why the area devoted to sugar cane cultivation should not be greatly increased. The yield of alcohol per acre under favourable conditions is as large or larger than that of any other crop. Against this must be set the fact that sugar cane is an exhausting crop, and the residues are not so readily returned to the soil either as manure or indirectly as feeding stuff, as are the residues from potatoes and root crops. Sugar cane "bagasse" or residual fibre forms about one-fourth of the weight of the canes, and can only be utilised as fuel.²³ Its moisture content is high, necessitating partial drying before use, and specially constructed furnaces are required to burn it properly. Owing to the great weight and bulk of the cane harvested per acre, cheap labour and easy means of transport from field to factory would appear to be essential factors if sugar cane is to be

²³ Attempts have been made to utilise "bagasse" as a source of alcohol by hydrolysing it with 1.8 to 2.5 per cent. sulphuric acid for fifty minutes at a pressure of 100 to 125 lb., but the results have not been encouraging. (E. C. Sherrard and G. W. Blanco, *Journ. Ind. Eng. Chem.*, 1920, **12**, 1160.)

cultivated for alcohol. It is estimated that in Queensland the cane delivered at the mill costs about 7s. per ton for cutting and hauling alone, and an additional 2s. 11d. to 7s. 9d. per ton for crushing.²⁴

The world's total production of cane sugar before the war was about 10 million tons. This rose to 12½ million in 1917 to 1918, of which 3¾ million were produced in the British Empire. The total production of beet sugar for the same years was 8¾ and 5 million tons respectively. If the whole sugar supply of the world in 1917 to 1918, both cane and beet, had been converted into alcohol, the quantity produced (2100 million gallons) would have been considerably less than the consumption of petrol in the United States alone for that year.

Sorghum Cane, or saccharine sorghum, is a variety of *Andropogon sorghum* or *S. vulgare*, already referred to among the cereals. The green stalks contain on an average 81.4 per cent. of water, 12.7 per cent. of sucrose, and 1.1 per cent. of reducing sugars.²⁵ The cane cannot readily be used as a source of commercial sucrose, owing to the presence of invert sugar, dextrans, and gums which prevent crystallisation, but it is largely grown in the United States and Australia both as a green fodder and for the production of sorghum syrup. The crop can be grown successfully over a wide tropical and subtropical area. While the varieties grown for grain are suited to hot dry climates, saccharine sorghum succeeds best in districts with a good summer rainfall, or, failing this, efficient irrigation. The average yield under good conditions is about 15 tons of topped and cleaned cane per acre. On the basis of an extraction of juice amounting to 65 per cent. of the weight of the cane, 1 ton would yield 12½ gallons of 95 per cent. alcohol,²⁶ corresponding to a yield of 187 gallons per acre. This estimate was, however, not confirmed in later tests carried out in Australia. In these tests the total extraction of juice averaged only 38 per cent. of the weight of the cleaned cane, and the average yield of alcohol per ton was not more than 6.73 gallons, or 76.4 gallons per acre. It should be possible, by adopting the more powerful machinery used in sugar-cane practice, to raise the percentage extraction considerably. The residual sorghum "megasse" in these experiments still contained about 50 per cent. of the total sugars of the cane.

The value of sorghum on the farm in Australia is placed at 10s. per ton, or 15s. delivered to the distillery. The raw material for 1 gallon of alcohol would therefore cost 1s. 2½d., assuming a 65 per cent. extraction. With more efficient means of extracting the juice, it is estimated that the amount could easily be increased to

75 per cent. of the cane, which would reduce the cost of raw material per gallon of alcohol to 1s. 0½d.

In the U.S.A. approximately 17 million gallons of sorghum syrup were produced in 1900 at an average cost of 9½d. per gallon. One gallon of syrup would yield about 9 lb. of sugar, or approximately 0.5 gallon of absolute alcohol.

In the report of the Advisory Council of Science and Industry of Australia already referred to, the opinion is expressed that sorghum cane deserves favourable consideration as a source of alcohol, and that it is likely to be used for that purpose in the future. It has been suggested that the manufacture of alcohol should be combined with the production of sorghum fibre, which has been found to be well adapted for paper and textile fabrics.²⁷

Molasses.—In the manufacture of cane and beet sugars the extracted juice contains, in addition to sucrose, all the other soluble constituents of the plant, such as gums, pectins, nitrogenous matter, organic acids, and various inorganic salts. Much of the organic matter is removed by precipitation with lime ("defecation"), the lime being subsequently removed by sulphur dioxide or carbonic acid ("carbonatation"). It is not possible to remove the non-sugars completely from the juice, and these accumulate in the mother liquor after evaporation and crystallisation of the sucrose. The mother liquor or molasses still contains about half its weight of sucrose and invert sugar which cannot be crystallised by further concentration. The amount of molasses obtained in the manufacture of cane sugar varies from 19.5 per cent. to 27 per cent. of the weight of cane sugar produced, the difference being due to variations in the purity of the juice, owing to soil, climate, and variety of cane cultivated. The average may be taken as 24 per cent. on the sugar produced.

Cane molasses contains from 25 to 40 per cent. of sucrose and 5 to 30 per cent. of reducing sugars, mainly invert sugar, the average, expressed as dextrose, being about 58 per cent. The water content is 15 to 25 per cent., the remainder being made up of salts and unfermentable organic matter. The molasses obtained in the manufacture of beet sugar amounts to 3 to 4 per cent. on the weight of the roots, or 19.5 to 26 per cent. of the total sugar. Beet molasses contains 48 to 53 per cent. of fermentable sugars, and differs from cane in that the sugar present is mainly sucrose, while cane molasses contains a large proportion of invert sugar.

Several methods have been introduced of late years for the recovery of the sucrose from beet molasses, depending for the most part on precipitation with lime or strontia. These processes are

used only where it is not profitable to utilise the molasses for production of alcohol, so that for practical purposes the molasses available for distillation may be taken as 20 per cent. of the weight of the sugar produced.

Cane and beet molasses constitute one of the cheapest sources of alcohol at the present day. The yield of absolute alcohol per ton is about 69 gallons for cane and 63 for beet molasses, and the actual cost of the raw material at the sugar factory is low. Heriot²⁸ estimated that the maximum cost of cane molasses in 1915 was 4d. per gallon, and in many localities it is practically a waste product of no value. In Australia the price was estimated to be about 2d. per Imperial gallon in 1918. The chief item of expense in the manufacture of molasses spirit is fuel. The cost of manufacture in 1915 is given by Heriot as varying from 5d. per Imperial gallon of alcohol in the United States to 6d. in Hawaii and Cuba.

The quantity of alcohol available from this source is limited by the extent of the sugar crop. The total production of cane sugar in 1917 to 1918 was about 12,500,000 tons, which included about 2½ million tons of the crude Indian sugar termed "gur" or "jaggery," from which no molasses is separated. Deducting this from the total, and taking the average yield of molasses as 24 per cent. of the sugar produced, the total amount of cane molasses produced is roughly 2.4 million tons, with an average content of 57 per cent. of fermentable sugars. Taking a yield of 73 gallons of 95 per cent. alcohol per ton of cane molasses, the total quantity which could be produced from this source would be approximately 620,000 tons, or 170 million gallons. The total production of beet sugar in 1917 to 1918 was 5 million tons, but this was abnormally low owing to conditions caused by the war. The normal production, *i.e.* that of 1913 to 1914, was 8¾ million tons. If the average yield of molasses is taken at 20 per cent. of the total sugar, the possible production of 95 per cent. alcohol from this source would be 116 million gallons.

Molasses is already extensively used for the production of rum. In 1913 it was estimated²⁹ that a quantity of rum equivalent to 14.7 million gallons of absolute alcohol was produced annually from cane molasses, and Deerr estimated the quantity at 15 million gallons. This corresponded to about 12.5 per cent. of the possible production from cane molasses at that time.

Besides being used for the manufacture of rum, molasses, both cane and beet, is in many countries an important raw material for industrial alcohol. In the United Kingdom in 1913 the amount of spirit produced from this source was about 5 million gallons.

In Hawaii the production of alcohol from molasses for use as motor fuel is being developed,³⁰ and it is estimated that about 10 million gallons could be produced from this source. Molasses is also a valuable ingredient of many feeding stuffs. It is often used in a diluted form as a fertiliser for sugar canes, and thus the large amount of potash which it contains is returned to the soil.

The estimated production of "blackstrap" molasses in Cuba in 1920 was 150 million Imperial gallons, of which 17 to 25 million were used locally in the production of fuel alcohol.³¹ The total estimated production of refined sugar in the British Empire in the season 1919 to 1920 was estimated at just over one million tons, and the whole of the resulting molasses would produce about 17 to 18 million gallons of 95 per cent. alcohol.³²

Trees: Mowra Flowers.—Three species of *Bassia* are met with in India, of which the principal one, *Bassia latifolia* (the "Mowra," "Mhowa," or "Mahua" tree), is indigenous to the forests of central India. In southern India and Ceylon its place is taken by *B. longifolia* and in the Himalayan district by *B. butyracea*, the Indian butter tree.³³ *Bassia* seeds are an important article of commerce, yielding the edible fat known as "Illipé butter," which is largely exported to Europe.

Bassia flowers are rich in sugar, and are used extensively in India, either as a food stuff, or for the preparation of a potable spirit called "daru." The flowers, appearing in March and April, have a thick, succulent, globe-shaped corolla of a pale-cream colour, enclosed at the base in a velvety chocolate-coloured calyx. The corollas fall when the fruit sets, and are collected and dried in the sun. The preparation of "daru," as carried out by the Indians, is a somewhat crude process. Jars holding from 10 to 20 gallons are charged with sun-dried flowers, spent wash, and water, and the mixture fermented for three to seven days. The liquor is then distilled in earthenware pots, producing a spirit of 60° to 90° under proof (approximately 6 to 22 per cent. alcohol by volume). By a second distillation the strength can be raised to 25° under proof (43 per cent. alcohol by volume). The spirit thus prepared is rich in fusel oil, containing, according to Elsworth, as much as 3 per cent., and possesses an unpleasant butyraceous odour which may be removed by rectification. The local distillation methods give a yield corresponding to not more than 12 parts by weight of absolute alcohol per 100 parts of dried flowers, but by more efficient methods of fermentation and distillation it has been found possible to obtain twice this quantity. Assuming a 90 per cent. fermentation yield, this would correspond to 52 per cent. of fermentable sugars in the

dried flowers. It has been stated that in some cases as much as 90 gallons of 95 per cent. alcohol have been obtained per ton of dried flowers, or 30 parts by weight of absolute alcohol per 100 parts of raw material.

The composition of the flowers has been investigated at different times with somewhat divergent results.³⁴ The total sugar calculated on the dry material appears to vary from 40 to 70 per cent., and consists of cane sugar 3 to 17 per cent., and invert sugar 40 to 53 per cent. The maximum amount of protein recorded is 7.25 per cent. Owing to the high content of invert sugar, it is not possible to obtain more than a small proportion of the sucrose in the crystalline condition, so that the flowers are of little value as a source of commercial sugar, except for brewing purposes.

The trees take about twenty years to produce flowers and seeds in large quantity, and it is suggested³⁵ that they should be planted about fifteen to twenty to the acre, so that the intervening space can be made use of for other crops, during the period of growth of the trees. A tree will yield 200 to 300 lb. of flowers in a year, but the crops vary considerably, and it would appear that a good crop is obtained only once in three years, which would constitute a serious objection if the flowers were the chief or only raw material available for a distillery. Further, the labour involved in the collection of the flowers is likely to be considerable, although it was reported to the Interdepartmental Committee on Alcohol Motor Fuel that the total cost of collecting and drying the flowers, and delivering them to a factory in the same district, would not amount to more than £1, 10s. per ton.³⁵ An estimate made in 1896 indicated that at least 80,000,000 lb. of dried flowers were consumed locally every year in the Central Provinces. In terms of alcohol this would correspond to about 2,600,000 gallons at 95 per cent. strength. In the State of Hyderabad alone there are sufficient *Bassia* trees for the production of over 400,000 gallons of 95 per cent. alcohol yearly, in addition to that consumed locally. Assuming an average yield of 150 lb. dry flowers per tree, and the trees to be planted twenty to the acre, the yield of 95 per cent. alcohol per acre would be approximately 90 gallons, which is less than that obtained from potatoes and root crops, but more than is given by cereals.

The main disadvantages of this source of alcohol would seem to be the uncertainty of the crop and the long period which must elapse before the trees come into bearing. Moreover, it would seem doubtful whether the cost of collecting the flowers could really be brought down to a figure as low as £1, 10s. per ton. On the other

hand, the expenses of cultivation should not be great, and when once the trees have matured, it should be possible to obtain from this source limited supplies of alcohol at a reasonable cost.

Nipa Palm.—The sap of the Nipa palm (*Nipa fruticans*) is stated to contain about 12 per cent. of recoverable sugar, and from 100 gallons of the sap between 6 and 7 gallons of alcohol can be produced. The Nipa palm grows extensively in the Philippines and in Borneo, the acreage being estimated at 100,000 in the former islands and 300,000 in British North Borneo.

Nipa sap has been used in the Philippines for many years for the production of an alcoholic beverage. In 1913 there were seventy-five distilleries at work with an output of 2 million gallons. The annual yield of sap per acre is given as 3300 Imperial gallons, which would represent a yield of 217 gallons of alcohol per acre and a possible yearly production of about 67 million gallons of 95 per cent. alcohol from British North Borneo alone. It is stated that the average cost of collection of the sap is about 4s. 9d. per 100 gallons, but that it should be possible to reduce this to about 3s. by efficient organisation. Thus the cost of raw material should be about 5½d. per gallon of alcohol. The cost of manufacture is variously estimated at from 9d. per Imperial gallon in the Philippines to 1s. in Borneo. If these estimates are correct, the Nipa palm would appear to constitute a promising source of cheap alcohol.³⁷

Prickly Pear.—Many proposals have been made to utilise the prickly pear (*Opuntia inermis*) as a source of alcohol. This plant, a species of cactus, is widely distributed in subtropical countries, and has become a serious pest in many parts of Australia, where it is estimated to occupy a total area of 22 million acres, and to be spreading at the rate of a million acres per annum.³⁸ The content of fermentable sugar is, however, very small. Investigations made in the United States showed that 140 lb. of the fruit were required to produce 1 gallon of alcohol. If the green parts of the plant be included, the yield of alcohol under the most favourable conditions is only 0.5 per cent. of the material treated.³⁹ When the cost of labour for cutting and collecting the pear, crushing and fermenting, and finally of distilling the alcohol from the weak solution are considered, it does not appear practicable to utilise this material as a source of alcohol. To compete with molasses, prickly pear would have to be delivered to the distillery at a cost of only 2s. 7d. per ton.

The **Zamia Palms** of Australia (*Macrozamia spiralis*, *M. Fraseri*, and *M. Macdonelli*) grow to a height of 2 to 3 feet, sometimes more, and the stems are extremely thick in proportion, up to 2 feet in

diameter. They grow on poor ground, of no value for agricultural purposes, chiefly near the seaboard, and in some localities they form the chief element of the vegetation. The leaf bases and the pith of the stem contain 12 to 13 per cent. of starch, or 57 to 67 per cent. calculated on the dry substance.⁴⁰ It is estimated that 1 ton of the material as collected would yield approximately 18 gallons of 95 per cent. alcohol, but no data are available regarding cost of collection.

In an appendix to a reprint of Bulletin No. 6 of the Advisory Council of Science and Industry, Australia, data are given as to the yield of alcohol from *Zamia* palms in different localities. Great variations were observed, but the average yield from the palms at Bateman's Bay on the south coast was in agreement with the original estimate of 18 gallons per ton.

The **Sago Palm** (*Metroxylon Rumphii*, *Caryota urens*, and other species) is extensively cultivated in the Malay States. Like the *Zamia* palm, the pith is rich in starch, which is washed out and dried, and forms the sago of commerce. The palm is short, growing to a height of only a few feet, and flowers once during its lifetime. The starch content of the pith reaches its maximum just before the flowering stage, having been stored up by the plant for this purpose. It is stated that a scheme is now under consideration for utilising the sago palm in New Guinea as a source of power alcohol.⁴¹

The **Grass Tree** is the name given to various species of *Xanthorrhæa*, peculiar to Australia. The stems yield a fibrous core, containing a variable quantity of fermentable sugars. Trials made in Australia at various periods of the year showed that from 11 to 28 gallons of 95 per cent. alcohol could be obtained per ton of the core, the average being 19 gallons. No details are available regarding cost of collection.

Certain **Lichens** contain a high percentage of carbohydrates, in the form of lichenin, a complex polysaccharide possibly allied to starch. Thus Iceland moss (*Lichen islandicus*) contains about 60 per cent. of lichenin and reindeer moss (*Cladonia rangiferina*) 55 per cent. Lichenin is not converted into sugar by plant diastases, but on treatment with 2.5 per cent. hydrochloric acid or 6 per cent. sulphuric acid, it is hydrolysed mainly to dextrose, the yield of this sugar amounting to 60-66 per cent. of the dry material.⁴² According to Ellrodt and Kunz,⁴³ the maximum yield of alcohol was obtained by steaming the plant for one hour at a pressure of three atmospheres, then adding dilute hydrochloric acid and continuing the heating at the same pressure for another hour. Under these conditions 1 kgm. of the plant gave 282 c.c. of

alcohol, equivalent to 63 gallons per ton. It is stated that enormous quantities of these lichens are available in Sweden, and it was recently proposed to manufacture alcohol from this material on a large scale.⁴⁴ It would seem, however, that the cost of collection of a material of this nature might be considerable.

By treating certain **Seaweeds** such as *Laminaria digitata* with 3 to 5 per cent. sulphuric acid for one hour at 122° C., Kayser obtained a solution which on neutralisation and fermentation yielded 27 gallons of absolute alcohol per ton of the dry weed.⁴⁵ Factories have been erected in Sweden and Norway for the purpose of working up seaweed into various products, among which is a substance similar to size,⁴⁶ but there is no record of the production of alcohol from seaweed on a commercial scale. It is probable that the cost of collecting the weed would be too great.

Various Plants.—Among other plants from which alcohol is produced locally or which might serve as sources of industrial alcohol on a small scale, are the Sotol plant (*Dasyvirion Texanum*), which is abundant in Mexico; Sisal hemp (*Agave rigida*), a native of Yucatan; Arrowroot (*Maranta arundinacea*); Asphodel root (*Asphodelus ramosus* and *A. albus*), found in southern Europe and Algeria, and containing 9.6 to 17.5 per cent. of inulin,⁴⁷ and the sap and flowers of several species of palm. During the war the manufacture of alcohol from horse-chestnuts and acorns was investigated. J. L. Baker and H. F. E. Hulton⁴⁸ found that peeled acorns contained about 44 per cent. of starch, and chestnuts from 15 to 39 per cent. of starch and 7 to 17 per cent. of sucrose, together with a small proportion of reducing sugars. From the dry peeled kernels the yield of absolute alcohol corresponded to 80 gallons per ton, or 32 to 36 gallons per ton of the nuts as picked. It was recognised, however, that the cost of collection of the raw material would be so great that horse-chestnuts and acorns could not be considered as an economic source of alcohol in normal times.

Tabular Summary of Yields.—The different data which have been given for weight of crop per acre and yield of alcohol per ton are summarised in the following table for the more important raw materials containing starch and sugar. The figures are of necessity approximate, since in many cases widely different estimates are met with for the same material.

The yield of 95 per cent. alcohol per ton may be arrived at either on the basis of assuming an average yield of, say, 125 gallons per ton of pure carbohydrates, or by taking the mean of the various data which have been given for each material. In the table the latter method has been adopted.

RAW MATERIALS CONTAINING STARCH AND SUGAR

Material.	Total Fermentable Carbohydrates. Per cent.	Average Crop Yield per Acre in Tons.	Yield of 95 per cent. Alcohol per Ton in Imperial Gallons.	Yield of 95 per cent. Alcohol per Acre in Imperial Gallons.
<i>Cereals—</i>				
Wheat . . .	65	0.5	83	42
Barley . . .	60	0.65	75	49
Rye . . .	64	0.4	80	32
Oats . . .	55	0.6	70	42
Maize . . .	67	0.7	86	60
Sorghum grain . . .	67	0.7	86	60
Rice (cleaned) . . .	76	0.43	85	37
<i>Tubers—</i>				
Potatoes . . .	17.5	6.5	21	137
Cassava . . .	30	9	37	330
Jerusalem artichoke . . .	17	7	19	133
Sweet potato . . .	27	4	35	140
Yam . . .	17	5	20	100
<i>Roots—</i>				
Sugar beet . . .	15	14	21	294
Mangolds . . .	5	20	7	140
Sugar mangolds . . .	8	20	11	220
<i>Sugarcane—</i>				
Sugar cane . . .	13	15	17	255
Sorghum cane . . .	14	15	12.5	187
Molasses (cane) . . .	58	—	73	—
„ (beet) . . .	50	—	66	—
<i>Trees—</i>				
Mowra flowers (dried) . . .	50	1.3	69	90
Nipa palm (sap) . . .	12	15	15	217
Zamia palm (pith) . . .	13	—	18	—
Grass tree (<i>Xanthorrhæa</i>) . . .	—	—	19	—
Horse-chestnuts and acorns . . .	—	—	36	—
<i>Other—</i>				
Iceland and reindeer moss . . .	60	—	63	—
Seaweed (dry) . . .	—	—	28	—

It is evident that although tubers and roots are, as a rule, poor in fermentable carbohydrates compared with cereals, yet this is more than counterbalanced by the great weight of the crops.

Cost of Cultivation.—As already stated (p. 86), the relative value of different raw materials for alcohol production does not

depend only upon yield per ton and per acre. The cost of cultivation is an important factor, and one which varies greatly for different crops. It is clear that the heavier the crop the greater the exhaustion of the nutritive constituents of the soil, necessitating heavier applications of manure. The labour involved in the planting and earthing-up of potatoes and in the thinning and hoeing of beets and mangolds is considerable, while cereal crops do not require the same amount of attention. The lifting, transporting, and handling of 20 tons of mangolds is a more costly proceeding than the harvesting of one ton of grain with its equivalent of straw by modern agricultural machinery.

The great differences in cultivation costs per acre is reflected in the market price of, *e.g.*, barley, potatoes, and mangolds. Before the war the prices of these three crops were approximately £8, £3, and 11s. per ton. If the yields per acre in this country are taken at 0.9, 6.0 and 20 tons respectively, the market price of an acre of produce works out at £7, 4s. for barley, £18 for potatoes, and £11 for mangolds, figures which indicate roughly the ratio between the costs of cultivating a given area. According to figures given by the Board of Agriculture,⁴⁹ the average cultivation costs per acre for these crops on an Irish farm during the period 1914 to 1919 worked out at £6, 8s. for barley, £14, 10s. for potatoes, and £10, 2s. for mangolds. More recent figures given for artichokes⁵⁰ and sugar beet⁵¹ are much higher than this, being £28 and £29 per acre respectively, but these figures appear to be based on economic conditions prevailing in 1920.

Taking the yield of alcohol from barley at 75 gallons per ton, the cost, at pre-war prices, of the raw material for 1 gallon of alcohol was 2s. 1½d. If the same area could be cropped with potatoes or mangolds at the same cost as with barley, the raw material for 1 gallon of potato spirit would be valued at 1s. 1¾d., and for mangold spirit at 1s. Actually, however, the cost of material per gallon of alcohol was 2s. 10d. for potatoes and 1s. 7d. for mangolds, so that potato spirit was more expensive than grain spirit. These figures are approximate, but they serve to show that the crop which gives the highest yield of alcohol per acre is not necessarily the cheapest source of alcohol, and that the controlling factor is the cost of producing and delivering to the factory a unit of fermentable carbohydrates.

Alcohol and Petrol: Comparison of Costs.—The retail price of petrol, which in September 1921 was 4s. 3d. per gallon, including 6d. duty, and now stands at about 2s. 6d. per gallon free of duty, includes, besides the actual cost of production, all the charges incurred in freight and distribution. These charges were subjected

to a critical examination by a sub-committee appointed by the Standing Committee on the Investigation of Prices. The figures arrived at are given in the Committee's two Reports on Motor Fuel, published in 1920 and 1921,⁵² and may be compared with corresponding estimates given by one of the petrol importing companies :⁵³

	Committee's Estimate.	Importer's Estimate.
Freight and marine charges	3d.	5d.
Distribution charges . .	7·5d.	8·5d.
Garage remuneration . .	4d.	4·5d.
Profit on distribution . .	1·5d.	1·5d.
	16·0d.	19·5d.

These figures must, no doubt, be reduced somewhat, in conformity with the recent fall in prices ; but for the present purpose it may be assumed that 1s. 4d. per gallon is a fair estimate of the charges incurred between the refinery and the consumer, and that similar charges would be operative in the case of alcohol.

The Committee found it difficult to arrive at the actual cost of production of petrol and delivery to seaboard in the country of origin, but estimated it to be not more than 10d. per gallon, or allowing for the rate of exchange, 1s. 0½d. per gallon. This sum apparently includes all overhead charges, and may be considered, in default of more accurate data, as the maximum cost of production. According to some estimates the actual cost is as low as 6d. or 7d. per gallon.

The cost of manufacture of alcohol, apart altogether from that of the raw material, is estimated to be about 9d. per gallon. To this must be added a certain amount, say 5d., for interest on capital, and for denaturation and Excise supervision.⁵⁴ It is clear, therefore, that even assuming the raw material to cost nothing at all, it would be barely possible for alcohol to compete commercially with petrol provided that the supplies of the latter were adequate and the price were reduced to the lowest possible level. The cost of alcohol must be considered from the standpoint that it is a supplementary and not a competitive fuel, and that its rôle is not to drive petrol off the market, but to provide an alternative in the event of an actual and permanent shortage of supplies. From this point of

⁵⁴ In this connection the effect of the differential duties and allowances in respect of foreign, Empire, and home-produced alcohol should be noted (cf. p. 198).

view the economic price may be calculated on a more liberal basis.

The price of petrol f.o.b. at U.S.A. ports was stated to be 2s. 2d. per Imperial gallon in September 1920. This figure was the same as the retail price in America at that time, and was considered by the Standing Committee on the Investigation of Prices to be far in excess of the actual cost of production and delivery to seaboard. For purposes of comparison, however, it may be taken arbitrarily as the maximum cost allowable for alcohol at the distillery or port of shipment. Deducting 9d. for cost of manufacture, including depreciation of plant, and 5d., which is probably a low estimate, for interest on capital, cost of denaturation and Excise supervision, there remains 1s. as the maximum allowable cost of the raw material necessary for 1 gallon of 95 per cent. alcohol. On this basis the cost per ton of the chief raw materials, taking the figures already given in the table on p. 115, must fall within the following limits, if the retail price of power alcohol is not to exceed 3s. 6d. per gallon :

	Per ton.
	£ s. d.
Barley	3 15 0
Maize	4 6 0
Sorghum grain)	
Potatoes	1 1 0
Cassava	1 17 0
Artichokes	0 19 0
Sugar cane	0 17 0
Sugar beet	1 1 0
Mangolds	0 7 0
Sugar mangolds	0 11 0
Molasses (cane)	3 13 0
Molasses (beet)	3 6 0

Present wholesale prices ⁵⁵ for these materials are in most cases two to three times as high as those given above, which would mean that power alcohol would cost the consumer from 4s. 6d. to 5s. 6d.. a gallon. But the prices at present ruling for materials which are used solely as food and feeding stuffs are largely due to abnormal conditions. They cannot fairly be taken as representing the actual cost of cultivating the crops on a large scale and under favourable conditions, and of delivery to a central distillery situated in the immediate neighbourhood. It has been estimated that it should be possible to grow maize and cassava in certain tropical countries

⁵⁵ It is difficult to make an accurate comparison of costs under the conditions prevailing in 1921 with rapidly falling prices. The figures given must be regarded as of a tentative nature, subject to revision with the return of more stable trade conditions.

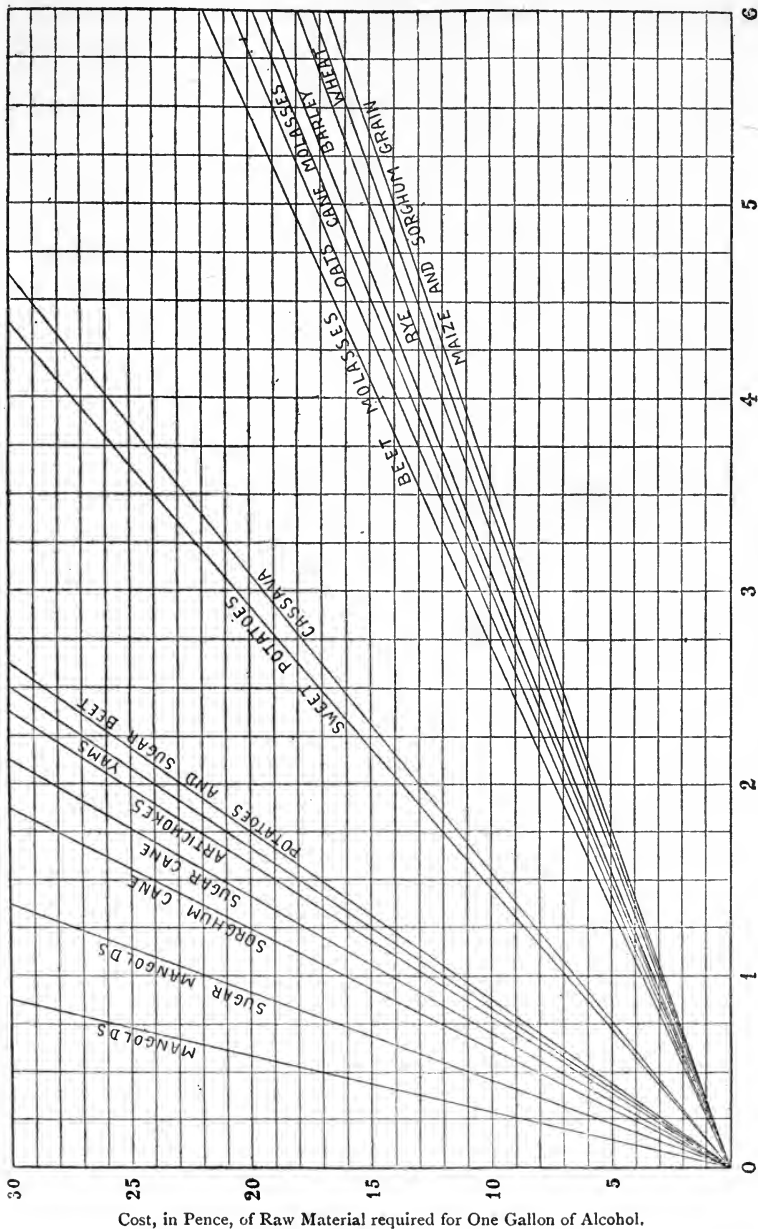

FIG. 16.—Cost of Raw Material necessary for the Manufacture of One Gallon of 95 per cent. Alcohol.

at as low a price as £2 per ton, and that with a rotation consisting principally of maize, cassava, and sugar cane the cost of the raw material for one gallon of alcohol should not on an average exceed 6d., which would mean a retail price of approximately 3s. per gallon. In this connection it may be noted (cf. p. 107) that according to estimates made in Australia⁵⁶ sugar cane delivered at the mill costs on an average 7s. per ton for cutting and hauling alone. If the raw material for one gallon of alcohol is to cost not more than 6d., the maximum allowable figure for cultivation of sugar cane and delivery at the distillery would be 8s. 6d. per ton. By replanting the cane every two years or so, and with the most favourable conditions of soil and climate, the yield of alcohol might be doubled, and the maximum allowable cost be placed at 17s. per ton of cane.

Given the amount of alcohol produced by a ton of raw material, it is a matter of simple calculation to arrive at the cost of the material necessary to produce one gallon of alcohol. It is often of advantage to have the data for different crops in a form which admits of ready comparison, and for this purpose the accompanying diagram (Fig. 16) is useful.⁵⁷ It can be seen, for example, that if the cost of the raw material for one gallon of alcohol is not to exceed 1s. 3d., the corresponding price for maize will be £5, 7s. 6d., for sugar beet and potatoes £1, 6s. 3d., for mangolds 8s. 9d., and so on. Maize at £2, 3s. per ton, cassava at 18s. 6d., and sugar cane at 8s. 6d., would provide material for a gallon of alcohol at a cost of 6d.

Use of Food Stuffs for Alcohol Production.—Many of the raw materials above mentioned are also important food stuffs, and objections have been urged against their being used for alcohol production while the present shortage of food stuffs throughout the world continues. This contention may be sound as applied to present conditions, and as regards land now under cultivation, although it loses much of its force when one considers the extensive areas of productive land planted with rubber and tobacco. But, as is pointed out by Desborough,⁵⁸ the extension of cultivation to areas at present unproductive is not open to the same objections, and when once the food supply is assured, there can be no reason why further land should not be cropped with food stuffs for other purposes. In fact, it is obvious that the production of power alcohol by the fermentation of starch and sugar on anything like a large scale, must involve the cultivation of extensive additional areas.

It is instructive in this connection to compare the alcohol value of the whole of the cereals, potatoes, and mangolds produced in this country and imported from abroad with the annual consumption of motor spirit. The average annual production of cereals of all kinds, potatoes and mangolds, in the United Kingdom from 1909 to

ECONOMICS OF ALCOHOL PRODUCTION 121

1913 would, if the whole of it had been converted into 95 per cent. alcohol, have produced about 600 million gallons. If imported food stuffs are included, thus giving the total quantity of these crops consumed annually in this country either as human or animal food, the alcohol value is approximately 1500 million gallons. The quantity of petrol imported into the United Kingdom in 1920 was 208 million gallons, and it is highly probable that this amount will increase considerably in future years. It is clear, therefore, than in order to produce a supply of power alcohol equivalent to the present consumption of petrol, the additional acreage to be brought under cultivation would bear quite a considerable relation to that now utilised for the country's food supply.

ALCOHOL VALUE IN MILLIONS OF GALLONS. AVERAGE OF
1906 TO 1913

	Home Produce.	Imported.	Total.
Cereals . . .	460	832	1308
Potatoes . . .	84	5	89
Mangolds . . .	70	—	70
Total . . .	614	837	1467

Experiments on the reclamation of waste land for the purpose of alcohol production are now being carried out at the Royal Naval Cordite Factory, Holton Heath, and the results will be awaited with interest. If it proves possible to grow 14 to 15 tons or more of artichokes per acre on the same ground over a number of years, the cost of raw material for one gallon of alcohol might be brought down to the neighbourhood of 1s. Desborough puts the cost of cultivation of artichokes at £28 per acre, but possibly this is rather a high estimate for the present time.

In any case it would seem that conditions in this country are not favourable to the production of more than a small quantity of power alcohol, and that the greater part must come from overseas.

The suggestion which has been made, that surplus or damaged crops should be utilised for conversion into alcohol, is open to several objections. The supplies of such material are uncertain, and a distillery which depended mainly upon surplus crops would be operating intermittently, with the result that overhead charges would represent too high a proportion of the cost of manufacture. Damaged and unsound agricultural produce is liable to deteriorate still further on storage, and for a distillery working on annual crops

it is important that the raw material be capable of being stored throughout the distilling season. Otherwise the capacity of the plant is overtaxed at the time of harvest, and it remains idle during a great part of the year. At the same time there would be undoubted advantages in having the distillery so situated and designed that full use could be made of any supplies of surplus or damaged material which might from time to time be available.

Chief Factors affecting Alcohol Production in the Tropics.—

The factors which are likely to control the successful development of the alcohol industry in the tropics have been summarised by W. R. Ormandy in a paper read before the Fuels Section of the Imperial Motor Transport Conference in 1920, in which the main considerations regarding crop rotation, supplies of fuel and labour, distillation, denaturation, and transport were reviewed.

The rotation of different crops is one of the most important points to be considered. No crop can be grown successfully for many years in succession on the same ground, and provision must be made for its replacement during at least two out of every three seasons by others of a different character. The crops selected must be suited to the soil and climate. It is not always the case that all of the chief starch- and sugar-yielding crops of the tropics can be grown successfully in the same locality, and a selection must be made of those crops which will give the best results under the conditions existing. Leguminous and oil-producing plants might also be introduced into the rotation, and it would no doubt be advantageous if the area were developed with a view to the production of food stuffs and other commodities in addition to alcohol.

Transport is one of the chief difficulties in many undeveloped countries. The ideal position for a central distillery would be close to the seaboard on the banks of a navigable river, so that the raw material could be sent down from the interior by water, and the finished product shipped with a minimum of handling.

The water supply for a distillery is an important consideration, and it is often difficult in tropical countries to obtain an adequate supply of cold fresh water for cooling the wort before fermentation and for condensing the distillates. Lack of sufficient cold water may result in a diminished yield of alcohol per ton of raw material. It was, in fact, found, when working the Classen process in South Carolina, that one of the chief factors in reducing the average output of the distillery was the high temperature prevailing during the summer months and the lack of refrigerating plant (p. 141).

Fuel supply is also a matter of great importance, since this is one of the main items contributing towards the cost of manufacture. Every gallon of 95 per cent. alcohol requires the

expenditure of about 15 lb. of coal, which would represent roughly 2d. to 3d. per gallon in this country and considerably more in localities where coal is not readily obtainable. In tropical countries wood, scrub, or the refuse from the crops must usually constitute the main fuel supply, and much progress has already been made in the design of producers, capable of converting vegetable matter of the most varied description into a gas of high calorific power.⁵⁹

Another important consideration is the supply of labour. It has been said that the labour difficulty is one of the greatest that confront any one proposing to start agricultural enterprises in the tropics.⁶⁰ Native labour is becoming more expensive, and in many countries the natives will not undertake agricultural work. To establish an alcohol industry on a large scale the necessary labour would in many cases have to be introduced from elsewhere.

The industry would be organised, according to local conditions, either as one large concern with one or more central distilleries, and a staff of European superintendents controlling native labour, or on a co-operative basis, the planters and farmers of the district contracting to supply a certain quantity of raw material in return for an assured market and a stable price. Large central factories would probably be preferable to a system of small agricultural distilleries, not only on account of the lower cost of manufacture, but also owing to the difficulties of effective Excise supervision in a large area with a native population.

The production of cheap alcohol from farm crops depends to some extent on the existence of a profitable outlet as feeding stuffs for the distillery residues. In undeveloped or thinly populated countries, with a comparatively small number of live stock, there may be little demand for feeding stuffs, and it would probably not be remunerative to dry or compress the residues for transport to stock-raising districts.

The transport of alcohol in tank steamers presents further problems which will have to be considered in connection with any large scheme for tropical distilleries. The average annual production for a distillery of fair size may be taken as 1 million gallons of 95 per cent. alcohol per annum, or about 3600 tons, representing the annual produce of, say, 5000 acres, or 8 square miles, of cultivated ground. A modern tank steamer will take in one trip as much as three times this quantity. It would not be economical to employ tank steamers exclusively for the transport of alcohol unless supplies could be drawn from a large area and from several distilleries.

Incidentally a point to be considered is the corrosive effect of denatured alcohol on sheet iron, which was noticed during the trials

carried out in 1919 by the London General Omnibus Company (p. 297). It was found that iron and steel were badly attacked by alcohol and by benzol-alcohol mixtures, and that the fuel tanks and pipes must be coated inside with lead or with a tin-lead alloy. This corrosive action was found by Heinzelmann (p. 267) to be due largely to the presence of esters in the wood naphtha used as a denaturant. It might have an important bearing on the construction of tank steamers used for the transport of denatured alcohol in bulk, unless a denaturant other than wood-naphtha be used.

The production of power alcohol in tropical countries may assume considerable importance in connection with commercial aviation. Trans-continental aircraft routes are dependent on a chain of aerodromes or depôts at which supplies of fuel can be stored. These aerodromes must often be so situated that petrol cannot be carried to them from the coast except at a prohibitive cost. A case in point would be the aircraft route from Egypt to the Cape. A number of distilleries, established in conjunction with the aerodromes, and drawing their supplies of raw material from the surrounding country, would undoubtedly furnish the cheapest and most easily accessible fuel for a regular air service.

It seems probable that the use of alcohol for power purposes is more likely to be successful at first as a local industry. In countries possessing a sufficiently cheap and abundant supply of raw material, or where the price of petrol, owing to distance from the seaboard, transport difficulties, etc., is abnormally high, the conditions may be particularly favourable for the replacement of petrol by alcohol. Production on a large scale for export to this country is a more formidable proposition. In addition to the question of cost of production as compared with petrol, the framing of Excise regulations so as to permit of overseas trade in duty-free alcohol is a far more difficult matter than the modification of local Excise laws in the country of origin.

Cellulose Materials.—The raw materials so far considered have been dealt with as potential sources of alcohol on the basis of their starch or sugar content, without reference to the cellulose, which in many cases forms a large proportion of the plant. By hydrolysis with concentrated mineral acids cellulose can be made to yield a high proportion of fermentable sugars, but the use of concentrated acids on the large scale is far too costly unless the acid can be readily recovered. By heating under pressure with dilute acids a smaller proportion, somewhat less than 30 per cent., of the actual cellulose is hydrolysed to fermentable sugars. Processes depending on the hydrolysis of cellulose have been in

operation for several years in America and other timber-producing countries. So far, these processes have been chiefly concerned with sawdust and wood waste, but the utilisation of cereal straws, such as rice straw in Burma, is now being attempted. The alcohol obtained from wood is only partly derived from the cellulose, a considerable proportion being due to sugars or polysaccharides associated with cellulose in the wood substance. In the fermentation of waste liquor from the manufacture of sulphite pulp, it is probable that none of the alcohol is actually derived from cellulose itself, but in view of the character of the raw material and the methods employed, all processes in which cellulose materials are utilised are conveniently placed in a separate group and will be dealt with in detail in a subsequent chapter.

Since cellulose is an important constituent of many starch- and sugar-yielding plants, the development of processes for the conversion of this substance into fermentable sugars may eventually have an important influence on the economic production of alcohol from cultivated crops.

The quantity of 95 per cent. alcohol obtainable from wood waste under the most favourable conditions is 33 to 36 Imperial gallons per ton of dry wood. In practice on a commercial scale the average is about 15 to 17 gallons. If a similar yield could be obtained by the acid hydrolysis of cereal straws, artichoke stalks, and the woody parts of other starch- and sugar-yielding crops, this would represent a considerable addition to the total quantity of alcohol obtained, and the cost of raw material per gallon would be appreciably lowered. Thus maize yields approximately equal weights of grain and dry straw per acre. Wheat yields 1.7 parts of dry straw to 1 part of grain, while barley and oats lie between these limits.

The hydrolysis of cellulose under different conditions has been little investigated from the scientific standpoint, and there is every reason to anticipate that great advances may be made both in yield of fermentable sugars and in reduction of cost. A further possibility lies in the treatment of cellulose by biochemical means, and in breaking it down into fermentable sugars by the agency of bacteria or moulds on lines analogous to the amylo process for starch conversion. As far as is known at present the conversion of cellulose into sugar does not occur in nature. Starch, being a material which is held in reserve for the needs of the growing plant, is capable of being hydrolysed by naturally occurring enzymes into soluble carbohydrates for transference to other parts of the plant as required. There is no evidence that cellulose is other than a purely structural material. When once formed in the plant, it is apparently not

broken down again, but remains as cellulose until the plant dies and decays. It is therefore perhaps hardly to be wondered at that although cellulose, like starch, is built up mainly of dextrose units, no natural enzyme corresponding to the diastase of germinating seeds has yet been found capable of hydrolysing it to simpler carbohydrates.

Cellulose is broken down by the action of moulds, such as certain species of *Aspergillus* and by bacteria, probably through the agency of enzymes secreted by them. The end products of bacterial decomposition include acetic, butyric, and lactic acids,⁶¹ and the intermediate formation of sugars or alcohol in any appreciable quantity has not been established. It may be possible, as the outcome of further research in this direction, so to control the action of certain organisms as to secure the production of fermentable sugars. In a recent patent⁶² it is claimed that cellulosic material, when inoculated with fermenting vegetable matter and kept under aerobic conditions at a temperature between 25° C. and 60° C., yields ethyl alcohol as one of the principal products of the fermentation, but it is probable that the alcohol is derived in great part from the non-cellulose constituents of the material.

A biological process for the direct conversion of cellulose into sugars on a commercial scale would be of immense importance, and would make it possible to utilise the luxuriant vegetation of the tropics as a source of power alcohol.

As far as starch and sugar are concerned, tropical crops on the whole are not greatly superior to those grown in temperate climates, and the yield of alcohol per acre compares unfavourably in many cases with that of, *e.g.*, sugar beet. The chief advantage possessed by the tropics, apart from cheap labour and the existence of large areas of fertile soil as yet undeveloped, lies in the wealth of vegetation and the rapidity with which it is renewed. This advantage can only be turned to full account by the discovery of some process for converting cellulose directly into fermentable carbohydrates.

REFERENCES

- ¹ and ² T. F. Hunt, *The Cereals in America*, New York and London, 1909.
- ³ *Bull. Imp. Inst.*, 1908, 6, 261.
- ⁴ R. F. Herrick, *Denatured or Industrial Alcohol*, New York, 1907.
- ⁵ P. Vieillard, *Bull. agr. de l'Inst. scient. de Saïgon*, 1920, 2, 106.
- ⁶ B. Viswanath and others, *Mem. Dep. Agric. India*, 1919, 5, 117.
- ⁷ F. Keeble, *Nature*, Oct. 28, 1920, p. 293.
- ⁸ E. Kremers, U.S.A. Department of Agriculture, Bull. No. 182 (1915). "Agricultural Alcohol: Studies of its Manufacture in Germany." Also Report of Departmental Committee on Industrial Alcohol. Cmd. 2477 (1905).

- ⁸ R. N. Twcedy, *Industrial Alcohol*, Dublin, 1917.
- ⁹ *Bull. Imp. Inst.*, 1915, **13**, 581; 1919, **17**, 571.
- ¹⁰ K. Windisch, *Zeitsch. für Spiritus Industrie*, 1920, **43**, 292, 300.
- ¹¹ M. Rüdiger, *Zeitsch. für Spiritus Industrie*, 1920, **43**, 203.
- ¹² and ¹³ A. P. H. Desborough, *Journ. Soc. Chem. Ind.*, 1920, **39**, 302R.
- ¹⁴ *Bull. Imp. Inst.*, 1907, **5**, 171.
- ¹⁵ H. C. Gore, *Journ. Biol. Chem.*, 1920, **44**, 19-20.
- ¹⁶ *Journ. Soc. Chem. Ind.*, 1919, **38**, 290T.
- ¹⁷ J. Golding and H. B. Hutchinson, *Journ. Soc. Chem. Ind.*, 1907, **26**, 512.
- ¹⁸ *Zeitsch. für Spiritus Industrie*, 1920, Nov. 4.
- ¹⁹ D. Sidersky, *Brennereifragen*, Braunschweig, 1914.
- ²⁰ *Journ. Soc. Chem. Ind.*, 1921, **40**, 108R.
- ²¹ D. Sidersky, *loc. cit.*
- ²² J. C. Willis, *Agriculture in the Tropics*, Cambridge, 1909.
- ²⁴ Advisory Council of Science and Industry, Australia, Bull. No. 6, "Power Alcohol," Melbourne, 1918.
- ²⁵ H. W. Wiley, U.S.A. Department of Agriculture, Bureau of Chemistry, Bull. No. 34, "Record of Experiments with Sorghum," 1891.
- ²⁶ Advisory Council of Science and Industry, Australia, Bull. No. 6, "Power Alcohol," 1918; and reprint with appendix, Bull. No. 20 (1921).
- ²⁷ B. Haas, *Zeitsch. für angew. Chemie*, 1918, **31**, 84.
- ²⁸ T. H. P. Heriot, *Journ. Soc. Chem. Ind.*, 1915, **34**, 336.
- ²⁹ *Times Commercial Supplement*, Dec. 1, 1913.
- ³⁰ *U.S. Com. Rep.*, July 2, 1920.
- ³¹ *U.S. Com. Rep.*, March 5, 1921.
- ³² Interim Memorandum by the Fuel Research Board, "Fuel for Motor Transport," 1920.
- ³³ *Bull. Imp. Inst.*, 1919, **17**, 401.
- ³⁴ G. J. Fowler and others, *Journ. Indian Inst. of Science*, 1920, **3**, 81-118.
- ³⁵ G. M. Ryan, *Indian Forester*, 1918, **44**, 302.
- ³⁶ H.M. Petroleum Executive. Report of the Interdepartmental Committee on Various Matters concerning the Production and Utilisation of Alcohol for Power and Traction Purposes. Cmd. 218 (1919).
- ³⁷ U.S. Cons. Rep., *Chem. Trade Journal*, Feb. 20, 1915. *Board of Trade Journal*, Aug. 7, 1919. H. D. Gibbs, *Philippine Journ. Sci.*, 1911, **6**, 99, 147.
- ³⁸ Inst. Science and Industry, Australia, Bull. No. 12 (1919).
- ³⁹ and ⁴⁰ Advisory Council of Science and Industry, Australia, Bull. No. 6 (1918); and reprint with appendix, Bull. No. 20 (1921).
- ⁴¹ *Autocar*, May 21, 1921.
- ⁴² E. Salkowski, *Zeitsch. Physiol. Chem.*, 1919, **104**, 105.
- ⁴³ Ellrodt and Kunz, *Brennerei Zeitung*, 1918, 6171; *Chem. Zeitung*, 1919, **43**, Rep. 40.
- ⁴⁴ *U.S. Com. Rep.*, Dec. 21, 1918.
- ⁴⁵ E. Kayser, *Compt. Rend. Acad. d'Agric.*, 1918, **4**, 450.
- ⁴⁶ *Teknisk Ukeblad*, March 31, 1919.
- ⁴⁷ G. Savini, *Annali Chim. Appl.*, 1919, **11**, 1-5.
- ⁴⁸ J. L. Baker and H. F. E. Hulton, *Analyst*, 1917, **42**, 351.
- ⁴⁹ "The Determination of Farm Costs." Sir John Keane, *Journal of the Board of Agriculture*, 1919, **26**, 891.
- ⁵⁰ A. P. H. Desborough, *Journ. Soc. Chem. Ind.*, 1920, **39**, 302R.
- ⁵¹ *Journ. Soc. Chem. Ind.*, 1921, **40**, 108R.
- ⁵² Cmd. 597 (1920), and 1119 (1921).
- ⁵³ *Autocar*, Sept. 4, 1920, p. 409.

⁵⁶ and ⁵⁷ Advisory Council of Science and Industry, Australia, Bull. No. 6 (1918).

⁵⁸ A. P. H. Desborough, *loc. cit.*

⁵⁹ J. Wells, Paper read before Imperial Motor Transport Council (Fuel Section), Oct. 1920.

⁶⁰ J. C. Willis, *Agriculture in the Tropics*, Cambridge, 1909.

⁶¹ J. Groenewege, *Med. Geneesk Lab. Weltevreden*, 1920, 163-269.

⁶² Power Gas Corporation Ltd. and H. Langwell, Eng. Pats. 134,265 (1918) and 161,294 (1920).

CHAPTER V

ALCOHOL FROM CELLULOSE MATERIALS

The Constituents of Wood.—The main constituent of the structural or woody elements of plants is cellulose, a substance of unknown constitution, possessing approximately the empirical formula $(C_6H_{10}O_5)_n$. Cellulose occurs in nature in many different forms. The purest natural product is the raw cotton fibre, containing about 95 per cent. of cellulose, calculated on the dry fibre. For practical purposes purified cotton cellulose is adopted as the standard or normal type. The celluloses of wood, straw, and similar materials are intimately associated in the plant with a variety of other substances such as lignin, resins, "wood gum," "carbohydrates," and glucosides of various kinds, fats, and proteins. Cross and Bevan have classified the naturally occurring celluloses according to the kinds of non-cellulose material associated with them in the plant :

Lignocelluloses, comprising wood and woody fibres such as jute and straw. These contain cellulose together with a non-cellulosic substance known as "lignin."

Pecto- and mucocelluloses, which consist of cellulose in association with pectins, gums, and mucilages. This group comprises, among other plants, hemp, flax, bamboo, and cotton.

Adipo- and cutocelluloses, in which the cellulose is associated with fats and waxes. In this group are placed cork, and similar substances, typical of the cuticle or epidermal layer of stems and leaves.

It was formerly considered that the removal of the non-cellulose constituents from wood, straw, and fibres left a residue of "true cellulose," a definite chemical substance which was held to be the ultimate structural foundation of all plants. This true cellulose was associated with varying proportions of oxycellulose, hydro-cellulose, and similar modified celluloses formed from the parent substance by oxidation and hydration. A view now held is that the basic celluloses of different plants differ to a greater or less extent in physical characters and in the degree of resistance offered to attack

by different chemical agencies. According to this view there is no such thing as a true cellulose—that is, a structural unit of definite chemical organisation common to all plants.¹

The only one of the above classes with which we are immediately concerned from the standpoint of alcohol production is lignocellulose. In countries such as the United States, Canada, and Sweden, where the timber and wood-pulp industries are highly developed, large quantities of sawdust, waste wood, and sulphite liquor are produced. The disposal, or economic utilisation, of these by-products, especially sulphite liquor, has proved to be a matter of considerable difficulty. It has been known from the early part of the nineteenth century that sugar could be obtained from wood by acid hydrolysis. Many attempts have since been made to obtain alcohol commercially by the fermentation of this sugar, but it is only in recent years that the process has been carried out successfully on a manufacturing scale.

The question as to how the various constituents of wood are related to one another and how they are combined to form the wood fibre is one of great complexity. It is beyond the scope of this book to enter into a detailed discussion of the complicated relationships involved,² but reference may be made to a few of the more important points.

According to Klason,³ the average composition of dry pine wood is :

Cellulose . . .	53 to 55 per cent.
Lignin . . .	29 „ 30 „
Carbohydrates . . .	10 „ 14 „
Resins, fat, and ash . . .	3.3 „ 5 „
Nitrogen . . .	0.1 per cent.

The cellulose and lignin together form the complex known as lignocellulose, while the carbohydrates consist to a great extent of pentosans, and are the main constituents of the so-called “wood gum.”

It is possible by appropriate methods to effect an approximate separation of the cellulose, lignin, and wood gum, but the chemical characteristics of these substances are somewhat indefinite, and it is by no means certain that they exist in the wood in the form in which they are ultimately obtained by extraction or hydrolysis. Lignocellulose must be looked upon as a complex containing various groupings, which offer varying degrees of resistance to the hydrolysing action of different chemical agencies. Under certain conditions, such as the action of strong mineral acids in the cold, the cellulose may be attacked, and suffer progressive degradation, while the lignin complex remains intact. Under other conditions,

such as those obtaining in the sulphite wood-pulp process, lignin may be attacked and split off, leaving a residue consisting mainly of cellulose. Under yet other conditions, such as mild hydrolysis by water or weak alkalies, pentosans and wood gum may be removed, leaving the greater part of the cellulose and lignin unaffected. The separation of the different constituents is never quite complete whatever the method of hydrolysis adopted, and the residue is always more or less modified and has probably yielded up certain of its constituent groups to the hydrolysing agent.

Payen and Sachse considered that lignin formed an incrustation on the cellulose of the wood, while Cross and Bevan, Hoppe-Seyler, and others held, in view of the difficulty of separating the constituents except by reactions involving chemical decomposition, that lignocellulose was a definite chemical compound. Wislicenus and Kleinstück⁴ have advanced the theory that lignocellulose is a colloidal adsorption compound, and that the formation of lignocellulose in plants is due to the deposition of substances from the sap in the form of gel-membranes on the cellulose skeleton. This latter view is the one now generally favoured. J. König⁵ and Willstätter and Zechmeister⁶ have succeeded in removing the cellulose from wood by hydrolysis with either 72 per cent. sulphuric acid or concentrated hydrochloric acid, and thus obtaining a residue of lignin which retains the form and structure of the original cell walls.

Cellulose.—The cellulose constituent has by most investigators been looked upon as the main source of the fermentable hexoses obtained by the hydrolysis of wood with strong acids, and practically all of the constitutional formulæ suggested for cellulose are based upon the idea that it is built up of condensed hexose, or hexose and pentose, units.

If cellulose be treated with strong mineral acids it yields a solution which is optically active and which reduces Fehling's solution. The specific rotation and reducing power correspond closely with the values which would be expected if dextrose were the only product of the hydrolysis. Willstätter and Zechmeister⁷ claimed to have effected a quantitative resolution of cellulose into dextrose by treatment with fuming hydrochloric acid at ordinary temperatures, but they did not isolate crystalline dextrose, and there was always the possibility that a mixture of substances was formed which happened to show a rotation and copper reduction similar to that of dextrose. Ost and Wilkening⁸ studied the action of 72 per cent. sulphuric acid on cellulose, and claimed to have isolated crystalline dextrose in varying yield from the products of hydrolysis, but it would appear that their results, like those of Willstätter, were based largely

on measurements of the rotation and copper reduction of the syrup resulting from hydrolysis.

M. Cunningham,⁹ in a reinvestigation of the cellulose-dextrose relationship, was unable to isolate dextrose from the products of hydrolysis of esparto cellulose with sulphuric acid. She found that when the first products of the reaction were boiled with dilute acid, a procedure which was stated by Ost and Wilkening to result in complete resolution to dextrose, the tendency was for further condensation to take place, rather than hydrolysis. She concluded that no quantitative resolution of cellulose to dextrose had yet been obtained, and that the immediate result of the action of strong acids was the formation of esters of polysaccharides.

It has since been shown, however, that if the action of the sulphuric acid is sufficiently prolonged, and the solution is then highly diluted and boiled for several hours, an approximately quantitative yield of crystalline dextrose can be obtained from cotton cellulose.¹⁰

Definite proof that cellulose is built up mainly of dextrose units has been furnished by the work of J. C. Irvine and C. W. Souttar.¹¹ These investigators found that if cellulose were treated with acetic anhydride and sulphuric acid, the mixture of polysaccharide acetates obtained could be converted by heating with methyl alcohol and hydrochloric acid into a methyl glucoside, which gave pure crystalline dextrose on hydrolysis. The yield of methyl glucoside from cotton cellulose corresponded to 85 per cent. of the theoretical quantity. This method has the advantage over direct acid hydrolysis that by ascertaining the number and position of the substituting groups in the intermediate and final products, information may be gained as to the way in which the dextrose units are combined in the cellulose complex.

Pentosans and Hexosans.—One of the chief characteristics of lignocellulose is the production of furfural and methyl furfural on distillation with mineral acids. This is usually attributed to the presence of pentose sugars, which give a quantitative yield of furfural when treated in this way :

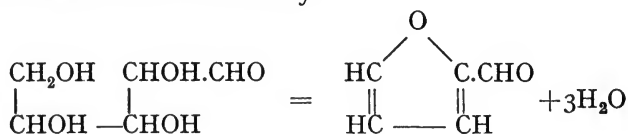

On extracting conifer woods with boiling water and alcohol alternately or with dilute alkalis, a certain portion, about 10 to 14 per cent. (the so-called "wood gum"), goes into solution. From the solution alcohol precipitates a substance known as "xylan"

to the extent of about 25 per cent. of the total extract or about 2.5 to 3.0 per cent. of the wood.¹² Hard woods, such as oak, beech, and elm, yield much larger quantities of wood gum, up to 30 per cent. On hydrolysis xylan yields the pentose sugar xylose, and ultimately furfural. Pentose sugars are optically active and reduce Fehling's solution, but are not fermentable by yeast.

Furfural can be obtained not only from the non-cellulose constituents, but also from the purified cellulose of many plants. The view generally held that pentose sugars or pentosans are the only bodies responsible for the production of furfural has been controverted by Cross and Bevan. They look upon cellulose as an aggregate of atomic groups in a state of flux, and hold that the formation of furfural and dextrose does not imply the presence of preformed pentose and dextrose groupings, but is merely one of the paths by which the labile groups or functions may be thrown out and polarised in a comparatively non-labile form (Briggs).¹³

W. H. Dore¹⁴ has stated that when wood is subjected to hydrolysis in successive stages, so that lignin and xylan are completely removed, the greater part of the furfural-yielding complex remains in the residue.

Wood from conifers contains, in addition to pentosans, a considerable proportion of hexosans, mainly of a type yielding mannose and galactose on hydrolysis. Thus A. W. Schorger and D. F. Smith¹⁵ found that the Western Larch of America (*Larix occidentalis*) contains 10 per cent. of a galactan which yields only galactose on hydrolysis. Galactose is a characteristic constituent of several of the common conifers. It is fermentable by yeast, but only very slowly. Schorger also found that different species of coniferous woods (gymnosperms) yield from 1.5 to 9.2 per cent. of mannan, the sapwood containing more than the heartwood.¹⁶ Klason¹⁷ found 2.5 per cent. of mannose, 7.9 per cent. of dextrose, 1.3 per cent. of galactose, and 4.3 per cent. of arabinose in spruce wood, calculated from the analysis of a sulphite pulp liquor (cf. p. 166). He found that spruce wood contained little or no xylose. Hard woods (angiosperms), although they yield much larger quantities of wood gum and pentosans than conifer woods, do not contain any mannose. The amount of hexose sugars yielded by them is very small in comparison with conifers.

Lignin.—The lignin or "lignone" constituent of wood is characterised by a higher content of carbon than is found in cellulose. Thus Cross and Bevan ascribed to jute lignone the empirical formula $C_{19}H_{22}O_9$. A characteristic property of lignin is its behaviour with chlorine. When lignocellulose is treated with gaseous chlorine, the lignin portion is chlorinated and may be dissolved

out by treatment with alkaline sulphites. The cellulose, although it undergoes a certain amount of modification, is not chlorinated and is left as a residue insoluble in alkaline sulphites. The well-known chlorination process of Cross and Bevan for the estimation of cellulose is based upon this behaviour of lignocelluloses.

These investigators considered that lignin was derived essentially from a keto-R-hexene ring :

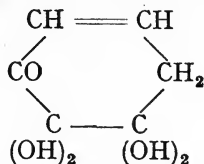

which by reason of its ring structure and the presence of unsaturated groups is susceptible to attack by chlorine gas. This group, in association with a furfural-yielding complex, to which the empirical formula $\text{C}_{13}\text{H}_{16}\text{O}_6$ was assigned, formed the "lignone" or non-cellulose constituent of wood.

Klason has carried out extensive investigations on this subject, and considers that lignin is essentially a condensation product of substances of the type of coniferyl alcohol :

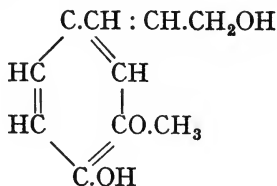

The molecule contains a benzene nucleus substituted in the 1 : 3 : 4 positions, which indicates a possible relationship to protocatechuic acid and the tannins and resins. This view is based upon the remarkable similarity existing between the lignin sulphonic acids found in the waste liquor from the manufacture of sulphite pulp and the substances obtained by the action of sulphur dioxide on coniferyl alcohol.

Klason¹⁸ infers the presence in conifer woods of two different lignins which can be separated from each other by means of their β -naphthylamine sulphonates. The empirical formulæ given for these lignins vary somewhat according to the source from which they are obtained, but they are all apparently derived from coniferyl alcohol or from a hypothetical coniferyl aldehyde. He suggests that lignin may be built up from pentose sugars, with the intermediate formation of dihydroxy-cinnamyl alcohol, a substance possessing a constitutional formula similar to that given above

for coniferyl alcohol, but with an —OH group in place of the —OCH₃ group.

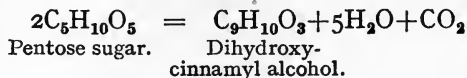

It is possible that lignin may exist in the wood in the form of glucosides, yielding sugars on hydrolysis.

The processes which are in operation for the production of alcohol from wood fall naturally into two main classes, according to whether alcohol is the chief or a subsidiary product. In the first case, sawdust and wood waste are treated in such a way as to secure the maximum conversion of the wood substance including the cellulose into fermentable sugars. In the second case, the primary object is to produce a pure cellulose for paper making, and the alcohol is recovered as a by-product from the non-cellulose constituents which would otherwise be run to waste. The fermentable sugars obtained in the two processes are likely therefore to be different in amount and in the relative preponderance of different individuals according as they are derived mainly from the cellulose or from the non-cellulose.

SAWDUST AND WOOD WASTE

The conversion of certain of the constituents of wood into sugars was first effected by Braconnot¹⁹ in 1819, by treatment with cold 91·5 per cent. sulphuric acid. On diluting and heating the liquid he obtained a saccharine solution. In 1854 Arnould²⁰ repeated Braconnot's observations, using 110 parts of concentrated sulphuric acid per 100 parts of wood, and claimed to have effected the solution of 80 to 90 per cent. of certain kinds of wood. More recently Voerkelius²¹ succeeded in getting a yield of 24·8 parts of alcohol from 100 parts of dry wood by hydrolysis with 70 per cent. sulphuric acid and subsequent fermentation. If we take the cellulose content of dry wood as approximately 50 per cent. and assume a 90 per cent. fermentation yield, this would correspond to a 97 per cent. conversion of cellulose, or a 48·5 per cent. conversion of wood into fermentable sugars. It is highly probable that part of the alcohol was derived from the hexosans of the wood gum, which would make the actual percentage conversion of cellulose considerably lower.

The large quantities of acid which were used and the difficulty of removing the acid from the diluted sugar solution made the commercial application of the process in this form impossible. Attempts to effect the hydrolysis of the wood with dilute sulphuric acid

under pressure were made by Melsens²² in 1855 and by Payen²³ in 1867, but no real progress was made until 1894, when Simonsen²⁴ in Sweden carried out a systematic investigation into the effect of acid concentration, pressure, and time upon the hydrolysis of wood and cellulose. Simonsen, by treating sawdust containing 15 per cent. of moisture with 0.5 per cent. sulphuric acid for a quarter of an hour at a pressure of nine atmospheres, obtained a yield of 26.5 per cent. of sugar calculated on the dry wood, the amount of sugar being estimated from the copper reduction of the liquid, on the assumption that the whole of the reduction was due to dextrose. On fermentation the yield of absolute alcohol was 7.6 litres per 100 kgm. of dry wood, which is slightly less than half the amount which should have been obtained had the reducing sugar consisted wholly of dextrose.

Later experiments by Simonsen gave a yield of 9 litres of absolute alcohol per 100 kgm. of dry wood (20.1 Imperial gallons per ton). No immediate commercial application was made of this process, the reason probably being that he used too great an excess of water, so that the fermented wash contained barely 2 per cent. of alcohol.

About ten years later Koerner²⁵ repeated some of Simonsen's experiments, and, working on the same lines, obtained a yield of 12.8 per cent. of alcohol from wood cellulose (sulphite cellulose), corresponding to about 26 per cent. of fermentable sugars. From dry sawdust the yield was only 6 per cent. of alcohol by weight, or approximately the same as was obtained by Simonsen. He remarked that although the theoretical yield of alcohol from 100 grms. of dry cellulose is 56.8 grms., yet even in the most favourable circumstances not more than 25 per cent. of the theoretical quantity was obtained by simple hydrolysis of the cellulose.

Classen's Sulphurous Acid Process.—In 1899 and 1900 Classen took out a number of patents for the production of alcohol from wood, in which he claimed that by substituting sulphurous acid for dilute sulphuric acid, higher yields of alcohol could be obtained.

Classen conducted successful experiments on a small plant at Aachen, and shortly afterwards, in conjunction with Ewen and Tomlinson, erected a similar plant on a larger scale at Chicago. This was followed by a still larger plant at Hattiesburg, Missouri. The convertor or digester was of sheet iron lined with lead, and measured 30 feet long by 36 inches in diameter, with a capacity of about 2 tons. The digester was nearly filled with wood waste, and an approximately saturated solution of sulphur dioxide was added in amount corresponding to one-third of the weight of wood. The digester was closed and slowly revolved, while live steam was

blown in until the temperature had risen to 140° – 150° C., and the pressure to 100 lb. per square inch. After four to six hours the sulphurous acid and steam were blown off, the SO_2 being partially recovered by absorption in water.

The contents of the digester, which were described by Ruttan as resembling finely-ground coffee in appearance, were conveyed to diffusion batteries and the sugar extracted with water: 350 to 400 lb. sugar were obtained for each ton (2000 lb.) of wood treated. The acid liquor from the diffusion batteries was neutralised, allowed to clear by settling, pumped into the fermentation vats, and fermented and distilled in the ordinary way. The yield was claimed to be 18 to 20 U.S. gallons of absolute alcohol per short ton (2000 lb.) of waste wood, which corresponds to 16.8–18.7 Imperial gallons per ton (2240 lb.), or 7.5 to 8.3 litres per 100 gm.

Ewen and Tomlinson's Improvements.—In the process as carried out at Hattiesburg great trouble was experienced from the buckling and breaking of the lead lining of the digester, which had frequently to be repaired. The time taken to complete the conversion, four to six hours for $1\frac{1}{2}$ to 2 tons of wood, and the large quantity of acid used, had the effect of breaking down the wood to a fine powder, and the sulphuric acid formed in the reaction produced extensive caramelisation of the sugars. The extraction of the soluble constituents in the diffusion batteries was thus rendered difficult. In 1904 Ewen and Tomlinson introduced various improvements into the process, and succeeded in reducing the amount of acid and the time necessary for conversion. A new type of digester was introduced which withstood the action of the acid better than the lead-lined vessel of the original process. A plant was erected near Chicago by the Wood-Waste Products Co., which later became the Standard Alcohol Company. The process has been fully described by Ruttan.²⁶

Instead of a 30 feet \times 36 inch digester, a shorter and wider revolving cylinder, measuring 12 feet \times 8 feet, was used. This was constructed of steel and lined with fire-brick set in a cement of lead oxide and glycerine. The charge consisted of about 3 tons of sawdust or 2 tons of wood shavings or chips. Gaseous sulphur dioxide, in quantity equal to 1 per cent. by weight of the dry wood, was introduced by a perforated tube passing through the trunnions of the cylinder. Live steam was then blown in for ten to fifteen minutes, and the pressure thereby raised to about 100 lb. per square inch. The cylinder was revolved slowly for about forty to forty-five minutes, the pressure and temperature being kept constant. The steam was then blown off into an absorption tank or into a second digester, carrying with it the excess of sulphur

dioxide, together with terpenes and some acetic acid. The digester was discharged and the contents transferred by a conveyor to the diffusion batteries. The hot acid liquid from the diffusion batteries was neutralised with slaked lime and calcium carbonate, allowed to settle, and then fermented and distilled. An analysis of the coffee-brown products from the digester, resulting from the treatment of sawdust containing a high percentage (70·4 per cent.) of moisture, gave the following figures :

Moisture	34·63 per cent.	
Total reducing sugars	14·28	{ Fermentable 10·97
Sugars calculated to dry basis	24·18	{ Non-fermentable 3·31
Total acidity	1·12	
Sulphuric acid	0·353	

The liquor obtained from the treatment of two digester charges in the diffusion battery contained 5·6 per cent. of reducing sugars calculated as dextrose. Total acidity was 0·64 per cent. calculated as sulphuric acid, of which 0·21 per cent. was due to sulphuric acid and the remainder to acetic and sulphurous acids and phenolic bodies of the type of pyrogallol. On neutralisation with lime and calcium carbonate the liquor assumed a black colour, due apparently to oxidation of the phenols and tannins (cf. sulphite liquor, p. 159). A considerable amount of furfural was also present.

The fermentation was carried out with brewer's yeast, the necessary nitrogenous material being provided in the form of malt combings. It occupied about three days, and with the particular yeast employed was not complete, only 75 to 80 per cent. of the theoretical yield of alcohol being obtained. The yield calculated on the dry wood was 20·55 U.S. gallons of 94 per cent. alcohol per short ton (2000 lb.). This is equivalent to 18 Imperial gallons of absolute alcohol per ton (2240 lb.), or 8·06 litres per 100 kgm. The wood waste left behind after complete extraction represented about 65 per cent. of the original wood, of which therefore only about one-third was rendered soluble by the sulphurous acid treatment.

It is of interest to note that this process was apparently worked in England on a small scale about the year 1907. According to Laskowsky²⁷ a rotating lead-lined digester was used, of 1 ton capacity, and the yield of alcohol was at most 5 to 6 litres per 100 kgm. of dry wood. The sawdust is stated to have cost at that time 20s. per ton.

A modification of the Classen process appears to have been in use in France in 1909, in which the action of the sulphurous acid in the digester was sufficiently prolonged to cause a more extensive decomposition of the wood fibre with the object of recovering acetic

acid as well as alcohol, and of using the residue as a feeding stuff. The acetic acid was recovered by vaporisation in steam, and the residue neutralised and fermented direct without separation of the sugar from the solid matter. The residues from the still were compressed, dried, and sold for cattle food.

The cost of the alcohol manufactured by Ewen and Tomlinson's sulphurous acid process was stated to be 6·4d. per Imperial gallon of 90 per cent. alcohol, taking the par value of exchange. This was based on an estimate of approximately £20,500 as the cost of erecting plant and buildings capable of handling 100 tons of dry sawdust per ten-hour day, or 200 tons working continuously over the twenty-four hours. The daily cost of maintenance, including interest, depreciation, labour, and material, allowing 2s. per ton for sawdust or other wood waste, was put at £44, 10s. per 100 tons.

As the fuel used consisted of the cellulose residues from the digestors, no allowance for fuel was made in the estimate, except the cost of drying this residue. In 1909 the cost to the consumer in America of 94 per cent. alcohol made from grain averaged about 2s. 6d. per Imperial gallon exclusive of the Excise duty, and of denatured alcohol 2s. 2d. to 3s. Ruttan estimated that 94 per cent. alcohol from waste wood should not cost the consumer more than 1s. or 1s. 3d. per Imperial gallon.

Notwithstanding the claims made for cheap production of alcohol by the sulphur dioxide process, it does not appear to have been a commercial success on a large scale. The average yields, taken over an extended period, apparently fell far short of those obtained in Ruttan's tests, and the use of sulphur dioxide presented several difficulties, including loss of acid by volatilisation, which contributed towards raising the cost of the alcohol.

Sulphuric Acid Process.—The sulphur dioxide process was discarded at the end of 1909 in favour of the one originally introduced by Simonsen, in which dilute sulphuric acid took the place of sulphurous acid. In 1910 Ewen and Tomlinson erected a factory at Georgetown, S. Carolina, for the Du Pont de Nemours Powder Co., and early in 1911 this factory commenced the regular production of alcohol.²⁸ In 1912 a second factory designed for an output of over 2000 gallons daily was erected to work the Simonsen process at Fullerton, Missouri.

It was found that by carrying out the sulphuric acid process in rotating digestors it was possible to reduce considerably the quantity of acid and water used, and at the same time secure a degree of conversion to sugar quite as high as had been obtained by Simonsen.

The factory at Georgetown was built close to a large sawmill,

and the sawdust was drawn from each saw by suction draught and subsequently blown by compressed air into the storage rooms of the alcohol plant. It was then transported by means of a conveyor to the four digestors, which were of the same dimensions as those previously used in the sulphurous acid process, and lined with acid-proof tiles.

The process was essentially the same as that already described for sulphurous acid. It was found that the shorter the time during which the steam pressure was kept up in the digester, the less was the destruction of the sugar. The maximum production of sugar corresponded to the conversion of somewhat less than half of the cellulose originally present. By varying the proportions of the reagents it was found possible to increase slightly the yield of sugar, but the process became less economical. The actual time of digestion was somewhat over one hour, after which the steam was blown off and turpentine recovered from it to the extent of about 0.2 to 0.3 kgm. from 1000 kgm. dry wood.

The contents of the digestors were then transported by conveyors to the diffusion batteries. After extraction of the sugar the residue was passed between rollers to remove excess of water, and formed the sole fuel used in the factory. The sugar solution was neutralised with lime and chalk, allowed to clear by subsidence, and fermented with yeast. The yeast used was first grown in a mixed rye and malt mash, and subsequently acclimatised in wood liquor from the diffusion batteries after this had been boiled with malt combings to supply the necessary yeast food and cooled to the requisite temperature. The fermenting "bub" was then added to the wood liquor in the fermenting vats, part of it being reserved to propagate fresh yeast for subsequent operations. Fig. 17 shows in diagrammatic form the general arrangement of the plant.

Samples of the alcohol produced at Georgetown were examined at the Institut für Gärungsgewerbe in Berlin. The crude spirit was found to contain 0.5 per cent. of fusel oil, but only traces of methyl alcohol and no acetone. The rectified alcohol was a silent spirit of good quality, containing traces of secondary constituents and of very slight acidity.

According to von Demuth,²⁹ the yields of alcohol were adversely affected by two factors—inadequacy of the fermentation plant, and American regulations in force at the time prohibiting the addition of more than a certain maximum amount of malt, rye, and malt-combings to each fermentation vat. The amount permitted was not sufficient to allow of vigorous growth of the yeast.

The summer temperature in South Carolina often went up to 106° F. in the shade, and the water supply to about 90° F. (32° C.), in

addition to being insufficient in amount. As there was no refrigerating plant at the factory it was impossible to keep the fermentation vat at the proper temperature and a diminished yield was the result. Thus the yield of alcohol in June 1911, although in the middle of the month water at 26° C. was obtained from a boring, was still

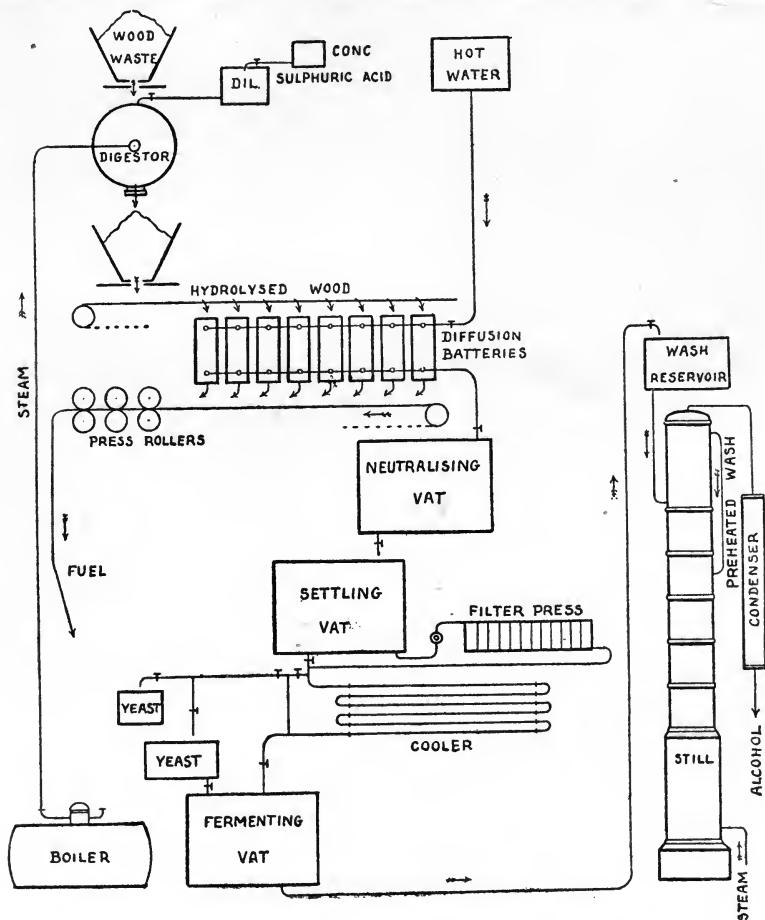

FIG. 17.—Arrangement of Plant for Treatment of Wood Waste.

35 per cent. below the yield for April. During the winter months 7.3 litres of absolute alcohol were obtained from 100 kgm. of dry wood, but the average for the whole year was only 6.4 litres, owing to the reduced yield in summer. The most favourable winter yield was estimated to be 9.5 litres per 100 kgm. of dry wood (21 Imperial gallons per ton), but this could only be reached by the use of a

larger quantity of yeast food than was permitted by the American Excise authorities.

In 1913 the output of the Georgetown distillery was about 2,000,000 litres of absolute alcohol.

The experience of this factory serves to emphasise the importance of providing for a sufficient supply of cold water, which is likely to be a matter of some difficulty in tropical countries. It does not necessarily follow that distilleries in the tropics will give even approximately the same yields as European distilleries working on the same material, unless efficient refrigerating machinery is installed.

At about the same time as the erection of the factory at Georgetown, another plant for working the sulphur dioxide process³⁰ appears to have been started at Port Hadlock, Washington, with the object of producing alcohol and cattle food from the waste sawdust of the Seattle mills.

The process seems to have been modelled on that used in France in 1909 by the Compagnie Ind. des Alcools de l'Ardèche.³¹ The six digestors consisted of steel cylinders $2\frac{1}{2}$ metres in diameter and $2\frac{1}{2}$ metres in length. At either end were flanged steam jackets connected with each other by twenty-two tubes, each of 160 mm. diameter, running longitudinally through the digester. The heating was therefore effected by indirect steam. Sawdust was introduced through the manhole together with sufficient water to bring the moisture content up to 45 per cent. Anhydrous sulphur dioxide was passed in and the mixture heated at a pressure of 75 to 100 lb. After the "cooking," the contents of the digester were extracted with water and the residue mixed with Hawaiian molasses and sold as cattle food. It was found necessary to dry the residue to a moisture content of 12 per cent. in order to prevent decomposition, and trouble was experienced through dust explosions in the dryers. Further difficulties were met with owing to rapid corrosion of the digestors, to the length of time necessary for digestion with the indirect method of heating employed, leakage of sulphur dioxide gas from the digester into the steam pipes, and incomplete extraction of the sugar from the residue. Moreover, the plant was situated 80 miles from a railway. In face of these difficulties, it was found impossible to carry on the process, and the factory appears to have been shut down.

The plant erected in 1912 at Fullerton, Missouri, was in full operation during the years 1916 to 1918, and was able, owing to the scarcity and high cost of alcohol during this period, to compete successfully with distilleries using grain and molasses. The digestors are of spherical shape, 12 feet in diameter, constructed of

steel plates lined with acid-proof tiles, after the fashion of sulphite pulp digestors. After they have been charged with sawdust, dilute sulphuric acid is added in the proportion of 0.5 to 1 per cent. of sulphuric acid calculated on the dry wood. The digester is then rotated slowly and steam introduced through the centre trunnions. The pressure gradually rises to 120 lb. per square inch, and the temperature to 335° F. (168° C.). The total time required for charging, heating up, cooking, blowing off, and discharging is about one hour. The "hydrolysed wood" contains about 50 per cent. of water.³²

It is essential to keep the proportion of liquid to that of wood as low as possible, not more than equal parts of each. If too high a proportion of liquid be present, the consumption of acid, the heat required, and the time of digestion all increase, and the resulting sugar solution is too dilute for economical working. Wood will absorb an equal weight of liquor without reaching the saturation limit, so that the hydrolysed wood can be handled in conveyors. The extraction is carried out in standard beet-sugar diffusion batteries, lined, like the digester, with acid-proof tiles. It is desirable to provide means for rapid cooling of the liquor after extraction, or secondary products are liable to be formed from the sugar before fermentation. The "wood liquor" from the diffusion batteries is neutralised, clarified, and fermented as already described.

The cost of alcohol at the Fullerton plant was estimated in 1913 to be approximately 1s. per Imperial gallon, as against 1s. 6d. for grain alcohol at that time.

The yield aimed at in this process and actually attainable in experimental plants under most careful control is from 33 to 36 Imperial gallons of 95 per cent. alcohol per ton (2240 lb.) of dry wood (14 to 15 litres absolute alcohol per 100 kgm.). On the assumption that the whole of the alcohol originates from preformed hexoses in the wood, this corresponds, on the basis of a 90 per cent. fermentation yield, to the conversion of 24 to 26 per cent. of the original dry wood into fermentable sugars. If it be assumed that the whole of the fermentable sugars come from the cellulose ($C_6H_{10}O_5$), the yields correspond to a conversion of 21.5 to 23.5 per cent. of the wood, or 43 to 47 per cent. of the cellulose. The actual average yields obtained on the large scale are less than half of this, corresponding to a conversion of only 11 to 12 per cent. of the dry wood into fermentable sugars, and a production of 6 to 7 litres of absolute alcohol per 100 kgm.

Comparison of Different Methods of Hydrolysis.—W. P. Cohoe³³ has investigated the conditions under which the maximum yield of sugar may be obtained. He found that hydrochloric acid

gave a higher yield than sulphurous acid and recommended that the process be carried out in two stages. Live steam alone was first introduced at a pressure of 95 lb. per square inch, and when the pressure in the digester had risen to this point the steam was blown off. Gaseous hydrochloric acid was then introduced, together with more steam and the pressure raised to 65 lb. The total quantity of sugar extracted from the wood under these conditions amounted to about 16 to 18 per cent. calculated on the dry wood. About 75 to 80 per cent. of the sugar was fermentable with brewer's yeast, which corresponded to a yield of about 8 to 9 litres of absolute alcohol per 100 kgm. of dry wood.

That great variations in yield of sugar and alcohol may occur with different acids under different conditions of concentration, time, and temperature is evident from Haegglund's experiments.³⁴ Wood was treated at 175° C. under pressure, with sulphuric acid ranging in strength from 0.4 to 1 per cent., the time of heating varying from twenty minutes to one hour. Provided that the ratio of liquor to wood was not below 3.3 : 1 the yields of sugar were from 15.0 to 20.8 per cent. of the dry wood, and the alcohol from 6.7 to 8.7 litres per 100 kgm. Where the ratio of liquor to wood was smaller, the yields fell off considerably, and with 1.3 parts of liquor to one of wood only 8.8 per cent. of sugar and 3.8 litres of alcohol were obtained. With sulphur dioxide (9.4 per cent. solution) at 135° to 145° C. the yields were from 4.0 to 4.3 litres per 100 kgm. for digestion times up to two hours, but fell to 2.5 litres when the digestion was prolonged to three hours. With calcium bisulphite the yields were fairly uniform, 5.6 to 6.5 litres, at varying temperatures and digestion times up to four hours.

F. W. Kressmann³⁵ has given the following as the best conditions for the commercial working of the process : Pressure 110 lb. per square inch for a maximum period of twenty minutes, ratio of liquor to dry wood 125 to 100, ratio of sulphuric acid to dry wood 2.5 to 100. White spruce under these conditions yielded 23.6 per cent. of total sugars calculated on the dry wood, 71.4 per cent. of the sugar being fermentable, and the yield of alcohol was 8.54 per cent. of the dry wood (10.7 litres absolute alcohol per 100 kgm.). Western larch (*Larix occidentalis*) yielded alcohol only to the extent of 4.98 per cent. of the dry wood. This species was found by Schorger and Smith to contain 10 per cent. of a galactan which yielded only galactose on hydrolysis (p. 133), and the low yield of alcohol is therefore to be attributed to the slow rate at which galactose is fermented by ordinary yeast.

In comparing the average yields given by the sulphuric acid process as worked at Fullerton and Georgetown with those of the

older Classen process using SO_2 it is seen that there is not much to choose between them. If anything, the Classen process gives the higher yields. Ruttan claims to have obtained 8 litres of absolute alcohol per 100 kgm. dry wood with the Classen process, although the average yield worked out at less than this. Von Demuth obtained an average of 6.4 litres at Georgetown with the sulphuric acid process, a figure which was largely due to the extremely low yield during the summer months. The Fullerton average was apparently 6 to 7 litres or even less. There appears to be a tendency now to revert to the use of volatile acids such as sulphur dioxide and hydrochloric acid, with the idea of obtaining more uniform penetration of the wood.³⁶ The yields under the most favourable conditions are said to approximate to 14 to 15 litres of absolute alcohol per 100 kgm. of dry wood, being thus comparable with the highest experimental yields in the sulphuric acid process. The average quantity attainable in practical working would appear, however, not to exceed 7 litres.

In the more recent patents dealing with the acid hydrolysis of cellulose it seems to be recognised that the preliminary saccharification must be carried out by concentrated acids, followed by heating with more dilute acid. C. G. Schwalbe³⁷ subjects wood containing less than 50 per cent. of moisture to the action of gaseous hydrochloric acid, hydrofluoric acid, or sulphurous acid until it is swollen but not dissolved, and subsequently saccharifies the gelatinous material by boiling with dilute acid. He claims in this way to have obtained nearly the theoretical yield of fermentable sugars, but there is no record of these yields having been achieved on the commercial scale. H. Terrisse and M. Levy³⁸ propose to treat dry sawdust with about twice its weight of 33 per cent. hydrochloric acid. The mixture is then conveyed through other mixing cylinders, into each of which gaseous hydrochloric acid is introduced so as to increase the acid concentration to about 41 per cent., the temperature being kept below 25° C. The impregnated material is digested in a rotating vessel at a slightly higher temperature for ten hours, and the excess of hydrochloric acid is removed by raising the temperature to about 30° C. and reducing the pressure to 40 mm., the gaseous acid being absorbed and collected. The residue is extracted with water, the extract filtered and distilled under reduced pressure to remove the remainder of the hydrochloric acid.

The Goldschmidt process, which is worked on somewhat similar lines, is stated to give a high yield, but to be beset by many technical difficulties.

Several German concerns appear to be working on the idea of combining the use of strong acids for saccharification with the

production of nitrogenous and phosphatic fertilisers. Concentrated sulphuric acid is used for the preliminary hydrolysis of the cellulose, and is then either recovered in the form of ammonium sulphate³⁹ or utilised for the conversion of mineral phosphates into super-phosphates.⁴⁰ Thus the concentrated acid, which must in the ordinary course be used for the manufacture of these fertilisers, is made to perform the intermediate function of saccharifying cellulose.

Economic Considerations.—The economic aspect of the production of alcohol from waste wood in connection with timber operations has been discussed by Tomlinson.⁴¹

The industry has suffered from attempts to develop it too rapidly without adequate investigation and research. Sawmills are seldom permanent, and are liable to be moved from place to place as the area in the immediate neighbourhood becomes depleted of timber. The location of sawmills is often unfavourable as regards labour, transport, and water supply. Sawdust and waste wood are too bulky for profitable transport to a distant distillery, so that for economic working it is essential that the plant be erected close to the source of raw material and that the supply be assured at a reasonable price. Tomlinson suggests that these difficulties might be largely overcome by producing wood molasses only at the sawmill and transporting this to a central distillery. The cost of the plant would thus be far less and the operations would not be affected to so great an extent by local fluctuations in the supply of raw material. There would be great advantage in being able to send the molasses to distilleries already established, and Excise supervision would be simplified. The extra cost of evaporation of the wood liquor to molasses would have to be taken into consideration, but according to Tomlinson this would be small. He calculated that in June 1913 it would have been possible to produce wood molasses at a cost of 1·5d. to 1·8d. per Imperial gallon, from which a yield of slightly less than 0·2 Imperial gallon of absolute alcohol could be obtained, as against 0·5 gallon of alcohol from 1 gallon of cane molasses. According to this estimate the cost of the wood molasses required per Imperial gallon of absolute alcohol would be about 9d., without reckoning fermentation and distillation costs. The figures are based upon the results of twenty-two days' working, in which an average yield of 5·4 litres of absolute alcohol per 100 kgm. of dry wood (12·1 Imperial gallons per ton) was obtained, operating upon waste green wood containing 48 per cent. of moisture. This corresponds to a conversion of less than 9 per cent. of the dry wood into fermentable sugars. The total extraction amounted

to about 27 per cent. of the dry wood. Tomlinson considers that it should be possible by careful working to make the average large scale yields correspond more closely with those obtained in experimental plants, and to produce a molasses almost equal to cane molasses in fermentable value at the same cost as the present low-grade product.

Straw.—Experiments on the production of alcohol from rice straw are now being carried out on a commercial scale in Burma.⁴² According to the patent the straw is steamed, preferably with superheated steam, then converted into pulp and digested with dilute acid. The liquid obtained is neutralised and fermented. During the steaming process the material may be subjected to the action of hydrochloric acid vapour or atomised calcium hypochlorite and chlorine. It is claimed that the proportion of acid required is small, and that the slight lignification of the straw as compared with that of wood renders the hydrolysis easier. No data are given as to the yield of alcohol obtained, and no conclusions can therefore be drawn as to how far the fermentable sugars are the result of hydrolysis of cellulose or derived from the preformed sugars or hexosans of the straw. In view of the statement that the manufacture of paper from the straw fibre is an essential factor in the commercial development of the process, it would appear that it is the simpler hexosans and not the cellulose which are the principal source of the alcohol. According to S. H. Collins and A. Spiller⁴³ oat straw when cut green may contain upwards of 6 per cent. of sugars, mostly invert sugar, but when fully ripe the sugar content is much smaller.

The approximate composition of rice straw has been given as :⁴⁴

Moisture	12	per cent.	
Dry matter	88	„	
Crude fibre	31	„	
Ash	12	„	(containing 6 per cent. of silica).
Dextrose and sucrose	3.5	„	
Starch and hemicelluloses	15	„	
Pentosans	15	„	
Proteins, fat, etc. . . .	7	„	

Rice straw is more highly silicified than that of other cereals. The straw from wheat contains 2.1, from barley 2.7, from oats 3.4, and from maize 1.5 per cent. of silica.

The advantages claimed for rice straw as a raw material are that it has a low market value, and is easily accessible. The Burma rice-fields are largely deltoid, and water transport can be used between the fields and the distillery.

Peat.—The treatment of peat for the production of alcohol on lines similar to the Classen process for sawdust has been the subject of several investigations. According to a process patented in 1907,⁴⁵ dry peat (400 parts) was mixed with water (2200 parts) and concentrated sulphuric acid (16 parts) and heated under pressure in a digester. The acid was then neutralised with calcium carbonate and the liquor fermented with a yeast obtained from berries growing on peat bogs. The yield of alcohol is not stated. R. Pique⁴⁶ treated 225 kgm. of peat, apparently without previous drying, with 400 to 460 litres of water and 3 to 4 litres of sulphuric acid under a pressure of three atmospheres for forty-five minutes. The liquor expressed from the saccharified product was neutralised to an acidity of 0.3 per cent. sulphuric acid, and fermented with *Saccharomyces ellipsoideus*. The yeast was first cultivated in an acid solution of beet-root molasses and acclimatised to withstand the action of the toxic bodies present in peat. The yield of alcohol amounted to 10 litres per 100 kgm. of dry peat, or about 22 Imperial gallons per ton.

This yield is of much the same order as that obtained from wood, but as peat in its raw state contains over 90 per cent. of water, it represents a yield of not more than 1 per cent. of alcohol on the original raw material. It is stated that 28 per cent. of the dry substance of peat can be readily hydrolysed into substances which reduce Fehling's solution,⁴⁷ but according to Feilitzen and Tollens⁴⁸ only half of this is fermentable, a large proportion consisting of pentose sugars. Feilitzen and Tollens obtained on an average about 15 gallons of absolute alcohol per ton of dry peat.

The great difficulty with peat is its high water content. Owing to the colloidal nature of the material, the water cannot be removed by pressure alone, and so far the only commercially successful process is that of spreading the peat out to dry in the open, whereby the water content can be reduced to 35 per cent. Even if methods of artificial drying, such as the so-called "osmose filter-press," eventually prove successful, it is doubtful whether peat will prove a cheaper source of alcohol than other forms of cellulose. The chief advantage of peat is that it is available in large quantities in this country. The Irish deposits alone are estimated to contain 3700 million tons of anhydrous peat.

WASTE SULPHITE LIQUOR

In the production of wood pulp or sulphite cellulose, wood in the form of chips and shavings is digested under pressure with 3.5 to five times its weight of a solution of calcium bisulphite containing

from 2 to 5 per cent. of free sulphurous acid and from 1 to 2 per cent. of calcium sulphite. The digestion is either carried out by indirect steam heating at a low temperature and pressure (110° to 125° C. and three to four atmospheres) for thirty to forty-eight hours (Mitscherlich process), or by direct steam at a higher temperature and pressure (125° to 140° C. and four to six atmospheres) for fifteen to twenty hours (Ritter-Kellner process). The two extremes represented by these processes merge more or less into one another according to the kind of wood treated and the grade of wood pulp required. The temperatures of digestion are thus considerably lower than those employed for the extraction of fermentable sugars from sawdust, the object being to remove the non-cellulose bodies without injuring the cellulose. The non-cellulose constituents of the wood, lignin, carbohydrates, proteins, resins, and fat, pass into the liquor, leaving a residue of cellulose representing about 50 per cent. of the dry wood. The greater part of the sulphur dioxide combines with the lignin and probably with other organic constituents to form sulphonic acids. Klason found that lignin would combine with 36 per cent. of sulphur dioxide, corresponding approximately to four molecules of sulphur dioxide for one lignin group $C_{40}H_{40}O_{11}$. Two of these molecules are firmly bound to the lignin, forming apparently a true sulphonic acid. Klason isolated the barium salt of this acid $C_{40}H_{42}O_{17}S_2Ba$. The third molecule of sulphur dioxide is more loosely bound, while the fourth is still more easily detached, and can be partially titrated with iodine at ordinary temperatures.

Sulphite liquor has a specific gravity of 1.05 and contains 10 to 12 per cent. of organic and 1 to 1.5 per cent. of inorganic constituents.⁴⁹ The sulphurous acid varies from 0.5 to 3.0 per cent., the greater part being combined sulphur dioxide. There is also present from 0.02 to 0.2 per cent. of sulphuric acid. The total sulphur dioxide can be estimated by distillation with phosphoric acid, and the free sulphur dioxide titrated with iodine; but the results of this titration are much influenced by dilution and time.

On completion of the digestion, the liquor is drawn off and the pulp washed several times in the digester with fresh water before being removed. In the Ritter-Kellner process the liquor, together with the first washings, amounts to 10 cbm. per metric ton of cellulose (=2240 Imperial gallons per English ton), and in the Mitscherlich process 8 cbm. (1790 gallons per English ton). The larger volume in the former process is due to condensation of part of the live steam used for heating. The Ritter-Kellner liquor contains on the average 10 per cent. of solids and the Mitscherlich liquor 12.5 per cent.

In some American and Canadian mills it is usual to employ a still shorter cooking period (eight to ten hours) and a higher temperature (165° C.), and then to blow off the whole contents of the digester into "blow pits" (tanks with perforated bottoms), from which the liquor drains off. The amount of liquor thus obtained, without washings, is about 700 to 750 Imperial gallons per English ton of cellulose, *i.e.* 3.1 to 3.4 cbm. per metric ton, which is only 35 to 40 per cent. of the total liquor produced per ton of pulp.⁵⁰ This liquor, therefore, although it does not contain the whole of the fermentable sugars extracted from the wood, is richer in sugar than that obtained when the first washings are included.

According to Klason,⁵¹ there are produced for every metric ton (1000 kgm.) of cellulose the following by-products, all of which are contained in solution in the sulphite liquor :

Lignin	644 kgm.
Carbohydrates	311 "
Proteins	15 "
Resins and fats	73 "
Sulphurous acid in combination with lignin	235 "
Calcium hydrate	102 "
	<hr/>
	1380 "

On standing in contact with air the liquors oxidise and deposit calcium sulphate.

The disposal of waste sulphite liquor has proved to be a difficult problem. The simplest course is to discharge it into streams, but unless the factory is situated on a river of some size, this procedure results in extensive pollution. When sulphite liquor is disposed of in this way, the bed of the stream sometimes becomes covered to a depth of several inches with a dark green slime, due apparently to the growth of algæ. In certain streams of the Black Forest, this condition can be observed for a distance of several miles below the factory, and appears to be highly injurious to fish life.

Many proposals have been made for the evaporation of the liquors and the utilisation of the residue as fuel or for the recovery of by-products by destructive distillation, but it does not seem that any of these have been commercially successful.⁵²

Sulphite Liquor as a Source of Alcohol.—The proposal to utilise the fermentable sugars of sulphite liquor for the production of alcohol was the outcome of the older attempts to produce alcohol from sawdust. The chief difficulty here met with is the large amount of liquor compared with the quantity of fermentable sugars contained in it. In the Classen and Simonsen processes one of the most essential conditions is to keep the ratio of liquor to wood

as low as possible. The quantity of liquor is not sufficient to dissolve all the non-cellulose constituents (lignin, etc.). The residue after extraction of the sugars still amounts to 65-70 per cent. of the original wood, and retains a large proportion of non-cellulose. In sulphite pulp cooking the quantity of liquor must be large enough to dissolve out all the wood gum and lignin, and leave a residue of pure cellulose.

Swedish sulphite liquors contain about 2 to 2.4 per cent. of total carbohydrates, of which about 0.7 per cent. is xylose and the remainder, roughly 1.3 to 1.7 per cent., fermentable sugars. After fermentation the wash contains therefore not much more than 1 per cent. by volume of alcohol and is much weaker than the liquor obtained in the Simonsen and Classen processes. B. Johnsen has stated that the waste liquors as now produced contain from 1.5 up to 2 per cent. of fermentable sugars or even occasionally 2.4 per cent. It would appear from the context of his paper that this refers to liquors which have been drained off from the pulp in blow-pits, without the addition of any washings. The quantity of liquor thus draining off is less than half of the total liquor in the digester.

According to A. D. J. Kuhn⁵³ the ratio of liquor to wood depends upon the method of digestion, the moisture content, and the species of the wood so that the quantity of waste liquor may vary between 5 and 10 cbm. per metric ton of cellulose. He recommends that the digester should be drained under a pressure of four to five atmospheres, when the pulp will retain 4 cbm. of liquor per ton as against 5.25 cbm. if the draining is done at two to three atmospheres pressure. Hot water introduced on to the pulp under pressure will displace the spent liquor, whereas the introduction of water without pressure results in undue dilution.

V. K. Krieble⁵⁴ gives the total sugar content of typical Canadian liquors as 2.0 to 2.9 per cent., of which 61 to 75 per cent. is fermentable. The yield of alcohol ranges from 0.82 to 1.23 per cent. by volume and averages 1 per cent.

The proportion of sulphur dioxide in the fresh liquor has an important bearing on the amount of sugar formed. According to Kuhn and Haegglund, the maximum production of fermentable sugars is effected by a liquor in which the proportion of free sulphur dioxide is at least 70 to 80 per cent. of the total. If the digestion is continued for too long, a gradual decomposition of the sugar sets in. The proportion of free sulphur dioxide in the fresh liquor is highest, and the time of cooking is shortest, in the Ritter-Kellner or direct steam process. This method of cooking, therefore, gives a greater quantity of fermentable sugars per ton of pulp

produced than the Mitscherlich or indirect process. Indirect cooking with forced circulation of the liquor (the "Mortrud" process) has been introduced in America,⁵⁵ and is claimed to give a pulp of the Mitscherlich character, and at the same time a much more concentrated waste liquor. The percentage of sugar in the liquor from this process is stated to have been raised from 2.2 to 4 per cent.

But in any case the recovery of alcohol by no means solves the problem of the disposal of the liquor, since the quantity of fermentable sugars is at the best very small compared with that of the other non-cellulose constituents. If the liquor is concentrated before fermentation to about four-fifths or two-thirds of its bulk, the recovery of alcohol is greatly facilitated, and it may then become profitable further to concentrate the waste liquor from the still with a view to the recovery of the solid residue.

The first attempts to recover alcohol from sulphite liquor were made in 1867 by Payen in connection with his work on the hydrolysis of sawdust by dilute acids. In 1891 Lindsay, Weld, and Tollens established the presence of mannose, xylose, and galactose in the liquors from an Aschaffenburg factory. The total content of the liquor in fermentable sugars was 1.2 per cent., and the yield of alcohol on fermentation 5.8 to 6.7 c.c. per litre, corresponding to 58-67 litres per metric ton of cellulose produced, assuming a ratio of ten parts of liquor to one part of cellulose. In 1892 Mathëus obtained 70 litres of alcohol per metric ton of cellulose, and Krause in 1905 confirmed the results obtained by these investigators.

The production of alcohol from sulphite liquor did not make much headway in Germany at this time since the policy of the German Government was to promote the manufacture of alcohol from potatoes, and Excise restrictions were framed with this object. There was no demand for sulphite alcohol and, further, its production did not afford a complete solution of the waste liquor problem. Other methods, therefore, of dealing with the waste liquors were sought for, in the direction of converting them into fuel, tanning materials, manure, or feeding stuffs.

Processes of Wallin, Ekström, and Landmark.—In 1908 a process was introduced simultaneously by J. H. Wallin⁵⁶ and by G. Ekström⁵⁷ in Sweden, for which a yield of 115 litres of alcohol per metric ton of cellulose was claimed. In this process the sulphite liquor is first evaporated, preferably in towers, to effect removal of part of the sulphurous acid. It is then partly neutralised with milk of lime, care being taken to avoid any local alkalinity. Complete neutralisation with lime is liable to lead to partial de-

struction of the sugars, and to a persistent turbidity. The amount of lime used is therefore kept as low as possible, and the liquor is brought to the right degree of acidity for fermentation by the subsequent addition of calcium carbonate. Marchand proposed the use of barium carbonate instead of calcium carbonate. In Ekström's process the liquor is completely neutralised with carbonate of lime, and sulphuric acid then added to bring it to the necessary degree of acidity.

In Landmark's process, as carried out at Drammen in Norway, a similar procedure is adopted for removal of the sulphur dioxide by evaporation and subsequent neutralisation. The preliminary evaporation so reduces the sulphur dioxide content of the liquor that only 2 to 3 kgm. of lime are required to neutralise each cubic metre of liquor, instead of 11 to 13 kgm. which would otherwise be required. The yeast used is an ordinary beer yeast cultivated in a malt mash and acclimatised by the addition of successive quantities of sulphite liquor, a process which occupies about six days.⁵⁸ An addition of a small quantity of milk or whey is made to the liquor before pitching with yeast. It is stated that the milk sugar is hydrolysed in the slightly acid solution to dextrose and galactose, and the progress of the fermentation thereby assisted. An additional advantage claimed for the addition of milk is the removal of tannins from the liquor before fermentation. The cost of the milk is stated to be offset by the recovery of precipitated "ligno-casein," obtained as a yellow powder containing 65 per cent. of casein and capable of being used for sizing paper.

The liquor after removal of the ligno-casein is evaporated at 50° C. to a strength of 2.0 to 2.3 per cent. of fermentable sugar, and fermented at 26° to 28° C., for four to five days. According to Landmark the yield amounts to 55 c.c. of absolute alcohol from every 100 gms. of fermentable sugars in the liquor, or 1.1 per cent. of alcohol by volume from a liquor containing 2 per cent. of fermentable sugars, corresponding to an 85 per cent. fermentation yield. On an average he obtains 88 litres of alcohol for each metric ton of cellulose produced. This is a considerably higher yield than was obtained by Lindsay and Tollens or by Mathëus, but much lower than that claimed by Ekström.

It is pointed out by Kiby⁵⁹ in a critical survey of the Wallin, Ekström, and Landmark processes, that yields higher than 80 litres per ton of cellulose must be due partly to the presence of carbo-

⁵⁸ According to Haegglund (*Biochem. Zeitsch.*, 1920, 103, 299), sulphurous acid at 0.007 N concentration completely inhibits fermentation with 1 gram of yeast in 25 c.c. of solution. The toxic effect is attributed to the undissociated acid.

hydrates in the yeast food added. A yield of 115 litres of absolute alcohol per metric ton of cellulose would mean that the sulphite liquor as run off from the digestors must contain over 2 per cent. of fermentable sugars, while according to Haeggund the normal Swedish and Norwegian liquors do not contain more than 1.4 to 1.7 per cent., corresponding to a yield under practical conditions of approximately 80 litres.

Several of the more recent estimates of yield are considerably lower than this. Thus E. J. Ljungberg⁶⁰ gives the average yield as 43 litres of 100 per cent. alcohol per metric ton of cellulose produced. J. H. Wallin⁶¹ states that while the maximum yield is 93 litres of 100 per cent. spirit per metric ton of cellulose, in practice only 60 litres are obtained. The reason of these divergences is no doubt to be found in the varying quantities of liquor upon which the estimates are based, that is to say, the extent to which the pulp washings are included in the total quantity of liquor to be fermented.

Kiby has indicated certain directions in which endeavours should be made to improve the processes if they are to continue as a commercial success. The preliminary removal of as much as possible of the free sulphurous acid by evaporation is most important. The amount of lime necessary for neutralisation is thus reduced, and the presence of excess of calcium sulphite in the liquor, which would inhibit fermentation, is avoided. The liquor, after the sulphur dioxide has been driven off and recovered, should be concentrated to four-fifths or two-thirds of its original bulk. The stronger liquor so obtained is more easily and completely fermented, and moreover a great saving of steam is effected in the distillation. A fermentation period of three days is too long. Kiby considers that it should not occupy more than twenty-four hours, and that great care should be taken to maintain the temperature of the fermentation vat at the proper point. The yeast should be kept in constant and intimate contact with the liquor by gentle stirring or aeration. As aeration stimulates the growth of the yeast, a sufficient supply of yeast food must be supplied. The slow fermentation in Landmark's process is due, according to Kiby, to lack of aeration or stirring, the evolution of carbon dioxide being so slight that it has practically no effect in keeping the yeast in suspension. The yeast sinks to the bottom and has to work under unfavourable conditions of carbon dioxide concentration. He emphasises the importance of using a pure culture of yeast and of taking greater care in acclimatising it by successive cultivation in an increasing concentration of sulphite liquor, with gradually decreasing acidity. If a thoroughly acclimatised yeast is used and fermentation carried out under optimum

conditions of temperature and aeration, it should be possible to secure complete fermentation of a 2 per cent. sugar solution in twenty-four hours instead of three to four days, which Kiby regards as the main factor in economical working. One of the modern forms of combined distillation and rectification still should be employed, specially designed for very weak washes, such as the one already described on p. 80. A still of this type permits complete recovery of the volatile by-products of fermentation, such as methyl alcohol, aldehyde, and fusel oil. The crude sulphite spirit contains about 3 per cent. of methyl alcohol and a varying proportion of acetone.

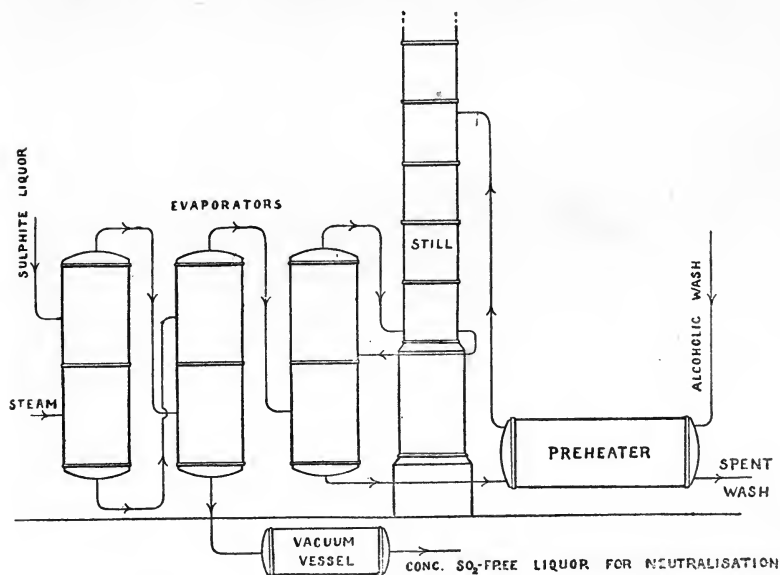

FIG. 18.—Triple Effect Evaporator in conjunction with Sulphite Liquor Still.

(W. Kiby, *Chem. Zeitung*, 1915, 39, 284.)

According to Sieber^{61a} it also contains acetaldehyde in quantity proportional to the amount of sulphurous acid in the wort before fermentation (cf. p. 27). The complete removal of these products from the alcohol is not absolutely necessary if the latter is destined for use as motor fuel, and the degree of rectification to be adopted would depend to some extent upon the commercial value of the fusel oil and methyl alcohol compared with the additional cost of the steam required.

The distillation plant should be combined with a triple effect evaporator (Fig. 18) in which the sulphite liquor is concentrated in the first two effects, and in the third the spent wash from the still

is further concentrated so as to facilitate the recovery from it of other by-products.

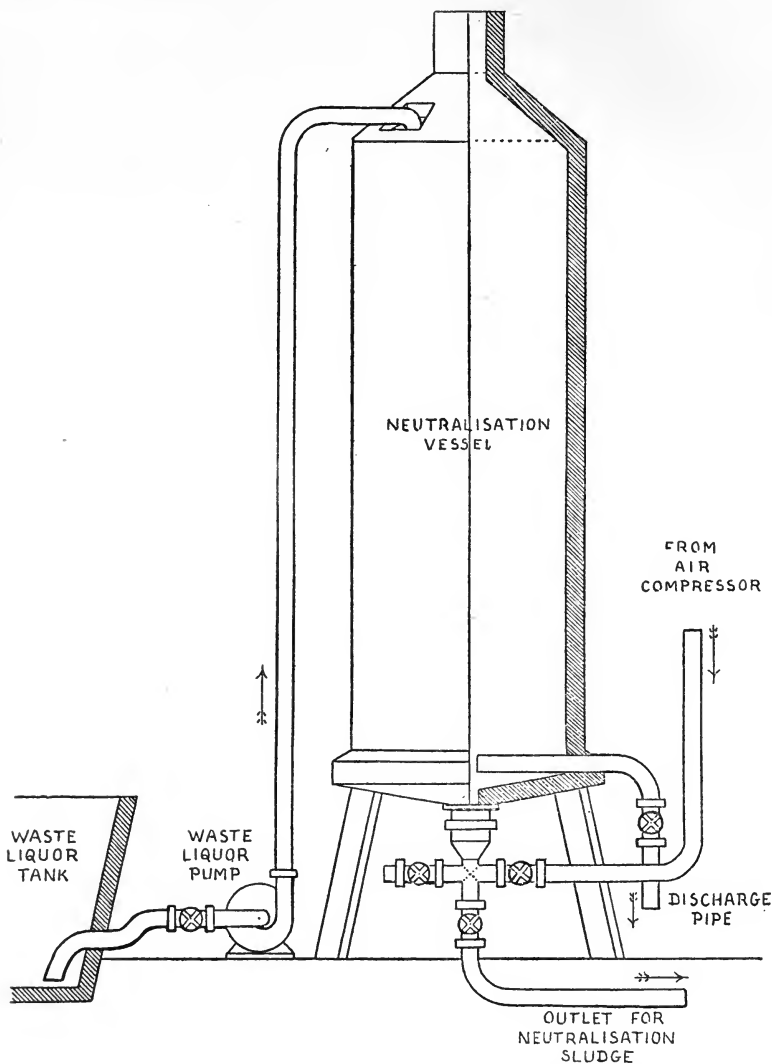

FIG. 19.—Concrete Neutralisation Tower for Sulphite Liquor.
(E. Haegglund.)

Recent Swedish Developments.—Haegglund⁶² has given a detailed account of the process as carried out in several Swedish pulp factories. One of the chief difficulties encountered is that of obtain-

ing a clear liquor after neutralisation with lime. It is essential to get rid of the free sulphur dioxide, as fermentation is seriously inhibited if as little as 0.01 per cent. free sulphur dioxide remains in the liquor. The greater part of the sulphur dioxide is removed by aeration of the hot liquor which effects a great saving in the amount of lime necessary.

The liquor is pumped to the top of a reinforced concrete tower of 100 cubic metres (22,000 gallons) capacity and air is blown in at the bottom by a compressor (Fig. 19). The sulphur dioxide is partly swept out by the air current and partly oxidised, together with certain of the organic constituents of the liquor. One patent⁶³ recommends the addition of catalytic materials, such as manganese and iron, to assist in the oxidation, but Haegglund considers this unnecessary. When the tower has been charged with liquor, 300 kgm. (660 lb.) of freshly slaked lime are added, the air blast being continued so as to promote rapid mixing and prevent the occurrence of local alkalinity. After half an hour an excess of pulverised limestone is added, ground as fine as possible. If the neutralisation be effected with lime alone it is impossible to obtain a clear liquor except by prolonged settling. The suspended sludge inhibits fermentation and also gives trouble in the still. If calcium carbonate alone be used for neutralisation great difficulty is experienced subsequently in the distilling column through the deposition of a hard deposit of calcium sulphate. This deposit may attain a thickness of 3 to 4 cm. in a fortnight, necessitating frequent stoppage of operations for cleaning the still. This calcium sulphate deposit probably originates from the third molecule of sulphur dioxide which has been referred to above as being loosely bound to the lignin grouping. If, however, the neutralisation be effected partially with lime and completed with calcium carbonate the sludge settles quickly and yields a clear liquor which shows no tendency to deposit calcium sulphate on further heating or standing.

The calcium carbonate is only partially converted into sulphite and sulphate in the tower. Apparently the solid particles become coated with an insoluble layer which protects the carbonate from further action. The composition of the sludge once used is :

CaSO ₃	39.6 per cent.
CaCO ₃	35.5 "
CaSO ₄ + insoluble matter	22.1 "
Organic matter	2.8 "

On further treatment with sulphur dioxide the protective layer is dissolved, and a fresh surface of calcium carbonate exposed. The sludge from the first operation can therefore be used again to

neutralise fresh sulphite liquor. After being used in this way six times its composition is approximately :

CaSO ₃	60.9 per cent.
CaCO ₃	7.2 "
CaSO ₄ etc.	28.8 "
Organic matter	3.1 "

It is then removed and used for the regeneration of sulphur dioxide for the pulp process.

The neutralisation of the liquor with calcium carbonate is not carried to the point of complete neutrality, as a slight acid reaction (0.025 per cent. H₂SO₄) is favourable to fermentation. The acidity is checked by withdrawing samples at intervals during the progress of the operation.

Haegglund investigated the action of lime on pure dextrose, by passing a slow current of air through a solution of the sugar in lime water at different temperatures. His results were as follows :

TEMP. 90° C.	CALCIUM HYDRATE 0.005 N.
Time in Hours.	Sugar per cent.
0	1.81
1	1.77
2	1.64 (solution neutral)
3	1.60
4	1.58
5	1.56 (solution faintly acid)

TEMP. 21° C.	CALCIUM HYDRATE 0.02 N.
Time in Hours.	Sugar per cent.
0	1.48
1	1.09
2	0.99
3	0.97
4	0.77

These results were obtained with dextrose, a sugar which, according to Haegglund, is not present in sulphite liquor, but there is every indication that many other sugars are equally sensitive to the action of free lime.

After neutralisation the liquor is cooled and run into fermentation vats. These are open vats of large size, 100 to 300 cbm. (22,000 to 66,000 gallons), as it is found that the larger the fermentation vats the easier it is to control the temperature, and greater economy in supervision is secured. It is necessary to use a highly resistant strain of yeast. The yeasts known as Type XII. and "M" mixture of the Institut für Gärungsgewerbe in Berlin have been found to be the most satisfactory. Certain types of

moulds have been tried with a view to effecting saccharification and fermentation of the so-called "wood dextrins" present in the liquor (cf. p. 53, amylo process), but without much success, and further investigations in this direction are desirable.

Since the liquors are extremely poor in nitrogen and phosphorus (Stutzer gives the amount of nitrogen per litre as 0.03 grm.), it is necessary to add some form of yeast food. A yeast extract formed by the autolysis of yeast at 45° to 50° C. is largely used, but Haegglund claims to have introduced a mixture which is only one quarter of the price and gives a 5 per cent. better yield than autolysed yeast.

The fermentation is carried out by the continuous method as used for molasses (p. 61) at a temperature of 29° to 30° C., and lasts for three to four days. It takes place in the usual three stages, the first being marked by strong growth of yeast and comparatively little production of alcohol. The second or main fermentation, lasting for two days, is characterised by a more rapid evolution of carbon dioxide and the formation of a considerable quantity of foam. The third stage represents the period of slackening fermentation with a decrease in the amount of carbon dioxide evolved, and it is probable that during this stage a certain amount of hydrolysis and fermentation of the "wood dextrins" takes place. The three stages are not sharply marked, but run more or less into one another.

During neutralisation and aeration of the sulphite liquor oxidation occurs and the liquor turns from yellow or reddish-yellow to brownish-black. During fermentation the liquor becomes lighter in colour owing to absorption of oxygen by the yeast. According to Haegglund the oxygen thus available for absorption is sufficient for the yeast without further aeration.

The type of still mainly used in Sweden for the distillation and rectification of sulphite spirit is a three-column still built by Avenarius, somewhat similar in design to that shown in Fig. 14 (p. 80). The most important considerations in connection with such a still are:

- (i) Steam consumption.
- (ii) Resistance to the corrosive action of the hot sulphite-liquor wash.
- (iii) High rectification and continuous separation of first runnings, containing methyl alcohol, acetone, etc., and last runnings or feints containing the fusel oil.

Haegglund gives the steam consumption for the Avenarius still as 160 to 170 lb. per 100 gallons of wash, but according to Kiby it is possible in some modern stills to reduce this figure to

140–147 lb., or if crude 80 per cent. spirit only be made, a consumption of only 115 lb. of steam per 100 gallons of wash.

Sulphite wash is used for cooling the dephlegmators, being thereby heated to 75° C. It passes on to the preheater, where it is heated a further 10° or 15° C. by means of the hot residual liquor from the still. The columns of the still are lagged with a view to diminishing still further the loss of heat.

Hot sulphite liquor wash is liable to be particularly corrosive, and the still is therefore built of cast-iron, coated on the interior with an acid-proof enamel. Small amounts of organic acids (formic, acetic, etc.) present in the wash are removed by passing the alcoholic vapours through small columns containing a solution of caustic soda. The yield of alcohol varies between 0.5 and 1.4 per cent. by volume of the liquor and averages 1 per cent.

T. Bokorny⁶⁴ has investigated the use as a fertiliser of the spent wash from sulphite-alcohol stills. The spent wash, if undiluted, is injurious to plant life, but if diluted ten times it is harmless. It is a favourable medium for mould growths, and although it contains no nitrogen, its use is stated to be beneficial to the growth of barley crops, and it is suggested that it may constitute a source of carbon nutrition.

Cost of Sulphite Alcohol.—Kiby calculated in 1915 that an installation for dealing with the liquors from a factory producing 60 metric tons of cellulose a day would cost £25,000, and that the running costs, including interest and depreciation, would be £12,000 per annum. Under the best conditions of working it should be possible to obtain a yield of 90 litres of absolute alcohol per metric ton of cellulose, or 1,980,000 litres yearly. The cost of the alcohol at the factory in 1915 works out therefore at about 12s. per 100 litres, or 6½d. per Imperial gallon. The Excise regulations as applied to sulphite-spirit in Germany at that time would have raised the cost to over 50s. per 100 litres as against 30s. for denatured alcohol from potatoes.

According to Haegglund⁶⁵ the actual manufacturing cost of 1 Imperial gallon of 100 per cent. alcohol before the war was 5½d., 6¼d., and 7¼d., according as the capacity of the pulp mill was 30,000, 20,000, or 10,000 tons per annum. This was based on a recovery of only 3.7 cubic metres of liquor per metric ton of pulp. Landmark, calculating on a basis of 6.5 cubic metres recovered per ton of pulp, gave the manufacturing cost of 1 gallon of 100 per cent. alcohol as 5½d. for a 30,000-ton pulp mill. It would appear that these figures are based on the working up of the strong liquor draining off from the pulp, without dilution with wash water. Several other estimates made in 1911 to 1914 gave the actual

manufacturing cost at 6d. to 7d. per Imperial gallon of 100 per cent. spirit, but Forrester⁶⁶ made it 9½d. to 9¾d.

In 1917 the cost of manufacture in Sweden, according to Haegglund, had risen to 9d. or 10d. per Imperial gallon, and an independent estimate⁶⁷ gives the average cost of production for all Swedish works as 11d. per gallon of absolute alcohol.

B. Johnsen⁶⁸ by applying Haegglund's data to Canadian conditions in 1918, calculated that the cost per Imperial gallon of absolute alcohol would be 10·8d., 1s. 0·4d., and 1s. 3·8d. on the basis of a 30,000, 20,000, and 10,000 ton pulp mill respectively. By recalculating certain data given by Landmark so as to bring them into accordance with conditions in Canada, he worked out the cost at 9¼d. per Imperial gallon. McKee⁶⁹ estimated the cost of sulphite alcohol prepared by his process to be 1s. 4¾d. per Imperial gallon, and Ruttan in 1919 gave it as 1s. 8d. In a report of the Hon. Advisory Council for Scientific and Industrial Research of Canada (1918), the cost of sulphite alcohol was estimated to be 1s. 6d. per gallon.

A. M. Breckler⁷⁰ has given figures bearing on the fuel consumption and cost of distillation of 1 gallon of 80 per cent. alcohol by volume from washes of various strengths. Taking as a basis a concentrated sulphite liquor containing 4 per cent. fermentable sugars, the quantity of alcohol obtained will be 2·2 per cent. by volume on the liquor, assuming an 85 per cent. yield. To produce by distillation 1 Imperial gallon of 80 per cent. alcohol from wash of this strength requires an average consumption of 200,000 B.Th.U. For 95 per cent. alcohol the additional rectification necessary would bring this up to 300,000 B.Th.U. Breckler calculates that with coal at 13,000 B.Th.U. per lb. and costing 12s. 4d. per ton, the consumption of fuel would be 12 to 17 lb. and the cost 1d. to 1¼d. per Imperial gallon of 80 per cent. alcohol. At 1921 prices this would be increased at least three times, although it should be possible to reduce considerably the fuel consumption by the use of the most efficient types of still, combined with multiple effect evaporation.

An important point is the relation of the fuel consumption to the strength of the wash. The fuel necessary for the production of 1 gallon of alcohol will be roughly in inverse proportion to the percentage of alcohol in the wash. The effect of this in increasing the cost of dealing with weak washes is seen on reference to Fig. 20, where the strength of the alcoholic wash is plotted against a rough estimate of B.Th.U. required for the production of 1 gallon of 80 per cent. alcohol. The distillation costs for weak washes, such as fermented sulphite liquors, will be unduly high in proportion to those for the stronger washes obtained from starch and sugar

materials. If we take 1½d. as the cost of distilling 1 gallon of alcohol from a wash which originally contained 4 per cent. fermentable sugars, with coal at 12s. 4d. a ton, this will correspond to approximately 11d. for the same quantity of alcohol distilled from a wash originally containing 1·5 per cent. of fermentable sugars, with coal at, say, 40s. per ton. This cost represents that of fuel for distillation alone. To it must be added cost of power for pumping, etc., labour, and overhead charges.

Statistics.—Various estimates have been given of the quantity

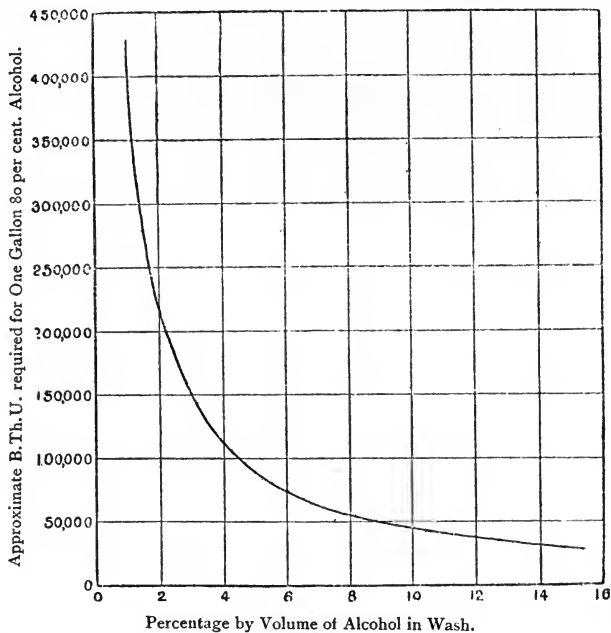

FIG. 20.—Approximate B.Th.U. required for Production of One Gallon 80 per cent. Alcohol from Wash of Different Strengths.

of sulphite spirit produced at pulp mills in Sweden, Germany, and Canada. In 1918, the four established sulphite spirit distilleries in Sweden produced about 3 million litres of alcohol per annum. Plants were then being put up or projected at many other mills, and it was held that under the most favourable conditions the output of sulphite spirit should reach 36 million litres.⁷¹ This would seem to be a somewhat generous estimate. The output of sulphite cellulose was seriously affected by the war, and in 1919 was still only 64 per cent. of the normal pre-war figure. In 1920 it was stated that twenty-two mills would shortly be equipped with

distilleries, with an output of 17 million kgm. (21 million litres) of 95 per cent. spirit.⁷²

Twelve of the largest sulphite cellulose factories established in Germany in 1918 represented a possible production of 11½ million litres of alcohol, and it was estimated that this quantity could be doubled if alcohol were produced at all the pulp mills in that country.

According to the report of the Hon. Advisory Council for Scientific and Industrial Research of Canada, referred to above, the possible production from Canadian pulp mills would be about 5 million gallons of 95 per cent. alcohol. In 1910, Ekström calculated that if alcohol were recovered from all the sulphite pulp mills throughout the world, the total quantity would be about 55 million gallons (250 million litres).

NATURE OF THE SUGARS FORMED BY HYDROLYSIS OF WOOD

From the foregoing it will be gathered that there is some uncertainty as to the actual source of the fermentable sugars resulting from the hydrolysis of wood, and it is not clear to what extent they are derived from the cellulose or the non-cellulose constituents. As has been pointed out, the dividing line between cellulose and non-cellulose is by no means sharp, and it is possible that hexose groups are associated more or less with all parts of the lignocellulose complex, the extent to which they are split off from one part or another depending upon the conditions of hydrolysis.

These conditions are less severe in the production of sulphite pulp than in the processes which have for their object the production of sugar from sawdust. In the former case the object is to remove as much as possible of the non-cellulose constituents without injuring the cellulose, and in the latter to attack the cellulose and break it down into sugars.

The action of concentrated acids upon cellulose has been shown to result in the formation of dextrose, and it is possible when working under laboratory conditions to obtain a yield of alcohol not far short of the theoretical amount. The yields obtained when dilute acids are employed are much lower. The highest yields recorded by Tomlinson in his process correspond to a conversion of approximately 25 to 28 per cent. of dry wood substance into fermentable sugar.

Ost and Wilkening⁷³ pointed out that on heating with dilute acids at high temperatures and pressures dextrose yields reversion products which show a smaller copper reduction but a higher polarisation than dextrose. At lower temperatures (120° to 145° C.)

these reversion products are not formed, but dextrose decomposes in another direction, giving levulinic and formic acids and humic substances. This progressive decomposition is indicated by the following results (Ost and Wilkening) :

Per cent. Dextrose.	Per cent. H ₂ SO ₄ .	Hours Heated.	Temperature.	Dextrose found by	
				Reduction.	Polarisation.
				Per cent.	Per cent.
5	2	3	120°	91.4	91.0
5	2	8	120°	70.3	71.0
5	2	1½	145°	67.7	67.5
5	2	5	145°	{ 28.6	28.9
				{ 35.1	35.0

These investigators further found that when 5.022 gms. of cotton cellulose (4.718 gms. dry matter) were heated under pressure with 100 c.c. of 1 per cent. sulphuric acid for two hours at 150° C., and the treatment repeated six times, the combined liquor from the first three boilings contained 29.1 per cent. of sugar calculated on the cellulose, and that from the second three boilings 15.2 per cent. of sugar, or 44.3 per cent. altogether. The dark-coloured residue was only slowly attacked by a repetition of the treatment with dilute acid under pressure, but on treatment with concentrated acid gave a further 42.7 per cent. of sugar calculated on the original cellulose. These experiments show how difficult it is to effect the conversion of cellulose into fermentable sugars by the action of dilute acids. Wohl and Blumrich⁷⁴ have suggested that when cellulose is heated with dilute acids, the reducing sugars which pass into solution interact, on continued heating, with the residue, and form highly resistant reversion products.

Klason⁷⁵ found that on boiling pinewood alternately with water and alcohol the extracted solids amounted to about 10 to 14 per cent. of the dry wood. The "wood gum" so extracted consisted of xylose 25 per cent., mannose 6 per cent., and a trace of galactose, the remaining 69 per cent. being sugars the nature of which could not be ascertained, but which Klason considered to be dextrose. The total quantity of fermentable sugars was 7.4 per cent. of the dry wood.

Haegglund⁷⁶ found 2.30 per cent. of total sugars in a sulphite liquor of normal specific gravity 1.052 at 15° C. The analysis of the liquor gave the following results :

SUGAR CONTENT OF NORMAL SULPHITE LIQUOR
(HAEGGLUND)

	Per cent. on Liquor.	Per cent. on Dry Wood.
Xylose . . .	0.69	3.11
Mannose . . .	0.96	4.32
Galactose . . .	0.06	0.27
Lævulose . . .	0.07	0.31
Dextrose
Undetermined . . .	0.52	2.35
	2.30	10.36

Of these, mannose, dextrose, and lævulose are easily fermented by yeast, and galactose only slowly. Xylose is not fermented at all.

The figures in the second column are calculated from the volume of the liquor and the weight of finished cellulose obtained. The total quantity of sugars is in agreement with Klason's figure of 10 to 14 per cent. of carbohydrates in pine wood. On fermenting the waste liquor the yield of absolute alcohol was 0.95 per cent. by volume. Haegglund assumes a 90 per cent. fermentation yield, which therefore indicates that of the 2.3 per cent. of total sugar 1.63 per cent. is fermentable and 0.67 per cent. unfermentable. The latter figure is approximately equal to the pentose content, therefore the undetermined sugars must be fermentable. The undetermined sugars probably consist partly or wholly of mannose, galactose, and lævulose, owing to the tendency to low results in the methods of estimating these sugars. Calculated on the dry wood, the fermentable sugars, exclusive of galactose, amount to 6.98 per cent., as compared with Klason's previous figure of 7.4 per cent. The conditions under which the sugars were extracted were different in both cases, and Haegglund gives a much higher proportion of mannose to xylose than does Klason. Moreover, it is not clear whether the species of conifer dealt with were the same in both cases, but taking the figures as a whole it would seem that the so-called "wood gum" constituent of pine wood is capable of accounting for the whole of the fermentable sugars in sulphite liquor.

Results recently obtained by Klason⁷⁷ on a Ritter-Kellner liquor derived from spruce wood show a high proportion of dextrose compared with other sugars :

SUGAR CONTENT OF SULPHITE LIQUOR FROM
SPRUCE WOOD (KLASON)

	Per cent. on Liquor.	Per cent. on Dry Wood.
Mannose . . .	0.526	2.5
Galactose . . .	0.279	1.3
Dextrose . . .	1.65	7.9
Arabinose . . .	0.90	4.3
	3.355	16.0

This particular liquor contained no xylose, and Klason considers that this sugar is not present in spruce, or at least only in small quantities. The alcohol obtained in practice results from the fermentation of dextrose and mannose only.

The figures found by other observers for total wood gum and for total fermentable sugar vary with different methods of extraction, but are usually of the same order as those given above.

It is probable that a partial destruction of the sugars takes place during the sulphite pulp "cook," and that this loss may be more or less balanced by further hydrolysis of the more resistant parts of the lignocellulose complex. Haegglund found that there was a clearly defined point during the cook at which the sugar content was at a maximum, and that if the process were prolonged beyond this point sugar was destroyed at a greater rate than it was formed by hydrolysis of the wood substance. According to V. K. Krieble, Canadian liquors fall into two classes, one containing 20 per cent. of the total organic matter in the form of reducing sugars, and the other 28 per cent. The difference is in all probability due to greater destruction of sugars in certain processes than in others. If the digestion is prolonged for much over ten hours, or if the temperature goes above 145° C., the yield of sugar will be materially reduced, the fermentable sugars being the first to be destroyed.

Haegglund has compared the sugars found in waste sulphite liquor with those formed in the Simonsen process of heating wood under pressure with dilute sulphuric acid. The following results were obtained in two experiments. In the first, 150 grms. of dry pinewood sawdust were heated with 1000 c.c. of 0.5 per cent. sulphuric acid at 155° to 165° C. for thirty minutes. In the second, 76 grms. of dry wood were heated with 750 c.c. of 0.5 per cent. sulphuric acid at 170° C. for forty-five minutes:

	Per cent. of Total Sugars formed.	
	Experiment I.	Experiment II.
Pentoses (xylose)	32.7	30.1
Mannose	35.6	43.7
Lævulose	4.3	4.7
Galactose	3.3	3.3
Dextrose	0.5	14.0
Undetermined	23.6	4.2
	100.0	100.0

In the first experiment the total yield of sugars amounted to 9 per cent. of the wood, and in the second case 14.5 per cent. The results are not very conclusive, but they indicated that cellulose is not attacked until a fairly high temperature is reached. Further, it would appear that in the Simonsen process as developed by Ewen and Tomlinson, the mannose, lævulose, and possibly the galactose of the wood gum represent a considerable proportion of the total fermentable sugars obtained, and their presence must be allowed for in estimating the extent to which the cellulose has been hydrolysed to sugar.

Ruttan, as a result of his experiments on the Classen process (treatment of wood with gaseous sulphur dioxide at 100 lb. pressure for forty-five minutes) advanced arguments to show that the sugar formed originated from the lignin or non-cellulose constituents of the wood.

He found that the residual material left after the extraction of soluble products consisted of cellulose which on further treatment with steam and sulphur dioxide yielded only a trace of sugar. This argument, however, does not appear conclusive, as it is possible that under the conditions of the process part of the cellulose is hydrolysed to sugars, and that the residue is changed into a modified cellulose which is resistant to the action of sulphur dioxide under pressure.

The actual hydrolytic agent in the Classen process is probably the sulphuric acid which is formed by oxidation to the extent of 0.3 to 0.4 per cent. of the total digester contents. The process thus occupies a position between the sulphite pulp and the Simonsen processes.

The yield of alcohol in the Classen process amounts to about 6 per cent. calculated on the dry wood, corresponding to 12 or 13

per cent. of fermentable sugars. Haegglund's experiments, already referred to, showed that in the sulphite pulp process only 7 per cent. of the wood is obtained as fermentable sugar. If waste sulphite pulp liquor contains, as appears probable, the whole of the sugars derivable from the non-cellulose constituents of the wood, then the Classen process must involve a partial hydrolysis of cellulose. In the latest forms of the sulphuric acid process with maximum yields of fermentable sugars corresponding to 25-28 per cent. of the dry wood, the action on the cellulose must be still greater.

The various processes in operation on a commercial scale for the hydrolysis of wood represent a gradual transition from the comparatively gentle action of the Mitscherlich "cook" to the far more vigorous hydrolysis of the Simonsen process. The breaking up of the lignocellulose complex and the formation and simultaneous decomposition of fermentable sugars will be progressive according as the conditions of hydrolysis are more severe. The conditions which favour a maximum of sugar formation will also in all probability produce the most rapid decomposition of those sugars when once split off from the parent groupings. The yield of fermentable sugars in any of these processes must therefore be dependent on the difference between the rate of formation and the rate of destruction of the sugars under the particular conditions obtaining, which renders it difficult to determine in any particular case the proportion in which they are derived from the different constituents of the wood.

The considerations which apply to wood will also apply in greater or less degree to straw, grasses, peat and various other cellulosic materials which have been suggested as possible sources of alcohol. It is clear that much further research is necessary to establish the conditions under which the full yield of non-cellulose sugars may be obtained combined with the maximum degree of hydrolysis of the residual cellulose. It would seem that to be commercially successful, such processes must fulfil certain conditions, namely, that a minimum amount of acid or other catalytic agent be used, and that the relative volume of liquor from which the alcohol has subsequently to be distilled, be kept as low as possible.

REFERENCES

¹ J. F. Briggs, *Analyst*, 1915, **40**, 107.

² For detailed information on the chemistry of cellulose, the reader is referred to *Cellulose*, by C. F. Cross and E. J. Bevan, London, 1893, together with the later quinquennial appendices, "Researches on Cellulose"; also to *Die Chemie der Cellulose*, by Carl Schwalbe, Berlin, 1911.

ALCOHOL FROM CELLULOSE MATERIALS 169

- ³ P. Klason, *Beiträge zur Kenntnis der Chemischen Zusammensetzung des Fichtenholzes*, Berlin, 1910.
- ⁴ W. Wislicenus and M. Kleinstück, *Zeitsch. Chem. Ind. Kolloide*, 1910, **6**, 17, 87.
- ⁵ J. König, *Chem. Zeitung*, 1912, **36**, 1101.
- ⁶ and ⁷ R. Willstätter and L. Zechmeister, *Berichte*, 1913, **46**, 2401.
- ⁸ H. Ost and L. Wilkening, *Chem. Zeitung*, 1910, **34**, 461.
- ⁹ M. Cunningham, *Trans. Chem. Soc.*, 1918, **113**, 173.
- ¹⁰ G. W. Monier-Williams, *Trans. Chem. Soc.*, 1921, **119**, 803.
- ¹¹ J. C. Irvine and C. W. Souttar, *Trans. Chem. Soc.*, 1920, **117**, 1489.
- ¹² P. Klason, No. 2 of *Schriften des Vereins der Zellstoff und Papier Chemiker*, Berlin, 1911, p. 28 ff.
- ¹³ J. F. Briggs, *Journ. Soc. Chem. Ind.*, 1918, **37**, 216R.
- ¹⁴ W. H. Dore, *Journ. Indust. and Engin. Chem.*, 1920, **12**, 264.
- ¹⁵ A. W. Schorger and D. F. Smith, *Journ. Ind. Eng. Chem.*, 1916, **8**, 494.
- ¹⁶ A. W. Schorger, *Journ. Ind. Eng. Chem.*, 1917, **9**, 748.
- ¹⁷ P. Klason, *Svensk, Pap. Tid.*, 1917, **20**, 176.
- ¹⁸ P. Klason, *Berichte*, 1920, **53** [B], 706, and 1864; and *Arkiv. Kem. Min. Geol.*, 1917, **6**, No. 15, 1-21.
- ¹⁹ H. Braconnot, *Ann. de chim. et de phys.*, 1819 (2), **12**, 172.
- ²⁰ J. E. Arrould, *Compt. Rend.*, 1854, **39**, 807.
- ²¹ G. A. Voerkeilius, *Wochenblatt*, 1911, **42**, 852.
- ²² M. Melsens, *Genie industriel*, 1855, 106.
- ²³ M. Payen, *Dingler's Journal*, 1867, **185**, 308.
- ²⁴ E. Simonsen, *D.R.P.*, 92,079 (1894), and *Zeitsch. für angew. Chemie*, 1898, **11**, 195, 219.
- ²⁵ T. Koerner, *Zeitsch. für angew. Chem.*, 1908, **21**, 2353.
- ²⁶ R. F. Ruttan, *Journ. Soc. Chem. Ind.*, 1909, **28**, 1290.
- ²⁷ Laskowsky, *Chem. Zeitung*, 1919, **43**, 51.
- ²⁸ and ²⁹ R. von Demuth, *Zeitsch. für angew. Chemie*, 1913, **26**, 786.
- ³⁰ *Chem. Trade Journ.*, 1918, **63**, 231.
- ³¹ Compagnie Ind. des Alcools de l'Ardèche, Fr. Pat. 391,057 (1908).
- ³² *Chem. Trade Journ.*, 1918, **63**, 231.
- ³³ W. P. Cohoe, *Journ. Soc. Chem. Ind.*, 1912, **31**, 513.
- ³⁴ E. Haegglund, *Journ. prakt. Chemie*, 1915, **91**, 358.
- ³⁵ F. W. Kressmann, *Journ. Ind. Eng. Chem.*, 1915, **7**, 920.
- ³⁶ G. H. Tomlinson, Convention of Canadian Chemists at Ottawa; see *Chem. Trade Journ.*, 1918, **63**, 103.
- ³⁷ C. G. Schwalbe, Ger. Pat. 305,690 (1916).
- ³⁸ H. Terrisse and M. Levy, Eng. Pat. 143,212 (1920).
- ³⁹ Zellstoff-Fabrik Waldhof, Ger. Pat. 305,180 (1917).
- ⁴⁰ Chem. Fabrik Rhenania, Ger. Pat. 304,400 (1917), 305,120 (1917), 316,696 (1917).
- ⁴¹ G. H. Tomlinson, *Journ. Ind. Eng. Chem.*, 1918, **10**, 859.
- ⁴² A. B. C. Rogers and C. H. Bedford, Eng. Pat. 144,079 (1919).
- ⁴³ S. H. Collins and A. Spiller, *Journ. Soc. Chem. Ind.*, 1920, **39**, 66T.
- ⁴⁴ T. Takeuchi, *Bull. Soc. Agric. Tokio*, 1908, **7**, 619.
- ⁴⁵ G. J. L. Pradel, Eng. Pat. 5128 (1907).
- ⁴⁶ R. Pique, *Bull. Assoc. Chim. Sucr. Dist.*, 1907, **24**, 1730.
- ⁴⁷ J. Reilly, *Industrial Alcohol*, Dublin, 1919.
- ⁴⁸ H. von Feilitzen and B. Tollens, *Berichte*, 1897, **30**, 2571.
- ⁴⁹ A. Stutzer, *Zeitsch. für angew. Chemie*, 1909, **22**, 1999.
- ⁵⁰ B. Johnsen, *Journ. Soc. Chem. Ind.*, 1918, **37**, 131T.

- ⁵¹ P. Klason, *Papierfabrikant*, 1909, 7; Festheft, p. 27.
- ⁵² Cf. "The Utilisation of Waste Sulphite Liquor: A Review of the Literature," compiled by B. Johnsen and R. W. Hovey, Department of the Interior, Canada, Forestry Branch, Bull. No. 66 (1919).
- ⁵³ A. D. J. Kuhn, *Woch. für Papier fab.*, 1919, 30, 2317-2319, 2388-2391.
- ⁵⁴ V. K. Krieble, *Paper. Ann. Conv. Nr.*, 1919, 23, 153-162.
- ⁵⁵ O. L. Berger, *Paper. Ann. Conv. Nr.*, 1919, 23, 104-114.
- ⁵⁶ J. H. Wallin, Norwegian Pat. 18,687 (1908); Swedish Pat. 267,808 (1907).
- ⁵⁷ G. Ekström, *Svensk. Kem. Tid.*, 1907, No. 7.
- ⁵⁸ W. Kiby, *Chem. Zeitung*, 1915, 39, 212, 261, 284, 307, 350.
- ⁵⁹ E. J. Ljungberg, *Papier Zeitung*, 1912, 36, 337, 490.
- ⁶⁰ J. H. Wallin, *Papier Zeitung*, 1912, 36, 1283.
- ⁶¹ R. Sieber, *Chem. Zeitung*, 1921, 45, 349.
- ⁶² E. Haegglund, *Die Sulfitablaugung und ihre Verarbeitung auf Alkohol*, Braunschweig, 1915; *Paper*, 1917-18, 21, No. 16, et seq.
- ⁶³ Swedish Pat., 34,624 (1912).
- ⁶⁴ T. Bokorny, *Chem. Zeitung*, 1919, 43, 64.
- ⁶⁵ E. Haegglund, *Die Sulfitablaugung und ihre Verarbeitung auf Alkohol*, Braunschweig, 1915.
- ⁶⁶ G. P. Forrester, *Papier Zeitung*, 1911, 36, 937.
- ⁶⁷ *Papir Journ.*, 1916, 4, 44.
- ⁶⁸ B. Johnsen, *Journ. Soc. Chem. Ind.*, 1918, 37, 1291. Cf. also "The Utilisation of Waste Sulphite Liquor," Department of the Interior, Canada, Forestry Branch, Bull. No. 66 (1919), for bibliography of the subject.
- ⁶⁹ R. H. McKee, *Pulp and Paper Mag.*, 1920, 18, 715-718.
- ⁷⁰ A. M. Breckler, *Journ. Ind. Eng. Chem.*, 1917, 9, 612.
- ⁷¹ *Board of Trade Journ.*, July 18, 1918.
- ⁷² *U.S. Com. Rep.*, June 3, 1920.
- ⁷³ H. Ost and L. Wilkening, *Chem. Zeitung*, 1910, 34, 461.
- ⁷⁴ A. Wohl and K. Blumrich, *Zeitsch. für angew. Chemie*, 1921, 34, 17.
- ⁷⁵ P. Klason, *Arkiv. för Kemi, Mineralogi o. Geologi*, 1908, 3, No. 6.
- ⁷⁶ E. Haegglund, *Biochem. Zeitsch.*, 1915, 70, 416.
- ⁷⁷ P. Klason, *Svensk. Pap. Tid.*, 1917, 20, 175.

CHAPTER VI

SYNTHETIC ALCOHOL

Synthesis from Ethylene.—The first synthesis of alcohol was effected by Hennell in 1828. He found that if ethylene $\text{CH}_2=\text{CH}_2$ were absorbed in concentrated sulphuric acid and the resulting liquid diluted and distilled, alcohol was produced :

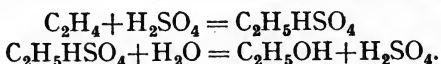

At that time the only method known of preparing ethylene in any quantity was by a reversal of the above equation, using alcohol as raw material. When it was subsequently found that ethylene was a constituent of coal gas and of the gases produced by the distillation of mineral oils, attempts were made to separate it from these gases by absorption in concentrated sulphuric acid.

Coke-oven gas contains from 1 to 4 per cent. of ethylene and coal gas up to 5 or 6 per cent., according to the temperature of carbonisation. At this low concentration ethylene is absorbed only slowly by sulphuric acid, and comparatively large quantities of acid have to be employed. P. Fritsche¹ in 1898 investigated the formation of ether from ethylene and sulphuric acid by the interaction of ethylsulphuric acid and alcohol :

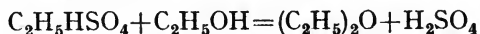

and in 1900 to 1901 a plant was erected in the United States for the production of ether in this way from the ethylene contained in oil-gas. The cost of manufacture is stated to have been about 6s. 3d. per gallon, and the process was discontinued in 1907 when industrial alcohol was made free of duty by the Act of Congress of 1906, and the price of ether prepared from it fell to 4s. 3d. per gallon.

More recently Bury² has carried out extensive investigations on the production of alcohol from the ethylene contained in coke-oven gas. The process does not appear so far to have been conducted on a manufacturing scale, the data given having been obtained from a small scale plant.³ Durham coking coal gives a gas containing 2.0 to 2.5 per cent. of olefines consisting chiefly of

ethylene. The gas was passed through the usual plant for the removal of tar, ammonia, naphthalene, and benzol, and then desulphurised in iron oxide purifiers or by adding sulphur dioxide. The latter gas reacts with the sulphuretted hydrogen present and causes the precipitation of sulphur. The gas then entered a scrubber containing 80 per cent. sulphuric acid, the object of which was to remove moisture and higher homologues of ethylene, such as propylene and butylene.

After being thus dried and purified the gas was passed up through towers constructed of sheet lead and packed with broken fused silica. Sulphuric acid of 95.4 per cent. strength was allowed to flow down the towers continuously at a temperature of 60° to 80° C. It was found that when the gas stream was so regulated that the time of contact of the gas with the acid was $2\frac{1}{2}$ to 3 minutes, 90 per cent. of the ethylene present in the gas could be absorbed at first. As the quantity of ethyl-sulphuric acid formed increased, the percentage absorption of ethylene became less, and if the acid were used until it had taken up 5 per cent. of its weight of ethylene, the average extraction amounted to 70 per cent. of the ethylene originally present in the gas. At temperatures lower than 60° to 80° C. the absorption was slow, and at higher temperatures decomposition occurred. A certain amount of sulphur dioxide was formed in the absorption towers, and it was proposed to utilise this for the preliminary removal of sulphuretted hydrogen from the gas.

The liquor from the towers could apparently be dealt with in two different ways. It was at first distilled direct in a column with a counter current of steam. The steam hydrolysed the ethyl-sulphuric acid, and alcohol distilled over at a strength of 95 per cent., the acid being at the same time reduced to 75 per cent. strength. This method seems to have been given up owing to the excessive frothing which occurred.

The second method was to dilute the liquor from the tower to 65 per cent. sulphuric acid by the addition of water under reduced pressure. The diluted liquid was then distilled under reduced pressure, steam being admitted towards the end of the operation. Distillation commenced at 94° C. and was complete at 146° C., the residual sulphuric acid being at a strength of 80 per cent. The distillate contained 15 per cent. of alcohol and was concentrated by redistillation in the usual way. Owing to the difficulty of removing completely the sulphuretted hydrogen from the gas, the alcohol obtained was contaminated with bodies containing sulphur.

It was estimated that a plant dealing with 5800 tons of coal per week should yield 9280 gallons of absolute alcohol, corresponding to 1.6 gallons of alcohol per ton of coal. This was based on a 70 per

cent. absorption of ethylene and a 70 per cent. conversion of the absorbed ethylene into alcohol. The cost was estimated at 2s. per gallon.

The main obstacle in the way of developing this process commercially would appear to be the large amount of concentrated sulphuric acid required. From figures given by Tidman⁴ for a small experimental plant, the amount of sulphuric acid used works out at six to seven times the weight of the alcohol produced. This acid would have to be reconcentrated and probably submitted to special purification processes before it could be used again for absorption of ethylene.

It would appear that a more rapid and complete absorption of ethylene by sulphuric acid can be effected in the presence of catalysts. Lebeau and Damiens⁵ in 1913 proposed the addition of 1 per cent. of vanadic anhydride or 6 per cent. of uranyl sulphate to the sulphuric acid used in the analytical estimation of ethylene by absorption from coal gas. Tungstic or molybdic acids could also be used. On these observations de Loisy⁶ based a process for the extraction of ethylene from coal gas. The gas after being dried and purified was bubbled through concentrated sulphuric acid (specific gravity 1.84) containing one or more of the above catalysts. In the process as patented⁷ a variety of catalysts were claimed, among them metallic sulphates, phosphoric and arsenious acids, ferrous sulphate, cuprous sulphate, etc. The dilute acid from which the alcohol had been distilled was reconcentrated by means of the hot furnace gases from the retorts and coke ovens.

In another process⁸ chlorosulphonic acid, $\text{Cl}\cdot\text{SO}_2\cdot\text{OH}$, is used as the absorbing liquid. The coke-oven gas, after removal of benzene, is dried and treated with a spray of 90 to 100 per cent. chlorosulphonic acid. The resulting liquid is stated to contain 90 to 100 per cent. of the ethyl ester of this acid, and to decompose on treatment with an equal volume of water into alcohol, hydrochloric, and sulphuric acids. Bronn^{8a} proposes to cool the purified coal gas in stages so as to yield a mixture of liquefied methane and ethylene, from which the ethylene may be obtained in an almost pure condition.

The conditions under which ethylene either pure or mixed with air is absorbed by sulphuric acid have been investigated by Plant and Sidgwick.⁹ The rate of absorption increased with the temperature, the strength of the acid and the percentage of ethylene in the gas, but at 100° C. considerable decomposition occurred. The theoretical increase in weight of the acid, corresponding to the quantitative formation of ethyl-sulphuric acid, is 28.57 per cent., but after a 20 per cent. increase in weight has been reached, a certain amount of diethyl sulphate $(\text{C}_2\text{H}_5)_2\text{SO}_4$ is formed.

The highest absorption observed corresponded with an increase in weight of 38.62 per cent. This was obtained by passing pure ethylene in excess through 100 per cent. sulphuric acid at 70° C. for thirty-two hours, and the resulting product contained 70 per cent. of ethyl-sulphuric acid and 30 per cent. of diethyl sulphate. When fuming sulphuric acid was employed the results were irregular owing to the formation of carbyl sulphate, the anhydride of ethionic acid $\text{CH}_2(\text{OSO}_3\text{H}) - \text{CH}_2(\text{SO}_3\text{H})$.

According to a recent patent¹⁰ the ethylene content of coal gas or coke-oven gas may be raised by repeated absorption by charcoal. The gas is freed from tar, ammonia, and benzene, and is then passed over absorbent charcoal at 0° C. to 20° C. The absorbed gas is then expelled and again subjected to the same treatment. By repeated absorption the ethylene content can be raised from 1 or 2 per cent. successively to 17, 36, and 59 per cent.

Synthesis from Acetylene.—Most of the processes now being developed on the Continent depend on the use of acetylene $\text{CH} \equiv \text{CH}$, as raw material. When powdered coke is heated with lime or chalk in an electric furnace, calcium carbide is produced, and this, on treatment with water, yields acetylene :

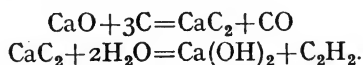

The synthesis of alcohol from acetylene can be effected in two ways, each of which involves the addition to the acetylene of hydrogen and water in separate stages :

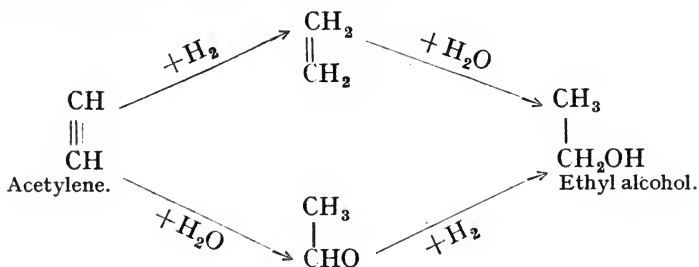

according to the way in which the reduction and hydration are carried out, either ethylene or acetaldehyde appears as one of the intermediate products.

Acetaldehyde can also be prepared direct from ethylene by heating the latter with carbon dioxide at 400° C.

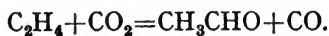

Many of the earlier patents for the synthesis of alcohol from acetylene depend upon the preliminary reduction of this gas to

ethylene. In Freeman's process¹¹ hydrogen under pressure was passed between the poles of an electric arc, and with careful adjustment of conditions and exclusion of air the product was stated to be almost pure ethylene.

Acetylene and hydrogen may be made to combine by passing them over a catalyst consisting of platinum together with another metal such as iron or copper,¹² but it is difficult to prevent the reduction going further and resulting in the formation of ethane C_2H_6 . Another method is that of Traube. Acetylene is passed under pressure into an acid solution of a chromous salt. It is thereby reduced to ethylene, and from the resulting chromic salt the chromous salt is regenerated by means of zinc or by electrolytic reduction.¹³ The liquid consists of 20 per cent. hydrochloric acid, to which is added 20 per cent. of crystallised chromous chloride and the same quantity of metallic zinc. This solution is shaken under pressure with 2 per cent. of acetylene. Ethylene is also stated to be formed when acetylene is passed into an aqueous solution of chromium and ammonium sulphates at $40^\circ C$.

In Arachequenue's process worked in Saxony in 1903 a mixture of metallic oxides was heated with coke in an electric furnace. The resulting carbide, "ethylogène," yielded ethylene on treatment with water, in the same way that calcium carbide yields acetylene. The quantity of coke required in this process is stated to have been 20 lb. per gallon of alcohol¹⁴ or four times the theoretical amount.

The pure ethylene prepared by any of the above methods may be converted directly into alcohol by the sulphuric acid process, as already described for coke-oven gas, or it may be converted into aldehyde by heating with carbon dioxide at $400^\circ C$.

One patentee¹⁵ proposes to pass ethylene into a solution of a mercury salt. The compound thus formed is subjected to anodic oxidation in aqueous solution, the acetaldehyde being removed by continuous distillation. It is claimed that this process also affords a means of separating ethylene from a gaseous mixture. But it would appear doubtful whether it could be applied to coke-oven or coal gas unless preceded by complete removal of sulphur from the gas.

Methods involving the reduction of acetylene to ethylene have not been successful on a technical scale, and have mostly given place to those in which acetylene is directly hydrated with formation of acetaldehyde, the latter body being then reduced to ethyl alcohol.

Conversion of Acetylene into Acetaldehyde.—In most of the patents which have been taken out for the direct conversion of

acetylene into acetaldehyde, the gas is passed through dilute sulphuric acid containing a mercuric salt which acts as a catalyst.¹⁶ The mercuric sulphate gradually becomes reduced by a portion of the aldehyde formed, and must be periodically reoxidised. In several of the earlier patents¹⁷ the solution contained 20 to 25 per cent. of sulphuric acid or 30 to 35 per cent. of phosphoric acid. Sometimes¹⁸ organic sulphonics acids were used, in a concentration of about 40 per cent., as it was found that under these conditions the acetylene was more readily hydrated.

The reaction vessels were of earthenware, and the temperature was kept as low as possible in order to avoid the formation of condensation products and the polymerisation of the aldehyde. The liquid contained about 2 per cent. of a mercury salt, and in one patent ferric sulphate and chromic acid were also added, as it was found that they decreased the rate at which the mercuric salt was reduced. The sludge from the reaction vessels contained metallic mercury and mercurous sulphate, together with resinous substances formed by polymerisation of the aldehyde. It was carbonised at a low temperature, and the mercury recovered as metal by electrolysis in a 10 per cent. solution of sodium hydrate.¹⁹

According to Shoji,²⁰ the yield of aldehyde when using 25 per cent. sulphuric acid containing 2 per cent. of mercuric oxide is 80 to 84 per cent. of the theoretical quantity.

Dreyfus in 1917²¹ used cylindrical vessels of 220 to 1100 gallons capacity made of iron lined internally with lead. The lead was coated with a layer of lead peroxide by treating it with nitric acid, the object being to avoid amalgamation by the mercury. The peroxide coating can also be produced electrolytically.²³ In a subsequent patent²² the vessels were constructed of ferrosilicon containing 12 to 17 per cent. of silicon. This alloy is resistant to hot dilute sulphuric acid and does not amalgamate with mercury. It possesses, however, certain disadvantages from the constructional standpoint. The shrinkage on casting is considerable, and the size and form of the vessel are therefore restricted. Ferrosilicon is extremely hard and brittle, and is in consequence difficult to machine and liable to crack. The unequal expansion caused by sudden heating is also apt to crack the casting. Lastly, it is much more expensive than earthenware.²⁴

Dreyfus employs a solution containing 10 to 15 per cent. of sulphuric acid and 3 to 6 per cent. of mercuric oxide, the mercury being completely dissolved in the liquid. Acetylene is passed into the solution at first slowly and then more rapidly, the temperature being kept down to 25° to 40° C., and the liquid well stirred. The reaction is carried out under a pressure of 0.5 atmospheres. It is

advisable to purify the acetylene before use from traces of sulphuretted hydrogen, phosphoretted hydrogen, and ammonia.

At intervals during the process the liquid is heated to 50°-60° C. and the aldehyde distilled off. When the mercuric sulphate has been so far reduced to mercurous sulphate and mercury that it is no longer sufficiently active, it is withdrawn and regenerated by oxidising agents. The yield of aldehyde is stated to be 90 to 95 per cent. calculated on the acetylene, and from five to ten times the weight of the mercury salt introduced.

The process was carried out in this country during the war, with the object of preparing acetic acid and acetone from the acetaldehyde produced.²⁵ The reaction mixture consisted of 20 per cent. sulphuric acid containing 1 per cent. of mercuric oxide and 2.5 per cent. of ferric sulphate. The temperature of the vessel was kept at 60° C. After passing a rapid current of acetylene through the vessel for two hours the quantity of aldehyde formed amounted to 20 per cent. of the reaction mixture. The action then slackened owing to reduction of the catalyst to metallic mercury and mercurous sulphate. The catalyst was reoxidised by the addition of oxidising agents, of which a variety were employed at various times. In the earlier patents, potassium permanganate (1 per cent.) and hydrogen peroxide (0.3 per cent.) were claimed, but these appear to have been replaced later on by lead dioxide, red lead, cerium oxide, or manganese dioxide. After addition of the oxidising agent the passage of acetylene was continued for another two hours, whereby an additional 13 per cent. of aldehyde was produced. Reoxidation and passage of acetylene were repeated until the total quantity of aldehyde amounted to over one hundred times the weight of mercuric oxide originally added, the total time being fifteen hours. When permanganate was used as the oxidising agent, the quantity required amounted to 3.8 per cent. of the aldehyde produced. At this stage the catalyst had become too highly contaminated with aldehyde by-products and resins, and it was necessary to empty the vessels and wash the sludge free from organic matter before reoxidising. The yield of acetaldehyde amounted to nearly 97 per cent. of the theoretical quantity. The use of pyrolusite in place of a soluble oxidising agent is stated to give a still better result. Thus, a reacting solution consisting of 200 c.c. of 20 per cent. sulphuric acid, containing 1 per cent. of mercuric oxide and 5 per cent. of ferric sulphate, will yield 489 grams of aldehyde in 30 hours if 11 additions of 2 grams of pyrolusite are made at intervals when absorption of acetylene slackens.^{25a}

In Canada the process²⁶ is carried out in much the same way.

The vessels are of ferrosilicon, of 1000 gallons capacity, and fitted with stirrers. The sulphuric acid is comparatively weak (6 per cent.), and a smaller quantity of mercuric oxide is added (25 lb. to each vessel). The temperature is kept down to 60°–65° C. by external cooling, and the pressure caused by the resistance of the gas scrubbers is less than 2 lb. per square inch. The reaction gases are led through a brine condenser at -10° to -15° C., where the greater part of the aldehyde is condensed, and thence through a cold water scrubber back to the reaction vessel. Water is added at intervals to the vessel to take the place of that which combines with the acetylene. The catalyst is not regenerated during the process, but mercuric oxide is added from time to time to replace that reduced. Eventually the sludge is withdrawn and the mercury recovered.

It is important to remove the aldehyde as rapidly as possible from the reaction mixture so as to minimise the formation of condensation products. By careful regulation of the stream of acetylene it is possible so to arrange matters that the unabsorbed gas carries away the heat of the reaction.²⁷ In one process the aldehyde is removed from the liquid under reduced pressure. The vacuum is applied to a second vessel set at a higher level than the main reaction vessel, so that while the liquid is drawn up continuously into the upper vessel and allowed to flow back to the lower one, the latter remains under atmospheric pressure. In this way aldehyde can be continuously withdrawn without raising the temperature of the reaction vessel²⁸ (Fig. 21).

Among processes for the regeneration of the catalyst are included several depending on continuous electrolytic oxidation. In one French patent portions of the reaction mixture are withdrawn at intervals by means of a branch pipe and made to traverse an electrolytic cell.²⁹ It is also claimed³¹ that continuous electrolytic regeneration may be effected in the reaction vessel itself. The latter is constructed of such a form that the reduced mercury comes into contact with the anode and is thereby reoxidised.

In the French process³⁰ above referred to, the hydration of the acetylene is carried out in a series of sandstone towers working on the counter-current principle (Fig. 22). The first tower A is used for removing the excess aldehyde from the reaction mixture containing the spent catalyst previous to its electrolytic regeneration. The main reaction takes place in the second tower B, and in the third and fourth, C and D, the aldehyde is absorbed from the gaseous current and at the same time polymerised by means of a 15 to 20 per cent. solution of sulphuric acid at 20° C. The object of the

temporary polymerisation of aldehyde is to obtain a better recovery of the product from the reaction gases by conversion into the less

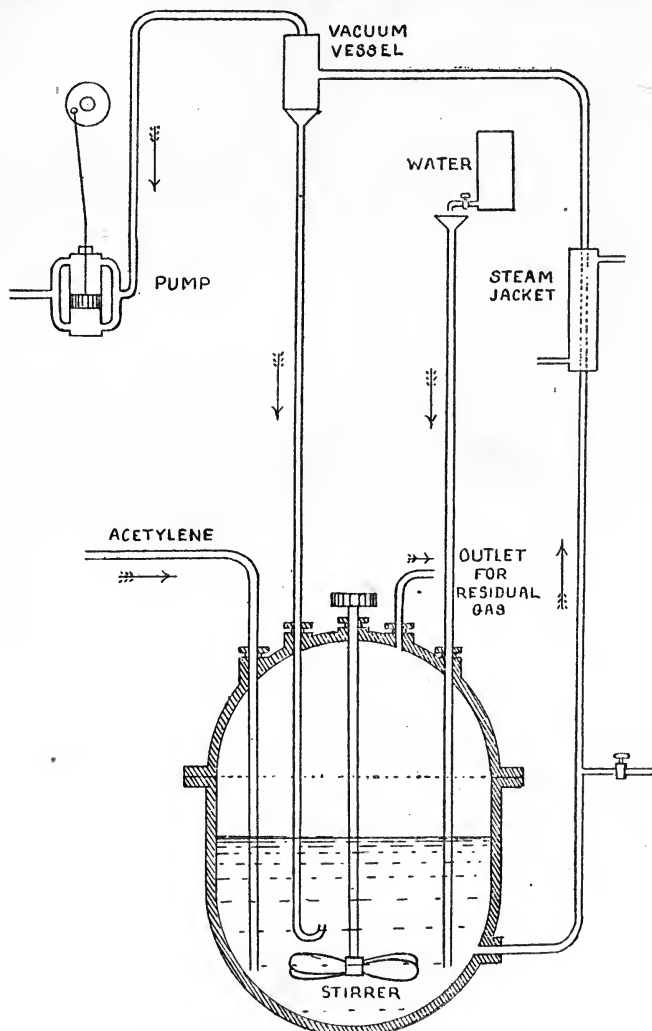

FIG. 21.—Removal of Acetaldehyde from Reaction Vessel under reduced pressure.

(Eng. Pat. 130,650, 1918.)

volatile and more easily handled paraldehyde, and it also makes it possible for the material to be temporarily stored if necessary. The plant is primarily designed for the continuous production of

acetic acid by oxidation of the aldehyde, for which purpose a fifth tower is added.

The rapidity of conversion of acetylene into acetaldehyde is

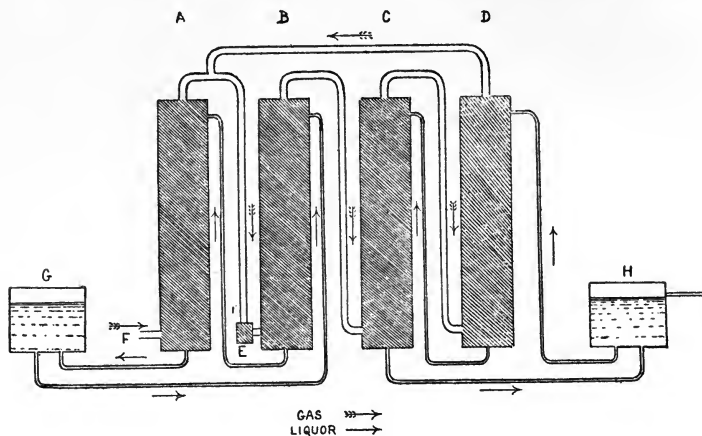
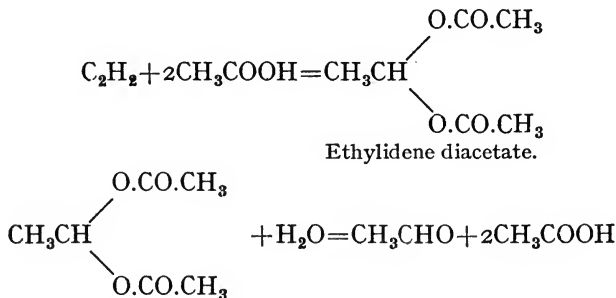

FIG. 22.—Diagram of Plant for Production of Acetaldehyde from Acetylene.

(Eng. Pat. 132,529, 1919.)

- A = Tower for removal of aldehyde from spent catalysts.
- B = Main reaction tower.
- C and D = Towers for polymerisation of aldehyde to paraldehyde.
- E = Fan.
- F = Acetylene inlet.
- G = Tank for electrolytic regeneration of catalyst.
- H = Tank for separation of paraldehyde from sulphuric acid.

greatly increased if the reaction be carried out in glacial acetic acid instead of in dilute sulphuric acid. Apparently the first product of the reaction is ethylidene diacetate which on addition of water is hydrolysed to acetaldehyde and acetic acid :



To the glacial acetic acid are added about 2 per cent. of sulphuric acid and 10 per cent. of mercuric oxide, and the temperature during

the passage of the acetylene is maintained at 80° to 90° C.³² The excess of acetylene passes through a fractionating apparatus, a condenser cooled by a freezing mixture, an absorption vessel charged with water, and then back to the reaction vessel. Water is added to the reaction vessel at the same rate as it is used up in hydrating the acetylene. According to Neumann and Schneider,³³ the best results on a laboratory scale are obtained with 96 per cent. acetic acid containing 3 per cent. of mercuric sulphate in solution, the temperature being maintained at 30° C. At higher temperatures the yield of aldehyde was not so good.

In some processes the ethylidene diacetate formed during the reaction is separated from the liquid and subsequently decomposed into acetaldehyde and acetic anhydride. Ethylidene diacetate boils at 169° C., and its decomposition can be effected either by passing the vapour through tubes filled with pumice stone at 250° to 300° C.,³⁴ or by heating the liquid under atmospheric pressure at 125° to 135° C., or under reduced pressure, in the presence of acid phosphates, metaboric acid or sulpho-acetic acid which act as catalysts.³⁵ In the preparation of ethylidene diacetate the glacial acetic acid contains 2 per cent. of methylene sulphate or other alkyl sulphates in place of sulphuric acid, and the reaction is carried out at 50° to 70° C.³⁶ The intermediate preparation of ethylidene diacetate is not undertaken unless the object is to prepare acetic anhydride as well as acetaldehyde.

Acetylene may also be hydrated to acetaldehyde by passing it together with steam over catalysts at a high temperature.^{37 38 39} The gas must previously be purified from phosphoretted hydrogen, or the catalyst is rapidly "poisoned." In one patent⁴⁰ acetylene is mixed with four parts of steam and passed over bog iron ore at 400° to 430° C., and in another,⁴¹ fifteen parts of acetylene and four hundred parts of steam are led through tubes containing molybdic acid and asbestos heated to 600° C. The yield of acetaldehyde in the latter process is stated to be 17 per cent. The molybdic acid catalyst is regenerated by a current of air at the same temperature.

When acetylene is treated with ozonised air in the presence of water, a mixture of glyoxal CHO.CHO and formic acid H.COOH is formed.⁴² If hydrogen be present as well, oxygen is evolved and the products of the reaction are acetaldehyde and alcohol. According to one patent,⁴³ 540 litres of ozonised oxygen are allowed to react at a low temperature with 45.6 litres of acetylene and 173 litres of hydrogen. The reaction product is neutralised with sodium carbonate and the aldehyde and alcohol separated by

fractional distillation. There are no records of this process having been successful on a commercial scale, and the yield of alcohol would appear to be too low.

Reduction of Acetaldehyde to Ethyl Alcohol.—The reduction of acetaldehyde to ethyl alcohol is carried out by the well-known process of Sabatier and Senderens,⁴⁴ in which the vapour mixed with hydrogen is passed over finely divided nickel at a temperature of 140° C. The nickel catalyst is prepared by reducing nickel oxide or salts of nickel in a stream of hydrogen at 350° C. The temperature limits within which the hydrogenation is carried out must be strictly controlled, since at higher temperatures the aldehyde is partially decomposed into methane and carbon monoxide, and moreover there is a tendency for the alcohol formed to be dehydrogenated and reconverted into aldehyde. Armstrong and Hilditch⁴⁵ have investigated the course of the reaction between the temperature limits 120° to 300° C. with both nickel and copper as catalysts. When using copper the yield of alcohol at 200° C. was 87.6 per cent. of that theoretically possible, while at 300° C. it was only 33.7 per cent. owing to a reversal of the reaction at this temperature. With nickel at 120° to 150° C. the yield of alcohol was 53.6 per cent. The gases must be carefully dried, since traces of water tend to prevent the hydrogenation of the aldehyde and to favour the reverse action.

Armstrong considers that the primary action of the catalyst is to enter into association with the aldehyde and that the resulting unstable complex is then resolved into other compounds. Small quantities (1 to 2 per cent.) of by-products, chiefly normal butaldehyde, crotonaldehyde, and ethyl acetate are always produced.

On the large scale the aldehyde vapour mixed with excess of hydrogen is passed through metal tubes packed with the catalyst and heated electrically to a temperature of 90° to 170° C. At least six times the theoretical quantity of hydrogen is used, otherwise the alcohol is contaminated with by-products and the reduction of the aldehyde is incomplete. In practice a still larger excess of hydrogen is used, up to thirty times the amount required by theory, in order that the gas stream may carry off the heat produced by the reaction, and reduce the amount of external cooling necessary.⁴⁶ About 80 per cent. of the aldehyde is reduced in one passage over the catalyst. After condensation of the alcohol the hydrogen containing the unreduced aldehyde is recirculated through the tubes together with more aldehyde.

At the Lonza works in Switzerland⁴⁷ it was found that ether was always present as a by-product, in some cases up to 15 per cent.,

but that if a small quantity of oxygen, not exceeding 0.3 per cent. of the gas, were introduced, the formation of ether was almost entirely prevented. In absence of oxygen the yield of alcohol at the end of a thirty-hour run fell to zero, but when 0.15 per cent. of oxygen was added, a 95 per cent. yield of alcohol was obtained in a run of 211 hours, and the proportion of ether was reduced to 0.5 per cent. of the condensed product.

Acetaldehyde may also be converted into alcohol by electrolytic reduction, and patents have been taken out for this process.⁴⁸ The aldehyde or paraldehyde is dissolved to a 10 per cent. solution in 5 to 10 per cent. sulphuric acid, and introduced into the cathode chamber of an electrolytic cell. The cathode consists of lead, antimonial lead, or mercury, and a current density of 2 to 3 amperes per square decimetre is employed, which is sufficient to maintain the temperature at about 40° C. By increasing the temperature, current density, percentage of acid or aldehyde, or the duration of the reduction, secondary products such as butyl and crotonyl alcohols, ethyl ether, and reduction and polymerisation products of crotonaldehyde are formed. If the cathode liquid contain a mercury salt, acetylene may be converted into alcohol in one operation, hydration of the acetylene occurring first under the catalytic influence of the mercury, and the acetaldehyde formed being then reduced to alcohol.⁴⁹

In connection with the decomposition of acetaldehyde into methane and carbon monoxide, mention may be made of a new process in which it is stated that alcohol can be obtained as a product of the interaction of water gas and certain other gases.⁵⁰ Details of the process have not so far been published, but it has been suggested that it may consist of a reversal of the reaction $\text{CH}_3\text{CHO} = \text{CH}_4 + \text{CO}$, with subsequent reduction of the aldehyde by the hydrogen of the water gas in presence of catalysts. It is stated that methyl alcohol can be produced by this process to the extent of 80 per cent. of the theoretical maximum.

The relationships between the various substances dealt with in the preceding pages are shown in the form of a chart in Fig. 23.

Economic Considerations.—It was reported in 1917 that the Lonza company in Switzerland were able to produce alcohol of second quality at 1s. 6½d. per Imperial gallon and pure industrial spirit at 1s. 7½d. At that time a plant developing 20,000 to 30,000 h.p. was in course of erection, with an estimated annual output of 2 to 2.7 million gallons. In 1918 a larger plant capable of an annual output of 28 million gallons was stated to be under construction, and the company appears to have contracted to supply rectified spirit

to the Swiss Government at approximately 1s. per gallon. In the same year a Norwegian factory was completed with an estimated annual output of 250,000 to 650,000 gallons. It has been estimated that the cost of producing a ton of aldehyde by the British process, using pyrolusite, exclusive of charges such as interest on capital and depreciation, and not including cost of carbide, is roughly 70s., corresponding to 3d. per gallon of aldehyde.⁵¹

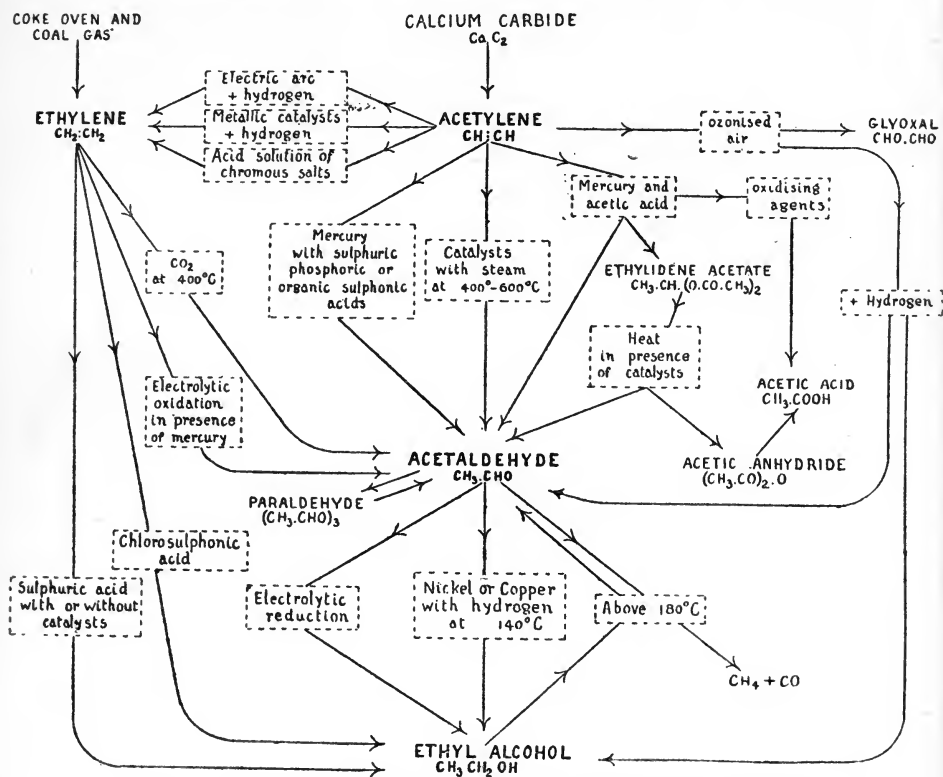

FIG. 23.—Chart showing Synthesis of Alcohol from Ethylene and Acetylene.

On the general question as to whether, apart from cost of production, it is sound policy to look to synthetic alcohol as one of the motor fuels of the future, the following points may be considered. The source of the carbon in synthetic alcohol is coal, while in fermentation alcohol it is derived from atmospheric carbon dioxide. Although the world's reserves of coal are ample, and there is little danger of their being exhausted within a reasonable period, it is likely that the cost of raising coal will gradually increase as the more

easily worked seams are used up and the accessibility of the material diminishes.

Economy in the use of coal is a matter of national importance, and it is questionable whether alcohol is the most economic form in which the available carbon can be utilised as a motor fuel. On the face of it, it would seem preferable to work in the direction of utilising more directly the heat of combustion of acetylene, possibly by polymerising it into hydrocarbons of higher boiling-point, rather than to add to it the elements of water which represents so much dead weight in the resulting fuel. Quite apart from this there is the question of the electrical energy required for the manufacture of calcium carbide from lime and coke. Where ample water power is available, the demands made upon coal are limited to that necessary for the actual formation of carbide in the furnace. It is claimed, however, that under the most favourable conditions electrical power may be obtained almost as cheaply in the neighbourhood of coal-fields as near waterfalls. Where coal is used as a source of power, it has been estimated that the amount consumed in the manufacture of synthetic alcohol is nine times as great as that required for the same quantity of fermentation alcohol.

Another point which has been raised has reference to the value as a fertiliser of calcium cyanamide, prepared from calcium carbide by the Frank-Caro process. One ton of carbide will yield approximately 110 gallons of alcohol. If the carbide is used for the production of calcium cyanamide, Ca.N.CN , the nitrogen thereby made available for crops amounts to 550 to 600 lb. Applied to potato land under normal weather conditions this quantity of nitrogen should result in an increase of over 20 tons in the crop yield. Twenty tons of potatoes will yield at least 400 gallons of alcohol, or nearly four times as much as could be obtained direct from one ton of carbide.

REFERENCES

- ¹ P. Fritsche, *Chem. Industrie*, 1898, **21**, 27; 1912, **35**, 637.
- ² E. Bury, *Cleveland Inst. Eng. Gas Journ.*, 1919, **148**, 718.
- ³ C. F. Tidman, *Journ. Soc. Chem. Ind.*, 1921, **40**, 86. Cf. also W. A. Bone, *Third Report of Brit. Assoc. Committee for Investigation of Fuel Economy*, etc., 1920.
- ⁴ C. F. Tidman, *loc. cit.*
- ⁵ P. Lebeau and A. Damiens, *Compt. Rend.*, 1913, **156**, 557.
- ⁶ E. de Loisy, *Compt. Rend.*, 1920, **176**, 50.
- ⁷ A. A. L. J. Damiens, M. C. J. E. de Loisy, and O. J. G. Piette, Eng. Pat. 152,495 (1919).
- ⁸ W. Traube, Eng. Pat. 147,543 (1920).
- ^{8a} I. Bronn, Ger. Pat. 338,358 (1916).

- ⁹ S. G. P. Plant and N. V. Sidgwick, *Journ. Soc. Chem. Ind.*, 1921, **40**, 147.
- ¹⁰ F. Bergius and P. Kalnin, Eng. Pat. 146,332 (1920).
- ¹¹ W. U. Freeman, Eng. Pat. 28,928 (1913).
- ¹² W. Karo, Ger. Pat. 253,160 (1911).
- ¹³ W. Traube, Ger. Pats. 287,565 (1913) and 295,976 (1914).
- ¹⁴ J. Reilly, *Industrial Alcohol*, Dublin, 1919.
- ¹⁵ G. O. Curme, Union Carbide Co., U.S. Pats. 1,315,541 and 1,315,543 (1919).
- ¹⁶ H. Erdmann and P. Köthner, *Zeitsch. anorg. Chem.*, 1898, **18**, 56.
- ¹⁷ Farbw. vorm. Meister Lucius & Brüning, U.S. Pats. 1,151,928 and 1,151,929 (1915).
- ¹⁸ Baeyer & Co., Fr. Pat. 469,497 (1914).
- ¹⁹ Chem. Fabrik Griesheim Elektron, Eng. Pat. 15,669 (1914).
- ²⁰ T. Shoji, *Journ. Chem. Ind. Tokio*, 1919, **22**, 28.
- ²¹ H. Dreyfus, Eng. Pat. 105,064 (1917).
- ²² H. Dreyfus, Eng. Pat. 115,899 (1917).
- ²³ M. Soller and J. L. R. Hotz, Eng. Pat. 151,086 (1919).
- ²⁴ G. B. Jones, *Chemical Age*, 1921, **4**, 394.
- ²⁵ J. Crosfield & Sons, and T. P. Hilditch, Eng. Pats. 124,702, 125,926, 131,084 (1919).
- ^{25a} *Journ. Soc. Chem. Ind.*, 1921, **40**, 236R.
- ²⁶ H. W. Matheson, Shawinigan Falls, Canada, Eng. Pat. 132,557 (1918).
- ²⁷ Konsort. für Elektrochem. Ind., Ger. Pats. 309,103 and 309,104 (1916).
- ²⁸ Comp. des Prod. Chim. d'Alais et de la Camargue, Paris, Eng. Pat. 130,650 (1918).
- ²⁹ Soc. des Aciéries et Forges de Firminy, Eng. Pat. 124,194 (1919).
- ³⁰ Soc. des Aciéries et Forges de Firminy, Eng. Pat. 132,529 (1919).
- ³¹ Soc. Chem. Ind. Basle, Eng. Pat. 130,138 (1918). Cf. also Chem. Fabrik Griesheim Elektron, Eng. Pat. 143,891 (1920).
- ³² Konsort. für Elektrochem. Ind., Eng. Pat. 5132 (1915). Cf. also H. Dreyfus, Fr. Pat. 479,656 (1914).
- ³³ B. Neumann and H. Schneider, *Zeitsch. für angew. Chemie*, 1920, **33**, 189.
- ³⁴ Bosnische Elektrizitäts A.-G. Vienna, Eng. Pat. 23,190 (1914).
- ³⁵ Soc. Chim. des Usines du Rhône, Eng. Pats. 110,906 (1917) and 131,399 (1918).
- ³⁶ Soc. Chim. des Usines du Rhône, Eng. Pat. 112,766 (1917).
- ³⁷ A. Desgrez, *Bull. Soc. Chim.*, 1894, III Série, **11**, 363.
- ³⁸ W. A. Bone and G. A. Andrew, *Proc. Chem. Soc.*, 1905, **21**, 221.
- ³⁹ A. Tchichibabin, *Journ. Russ. Chem. Soc.*, 1915, **47**, 703.
- ⁴⁰ Chem. Fabrik Rhenania, Eng. Pat. 109,983 (1916).
- ⁴¹ Deutsche Gold und Silber Scheide-Anstalt, Eng. Pats. 107,584 and 107,585 (1917).
- ⁴² A. Wohl and K. Bräunig, *Chem. Zeitung*, 1920, **44**, 157; Ger. Pat. 324,202 (1916).
- ⁴³ Jay & Co., Ger. Pat. 149,893 (1902).
- ⁴⁴ P. Sabatier and J. B. Senderens, *Compt. Rend.*, 1903, **137**, 301.
- ⁴⁵ E. F. Armstrong and T. P. Hilditch, *Proc. Roy. Soc.*, 1920, **97**, [A] 259.
- ⁴⁶ A. G. Bloxam, Elektrizitätswerk Lonza, Gampel, Switzerland, Eng. Pat. 120,163 (1918).

⁴⁷ Elektrizitätswerk Lonza, Eng. Pat. 134,521 (1919) ; Ger. Pat. 312,589 (1918).

⁴⁸ P. V. H. Pascal, France, Eng. Pats. 140,115 (1918) and 140,527 (1919).

⁴⁹ Chem. Fabr. Griesheim Elektron, Ger. Pat. 328,342 (1917).

⁵⁰ G. O. Calvert, Twickenham, *Chemical Age*, April 2, 1921.

⁵¹ *Journ. Soc. Chem. Ind.*, 1921, **40**, 346R.

CHAPTER VII

EXCISE SUPERVISION AND DENATURATION

Alcoholometry.—For Revenue purposes in this country, the amount of alcohol contained in commercial spirits is calculated from the specific gravity of the liquid. In view of its importance in the assessing of duty, the specific gravity of mixtures of alcohol and water has been the subject of repeated investigations. The tables used for many years by the British Excise authorities were based upon the original determinations of Blagden and Gilpin made in 1790 to 1794. In these tables the alcohol taken as a basis was of specific gravity 0·82514 at 15·5°/15·5° C. corresponding to 88·974 per cent. by weight of absolute alcohol.

There is some doubt as to the correct specific gravity of absolute alcohol owing to the difficulty of eliminating the last traces of water, and this accounts in great measure for the differences observed in the various tables published subsequent to those of Blagden and Gilpin. Tralles in an investigation carried out in 1811 for the Prussian Government obtained the value 0·7946 for absolute alcohol at 15·6°/15·6° C. Tables based on this figure were officially adopted in Germany, but were replaced later on by others calculated from the value 0·79359 found by Mendeléeff in 1869. Fownes and Drinkwater in 1847, working independently, found the values 0·7938 and 0·79381 respectively, and Squibb in 1884 prepared alcohol of as low a specific gravity as 0·7935, but it is possible that this alcohol contained traces of ether. Stevenson's tables are based upon those of Blagden and Gilpin, and Hehner's upon Fownes's and Drinkwater's results. The tables now in use by the Board of Customs and Excise were published in 1912 after a careful revision of all the available data, and are given on pages 190 and 191 in greatly shortened form. Mendeléeff's figure of 0·79359 at 15·6°/15·6° C. (in air) is now accepted as the most accurate value for the specific gravity of absolute alcohol.¹

On mixing absolute alcohol with water a contraction in volume occurs, varying in degree according to the relative quantity of each of the liquids. The contraction is greatest when 100 c.c. of absolute alcohol are mixed with 248 c.c. of water, giving a mixture

EXCISE SUPERVISION AND DENATURATION 189

corresponding to $C_2H_6O.8H_2O$.² This mixture occupies a volume, not of 348 c.c., but of 339 c.c., showing that a contraction of 9 c.c. has taken place on mixing the two liquids. The specific gravity of the mixture is 0.9660 instead of 0.9407, the latter being the value calculated on the assumption that no contraction takes place.

In Great Britain the content of alcohol by volume in any liquid is always reckoned officially in terms of "proof spirit." This term was originally introduced when the strength of alcohol was tested by pouring it over gunpowder and observing whether the water content was sufficiently high to prevent the combustion of the powder. Proof spirit was legally defined in the Hydrometer Act of 1818 (58 Geo. III. c. 28) as alcohol of such a strength that at a temperature of 51° F. a given volume weighs $\frac{1}{3}$ ths of the weight of an equal volume of distilled water. The temperature of the water was not specifically stated, but is taken as being 51° F. One hundred volumes of an alcoholic liquid of strength 25 over proof (o.p.) contain alcohol equivalent to $100 + 25 = 125$ volumes of proof spirit, while 100 volumes of a spirit of 25 under proof (u.p.) are equivalent to $100 - 25$ or 75 volumes of proof spirit. Proof spirit contains 49.28 per cent. of alcohol by weight or 57.10 per cent. by volume at 15.5° C. Absolute alcohol is 75.35 over proof.

The following equations may be used for calculating the percentage of alcohol by weight and volume from the percentage of proof spirit, and *vice versa*, where :

W=percentage of alcohol by weight.

V=percentage of alcohol by volume.

P=percentage of proof spirit.

D=specific gravity.

$$V = P \times 0.5703 \qquad V = \frac{WD}{0.7936} = WD \times 1.2601$$

$$P = \frac{V}{0.5703} = V \times 1.7535 \qquad P = WD \times 2.2095$$

$$W = \frac{P}{D \times 2.2095} \qquad W = \frac{V \times 0.7936}{D}$$

The amount of water required to reduce alcohol of a given strength by volume to a lower strength is given by the following equation :

$$x = \frac{V_1}{S_2} (D_2 S_1 - D_1 S_2)$$

where x is the quantity of water required in gallons,

V_1 is the initial volume of alcohol in gallons at strength S_1 and gravity D_1 ,

S_2 is the required strength, and

D_2 the gravity at this strength.

POWER ALCOHOL

ALCOHOL TABLE

SPECIFIC GRAVITY AT 60°/60° F. (15·56°/15·56° C.)

Specific Gravity in Air at 60°/60° F.	Percentage of Proof Spirit.	Percentage of Alcohol.		Specific Gravity in Air at 60°/60° F.	Percentage of Proof Spirit.	Percentage of Alcohol.	
		By Weight.	By Volume at 60° F.			By Weight.	By Volume at 60° F.
0·7936	175·35	100·00	100·00	0·8450	151·55	81·20	86·45
0·7940	175·21	99·87	99·92	0·8460	150·97	80·79	86·12
0·7950	174·87	99·55	99·72	0·8470	150·39	80·39	85·79
0·7960	174·52	99·22	99·52	0·8480	149·80	79·98	85·46
0·7970	174·16	98·90	99·32	0·8490	149·21	79·57	85·12
0·7980	173·80	98·57	99·12	0·8500	148·62	79·17	84·78
0·7990	173·44	98·24	98·91	0·8510	148·03	78·76	84·44
0·8000	173·07	97·91	98·70	0·8520	147·43	78·35	84·11
0·8010	172·71	97·58	98·49	0·8530	146·83	77·94	83·77
0·8020	172·33	97·25	98·28	0·8540	146·23	77·53	83·42
0·8030	171·94	96·91	98·06	0·8550	145·62	77·12	83·08
0·8040	171·56	96·57	97·84	0·8560	145·01	76·71	82·73
0·8050	171·16	96·23	97·61	0·8570	144·39	76·29	82·38
0·8060	170·77	95·89	97·39	0·8580	143·78	75·88	82·03
0·8070	170·37	95·55	97·16	0·8590	143·16	75·47	81·68
0·8080	169·96	95·20	96·93	0·8600	142·54	75·05	81·32
0·8090	169·54	94·85	96·69	0·8610	141·91	74·64	80·97
0·8100	169·13	94·50	96·45	0·8620	141·28	74·22	80·61
0·8110	168·70	94·15	96·21	0·8630	140·65	73·80	80·25
0·8120	168·28	93·80	95·97	0·8640	140·02	73·39	79·89
0·8130	167·84	93·44	95·72	0·8650	139·38	72·97	79·53
0·8140	167·41	93·08	95·47	0·8660	138·74	72·55	79·16
0·8150	166·96	92·72	95·22	0·8670	138·10	72·14	78·80
0·8160	166·51	92·36	94·97	0·8680	137·46	71·72	78·43
0·8170	166·06	92·00	94·71	0·8690	136·81	71·30	78·06
0·8180	165·60	91·63	94·45	0·8700	136·16	70·88	77·69
0·8190	165·14	91·27	94·19	0·8710	135·50	70·46	77·32
0·8200	164·67	90·90	93·92	0·8720	134·84	70·04	76·94
0·8210	164·20	90·53	93·65	0·8730	134·19	69·61	76·57
0·8220	163·72	90·16	93·38	0·8740	133·53	69·19	76·19
0·8230	163·23	89·79	93·10	0·8750	132·87	68·77	75·82
0·8240	162·75	89·41	92·83	0·8760	132·19	68·35	75·44
0·8250	162·26	89·03	92·55	0·8770	131·53	67·93	75·06
0·8260	161·76	88·65	92·26	0·8780	130·86	67·51	74·68
0·8270	161·26	88·27	91·98	0·8790	130·18	67·09	74·29
0·8280	160·75	87·88	91·69	0·8800	129·50	66·66	73·91
0·8290	160·24	87·50	91·40	0·8810	128·82	66·23	73·52
0·8300	159·73	87·11	91·11	0·8820	128·14	65·81	73·13
0·8310	159·21	86·73	90·81	0·8830	127·45	65·38	72·74
0·8320	158·69	86·34	90·52	0·8840	126·77	64·96	72·34
0·8330	158·16	85·95	90·22	0·8850	126·07	64·53	71·95
0·8340	157·63	85·56	89·91	0·8860	125·37	64·10	71·55
0·8350	157·09	85·17	89·61	0·8870	124·67	63·67	71·15
0·8360	156·56	84·78	89·30	0·8880	123·97	63·24	70·75
0·8370	156·02	84·38	88·99	0·8890	123·27	62·81	70·35
0·8380	155·47	83·99	88·68	0·8900	122·56	62·38	69·95
0·8390	154·92	83·59	88·37	0·8910	121·85	61·95	69·55
0·8400	154·37	83·20	88·06	0·8920	121·14	61·52	69·14
0·8410	153·81	82·80	87·74	0·8930	120·42	61·09	68·73
0·8420	153·25	82·40	87·42	0·8940	119·70	60·66	68·33
0·8430	152·69	82·00	87·10	0·8950	118·98	60·23	67·92
0·8440	152·12	81·60	86·77	0·8960	118·26	59·80	67·50

EXCISE SUPERVISION AND DENATURATION 191

ALCOHOL TABLE (Continued)

Specific Gravity in Air at 60°/60° F.	Percentage of Proof Spirit.	Percentage of Alcohol.		Specific Gravity in Air at 60°/60° F.	Percentage of Proof Spirit.	Percentage of Alcohol.	
		By Weight.	By Volume at 60° F.			By Weight.	By Volume at 60° F.
0·8970	117·54	59·37	67·09	0·9490	73·06	34·92	41·75
0·8980	116·81	58·93	66·67	0·9500	71·98	34·37	41·13
0·8990	116·07	58·50	66·25	0·9510	70·87	33·81	40·50
0·9000	115·33	58·06	65·83	0·9520	69·76	33·25	39·87
0·9010	114·59	57·62	65·41	0·9530	68·63	32·68	39·23
0·9020	113·84	57·18	64·98	0·9540	67·48	32·09	38·57
0·9030	113·10	56·75	64·56	0·9550	66·30	31·50	37·89
0·9040	112·35	56·31	64·13	0·9560	65·09	30·90	37·20
0·9050	111·58	55·86	63·70	0·9570	63·86	30·28	36·50
0·9060	110·82	55·42	63·26	0·9580	62·60	29·66	35·79
0·9070	110·06	54·98	62·83	0·9590	61·33	29·03	35·07
0·9080	109·29	54·54	62·39	0·9600	60·03	28·39	34·33
0·9090	108·51	54·10	61·95	0·9610	58·70	27·73	33·57
0·9100	107·74	53·65	61·51	0·9620	57·33	27·06	32·79
0·9110	106·97	53·21	61·07	0·9630	55·94	26·37	32·00
0·9120	106·20	52·77	60·63	0·9640	54·51	25·68	31·18
0·9130	105·41	52·33	60·19	0·9650	53·04	24·96	30·34
0·9140	104·63	51·88	59·74	0·9660	51·53	24·23	29·48
0·9150	103·84	51·43	59·29	0·9670	49·97	23·47	28·60
0·9160	103·05	50·98	58·83	0·9680	48·38	22·71	27·69
0·9170	102·24	50·53	58·38	0·9690	46·77	21·93	26·77
0·9180	101·43	50·08	57·92	0·9700	45·14	21·14	25·83
0·9190	100·62	49·62	57·45	0·9710	43·47	20·34	24·88
0·9200	99·80	49·17	56·99	0·9720	41·77	19·53	23·91
0·9210	98·98	48·71	56·52	0·9730	40·07	18·72	22·94
0·9220	98·16	48·25	56·05	0·9740	38·35	17·90	21·96
0·9230	97·33	47·79	55·57	0·9750	36·62	17·07	20·97
0·9240	96·49	47·33	55·10	0·9760	34·87	16·25	19·98
0·9250	95·64	46·87	54·62	0·9770	33·14	15·43	18·99
0·9260	94·80	46·40	54·14	0·9780	31·42	14·61	18·00
0·9270	93·95	45·94	53·65	0·9790	29·70	13·80	17·01
0·9280	93·09	45·47	53·16	0·9800	27·99	12·99	16·04
0·9290	92·23	45·00	52·67	0·9810	26·32	12·20	15·08
0·9300	91·36	44·53	52·18	0·9820	24·66	11·42	14·13
0·9310	90·50	44·07	51·68	0·9830	23·03	10·66	13·20
0·9320	89·61	43·59	51·18	0·9840	21·44	9·91	12·29
0·9330	88·72	43·11	50·67	0·9850	19·87	9·18	11·40
0·9340	87·81	42·62	50·15	0·9860	18·34	8·46	10·51
0·9350	86·89	42·13	49·63	0·9870	16·85	7·76	9·65
0·9360	85·97	41·64	49·10	0·9880	15·38	7·08	8·80
0·9370	85·04	41·15	48·57	0·9890	13·94	6·41	7·98
0·9380	84·10	40·65	48·04	0·9900	12·53	5·76	7·18
0·9390	83·15	40·15	47·50	0·9910	11·16	5·13	6·40
0·9400	82·19	39·65	46·95	0·9920	9·82	4·51	5·63
0·9410	81·23	39·14	46·40	0·9930	8·51	3·90	4·88
0·9420	80·26	38·64	45·85	0·9940	7·24	3·31	4·14
0·9430	79·27	38·12	45·28	0·9950	5·98	2·73	3·42
0·9440	78·26	37·60	44·71	0·9960	4·73	2·17	2·71
0·9450	77·24	37·07	44·13	0·9970	3·52	1·61	2·02
0·9460	76·21	36·54	43·54	0·9980	2·33	1·07	1·34
0·9470	75·17	36·00	42·95	0·9990	1·16	0·53	0·66
0·9480	74·12	35·46	42·35	1·0000	0·00	0·00	0·00

The official instrument for the determination of the amount of alcohol in a liquid is **Sikes's Hydrometer** (Fig. 24). This hydrometer consists of a hollow brass ball usually 1.5 to 1.6 inch in diameter, to opposite poles of which are affixed the stems. The lower of the stems is the shorter, being about 1.7 inch long, and is weighted so that the instrument floats in an upright position. The upper stem is usually about $3\frac{1}{2}$ inches long, and 0.2 inch wide, and 0.1 inch thick. It is graduated upon both its flat sides, the

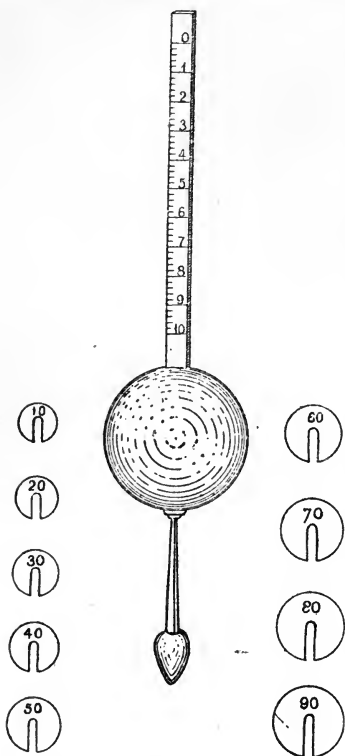

FIG. 24.—Sikes's Hydrometer.

highest mark being 0 and the lowest 10. The ten principal divisions are each subdivided into fifths, so that the scale bears fifty divisions in all. There are nine detachable weights with the instrument, which slip over the lower stem. They are numbered 10, 20, . . . 90, and the instrument is therefore capable of measuring a considerable range of specific gravities. A table is supplied with the hydrometer (p. 193) giving the strength of alcohol corresponding to the readings on the stem when different weights are attached. The accuracy of a Sikes's Hydrometer may be tested in the following manner :

1. Applied to spirits at proof strength at 51° F. (10.55° C.) the instrument should float at the proof mark when the weight 60 is on the stem. This mark is the fourth subdivisional reading from the zero point, or the indication 0.8. The total indication at the proof mark is therefore 60.8.

2. In distilled water at 51° F. with the brass cap (supplied with the instrument) on the stem top, and the weight 60 attached, the instrument will float at the proof mark 60.8. The weight of the brass cap is exactly one-twelfth of that of the instrument and the weight 60 taken together.

3. In distilled water at 51° F. with the weight 90 attached the hydrometer will float at the indication 10, giving a full indication of 100.

PROOF SPIRIT STRENGTH CORRESPONDING WITH THE INDICATIONS OF SIKES'S HYDROMETER. TEMPERATURE 60° F.

Indication.	Strength Over Proof.	Indication.	Strength Over Proof.
Light Hydrometer.		Ordinary Hydrometer.	
A 0	73·5	46	18·3
1	72·9	47	17·0
2	72·2	48	15·6
3	71·6	49	14·3
4	71·0	50	12·9
5	70·3	51	11·5
6	69·6	52	10·1
7	68·9	53	8·7
8	68·2	54	7·3
9	67·5	55	5·8
		56	4·4
Ordinary Hydrometer.		57	2·9
0	66·7	58	1·4
1	66·0		
2	65·2		Under Proof.
3	64·4	59	0·2
4	63·6	60	1·7
5	62·8	61	3·3
6	61·9	62	4·8
7	61·1	63	6·4
8	60·2	64	8·1
9	59·3	65	9·7
10	58·4	66	11·4
11	57·6	67	13·1
12	56·7	68	14·9
13	55·7	69	16·7
14	54·8	70	18·6
15	53·8	71	20·5
16	52·9	72	22·4
17	51·9	73	24·4
18	50·9	74	26·4
19	49·9	75	28·5
20	48·9	76	30·7
21	47·9	77	32·9
22	46·8	78	35·3
23	45·8	79	37·7
24	44·7	80	40·3
25	43·6	81	42·9
26	42·5	82	45·7
27	41·4	83	48·6
28	40·3	84	51·7
29	39·1	85	54·8
30	38·0	86	58·2
31	36·9	87	61·5
32	35·7	88	65·0
33	34·6	89	68·4
34	33·4	90	71·9
35	32·2	91	75·2
36	31·0	92	78·4
37	29·8	93	81·4
38	28·5	94	84·4
39	27·3	95	87·3
40	26·0	96	90·0
41	24·8	97	92·6
42	23·6	98	95·1
43	22·3	99	97·6
44	21·0	100	100·0
45	19·7		

Foreign Systems.—The proof spirit of the United States contains 50 per cent. by volume of alcohol, the tables being calculated on the basis of a specific gravity of 0.7946 at 15.6°/15.6° C. for absolute alcohol (Tralles). The hydrometer used is divided into 200 scale divisions, distilled water being represented by 0, proof spirit by 100, and absolute alcohol by 200. In most continental countries the centesimal scale is in use, hydrometers being graduated to show directly the percentage of alcohol in the liquid either by weight or by volume. The official tables vary to some extent according to the experimental data upon which they are based.

In France the proportion of alcohol in an alcoholic liquid is frequently estimated from the boiling-point of the liquid. Several forms of apparatus termed "ebullioscopes" or "ebullimeters" have been designed for this purpose. It is claimed that these instruments give results comparable in accuracy with those obtained from the specific gravity.³ Other methods depending on the refractive index, the freezing-point, the extent of dilatation by heat, the vapour tension, and the surface tension of mixtures of alcohol and water have been proposed, but none of these methods have come into general use in this country.

Excise Regulations.—In Great Britain alcohol has for many years been taxed at a much higher rate than in any other country. The Excise receipts from this source amounted in 1913-1914 to nearly 20 millions, or double this figure if one includes the duty on beer and the receipts from liquor licences. Recent years have seen the duty on spirits distilled in this country progressively raised until it now stands at £6, 3s. 3d. per gallon of 95 per cent. alcohol (£3, 14s. per proof gallon of immature spirits), and the Excise receipts have shown a corresponding increase. With a view to safeguarding this important source of revenue, the manufacture and sale of alcohol is subjected to close supervision on the part of the Excise authorities.

Official control is exercised both as regards the construction of the plant and the methods of working. Fermenting vats, or wash-backs, and wash-chargers must be so constructed as to allow of the official gauging of their contents, and vessels or stills must not be fitted with any pipes or outlets other than those expressly sanctioned by regulations. All outlets and receivers for distillates and finished spirits must be closed and secured by Revenue locks, and access to worm ends, or to any low wines, feints, or spirits can only be had after due notice has been given to the Excise officer and in his presence. Brewing and distilling operations may not be carried out simultaneously, and distilling may not commence until two hours after the whole of the fermented wash has

been collected in the wash-backs and wash-charger. These are but instances of the numerous restrictions and regulations controlling the manufacture of alcohol.

The most important restrictions, from the point of view of their effect in increasing the cost of manufacture, are the following :

- (1) The prohibition against brewing and distilling simultaneously.
- (2) The prohibition against mixing worts during fermentation.
- (3) Compulsory stoppage of work between Saturday and Monday.
- (4) Restrictions on the manufacture of yeast.

The older regulations concerning the manufacture of spirits were consolidated in the Spirits Act of 1860, and again in that of 1880. The latter is the principal governing Act at the present day, although it has been amended in certain particulars, mainly in the direction of granting extended privileges as to yeast removal and the denaturing of spirits.

Provided that the manufacture of alcohol is carried out on traditional lines, Excise supervision does not hamper unduly the routine operations of the distillery. Indulgences are frequently granted for minor improvements in processes, but any radical changes in methods of working, such as the introduction of the "amylo" process, or of continuous fermentation and distillation, are rendered difficult if not impossible.

When the present regulations were drawn up, the possibility that alcohol might be manufactured synthetically was not considered. Under Section 14 of the Finance Act, 1921, the Commissioners of Customs and Excise are empowered to make regulations for securing the duties on, and controlling the manufacture of, synthetic alcohol. Licences similar to those taken out by distillers will be required for the manufacture of alcohol from coal gas or calcium carbide.

Denaturation.—Alcohol, if intended for use free of duty for industrial purposes, must be "denatured" or rendered unfit for drinking. Great Britain was one of the first countries to allow the use of duty-free denatured alcohol, legislation to this effect being introduced in 1855. At this time the duty on alcohol in Great Britain averaged over 12s. per bulk gallon, while on the Continent the tax was so small that duty-paid spirit was largely used for industrial purposes. "Methylated spirits," as legalised in 1855, consisted of alcohol to which 10 per cent. of crude wood naphtha had been added, and was allowed to be used free of duty for manufacturing purposes only. From 1861 to 1891 it could be sold in small quantities by a licensed retailer for domestic use, but in the

latter year its use was again restricted to manufacturing operations, and methylated spirit for domestic use was further denatured by the addition of 0.375 per cent. of mineral naphtha of a specific gravity not less than 0.800 ("mineralised" methylated spirit).

As wood naphtha was an expensive substance, the quantity required to be added to "industrial" methylated spirit was reduced in 1906 from 10 per cent. to 5 per cent. on the recommendation of the Departmental Committee on Industrial Alcohol, and a rebate or "drawback" of 3d. per proof gallon (5d. per bulk gallon) was granted to compensate for the extra cost of production of the original plain spirit owing to Excise supervision. The composition of mineralised methylated spirit remained the same.

By Section 8 of the Finance Act, 1902, the use of specially denatured alcohol was permitted in manufacturing operations where the presence of methyl alcohol was inadmissible. Under special licence from the Commissioners of Inland Revenue, the denaturant used could be varied to suit the needs of any particular industry. Advantage is taken of the provisions of the 1902 Act in such operations as the manufacture of fulminate of mercury, where the alcohol used is denatured with 10 per cent. of the spirit recovered in the process of manufacture together with 0.025 per cent. of bone oil. In the manufacture of tolidine and benzidine the denaturant may consist of 2 per cent. of nitrotoluene, and in the production of xylonite camphor may be used. These are, however, isolated instances, and for practical purposes the only denaturants hitherto used in this country are wood naphtha and petroleum.

During the war difficulty was experienced in obtaining supplies of wood naphtha, and as a temporary measure the amount added was reduced, the proportion of mineral naphtha being at the same time increased. In 1918 three grades of methylated spirit were sanctioned, with the following composition :

- (i) Industrial methylated spirit (ordinary)—
Wood naphtha, 2 per cent. Mineral naphtha, 0.5 per cent.
- (ii) Industrial methylated spirit (special)—
Wood naphtha, 3 per cent.
- (iii) Mineralised methylated spirit—
Wood naphtha, 5 per cent. Mineral naphtha, 0.5 per cent. Methyl violet dye, 0.025 oz. per 100 gallons.

With the return of more normal conditions methylated spirit was again denatured according to the older formulæ, with the addition of methyl violet to the "mineralised" spirit.

The preparation of methylated spirit may only be carried out by an authorised methylator, who may also be a distiller or rectifier. Alcohol destined for methylation must be conveyed under bond to

the premises where the methylation is to take place, and an account of the quantity so delivered must be taken by a Revenue officer. The wood naphtha and mineral naphtha used must be previously examined and approved by the Government chemist or by some other duly appointed officer. After methylation the spirits may not be removed from the premises without a permit endorsed by a Revenue officer.

The use of industrial methylated spirit in manufacturing operations is subject, in greater or less degree, to Excise supervision. The user must obtain permission from the Board of Customs and Excise and must enter into bond for the proper use of the spirit. Revenue officers must be allowed to visit all parts of the factory where the spirit is used, and to take samples of the spirit and products at any stage of the manufacture. Where alcohol is specially denatured under the provisions of the 1902 Finance Act, Excise supervision is still more stringent, and the operation of denaturing must be carried out in the presence of a Revenue officer.

A licensed retailer of mineralised methylated spirit must not have in his possession at any one time a greater quantity than 200 gallons, and must not sell to any one person more than four gallons at a time. He is required to keep an account of all spirits received and sold, and this account must at all times be open to inspection by any officer of Inland Revenue.

It is obvious that the regulations and restrictions outlined above constitute a serious obstacle to the use of alcohol on any considerable scale as a motor fuel. The Interdepartmental Committee of H.M. Petroleum Executive in 1919 recommended that the existing regulations should be modified in several directions. Greater latitude should be allowed in respect both of the premises upon which denaturing may be carried out and of the vessels in which the necessary volumetric mixings are made. The usual bonded warehouse regulations should give place to special rules of a more elastic nature, and facilities should be given for the transport of power alcohol by rail or road in tank waggons instead of drums, barrels, or other small containers.

These recommendations have recently been carried into effect by the Power Methylated Spirits Regulations dated August 18, 1921, made by the Commissioners of Customs and Excise under Section 16 of the Finance Act, 1921. Under these regulations it is possible to import alcohol for power purposes as bulk cargo under Customs supervision. Alcohol so imported may be landed only at ports at which an approved tank warehouse is installed, and definite conditions are laid down as to the construction of the tanks and the procedure to be followed in transferring the alcohol to them. The conversion

of the alcohol into power methylated spirits may be carried out only by an authorised methylator. If this operation be not carried out in the tank warehouse, the alcohol may be conveyed to the methylator's premises in tank waggons under Revenue lock. Not less than 2500 gallons may be methylated at any one time. The power methylated spirits (p. 202) must be mixed in bond before use with at least 25 per cent. of petrol, benzol, or other approved substance. This may be done by an authorised user, provided that he receives not less than 1000 gallons at a time. After mixing, the spirit may be distributed without restriction, but may only be used for generating power.

Surtax on Imported Alcohol.—Under the Finance Act of 1920, the duty on immature spirits imported in cask is £3, 16s. 11d. per proof gallon, but if the spirits are produced in any part of the British Empire, the duty is £3, 14s. 5d. The Excise duty on similar spirits produced in this country is £3, 14s. per proof gallon. The difference in the case of foreign spirits is therefore 2s. 11d. per proof gallon or 4s. 10d. per bulk gallon at 95 per cent. strength. For Empire-produced alcohol the difference is 5d. per proof gallon or 8½d. per bulk gallon. Alcohol imported into bond for methylation is allowed in free of duty, but under the Finance Act of 1920 it had to pay the above differences between the Customs and Excise duties in each case. Thus power alcohol imported from a British Colony had to bear, in addition to the cost of methylation, a "surtax" or differential Customs duty of 8½d. per gallon, and if imported from a foreign country 4s. 10d. per gallon. This Customs surtax was originally introduced in 1860, when the old protective duties were abolished, in order to save the British distiller from being at a disadvantage, owing to the cost of Excise restrictions and supervision, as compared with his foreign competitor. There are in consequence considerable difficulties in the way of removing the surtax, unless the whole Excise system in this country is recast.

Under Section 11 of the Finance Act, 1920, it was provided that the allowance of 5d. per bulk gallon payable in respect of spirits used for making industrial methylated spirits should apply also to power methylated spirits. Thus, of the 8½d. differential duty on imported Empire alcohol, 5d. was refunded, so that the actual amount payable was 3½d. per bulk gallon. Since, however, the allowance of 5d. applied to both home- and Empire-produced alcohol, the former still received preferential treatment to the extent of 8½d. per bulk gallon.

Under the Finance Act of 1921, industrial or power alcohol produced in the Empire and imported into this country is exempt from the differential duty, and a corresponding reduction is made

EXCISE SUPERVISION AND DENATURATION 199

in the case of foreign spirits, but the allowance of 5d. per bulk gallon on imported spirits is withdrawn. At the same time, the allowance on home-produced alcohol is increased to 8½d. per bulk gallon. The effect of this would appear to be that while home-produced alcohol still receives a preference of 8½d. per gallon over imported Empire spirits and of 4s. 10d. over foreign spirits, power or industrial alcohol from all sources benefits to the extent of 3½d. per bulk gallon. The following table summarises the duties and allowances payable in respect of the three classes of alcohol under the Acts of 1920 and 1921 respectively :

	Differential Duty per Bulk Gallon.		Allowance Refunded.		Net Increase or Decrease in Cost of Alcohol.	
	1920	1921	1920	1921	1920	1921
Foreign spirits .	4s. 10d.	4s. 1½d.	5d.	nil.	+4s. 5d.	+4s. 1½d.
Empire spirits .	8½d.	nil.	5d.	nil.	+3½d.	nil.
British spirits .	nil.	nil.	5d.	8½d.	-5d.	-8½d.

Requirements of a Denaturant.—Before discussing the various denaturants which have been used in other countries or which have been proposed for power alcohol, the chief conditions which a denaturant must fulfil may be considered.

1. It must be soluble in alcohol, benzol, and petrol, and in certain mixtures of these.

2. It should impart a taste and smell sufficiently disagreeable to prevent the alcohol being drunk even after dilution, sweetening, or flavouring.

3. It should not be capable of being eliminated easily by filtration, distillation, precipitation, or by any other process which can readily be applied.

4. It should be capable of detection with ease and certainty even when present only in minute quantities.

5. It should be stable on keeping and should be unaffected by contact with metals. Conversely, it should not corrode metals, nor should the products of combustion be of an acid or corrosive nature, or possess an offensive smell.

6. It should not be actively poisonous.

7. It should not add materially to the price of denatured spirits as compared with that of ordinary duty-free alcohol.

8. It should be obtainable in sufficient quantity, and not be liable to great fluctuations in supply and price.

No substance has yet been found which fulfils satisfactorily all these conditions. The nearest approach to a perfect denaturant for ordinary purposes is crude wood naphtha, which contains on an average 77 per cent. of methyl alcohol and 10 per cent. of acetone, together with about 2 to 2.5 per cent. of esters, unsaturated compounds, and organic bases. Wood naphtha has the disadvantage of comparatively high cost,⁴ being nearly double the price of alcohol, and it is also liable to give rise to acid combustion products which may cause corrosion of the exhaust system in the engine. A further disadvantage from the fiscal point of view is that wood naphtha, unless it be present in comparatively large amount, does not render the alcohol sufficiently nauseous to prevent its being drunk after dilution and flavouring. Thus "mineralised" methylated spirit as sold to the public must contain a high proportion (10 per cent.) of wood naphtha together with sufficient petroleum to render it milky on dilution with water or proof spirit. Industrial methylated spirit with only 5 per cent. of wood naphtha is not so nauseous.

A fraud often practised on the Revenue is the mixing of small quantities of industrial methylated spirit with duty-paid spirit, and selling the mixture for human consumption. With an Excise duty on potable spirits of £3, 12s. 6d. per proof gallon, an admixture of less than 7 gallons of 95 per cent. industrial methylated spirit (=10 gallons of proof spirit approximately) with 90 gallons of duty-paid proof spirit would entail a Revenue loss of £36, 5s. This proportion of denatured alcohol would give less than 0.3 per cent. of methyl alcohol in the mixture, which approaches the limit at which the admixture of wood naphtha can be detected with certainty. If only half this amount of methylated spirit were added, thus reducing the methyl alcohol content to 0.15 per cent., the loss to the Revenue would still be over £18 on the 100 gallons, and the admixture would be difficult to prove.

The proportion of wood naphtha employed as a denaturant in various countries is roughly proportional to the amount of duty chargeable on the undenatured spirit, and to the consequent loss which the Revenue may suffer owing to admixture of the two. In Germany, where the tax on alcohol is much lower than in this country, the Revenue has less to fear from admixture and is sufficiently protected by the smaller amounts of wood naphtha prescribed (1 to 2 per cent.).⁵

⁴ The rise in price of wood naphtha in recent years has been attributed to the increased demand for methyl alcohol for the manufacture of formaldehyde, largely used as an insecticide in agriculture.

EXCISE SUPERVISION AND DENATURATION 201

The increase in cost of alcohol due to admixture with wood naphtha is shown by the following figures :

Year.	Cost of Alcohol per Bulk Gallon at 60 o.p.	Average Price of Wood Naphtha per Bulk Gallon.	Increase in Cost of Denatured Spirit due to Admixture with 10 per cent. of Wood Naphtha.	
			Actual.	Per Cent.
1906	1s. 4d.	} 2s. 8d.	1·60d.	10
1907	1s. 6½d.		1·36d.	7·3
1909	1s. 10¾d.		0·96d.	4·7
1914	2s. 1½d.	} 11s. 6d.	0·64d.	2·5
1919	7s. 2½d.		5·16d.	6

To the extra cost due to the wood naphtha must be added the expense of mixing, storing, carriage, and methylator's profit, but these items would be much the same whatever the denaturant used.

The allowance of 3d. per proof gallon, increased in 1921 to 5d. (8½d. per bulk gallon), payable in respect of all spirit destined for methylation, was intended to compensate for the enhanced cost of manufacture of the original plain spirit owing to Excise restrictions, and has no relation to the cost of subsequent methylation which is borne by the consumer.

Special Provision for Denaturing Power Alcohol.—In view of the high price of wood naphtha and the desirability of reducing the quantity of methyl alcohol to be added to motor fuels, the Interdepartmental Committee in 1919⁶ recommended that in all cases of approved use for power or traction purposes, where the user gives bond, the proportion of wood naphtha in alcohol might be substantially diminished, the difference being made up, wholly or partially, by petrol, benzol, or other nauseous substances, supplemented by a small quantity of methyl-violet dye. A further deterrent could be provided by the imposition of much heavier penalties than those now sanctioned by law for evasion of the spirits duty in any case of illicit purification of power alcohol to render it potable. Under Section 11 of the Finance Act, 1920, it is enacted that "the substance to be mixed with spirits for the purpose of methylation, shall, in the case of Power Methylated Spirits, be such substance or combination of substances, and shall be used in such proportion, as the Commissioners of Customs and Excise may by regulations prescribe." Still wider

powers are taken by Section 16 of the 1921 Act, under which Regulations have now been made.⁷ According to these Regulations power methylated spirits consist of alcohol of a strength of not less than 66 per cent. over proof, to which has been added not less than $2\frac{1}{2}$ per cent. by volume of wood naphtha, 0.5 per cent. of crude pyridine, and 5 per cent. of benzol. To every 1000 gallons of the mixture thus obtained is added $\frac{3}{4}$ oz. of "Eosin" (yellow shade) and $\frac{1}{4}$ oz. of "Spirit Red 3." All the denaturants must, before mixing, be examined and approved by the Government chemist, or other officer appointed in that behalf. The power methylated spirits thus prepared may not be taken out of bond for distribution until they have been mixed under Revenue supervision with at least 25 per cent. of petrol, benzol, or other approved substance, or unless they contain as an ingredient added in the course of manufacture not less than 25 per cent. of denatured ether. After such admixture they may be distributed without restriction for the purpose of generating mechanical power.

Denaturation in Other Countries.—In Germany there are two grades of industrial alcohol, completely denatured, and incompletely denatured. The liquid employed for complete denaturing consists of four parts of wood naphtha and one part of pyridine bases, to each litre of which may be added 50 grms. of essential oil to counteract the smell of the pyridine. The latter addition is, however, seldom made. Of this mixture $2\frac{1}{2}$ litres are added to each 100 litres of alcohol, so that the resulting methylated spirit contains 2 per cent. of wood naphtha and 0.5 per cent. of pyridine bases, with optionally 0.125 per cent. of lavender or rosemary oil. This spirit is intended for sale by retail for domestic purposes. For use in internal combustion engines a specially denatured spirit is allowed, in which half of the wood naphtha is replaced by benzol. The object of this is, apparently, to lessen the risk of corrosion due to the combustion products of methyl alcohol and acetone. This motor spirit contains, for every 100 litres, $1\frac{1}{4}$ litre of the above denaturing liquid, together with $\frac{1}{4}$ litre of a solution of methyl violet, and from 2 to 20 litres of benzol.

Incompletely denatured alcohol is allowed to be made and sold under special conditions, corresponding roughly with those governing the use of industrial methylated spirit in this country. The most usual grade of incompletely denatured spirit contains 5 per cent. of wood naphtha for which may be substituted 0.5 per cent. of pyridine. Other denaturants allowed in certain industries include camphor, turpentine, benzol, ether, and bone oil, and in this respect the regulations are not unlike those which operate in this country under the provisions of Section 8 of the Finance Act, 1902.

In France alcohol denatured by the "general" process contains, for each 100 litres of spirit, 10 litres of wood naphtha containing 25 per cent. of acetone and 2.5 per cent. of "impurités pyrogénées." Where the alcohol is used for heating, lighting, or motive power a rebate of 4d. per bulk gallon is allowed. For sale by retail the spirit is "mineralised" by the addition of 0.5 per cent. of a petroleum distillate. Specially denatured spirit may be used in certain manufacturing operations. Thus the French denatured alcohol contains approximately the same quantity of wood naphtha and mineral oil as our own methylated spirit, and although efforts have been made to popularise beet alcohol as a motor fuel, no special denaturing formula, such as those sanctioned in this country and in Germany, has been introduced.

In the United States denatured alcohol was not legalised till the year 1907. Before the Civil War alcohol was not subjected to any tax at all, but in 1868 a duty of 2s. 10d. per English proof gallon was imposed. In 1914 this had been increased to 6s. 3d. per proof gallon. In 1909 the revenue from alcohol produced in the U.S.A. amounted to £28,000,000, which was 60 per cent. of the total internal revenue and more than 20 per cent. of the entire revenue.⁸ In 1907 duty-free denatured alcohol was introduced for industrial purposes, the denaturant being 10 volumes of approved methyl alcohol and 0.5 volumes of approved mineral oil per 100 volumes of alcohol, the latter to be of a strength not less than 180° (158 per cent. of English proof spirit or 90 per cent. alcohol by volume). An alternative formula was allowed under which two parts of methyl alcohol and 0.5 part of pyridine bases could be added to a hundred parts of alcohol. Several subsequent amending acts and regulations were passed with the object of relaxing as far as possible the restrictions on agricultural distilleries. The present laws are stated⁹ to be more liberal than those of any other country where alcohol is an important source of revenue, but in spite of endeavours on the part of the American Government to encourage the small distiller, the production of alcohol as an adjunct to farming operations has, for various reasons, made hardly any progress. It would appear that under pre-war conditions there was not sufficient demand for alcohol to induce farmers to grow crops for this purpose alone. The beneficial influence of the distillery on the all-round productivity of the farm was not so obvious under American farming conditions as on the poor soils of Eastern Germany.

The compulsory use of wood naphtha as a denaturant in America has now been discontinued, owing largely to the demand for methyl alcohol for making formaldehyde and for other industrial purposes.

The denaturant now approved for power alcohol consists of 5 gallons of sulphuric ether, 2 gallons of "benzine," and 1 gallon of pyridine to every 100 gallons of ethyl alcohol.

In Australia, under the Spirits Act of 1906 and Regulations made under that Act, provision was made for two classes of spirit. The prescribed denaturants are :

(i) For industrial methylated spirits, 2 per cent. of wood naphtha, 0.5 per cent. of pyridine bases, and 0.5 per cent. of coal tar naphtha or shale naphtha.

(ii) For mineralised methylated spirit, 1 per cent. of wood naphtha, 0.25 per cent. of pyridine bases, 2 to 20 per cent. of mineral oil ("benzine") and 0.25 per cent. of a solution of a blue or violet dye.

Of the two, only the former is manufactured in Australia, there being little demand for spirits for lighting or heating purposes. The cost of the denaturants alone was, in 1918, 1.74 pence per gallon for industrial spirits and 1.36 pence for mineralised spirits, figures which were stated to represent an addition of about 10 or 15 per cent. to the cost of the alcohol.¹⁰

The Regulations regarding the denaturation of industrial spirit have since been amended. The spirit before methylation must be of a strength not less than 60 over proof, and must be mixed with 1 per cent. of wood naphtha, $\frac{1}{2}$ per cent. of pyridine, and 2 per cent. of approved petroleum distillate, coal tar naphtha, or shale naphtha.

Alternative Denaturants.—Besides wood naphtha or methyl alcohol, pyridine, and mineral oils, the chief denaturants which have at various times been used or proposed include benzol, tar oil distillates, turpentine, ether, bone oil, "caoutchoucine," formaldehyde, nicotine or tobacco oil, and various essential oils. It has also been claimed that in the electrolytic reduction of acetaldehyde to alcohol the bodies formed by reduction and polymerisation of crotonaldehyde and acrolein act as effective denaturants (p. 183).

Alcohol mixed with a high proportion (25 to 40 per cent.) of benzol has been used for some years as a motor spirit on the Continent, the benzol being not merely a denaturant but a valuable constituent of the resulting fuel. Benzol alone is too easily removed from alcohol by dilution and distillation to be capable of satisfying completely the requirements of a denaturant. According to Sidgwick and Spurrell,¹¹ benzene separates almost completely from its mixtures with alcohol if they are diluted with water to an alcoholic strength of 39 per cent. The aqueous liquid then contains less than 1 per cent. of benzene, and this could be further reduced by distillation.

EXCISE SUPERVISION AND DENATURATION 205

It will be seen on reference to the diagram on p. 73, that the relative ease with which any substance when present in small quantities may be removed from alcohol by distillation will depend on the value of the coefficient k as compared with that of alcohol at different dilutions. Substances which at all alcoholic strengths would pass over as "foreshots" on distillation are unsuitable as denaturants. It is more difficult to purify alcohol from, *e.g.*, amyl alcohol, which can behave either as "foreshots" or as "feints" according to the strength of the alcohol. The ideal denaturant should therefore show on distillation a behaviour analogous to that of amyl alcohol.

The Advisory Council of Science and Industry in Australia recommended in 1918 the use of coal tar distillates or creosote oil as a denaturant for power alcohol. This oil mixes with alcohol in any proportion and costs only about half as much as alcohol. Any proportion over 2 per cent. gives a decided brown colour to the spirit. It is nauseous to the taste and repulsive in smell. It cannot be separated by ordinary methods nor by simple distillation, and spirit denatured in this way shows a decided turbidity on dilution.

Ethyl ether, which is a constituent of several suggested motor fuels, is not by itself a sufficient denaturant. A committee appointed in South Africa ¹² to investigate the question, recommended that mixtures of alcohol and ether should contain at least 0.5 per cent. of pyridine bases and 2 per cent. of crude methyl alcohol, with an additional 1 per cent. of either crude methyl alcohol or benzol for every 10 per cent. of ether present.

Oil of turpentine has been approved for denaturation in certain cases by the Treasury Department, U.S.A.,¹³ and an oil obtained from the distillation of turpentine has been patented in Sweden for this purpose. It is stated to possess an extremely disagreeable taste and smell and to be not so poisonous as methyl alcohol. Another proposal¹⁴ is to saturate alcohol with acetylene and to add about 1 per cent. of acrolein, but the presence of acetylene in solution is open to certain objections (p. 309).

Among the other suggested denaturants are distilled bone oil and "caoutchoucine," a product of the distillation of vulcanised rubber. The oil obtained by the dry distillation of bones consists mainly of the nitriles of fatty acids, but also contains pyridine :

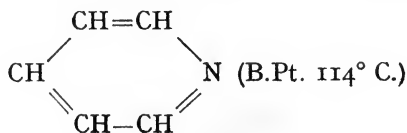

pyrrole :

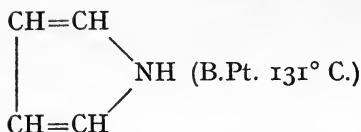

and their homologues, together with other basic substances and aromatic hydrocarbons. Bone oil has been used for many years as a denaturant for special purposes, but is not altogether satisfactory as a general denaturant. Bedford¹⁵ states that by redistilling the crude bone oil of commerce and collecting the first half to two-thirds which distil over, a product is obtained which fulfils almost completely the conditions for a general denaturant. He found that as small a quantity as 0.125 per cent. was sufficient for the purpose. It is claimed that this denaturant cannot be removed from the alcohol by any process commercially feasible. It is at present being tested by the Empire Motor Fuels Committee in conjunction with the London General Omnibus Company, as regards its suitability for the denaturing of power alcohol.¹⁶

The use of light "caoutchoucine" was suggested by Bedford some years ago. It is obtained by the distillation of scrap vulcanised rubber, or of crude rubber and sulphur. This substance would appear to be somewhat similar to the so-called "caoutchine," which was the name given by Himly, and later by Bouchardat, to the fraction passing over between 176° and 180° C. when unvulcanised Para rubber is distilled. Two kilograms of this oil were obtained from 5 kgm. of Para rubber. It consists of a mixture of various hydrocarbons, of which the chief is probably dipentene C₁₀H₁₆ (B.Pt. 175° to 176° C.). The name "caoutchene" has also been applied to the whole of the distillate of raw rubber boiling between 18° and 300° C., and including trimethyl ethylene, isoprene, CH₂:C(CH₃).CH:CH₂ (B.Pt. 35° C.), dipentene, myrcene, and allied terpenes, heveene (B.Pt. 252° C.), and various polyterpenes. The composition of "light caoutchoucine" from vulcanised rubber is likely to be more or less modified by the presence of sulphur and various "fillings" in the original material. A denaturant consisting of light caoutchoucine to the amount of 0.5 per cent. of the alcohol, together with an equal quantity of mineral pyridine bases, was adopted in 1910 by the Indian Government as a general denaturant. According to Bedford, the use of redistilled bone oil, in view of its origin from dead animal matter, was avoided on account of the religious and caste scruples prevailing among Hindus and Mohammedans, and the possibility of political agitation arising from this cause.

EXCISE SUPERVISION AND DENATURATION 207

In the report of the Industrial Alcohol Committee, India, published in 1920, it is recommended that if Excise restrictions are relaxed in favour of power alcohol, the amount of pyridine should be raised from 0.5 to 1 per cent. At the wholesale price of pyridine in September 1920, this additional quantity would represent an increase in cost of about 1½d. per gallon of alcohol.

The following are the specifications authorised by the Bengal Government in 1913 for "light caoutchoucine" and pyridine bases. Similar specifications were adopted by other provinces of India.

SPECIFICATION FOR "LIGHT CAOUTCHOUCINE," PROVINCE OF BENGAL, 1913

1. *Nature*.—By "caoutchoucine" is meant the liquid obtained by the dry distillation of vulcanised rubber. By "light caoutchoucine" is meant the liquid obtained by redistilling "caoutchoucine" and collecting that portion which passes over at or below about 200° C.

2. *The Specific Gravity of "Light Caoutchoucine."*—The specific gravity of "light caoutchoucine" at 60° F. should lie between 0.835 and 0.860 referred to water as 1.000.

3. *Boiling Test*.—For the purpose of this test, 100 c.c. of "light caoutchoucine" should be redistilled in the pyridine testing flask (see Specification for Pyridine Bases). Under those conditions not more than 15 c.c. of distillate should pass over at or below 100° C., whilst a total (including the foregoing) of at least 70 c.c. should pass over at or below 200° C.

4. *Absence of Soluble Constituents*.—When 25 c.c. of "light caoutchoucine" are shaken with an equal volume of water in a stoppered graduated cylinder and due time is allowed for the liquids to separate again into two layers, the "light caoutchoucine" should show no appreciable diminution in volume.

5. *Neutrality*.—The aqueous layer obtained from test 4 should show no marked acidity or alkalinity when tested with both red and blue litmus paper.

6. *Limit of Saturated Hydrocarbons*.—At least 70 per cent. of the "light caoutchoucine" should be soluble in concentrated sulphuric acid. For testing this, 25 c.c. should be measured off into a tapped and stoppered separating cylinder of suitable capacity, and sulphuric acid should be added, at first with great care and in very small quantities. After each addition of acid, the cylinder should be shaken and cooled to avoid loss of volatile constituents. Sufficient acid must be used (usually about 50 c.c.) for the highly-coloured layer to become quite fluid, so that it can separate readily from the upper layer of unattacked constituents. After a final thorough shaking and cooling, the cylinder should be left for about three hours to effect complete separation of the two layers, and the lower layer be then tapped off. The almost colourless upper layer

should be again shaken with strong sulphuric acid until it appears free from soluble constituents (as judged by the colour imparted to the sulphuric acid), and separated as before after standing. It should finally measure not more than 7 c.c. The acid used should be of specific gravity 1.84, and may be of commercial quality.

7. *Freedom from Water.*—"Light caoutchoucine" should not contain any appreciable amount of water. Any officer engaged in drawing samples for test should certify on the bottle that he has drawn the sample from the bottom of the containing vessel where the water, if present, will be found. For this purpose he should employ a siphon tube of which the shorter limb reaches to the floor of the containing vessel. He should also assure himself that the sample is collected in a bottle free from moisture.

SPECIFICATION FOR PYRIDINE BASES, PROVINCE OF BENGAL,
1913

1. *Nature.*—"Pyridine" proper is a single definite compound (C_5H_5N) boiling at about $116^\circ C$. "Pyridine Bases" are mixtures of pyridine with closely allied compounds (boiling at various temperatures), and must be of guaranteed mineral origin.

2. *Colour.*—The colour must not be darker than that given by 2 c.c. of decinormal iodine solution dissolved in 1 litre of distilled water.

3. *Miscibility with Water.*—20 c.c. of the pyridine bases should give a clear mixture with 40 c.c. of water; or else a mixture only so slightly opalescent that, after standing for five minutes, ordinary newspaper type is clearly visible through a layer 15 cm. deep.

4. *Amount of Water present.*—From 20 c.c. of the pyridine bases mixed with 20 c.c. of caustic soda solution (density 1.4), at least 18.5 c.c. of the bases should separate, after having been repeatedly shaken together and allowed to stand.

5. *Titration.*—Dissolve 1 c.c. of the pyridine bases in 10 c.c. of distilled water. Titrate with normal sulphuric acid until a drop of the mixture gives a definite blue spot on Congo-red paper (the blue colour should at once disappear). At least 10 c.c. of the normal sulphuric acid should be required to produce this reaction. (To prepare the Congo-red paper dissolve 1 gram of Congo-red in 1 litre of distilled water. Soak filter paper in this and then dry.)

6. *Cadmium Chloride Reaction.*—Vigorously shake together 10 c.c. of a solution of 1 c.c. of pyridine bases in 100 c.c. of distilled water with 5 c.c. of a 5 per cent. solution of dry fused cadmium chloride. A distinct crystalline precipitate should immediately result.

7. *Boiling-point.*—Distil 100 c.c. of the pyridine bases in the manner described below. At least 90 per cent. should distil at or under $140^\circ C$. Method:

100 c.c. of pyridine bases are placed in a short-necked copper flask of about 200 c.c. capacity. The flask is arranged on an asbestos card, which has a circular hole of 30 mm.

diameter cut in it. To the flask is attached a fractionating column (consisting of a tube 13 mm. wide and 170 mm. long, provided with one bulb) of which the side tube (issuing 1 cm. above the bulb) joins a Liebig's condenser of which the cooled part is at least 400 mm. long. A standard thermometer is placed in the head of the column, so that its bulb occupies the centre of the bulb of the column.

The speed of distillation is adjusted to 5 c.c. per minute, the distillate being received in a graduated glass cylinder. At least 90 c.c. should distil over at or under 140° C. at a barometric pressure of 760 mm. If the barometer varies from 760 mm., a correction of 1° C. for each 30 mm. of variation should be applied (*e.g.* under 770 mm. 90 c.c. of distillate should come over at or under 140.3° C., whilst under 750 mm. the same amount of distillate should come over at 139.7° C.).

It is obvious that the selection of a suitable denaturant is one of the most important and at the same time one of the most difficult of the problems which surround the production and utilisation of power alcohol. Substantial prizes have been offered at various times for a satisfactory solution of this problem, but these have never been won. It would be of advantage if the denaturant employed were the same throughout the Empire, if not throughout the world, and in any case denatured alcohol imported into this country would have to be accompanied by adequate guarantees that denaturing had been carried out according to an approved specification. The importation of alcohol in bulk for denaturation under bond in this country entails undue expense for Excise supervision at a number of points between the overseas distillery and the distributor. Owing to the complex nature and variable composition of materials such as wood naphtha, bone oil, and caoutchoucine, it is not possible to exercise control merely by analysis of the denatured alcohol. The denaturant must conform to an approved specification, and a uniform system of Excise supervision over the operation of mixing is necessary. If a denaturant could be discovered consisting of one or more simple chemical substances capable of being accurately estimated in the finished product by analysis, the problem would be greatly simplified.

REFERENCES

- ¹ C. Simmonds, *Alcohol*, London, 1919.
- ² J. Holmes, *Trans. Chem. Soc.*, 1906, **89**, 1775.
- ³ J. C. Cain, *Chem. News*, 1914, **109**, 37.
- ⁵ Sir James J. Dobbie, *Journ. Soc. Chem. Ind.*, 1920, **39**, 86R.
- ⁶ Cmd. 218 (1919).
- ⁷ Power Methylated Spirits Regulations, 1921, August 18.

⁸ and ⁹ R. N. Tweedy, *Industrial Alcohol*, Dublin, 1917.

¹⁰ Advisory Council of Science and Industry, Australia, Bulls. No. 6 (1918) and No. 20 (1921).

¹¹ N. V. Sidgwick and W. J. Spurrell, *Trans. Chem. Soc.*, 1920, **117**, 1397.

¹² *S. Afric. Journ. Ind.*, August 1918.

¹³ *Journ. Soc. Chem. Ind.*, 1920, **39**, 337R.

¹⁴ Eng. Pat. 120,792 (1917).

¹⁵ Sir Charles Bedford, *Autocar*, 1920, Dec. 11, p. 1166.

¹⁶ *Report of the Empire Motor Fuels Committee of the Imperial Motor Transport Council*, Jan. 26, 1921.

CHAPTER VIII

OUTLINE OF THE PRINCIPLES OF THE INTERNAL - COMBUSTION ENGINE

As a preliminary to a discussion of the use of alcohol as a motor fuel the principles upon which the internal combustion engine works may be briefly considered.

Four-Stroke Engine.—By far the greater number of engines now in use with gaseous or liquid fuels work upon what is known as the "Otto" or four-stroke cycle. This type of engine was invented in 1862 by Beau de Rochas, but was not a practical success until developed by Otto in 1876. Since that time it has undergone extensive improvement, and there are now in use an enormous number of different types. Fig. 25 shows the method of working of an engine operating on the four-stroke cycle. During the outward (suction) stroke of the piston the mixture of air and vapour from the carburettor is drawn into the cylinder through the induction pipe and open inlet valve. Shortly before the position of outer dead centre is reached the inlet valve closes, and the return (compression) stroke of the piston compresses the mixture in the cylinder. At the position of inner dead centre the compression is at a maximum and the mixture is ignited. A great increase of temperature and pressure occurs, and the piston is driven out again by the expansion of the products of combustion. Shortly before the position of outer dead centre the exhaust valve opens and the burnt gases are driven out by the return (exhaust) stroke of the piston. The cycle then begins again with the opening of the inlet valve and the outward movement of the piston.

The volume into which the charge is compressed is termed the "clearance space," and the ratio of the total volume when the piston is at outer dead centre, to the "clearance space," is the "compression ratio." The smaller the clearance space compared with the total volume at outer dead centre the higher is the compression ratio. The actual distance between inner and outer dead centre is termed the "stroke."

Two-Stroke Engine.—For marine work and also for motor-

cycle engines, the two-stroke engine invented in 1880 by Dugald Clerk is often employed. This engine works on an entirely different principle, in which use is made of the crank chamber to effect partial

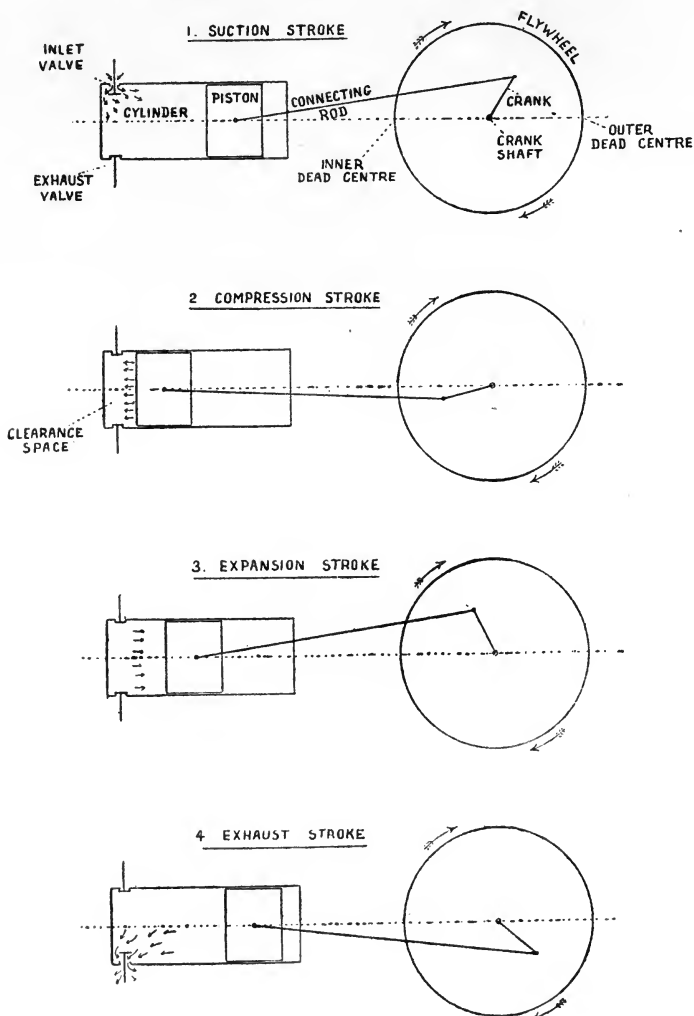

FIG. 25.—Diagram of Four-stroke Engine.

compression of the mixture. The piston on its inward stroke creates a partial vacuum in the crank chamber. At a certain point on its inward course it uncovers an inlet port (Fig. 26) in the cylinder wall through which the mixture of air and vapour from the car-

buretton is drawn into the crank chamber. The piston, on commencing its outward stroke, soon covers up the inlet port, and the mixture is compressed in the crank chamber to about 6 to 8 lb. gauge.¹ As the piston approaches outer dead centre it uncovers the port in the cylinder wall leading from the crank case, and part of the compressed charge in the crank chamber passes into the cylinder, driving out in front of it, through the exhaust port, the exhaust gases from the previous stroke. The object of the baffle is to direct the incoming charge towards the cylinder head, and prevent an excessive amount of the fresh mixture from being drawn away through the exhaust port by the exhaust gases. On the return stroke the piston closes both the exhaust port and the inlet to the cylinder and compresses the charge. At the position of inner dead

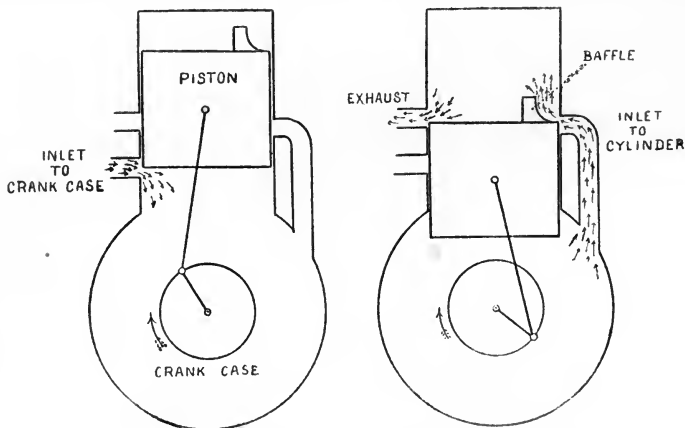

FIG. 26.—Diagram of Two-stroke Engine.

centre the charge is ignited and expansion takes place. The exhaust port is uncovered by the piston slightly earlier in the outward stroke than the inlet to the cylinder, so that a considerable portion of the burnt gas escapes before the entry of the new charge. The exhaust and suction strokes of the four-stroke cycle are thus dispensed with in the two-stroke cycle, the exhaust gases being forced out of the cylinder by the entry of the new charge under pressure. The two-stroke engine gives therefore twice as many working strokes for 1000 revolutions of the flywheel as the four-stroke engine, but against this must be set the work which has to be expended in compressing the charge in the crank case.

¹ Gauge pressure is the number of pounds per square inch in excess of atmosphere pressure. As the latter is approximately 14.7 lb. per square inch, the total pressure = gauge pressure + 14.7 lb.

Diesel Engine.—A third type of internal combustion engine is the Diesel engine, which is designed to work with heavy oil fuels. In this engine air only is allowed to enter during the suction stroke. The air is then compressed to a high degree on the return stroke, with the result that it reaches a high temperature. At the position of inner dead centre a small quantity of oil is injected by means of a pump (semi-Diesel engine) or compressed air (Diesel engine). The oil ignites spontaneously at the high temperature caused by compression, and the piston is forced outwards. The injection of oil continues until the piston has travelled part of the way on the outward stroke, when the fuel supply is cut off, and the combustion is completed during the remainder of the stroke. The semi-Diesel engine works at a lower compression than the Diesel engine, and the ignition of the oil vapour is effected in a separate hot chamber at the head of the cylinder.

The Unit of Heat.—The internal combustion engine is a contrivance for converting heat into work. In order to arrive at correct estimates of the comparative efficiency of different types of engine using different fuels, we must be able to measure accurately the quantity of heat supplied and the work performed.

Heat is expressed either in calories (small calories, gram-calories), in Centigrade heat units, or in British thermal units.

The calorie (cal. or grm.-cal.) is the amount of heat required to raise the temperature of 1 gram of water by 1° Centigrade (from 15° to 16° C.). As the number of calories set free in a reaction is sometimes inconveniently large, the large Calorie (Cal.) which is 1000 times the small calorie, is frequently used.

The Centigrade heat unit (C.H.U.) is the amount of heat required to raise the temperature of 1 lb. of water by 1° Centigrade.

The British thermal unit (B.Th.U.) is the amount of heat required to raise the temperature of 1 lb. of water by 1° Fahrenheit (from 60° F. to 61° F.).

The relationship between C.H.U. and B.Th.U. is simply that of Centigrade and Fahrenheit, *i.e.* 9 B.Th.U.=5 C.H.U. or 1 C.H.U.=1.8 B.Th.U. The calorie and B.Th.U. are related to each other as follows :

$$\begin{aligned} 1 \text{ calorie} &= 0.003968 \text{ B.Th.U.} \\ 1 \text{ B.Th.U.} &= 252 \text{ calories.} \end{aligned}$$

The amount of heat produced when a definite weight of a fuel containing carbon and hydrogen is burnt completely to form carbon dioxide and water, is termed, according to circumstances, the "heat of combustion" or "calorific value" of the fuel. The term "heat of combustion" is generally used when it is a question of the evolu-

tion of heat in a series of chemical reactions in which the reacting substances are concerned in the ratio of their combining weights. The unit of weight is here the gram-molecule or molecular weight in grams. Thus the energy equation for the combustion of alcohol is

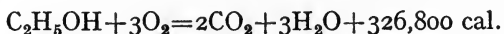

indicating that a quantity of alcohol equal to the molecular weight in grams, *i.e.* 46 grams, yields on complete combustion 326,800 calories.

In comparing different fuels of widely divergent mean molecular weights, the gram-molecule is not a convenient unit to take. The "calorific values" of fuels are compared for equal weights, or equal volumes, of the fuels, and are expressed as Calories per kgm. or per litre, or as C.H.U. or B.Th.U. per pound or per gallon. The gross calorific value of alcohol is thus 7105 C.H.U. or 12,790 B.Th.U. per pound. The "net" calorific value, in which allowance is made for the heat of vaporisation of water, is somewhat lower than this (p. 234).

The "specific heat" of a substance is the quantity of heat necessary to raise the temperature of 1 gram of the substance by 1° Centigrade, compared with that required for the same weight of water. The specific heat multiplied by the molecular weight gives the "molecular heat." Inasmuch as a molecular weight in grams of every perfect gas occupies the same volume at normal temperature and pressure, the molecular heat is the specific heat referred to unit volume.

The Unit of Power.—The unit of power in this country is the horse-power (H.P.). One horse-power is equal to 33,000 foot-pounds per minute—that is to say, the work expended in raising 33,000 pounds through a height of one foot in one minute. One horse-power hour is therefore equal to $33,000 \times 60 = 1,980,000$ foot-pounds.²

As an engine converts heat into work, it is important to know the number of foot-pounds of work into which one heat unit can be converted. This was determined experimentally by Joule in 1843, who found that 1 B.Th.U. was equal to 772.5 foot-pounds, or, when corrected for temperature, 776.7 foot-pounds. As a result of later and more accurate determinations the figures now taken for the mechanical equivalent of heat are

$$\begin{aligned} 1 \text{ gr. cal.} &= 42,750 \text{ grm. cm.} \\ 1 \text{ C.H.U.} &= 1402 \text{ foot-pounds.} \\ 1 \text{ B.Th.U.} &= 779 \text{ foot-pounds.} \end{aligned}$$

² On the Continent the horse-power corresponds to 75 metre kgm. per second, or 4500 m.kgm. per minute. It is thus 98.6 per cent. of the English horse-power.

The Gas Laws.—The laws governing the pressure and volume of a perfect gas may be combined into the equation

$$pv = p_0 v_0 \left(1 + \frac{1}{273} t\right)$$

which can be simplified into

$$pv = \frac{p_0 v_0 T}{273}$$

where p = the pressure of the gas,

v = the volume of the gas,

p_0 = the pressure of the same weight of gas at 0°C. ,

v_0 = the volume of the same weight of gas at 0°C. ,

T = the absolute temperature,

$\frac{p_0 v_0}{273}$ is the product of the pressure and volume at absolute zero and

is usually written R , the expression becoming

$$PV = RT$$

in which R is known as the gas constant.

One litre of hydrogen at 0°C. and 760 mm. weighs 0.089872 grms. Therefore the molecular weight of hydrogen in grams (2 grms. hydrogen) occupies a volume of approximately 22.4 litres. By Avogadro's hypothesis a molecular weight in grams of every perfect gas occupies the same volume at normal temperature and pressure, so that 22.4 litres may be taken as unit volume of a gas at 0°C. and 760 mm. pressure.

With $p_0 = 1$ atmosphere and $v_0 = 22.4$ litres

$$R = \frac{p_0 v_0}{273} = \frac{22.4}{273} = 0.0819 \text{ litre-atmosphere.}$$

Specific Heats at Constant Volume and Constant Pressure.

—If one gram-molecule of gas at volume V be heated through 1°C. , the pressure being kept constant at P , the gas expands to the extent of $\frac{1}{273} V$, *i.e.* $\frac{V}{T}$, and the work performed by this

expansion is $\frac{PV}{T}$. If the gas during the heating be not allowed to expand, no work will be performed. The total quantity of heat imparted to the gas (the molecular heat) is found to be greater when the gas is allowed to expand than when the volume is kept constant, the difference between the two values being equivalent to the work performed $\frac{PV}{T}$.

If we call the molecular heat at constant pressure C_p and at constant volume C_v , we have

$$C_p - \frac{PV}{T} = C_v$$

and combining this expression with $PV=RT$ we have

$$\begin{aligned} C_p - R &= C_v \\ \text{or } C_p - C_v &= R. \end{aligned}$$

We have already seen that $R=0.0819$ litre-atmosphere. To ascertain the difference between C_p and C_v in terms of heat units the value of R must be reduced to calories. The pressure of the atmosphere on 1 square cm. surface is 1033 grams. A litre-atmosphere is the work performed in producing an increase in volume of 1 litre or 1000 c.c. against atmospheric pressure, and is equal to 1,033,000 gram-centimetres. From the experiments of Joule and others it has been ascertained that one calorie (gram-calorie) is equal to the work performed in raising a weight of 1 gram through a height of 42,750 cm.

$$i.e. \ 1 \text{ gram. cal.} = 42,750 \text{ gram.-cm.},$$

which is termed the mechanical equivalent of heat, or J .

$$\text{Therefore 1 litre-atmosphere} = \frac{1033000}{42750} = 24.17 \text{ gram. cal.}$$

and

$$\begin{aligned} R &= 0.0819 \text{ litre-atmosphere.} \\ &= 0.0819 \times 24.17 \text{ gram. cal.} \\ &= 1.98 \text{ gram. cal.} \end{aligned}$$

which is therefore the difference between the two molecular heats C and C_v .

If c_p and c_v represent the two specific heats, we have

$$c_p - c_v = \frac{1.98}{M}$$

where M =molecular weight of the gas.

Ratio of Specific Heats.—The ratio of the two specific heats at constant pressure and constant volume, $\frac{c_p}{c_v}$, or, as it is usually written, γ , is of great importance in calculations on the internal combustion engine. This ratio has been determined experimentally by several methods. For monatomic gases it is 1.667; for diatomic gases, such as oxygen, nitrogen, and carbon monoxide, it is about 1.4. For gases possessing more complex molecular structure it is 1.3 or lower.

The following table gives the values of c_p , c_v , and $\frac{c_p}{c_v}$ for the more important gases and vapours concerned in the internal combustion engine (Regnault):

	c_p	c_v	$\frac{c_p}{c_v} = \gamma$
Air	0.238	0.169	} 1.41
Oxygen	0.217	0.153	
Nitrogen	0.245	0.174	
Carbon monoxide	0.245	0.174	
Carbon dioxide	0.200	0.155	
Steam	0.480	0.370	1.29 1.30

Isothermal and Adiabatic Expansion.—If the temperature of a gas be kept constant during expansion or compression, by supplying or withdrawing heat as required, the product of pressure and volume, PV , remains constant (Boyle's law). The expansion and compression under these conditions are termed "isothermal," and if pressure and volume be plotted on a system of co-ordinates the resulting curve is a hyperbola. If, on the other hand, the change of volume takes place in such a way that no heat is supplied or withdrawn, the expansion and compression are termed "adiabatic."

If a gas be imagined to be compressed in stages under adiabatic conditions it is obvious that the resistance offered to compression at each successive stage will rise at a greater rate than would be the case were the compression isothermal, owing to the fact that the heat produced by compression, instead of being removed, remains in the gas and raises its temperature (Fig. 27). The law connecting pressure and volume for adiabatic compression and expansion can be shown to be

$$PV^{\frac{c_p}{c_v}} \text{ or } PV^\gamma = \text{constant.}$$

By combining this expression with the gas equation

$$PV = RT$$

we obtain two further expressions connecting temperature and volume, and temperature and pressure, respectively, for adiabatic compression and expansion.

$$TV^{\gamma-1} = \text{constant.}$$

$$\text{and } \frac{T^\gamma}{P^{\gamma-1}} = \text{constant}$$

These expressions enable us to calculate the temperature attained by a given quantity of gas after it has been subjected to adiabatic expansion or compression, provided that both its initial state and its final pressure or volume are known.

In the ideal internal combustion engine the compression would approximate to the adiabatic law, but in actual practice a certain amount of the heat of compression is removed by losses through

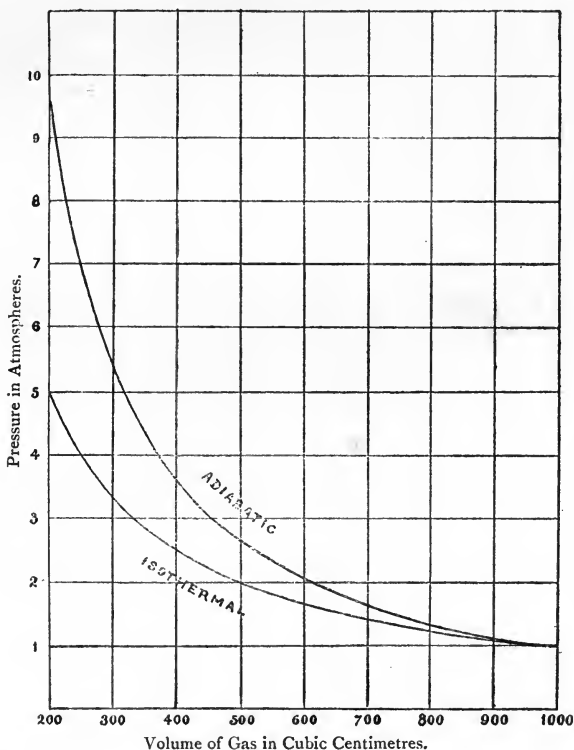

FIG. 27.—Isothermal and Adiabatic Compression of 1 Litre of Gas to a Volume of 200 c.c.

the cylinder walls, assisted by the action of the cooling water. The compression therefore follows the law

$$PV^n = \text{constant}$$

where the exponent n lies between 1 (isothermal compression) and 1.41 (adiabatic compression of air). For the compression stroke in an internal combustion engine the value of n lies between 1.3 and 1.35.

The compression of an engine is frequently given in pounds per

square inch, the figures being sometimes absolute and sometimes gauge pressures. Since the compression pressure varies with the value of n in the above expression and is also affected by the speed of the engine, it is preferable to refer to the compression ratio in lieu of the actual compression pressure.

Besides the mechanical loss of heat from the engine there is a still more important factor affecting the value of n during the expansion, or working stroke of the engine.

If a gas mixture be exploded in a closed vessel it is found that the temperature and pressure reached in the explosion are much less than the values calculated on the basis of the specific heats of the gaseous combustion products at normal temperature. Various explanations have been advanced to account for this, and it was for a long time held to be due to delayed combustion or "after burning" of the charge. It is now accepted as being due largely to an increase in the specific heats of gases at high temperatures, the rate of increase varying with the complexity of the gaseous molecule. The ratio of the specific heats at high temperatures thus becomes

$$\frac{c_p + at}{c_v + at}$$

where a is a coefficient depending on the nature of the gas, and t is the temperature. The values obtained for this coefficient vary to some extent according to the experimental methods employed by different investigators, and it is probable that for an extended temperature range the expression is more nearly

$$\frac{c_p + at + \beta t^2}{c_v + at + \beta t^2}$$

For oxygen, nitrogen, and carbon monoxide a would seem to be approximately 0.000015 to 0.00002. The values for steam and carbon dioxide are about 0.0001 and 0.00025 respectively.

According to Bjerrum's³ determinations the mean specific heats of nitrogen, water vapour, and carbon dioxide at various temperatures are as follows :

100° C. up to . . .	500°	1000°	1500°	2000°	2500°	3000°
Nitrogen	0.185	0.189	0.196	0.205	0.214	0.225
Water vapour	0.347	0.386	0.424	0.468	0.539	0.622
Carbon dioxide	0.187	0.217	0.229	0.236	0.247	0.249

These values represent the actual specific heats at constant volume with dissociation reduced to a minimum by the presence of an excess of one of the dissociation products.

The higher the temperature, therefore, the lower will be the ratio $\frac{c_p}{c_v}$ and the nearer will it approximate to unity.

The question has recently been subjected to a thorough examination from the theoretical standpoint by Tizard and Pye.⁴ They show that the value of n in the expression $PV^n = \text{const.}$ for the expansion or working stroke of an engine is affected not only by the rise in specific heats at high temperatures, but also by the dissociation of the gaseous products of combustion, whereby the actual number of gas molecules is increased. The total volumetric heat of the exploded charge is thus increased and the temperature and pressure in the cylinder correspondingly reduced.

The dissociation of CO_2 and H_2O at high temperatures is shown in the following table :

DISSOCIATION OF CO_2 AND H_2O AT HIGH TEMPERATURES

CO_2				
Temperature.	Dissociation per cent. at Different Pressures.			
	0.1 Atmosphere.	1.0 Atmosphere.	10 Atmospheres.	100 Atmospheres.
1500° C.	0.104	0.048	0.024	0.01
2000° C.	4.35	2.05	0.96	0.445
2500° C.	33.5	17.6	8.63	4.09
3000° C.	77.1	54.8	32.2	16.9
H_2O .				
1500° C.	0.043	0.02	0.009	0.004
2000° C.	1.25	0.58	0.27	0.125
2500° C.	8.84	4.21	1.98	0.927
3000° C.	28.4	14.4	7.04	3.33

As a result of these factors, mechanical loss of heat, increase of the specific heat with rise of temperature, and dissociation, it is found in practice that the value of n in the expression PV^n for the expansion or working stroke of most engines is between 1.15 and 1.3. If there were no thermal losses and the specific heat did not

change with the temperature, n would be approximately equal to the ratio $\frac{c_p}{c_v}$ or γ for air at ordinary temperatures, *i.e.* 1.41.

The Indicator Diagram.—By means of a contrivance termed an indicator, a record can be obtained of the pressure and volume of the cylinder contents at every point of the cycle. It is beyond the scope of this book to describe in detail the mechanism of the optical indicator as used on high speed engines, but the following is the principle of the apparatus.

A pressure tube leads from the cylinder head to a small chamber containing a diaphragm. This diaphragm moves backwards and forwards under the influence of the varying pressure in the cylinder, and the movements are taken up by a mirror. If a beam of light be thrown on to the mirror and reflected from it on to a screen, the movement of the light spot on the screen will be directly proportional to the differences of pressure in the cylinder. A second mirror is actuated from the connecting rod by a reducing gear, and its movements therefore correspond to the difference in volume of the cylinder contents. The axes of movement of the two mirrors are set at right angles to each other, and the beam of light is reflected from one mirror to the other and finally on to the screen. The light spot, therefore, describes a figure on the screen showing both pressure and volume at any point in the cycle. At normal engine speeds the motion of the light spot is so rapid that its path appears as a continuous line—the indicator diagram.

By the substitution of a photographic plate or sensitive paper for the screen, a permanent record of the indicator diagram may be obtained.

Fig. 28 shows the type of indicator diagram obtained from an engine working on the "Otto" or "constant volume" cycle. Starting from the lower left-hand corner of the diagram, the sequence of suction, compression, explosion, expansion, and exhaust is clearly shown. The area of the upper closed figure represents the work done upon the piston by the expanding gases. The area of the lower closed figure represents "negative" work, *i.e.* work done by the piston upon the cylinder contents. To find the total work, the area of the lower must therefore be subtracted from that of the upper closed figure. The value obtained will be a measure of the "indicated horse-power" or I.H.P. In Fig. 28 the negative work area is drawn, for the sake of clearness, to a larger vertical scale than the rest of the diagram.

The "mean effective pressure" (M.E.P.) on the piston is first ascertained from the diagram by taking the mean of all the pressures at different equidistant points along the volume axis,

allowance being of course made for the "negative" pressure of the lower closed figure. Then the mean effective pressure in pounds per square inch \times the area of the piston in square inches \times by length of stroke in feet gives the work done in foot-pounds. The work done in foot-pounds multiplied by the number of working strokes per minute and divided by 33,000 gives the indicated horse-power (I.H.P.).

In practical engine tests the "brake horse-power" (B.H.P.) is of more immediate value than the I.H.P., since it represents the

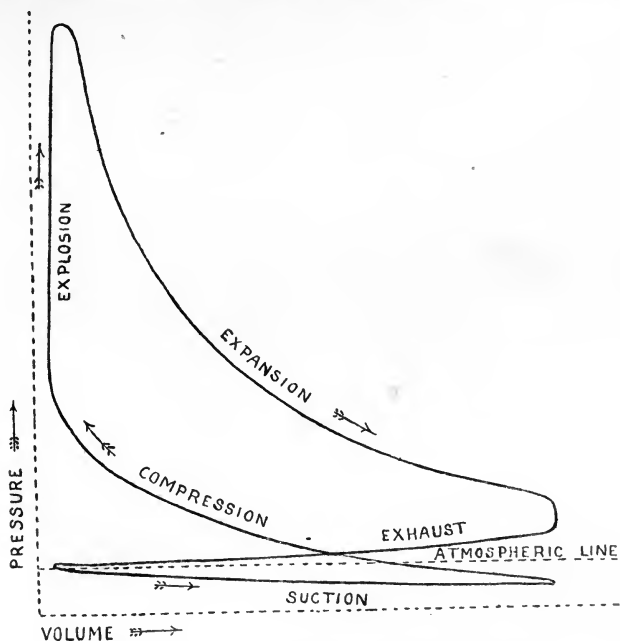

FIG. 28.—Typical Four-stroke Indicator Diagram.

actual power output of the engine. The B.H.P. is determined by means of a dynamometer connected with the flywheel. It is always less than the I.H.P. by that amount of work which is expended in moving the piston, crank, and flywheel of the engine.

Volumetric Efficiency.—During the suction stroke the pressure is seen to be somewhat lower than the atmospheric pressure. This is due to the fact that, owing to the speed of the engine, the carburettor, induction pipe, and inlet valve cannot supply the air-vapour mixture sufficiently quickly to maintain atmospheric pressure in the cylinder. In the induction system

there is a certain amount of inertia and frictional resistance (the latter being sometimes referred to as "wiredrawing") which impedes the free movement of the air. This is more pronounced at high speeds than at low speeds, but is mainly dependent on the extent to which the throttle of the carburettor is closed. Thus at high speeds and low loads (*i.e.* small throttle openings) the quantity of combustible mixture taken into the cylinder is reduced and the compression pressure is lowered. Moreover, the air and fuel mixture is warmed by the heat supplied to the carburettor and by contact with the hot walls of the cylinder, and its weight per unit volume is thus reduced.

The ratio of the actual volume of air-fuel mixture drawn into the cylinder to that drawn in at 0° C. and 760 mm. pressure is termed the "volumetric efficiency." It may vary at normal loads from 68 or 70 per cent. upwards according to the speed of the engine, the setting of the carburettor, and the relative size of valve and induction pipe; at very low loads the volumetric efficiency may be enormously reduced owing to the excessive throttling necessary.

Thermal Efficiency.—The thermal efficiency of an engine is the ratio of the heat converted into work to the total heat supplied to the engine. This may be written :

$$\frac{\text{Heat supplied} - \text{Heat discharged}}{\text{Heat supplied}}$$

The heat converted into work multiplied by Joule's equivalent is the same as the indicated horse-power (I.H.P.), so that thermal efficiency may also be expressed in the form :

$$\frac{\text{Indicated horse-power}}{\text{Thermal value of fuel consumed} \times J}$$

It is not possible even in a perfect engine to convert the whole of the heat supplied into work. If H be the quantity of heat which is supplied to the engine at absolute temperature T , and H' the quantity of heat discharged from the engine at absolute temperature T' , then

$$\frac{H - H'}{H} = \frac{T - T'}{T}$$

$H - H'$ is the heat converted into work, so that according to this law the proportion of the heat which is converted into work is primarily dependent upon the limits of temperature between which the engine operates (Carnot's principle).

In an internal combustion engine, which compresses the charge

before ignition, we may write the above equation in the following form :

$$\text{Thermal efficiency} = \frac{(T_2 - T_1) - (T_3 - T_0)}{(T_2 - T_1)} = 1 - \frac{T_3 - T_0}{T_2 - T_1}$$

where T_1 = the absolute temperature of compression.

T_2 = the absolute temperature of explosion.

T_3 = the absolute temperature of exhaust gases.

T_0 = the absolute temperature of inlet gases.

Since in the ideal engine the compression and expansion are adiabatic, we have the relationship

$$\frac{T_1}{T_0} = \frac{T_2}{T_3} \text{ or } T_3 = \frac{T_2 T_0}{T_1}$$

Substituting this value for T_3 in the above equation, we obtain

$$\text{Thermal efficiency} = 1 - \frac{\frac{T_2 T_0}{T_1} - T_0}{T_2 - T_1}$$

Dividing both the numerator and denominator of the fraction by

$$\frac{T_2 - T_1}{T_1}$$

$$\text{Thermal efficiency} = 1 - \frac{T_0}{T_1}$$

For adiabatic compression and expansion we have (p. 218)

$$TV^{\gamma-1} = \text{constant.}$$

Therefore

$$\frac{T_0}{T_1} = \left(\frac{V_1}{V_0}\right)^{\gamma-1}$$

$\frac{V_0}{V_1}$ is the compression ratio r , so that the thermal efficiency equation may be written

$$\text{Thermal efficiency} = 1 - \left(\frac{1}{r}\right)^{\gamma-1}$$

This equation is sometimes met with in a slightly different form, the compression pressure P being substituted for the compression ratio r . Thus for adiabatic compression and expansion we have

$$\frac{T^\gamma}{P^{\gamma-1}} = \text{constant (p. 218).}$$

$$i.e. \quad \frac{T_0^\gamma}{T_1^\gamma} = \frac{P_0^{\gamma-1}}{P_1^{\gamma-1}} \text{ or } \frac{T_0}{T_1} = \left(\frac{P_0}{P_1}\right)^{\frac{\gamma-1}{\gamma}}$$

$$\begin{aligned} \text{and thermal efficiency} &= 1 - \frac{T_0}{T_1} \\ &= 1 - \left(\frac{P_0}{P_1}\right)^{\frac{\gamma-1}{\gamma}} \end{aligned}$$

where P_0 is the initial pressure and P_1 the final compression pressure.

“ Air Standard ” Efficiency.—It has been assumed in the above calculations that $\frac{c_p}{c_v}$ or γ is a constant. Owing, however, to the change in specific heat with rise in temperature, γ is not constant over the whole range of temperature in the cycle. The nearest approach to constancy is given by air, for which the ratio $\frac{c_p}{c_v}$ is equal to about 1.4 over a considerable range of temperature. The expression

$$1 - \left(\frac{1}{\gamma}\right)^{0.4}$$

is therefore spoken of as the “ air standard efficiency.” It represents the efficiency of a hot-air engine working under ideal conditions on the assumption that the specific heat of air does not change at all with the temperature.

But even with air there is, in fact, a considerable rise in specific heat at high temperatures. According to Dugald Clerk the maximum thermal efficiency in an engine in which there are no thermal losses is about 20 per cent. lower than the theoretical “ air standard efficiency,” and may be represented by the expression

$$1 - \left(\frac{1}{\gamma}\right)^{0.3}$$

which can be termed the “ ideal thermal efficiency ” of an internal combustion engine.

Thus, if we take a compression ratio of 4 to 1, the ideal efficiency would be

$$1 - \left(\frac{1}{4}\right)^{0.3} = 0.341$$

as against

$$1 - \left(\frac{1}{4}\right)^{0.4} = 0.426$$

for the air standard efficiency, or a difference of approximately 20 per cent.

Thermal efficiencies are usually given in terms of percentages, thus : 34.1 per cent. and 42.6 per cent.

Tizard and Pye,⁵ from theoretical considerations involving the change in specific heat and dissociation at high temperatures,

showed that the theoretical thermal efficiency, when air and fuel were present in correct proportions for complete combustion, was

$$1 - \left(\frac{1}{r}\right)^{0.258}$$

The highest thermal efficiency is usually attained when the ratio of fuel to air is about 0.8 of that required for the correct mixture, *i.e.* when a certain quantity of excess air is present. Under these conditions the theoretical thermal efficiency was calculated to be

$$1 - \left(\frac{1}{r}\right)^{0.298}$$

agreeing closely with Dugald Clerk's expression for ideal thermal efficiency.

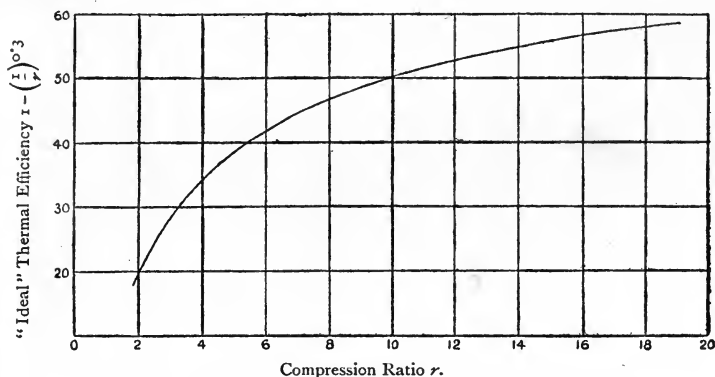

FIG. 29.—Relation between "Ideal" Thermal Efficiency and Compression Ratio.

Actual thermal efficiencies are, for various reasons such as thermal losses, etc., much lower than this. Thus Watson, working with a Clement-Talbot engine, found efficiencies ranging from 0.19 with compression ratio 3.92, to 0.28 with compression ratio 4.71, using in the former case a strong petrol-air mixture and in the latter a weaker one. These results would correspond to values for the exponent varying between 0.15 and 0.21, instead of 0.3 as in the expression for ideal thermal efficiency, and would indicate that the mean values of n in the expression PV^n , for the whole cycle, ranged from 1.15 to 1.21.

The ratio of the actual efficiency to the air standard efficiency is termed the "relative" efficiency of the engine, but the term is also used sometimes to denote the ratio of actual efficiency to ideal efficiency. Fig. 29 shows the rate of increase of the ideal efficiency with increasing compression ratio. It is evident that the effect of

raising the compression is relatively great for low compressions but becomes less as the compression ratio increases. This is a point of some importance when using alcohol as a fuel. Alcohol will stand a much higher compression than petrol without detonation or pre-ignition, but if the compression ratio be raised too high the relative gain in thermal efficiency will be small compared with the mechanical difficulties introduced. High compressions imply an increase in cost and weight of the engine and an increase also in internal friction due to heavier reciprocating and rotating parts. Ricardo considers that a compression ratio of 7 : 1 is the highest that can be usefully employed. For each different type of fuel there exists a limiting compression ratio above which detonation and pre-ignition occur with consequent loss of power. The maximum thermal efficiency for any particular fuel is therefore that obtained when the compression ratio is the highest which the fuel will stand.

Overall Thermal Efficiency.—In the foregoing sections thermal efficiency has been taken as representing the ratio of the indicated horse-power to the energy content of the fuel. In practical engine tests the performance of the engine is more often given in terms of brake horse-power (B.H.P.). The brake horse-power of most engines is about 80 per cent. of the indicated horse-power.

The ratio $\frac{\text{B.H.P.}}{\text{Energy supplied}}$ is termed the "overall" thermal efficiency, and the ratio $\frac{\text{B.H.P.}}{\text{I.H.P.}}$ the mechanical efficiency. Thus

for an engine consuming 0.5 lb. of fuel, of calorific value 12,500 C.H.U. per lb., per B.H.P. per hour, the overall thermal efficiency (taking 1 C.H.U. = 1400 ft.-lb.) is

$$\frac{60 \times 33,000 \times 100}{0.5 \times 12,500 \times 1400} = 22.6 \text{ per cent.}$$

Thermal efficiencies are usually calculated on a basis of "net" instead of gross calorific value, but net calorific value is not always arrived at in the same way (p. 234). In comparing published results of engine tests, uncertainty sometimes arises as to whether the thermal efficiencies given are based on I.H.P. or B.H.P., whether the heat values are gross or net, and what deductions have been made from gross values in arriving at net calorific values.

Thermal efficiency must not be confused with fuel consumption. While the former is the ratio of work done to heat units supplied, and requires for its determination a knowledge of the calorific value of the fuel, the latter represents the actual amount of fuel consumed (by weight or by volume), irrespective of its calorific value, for a given amount of work. In road tests the fuel consump-

tion is usually given in miles per gallon, and sometimes in ton-miles per gallon.

Control of Speed.—The speed of internal combustion engines may be controlled or governed in several ways.

1. The whole of the fuel supply may be cut off from one or more strokes.
2. The amount of fuel used may be reduced, leaving the air supply the same (quality governing).
3. Both fuel and air supply may be reduced, their relative proportion remaining the same (quantity governing).
4. The ignition may be retarded, or cut off altogether from one or more strokes.

In a motor-car engine, which is usually controlled by hand on the throttle, the system is a mixture of quantity and quality governing, sometimes combined with advanced or retarded ignition.

Stationary engines are generally controlled either on system 1 or 3. The former of these is the well-known "hit-and-miss" governing, in which a centrifugal device operates in such a way as to open the fuel inlet valve only below a certain engine speed. When the speed rises above this point the inlet valve remains closed for one or two strokes until the speed falls again. During these strokes air only is admitted to the cylinder until the speed is reduced below that for which the governor is set.

Quantity governing is now much used on large stationary engines, the centrifugal device being arranged so as to cause the throttling down of the explosive mixture before it enters the cylinder.

Quality governing is unsuited to stationary engines, since in this system the composition of the mixture is continually varying and this causes uneven running.

Ricardo's Variable Compression Engine.—H. R. Ricardo⁶ has given a description of an engine with variable compression designed by himself in conjunction with H. A. Hetherington for the purpose of fuel research. The engine is a single cylinder unit of $4\frac{1}{2}$ -inch bore and 8-inch stroke. It is so designed as to be capable of running for long periods at piston speeds of from 2000 to 3000 feet per minute, and every known expedient has been applied in order to obtain the highest possible thermal, volumetric, and mechanical efficiency.

The main feature of interest in the engine from the point of view of comparative tests with alcohol and other fuels is the manner in which the compression may be varied in a short time, while the engine is running on full load (Fig. 30). The method adopted allows of the cylinder being raised or lowered bodily in relation to

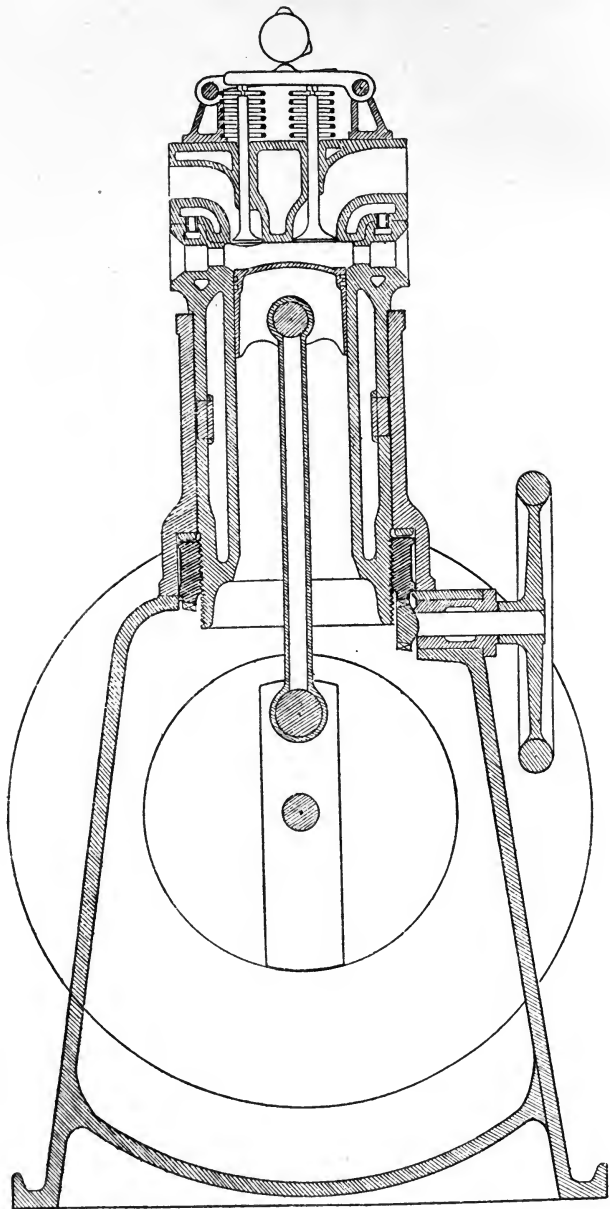

FIG. 30.—Internal Combustion Engine with Variable Compression.

(H. R. Ricardo, *Engineering*, 1920, 110, 325.)

the flywheel and piston, thus enlarging or reducing the clearance space. The outside surface of the cylinder water-jacket is machined and ground, and slides in a massive cast-iron guide. The cylinder can be locked in position in the guide by a clamp bolt (not shown in the figure) which closes in the guide and so grips the cylinder uniformly round the whole circumference of the jacket. The lower end of the jacket is screwed externally to receive a large phosphor-bronze nut located between the lower face of the guide and the base chamber. This nut can be rotated by a hand wheel through the medium of bevel gearing and the cylinder bodily raised or lowered thereby. The nut and thread are amply strong enough to withstand the maximum pressure in the cylinder, but to ensure absolute rigidity the clamp bolt in the guide is always tightened up when the desired position is attained and the cylinder held rigidly in a friction grip.

A special micrometer arrangement is used to indicate the exact position of the cylinder in its guide and therefore the compression ratio. This ratio can be varied from 3·7 : 1 up to 8 : 1. The cylinder head is flat with the valves fitted vertically in it. This ensures the absence of irregularities in explosion due to valve pockets and also reduces to a minimum the change in the general form of the combustion chamber with alteration in compression. Thus throughout the whole range of compression ratios from 3·7 : 1 to 8 : 1 the surface-volume ratio of the combustion chamber only varies from 1·6 : 1 to 2·75 : 1, which reduces considerably the irregularities due to different rates of cooling.

High volumetric efficiency is attained by fitting five valves, two inlet and three exhaust, and by making the valve area and cross-section of induction pipes as large as possible. Four sparking plugs are fitted at equidistant points round the circumference of the cylinder.

Tests on benzol and petrol with this engine showed an indicated thermal efficiency for both fuels at 100 per cent. load of 34·9 per cent. at compression ratio 6 : 1, and 27·5 per cent. at compression ratio 4 : 1. The corresponding brake thermal efficiencies were 30·7 per cent. and 23·4 per cent. respectively.

REFERENCES

- ³ N. Bjerrum, *Zeitsch. Physikal Chem.*, 1912, **79**, 513, 537.
⁴ and ⁵ H. T. Tizard and D. R. Pye, *Automobile Engineer*, 1921, **11**, 55, 98, 134.
⁶ H. R. Ricardo, *Engineering*, 1920, **110**, pp. 325 and 361.

CHAPTER IX

THE CHEMICAL AND PHYSICAL PROPERTIES OF ALCOHOL FROM THE MOTOR-FUEL STANDPOINT

PURE alcohol, whether obtained by fermentation or synthetically from acetylene or coke-oven gas, is a definite chemical substance of formula C_2H_5OH . In this respect it differs from petroleum and coal-tar distillates, which usually consist of a more or less complex mixture of hydrocarbons. The physical properties of alcohol are therefore capable of more exact definition than is the case with other motor fuels. But the preparation of anhydrous alcohol is a difficult matter, and would be far too costly except in those cases in which the pure spirit is required for special purposes. Moreover, alcohol destined for use as a motor fuel must obviously be "denatured" or rendered undrinkable by the addition of nauseous ingredients, so that the fuel as it reaches the consumer is likely to be almost as complex a mixture as commercial petrol. Nevertheless, it will be of advantage to consider the physical properties of pure alcohol as a basis from which to calculate those of the various mixtures which may appear in commerce. It will be seen that in many of its properties, alcohol exhibits marked peculiarities as compared with petrol, benzol, and kerosene.

Ultimate Composition.—An essential difference between alcohol and the mineral oil fuels lies in the fact that the former contains a considerable quantity of oxygen. The percentage composition of pure alcohol is

$$C=52.13 \text{ per cent.}$$

$$H=13.12 \quad ,,$$

$$O=34.75 \quad ,,$$

whereas that of heptane, one of the main constituents of commercial petrol, is

$$C=84.00 \text{ per cent.}$$

$$H=16.00 \quad ,,$$

and of coal-tar benzene :

$$C=92.31 \text{ per cent.}$$

$$H=7.69 \quad ,,$$

Commercial mineralised methylated spirit at an approximate strength of 62° over proof has the following average composition :

Ethyl alcohol . . .	79.9	per cent.	by weight.
Methyl alcohol. . .	7.4	"	"
Ketones, esters, etc. }	1.5	"	"
Mineral naphtha }	11.2	"	"
Water . . .	100.0	"	"
	<hr style="width: 50%; margin: 0 auto;"/>		

The percentage composition is therefore approximately :

$$C = 45.4 \text{ per cent.}$$

$$H = 12.8 \quad "$$

$$O = 41.8 \quad "$$

The composition of commercial petrol (spec. grav. 0.740) may be taken as averaging

$$C = 84 \text{ per cent.}$$

$$H = 13 \quad "$$

and of "90's" benzol (*i.e.* a mixture of benzene and toluene of which 90 per cent. distils over below 100° C.)

$$C = 91.8 \text{ per cent.}$$

$$H = 8.2 \quad "$$

The ultimate composition is of value for the purpose of calculating the gross and net calorific values, and the amount of air required for complete combustion. Moreover, it often gives some indication of the liability of a fuel to form carbon deposits upon the valves and cylinder head of the engine.

Calorific Value.—The calorific value of a fuel can be calculated with a fair approach to accuracy from the known calorific values for carbon and hydrogen. The heat produced by the complete combustion of 1 gram of carbon is 8080 calories and of hydrogen 34,462 calories. The calorific value of alcohol can be calculated from these figures and from the percentage composition as follows :

$$\text{Carbon } 0.5213 \times 8,080 = 4212.1 \text{ calories}$$

$$\text{Hydrogen } 0.1312 \times 34,462 = 4521.4 \quad "$$

$$\underline{8733.5} \quad "$$

Less hydrogen required to combine
with oxygen already present :

$$0.0434 \times 34,462 = 1495.6 \quad "$$

$$\text{Calorific value} = \underline{7237.9} \quad "$$

Similarly, the theoretical calorific value of the pure constituents

of fuel mixtures may be calculated. For instance, the value for methyl alcohol is found to be 5212·5, benzene 10,111·4, and acetone 7486·5 calories per gram. From these figures the theoretical calorific values of mixtures such as methylated spirit may be ascertained, provided that the proportion of each constituent in the mixture is known. The theoretical value for methylated spirit of the composition given above is approximately 6281 calories.

It is, however, more satisfactory to rely on experimental determinations of the calorific value. Calculation from the percentage composition involves the assumption that the oxygen is already combined in the molecule in the form of water, an assumption which is not always justified. In point of fact, calculated calorific values seldom agree exactly with those found by direct experiment.

Gross and Net Calorific Values.—In determining experimentally the heat of combustion in a bomb calorimeter, we start with the liquid fuel at a temperature of about 15° C., and the end products of combustion are carbon dioxide and water cooled to approximately the same temperature. In the internal combustion engine the end products of combustion are ejected at a temperature considerably higher than the boiling-point of water. The water formed is not condensed, as in a bomb calorimeter, but leaves the engine in the form of steam. To obtain the number of heat units actually supplied to the engine by the combustion of the fuel, the so-called "lower" or "net" calorific value, it is therefore necessary to subtract from the gross calorific value the latent heat of vaporisation of water.

Thus the combustion of 1 gram of alcohol produces 1·1808 gram of water. The latent heat of vaporisation of water is 537 calories per gram. The net calorific value of alcohol is therefore

$$7237\cdot9 - 634\cdot1 = 6603\cdot8 \text{ calories per gram.}$$

In some published work, slight variations are observed in the method of arriving at lower or net calorific values. Strictly speaking, the following corrections should be made in the gross value as found by the calorimeter in order to obtain the net heat units rendered available in the engine.

(i) The latent heat of vaporisation of the fuel, which enters the cylinder partly in the form of spray and partly as vapour, should be added to the total calorific value. The reason that this value has to be *added* is that the fuel at the end of the compression stroke—that is, at the commencement of the heat cycle—is in the state of vapour. Its heat content has been increased by the amount of the latent heat, this heat being drawn from sources outside the actual heat cycle.

CALORIFIC VALUES OF VARIOUS FUELS (EXCLUSIVE OF LATENT HEAT)

Fuel.	Specific Gravity.	Gross Calorific Value.				Net Calorific Value.			
		C.H.U.		B.Th.U.		C.H.U.		B.Th.U.	
		Per Pound.	Per Gallon.	Per Pound.	Per Gallon.	Per Pound.	Per Gallon.	Per Pound.	Per Gallon.
Alcohol (absolute) . . .	0.7936	7,105	56,395	12,790	101,500	6,471	51,360	11,645	92,450
„ (95 per cent.) . . .	0.816	6,565	53,570	11,815	96,425	5,938	48,460	10,690	87,230
„ (90 per cent.) . . .	0.834	6,082	50,720	10,945	91,295	5,462	45,560	9,830	82,010
Methyl alcohol. . . .	0.796	5,316	42,320	9,570	76,170	4,712	37,500	8,480	67,510
Methylated spirit (mineralised)	0.820	6,290	51,580	11,320	92,820	5,750	47,150	10,350	84,900
Ethyl ether	0.720	8,807	63,400	15,850	114,120	8,154	58,710	14,675	105,680
Heptane	0.712	11,520	82,040	20,735	147,670	10,747	76,520	19,345	137,730
Petrol	0.740	11,250	83,240	20,250	149,830	10,488	77,730	18,880	139,700
Benzene	0.879	10,014	88,020	18,025	158,435	9,642	84,760	17,355	152,570
90's Benzol	0.872	10,060	87,700	18,110	157,860	9,664	84,280	17,395	151,700

(ii) The latent heat of vaporisation of water should be subtracted.

(iii) The heat given out on cooling the water, apart from its latent heat, the carbon dioxide, and the nitrogen of the exhaust from the exhaust temperature to atmospheric temperature, should also be subtracted.

It is usual to apply only the second of these corrections, involving the latent heat of vaporisation of water. The latent heat of the fuel, when dealing with petrol or benzol, is small, that of petrol being about 75 and that of benzol 92 calories per gram. Moreover, the correction for the heat of vaporisation of the fuel will be of opposite sign to that for cooling of the exhaust gases, so that these will tend to neutralise one another. The latent heat of alcohol is much higher, 220 calories per gram, and of methylated spirit, 252 calories. It has been shown by Ricardo and by Tizard and Pye that the relatively high latent heat of alcohol is of considerable importance when comparing it with other fuels.

The calorific values of alcohol and certain alcohol mixtures compared with other fuels are shown in the table on p. 235. They have been compiled from the most accurate data available.¹ It will be noticed that when comparing B.Th.U. per pound and per gallon the difference in specific gravity of the various fuels exercises a considerable effect on the relative values. Thus although petrol produces the greatest number of B.Th.U. per pound, benzol, by reason of its high specific gravity, has the highest calorific value per gallon. Again, one pound of alcohol has approximately two-thirds the calorific value of benzol, but on measurement by volume the difference between the two becomes greater. The calorific value of a 50 per cent. alcohol-benzol mixture does not fall far short of that of an equal volume of petrol. The comparatively low value for alcohol is, as already shown, due to the high content of oxygen which is contained in the molecule. On combustion this oxygen will combine with its equivalent of hydrogen to form water, thus reducing the quantity of hydrogen available for combustion.

Air required for Combustion.—The weight of air theoretically required for the complete combustion of unit weight of fuel can be calculated from the following formula :

$$A = 0.116 (C + 3(H - \frac{1}{8}O)).$$

Where C = Percentage of carbon in the fuel.

H = Percentage of hydrogen in the fuel.

O = Percentage of oxygen in the fuel.

Taking the figures already given for the percentage composition of the different fuels, we find that

- 1 lb. hexane requires 15.37 lb. of air.
 1 lb. petrol requires 14.3 lb. of air.
 1 lb. benzene requires 13.38 lb. of air.
 1 lb. ethyl alcohol requires 9.1 lb. of air.
 1 lb. methylated spirits requires 7.9 lb. of air.

Thus alcohol requires for complete combustion not much more than half the quantity of air which is needed for petrol.

With a knowledge of the amount of air required for complete combustion and the lower calorific value of the fuel, we can calculate the heat set free by the combustion of unit volume of the "correct" mixture as exploded in the engine.

Fuel.	Molecular Weight.	Net calories per Gram-Molecule.	Vol. of Explosive Mixture in Litres per Gram-Molecule of Fuel.	Net calories per Litre of Explosive Mixture.
Hexane . .	86	927,080	1044	888
Benzene . .	78	751,600	830	906
Ethyl alcohol .	46	297,760	346	860

That is, equal volumes of the correct explosive mixtures of these fuels with air possess approximately the same calorific value.

To ascertain the total heat energy liberated by the combustion of one litre of explosive mixture, we must take into account the change in specific volume of the gas on explosion. The combustion equation of, *e.g.*, benzene is as follows :

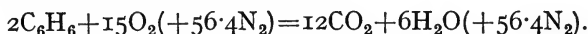

The total number of molecules before reaction is 73.4, and after reaction 74.4, and the ratio between the two, or the change in specific volume, is 1.013.

Similarly, the change in specific volume on combustion of hexane can be shown to be 1.053, and of ethyl alcohol 1.065.

The total heat energy liberated by the combustion of one litre of the correct explosive mixture is therefore

$$\begin{aligned}
 \text{Hexane} & . . 888 \times 1.053 = 935 \text{ calories.} \\
 \text{Benzene} & . . 906 \times 1.013 = 917 \quad ,, \\
 \text{Ethyl alcohol} & 860 \times 1.065 = 916 \quad ,,
 \end{aligned}$$

i.e. practically the same for the three fuels (Tizard and Pye).

This is found to be approximately true for all hydrocarbon fuels and for those of the alcohol group, but not for acetylene, carbon

disulphide, and hydrogen, when these are used as fuels. The value for acetylene is higher, and for carbon disulphide and hydrogen lower, than those given above.

The total energy liberated by unit volume of the explosive mixture will clearly determine the power output of the engine. It therefore appears that the power output with all hydrocarbon fuels and with alcohol should be approximately the same, provided that they are tested under similar conditions. While this is true for hydrocarbon fuels, it is not equally applicable to alcohol, owing to the effect produced by the high latent heat of alcohol (cf. p. 242).

It is evident that, although under similar conditions in the same engine the total energy liberated and the power output are approximately the same for petrol, benzol, and alcohol, the consumption of alcohol will be from 1.5 to 2 times as great as that of petrol, and it follows that when using alcohol a larger carburettor jet is required. The relative areas of jet for use with petrol and alcohol will be roughly in inverse proportion to the calorific values of the two fuels.

In practice it is always found that more air is required for complete combustion than is indicated by theory. If the exact proportion of air is used, there will always be a certain amount of carbon monoxide in the exhaust gas. The quantity of air which is being used in excess is usually ascertained with sufficient accuracy for practical purposes from exhaust gas analysis. Fig. 31 shows the results obtained by Watson with a single-cylinder Daimler sleeve-valve engine on petrol, benzol, and methylated spirit.² With methylated spirit the point at which CO disappeared from the exhaust corresponded with an excess of 1.4 per cent. of oxygen, equivalent to 6.1 per cent. of air. With benzol and petrol under the same conditions the excess of air required for perfect combustion was smaller.

The admixture of air sufficient for complete combustion does not necessarily lead either to the highest thermal efficiency or to the development of maximum power.

From Fig. 32 it is seen that the highest efficiency with petrol under certain conditions was obtained with a mixture of approximately 17 : 1 by weight, while in a similar series of tests by Watson on a Daimler engine with petrol, benzol, and alcohol, the maximum thermal efficiency was not attained even with still higher proportions of air to petrol (Fig. 47, p. 292). On the other hand, the maximum mean effective pressure was attained with a mixture slightly richer than the theoretical (Fig. 33). With alcohol the M.E.P. increased more rapidly with strength of mixture than was the case with petrol or benzol, and still showed signs of increasing with the strongest mixture used, six parts air to one part alcohol

by weight, giving 6 per cent. of CO in the exhaust. Watson therefore concluded that if the carburettor be adjusted to give approximately maximum power with alcohol, there will be appreciable loss due to incomplete combustion (Fig. 48, p. 292). The explanation

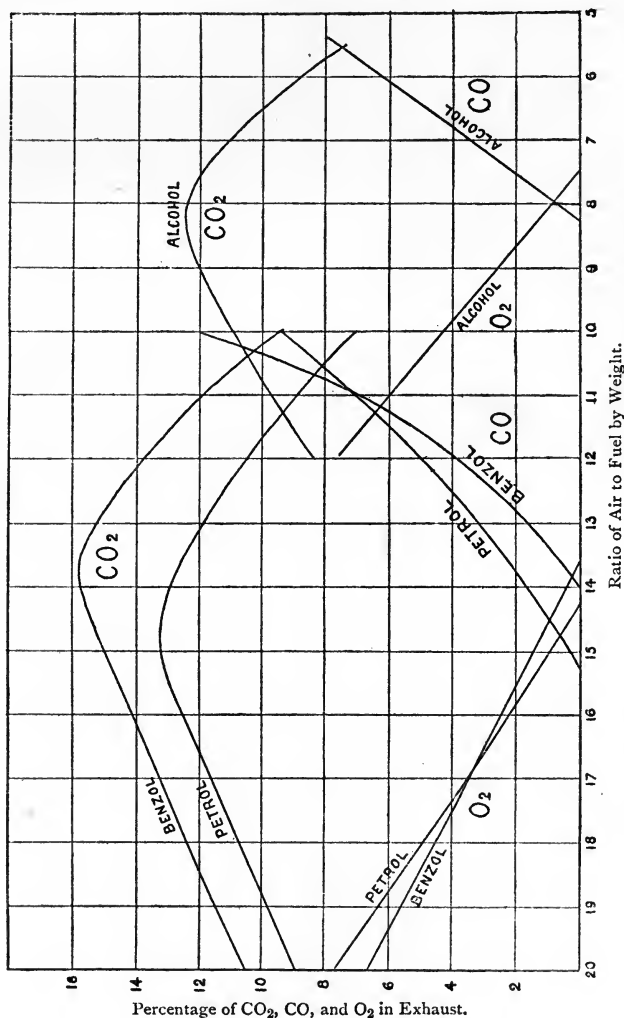

FIG. 31.—Composition of Exhaust Gas. Single-cylinder Knight Sleeve-valve Engine. (W. Watson and others, *Proc. Inst. Automobile Engineers*, 1914-15, 9, 73.)

of this, according to Ricardo, is that, when alcohol is used, the richer the mixture the lower is the temperature of the charge prior to compression, owing to the high latent heat of alcohol. The cooler the charge the higher is the volumetric efficiency and the greater the compression pressure, with the result that the power

output continues to increase slightly as the mixture becomes richer.

In exact bench tests of engines on different fuels it is frequently

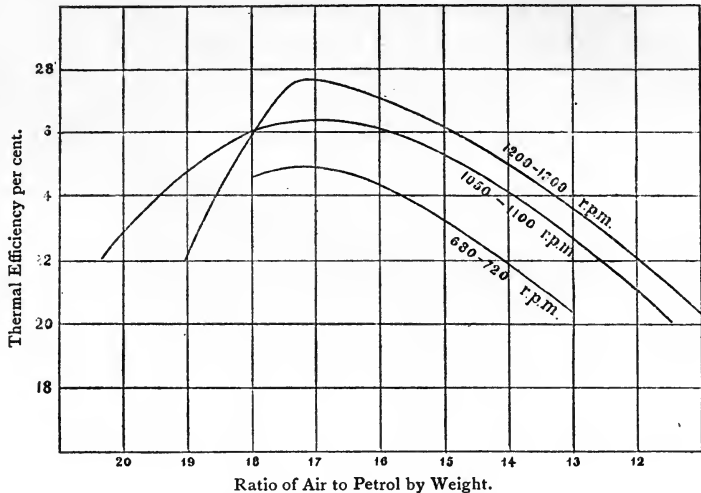

FIG. 32.—Thermal Efficiency of Four-cylinder Clement-Talbot Engine with Petrol.

(W. Watson, *Proc. Inst. Automobile Engineers*, 1908-9, 3, 387.)

Compression ratio, 4.71 : 1.

necessary to carry out analyses of the exhaust gases. Direct estimations are usually made of the amount of CO_2 , CO , and O_2 in the gas. The percentages of hydrogen and methane can be

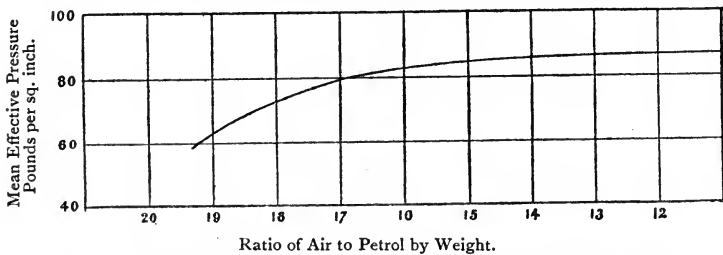

FIG. 33.—Mean Effective Pressure in Four-cylinder Clement-Talbot Engine with Petrol. (Watson.)

Compression ratio, 4.71 : 1.

calculated from that of carbon monoxide, using the ratios given by Ballantyne.³

$$\text{Percentage of H}_2 = \text{percentage of CO} \times 0.36.$$

$$\text{Percentage of CH}_4 = \text{ " " } \times 0.12.$$

Certain precautions are necessary in taking the samples.⁴ A glass gas-sampling burette is attached to the exhaust manifold as close to the cylinders as possible. If the samples be taken too near the silencer, oscillation of the gas in the exhaust owing to the repeated explosions may result in air being drawn in from outside. The opening in the exhaust manifold through which the sample is drawn must be small, so as to ensure that the sample is representative of several explosions. The time taken in displacing the air of the burette by exhaust gas should be about three to four minutes. If too large a hole be used, the contents of the burette would be affected too much by successive explosions. Under these conditions it is found that carbon monoxide and oxygen do not occur together in the exhaust gases except in very small amounts.

Watson found the following percentages of CO₂, CO, and O₂ in the exhaust of a single-cylinder car in four samples taken at random while the car was on the road.

CO ₂ per cent.	CO per cent.	O ₂ per cent.
12.6	2.2	0
11.0	4.4	0
12.8	0.4	1.8
11.6	0.2	3.8

Exhaust gas analyses showing considerable amounts of both CO and O₂ point to the probability that

- (i) The richness of the carburettor mixture has altered during collection of the samples, or
- (ii) Slightly different mixtures are being supplied to the different cylinders, or
- (iii) Air is being drawn in through a leak in the exhaust pipe.

Latent Heat of Vaporisation.—Ricardo found that when hexane, benzene, and alcohol were tested in an experimental engine at a constant compression ratio of 5 : 1 with ignition fully advanced and under different conditions of heat supply to the carburettor, the power output as shown by the indicated mean effective pressure was as follows :

	Indicated Mean Pressure (Pounds per Square Inch).		
	No Heat to Carburettor.	65 B. Th. U. per Minute added to Carburettor.	Heat added sufficient to produce Constant Recorded Temp. of 15° C. at Inlet.
Hexane . . .	140.1	132.3	132.3
Benzene . . .	139.8	131.6	123.7
Alcohol . . .	145.2	137.8	139.3

The power given by alcohol is seen to be considerably greater than that of the other fuels, although according to the figures given on p. 237 for total heat energy liberated by unit volume of the explosive mixture, the power output should be approximately the same for all these fuels. The values for total energy are, however, calculated on the assumption that the whole of the fuel is brought into the state of vapour before the commencement of the compression stroke by contact with the hot walls and admixture with the highly heated residual exhaust products in the cylinder. The power output is inversely proportional to the absolute temperature at the end of the suction stroke, since it is the temperature at this point which controls the weight of charge and therefore the volumetric efficiency. In the case of hydrocarbon fuels boiling below 200° C., the whole of the fuel is in the state of vapour before this point is reached, and the absolute temperature of the charge before compression is approximately the same in each case. With alcohol, owing to its high latent heat and to the fact that the proportion of fuel to air is comparatively high, evaporation is not complete at this point, and the suction temperature is lower. This leads to higher volumetric efficiency and greater power output.

The fall in temperature of the mixture with various fuels was found to be as follows :

	Latent Heat of Evaporation. (Calories per Gram.)	Fall in Temperature of Mixture due to Latent Heat. (Degrees C.)
Hexane	86.6	21.0°
Benzene	95.5	26.0°
Ethyl alcohol	220.5	83.0°
Methyl alcohol	284.4	140.0°

If the proportion of alcohol in the mixture is increased, the suction temperature is still further lowered, and thus the power output with alcohol continues to increase slightly with increasing richness of mixture. With petrol the power falls off if the mixture is too rich owing to the higher specific heat of the products of combustion, but with alcohol the latter factor is outweighed by the gain in weight of the charge (Fig. 33A).

Moreover, in the case of alcohol, evaporation continues to some extent during the compression stroke, with the result that the compression is more nearly isothermal. The temperature of the cycle

is therefore lowered, the losses due to conduction and to change in specific heat are reduced, and the thermal efficiency is in consequence slightly increased. With methyl alcohol, which possesses a higher latent heat of vaporisation than ethyl alcohol, Ricardo found that both the power output and efficiency were considerably greater than with any other fuel examined.

Rate of Flame and Temperature of Explosion.—The researches of Berthelot, Vieille, Mallard and Le Chatelier, Dixon, and others have shown that the explosion of a mixture of air and combustible gas when fired by a spark takes place in stages. The flame, starting from the point of ignition, travels at first comparatively slowly through the gas mixture. During its course it meets with sound waves reflected from the walls of the vessel, and these have the effect of increasing the velocity and intensity of the flame. At a certain point in its course the cumulative effect of the sound waves crossing and re-crossing the flame gives rise, according to Dixon, to the true explosion wave or detonation.

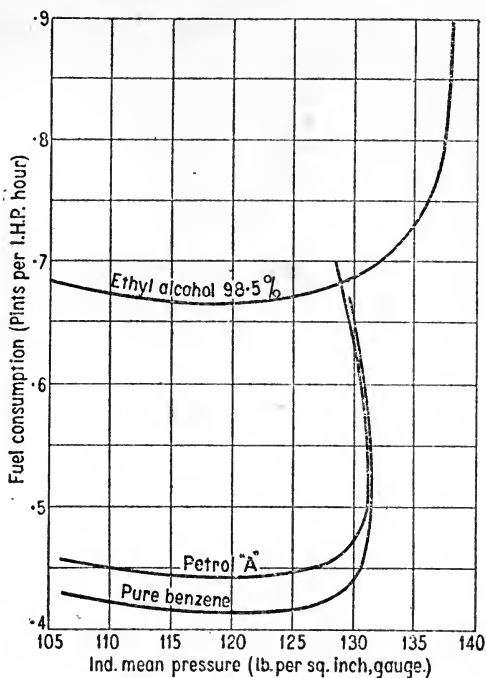

FIG. 33A.

(H. R. Ricardo, *Automobile Engineer*, June 1921, p. 203.)

The velocity of the detonation wave is constant for a given gas mixture under given conditions and is approximately equal to twice the velocity of sound in the gas.

The rate of flame propagation in alcohol-air mixtures is smaller than in air-petrol mixtures. When, on the other hand, the detonation wave has once been set up, the rates do not vary greatly with different fuels. Dixon⁵ found detonation rates varying from 1600 to 2500 metres per second, using alcohol, pentane, benzene, and ether with different proportions of oxygen and nitrogen. There was no striking difference between the four fuels in the rate

of the detonation wave. Ether mixtures gave slightly the fastest rates and alcohol the slowest, under similar conditions. When the different fuels were mixed with oxygen or air in the proportions necessary for complete combustion, the detonation wave travelled with nearly the same velocity in all of them. In the engine cylinder under normal conditions it is the period of true flame propagation which is of importance, and although the flame has been found by Dixon to start faster in alcohol-air than in petrol- and ether-air mixtures, the mean velocity of the alcohol flame is considerably less than that of the petrol flame.

The detonation or explosion wave must be avoided in an internal combustion engine, since it may give rise to considerable pressures in the cylinder with consequent strain on the structural materials and moving parts. The factors controlling detonation have been the subject of much experimental work, and a comprehensive investigation recently undertaken by H. R. Ricardo⁶ has thrown much light on the various questions involved. According to Ricardo, the tendency of a fuel to detonate is the one outstanding factor in determining its value for use in an internal combustion engine. He explains the phenomenon of detonation as follows :

“When a mixture of hydrocarbon vapour and air is compressed to a high pressure and to a temperature approaching that of its self-ignition temperature, and ignition is started from any point, the flame at first spreads from this point by the normal process of combustion, and compresses before it the unburnt portion of the charge. When the rise in temperature of the unburnt portion due to compression by the burning gases exceeds the rate of heat dissipation by a certain margin, spontaneous ignition takes place, and an explosion wave is set up which strikes the wall of the combustion chamber with a hammer-like blow, thus causing the familiar metallic ring known as ‘pinking’ or detonation. It also has the effect of compressing and still further raising the temperature of the portion first ignited, and with it the temperature of the ignition points. If detonation be allowed to persist, it will, unless it be very slight, increase in severity and ultimately raise the temperature of the sparking plug points or some other partially insulated object in the combustion chamber, to such a degree as to cause pre-ignition, quite a distinct phenomenon.”

According to this view, the tendency of a fuel to detonate depends largely on the relative rate at which it burns when mixed with air. Detonation only occurs when the rate of burning is greater than the rate at which the unburnt portion of the fuel mixture can lose its heat through the cylinder walls. Detonation is largely de-

pendent on the design of the combustion chamber and the position of the ignition plug. If the clearance space contain valve pockets or be otherwise irregular in shape, part of the unburnt gas may become stagnant and unable to give up its heat at a greater rate than it is generated by the compression due to combustion of that part of the gas mixture nearest to the ignition point. The more central the position of the plug the less danger will there be of detonation, since the flame will spread more evenly through the gas mixture. Similarly it is of advantage if the ignition plug be in the neighbourhood of the exhaust valve, so that the unignited gas may be driven, not towards the hot exhaust region, but towards the cooler parts of the compression space.

The "turbulence" of the charge is an important factor in determining detonation. If the conditions be such as to promote rapid movement of, and interchange between, all parts of the gaseous mixture, uniform distribution of the flame will be assisted and the tendency to detonate will be reduced.

It is to be expected, therefore, that different engines should show great variations in the compression ratios at which detonation will occur with any particular fuel.

Detonation is more likely to occur at low than at high speeds, since in the latter case turbulence will be greater and there will be less time for stagnation of parts of the charge to occur in the hotter regions of the combustion chamber, such as in the neighbourhood of the exhaust valve.

Ricardo, working with a specially designed engine (cf. p. 229) found that the highest compression ratios which could be used with various fuels were as follows, when ignition and mixture strength were adjusted to give maximum efficiency :

	Compression Ratio.	Compression Pressure. (Pounds per Sq. Inch Gauge.)
Petrol (various brands) . . .	4.55 : 1 to 6.0 : 1	96 to 148.5
Benzene (98 per cent.) . . .	6.9 : 1	179.0
Toluene and xylene . . .	>7.0 : 1	>183.0
Alcohol (98 per cent.) . . .	>7.5 : 1	>204.0
Methylated spirits . . .	6.5 : 1	163.5

These values were obtained with an engine so designed as to reduce to a minimum all factors likely to favour detonation, and it does not follow that such high compressions can be used in all types of engines.

In the case of benzene and methylated spirits the values given are those above which pre-ignition occurred, since this took place before audible detonation. Alcohol, toluene, and xylene could not be made to detonate under any circumstances in the engines employed.

By reducing or increasing the ratio of air to fuel so as to give a slower burning mixture, or by retarding the ignition, the compression ratio at which detonation occurs can be raised, but this is only attained at the cost of power and economy. The ratio above which detonation commences, with both the ignition and mixture strength adjusted to give the highest efficiency, is taken by Ricardo as representing the "highest useful compression ratio" for any fuel.

With hydrocarbon fuels, the ability to stand a high compression ratio without detonation is largely determined by the proportion of aromatic substances present. The addition of toluene to a petrol consisting of paraffins and naphthenes raises the limiting compression ratio in direct proportion to the amount of toluene added. Similarly, by the addition of hexane to either toluene, xylene, ethyl alcohol, or acetone, none of which detonate below a compression ratio of 7 : 1, the limiting compression ratio for detonation can be brought down to any desired point, varying linearly with the amount of hexane added. Ricardo has proposed to specify fuels according to their "toluene value" as expressing their tendency to detonate in terms of their equivalent toluene content. The toluene value for a petrol freed as far as possible from aromatic compounds is nil, while that of toluene itself is 100 per cent. Benzene has a "toluene value" of 67 per cent., while that of alcohol is above 88 per cent.

If it were not for the effect of turbulence in equalising the rates of flame propagation in different fuels, it is conceivable that part of the charge might remain unburnt at the end of the expansion stroke and escape into the exhaust in this condition. This would result in a decrease in power and efficiency which would be more pronounced at high speeds.

Ormandy⁷ found, when testing several different fuel mixtures in a Maudslay 17 h.p. four-cylinder engine with a compression ratio of 4 : 1, that up to 1000 r.p.m. the B.H.P. and consumption of the fuels used ran fairly parallel, the thermal efficiency with alcohol-benzol mixtures being considerably higher than with petrol or benzol alone. At higher speeds the B.H.P. with alcohol mixtures fell off rapidly compared with petrol (cf. Fig. 44, p. 288). This was partly due to the greater degree of throttling necessary with alcohol at the higher speeds and the consequent lower volumetric

efficiency, but was mainly the result, in his opinion, of the slow rate of flame in alcohol.

He found that at higher speeds and as the proportion of alcohol in the fuel increased, the exhaust valves had the appearance of having been subjected to greater heat than was the case with petrol under similar conditions. This pointed to the probability that the combustion of alcohol was so slow that it was still in progress when the exhaust valve opened, and part of the charge escaped into the exhaust unburnt. He quotes Junkers' axiom that for high thermal efficiency the temperature throughout the cycle should be as low as possible, and considers that the highest thermal efficiency is got from that fuel mixture which burns with the lowest speed consistent with the piston velocity desired. The petrol-air explosion is more rapid, causing higher instantaneous pressure and temperature, and leading to excessive heat losses through the cylinder head. These thermal losses are not so great with the slower burning alcohol, with which therefore a high thermal efficiency is obtained, provided that the combustion is completed before the end of the expansion stroke.

The effect would be analogous in some degree to the action of an explosive in a gun. If a dynamite cartridge be used in a gun, most of the energy of the explosion is wasted in shattering the breech and comparatively little effect is produced on the projectile. If a slower burning propellant such as gunpowder be used, the greater part of the energy set free is expended on the projectile. The maximum effect is produced by a propellant, the combustion of which is completed at the moment the projectile leaves the muzzle of the gun.

More recent experiments, however, have shown that the maximum explosion temperatures attained with petrol, benzol, and alcohol are of much the same order, and that any reduction in temperature and pressure which might be caused by the slower rate of flame with alcohol is largely nullified by the effects of turbulence. Watson⁸ showed that the temperatures attained in the cylinder when alcohol, benzol, or petrol are used do not differ appreciably. His results are shown in Fig. 34. The temperature curves were calculated from the indicator diagrams obtained from different fuels with varying proportions of air. For each fuel curves are given representing the temperatures of the different mixtures at definite points in the cycle, these points being indicated by the angle formed by the crank with the cylinder axis. Thus at 36° crank angle, when the piston is commencing its outward course immediately after the explosion, the temperatures were very nearly the same (approximately 2100° C.), that with alcohol being

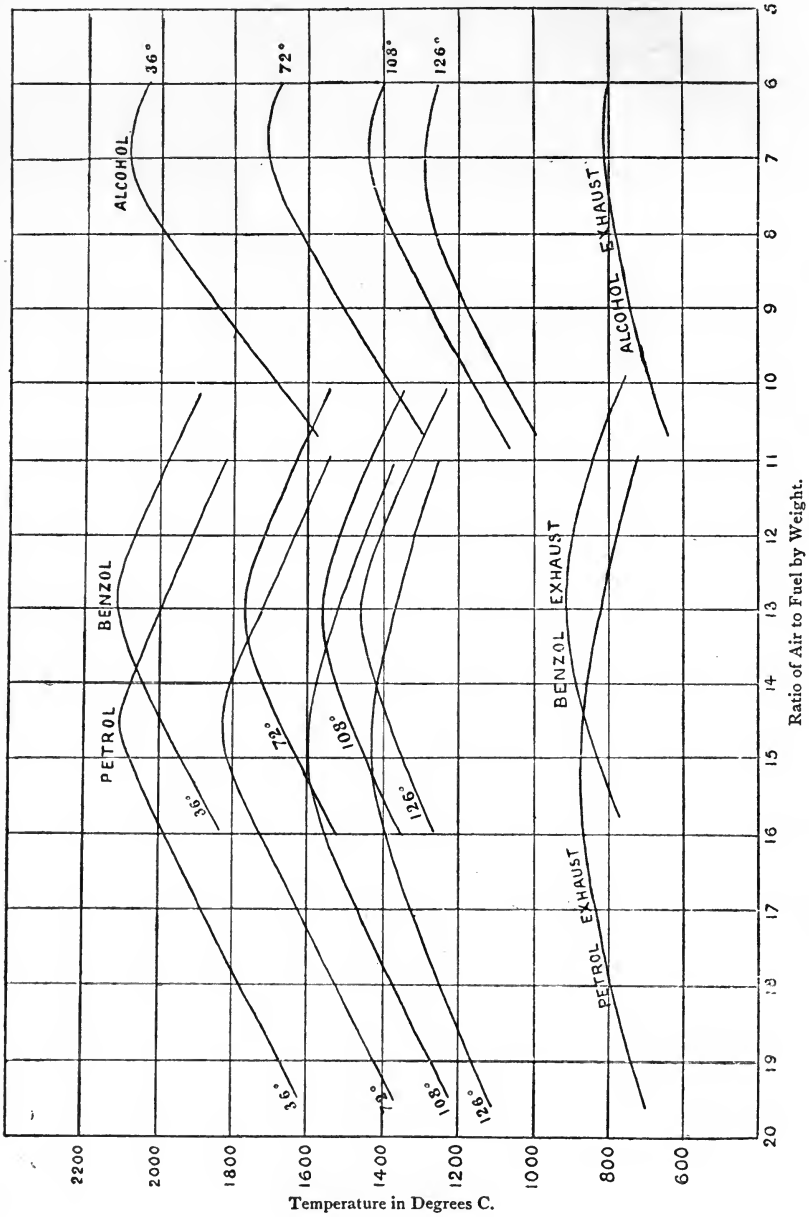

FIG. 34.—Temperatures during Expansion Stroke with Different Fuels.

(W. Watson, Proc. Inst. Automobile Engineers, 1914-15, 9, 73.)

slightly the lowest. The temperatures when alcohol was used fell off more rapidly, during the expansion stroke, than was the case with petrol and benzol. The actual maximum temperatures were 2100° C. for petrol, 2110° C. for benzol, and 2080° C. for alcohol. It is probable that these temperatures did not represent the highest attained. The point for which they were calculated was some distance after inner dead centre, and was chosen as being the earliest point at which the indicator diagram of the Knight engine was quite free from disturbance due to the rapid explosion of petrol, since the spark had to be appreciably retarded to avoid knocking.

Tizard and Pye⁹ calculated from theoretical considerations the maximum explosion temperatures with benzene, heptane, and alcohol, taking into account the specific heats of the reaction products at high temperatures, dissociation, and increase in specific volume, and assuming that there are no heat losses. Their results were as follows :

Degree of Richness of Mixture.	Maximum Explosion Temperatures. (Degrees C.)		
	Benzene.	Heptane.	Alcohol.
50 per cent. weak	1994
20 per cent. weak	2470
Correct	2655	2591	2507
10 per cent. rich	2690	2623	2524
20 per cent. rich	2701	2603	2505
30 per cent. rich	2681	2527	2429
40 per cent. rich	2630	2448	2348
50 per cent. rich	2561	2366	2278

If the proportions by weight of carbon dioxide and steam in the cylinder gases resulting from the explosion of petrol-air, benzol-air, or alcohol-air mixtures be calculated, it is found that alcohol produces the most steam and benzol the least, in proportion to the amount of carbonic acid formed. The difference is still more marked if account be taken of the water which is always present in commercial alcohol. Since the specific heat of steam is rather more than double that of carbon dioxide, the explosion temperature should be lowest for alcohol and highest for benzol. This relationship is apparent in the temperatures arrived at theoretically by Tizard and Pye, and also in those calculated by Watson from indicator diagrams.

Similar relationships are apparent between the different fuels when the thermal efficiencies at equal compression ratios are com-

pared. Watson, working with a Knight engine, found thermal efficiencies of 26.9 per cent. for alcohol, 26 per cent. for benzol, and 24.8 per cent. for petrol. Ricardo found that the thermal efficiencies for all hydrocarbon fuels at any given compression ratio and with identical inlet temperatures and ignition timings, were the same, but that the efficiency obtained with alcohol was consistently higher. Careful tests were run with 95 per cent. alcohol and benzene and also with various petrols within the limits of useful compression ratio. Conditions as to speed, jacket temperature, and rate of heat input to the carburettor were exactly the same for all the fuels. The results were as follows :

Compression.	Indicated Thermal Efficiency. Alcohol (95 per cent.).	Indicated Thermal Efficiency. Hydrocarbons.
3.8 : 1	26.8	26.3
5.0 : 1	32.5	31.7
7.0 : 1	38.2	37.4

It is seen that the thermal efficiency obtained with alcohol at all compression ratios was roughly $2\frac{1}{2}$ per cent. higher than that obtained with hydrocarbon fuels. This is explained by the reduction in the temperature of the cycle due to the evaporation of alcohol within the cylinder. It has been pointed out above (p. 242) that the fall in temperature of the mixture due to latent heat amounts to 83° C. in the case of ethyl alcohol as compared with 21° C. for hexane. With 95 per cent. alcohol, owing to its high water content, the fall in temperature will be about 97° C. Ricardo considers it probable that the whole of the alcohol and the water contained in it evaporates completely before the end of the compression stroke. The temperature at the completion of the compression stroke will therefore be, in the case of alcohol, some 70° C. lower than in the case of petrol. Since the maximum calculated flame temperature is also about 100° C. less than that of a petrol mixture, it follows that with alcohol the highest temperature attained will be approximately 170° C. lower than that of a petrol mixture. The loss of heat to the jackets, and that due to change of specific heat, etc., will be substantially reduced, and the thermal efficiency therefore increased.

Temperature of Spontaneous Ignition.—The temperature at which a fuel, in admixture with air or oxygen, will ignite spontaneously may be of some importance as a factor, additional to

the rate of flame propagation, in determining the liability to detonation or pre-ignition. It has been found that different fuels vary greatly in this respect.

Moore¹⁰ has determined the spontaneous ignition temperatures of various fuels in air and oxygen under atmospheric pressure. He gives the following values :

	Oxygen.	Air.
Alcohol (sp. gr. 0·817)	395° C.	518° C.
Benzol (100 per cent.) (sp. gr. 0·875)	566° C.	..
Petrol (sp. gr. 0·710)	272° C.	383° C.
Lubricating oil	265·5° C.	405° C.

Holm¹¹ gives for spontaneous ignition in air :

Alcohol	510° C.
Benzene	520° C.
Petrol	415° C.
Lubricating oil	380° C.

H. B. Dixon¹² has determined the ignition temperatures of alcohol, ether, pentane, alcohol-benzene mixtures, and alcohol-ether mixtures when heated by adiabatic compression, under conditions approximating closely to those of an internal combustion engine. He experimented with various proportions of fuel to air and oxygen, and found the range of ignition temperatures to be as follows :

	Ignition Temperature.
Alcohol 1 vol. +oxygen 2 vols.	405° C.
Alcohol 1 vol. +air 15 vols.	550° C.
Ether (all mixtures)	315-325° C.
Pentane 1 vol. +oxygen 8 vols.	445° C.
Pentane 1 vol. +air 40 vols.	510° C.
Hexane 1 vol. +air 47·5 vols.	500° C.
Benzene 1 vol. +air 37·5 vols.	464° C.
Alcohol 0·6 vol. +benzene 0·4 vol. +air 24 vols.	545° C.
Alcohol 0·6 vol. } + Ether 0·4 vol. } +air 21 vols.	370° C.

Dixon observed that in firing gases by adiabatic compression without the use of an igniting spark, ignition occurred more readily when the gas was driven towards the apex of a cone.

In general, it may be said that the higher the molecular weight of substances in the same homologous series the lower is the ignition

point—that is to say, the more complex the molecule the less stable is it towards heat (Moore).

The expressions $TV^{\gamma-1} = \text{constant}$ and $\frac{T^\gamma}{P^{\gamma-1}} = \text{constant}$ (p. 218) afford a means of calculating the temperatures produced by compression in the cylinder before the charge is fired. Owing to thermal losses through the cylinder walls the expressions become $TV^{n-1} = \text{constant}$ and $\frac{T^n}{P^{n-1}} = \text{constant}$.

These may be written :

$$T_1 V_1^{n-1} = T_2 V_2^{n-1} \text{ or } T_2 = T_1 \left(\frac{V_1}{V_2} \right)^{n-1}$$

and

$$\frac{T_1^n}{P_1^{n-1}} = \frac{T_2^n}{P_2^{n-1}} \text{ or } T_2 = T_1 \left(\frac{P_2}{P_1} \right)^{\frac{n-1}{n}}$$

where T_1 and T_2 are initial and final absolute temperatures, P_1 and P_2 initial and final pressures, and n has a value of approximately 1.34.

The initial temperature T_1 at the commencement of the compression stroke will vary according to the inlet temperature of the mixture, the amount of heat abstracted from the cylinder walls during the suction stroke, and the amount and temperature of the residual exhaust gases. It will thus depend to some extent on the design of the engine, but for the more volatile fuels the suction temperature may be taken as approximately 100°C. or 373° absolute. In the case of alcohol, the high latent heat causes the charge to be about 60°C. cooler than this, or, say, 313° absolute.

We have, therefore, taking a compression ratio of 4.5 : 1, with a volatile fuel,

$$\begin{aligned} T_2 &= 373 \cdot \left(\frac{4.5}{1} \right)^{0.34} \\ &= 622^\circ \text{ absolute, or } 349^\circ \text{ C.} \end{aligned}$$

The compression pressure can be calculated from the expression :

$$PV^n = \text{constant, or } P_2 = P_1 \left(\frac{V_1}{V_2} \right)^n$$

Assuming the pressure in the cylinder at the end of the suction stroke to be 0.9 atmosphere (13.23 lb. per sq. inch absolute),

$$\begin{aligned} P_2 &= 0.9 \left(\frac{4.5}{1} \right)^{1.34} \\ &= 6.75 \text{ atmospheres or } 99.2 \text{ lb. per sq. inch} \\ &\quad \text{absolute.} \\ &= 84.5 \text{ lb. per sq. inch gauge.} \end{aligned}$$

and

$$\begin{aligned}
 T_2 &= T_1 \left(\frac{P_2}{P_1} \right)^{\frac{\gamma-1}{\gamma}} \\
 &= 373 \cdot \left(\frac{6.75}{0.9} \right)^{0.34} \\
 &= 622^\circ \text{ absolute, or } 349^\circ \text{ C.}
 \end{aligned}$$

With alcohol the corresponding compression temperature would be somewhat lower, owing to the high latent heat.

H. R. Ricardo gives the following pressures and temperatures corresponding to different compression ratios in the experimental engine used by him. The compression ratios are the highest in each case which could be used without detonation of the fuel occurring.

Fuel.	Compression Ratio.	Compression Pressure. (Pounds per Sq. Inch Gauge.)	Compression Temperature. (Degrees C.)
Petrol (free from aromatic compounds)	4.85 : 1	105.5	392°
Petrol (A)	6.0 : 1	148.5	430°
Hexane (80 per cent.)	5.1 : 1	113.5	401°
Heptane (pure)	3.75 : 1	72.0	353°
Benzene	6.9 : 1	179.0	450°
Toluene	>7.0 : 1	>183.0	>452°
Ethyl alcohol	>7.5 : 1	>204.0	>424°
Ether	2.95 : 1	47.5	305°

In the case of alcohol and toluene detonation did not occur at the highest compression ratio used, while with benzene pre-ignition occurred before audible detonation. When these figures are compared with those given by Moore and by Dixon it is evident that there is no definite relationship between them, with the possible exception of fuels such as benzene, where pre-ignition occurs without previous detonation.

The correlation of spontaneous ignition temperatures in air or oxygen with pre-ignition temperatures in the engine is complicated by the occurrence of detonation before pre-ignition. Even in fuels which pre-ignite without detonating it is difficult to determine the pre-ignition temperature, since this clearly depends largely upon the temperature of the exhaust valve, sparking plug points, and other insulated parts of the combustion chamber. These may retain sufficient heat to fire the mixture although the compression temperature is well below the ignition point.

Explosive Range.—The range of percentage composition

within which propagation of flame can occur is much greater in alcohol-air than in petrol-air mixtures. The actual limits given by different observers vary to some extent, especially as regards the upper limit. Lewes¹³ gave the following limits for various fuels :

Petrol	.	.	.	2.0 to 4.0 per cent. by volume.
Benzene	.	.	.	2.7 " 6.3 " "
Alcohol	.	.	.	4.0 " 13.6 " "
Acetylene	.	.	.	3.2 " 52.2 " "
Ether.	.	.	.	2.9 " 7.5 " "

Brunswig¹⁴ gives :

Alcohol	.	.	.	4.0 to 13.7 per cent. by volume.
Ether.	.	.	.	2.7 " 7.7 " "
Acetone	.	.	.	5.0 " 12.0 " "

Bunte and Eitner¹⁵ give :

Alcohol	.	.	.	3.95 to 13.65 per cent. by volume.
---------	---	---	---	------------------------------------

Thornton's¹⁶ figures are :

Methyl alcohol	.	.	.	5.5 to 21.0 per cent. by volume.
Ethyl alcohol	.	.	.	2.8 " 9.5 " "
Benzene	.	.	.	1.5 " 8.0 " "
Pentane	.	.	.	1.35 " 4.5 " "
Acetylene	.	.	.	3.0 " 46.0 " "

while A. G. White and T. W. Price¹⁷ give for downward and horizontal propagation of flame :

Alcohol	.	.	.	4.32 to 13.80 per cent. by volume.
Ether.	.	.	.	2.05 " 8.00 " "

White and Price found higher limits, up to 18.95 per cent. by volume for alcohol and 18.50 per cent. for ether, in the case of upward propagation of flame. It would appear that the convection currents set up when the mixture is ignited at the bottom of a tube and the flame allowed to travel upwards cause combustion to take place in a stronger mixture than would otherwise be the case. The exact limits appear also to depend to some extent on the dimensions of the tube in which the mixture is contained.

The figures given can be taken as representing only the relative explosive range under certain conditions. It is, however, highly probable that the explosive range of alcohol-air mixtures under the conditions obtaining in the cylinder of an engine is much wider than that of petrol-air and benzol-air mixtures. In an alcohol engine the strength of mixture may be varied within wider limits without causing miss-firing. The extraordinarily wide range shown by acetylene is remarkable. This property, together with the solubility of the gas in alcohol and its low vapour tension, has led to the suggestion that alcohol containing acetylene should be used as a motor fuel (p. 309).

Miscibility with Other Liquids.—Alcohol mixes in all proportions with water. The presence of water within certain limits does not render the alcohol unsuitable as a fuel, although it naturally reduces the power output of the engine by the amount of energy absorbed in vaporising the water. Strong and Stone¹⁸ found that denatured alcohol diluted with water in any proportion up to 50 per cent. could be used, provided that the engine was properly adjusted. They found that for a given compression ratio the consumption of pure alcohol for any given load increases, and the B.H.P. decreases, with an increase in water content. The increased consumption, however, was so small that the use of 80 per cent. instead of 90 per cent. alcohol had little effect on the performance of the engine (cf. p. 285).

The presence of water in alcohol, according to these observers, enables the compression to be increased without pre-ignition. With quantities of water ranging from nil to 20 per cent. the consumption of dilute alcohol per B.H.P. hour was found to be almost directly proportional to the amount of water present.

It would seem that the possibility of adding considerable quantities of water to alcohol and alcohol mixtures without appreciably affecting the performance of the engine might open the way to fraud on the part of the vendor. The consumer would possess no check upon the quality of the spirit supplied to him, beyond the fact that he was not getting the mileage per gallon that he expected. The Interdepartmental Committee¹⁹ in 1919 recommended that all sales and deliveries of power alcohol should be made on the basis of a certified percentage by volume of absolute ethyl alcohol, with a minimum of 90 per cent. at a temperature of 62° F. The Committee was further of the opinion that in denatured alcohol, or in admixtures of alcohol, benzol, ether, petrol, or the like, sold as power alcohol, the ratio of water to alcohol after admixture should not exceed one part by volume of water to nine parts by volume of alcohol, measured at ordinary temperatures.

The miscibility of alcohol and water must obviously reduce greatly the risk of fire during storage and transport, since burning alcohol can be immediately extinguished if sufficient water be at hand to reduce it below a certain strength. This would, however, not apply to mixtures of alcohol with petrol, benzol, or ether.

While alcohol and methylated spirit mix with water in all proportions, mixtures of alcohol with petrol or benzol separate into two liquids of different composition if more than a certain proportion of water be present, the point at which separation commences depending on the temperature. H. B. Dixon²⁰ gives the follow-

ing details as to the separation temperatures of such mixtures :

SEPARATION TEMPERATURES OF ALCOHOL-BENZENE MIXTURES ON ADDITION OF WATER.

C.c. of Water Added.	100 c.c. of Mixture.		
	50 c.c. Alcohol. 50 c.c. Benzene.	60 c.c. Alcohol. 40 c.c. Benzene.	70 c.c. Alcohol. 30 c.c. Benzene.
0	-5.45° C.	-10.45° C.	below -18° C.
2	-2.8° C.	-6.65° C.	-14.3° C.
3	-1.95° C.	-5.7° C.	..
3.5	-1.45° C.	-5.1° C.	..
4	-1.0° C.	-4.55° C.	-11.1° C.
4.5	-0.58° C.	-4.0° C.	..
5	-0.2° C.	-3.48° C.	..
6	+0.4° C.	-2.55° C.	-8.65° C.
8	+1.4° C.	-0.8° C.	-6.6° C.
10	..	+0.55° C.	-4.95° C.
12	..	+1.55° C.	-3.0° C.
14	..	liquid separated 10° C.	-1.6° C.
16	-0.2° C.
18	+0.6° C.
20	liquid separated 10° C.

SEPARATION TEMPERATURES OF ALCOHOL-HEXANE MIXTURES ON ADDITION OF WATER.

C.c. of Water Added.	100 c.c. of Mixture.		
	50 c.c. Alcohol. 50 c.c. Hexane.	70 c.c. Alcohol. 30 c.c. Hexane.	80 c.c. Alcohol. 20 c.c. Hexane.
0	below -18° C.	below -18° C.	..
2	.. -15° C.
2.5	-4.5° C.
3	+7° C.
3.5	+17.45 C.
4	+28.3 C.
4.5	..	below -15° C.	..
5 -11° C.	below -18° C.
5.5	..	-10.3° C.	..
6	..	-3.4° C.	..
6.5	..	+3.3° C.	..
7	..	+8.2° C.	..
7.5	..	+13.4° C.	below -15° C.
8	..	+18.5° C.	-13.8° C.
8.5	-9.3° C.
9	..	+31.8° C.	-3.0° C.
9.5	+2.1° C.
10	..	+39.3° C.	+6.5° C.
10.5	+10.7° C.
11	+14.0° C.

At room temperature, 15°C ., the 50 per cent. mixture separated into two layers when 10 c.c. of water were added to the mixture, the lighter liquid, rich in benzene, having a volume of about 20 c.c. In other words, benzene added to alcohol containing 20 per cent. of water is only partially soluble at 15°C . When 12 c.c. of water had been added the volume of the lighter liquid separating out was about 60 c.c. The higher the percentage of alcohol in the mixture the more water is required to separate the mixture into two liquid layers.

In the second table are shown the results of similar experiments with alcohol-hexane mixtures. With equal volumes of alcohol and hexane, it required the addition of only 3.5 per cent. of water

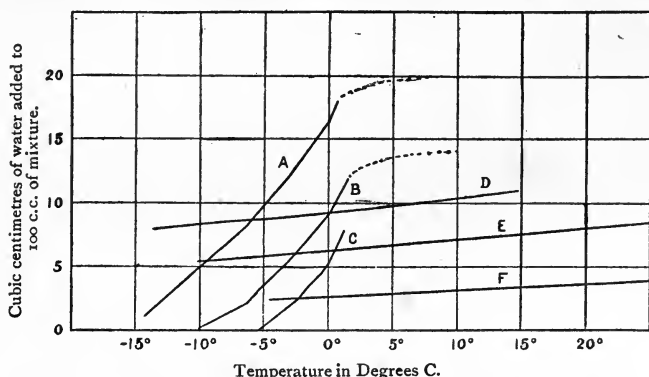

FIG. 35.—Separation Temperatures of Alcohol-benzene and Alcohol-hexane Mixtures on Addition of Water. (H. B. Dixon.)

A = 70 c.c. alcohol, 30 c.c. benzene.	D = 80 c.c. alcohol, 20 c.c. hexane.
B = 60 c.c. " 40 c.c. "	E = 70 c.c. " 30 c.c. "
C = 50 c.c. " 50 c.c. "	F = 50 c.c. " 50 c.c. "

to separate the liquids at 17.4°C ., whereas the same amount of water added to equal volumes of alcohol and benzene required the whole to be cooled below the freezing-point (-1.45°C .) before producing separation.

Dixon's results are shown in the form of curves in Fig. 35. It is evident that, at ordinary temperatures, alcohol-benzene mixtures can take up much more water, without separation occurring, than can alcohol-hexane mixtures. On the other hand, alcohol-benzene mixtures are more affected by low temperatures than are alcohol-hexane mixtures. The best mixture as regards homogeneity under all atmospheric conditions would be one containing both petrol and benzol.

Mixtures of alcohol and water with ether, benzene, hexane, and various other substances have been the subject of several investiga-

tions from the standpoint of the phase rule.²¹ For each temperature a range of mixtures can be found representing the borderline between complete miscibility and separation into two liquids or into solid and liquid. With ether and hexane the "isotherms" thus obtained do not vary greatly for different temperatures, but the solubility of benzene in dilute alcohol is greatly reduced at low temperatures. Pure benzene solidifies at 5.5°C ., and at temperatures below this solid benzene may be present in the mixture,

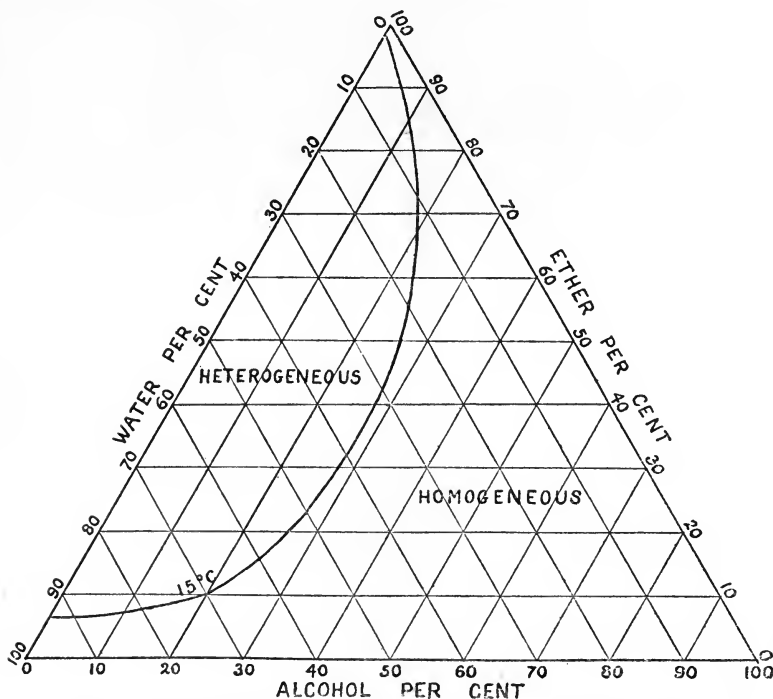

FIG. 36.—Isotherm for Mixtures of Alcohol, Water, and Ether at 15°C .
(Boutin and Sanfourche.)

sometimes in conjunction with two immiscible liquids. Pure benzene, therefore, would not be a suitable fuel for admixture with alcohol, as separation of crystals would be liable to occur in the carburettor and induction pipe of the engine. Commercial benzol does not exhibit this tendency to solidify in the same degree, owing to admixture with toluene and xylene, both of which remain liquid at extremely low temperatures. Watson found that a coke-oven benzol started to crystallise at -4°C . It was pasty at -8°C . and solid at -12°C .

The triangular diagrams in Figs. 36 to 38 show the isotherms for mixtures of alcohol and water with ether, benzene, and hexane respectively at certain temperatures. It is seen that, of the three liquids, ether possesses the highest and hexane the lowest range of miscibility with alcohol of various strengths. It has been pointed out by Sidgwick and Spurrell that 90 per cent. aqueous alcohol will dissolve up to four times its weight of benzene, but only one-third of its weight of hexane.

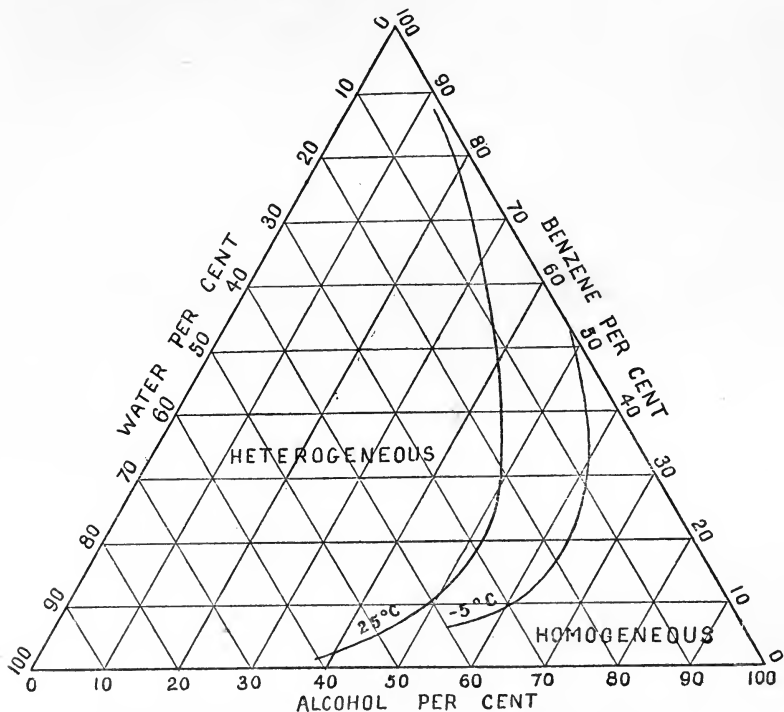

FIG. 37.—Isotherms for Mixtures of Alcohol, Water, and Benzene at 25° C. and -5° C. (Sidgwick and Spurrell.)

The fact that alcohol is not miscible with lubricating oil may possibly account to some extent for the absence of carbon deposit in alcohol engines, since the oil is not carried to those parts of the cylinder where high temperatures are attained. With fuels rich in alcohol this may lead to a considerable saving in lubrication, as the lubrication conditions will approach more nearly to those of a high pressure steam engine.²² Leakage of fuel past the piston rings into the lubrication system will not have the effect of thinning the oil which is sometimes observed with petrol-paraffin mixtures,

and which has been known to lead to seizure of the big-end bearings.

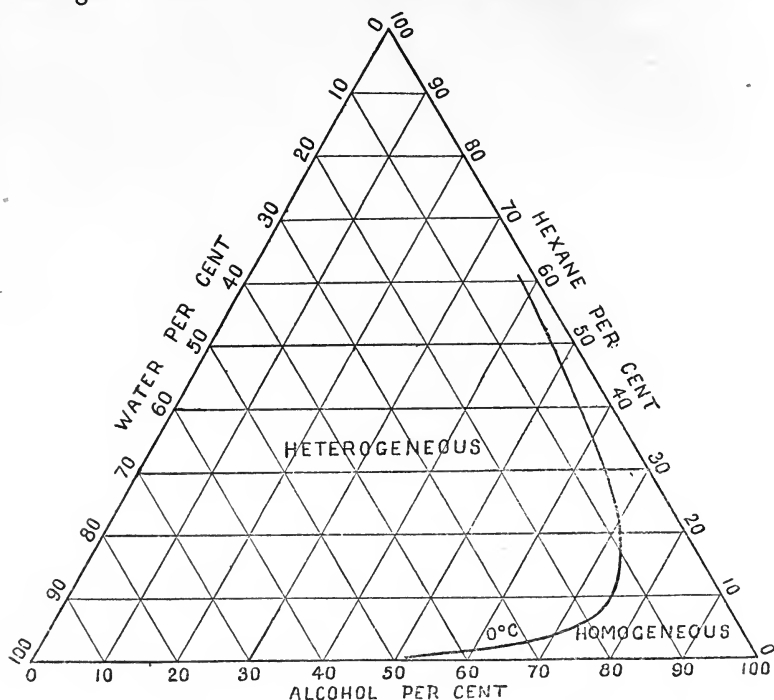

FIG. 38.—Isotherm for Mixtures of Alcohol, Water, and Hexane at 0° C. (Bonner.)

Vapour Tension.—Alcohol possesses a much lower vapour tension at ordinary temperatures than petrol or benzol. The actual values in millimetres of mercury at different temperatures for various fuels are given in the following table :²³

VAPOUR PRESSURES OF LIQUID FUELS IN MILLIMETRES OF MERCURY.

Temp.	Ether.	45% Ether 55% Alcohol.	20% Ether 80% Alcohol.	Alcohol.	20% Hexane 80% Alcohol.	Hexane.	20% Benzene 80% Alcohol.	Benzene.
0°	180	165	73	14	30	44	37	28
10°	280	250	105	22	46	76	56	45
20°	433	380	162	42	80	121	90	75
30°	637	547	247	79	141	184	142	120
40°	350	135	219	276	215	180
50°	500	217	328	400	325	263

Chaloner²⁴ gives a table showing the vapour tension of alcohol at different strengths, from which it appears that the presence of 20 per cent. of water does not greatly affect the vapour tension of alcohol.

VAPOUR TENSION IN MILLIMETRES OF MERCURY.

Temperature. Degrees C.	100 per cent. Alcohol.	90 per cent. Alcohol.	80 per cent. Alcohol.
0°	12	13	..
10°	24	24	..
20°	44	39	..
30°	78	75	73
40°	140	135	133
50°	221	221	221
60°	350	349	348
70°	545	539	529
80°	812	783	760
90°	1186
100°	1692

Moore²⁵ has determined the vapour tension of 98 per cent. alcohol, benzene, and petrol, and of alcohol-benzol and alcohol-

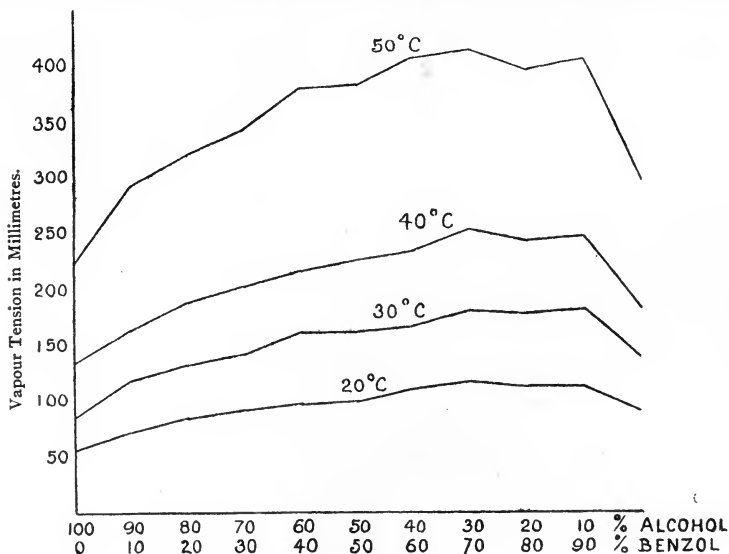

FIG. 39.—Vapour Tension of Alcohol-benzol Mixtures.

(H. Moore, *Journ. Soc. Chem. Ind.*, 1920, 89, 78T.

petrol mixtures at various temperatures (Figs. 39 and 40). From these results it is seen that certain mixtures of benzol or petrol

with alcohol possess a higher vapour tension than either of the two constituents separately.

The results obtained by Watson²⁶ are shown in Fig. 41, which gives the vapour tensions of petrol, benzol, and methylated spirit, and of mixtures of the two latter fuels. Mixtures of benzol with methylated spirit showed considerably higher vapour tension than either benzol or methylated spirit alone.

Meneghini²⁷ found that the loss in weight of various fuels

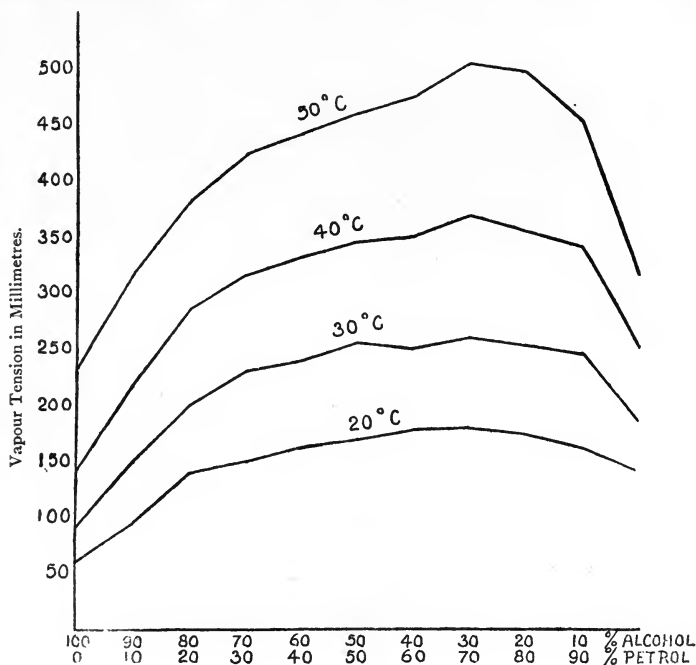

FIG. 40.—Vapour Tension of Alcohol-petrol Mixtures.

(H. Moore, *Journ. Soc. Chem. Ind.*, 1920, 39, 78T.)

contained in a U-tube in a thermostat at 25° C. and subjected to the passage of a current of dry air for five minutes was as follows :

Petrol (specific gravity 0.700)	20.5 per cent.
Benzene	5.1 "
Toluene	1.73 "
Methyl alcohol	3.60 "
Alcohol (95 per cent.)	1.90 "
" (80 per cent.)	1.85 "
90 per cent. benzol	5.35 "
" "	+10	"	"	.	6.25 "
" "	+20	"	"	.	6.30 "
" "	+35	"	"	.	6.40 "
" "	+50	"	"	.	6.15 "

is incombustible. At all temperatures below 20° C. air at atmospheric pressure cannot take up sufficient alcohol vapour to render the mixture combustible. With a fuel consisting of rectified alcohol or methylated spirit it is therefore a difficult matter to start an engine from cold unless special means are employed. This difficulty of starting is not so noticeable when mixtures of alcohol

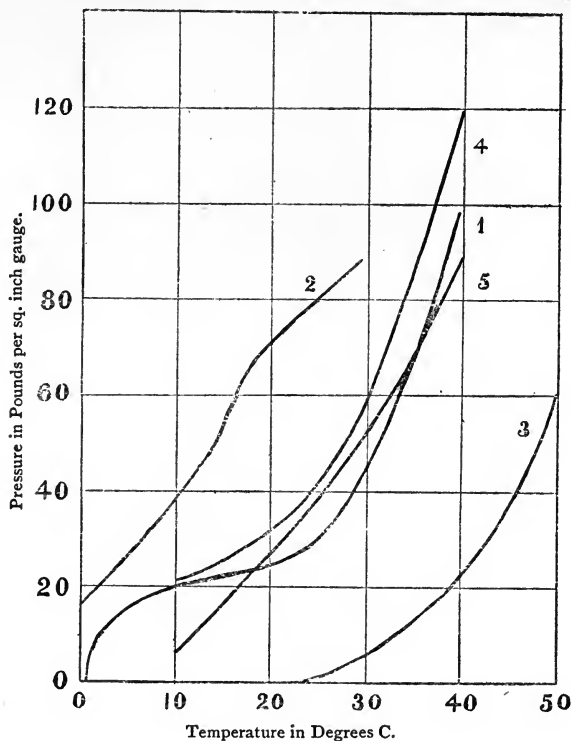

FIG. 42.—Formation of Explosive Mixtures at different Pressures.

(W. Watson, *Proc. Inst. Automobile Engineers*, 1914-15, 9, 73.)

- | | | |
|--|--|-----------------------|
| 1. Benzol. | 2. Petrol. | 3. Methylated spirit. |
| 4. Benzol 3 parts, methylated spirit 1 part. | 5. Benzol 1 part, methylated spirit 3 parts. | |

with more easily volatile substances are used, and with a 50 per cent. alcohol-benzol mixture it has been found that an engine starts up almost as easily as with petrol.

From the figures given above, it might appear at first sight that the difference between the vapour pressures of alcohol and benzol is not sufficiently great to account for the fact that the engine will start easily from cold with the one and not with the other. But it must be remembered that the proportion of vapour

to air required to form an explosive mixture is greater with alcohol than with benzol or petrol.

Of the devices employed for overcoming the starting difficulty when using alcohol alone the more important are :

(i) Heating of the carburettor and induction pipe by means of a spirit lamp or flame.

(ii) Heating the jet of the carburettor locally, either by mechanical or electrical means.

(iii) Injection of a small quantity of fuel into the cylinder through the compression tap. With a normal compression ratio the heat of compression produced on turning the starting handle will be in the neighbourhood of 150° C., which is sufficient to vaporise the fuel and give an explosive mixture.

(iv) Starting the engine on petrol, and gradually changing over to alcohol. This involves the provision of a separate petrol tank and probably two carburettors, as it is difficult to obtain in the same carburettor the extreme range of adjustment necessary for the purpose.

Whatever method be employed for overcoming the difficulty of starting, the air supply and induction pipe must be kept warm while the engine is running, if flexibility under varying loads and quick acceleration are to be secured. Owing to the comparatively high heat of vaporisation of alcohol (220.5 cal. per gram. as against 86.6 cal. for hexane, and 95.5 cal. for benzene), the quantity of heat to be supplied to the carburettor is considerable. The following values are given by Ormandy :²⁸

	Percentage of Heat of Combustion required for Evaporation.	Relative Carburettor Heat required.
Petrol	0.70	1.00
Benzol	1.04	1.60
Ethyl alcohol	3.26	7.57
Methyl alcohol	5.30	16.40
Methylated spirit	4.17	10.67

The relative carburettor heat required is the heat which must be conveyed to the fuel in the carburettor on the assumption that the various fuels are used in quantities inversely proportional to their heat values.

With mixtures of methylated spirit and benzol it has been found

that some engines do not run steadily under load unless the temperature of the jacket surrounding the induction pipe is at least 160° F. (71° C.) (Ormandy).

The effect of heating the induction system on flexibility and quick acceleration is obvious. Sudden opening of the throttle causes a rush of air and fuel to the engine, and unless the preheating is efficient alcohol will condense in the induction pipe and there will be a risk of the mixture falling below the explosion limit. Preheating of the induction pipe may be carried out either by means of the exhaust gases or by the hot water from the radiator. The latter is preferable, as the exhaust heat is difficult to control. In the trials carried out by the London General Omnibus Company with a mixture consisting of 65 per cent. alcohol, 30 per cent. benzol, and 5 per cent. ether it was found that water-jacketed induction pipes gave the best results, whilst exhaust-jacketed pipes were inferior to plain pipes.

A limit is set, however, to the extent to which the induction pipe may be preheated, by the following considerations. If the mixture be made too hot, the compression temperature will be raised, and with some fuel mixtures this is liable to give rise to knocking or "pinking" in the engine unless the compression ratio be lowered. It was found by Ricardo that the limiting compression ratio at which detonation occurred was lowered by 0.1 for every 10° C. rise in temperature from 30° C. to 70° C., the corresponding ratios for hexane being from 5.2 : 1 to 4.8 : 1.

Again, the hotter the mixture the smaller will be the weight of the charge in the cylinder, and the power output of the engine will be less in direct proportion as the density of the charge is reduced by heating. The ideal carburettor would be one which produced perfect atomisation of the fuel with the minimum of preheating.

Alcohol, unless mixed with other fuels of higher vapour tension, has been found, for the above reasons, to be more suited for use in stationary and farm engines, in which ease of starting and flexibility under varying load are of less importance than in engines employed for road transport.

Corrosion.—It has been frequently stated that the products of combustion of alcohol, and especially of methylated spirit, contain acid substances which gradually corrode the cylinder and exhaust valve of the engine.

Sorel²⁹ found that methyl alcohol begins to form aldehydic oxidation products at 160° C. and that ethyl alcohol does so at 300° C., and it is possible that these temperatures may be lowered by the catalytic action of metals, especially copper. Corrosion is reported to have been troublesome at one time in the case of

alcohol motors used for agricultural purposes in Germany, and to have militated against their use in inexperienced hands.

Two distinct types of corrosion may be distinguished: the action of the fuel itself on the metal of tanks, pipes, and carburettor, and the corrosion of the cylinder and exhaust system by acid products of combustion.

With regard to the former, it was found during experiments carried out by the London General Omnibus Company in 1919 to 1920 that denatured alcohol, even when mixed with 50 per cent. of benzol, corroded copper and iron very badly. Brass, zinc, aluminium, and tin were slightly attacked, and it was found necessary to employ lead-coated fuel tanks and pipes. Sheet-iron or steel coated with an alloy of 20 per cent. tin and 80 per cent. lead was found to be resistant to the corrosive action. Brass can be used in the construction of the carburettor, as this metal is only slightly attacked. It would seem that if any corrosion at all was noticed during the comparatively short time occupied by these tests, it might become a serious matter if the effects prove to be cumulative over a long period. Reliable data as to corrosion of the fuel supply system in alcohol engines which have been in commission for several years are difficult to obtain.

The action on metals is apparently due to the presence of wood naphtha. G. Heinzelmann,³⁰ in an investigation on this subject, immersed various metals in 90 per cent. alcohol denatured with wood naphtha, and kept the vessels for two months in the dark and for a further three months in diffused daylight. During this period the contents were shaken at intervals. The 90 per cent. alcohol used contained only 0.0036 per cent. of non-volatile residue.

Lead, zinc, iron, and aluminium were readily attacked, while brass and copper were corroded to a less extent, and tin was not affected. The action of the spirit was roughly proportional to its content of wood naphtha, but differences were observed in the amount of corrosion produced with different samples of wood naphtha. Wood naphtha varies considerably in composition according to the country of origin, more particularly as regards the percentage of esters present. Heinzelmann found that the higher the ester content, the greater the corrosion, the latter being apparently due in great part to the presence of traces of acetic and other organic acids derived from the esters by hydrolysis. Spirit denatured with wood naphtha from which esters had been removed by boiling with alkalis, but which still contained acetone and acetal, did not corrode metals to the same extent. Pyridine and fusel oil had no effect in accelerating the action on metals.

A second factor concerned in the corrosion of metals is the

amount of water present. Spirit of high strength, even when denatured with wood naphtha, does not readily attack metals. In distilleries it is customary to use vessels of sheet-iron for the storage of 95 per cent. alcohol, and the surface of the iron remains bright. Heinzelmann considered that at this strength the small quantity of water present is so firmly bound to the alcohol that no oxidation of the metal can occur. Corrosion by denatured alcohol would thus seem to be due to the combined action of water and esters.

R. P. Duchemin's results³¹ confirm to some extent those of Heinzelmann. He gives the following table as showing the amount of dry residue obtained from one litre of alcohol after being left in contact with various metals for three months :

	Iron.	Tin.	Zinc.	Copper.	Brass.
Ethyl alcohol, 95 per cent.	0·9	1·3	2·2	1·1	1·4
„ „ +50 per cent. water	10·8	2·5	8·3	1·9	2·1
„ „ +10 „ aldehyde	1·5	1·4	3·9	0·8	1·0
„ „ +10 „ ethyl acetate	3·4	1·9	4·7	0·8	0·8
„ „ +10 „ amyl acetate	1·0	1·2	8·4	2·2	3·0
Methyl alcohol, 95 per cent.	1·5	0·3	1·8	0·9	1·1
„ „ +50 per cent. water	13·8	0·9	13·6	0·4	0·5
„ „ +10 „ acetone	1·3	1·2	1·6	2·0	2·0
„ „ +10 „ methyl acetate	0·9	1·5	3·8	0·6	2·0

Exhaust corrosion would seem to be due largely to imperfect combustion. Provided that the mixture be not too rich, it is easier to secure complete combustion with alcohol than with petrol. The exhaust is remarkably clean, and free from any objectionable smell. It is possible that, owing partly to the smaller quantity of air required for combustion, a more perfect admixture of fuel and air is obtained with alcohol than with petrol. But in practice there is always a tendency to use too rich a mixture because of the extra power obtainable. Watson's results, referred to on pp. 238 and 293, showed that a setting of the carburettor for maximum power would cause the combustion to be incomplete, and would result in the escape of products of partial combustion into the exhaust. As long as these products remain uncondensed it is unlikely that corrosion will occur, but a certain amount of condensation is bound to take place when the engine is stopped. Traces of unburnt fuel will also remain in the cylinder after stoppage of the engine, and unless plenty of lubricating oil be present, this may start corrosion.

Various methods have been proposed for preventing or minimising corrosion. The engine may be run for the last few revolutions on petrol, which serves to sweep out all traces of corrosive

products due to the alcohol, but this introduces the inconvenience of two fuel tanks and complicates the carburetted system. The exhaust pipe must drain properly so as to prevent the lodgment of condensed liquid. In one mixture which is extensively used in South Africa ("Natalite"), ammonia is added with the object, apparently, of neutralising the exhaust, but it is doubtful whether it achieves this object.

It would seem that the most obvious methods of preventing corrosion are firstly to use always a full supply of air so as to ensure complete combustion, and secondly to maintain efficient internal lubrication. The choice of a suitable denaturant may do much to reduce the chances of corrosion, as there appears to be little doubt that the trouble is due largely to the ease with which methyl alcohol is oxidised to formaldehyde and formic acid.

Alcohol has been found to be less liable than petrol or benzol to cause carbon deposit on the piston and cylinder head. Nearly every one who has carried out comparative bench or road tests with these fuels has remarked on the cleanness of the piston head and exhaust valves after running on alcohol. It has, however, been observed that the inlet valve pockets and parts of the induction pipe close to the cylinder become covered with a thick tar-like, or according to some observers, gelatinous, deposit. The nature of this deposit is not clear, but it would seem to be due mainly to the non-volatile impurities present in commercial alcohol and to a less extent to the presence of acetaldehyde (cf. p. 300).

Specific Gravity and Viscosity.—For practical purposes fuels are always measured by volume, whereas calorific values are more frequently based on unit weight. A knowledge of the specific gravity is therefore necessary when comparing different fuels in bench and road tests. This is best illustrated by the figures for benzol and petrol :

	Specific Gravity.	B.Th.U. per Pound.	B.Th.U. per Gallon.
Petrol . . .	0.740	18,880	139,700
Benzol . . .	0.872	17,395	151,700

from which it is seen that although benzol has, weight for weight, a lower calorific value than petrol, the higher specific gravity of benzol turns the scale in its favour where the fuels are measured by volume.

The specific gravity of pure alcohol is 0.7936 at 15° C. and of methylated spirit about 0.819 to 0.825. The specific gravities of

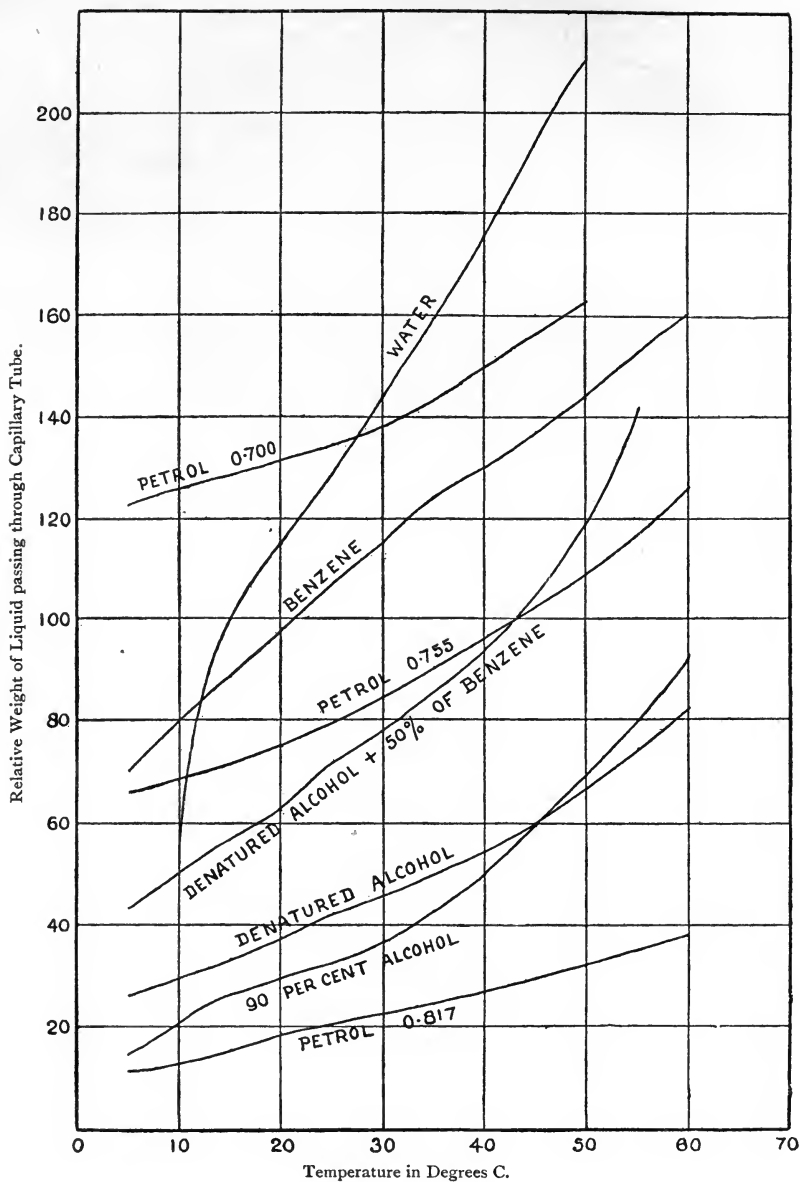

FIG. 43.—Relative "Fluidity" of different Fuels. (Sorel.)

different grades of petrol vary from 0.700 up to 0.750 or more with the heavy grades now used. The value for pure benzene is 0.880 at 15° C. and for toluene approximately the same. Xylene has a gravity of 0.756 at 15° C., so that commercial 90's benzol is about 0.870 to 0.875.

The higher specific gravity of commercial alcohol and of benzol renders it necessary to weight the float of the carburettor when adapting a petrol engine for use with these fuels.

The viscosity of alcohol and alcohol mixtures may be of importance in connection with carburettor design. A mixture of 45 per cent. by volume of ethyl alcohol and water has a viscosity which is almost exactly four times that of water at 0° C. This value is a maximum and decreases as the alcohol becomes stronger or weaker. Sorel³² has given figures showing the relative weights of various liquids passing through a capillary tube in the same time and under a pressure corresponding to 30 mm. of water, the value for distilled water at 15° C. being taken as 100. His results are shown graphically in Fig. 43. It is seen that the temperature coefficient for water is much greater than that of the various fuels examined. The viscosity of alcohol is greater (*i.e.* the "fluidity" is less) at all temperatures than that of benzene and light petrol. The enlargement of the carburettor jet which has been found necessary when changing over from alcohol to petrol is thus a consequence, not only of the larger proportion of fuel required to form the explosive mixture, but also of the higher viscosity of alcohol.

Flash Points of Alcohol and Alcohol Mixtures.—In connection with recommendations made by the Industrial Alcohol Committee of India in 1920,³³ regarding the inclusion of power alcohol within the provisions of the Indian Petroleum Act, 1899, a series of flash point tests was carried out by R. L. Jenks. The following results are given in an appendix to the Report :

Flash points (approximate) of spirit of various strengths from absolute alcohol downwards, of various spirit mixtures, and of certain other liquids, tested in accordance with the directions in the First Schedule of the Indian Petroleum Act, 1899.

(The flash point for dangerous petroleum is below 76° F. [Petroleum Act].)

(a) Absolute alcohol	.	.	.	55.3° F.
(b) Rectified spirit—				
60° over proof	.	.	.	56.3° F.
50° " "	.	.	.	59.3° F.
40° " "	.	.	.	64.3° F.
30° " "	.	.	.	66.0° F.
20° " "	.	.	.	70.0° F.

Rectified spirit (*continued*)—

10° over proof	.	.	.	72·0° F.
Proof spirit	.	.	.	74·0° F.
10° under proof	.	.	.	77·0° F.
20°	„	„	.	79·0° F.
30°	„	„	.	82·0° F.
40°	„	„	.	85·0° F.
50°	„	„	.	91·0° F.
60°	„	„	.	96·0° F.

(c) Mixtures—

(i) Alcohol denatured with 0·5 per cent. pyridine and 0·5 per cent. light caoutchoucine (see p. 206).

60° over proof 56·3° F.

50° „ „ 62·0° F.

(ii) Suggested "power alcohol" (denatured with 1 per cent. pyridine and 0·5 per cent. light caoutchoucine and coloured).

55° over proof 60·6° F.

Mixtures of the last-named grade of alcohol with 15 per cent. of petrol or with 25 per cent. of ether showed flash points below 40° F., which was the lower limit of the standard flash point apparatus.

REFERENCES

- ¹ Cf. T. W. Richards, *Journ. Amer. Chem. Soc.*, 1910, **32**, 268; 1915, **37**, 993; 1917, **39**, 341.
- ² W. Watson and others, *Proc. Inst. Automobile Engineers*, 1914-15, **9**, 73.
- ³ H. Ballantyne, *Proc. Inst. Automobile Engineers*, 1908, **2**, 101.
- ⁴ W. Watson, *loc. cit.*
- ⁵ H. B. Dixon, Imperial Motor Transport Conference, October 1920.
- ⁶ H. R. Ricardo, *Automobile Engineer*, 1921, **11**, numbers for February and succeeding months.
- ⁷ W. R. Ormandy, *Proc. Inst. Automobile Engineers*, 1913-14, **8**, 49.
- ⁸ W. Watson, *Proc. Inst. Automobile Engineers*, 1914-15, **9**, 49.
- ⁹ H. T. Tizard and D. R. Pye, *Automobile Engineer*, 1921, **11**, 55, 98, 134.
- ¹⁰ H. Moore, *Journ. Soc. Chem. Ind.*, 1917, **36**, 109.
- ¹¹ H. Holm, *Zeitsch. für angew. Chemie*, 1913, **26**, 273.
- ¹² H. B. Dixon, Imperial Motor Transport Conference, October 1920.
- ¹³ V. B. Lewes, *Journ. Roy. Soc. Arts*, 1915, 761.
- ¹⁴ H. Brunswig, *Explosives*, London and New York, 1912, p. 73.
- ¹⁵ H. Bunte and P. Eitner, *Journ. Gasbeleucht.*, 1901, **44**, 835.
- ¹⁶ W. M. Thornton, *Phil. Mag.*, 1917, **33**, 190.
- ¹⁷ A. G. White and T. W. Price, *Trans. Chem. Soc.*, 1919, **115**, 1462.
- ¹⁸ R. M. Strong and L. Stone, U.S. Bureau of Mines, Bull. No. 43 (1912).
- ¹⁹ Cmd. 218 (1919).
- ²⁰ H. B. Dixon, Imperial Motor Transport Conference, 1920.
- ²¹ A. Boutin and A. Sanfourche, *Bull. Soc. Chim.*, 1919, **25**, 458. W. D. Bonner, *Journ. of Phys. Chem.*, 1910, **14**, 738. N. V. Sidgwick and W. J. Spurrell, *Trans. Chem. Soc.*, 1920, **117**, 1397.

- ²² Advisory Council of Science and Industry, Australia, Bull. No. 6, "Power Alcohol," Melbourne, 1918.
- ²³ H. B. Dixon, Imperial Motor Transport Conference, October 1920.
- ²⁴ J. L. Chaloner, *Automobile Engineer*, April 1920.
- ²⁵ H. Moore, *Journ. Soc. Chem. Ind.*, 1920, **39**, 781.
- ²⁶ W. Watson, *Proc. Inst. Automobile Engineers*, 1914-15, **19**, 73.
- ²⁷ D. Meneghini, *Annali Chim. Appl.*, 1915, **3**, 235.
- ²⁸ W. R. Ormandy, *Proc. Inst. Automobile Engineers*, 1913-14, **8**, 49.
- ²⁹ E. Sorel, *Carburation et Combustion dans les Moteurs à Alcool*, Paris, 1904.
- ³⁰ G. Heinzelmann, *Zeitsch. für Spiritus Industrie*, 1904, No. 39, 1905, No. 39.
- ³¹ R. P. Duchemin, *Seventh Internat. Congress Appl. Chem.*, London, 1909.
- ³² E. Sorel, *loc. cit.*
- ³³ *Industrial Alcohol Committee Report*, Simla, 1920.

CHAPTER X

RESULTS OF ENGINE TESTS

THE comparisons drawn between alcohol and hydrocarbon fuels in the preceding chapter have been based to a great extent on the results of experiments conducted under approximately ideal conditions. The variable factors which play so great a part in the performance of different engines in everyday use have been as far as possible eliminated with a view to arriving at the essential differences existing between the various fuels. It remains to deal with some of the more important tests carried out on commercial engines, whether designed primarily for alcohol or petrol, and to indicate the conclusions which may be drawn from these tests as to the practical value of alcohol as a motor fuel compared with petrol and benzol.

The first serious attempt to investigate the possibilities of alcohol as a motor fuel appears to have been made in 1894 at Leipzig by Hartmann for the Deutsche Landwirtschaftliche Gesellschaft. The engine used had been built by Grobb of Leipzig, and was designed to work on kerosene. The consumption of kerosene was 425 grams per B.H.P. hour, equivalent to 0.93 pint (taking the specific gravity of kerosene at 0.800). This indicated an overall thermal efficiency for kerosene of 13.6 per cent. When working on alcohol the engine used 839 grams, or nearly twice as much as with kerosene, and the overall thermal efficiency was only 12.2 per cent.

This did not seem a very encouraging result, but the necessity of finding an outlet for the large quantities of industrial alcohol at that time being produced in Germany led to great efforts being made to develop the alcohol engine on more efficient lines. An engine built by Koerting of Hanover, fitted with a new form of vaporiser, was tested a year or so later by Slaby at the Charlottenburg Polytechnic. This engine showed an overall thermal efficiency of 17.5 per cent., or nearly 50 per cent. better than Hartmann's engine. From that time onward the alcohol engine was continually being developed and improved, and interest in the subject was stimulated by a series of international congresses and exhibitions held during the years 1901 to 1904. This development

RESULTS OF ENGINE TESTS

275

MEYER'S RESULTS ON 14 H.P. DEUTZ ENGINE WITH ALCOHOL.

Test No.	Load.	R.p.m.	Compression. Pounds.	B.H.P.	Alcohol per B.H.P. Hour. Pounds.	Overall Thermal Efficiency.	Outlet Temperature of Cooling Water. Degrees F.		
							Cylinder Head.	Cylinder Jacket.	Average of both.
1	Maximum	275.2	107	15.68	0.960	25.3	208.4° F.	172.0° F.	201.2° F.
2	Normal	280.3	100	13.91	1.00	24.3	"	179.5° F.	208.4° F.
3	$\frac{1}{2}$	279.1	..	10.42	1.060	23.1	"	170.5° F.	203.0° F.
4	$\frac{1}{2}$	282.7	53.2	7.05	1.218	20.0	"	176.0° F.	208.4° F.
5	$\frac{1}{2}$	291.4	..	3.64	1.885	13.0	"	172.0° F.	208.4° F.
6	No load	293.5	21 to 15	..	5.85 (lb. per hour)	..	"	201.2° F.	208.4° F.

was largely due to the activities of the German "Central Organisation for the Disposal of Alcohol" already referred to (p. 95), and resulted in the thermal efficiency of the alcohol engine being raised to slightly over 30 per cent.

Since the year 1901 a large number of tests have been carried out, both on commercial denatured alcohol and on mixtures of alcohol with benzol and petrol. It will suffice to deal with a few of the more important of these tests, as the general conclusions to be drawn from all of them are similar.

Meyer's Tests.—In 1901 E. Meyer carried out various tests on a Deutz locomobile alcohol engine, of cylinder diameter 8·28 inches and stroke 11·80 inches, rated at 14 h.p. The compression ratio was 5·91 : 1. Quantity governing was employed, and internal vaporisation—that is to say, the carburettor was not specially heated, the engine being started on petrol. For the first series of tests the fuel contained 87·2 per cent. by weight of alcohol, and had a net calorific value of 10,440 B.Th.U. per lb. The results obtained were as shown on p. 275.

The consumption of cooling water was small, on account of the high outlet temperature employed, and varied from 21·6 to 19·5 lb. per B.H.P. hour. Meyer also carried out tests on alcohol-benzol mixtures with the results shown on the table opposite.

In 1902 further trials of alcohol engines were carried out by Meyer¹ at the instance of the Deutsche Landwirtschaftliche Gesellschaft. A Deutz horizontal engine built with a higher compression ratio, *i.e.* 8·90 instead of 5·91, and with diameter 8·30 inches, stroke 11·8 inches, and piston speed 9·2 feet per second, gave the results shown on p. 278. The fuel used was alcohol of 86·1 per cent. strength by weight. Quantity governing was employed, and the carburettor was not supplied with extra heat.

Meyer's tests illustrate clearly the following points :

(i) At low loads there is a great decrease in power and efficiency, while the consumption goes up. This is due mainly to throttling and consequent reduction of volumetric efficiency.

(ii) As the proportion of benzol in the mixture is raised, the power and efficiency at normal loads increase, and the consumption goes down.

(iii) An increase in the compression ratio from 5·91 to 8·90 raises the thermal efficiency at maximum loads from 25·3 to 31·6 per cent.

In addition to the Deutz engine tests Meyer carried out comparative trials of nine other engines supplied by different makers, and full details of the tests are given in his report. The compression ratios varied from 5·91 to 10·26, and the thermal efficiencies

MEYER'S TESTS ON 14 H.P. DEUTZ ENGINE WITH ALCOHOL-BENZOL MIXTURES.

Fuel.	Commercial Alcohol 86 ⁷ / ₄ per cent. Alcohol { Water 13 ⁶ / ₈ " " by weight. Net Calorific Value, 10,350 B.Th.U. per lb.			Commercial Alcohol 90 ⁸⁸ / ₈ per cent. Benzol . . . 14 ³ / ₈ " " by weight. Net Calorific Value, 11,340 B.Th.U. per lb.			Commercial Alcohol 79 ⁹⁵ / ₈ per cent. Benzol . . . by weight, Net Calorific Value, 11,868 B.Th.U. per lb.								
	1	2	3	7	8	9	4	5	6	10	11	12	13	14	15
Test No. . . .															
Load	Normal	Maximum	$\frac{1}{2}$	Maximum	Normal	$\frac{1}{2}$	Maximum	Normal	$\frac{1}{2}$	Maximum	Normal	$\frac{1}{2}$	$\frac{1}{2}$	$\frac{1}{2}$	Nil.
R.p.m. . . .	273 ³	280	286	277 ⁵	278	286 ⁷	275 ⁸	278 ³	287 ²	279 ¹	280 ²	286	287 ⁸	291 ⁷	297 ³
B.H.P. . . .	13 ⁶⁰	15 ⁹²	7 ²⁰	15 ⁷⁸	13 ⁸⁷	7 ²¹	15 ⁶⁸	13 ⁹⁰	7 ²⁴	15 ⁸⁵	14 ⁰⁰	10 ⁷²	7 ²⁴	3 ⁷²	..
Pounds fuel per B.H.P. hour	1 ⁰³³	0 ⁹⁹³	1 ¹⁷⁵	0 ⁹⁴²	0 ⁹⁶⁸	1 ¹¹⁶	0 ⁸⁶⁵	0 ⁹¹⁸	1 ¹¹²	0 ⁸³⁷	0 ⁸⁵⁹	0 ⁸⁸⁷	1 ¹¹⁷	1 ¹⁴⁷	3 ⁸² (lb. per hr.)
Overall Ther- mal Efficiency per cent. . .	23 ⁸	24 ⁷	20 ⁸	24 ⁵	23 ⁸	19 ⁸	25 ⁸⁵	24 ³	20 ⁰	25 ⁷	25 ⁰	24 ³	20 ¹	14 ⁷	..

POWER ALCOHOL

MEYER'S TESTS ON 12 H.P. DEUTZ ENGINE WITH HIGH COMPRESSION.

Load.	R.p.m.	B.H.P.	Consumption per B.H.P. Hour.			Overall Thermal Efficiency.	Volumetric or "Charge" Efficiency.	Maximum Suction Pressure. Pounds per Square Inch.	Compression Pressure. Pounds per Square Inch.	Explosion Pressure. Pounds per Square Inch.	Exhaust Temperature. Degrees F.
			Pounds of Fuel.	Pounds of Cylinder Oil.	Pounds of Jacket Water.						
Maximum	276.9	16.55	0.813	0.0057	1.69	31.6	93	-2.40	193.0	468.0	>900° F.
Normal	284.1	11.93	0.867	..	2.10	29.6	71	-5.23	136.0	270.0	892° F.
Half	292.5	6.18	1.115	..	2.60	22.7	42	-9.08	76.5	178.0	892°-897° F.
No load	298.2	..	4.63 (lb. per hour)	0.0136	19	-11.50	36.8	113.5	585°-625° F.

from 18.8 per cent. to 29.6 per cent. Comparative tests of these engines, which were all of the slow-speed stationary type, were made with alcohol alone and with a mixture of alcohol 85 parts and benzol 15 parts. The alcohol used was denatured spirit of about 86 per cent. alcohol by weight (=approximately 90 per cent. by volume of the German "Zentralen Spiritus"). The results at normal load are given on p. 280. They show how wide may be the variations in thermal efficiency with engines of different design, even when the compression ratios are approximately the same.

Lucke and Woodward's Tests.—In some experiments carried out by the Office of Experiment Stations, U.S. Department of Agriculture, in 1906,² it was found that a small engine consumed 1.23 lb. of denatured alcohol per B.H.P. hour as against 0.69 lb. of petrol under the same conditions, quantities which are approximately in the same ratio as the respective calorific values. These figures represented the consumption when every care was taken to secure the best adjustment of the engine for each fuel, the compression remaining the same in both cases. By improper adjustments, it was possible to burn more than twice the amount of alcohol stated, and still have the engine working in an apparently satisfactory way. This corresponds with the results obtained by Strong (p. 281), and also with German experience, and it appears to be a more difficult matter to secure the best adjustment and minimum fuel consumption with alcohol than with petrol.

In this Bulletin are recorded the results of an inquiry by Strecker among 120 farmers in Germany who were using alcohol engines. It was found that the fuel consumption per B.H.P. hour varied from 1.97 pints to 0.77 pint, and averaged 1.02 pints. Nineteen per cent. of these farmers were using German denatured alcohol and 81 per cent. were using a mixture containing 20 per cent. of benzol. Presumably the engines were designed with the requisite high compression ratio for alcohol. In almost all cases, petrol was used for starting. An interesting point brought out in this inquiry was that the alcohol engine was capable of operating in all kinds of weather, in some cases with the temperature at 15° F. below freezing-point, although at low temperatures a little more time was required for starting.

Strong and Stone's Experiments.—In 1907 and 1908 an extensive series of comparative tests with petrol and denatured alcohol was carried out by the U.S. Geological Survey and reported on by R. M. Strong.³ A further report on the same series of tests was published by R. M. Strong and L. Stone in 1912.⁴

These tests, which numbered about 2000, were conducted on five stationary engines. Two of the engines were single-cylinder

COMPARATIVE TESTS ON ENGINES OF DIFFERENT MAKES (MEYER).

Engine.	Deutz. 12 H.P.	Dürr. 16-20 H.P.	Körting. 6 H.P.	Marienfelde.		Dresden.		Oberursel. 10 H.P.	Swiderski. 15 H.P.	Ulrich and Hinrichs. 15 H.P.
				14 H.P.	6 H.P.	8-11 H.P.	6-8 H.P.			
Compression ratio . . .	8.9	6.68	8.12	10.26	9.40	6.26	6.28	7.39	5.19	7.91
(i) <i>Alcohol alone</i> — Consumption in grams per metric B.H.P.*hour*	389.1	411.8	552.5	396.9	455.7	532.0	525.3	556.2	611.8	419.0
Thermal efficiency . . .	29.6	28.0	20.9	29.0	25.3	21.7	21.9	20.7	18.8	27.5
(ii) <i>Alcohol 85</i> <i>Benzol 15</i> } Consumption in grams per metric B.H.P. hour	357.9	..	441.6	353.2	410.3	459.2	443.8	475.2	530.8	380.6
Thermal efficiency . . .	29.0	..	23.5	29.4	25.2	22.5	23.3	21.8	19.5	27.2

* 1 metric horse-power = 0.986 English horse-power.

horizontal Otto petrol engines rated at 15 B.H.P. at 260 r.p.m., and measuring $6\frac{3}{4}$ inches diameter by $15\frac{1}{2}$ inches stroke. Two others were single-cylinder vertical four-cycle Nash engines, rated at 10 B.H.P. at 280 r.p.m. and measuring $7\frac{1}{2}$ inches diameter by 10 inches stroke, one of them being built for petrol and the other for alcohol with a higher compression. The fifth engine was an Otto alcohol engine of the same dimensions as the Otto petrol engines, but with higher compression, which could further be increased by inserting liners between the crank-pin end of the connecting-rod and the crank brasses. The engines were automatically governed either by throttle or on the hit-and-miss system.

The minimum fuel consumption for varying loads and operating conditions had to be determined by repeated trials, since it was found to be difficult to ascertain, from the appearance and smell of the exhaust, whether the mixture was correct and the combustion complete. The ratio of air used in the mixture to that theoretically required varied from 1.4 to 0.5 with petrol as fuel, and from 1.3 to 0.7 with alcohol. Within these limits the engines ran quite normally. The lowest fuel consumption per B.H.P. hour was obtained in the case of each fuel when the air used was 1.25 times the theoretical quantity. In the words of the report: "So wide is the range of adaptibility of alcohol and gasoline to the operating conditions governing or limiting the performance and fuel consumption of internal combustion engines, that for engines operating under different conditions the ratio of the rates of consumption of the two fuels per unit of power may be almost anything, even the reverse of their heating values; that is, even though the two engines are in good running condition and operating perfectly to all outward appearances, are of the same size, with compression regulated to that best for their respective fuels, and carry the same percentage of maximum load, the operating conditions may be made such that the engine run with gasoline will use twice as much fuel in pounds per B.H.P. per hour as the alcohol engine. Such a ratio is quite likely to be obtained in practice from off-hand comparison of the performance of two engines, but obviously such a comparison would be meaningless."

It was found by Strong that for 10 to 15 h.p. four-cycle stationary engines of the usual type the maximum compression pressures that could be used for petrol and alcohol without causing pre-ignition were 70 lb. and 180 lb. respectively (gauge pressures). It was possible to run an alcohol engine at 200 lb. compression, and a petrol engine at 90 lb., but in both cases it was difficult to prevent pre-ignition unless very weak mixtures were used. The compression was raised by putting liners between the crank-pin end of the

connecting-rod and the crank brasses. The attachment of plates to the piston or cylinder head was not found to be satisfactory. In certain engines the construction of the cylinder-head does not admit of the compression being raised, so that in such engines full economy with alcohol cannot be realised. Further, with a compression pressure of 180 to 200 lb. per square inch the explosion pressure is 600 to 700 lb., and the ordinary horizontal stationary engine is not usually built sufficiently heavy to withstand such pressures continuously.

Where the compression pressures were the same (70 lb. per square inch) it was found that alcohol gave 10 per cent. more power than petrol under the same conditions, whereas if the compression pressure of the alcohol engine were raised to 180 lb. the maximum available horse-power was 30 per cent. greater than for petrol at 70 lb. compression. The thermal efficiency was found to vary with the compression according to the formulæ (cf. p. 226)

$$E = 1 - \left(\frac{14.7}{P} \right)^{0.17} \text{ for petrol}$$

$$\text{and } E = 1 - \left(\frac{14.7}{P} \right)^{0.19} \text{ for alcohol,}$$

where E = thermal efficiency based on I.H.P. and net calorific value, and P = indicated compression pressure in pounds per square inch absolute. These equations were fulfilled only when the engines were operated under the best conditions and with a minimum amount of throttling.

For compression pressures of 70 lb. and 180 lb. gauge for petrol and alcohol respectively, the above equations become

$$E = 1 - \left(\frac{14.7}{70 + 14.7} \right)^{0.17} = 0.257 \text{ for petrol}$$

$$\text{and } E = 1 - \left(\frac{14.7}{180 + 14.7} \right)^{0.19} = 0.388 \text{ for alcohol,}^5$$

or approximately 26 per cent. for petrol and 39 per cent. for alcohol.

As regards fuel consumption per B.H.P. it was found that with low compression (70 lb.) the consumption of alcohol was in general 50 per cent. greater than that of petrol with the same compression. If, however, the compression were raised to 180 lb. for alcohol, the consumption of fuel per B.H.P. became approximately the same as that of petrol (about 0.8 pint per B.H.P. per hour). The actual

⁵ This corresponds to a thermal efficiency of $1 - \left(\frac{1}{r} \right)^{0.235}$ and may be compared with the theoretical thermal efficiencies for different mixture strengths given by Tizard and Pye (cf. p. 227).

figures for fuel consumption and thermal efficiency, averaged over a large number of tests, and representing the best economy values obtained when degree of compression, load, quality of the explosive mixture, and times of ignition were carefully adjusted, were as follows :

Fuel.	Compression Pressure in Pounds per Square Inch Gauge.	Fuel Consumption per B.H.P. per Hour.		Thermal Efficiency per cent.*
		Pounds.	U.S. Gallons.	
Petrol . . .	70	0.60	0.100	26
„ . . .	90	0.58	0.097	28
Alcohol . . .	70	0.96	0.140	28
„ . . .	180	0.71	0.104	39
„ . . .	200	0.68	0.099	40

* Based on I.H.P. and net calorific value.

Strong found that the amount of fuel consumed per B.H.P. hour varied greatly with the load. The rated, or optimum load, of the engines tested was about 80 per cent. of the maximum load. The fuel consumption was least at the rated load and increased by about 10 per cent. when the load was increased to maximum. At light load, about one-third of maximum load, the consumption was approximately 50 per cent. greater than that for optimum load.

When mixtures of petrol and alcohol were used in varying proportions by means of a double carburettor, the optimum compression pressure was found to increase directly with the percentage of alcohol present. Tests made with the compression adjusted to the optimum for each mixture indicated that the total fuel consumption for any given load was practically constant with all mixtures of the two fuels.

Several additional points of interest were brought out in this series of tests. The size of the engine has a certain influence on the fuel economy and the thermal efficiency. This is due to several factors. The relative cooling surface is less in a large engine than in a small one, and the thermal losses are therefore smaller. Still more important are the mechanical factors, such as leakage and friction, which are relatively greater in a small engine. It is harder to maintain compression with a small engine than with a large one, and this difficulty increases with the degree of compression.

Experiments on the effect of varying the jacket temperature

did not lead to conclusive results. The opinion is expressed that if the design and construction of the engine and carburettor are correct and if suitable cylinder oil is used, it is not necessary to raise the temperature of the cooling water when using alcohol. On the other hand, under certain conditions of governing and with certain forms of carburettor, a high jacket temperature is of advantage. Similarly it is maintained that preheating of the air is not necessary in order to obtain the best results with alcohol, although it may be of value when the carburation is ineffective or the mixture not uniform in quality. If carried to any great degree the power will be materially reduced owing to lowering of the compression pressure. Thus when the air was preheated to 120°C . the maximum power output of the engine was reduced by about 15 per cent. for alcohol and 14 per cent. for petrol, the fuel consumption per B.H.P. hour being increased by about 0.05 lb. for both fuels. With an air temperature of 22°C ., the temperature of the alcohol-air mixture at the inlet valve was found to be 16°C . Preheating of the air to 120°C . increased the mixture temperature only to 35°C . In the engine used for these tests the induction pipe was short, and the mixture temperatures given are those of the air mixed with atomised and partially vaporised fuel as it passed into the cylinder.

Strong's conclusions as to the influence of jacket temperature and heat input to the carburettor agree in the main with the results obtained by Ricardo. Ricardo found that differences in jacket temperature did not influence the indicated thermal efficiency to any marked degree, but that so far as the brake thermal efficiency is concerned, any increase in temperature of the cylinder walls results in a decrease in piston friction due to the lower viscosity of the lubricating oil, and therefore in higher mechanical efficiency.

The only essential alteration which must be made in a petrol engine to render it capable of being used with alcohol, assuming that fuel economy is disregarded, is the enlargement of the jet and fuel supply passages. As the consumption ratio of alcohol (by volume) was 1.45 times that of petrol at equal compression, the jet had to be enlarged in this ratio.

The tests afforded indications that for the same compression the rate of flame with alcohol is slower than with petrol, but that when the optimum compression pressure for each fuel is used, the rates of flame propagation are practically the same. The difference in rate of flame affects the time of ignition. At equal compressions the ignition must be timed to take place earlier for alcohol than for petrol. Moreover, the limits within which the

spark may be advanced or retarded without affecting fuel consumption are wider with alcohol than with petrol. Thus with petrol, carrying a load of 85 per cent. of the maximum, the consumption was 0.66 lb. per B.H.P. hour for an ignition timing of 13° crank angle before dead centre. A timing of 21° before dead centre increased the fuel consumption by 9 per cent., while the increase in consumption for a timing of 15° after dead centre was 36 per cent. With alcohol, carrying a load of 79 per cent. of the maximum, the consumption was 1.1 lb. per B.H.P. hour for a timing of 25° before dead centre. For 30° before, and 5° after, dead centre the consumption rate was increased by 4 per cent. and $6\frac{1}{2}$ per cent. respectively. The compression pressure was the same in both sets of experiments.

Strong also studied the effect of water on the fuel consumption per B.H.P. hour and on the thermal efficiency. At a constant compression pressure, the presence of water causes an increase in the amount of pure alcohol required for a given load and a decrease in the maximum available horse-power. The rates of increase and decrease are, however, small for all proportions of water up to 20 per cent., and the use of 80 per cent. alcohol instead of 90 per cent. has but little effect on the performance of the engine, except that the total fuel consumption is of course greater in proportion to the amount of water present. If alcohol at 80 per cent. strength could be sold at 15 per cent. lower cost than 90 per cent. strength, it would be more economical to use the 80 per cent. spirit, provided that the saving in cost were not offset by the expense of handling the greater bulk.

With alcohol at 70 per cent. strength, the engine becomes more difficult to start and less flexible under varying loads, while with 50 per cent. alcohol there is a considerable falling off in B.H.P. and thermal efficiency, the maximum available B.H.P. being only 72 per cent. of that obtainable with 94 per cent. alcohol.

Less cooling water is required for alcohol than for petrol engines, and the quantity required becomes still smaller when the alcohol is diluted with water. The effect is similar to that produced when a water spray is injected into the cylinder of a petrol engine. With 50 per cent. alcohol, scarcely any cooling water is required.

The maximum compression pressure which can be used without causing pre-ignition is raised by the presence of water in the fuel, and it is therefore possible that a slightly greater thermal efficiency might be obtained by using a diluted alcohol, provided that the compression were correspondingly increased.

It was found that incomplete combustion of the fuel, or the use of a lubricating oil of too low a flash point, did not give the smoky

exhaust which is so noticeable with petrol, and that the exhaust from alcohol was clear and free from odour.

It is rather remarkable that corrosion is not referred to at all in this report, nor is there any mention of the tarry deposit which has been noticed by other observers to be found in the inlet valve pockets and induction pipe. It must be borne in mind, however, that these experiments, although most exhaustive, were carried out on slow-speed stationary engines, and that operating conditions and details of engine construction may have been very different to those obtaining with engines designed for road transport,

French War Office Road Trials.—The French War Office carried out road tests in 1909 and 1910 with different fuels on lorries owned or subsidised by them. Petrol, benzol, and “carburetted” alcohol were used, the latter being apparently a mixture of 50 per cent. alcohol, 35 per cent. benzol, and 15 per cent. petrol.

A. E. Davidson has given⁶ tabulated results of these trials, in which engine dimensions, load, gross weight, speed, and ton-miles per gallon are recorded. The 1909 results appear to have been inconclusive, as the speed was not regulated and the trials degenerated into a race. The following year the speed was more strictly controlled, and averaged from 7·5 to 10·5 m.p.h. It was found that benzol gave the best result for ton-miles per gallon, and carburetted alcohol the worst. The table at top of next page shows in an abridged form the results of the 1910 trials and the average consumption figures for the three fuels.

Ormandy's Tests.—Ormandy⁷ in 1913 published the results of bench tests on a 17 h.p. four-cylinder Maudslay engine of 90 mm. bore and 130 mm. stroke, with compression ratio averaging 4·1 : 1 for the four cylinders. The valves were situated in the top of the cylinders, so that valve pockets were avoided. The carburettor used was a standard “White and Poppe.” The induction pipe above the carburettor was provided with a jacket through which circulated hot water from the cooling system, the temperature being regulated by a valve. Temperature measurements were taken of the cooling water at the inlet and outlet of the cylinder jacket and also in the jacket of the induction pipe.

Tests were carried out with the following fuels :

- (i) Petrol, sp. gr. 0·710.
- (ii) Benzol 50's/90's, sp. gr. 0·875.
- (iii) Benzol 90's, sp. gr. 0·885.
- (iv) 50 per cent. of benzol + 50 per cent. of methylated spirit.
- (v) 33 per cent. of benzol + 66 per cent. of methylated spirit.
- (vi) 25 per cent. of benzol + 75 per cent. of methylated spirit (sp. gr. of mixture 0·830).

FRENCH COMMERCIAL VEHICLE TRIALS, 1910.

Name of Vehicle.	Gross Ton-Miles per Gallon.		
	Petrol.	Carburetted Alcohol.	Benzol.
Malicet and Blin	43·6	37·2	49·7
De " Dion " Bouton	51·1	37·2	47·6
" " " "	67·7	54·6	69·4
" " " "	60·4	54·0	65·8
Avant Train Latil	39·8	36·2	45·4
" " " "	44·4	38·7	49·3
" " " "	34·0	39·6	43·4
" " " "	37·4	43·7	43·5
Peugeot	60·4	49·4	61·7
" " " "	63·5	49·4	65·4
" " " "	60·2	48·4	62·1
" " " "	60·4	50·5	65·9
Delahaye	68·0	61·3	76·0
" " " "	62·5	61·6	73·1
" " " "	54·7	44·5	53·2
" " " "	50·2	40·1	51·7
Panhard and Levassor	61·8	50·0	60·6
" " " "	61·2	49·0	62·3
" " " "	60·4	53·1	58·3
" " " "	62·2	48·6	61·0
Berliet	42·9	37·3	50·0
" " " "	42·4	40·8	55·3
" " " "	44·4	37·8	48·3
" " " "	43·5	41·7	46·8
Vinot and Deguingand	55·0	52·8	62·0
" " " "	53·2	48·0	58·9
Average	53·2	46·3	57·1

The quantity of air supplied to the carburettor was not measured, nor were analyses of the exhaust gas undertaken. The richness of the mixture was regulated so as to give maximum power, with an exhaust odourless and free from smoke or cloud. The results obtained for overall thermal efficiency, fuel consumption, and B.H.P. are shown in Figs. 44 to 46. At 1000 r.p.m. the consumption of fuel and the B.H.P. developed were as follows, taking petrol as 100 in each case :

	Relative Consumption (by Volume).	Relative Power Developed.
Petrol	100	100
Benzol	84·5	98·75
Benzol 1, Methylated spirit 1	96·3	99
" 1, " " 2	108·9	92
" 1, " " 3	124·5	91·5

It is seen from the figures that up to about 1100 r.p.m. the B.H.P. thermal efficiency and consumption of the different fuels run fairly parallel. Above 1100 r.p.m. the B.H.P. falls off and the consump-

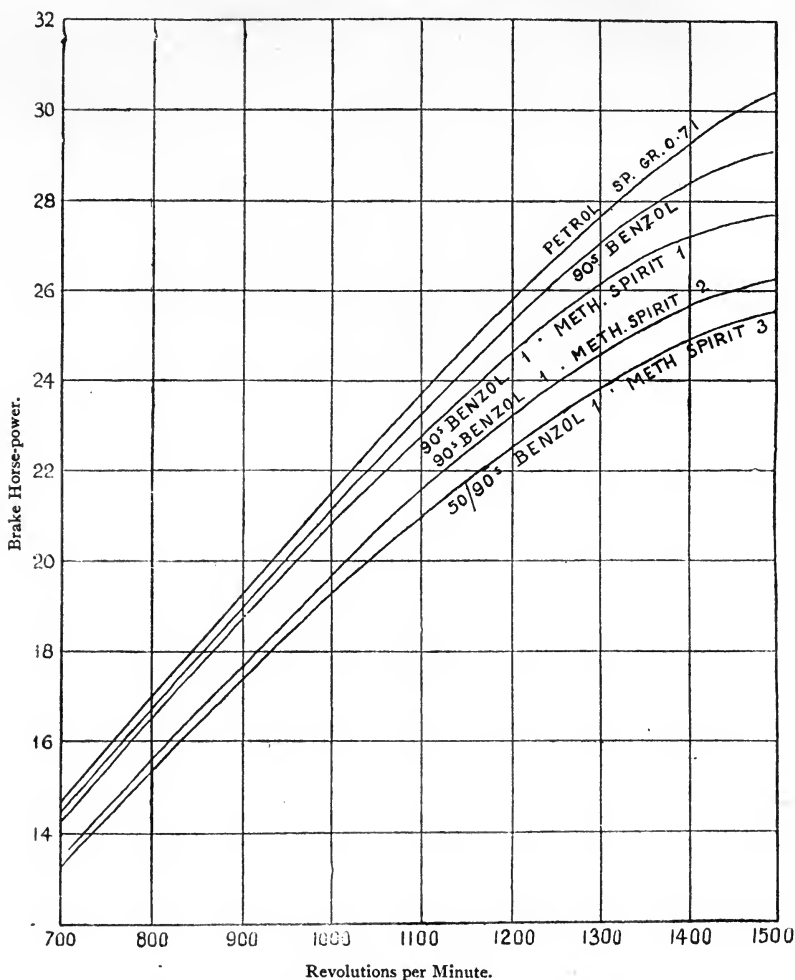

FIG. 44.—Power developed at Different Engine Speeds.

(W. R. Ormandy, *Proc. Inst. Automobile Engineers*, 1913-14, 8, 49.)

tion goes up more rapidly with alcohol mixtures than with petrol. Ormandy considered this to be due to two factors, slower rate of flame and lower volumetric efficiency. The slower rate of flame in alcohol prevents the combustion from being completed at high

speeds before the exhaust valve opens,⁸ and the greater degree of throttling necessary with alcohol at high speeds impairs the volumetric efficiency, thereby lowering the compression pressure.

The 1 : 1 benzol-alcohol mixture appears from Fig. 45 to give a higher thermal efficiency than any of the other fuels tested, but the sudden drop in efficiency at speeds higher than 1100 r.p.m. is pro-

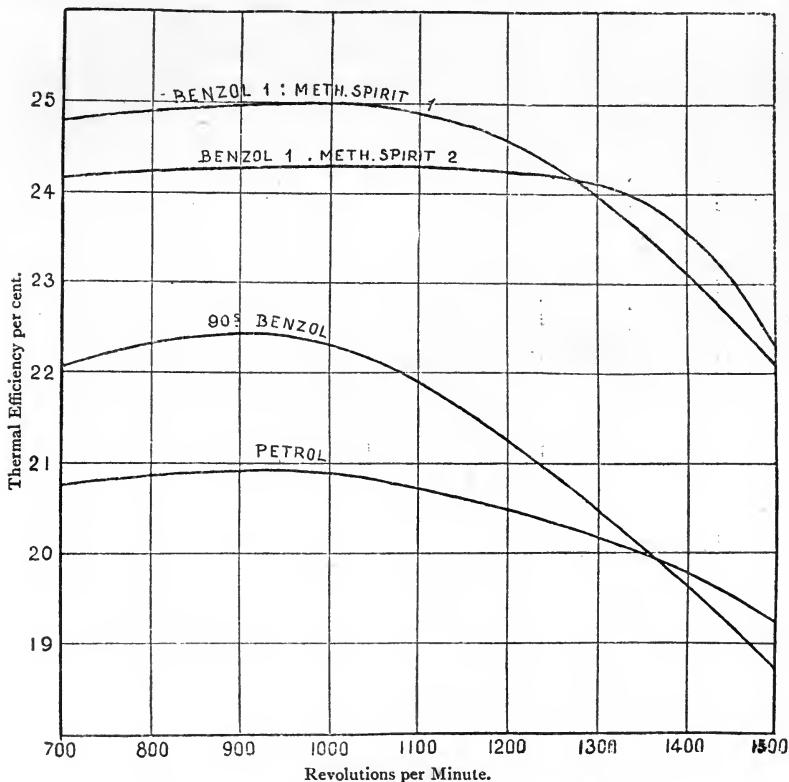

FIG. 45.—Thermal Efficiency at Different Engine Speeds.

(W. R. Ormandy, *Proc. Inst. Automobile Engineers*, 1913-14, 8, 49.)

nounced. Ormandy suggests that up to 1100 r.p.m. in spite of low compression, reduced still further by low volumetric efficiency, the rate of propagation of the explosion was sufficient to enable, if not the full, still a sufficient power to be exerted conjointly with a comparatively high degree of thermal efficiency.

Further experiments were carried out by the same investigator on

⁸ Ricardo, on the other hand, found that in the variable compression engine employed by him, none of the fuels tested possessed rates of burning too low to permit of maximum efficiency being obtained at the highest speeds.

a Sunbeam engine with the same compression as the Maudslay engine (approximately 4 : 1), but with cylinder dimensions 80 mm. \times 150 mm., *i.e.* slightly larger capacity than the Maudslay. The Sunbeam engine possessed larger valve openings and valve lifts and was therefore capable of being run at a higher speed (2000 r.p.m.) without undue loss of volumetric efficiency. A Claudel-Hobson carburettor was used with enlarged jet and with the air inlet adjusted for alcohol. With the 1 : 1 benzol-alcohol mixture slightly higher power than with petrol could be obtained at all speeds up to 2000 r.p.m. As the volumetric efficiency factor was largely eliminated by the increased size of the valves, these results indicated

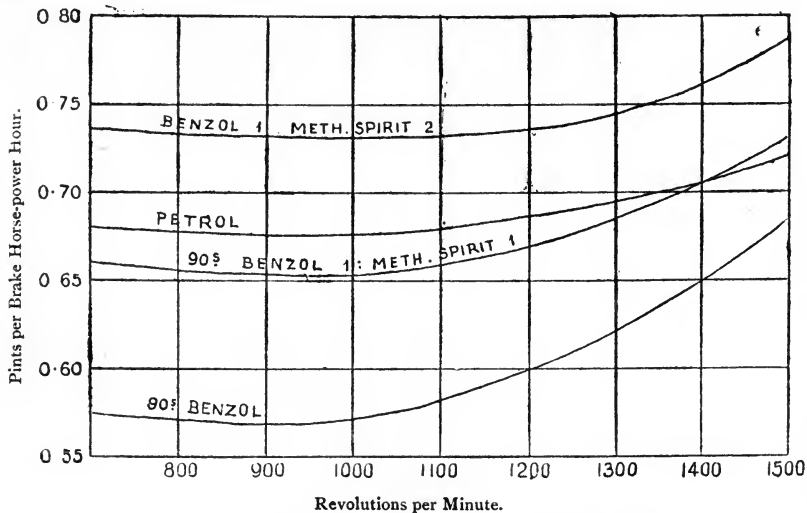

FIG. 46.—Fuel Consumption at Different Engine Speeds.

(W. R. Ormandy, *Proc. Inst. Automobile Engineers*, 1913-14, 8, 49.)

that the rate of explosion of the alcohol-benzol mixture was sufficiently rapid for all practical purposes in an engine of this type. The results were as shown in table at top of next page.

A consumption test on 1 : 1 benzol-alcohol gave :

Jet No.	Pounds Pull at 1400 r.p.m.	Time in consuming 1 lb. Fuel.
135	109	2' 46"
140	114	2' 45"

Thermal efficiency

= 22.6 per cent. (calculated from consumption and B.H.P.).

Volumetric efficiency (percentage charge)

= 72 per cent. (calculated from consumption and r.p.m.).

	Jet No.	Pounds Pull on Brake at—			Remarks.
		1000 r.p.m.	1400 r.p.m.	2000 r.p.m.	
Petrol	125	..	119·6	93	
1 : 1 Alcohol-benzol	125	..	92·5	..	Jet too small.
" "	135	..	123·0	78	Jet too small for high speed.
" "	140	..	125·0	91	
" "	145	..	122·0	94	Better at high speeds, worse at low speeds.
2 : 1 Alcohol-benzol	135	..	106·0	65	Jet too small.
" "	145	119	110·0	75	Inlet very cold.
" "	145		110·5	78	Inlet warmed.
" "	150		123	120·0	90

As a result of his experiments Ormandy concluded that

(i) Fifty per cent. benzol-alcohol gives quite as good results as petrol in respect of power, flexibility, ease of starting, silence, and economy. Only slight alterations of the carburettor are needed.

(ii) The efficiency of the modern high-speed engine when running on alcohol is influenced by compression to a high degree. This points to the necessity of further scientific investigation on carburation with a view to securing more complete gasification of the fuel and the provision of an adequate air supply with a minimum amount of throttling.

(iii) The growing tendency towards increasing the speed of engines has served to emphasise defects in carburation. These defects are accentuated if alcohol is a constituent of the fuel.

The experiments outlined above are open to the objection that the strength of the air-fuel mixture had not been ascertained by measurement of the air or by analysis of the exhaust gas, but had been judged by the running of the engine and the appearance and smell of the exhaust. Watson stated that the thermal efficiency of a good engine could be changed from 17 to 28 per cent. without either smoke or smell appearing in the exhaust, and the same thing was found by Strong in the extensive series of experiments to which reference has already been made. Watson, in tests carried out a little later in which the mixture strength was accurately measured, found that the thermal efficiencies for petrol, benzol, and alcohol were very nearly equal, and this was subsequently confirmed by Ricardo. Ormandy's results must be taken as indicating, not absolute thermal efficiencies, but the relative efficiencies of engines running under good practical working conditions.

Watson's Tests.—Watson's tests, referred to above, were

carried out on a single-cylinder Knight sleeve-valve engine of dimensions 101.6 mm. diameter by 130 mm. stroke.⁹ The fuels compared were petrol, coke-oven benzol, and methylated spirit, and

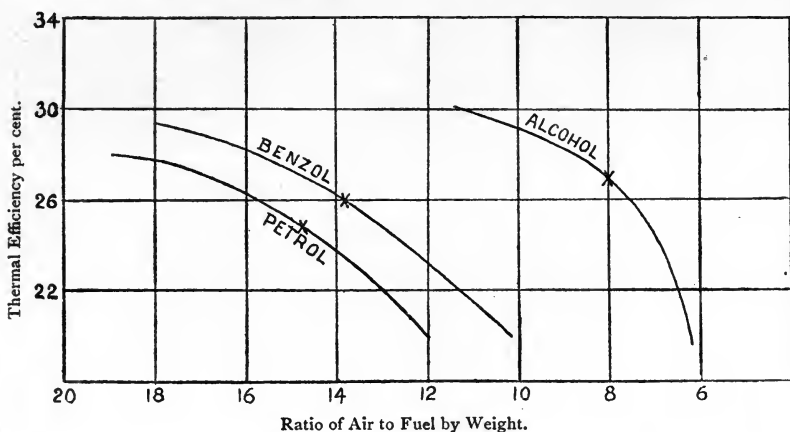

FIG. 47.—Thermal Efficiency. Knight Single-cylinder Sleeve-valve Engine.

(W. Watson, *Proc. Inst. Automobile Engineers*, 1914-15, 9, 73.)

X = Thermal efficiency at theoretically complete combustion mixture.

the compression ratio was the same for all the fuels. The amount of air entering the carburettor was carefully measured and analyses were made of the exhaust gas. A Daimler two-jet carburettor was

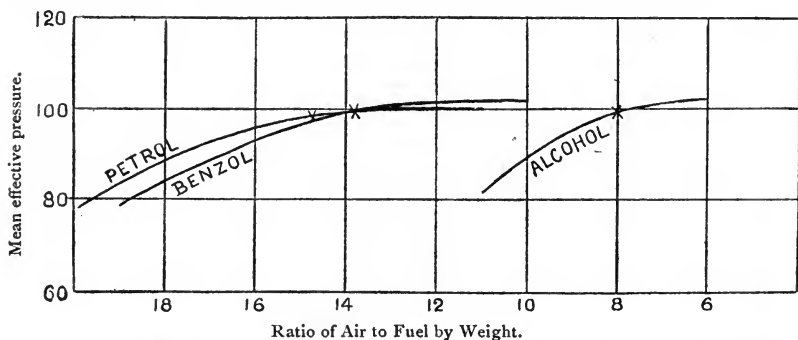

FIG. 48.—Mean Effective Pressure. Knight Single-cylinder Sleeve-valve Engine.

(W. Watson, *Proc. Inst. Automobile Engineers*, 1914-15, 9, 73.)

X = M.E.P. at theoretically complete combustion mixture.

used with a larger jet for alcohol than for petrol and benzol. It was found necessary to supply extra heat to the jet, which was done by passing an electric current through a wire wound round the pipe

leading from the jet chamber to the throttle. Even with this arrangement, it was found that the heat was insufficient to ensure regular vaporisation of the alcohol, and the exhaust gas analyses were therefore not quite so uniform with this fuel as with petrol and benzol.

The results obtained for thermal efficiency and mean effective pressure are shown in Figs. 47 and 48. The maximum M.E.P. attained was practically the same for all three fuels, but in the case of alcohol there was a tendency for the M.E.P. to increase even with the strongest mixture employed (6 parts air to 1 part alcohol by weight). It can be seen from these curves why it is that a motor-car engine is usually run with less air than is required for complete combustion. If the carburettor is adjusted so that there is excess of air the car will be running on the sloping portion of the curve, which means that slight alterations in the carburettor setting will have a considerable effect on the power and the car will be uncomfortable to drive. With a richer mixture the car will be driven on the horizontal part of the curve, where the power is hardly affected by differences in the carburettor mixture. It is therefore almost certain that in practice the exhaust will contain unburnt or partially burnt fuel. It is possible that this may give rise to corrosion in the silencer or in other parts of the exhaust system in which condensation can take place.

Watson found that the maximum thermal efficiency at 800 r.p.m. (Fig. 47) was highest for alcohol, and lowest for petrol, but the differences were not great. The approximate values were :

	Maximum Thermal Efficiency.	Thermal Efficiency at Theoretically Complete Combustion Mixture.
Alcohol . . .	30.0 per cent.	26.9 per cent.
Benzol . . .	29.4 „	26.0 „
Petrol . . .	28.0 „	24.8 „

the compression ratio being the same in all cases. In this series of tests the effect of increasing the compression was not studied.

The ratio between the thermal efficiencies for the three fuels at the same compression ratio is thus practically the same as that found by Strong with slow-speed stationary engines, and by Ricardo with a specially designed engine.

The temperature curves calculated from the indicator diagrams in this series of tests have already been referred to (Fig. 34, p. 247).

Watson suggested that the slight differences in temperature shown by alcohol during the expansion stroke might be sufficient to account for its slightly higher thermal efficiency.

The question of fuel consumption was not dealt with by Watson. At equal compression ratios, it is of course much larger per B.H.P. hour for alcohol than for petrol or benzol.

Melbourne University Experiments.—A series of comparative tests was carried out in 1917 in the Engineering Laboratory of Melbourne University.¹⁰ The engine used for the experiments was of 4 $\frac{3}{4}$ -inch cylinder diameter and 6-inch stroke, and was rated at 5 h.p. at 600 r.p.m. When using kerosene, there was a special preheating attachment which heated the fuel before, and the mixture after, carburation. The engine was governed by a centrifugal governor operating a hit-and-miss arrangement on the inlet valve. The jets used for alcohol were of approximately 50 per cent. larger orifice than those used for petrol.

The compression ratio was 4.9, giving a compression pressure of about 58 lb. per square inch gauge.¹¹ By putting a distance piece between the connecting rod and the big end, the compression pressure could be raised to 70 lb. per square inch gauge.¹² Power was measured on an electric generator driven by a belt from the engine and connected to a variable water resistance as load. Measurements were made of the current generated, belt friction being allowed for.

Details regarding composition of the alcohol, and calorific values and specific gravities of the fuels used, are not given in the report, so that the thermal efficiencies can be deduced only approximately from the experimental results. The particulars of the tests, as given in the report, are shown on table opposite, the overall thermal efficiencies having been calculated from the results by taking average figures for calorific values and specific gravities.

"In test No. 1 the kerosene used was 'Laurel' brand. The engine was started on alcohol and the fuel and mixture were heated by passing them through the exhaust gases.

"In test No. 2 the engine was run on 'Plume' benzine.¹³ The fuel was measured by taking times of consumption of 100 c.c. When several successive times were equal these were taken.

"In test No. 3 the fuel was led straight to the carburettor,

¹¹ This is apparently the isothermal compression pressure. A compression ratio of 4.9 : 1 should give a compression pressure of approximately 96.5 lb. per square inch gauge (p. 252).

¹² Presumably about 121 lb. per square inch gauge actual compression pressure, or a compression ratio of 5.7 : 1.

¹³ The term "benzine" is apparently used in the report as a synonym or petrol.

RESULTS OF ENGINE TESTS

295

ENGINE TESTS CARRIED OUT AT MELBOURNE UNIVERSITY, 1917

Test Number.	Fuel.*	Mixture.*	Air.*	Water.*	Time.	Total Fuel. Pints.	B.H.P.	Fuel per B.H.P. Hour. Pints.	Temperature.		Approximate Overall Thermal Efficiency.
									Mixture.	Water.	
1. Kerosene . . .	H	H	N	N	25' 20"	1.6	5.5	0.70	75° C.	55° C.	18.1 per cent.
2. Benzene . . .	N	N	N	N	20' 0"	1.64	5.9	0.80	17.1 "
3. Alcohol . . .	N	H	N	N	35' 30"	3.12	4.9	1.07	21° C.	42° C.	20.8 "
4. Alcohol . . .	H	H	N	H	31' 0"	3.04	5.7	1.03	29° C.	50° C.	21.6 "
5. Alcohol (part load)	H	H	N	H	28' 56"	2.32	3.9	1.26	26° C.	45° C.	17.7 "
6. Alcohol (high compression)	H	H	N	H	31' 11"	2.96	5.6	1.02	28° C.	65° C.	21.8 "
7. Alcohol (part load)	H	H	N	H	33' 2"	2.64	4.0	1.19	28° C.	46°-58° C.	18.7 "
8. Alcohol (part load)	H	H	H	H	58' 59"	5.44	4.7	1.17	35° C.	60°-70° C.	19.0 "
9. Alcohol (full load)	N	H	H	H	18' 55"	1.52	5.2	0.99	33° C.	65° C.	22.5 "
10. Alcohol (full load)	N	H	H	N	32' 40"	2.96	5.4	1.02	23° C.	43° C.	21.8 "
11. Alcohol (full load)	N	H	H	H	31' 15"	2.64	5.2	0.97	33° C.	50°-55° C.	22.9 "

* H indicates "heated." N "not heated."

and the mixture after carburation was heated by means of the exhaust gases.

"In test No. 4 the fuel was passed through the exhaust gases before carburation.

"In test No. 5 the conditions were the same as in No. 4, but the engine was adjusted to half load by closing the throttle.

"In test No. 6 the compression was altered to 70 lb. per square inch, the other conditions being as in Nos. 4 and 5.

"In test No. 7 the engine was allowed to adjust itself by means of the governor, the throttle being kept full open.

"In test No. 8 the full horse-power was not developed owing to gasification of fuel and reduced charge.

"In test No. 11 the water was kept at a slightly lower temperature than in No. 9, where there was over-heating. Fuel was measured as in No. 2."

The general results of the tests are summed up in the report as follows :

(A) The results point to the conclusions that in a relatively slow-speed engine—

- (a) Alcohol is capable of developing as much power as benzine, without any material alteration of the engine.
- (b) The area of the jet orifice in the carburettor must be increased by about 50 per cent., in order to deliver a sufficient supply of fuel for full load.
- (c) It is necessary to heat the carburettor prior to starting.
- (d) No lubrication difficulties are likely to be met with.
- (e) Alcohol is "softer" than benzine, and the running of the engine is smoother.
- (f) As far as the tests have gone, no corrosion has appeared in the valves and no acids have been detected in the exhaust.

NOTE.—In all tests as weak a fuel mixture as was consistent with the satisfactory running of the engine was used.

(B) To secure economical results it was necessary—

- (a) To keep the circulating water as hot as possible, say, 50° C. measured at the tank.
- (b) To keep the inlet air highly preheated, say, 50° C.
- (c) To keep the mixture preheated, the final mixture after the addition of air and fuel being about 35° C.

(C) It was found that preheating the fuel had to be done with caution, as the vaporisation of the alcohol prevented the engine developing its full power.

The results of this series of tests confirm many of the conclusions previously drawn. Alcohol would appear to give a slightly higher thermal efficiency than petrol at the same compression ratio. The relationship between the two is similar to that obtained by Strong and Stone, Watson, and Ricardo.

As regards the advantages or otherwise of preheating the mixture, it is difficult to arrive at definite conclusions, as the carburetted conditions vary greatly in different engines. With petrol and benzol, both of which are completely volatilised in the induction system, preheating of the mixture causes loss in power owing to lower volumetric efficiency. Alcohol, with its high latent heat, its considerable water content, and its low vapour tension, behaves in this respect somewhat differently to hydrocarbon fuels. While the indicated thermal efficiency of volatile hydrocarbons is not affected by preheating the mixture that of alcohol is slightly raised. Moreover, the maximum power output with alcohol does not fall off so rapidly as with petrol and benzol (cf. pp. 242, 250).

Ricardo found that with the more volatile fuels the M.E.P. dropped by 0.47 lb. per square inch for every degree Centigrade by which the inlet temperature rose above 10° C., at compression ratio 5 : 1. This drop in M.E.P. was due to the decrease in density of the charge. With less volatile fuels, such as alcohol, it was found that the drop in mean pressure was much less, and in some instances was hardly perceptible over a considerable range of temperature. The obvious explanation of this, according to Ricardo, is that as long as the whole of the fuel is evaporated outside the cylinder, the mean effective pressure is proportional to the absolute temperature of the charge, but when a less volatile fuel is used, a considerable proportion enters the cylinder in a finely divided though still liquid state, and evaporation takes place within the cylinder during the suction stroke, as the finely divided liquid particles come into contact with the hot walls and the residual exhaust gas. Owing to the heat absorbed by the evaporation of the fuel, it is to be presumed that under these conditions the true suction temperature, as distinct from what has hitherto been termed the inlet temperature, remains practically constant. These experiments would appear to confirm the view expressed as a result of earlier tests carried out in France, that the ideal carburettor would be one which produced perfect "atomisation" of the fuel with a minimum of preheating.

London General Omnibus Company's Tests.—An important series of tests was carried out in 1919 by the London General Omnibus Company on alcohol-benzol and alcohol-benzol-ether mixtures.¹⁴ The quality of the alcohol used was not definitely stated, and it is

not clear whether it was ordinary methylated spirit or whether it had been specially denatured.

The series comprised bench, road, and service tests. About fifty bench tests were first carried out on a 110 mm. \times 140 mm. engine ("B" type) with a 50 per cent. alcohol-benzol mixture, the best results being obtained with a compression of 123 lb. per square inch. With mixtures containing higher percentages of alcohol the compression had to be raised to get maximum efficiency. It was found that with mixtures containing up to 70 or 80 per cent. of alcohol the fuel consumption in B.Th.U. per B.H.P. decreased (*i.e.* the efficiency increased) at full load with increasing proportion of alcohol in the mixture. With higher percentages of alcohol in the mixture the compression employed was not sufficiently high for the maximum efficiency to be attained. At low loads, on the other hand, the consumption of B.Th.U. per B.H.P. increased (*i.e.* the efficiency decreased) with increasing proportion of alcohol. This was ascribed to loss of volumetric efficiency at small throttle openings, and it was suggested that the advantages gained at full throttle when using higher percentages of alcohol will be offset by the loss of efficiency at small throttle openings. It was further suggested that in the particular type of engine used, the bad effect of valve pockets on fuel consumption was accentuated by increased compression.

The opinion is expressed in the report, as a result of the bench tests, that while a slow burning fuel such as alcohol makes it possible to reach high thermal efficiency and great fuel economy, the best results can be obtained only in an engine with long stroke and high compression with overhead valves. Emphasis is also laid on the necessity of preheating the mixture so as to ensure thorough vaporisation. Whether this preheating, in any of the tests, was carried to the point at which loss of power would result, is not stated.

The results of the bench tests are summarised as follows :

- (a) The greater the percentage of alcohol, the higher are the possible thermal efficiencies for the same compression.
- (b) The greater the percentages of alcohol, the higher can the compression be raised with consequent rise in thermal efficiency.
- (c) With high compression the ill effects of valve pockets are more noticeable at small throttle openings than with low compression.

A road test was then carried out with a "B" type engine in which the compression had been raised to 160 lb. per square inch by fixing aluminium plates to the top of the pistons. Mixtures of alcohol and benzol varying from 90 per cent. to 50 per cent. of

alcohol were tested against petrol over a standard test run of 16 miles. The best results were obtained with the mixture containing 70 per cent. of alcohol. On this mixture, with compression 160 lb., the consumption of B.Th.U. per mile was 14,100 as against 15,810 with petrol (normal compression). The thermal efficiency with the alcohol mixture was therefore 10·8 per cent. better than with petrol. The bench test with the same two fuels and the same respective compressions had given a thermal efficiency, with alcohol, 24·5 per cent. better than with petrol.

Service tests were then carried out on the ordinary omnibus routes with alcohol-benzol mixtures containing from 5 per cent. to 50 per cent. of alcohol. The compression in these particular tests is not definitely stated, but was apparently 123 lb. per square inch. The results were as follows :

		Fuel.	Total Mileage.	Average Miles per Gallon.	Average B. Th.U. per Mile.
First period, ending July 16, 1919	{	75 per cent. benzol	4597·7	7·42	18,980
		25 " alcohol			
		95 " benzol	2632·4	7·6	20,150
		5 " alcohol			
		Petrol (fleet averages)	..	7·58	19,900
Second period, ending Sept. 10, 1919	{	80 per cent. benzol	6746·4	7·28	19,780
		20 " alcohol			
		50 " benzol	4567·6	7·0	17,816
		50 " alcohol			
		Petrol (fleet averages)	..	7·55	20,050

While the 95 per cent. benzol mixture gave the best mileage per gallon, the 50 per cent. mixture gave the most efficient result compared with petrol. A further series of tests carried out with the 50 per cent. mixture during two winter months gave an average of 6·05 miles per gallon as against 7·19 for petrol.

A set of bench tests was also carried out with a mixture of 65 per cent. alcohol, 30 per cent. benzol, and 5 per cent. ether (sp. gr. 0·8265 at 15° C.). It was easy to start the engine from cold, as would be expected with a liquid, such as ether, of high vapour tension. The tests were carried out on an engine with normal compression. At speeds below 900 r.p.m. the power developed was slightly better than with petrol, but not so at higher speeds. Consumption was slightly higher than with petrol, especially at quarter load. In all other respects the fuel compared favourably with petrol, and exhibited the characteristics of other alcohol mixtures in respect of flexibility, absence of knocking, and cleanliness.

Various points with regard to the running and behaviour of the engines with alcohol mixtures are considered in this report from the practical standpoint. Many of these points have already been dealt with in some detail. It was found necessary to use lead-coated fuel tanks and pipes, owing to the corrosion experienced with alcohol mixtures (cf. p. 267). No exhaust corrosion was noticed, but the inlet valve pockets and the induction pipe just under the valve heads became coated with a thick tar-like deposit, after six weeks' running, to such an extent as partially to choke the passage. The cause of this deposit is obscure. It is possibly of the same nature as that frequently met with on the wicks of alcohol burners, and investigated in 1903 by G. Heinzelmann.¹⁵ He found that it was due mainly to the non-volatile residue of the spirit, and that its production was favoured by the presence of light-boiling constituents such as acetaldehyde. Pure alcohol did not form a deposit, and a high percentage of fusel oil was also without effect. This points to the undesirability of storing alcohol in wooden vessels, from which it may extract non-volatile substances.

The ease of starting, acceleration, and flexibility were noticeable, and there was no knocking or "pinking" when negotiating hills at low speeds. Excess of water in the alcohol gave trouble at one time, which was attributed to condensation on the mica plugs, with consequent difficulty in starting. This was overcome by using plugs with porcelain insulation to within a short distance of the points. It was also found that in cold weather there occurred a separation of water in the tank, which had therefore to be fitted with a drain-cock, and it is suggested that the 50 per cent. alcohol-benzol mixture will hold only a limited quantity of water in solution at low temperatures (cf. p. 256).

In comparing the efficiency of the fuels, it is pointed out that motor fuels are bought on a basis of quantity and not of heat units. The fuel consumption in gallons per B.Th.U. and per mile was in every case greater with alcohol mixtures (except the one containing 95 per cent. benzol and 5 per cent. alcohol) than with petrol, although the relative consumption of B.Th.U. was less. On a basis of equal cost, say 25d. per gallon, the following would be the comparison between the fuels :

	Petrol.	50 per cent. Benzol-Alcohol.
B.Th.U. per penny . . .	6,050	5,000
B.Th.U. per mile . . .	20,050	17,816
Cost per mile . . .	3·3d.	3·5d.

The value of this series of tests lies in their essentially practical character. Alcohol mixtures were closely compared with petrol under service conditions, and the effective use of such mixtures shown to be practicable with comparatively slight alterations to the engine.

Donath and Gröger¹⁶ give the following results as having been obtained with different motor fuels in Germany. The car used was of 14 metric h.p. and weighed 2990 lb.

	Kilometres per Litre.	Miles per Gallon.
Petrol	5·8	16·4
Benzol	7·1	20·0
1 Benzol +1 alcohol	7·5	21·2
1 Benzol +2 alcohol	7·2	20·3
1 Benzol +3 alcohol	7·0	19·8
1 Benzol +4 alcohol	6·6	18·6
1 Benzol +5 alcohol	6·0	16·9
Alcohol	5·4	15·2

According to these results the 50 per cent. alcohol-benzol mixture is nearly 30 per cent. better in mileage than petrol alone. In the tests carried out by the London General Omnibus Company, on the other hand, this mixture was 7·3 per cent. inferior to petrol in miles per gallon. This discrepancy only serves to emphasise the unreliability of conclusions drawn from the results of road tests unless these are carried out on a large number of vehicles of different types and an average is taken of a sufficient number of individual tests. In comparing the results of a few tests it is difficult to assess the part played by road surface, wind, tyre inflation, and many other variables.

Ricardo's Experiments.—A large number of experiments with different fuels, including alcohol, have been carried out by H. R. Ricardo with a view to comparing their behaviour under precisely similar conditions.¹⁷ The work was carried out mainly on the variable compression engine already described (p. 229), and additional tests were run on several other types of engine.

These experiments constitute the most complete series of comparative tests which have yet been made, and throw fresh light on many of the problems connected with the internal combustion

engine. Most of the results obtained, in so far as they affect the behaviour of alcohol, have already been referred to above.

By comparing different fuels at their "highest useful compression ratios," *i.e.* those at which detonation was just avoided in each particular case, Ricardo found the following values :

Fuel.	Highest Useful Compression Ratio.	Corresponding Indicated Thermal Efficiency (per cent.).	Corresponding Indicated Mean Effective Pressure (Pounds per Square Inch Gauge). [Constant Heat Input to Carburettor of 65 B.Th.U. per Minute.]
Petrol (various brands)	4.55 : 1 to 6.0 : 1	30.2 to 34.9	124.4 to 140.1
Benzene (98 per cent.)	6.9 : 1	37.2	146.5
Toluene and xylene .	7.0 : 1	37.5	147.0
Hexane (80 per cent.) .	5.1 : 1	32.4	133.1
Alcohol (98 per cent.) .	7.5 : 1	40.4	156.5
Methylated spirits .	6.5 : 1	38.5 (approx.)	155.5
Purified wood naphtha.	5.2 : 1	35.0 (approx.)	146.6

With alcohol, toluene, and xylene these compression ratios are not the highest which can be employed without causing detonation, but are probably the highest which can usefully be employed in practice.

The results for fuel consumption were as follows :

Fuel.	Minimum Consumption at 5 : 1 Compression Ratio (Pints per B.H.P. Hour).	Minimum Consumption at Highest Useful Compression (Pints per B.H.P. Hour).
Petrol (various brands .	0.442 to 0.471	0.402 to 0.484
Benzene (98 per cent.) .	0.415	0.355
Toluene and xylene .	0.418 to 0.420	0.354
Hexane (80 per cent.) .	0.480	0.473
Alcohol (98 per cent.) .	0.665	0.533
Methylated spirits .	0.721	0.609
Purified wood naphtha.	0.750	0.700

Ricardo emphasises the importance of ignition timing in comparative tests on different fuels. When carrying out experiments with varying compressions, it is essential that the tests should be carried out over the whole range of ignition. He is of opinion that theories that benzol mixtures, alcohol, etc., give appreciably more power than pure petrol owe their origin to the fact that the tests

have been carried out on engines in which the compression was already too high to allow of them being operated with full ignition advance on petrol, and the gain in power or efficiency observed when benzol or benzol mixtures (and also presumably alcohol) were tested was due solely to the fact that only with such fuels could the correct ignition timing be used.¹⁸

Comparative tests with alcohol and other fuels on multi-cylinder engines are liable to be affected to a considerable extent by unequal distribution of the mixture to the cylinders. The heterogeneous mixture of fuel spray and air, as it is drawn through the induction pipe to the cylinder, is subject to continual fluctuations in speed, pressure, and temperature, which tend to produce partial condensation of liquid on the inner surface of the induction pipe, resulting in a weaker mixture. The vapour pressure, boiling range, and latent heat of the fuel are all concerned in determining the extent to which this occurs. The conditions affecting condensation will vary in each of the branches of the induction pipe, so that to avoid an over-weak mixture in one of the cylinders and back-firing of the charge, the ratio of fuel to air must usually be kept rather higher than would otherwise be the case. If the induction pipe be kept hot, so as to avoid the formation of a liquid film, volumetric efficiency is impaired. Very little is known at present as to the factors which control distribution.

Ricardo's main conclusions as regards alcohol may be summarised as follows :

1. The low rate of burning of alcohol-air mixtures lessens the tendency to detonate, and allows of high compression being used with consequent increase in thermal efficiency.

2. The rate of burning is not too low to permit of maximum efficiency being obtained in the highest speed engine yet tested.

3. The total energy liberated by the combustion of unit volume of the correct mixture is practically the same with alcohol, petrol, and benzol.

4. The maximum power output at equal compression ratios is somewhat higher for alcohol than for hydrocarbon fuels, owing to the high latent heat of alcohol, which results in a lower suction temperature and, in consequence, a greater weight of charge.

5. The thermal efficiency at equal compression ratios is slightly higher for alcohol than for hydrocarbon fuels, owing to the lower temperature of the heat cycle and smaller heat losses. This reduction in temperature is due partly to the higher latent heat of alcohol, partly to the greater increase in specific volume on explosion, and the higher specific heat of the combustion products, and partly to the lower rate of flame with alcohol.

6. Although alcohol gives a considerably greater maximum power output, and furthermore can be used with a higher thermodynamic efficiency than hydrocarbon fuels, the heat value of alcohol per unit of weight or per unit of volume is so much lower than that of petrol or benzol that the rate of consumption for equal power is nevertheless greater.

REFERENCES

- ¹ E. Meyer, *Die Haupt-prüfung von Spiritus-Locomobilen, Deutsche Landwirtschaftliche Gesellschaft, Heft 78, 1902.*
- ² C. E. Lucke and S. M. Woodward, U.S. Department of Agriculture, Farmers' Bull. No. 277, "The Use of Alcohol and Gasoline in Farm Engines," 1907.
- ³ R. M. Strong, U.S.A. Geological Survey, Bull. No. 392 (1909).
- ⁴ R. M. Strong and L. Stone, U.S. Bureau of Mines, Bull. No. 43 (1912).
- ⁶ A. E. Davidson, *Proc. Inst. Automobile Engineers, 1913-14, 8, 98.*
- ⁷ W. R. Ormandy, *Proc. Inst. Automobile Engineers, 1913-14, 8, 49.*
- ⁹ W. Watson, *Proc. Inst. Automobile Engineers, 1914-15, 9, 73.*
- ¹⁰ Advisory Council of Science and Industry, Australia, Bull. No. 6 (1918).
- ¹⁴ G. J. Shave, Imperial Motor Transport Conference, Oct. 18-21, 1920, Fuels Section, *Engineering, 1920, 110, 623.*
- ¹⁵ G. Heinzelmann, *Zeitsch. für Spiritus Industrie, 1903, No. 42.*
- ¹⁶ Donath and Gröger, *Die Treibmittel der Kraftfahrzeuge, Berlin, 1917.*
- ¹⁷ H. R. Ricardo, *Automobile Engineer, 1921, 11, numbers for February, March, April, May, and June.*
- ¹⁸ H. R. Ricardo, *Engineering, 1920, 110, 325 and 361.*

CHAPTER XI

FUEL MIXTURES CONTAINING ALCOHOL

Carburetted Alcohol.—It is evident from the foregoing that considerable alterations, more especially as regards compression, must be made in existing petrol engines if full efficiency is to be obtained from alcohol. In an engine built with the normal compression ratio for petrol, the fuel consumption per B.H.P. or per ton-mile is so much greater with alcohol than with petrol that the price of alcohol would have to be much the lower of the two, before it could be regarded as a commercial competitor. No doubt the advent of cheap alcohol in sufficient quantity would be followed by the production of low-speed high-compression engines suited to motor transport, but many years must elapse before the output of this type of engine reaches a figure in any way comparable to that of the present-day petrol engine. A more promising direction, therefore, in which to look for a solution of the motor fuel problem lies in the use of "carburetted" alcohol, or mixtures of alcohol with other fuels of greater calorific value and higher vapour tension, which may be used in the existing engine with a fuel consumption and efficiency comparable to that of petrol. The recent Excise regulations permitting such mixtures to be placed on the market without undue restrictions must undoubtedly have the effect of stimulating research into methods of producing alcohol cheaply. By the use of such mixtures engine designers will become familiarised with the properties of alcohol as a fuel, and the time taken to evolve an engine capable of utilising alcohol alone to the fullest advantage will depend largely on the relative cheapness and availability of the fuel.

Many mixtures of alcohol with other fuels have been proposed, and several have been used successfully in place of petrol with a minimum amount of alteration in the engine. Reference has already been made to the series of trials carried out by the London General Omnibus Company on mixtures of alcohol and benzol. For the purpose in view, however, that of utilising the existing engine with normal compression, these trials are hardly conclusive, since the compression of the engines used was raised to 123–160 lb. Even so,

the fuel consumption in miles per gallon of all mixtures except that containing 95 per cent. of benzol and 5 per cent. of alcohol, was inferior to that of petrol, although the actual thermal efficiency was higher.

Ormandy's bench tests, at equal compression, showed that 50 per cent. benzol-alcohol gave a slightly better result for fuel consumption than petrol at low speeds, but at high speeds the consumption was in favour of petrol. With one part benzol and two parts alcohol the fuel consumption was greater at all speeds than with petrol.

Donath and Gröger (p. 301) stated that equal mixtures of benzol and alcohol gave a 29 per cent. better mileage result than petrol alone, and that all mixtures of benzol and alcohol down to 17 per cent. benzol gave better results for fuel consumption than petrol. Meyer's results showed that at comparatively low compressions an increased proportion of benzol raises the power and thermal efficiency and lowers the fuel consumption per B.H.P. hour at normal load, while at half load the addition of benzol in proportions up to 21 per cent. made little difference as compared with alcohol alone. It is evident that the relative advantages or disadvantages of carburetted alcohol and petrol cannot be gauged from the results of any one series of tests, but will depend largely upon the conditions under which the fuels are used.

One advantage possessed by benzol over petrol as a diluent of alcohol is the higher degree of miscibility of the two liquids at ordinary temperatures, but this advantage is lost at low temperatures. H. B. Dixon's figures for the separation temperatures of alcohol-benzene and alcohol-hexane mixtures on addition of water have already been given on p. 256. It would appear from these results that although at ordinary temperatures benzene-alcohol mixtures will take up much more water than hexane-alcohol, at low temperatures the reverse is the case. Thus at 0° C. solid benzene separates from a 50 per cent. mixture of 90 per cent. alcohol and benzene, but a similar mixture of rectified spirit and hexane remains homogeneous until a much lower temperature is reached. These results explain to some extent the trouble experienced by the London General Omnibus Company with alcohol-benzol mixtures in cold weather owing to separation, which necessitated the provision of a drain tap in the fuel tank.

In alcohol-petrol mixtures the origin of the petrol has a considerable effect upon the homogeneity of the product at different temperatures. Petrol contains varying quantities of naphthenes, aliphatic and aromatic hydrocarbons, and will mix more or less readily with alcohol according to its relative content of each of

these classes of compounds. Borneo petrol, which contains a comparatively high proportion (up to 38 per cent.) of aromatic hydrocarbons, is more suitable for admixture with alcohol than are petrols consisting chiefly of paraffins.

Mohr¹ states that a mixture of 50 parts alcohol, 25 parts benzol, and 25 parts petrol has given good results. It does not exhibit an undue tendency to separation at low temperatures.

Several different mixtures are stated to have been used by the German Army during the war, among them the following :²

70	parts	denatured	alcohol	(95	per	cent.	strength)	+ 30	parts	benzol.
50	"	"	"	(90	"	"	"	+ 30	parts	benzol + 20 parts
										acetone.
90	"	"	"	(90	"	"	"	+ 10	parts	ethyl ether.
50	"	"	"	(90	"	"	"	+ 30	parts	petrol + 20 parts
										acetone.
80	"	"	"	(95	"	"	"	+ 20	parts	benzol (contain-
										ing naphthalene in the
										proportion of 200 grams
										per litre).

One per cent. of lubricating oil was often added with a view to preventing corrosion.

The use of naphthalene appears to have given trouble owing to separation of crystals in the induction system. Naphthalene is soluble in benzol to the extent of 40 per cent. at 15° C. and 32 per cent. at 0° C., while in alcohol the solubilities are only 5 per cent. and 4.25 per cent. respectively.

This difficulty has apparently been overcome by the use of tetrahydronaphthalene ("tetralin"). This substance has a high calorific value, and is readily soluble in mixtures of alcohol and benzol. The so-called "Reichskraftstoff" consists of benzol, tetralin, and alcohol in roughly equal proportions.

Ether Mixtures : Natalite.—The use of ethyl ether in admixture with alcohol has often been proposed. Although the calorific value of ether is only about 20 per cent. higher than that of alcohol, its high vapour tension and the fact that it can be manufactured direct from alcohol by a simple process are in its favour. A fuel known as "Natalite," consisting essentially of alcohol 60 per cent. and ethyl ether 40 per cent., is now being manufactured in Natal on a considerable scale from sugar-cane molasses. About 1 per cent. of ammonia is added to the fuel, with the object of neutralising the exhaust and preventing corrosion, and it originally contained about 0.5 per cent. of arsenic trioxide, presumably added as a denaturant. At present it would appear that pyridine and wood naphtha are used as denaturants. Road tests of this fuel as compared with petrol are stated to have shown

that the fuel consumption is practically identical in both cases, or even slightly less for Natalite. No difference could be detected in the running of the engine. The exhaust was quite clear, and no deposit in the cylinder or corrosion of the exhaust were observed. Tests on a 22 h.p. car,³ weight 3600 lb., are reported to have given a consumption of 16.4 miles to the gallon or 26.2 ton-miles per gallon over a total of 500 miles. The car was easy to start and the valves remained clean at the end of the test. A reduction of the air supply was necessary when using Natalite. On a 20 h.p. Ford car, at 20 miles per hour, 35.2 miles per gallon were obtained with Natalite as against 40.75 with petrol (sp. gr. 0.715).⁴

The extremely good results obtained for fuel consumption with Natalite are somewhat remarkable. The net calorific value of a mixture consisting of 60 per cent. of alcohol (95 per cent. strength) and 40 per cent. of ethyl ether is approximately 95,000 B.Th.U. per gallon as against 140,000 B.Th.U. for petrol. Assuming that the above tests were carried out at the same compression for both fuels, the results point to a much higher thermal efficiency with Natalite than with petrol. It may be that with the former fuel it was possible to secure more accurate timing of the ignition. Reference is in fact made to the absence of "pink-ing" in the engine when running on Natalite.

On the other hand, ether was found by Ricardo to detonate at extremely low compressions. A mixture of 50 per cent. of ether with 50 per cent. of petrol freed from aromatic compounds could not be used at a compression ratio higher than 3.9 : 1, which pointed to a value of 2.95 : 1 for the highest useful compression ratio for ether alone.

The main factory for the production of Natalite at Merebank, near Durban, was started in February 1918, and by the end of the year had produced over 250,000 gallons. The total production in 1920 is stated to have been between 1 and 1½ million gallons. The cost of the fuel was estimated in 1918 to be about 2s. 9d. per gallon, a price which was largely due to the high cost of the pyridine and wood naphtha used as denaturants.

The theoretical yield of ether is only about 5 gallons from 6 gallons of 96 per cent. alcohol, so that the higher the proportion of ether in the mixture the greater the cost of the fuel. It was found at Gretna during the war that a yield of ether amounting to 98 per cent. of the theoretical could be obtained at a cost of 7s. 2d. per gallon with alcohol costing 5s. 9d. per gallon, or 25 per cent. more than the cost of the alcohol.

Several patents have been taken out for motor fuels containing ether as a constituent.

J. P. Foster⁵ proposes a mixture containing 15 volumes of ether, 2 volumes methyl alcohol, and 0.5 volume pyridine to 100 volumes of ethyl alcohol.

The U.S. Industrial Alcohol Company⁶ have patented a mixture of alcohol 35 to 50 per cent., benzol 25 to 35 per cent., and ethyl or butyl ether 20 to 40 per cent.

Another patent⁷ proposes a mixture of 10 to 60 per cent. ethyl ether with 5 to 30 per cent. kerosene and 30 to 80 per cent. of alcohol of a specific gravity not higher than 0.84.

A. de-feo Lopez⁸ claims the partial conversion of alcohol into ether by passing alcohol vapour through a mixture of alcohol and sulphuric acid at 100° to 150° C. The product is rectified and mixed with 10 to 40 per cent. of alcohol together with 5 to 50 per cent. of a suitable hydrocarbon distillate. The final mixture has a specific gravity of 0.730 to 0.780. B. Benedix⁹ proposes mixtures of petrol and benzol or benzol and alcohol with at least 5 per cent. of ether.

A mixture of 5 per cent. of ether with 65 per cent. of alcohol and 30 per cent. of benzol was submitted to bench tests by the London General Omnibus Company with good results (p. 299). A mixture known as "E.H.A." in France is stated to contain 10 per cent. of ether and 25 per cent. of benzol, the remainder being alcohol.¹⁰

The separation of water from mixtures of alcohol and ether is not so likely to occur as with alcohol-benzol and alcohol-petrol mixtures. A. Boutin and A. Sanfourche have determined the reciprocal solubility of mixtures of water, alcohol, and ether at 15° C. Their results have already been given in the form of a triangular diagram on p. 258. It can be seen from this diagram that alcohol of a strength higher than about 70 per cent. by volume can be mixed with ether in all proportions at 15° C. without separation occurring. The isothermal curves for other temperatures investigated by S. Horiba¹¹ for 25° C. and W. D. Bonner¹² for 0° C. are similar to that for 15° C.

Alcohol containing Acetylene or other Gases.—Many suggestions have been made for the use of acetylene in alcoholic solution as a motor fuel. Acetylene is soluble in many organic liquids, especially in acetone, which will absorb, at 15° C., 25 volumes of the gas and at a pressure of twelve atmospheres as much as 300 volumes.¹³ Pure acetylene, being an endothermic compound, is explosive at pressures greater than two atmospheres, and the liquefied gas will explode with a violence comparable to that of gun-cotton. The solution in acetone is not explosive, but the gaseous atmosphere above the surface of the liquid may be

dangerous at high pressures. It has been proposed that acetylene should be compressed into cylinders filled with a porous medium impregnated with acetone, whereby the formation of a gaseous atmosphere is prevented.¹⁴

The employment of acetylene as the main constituent of motor fuels has been investigated by Haber.¹⁵ He found that the combustion was complete and that the usual compression ratio of 4.5 : 1 could be used. The sparking plugs must be kept as cool as possible to avoid danger of pre-ignition, and insulating material of low heat conductivity should be used only in the more remote parts of the plug. Haber was of the opinion that, provided the cost of carbide was sufficiently low, the admixture of acetylene with other fuels with the object of depressing its inflammability appeared particularly promising.

Acetylene is soluble to the extent of six volumes in alcohol at ordinary temperatures and pressures, and under these conditions there is not much risk of explosion of the gas. The limits of inflammability when mixed with air are extraordinarily wide; according to Le Chatelier all mixtures of air and acetylene containing from 2.9 to 65 per cent. by volume of the latter gas will explode if contained in a tube of sufficient diameter.

Acetylene appears under certain conditions to increase the velocity of flame propagation. It will not stand a high compression without pre-ignition, and if used in too large a proportion, gives too violent an explosion.

Gases dissolved in liquid fuels are liable to be given off from the liquid while it is being transferred from one receptacle into another. Gas will also collect in the fuel tank above the liquid, and the fuel in a partially empty tank may thus contain less of the gas than when the tank is freshly filled up. Moreover, owing to the reduction in pressure in the carburettor at each suction stroke, the gas is liable to be evolved from the liquid and to form bubbles in the jet, leading to irregular carburation.

The actual weight of acetylene which can be dissolved in alcohol is not more than 0.9 per cent. of the weight of the alcohol, so that the calorific value is hardly affected. Acetone will absorb 3.6 per cent. of its weight of acetylene at atmospheric pressures and 43.5 per cent. at twelve atmospheres.

King and Stoneham¹⁶ propose to introduce an equal volume of acetylene into the still before condensation of the alcohol vapours. The condensation, then takes place in the ordinary manner, the liquid holding the acetylene in solution. In the Barker-White system, aqueous alcohol is sprayed on to calcium carbide, and the resulting mixture of alcohol vapour and acetylene used as a fuel.

A German patent has been taken out for the addition to alcohol of a mixture of acetaldehyde and paraldehyde in any proportions required to give a fuel of the desired vapour tension. The mixture is stated to have approximately the same calorific value as methylated spirit. If the manufacture of alcohol from carbide were to prove to be a commercial success, and the production of power alcohol were to develop in this direction rather than by fermentation processes, there is no doubt that acetaldehyde, and possibly acetylene, being intermediate products in the manufacture, would be largely used instead of benzol, petrol, and ether to give to the fuel the necessary vapour tension. With cheap carbide it might also be found possible to utilise acetone for the same purposes.

Among other gaseous or easily volatile substances which have at times been suggested are ethylene¹⁷ and carbon disulphide.¹⁸ Ethylene dissolves to the extent of 3 per cent. by volume in alcohol (Bunsen and Carius), and this gas would be free from the disadvantages attending the use of acetylene. Carbon disulphide, although highly volatile and miscible in all proportions with alcohol, would in all probability lead to corrosion of the exhaust system and to the presence of sulphur dioxide in the exhaust gas.

Oxidising Agents and Explosives.—Several patents have been taken out for the addition to motor fuels of oxidising substances or explosives, such as ammonium perchlorate, picric acid, hydrogen peroxide, and nitrobenzene. The claims made for them are that they increase the speed of the explosion and assist in promoting complete combustion. It is extremely doubtful whether any advantage is to be gained from their use, and it is more than likely that some of them may lead to corrosion through the formation of oxides of nitrogen. Picric acid is soluble only to the extent of 0.015 per cent. in petrol, and although freely soluble in benzol and fairly so in alcohol, it is liable to separate out in the carburettor and cause choking of the jet. Moreover, it attacks and corrodes metals, and there is a distinct danger of the formation of deposits of highly explosive metallic picrates in the induction system. An interesting example of fuel of this type is afforded by a patent recently taken out in America for a mixture of alcohol, acetone, and cellulose nitrate.¹⁹

It is evident that when alcohol comes into general use as a motor fuel, a considerable variety of mixtures may be placed upon the market. It will be necessary, in the interests of the consumer, that some control be exercised over the composition of such mixtures, quite apart from the water content already referred to on p. 255.

The Interdepartmental Committee²⁰ in 1919 recommended

that when benzol, ether, petrol, or the like are mixed with alcohol in quantities in excess of those which may be legally required as partial denaturants, the nature and amount per cent. by volume of such components should be plainly stated on the containers of such mixtures and on the contracts, sales-notes, and invoices dealing with them.

REFERENCES

- ¹ O. Mohr, *Zeitsch. für angew. Chemie*, 1914, **27**, 558.
- ² K. Dietrich, *Zeitsch. für angew. Chemie*, 1914, **27**, 543.
- ³ *Autocar*, June 15, 1915.
- ⁴ *Autocar*, May 28, 1921.
- ⁵ J. P. Foster, U.S. Pat. 1,248,302 (1917).
- ⁶ U.S. Industrial Alcohol Co., Eng. Pat. 128,916 (1919).
- ⁷ P. d'O. Fayd'herbe, Eng. Pat. 123,450 (1918).
- ⁸ A. de-feo Lopez, Eng. Pat. 133,434 (1918).
- ⁹ B. Benedix, Ger. Pat. 296,193.
- ¹⁰ C. Simmonds, *Alcohol*, London, 1919, p. 384.
- ¹¹ S. Horiba, *Journ. Tokio Chem. Soc.*, **31**, 944.
- ¹² W. D. Bonner, *Journ. Phys. Chem.*, 1910, **14**, 738.
- ¹³ G. Claude and A. Hess, *Compt. Rend.*, 1897, **124**, 626.
- ¹⁴ M. Berthelot and P. Vieille, *Compt. Rend.*, 1897, **124**, 988.
- ¹⁵ F. Haber, *Zeitsch. Elektrochem.*, 1920, **26**, 325-329.
- ¹⁶ P. H. King and J. A. Stoneham, Eng. Pat. 112,741 (1917).
- ¹⁷ J. Reilly, *Industrial Alcohol*, Dublin, 1919.
- ¹⁸ U.S. Industrial Alcohol Co., U.S. Pat. 1,324,765 (1919).
- ¹⁹ U.S. Pat. 1,313,876 (1919).
- ²⁰ Cmd. 218 (1919).

INDEX

- " ABFINDUNGSBRENNEREIEN," 97.
 Acetaldehyde, from acetylene, 174-181.
 — as by-product of fermentation, 26.
 — as constituent of motor fuel, 311.
 — electrolytic reduction of, 183.
 — from ethylene, 175.
 — reduction of, to ethyl alcohol, 182.
 — in sulphite spirit, 155.
 — yield of, from acetylene, 177.
 Acetic acid, use of, in aldehyde synthesis, 180.
 Acetic anhydride, from ethylidene acetate, 181.
 Acetone, explosive range, 254.
 — production of, by *Bacillus acet-ethylicus*, 58.
 — as solvent of acetylene, 309.
 Acetylene, conversion into acet-aldehyde, 175.
 — explosive range, 254.
 — as motor fuel, 309.
 — reduction of, to ethylene, 175.
 — solubility in acetone, 309.
 — in alcohol, 310.
 — as source of alcohol, 174-185.
 Achroodextrinase, 45.
 Acidity of wort, 51.
 Acids, as bacterial antiseptics, 49, 61, 64.
 Acorns, yield of alcohol from, 114.
 Adiabatic expansion, 218.
 Adipo-celluloses, 129.
 Aeration of wort, 50, 154.
Agave, 114.
 Air, excess, amount required, 238.
 — standard efficiency, 226.
 Alcohol from acetaldehyde, 182.
 — from acetylene, 174.
 — from cellulose materials, 129-168.
 — consumption of, in engine, 238.
 — from contemporary vegetation, 7.
 — corrosion by, 77, 202, 266, 293.
 — cost compared with petrol, 117, 118.
 — cost of manufacture, 9, 109, 160.
 — denaturation of, 195-209.
 — deposit from, in induction pipe, 269, 300.
 Alcohol, difficulty of starting on, 264.
 — duty on, 194.
 — economics of production from crops, 86-126.
 — effect of water content, 255, 285.
 — from ethylene, 171.
 — Excise receipts from, 194.
 — explosion temperature of, 249.
 — explosive range of, 254.
 — factors affecting cost of, 86.
 — fire risk, 255.
 — flash point of, 271.
 — freight and distribution costs, 117.
 — as fuel for aircraft, 124.
 — gross calorific value of, 234.
 — latent heat of, 242.
 — as local industry, 124.
 — miscibility with benzene, 259.
 — — with benzol, 255, 300, 306.
 — — with ether, 258, 309.
 — — with hexane, 260.
 — — with lubricating oil, 259.
 — — with petrol, 255, 306.
 — net calorific value of, 234.
 — preparation of absolute, 66.
 — production of, from starch and sugar, 31-84.
 — — in tropics, 122.
 — specific gravity of, 188, 269.
 — summary of behaviour in engine, 303.
 — synthetic, cost of, 183.
 — — coal requirements, 185.
 — tables, 190-191.
 — theoretical yield of, from carbo-hydrates, 8.
 — ultimate composition of, 232.
 — vapour tension of, 260.
 — viscosity of, 271.
 — yield of, from carbohydrates, 52.
 — — from coke-oven gas, 172.
 — — from starch and sugar materials, 65.
 — — from various raw materials, 115.
 — — from wood, 135-145.
 Alcohol-benzol mixtures, 306, 307.
 — — London General Omnibus Company tests on, 299.

- Alcohol-benzol mixtures, Ormandy's tests on, 186.
 Alcoholometry, 188.
 — foreign systems, 194.
 Aleurone layer, 15.
 Algae, 16.
 Aluminium fluoride, as bacterial antiseptic, 48.
 Amino-acids, as source of higher alcohols, 29.
 Amylase, 15.
 Amylin, 38.
 Amylo process, 53-58.
 — — Excise restrictions on, 57.
 — — yield and cost of alcohol by, 58.
Amylomyces, 54.
Andropogon, 90, 107.
 Angiosperms, 133.
 "Antiferments," 23.
 Antiseptics, use of, in fermentation, 48, 63.
 Arabinose, 13.
 — from spruce wood, 133.
 — in sulphite liquor, 166.
 Arrowroot, 114.
 Artichoke, 100, 101.
 Ascospores, 17.
Aspergillus, 54.
 Asphodel root, 114.
 Attenuation, 19, 51.
 Australia, denaturation in, 204.
 — prickly pear in, 112.
 — sorghum cane in, 108.
 — *Zamia palm* in, 112.
 Aviation, use of alcohol in, 124.
 Avogadro's hypothesis, 216.
- Bacillus aceto-ethylicus*, 58.
 — *Delbrücki*, 47, 49.
 — *mesentericus*, 45.
 Bacteria, 19.
 — action of, on cellulose, 126.
 — action of, on starch, 45.
 — alcoholic fermentation by, 58.
 — infection of wort by, 47.
 Bacterial antiseptics, 48.
 "Bagasse," 106.
 Baker's yeast, 52.
 Barley, characteristics of, 33.
 — four-rowed, 33.
 — germinating power of, 33.
 — germination of, 15.
 — range of, 87.
 — six-rowed, 32.
 — two-rowed, 33.
 — yield of alcohol from, 87.
 — malt, 32.
Bassia, 110.
 Beet molasses, 108.
 — sugar statistics, 109.
- Beets (*see* Sugar beet), 58-61, 102-105.
 — as source of alcohol, 58.
 — unsuitability of, for thick mash process, 59.
 — use of residue as feeding stuff, 60.
 Benzene, explosion temperature of, 242.
 — explosive range, 254.
 — latent heat of, 242.
 — miscibility with alcohol, 259.
 — ultimate composition of, 232.
 Benzol, from coal, 6.
 — as denaturant, 204.
 — freezing-point of, 258.
 — miscibility with alcohol, 255, 300, 306.
 — ultimate composition of, 233.
 "Black strap" molasses, 110.
 Blow-pits, 150.
 Bohm's still, 68.
 Bone oil, 205.
 Borneo petrol, 307.
 Bottom yeasts, 19.
 Brake horse-power, 223.
 "Brennrecht," 96.
 "Brennsteuer," 94.
 British thermal unit, 214.
 "Bub," 46.
 Bub mash, fermentation of, 49.
 — — souring of, 47.
 Buckwheat, 88.
 Budding of yeast, 17.
 Burma, rice straw in, 147.
 Butter tree, 110.
 Butyl alcohol, in fusel oil, 29.
- Calcium carbide, 174.
 Calorie, 214.
 Calorific value, 214.
 — — of alcohol, 233.
 — — of correct explosion mixture, 237.
 — — of different fuels, 235.
 — — gross, 228, 234.
 — — net, 228, 234.
 — — theoretical, 233.
 Canada, sulphite pulp mills in, 163.
 Cane molasses, 108.
 — sugar, statistics, 107, 109.
 Caoutchoucine, 205.
 — specification for, 207.
 Carbon dioxide, effect of, on yeast growth, 21.
 — disulphide, as constituent of motor fuel, 311.
 Carbonatation, 108.
 Carboxylase, 25.
 Carburetted alcohol, 286, 305.
 Carburettor, atomisation of fuel by, 266, 297.

- Carburettor**, defects in, accentuated
by alcohol, 291.
— heat, 265.
— supply to, 241.
— jet, heating of, 265, 292.
— comparative size of, with different fuels, 238, 271, 284, 292, 296.
- Carbyl sulphate**, 174.
- Carnot's principle**, 224.
- Caryota**, 113.
- Cassava**, 99-100.
- Catalysts**, use of, in alcohol synthesis, 173, 175-183.
— regeneration of, in aldehyde synthesis, 177, 178.
- Cellulase**, 15.
- Cellulose**, 13, 124, 129, 131.
— action of bacteria on, 126.
— action of dilute acids on, 164.
— action of moulds on, 126.
— classification of, 129.
— esparto, 132.
— fermentation of, 126.
— hydrolysis of, 125, 131, 132, 145, 163, 167.
— reversion products, 164.
— as structural material, 125.
- Centigrade heat unit**, 214.
- "Centrale für Spiritus Verwertung," 95.
- Cereals**, 86.
— as source of industrial alcohol, 88.
— use of, in United Kingdom, 87.
- Champonnois' process**, 60.
- Charcoal**, as absorbent of ethylene, 174.
- "Chevalier" barley, 33.
- Chinese yeast**, 54.
- Chlorophyll**, 11.
- Chlorosulphonic acid**, as absorbent for ethylene, 173.
- Cladonia**, 113.
- Clearance space**, 210.
- Coal**, carbonisation of, 6.
— output of, 4.
— reserves of, 4.
- Coal gas**, ethylene content of 171.
— as motor fuel, 7.
— scrubbing of, 6.
- Coefficient of purification**, 75.
- Co-enzymes**, 23, 28.
- Coffey still**, 76, 77.
- Coke-oven gas**, ethylene content of, 171.
- Colophony**, as bacterial antiseptic, 63.
- Column still**, 68.
- Combustion**, amount of air required for, 236.
— heat of, 214.
- Compression**, 211.
- Compression pressure**, calculation of, 252.
— for different compression ratios, 245, 253.
— ratio, 210.
— effect of, on thermal efficiency, 225, 276.
— highest useful, 228, 246.
— variable, 229.
— temperature, 252, 253.
— effect of preheating on, 266.
— effect of latent heat on, 250.
- Coniferous woods**, 133.
- Coniferyl alcohol**, 134.
- "Contingent," 93.
- Continuous fermentation**, 61-63.
— stills, 67-84, 159.
- Convertor**, 40.
- Co-operative systems**, in Germany, 95.
— in France, 104.
— in tropics, 123.
— in United Kingdom, 99.
- Corrosion**, 266, 293.
— by denatured alcohol, 123, 267.
— effect of water content on, 268.
— esters as cause of, 267.
— exhaust, 268.
— of fuel tanks, 267, 300.
— prevention of, 268.
- Cost of alcohol compared with petrol**, 116.
- Cotton cellulose**, 129.
- Creosote oil**, as denaturant, 205.
- Crops**, surplus, as source of alcohol, 121.
- Cuto-cellulose**, 129.
- Cyanamide**, as fertiliser, 185.
- Cytase**, 15.
- d-amyl alcohol**, formation of, from isoleucine, 29.
- "Dari," 90.
- "Daru," 110.
- Dasyllirion**, 114.
- Defecation**, 108.
- Denaturants**, benzol, 204.
— bone oil, 205.
— caoutchoucine, 205.
— creosote oil, 205.
— mineral naphtha, 200, 203, 204.
— pyridine, 202, 203, 204.
— requirements of, 199.
— tobacco oil, 204.
— turpentine, 205.
— wood naphtha, 200.
- Denaturation**, 195.
— in other countries, 202-204.
— of power alcohol, 201.
— for special purposes, 196.
- Dephlegmators**, 78.
- Detonation**, 243-245.

- Deutz engine, 276.
 Dextrin, 37.
 Dextrose, 13.
 — action of lime on, 158.
 — from cellulose, 131, 132.
 — decomposition of, on heating with acids, 164.
 — from starch, 38.
 — in sulphite liquor, 165.
 Diastase, 15, 32, 37.
 — in unmalted rye, 45.
 Diastatic power, 35, 36.
 — of moulds, 53.
 Diesel engine, 3, 214.
 Diethyl sulphate, 173.
 Diffusion process for beets, 60.
 Digestor, for treating wood waste, 136, 137, 139, 142.
 Dihydroxy-acetone, 25.
 Dihydroxy cinnamyl alcohol, 135.
 Dipentene, 206.
 Dissociation of gases at high temperatures, 221.
 Distillation, 65.
 — continuous, 68.
 — Excise restrictions on, 194.
 — fractional, 72.
 — simple, columns, 67.
 — Sorel's work on, 65.
 — steam consumption in, 81.
 — values of k for secondary constituents, 72.
 Distribution, in multi-cylinder engines, 303.
 Donath and Gröger's tests, 301.
 Drawback, 196.
 Dujardin press, 59.
 Duty, differential, 198.
 — on immature spirits, 194.

 Ebulliometers, 194.
 Economics of alcohol production, 86-126, 146, 185.
 Efficiency, air standard, 226.
 — mechanical, 228.
 — thermal, 224.
 — volumetric, 223.
 Ekström's process, 152.
 Endosperm of barley, 15.
 Energy, in alcoholic fermentation, 20.
 — total heat, liberated by combustion, 237.
 Engine, Clement-Talbot, 240.
 — Deutz, 276.
 — Diesel, 214.
 — four-stroke, 211.
 — Knight, 239, 249, 292.
 — Maudslay, 286.
 — performance of different makes of, 280, 287.

 Engine, semi-Diesel, 214.
 — slow speed, 279.
 — stationary, 266, 279.
 — steam, 1.
 — Sunbeam, 290.
 — two-stroke, 210.
 — variable compression, 229.
 Enzymes, 13.
 — derivation of term, 22.
 — nomenclature of, 15.
 — properties of, 14.
 Ether, explosive range, 254.
 — formation of, in alcohol synthesis, 182.
 — highest useful compression ratio of, 308.
 — miscibility with alcohol, 258, 309.
 — yield of, from alcohol, 308.
 Ether mixtures, 307-309.
 — London General Omnibus Company's tests on, 299.
 Ethylene, 171.
 — absorption of, by charcoal, 174.
 — — — by chlorosulphonic acid, 173.
 — — — by sulphuric acid, 172-173.
 — from acetylene, 175.
 — in coke-oven gas, 171.
 — as constituent of motor fuel, 311.
 — conversion of, into acetaldehyde, 175.
 — separation of, by liquefaction, 173.
 Ethylidene diacetate, 180.
 Excise regulations, 194.
 Exhaust, 285.
 — gas, 238.
 — composition and sampling of, 241.
 Explosion temperature, 247-250.
 Explosive range, 253.
 Explosives in fuel mixtures, 311.
 Extract, 39.

 Farm engines, in Germany, 279.
 Fatty acids, production of, by bacteria, 64.
 Feints, 72.
 — hot, 77.
 Fermentation, 46.
 — Adrian Brown's views on, 20.
 — by bacteria, 58.
 — of bub mash, 49.
 — Buchner's work on, 22.
 — continuous, 61-63.
 — duration of, 51.
 — Excise restrictions on, 194.
 — Harden's theory of, 23.
 — Liebig's views on, 20.
 — of main wort, 49.
 — mechanism of, 23-30.
 — of molasses, 63.
 — Neuberg's theory of, 25.
 — Pasteur's views on, 19.

- Fermentation, Slator's work on, 21.
 — stages of, 50.
 Ferrosilicon vessels, 176.
 Finance Act, 1902, 196.
 — 1920, 198, 201.
 — 1921, 195, 198, 202.
 Flash points of alcohol, 271.
 Fluorides, as bacterial antiseptics, 48.
 — effect on cattle, 48.
 Foodstuffs, alcohol value of, 121.
 — use of, for alcohol production, 120.
 Foreshots, 72.
 Formaldehyde, in photosynthesis, 12.
 Formic acid, from acetylene, 181.
 Four-stroke engine, 211.
 France, beet cultivation in, 104.
 — denaturation in, 203.
 French War Office trials, 286, 287.
 "Frohberg" yeasts, 19, 46.
 Fuel, cost of, 3.
 — in tropical distilleries, 122.
 Fuel consumption, at different engine speeds, 290.
 — effect of load on, 276, 283.
 — effect of water on, 285.
 — Ricardo's results, 302.
 — mixtures, declaration of composition, 311.
 — Research Board, 7.
 — tanks, corrosion of, 267, 300.
 Fungi, 61.
 Furfural, 132.
 Fusel oil, 29, 72.
 — Ehrlich's work on, 28.
 — nature of, from various sources, 29.
 Galactans, 13, 133, 144.
 Galactose, 13.
 — fermentation of, 32.
 — from spruce wood, 133.
 — in sulphite liquor, 165.
 Gas constant, 216.
 — laws, 216.
 — producers for motor transport, 7.
 Gazagne's dephlegmator, 78.
 Germ of barley, 15.
 German Army, fuel mixtures used by, 307.
 Germany, cost of industrial alcohol in, 96.
 — decline of potato-spirit production in, 97.
 — denaturation in, 202.
 — farm engines in, 279.
 — production of potato spirit in, 92-98.
 — sulphite pulp mills in, 163.
 — taxation of alcohol in, 92-97.
 Germination of barley, 15.
 Glutamic acid, 29.
 Glyceraldehyde, 25.
 Glycerol, as fermentation by-product, 26.
 Glyoxal, from acetylene, 181.
 "Goldthorpe" barley, 33.
 Governing of engines, 229.
 Grains, removal of, from wort, 44.
 Grass tree, 113.
 Green malt, diastatic power of, 35.
 — use of, in maize conversion, 43.
 Gross calorific value, 228, 234.
 Guillaume's still, 70, 82.
 Guinea corn, 90.
 Gymnosperms, 133.
 Hansen's method of yeast cultivation, 18, 46.
 Hartmann's tests, 274.
 Heat, of combustion, 214.
 — specific, 215.
 — unit of, 214.
 Heat energy, of explosive mixtures, 237.
 — engines, types of, 1.
Helianthus, 100.
 Henze convertor, 40.
 Heptane, calorific value of, 235.
 — explosion temperature of, 249.
 — ultimate composition of, 232.
 Hard woods, 133.
 Hexane, ignition temperature of, 251.
 — latent heat of, 242.
 — miscibility with alcohol, 256, 260.
 — total heat energy liberated by, 237.
 Hexosans, 132.
 Hexose diphosphoric acid, 24.
 — phosphatase, 24.
 — sugars, 13.
 — enolic form of, 24.
 — fermentation by yeast, 17.
 Higher alcohols, 29.
 Highest useful compression ratio, 228, 246.
Hordeum, 33.
 Horse chestnuts, 114.
 Horse-power, 215.
 — brake, 223.
 — indicated, 222.
 — metric, 215.
 Hot feints, 77.
 Hydrochloric acid, use of, in maize conversion, 43.
 Hydrofluoric acid, as bacterial antiseptic, 48.
 Hydrogen "acceptor," 28.
 Hydrometer Act, 189.
 Iceland moss, 113.
 Ideal thermal efficiency, 226.

- Ignition, temperature of spontaneous, 250.
— timing of, 285, 302.
- Ignition plug, position of—as affecting detonation, 245.
- Ilge's still, 70.
- Illipé butter, 110.
- India, denaturation in, 206.
- Indicated horse-power, 222.
- Indicator diagram, 222.
- Induction pipe, deposit in, 269, 300.
— heating of, 265, 284, 297, 298.
- Inlet temperature, 241, 242, 265, 266, 284, 296, 297.
- Internal combustion engine, I, 211—231.
- Inulin, 13.
— in artichoke, 100.
— in asphodel root, 114.
- Inversion, of sucrose, 64.
- Ipomœa*, 102.
- Iso-amyl alcohol, formation of, from leucine, 29.
- Iso-butyl alcohol, in fusel oil, 29.
- Isoleucine, as source of *d*-amyl alcohol, 29.
- Isoprene, 206.
- Isothermal expansion, 218.
- Isotherms of alcohol mixtures, 258.
- Jacket temperature, 284, 296.
- Jerusalem artichoke, 100.
- Jet area, 238, 284, 292, 296.
- Joule's equivalent, 215.
- Kaffir corn, 90.
"Koji," 54.
- Labour, in tropics, 123.
- Lactic acid, commercial, as bacterial disinfectant, 49.
— — effect of, on bacteria, 47.
— — as intermediate product in fermentation, 25.
- Lævulose, 13.
— formation of, from hexose phosphates, 24.
— in sulphite liquor, 165.
- Lag-phase in yeast growth, 21.
- Laminaria*, 114.
- Landmark's process, 152.
- Larch, galactose from, 133.
— yield of alcohol from, 144.
- Latent heat, 241.
— — effect of, on carburettor heat required, 265.
— — effect of, on compression temperature, 250.
— — effect of, on inlet temperature, 242.
- Latent heat, effect of, on net calorific value, 234.
— — effect of, on power output, 239, 241.
— — effect of, on thermal efficiency, 250.
— — effect of, on volumetric efficiency, 242.
- Leucine, as source of iso-amyl alcohol, 29.
- Leuconostoc mesenteroides*, 61.
- Lichenin, 113.
- Lichens, 113.
- Lignin, 13, 130, 133.
— action of sulphur dioxide on, 134, 149.
- Lignin sulphonic acids, 134, 149.
- Ligno-casein, 153.
- Ligno-cellulose, 13, 129.
— chlorination of, 133.
— nature of, 131.
- Lignone, 133.
- Lipases, 15.
- Load, effect of, on fuel consumption, 276, 283.
- London General Omnibus Coy.'s tests, 297.
- Lonza works, 182, 183.
- Low wines, 72.
- Lubrication, 259.
- Lucke and Woodward's tests, 279.
- Maceration process for beets, 59.
- Macrozamia*, 112.
- Mahua flowers, 110.
"Maischraumsteuer," 93.
- Maize, 88.
— conversion of, 42.
— price of, 89.
— range of, 89.
— stalks as source of alcohol, 89.
— yield of alcohol from, 89.
- Malt, 32—37.
— green, 35, 38.
— from rye, wheat, oats, maize and sorghum, 36, 37.
- Malting, 34.
— pneumatic, 35.
- Maltodextrins, 38.
- Maltose, 13.
— fermentation of, 32.
— from starch, 38.
- Mangolds, 105.
- Manihot*, 99.
- Mannans, 13, 133.
- Mannose, 13.
— from spruce wood, 133.
— in sulphite liquor, 165.
- Maranta*, 114.
- Marble, use of, in purification of alcohol, 82.

- Mashing, British and Continental practice, 39.
- Mash tun, 43.
- Mean effective pressure, 222.
- — — in Clement-Talbot engine, 240.
- — — effect on, of heat supply to carburettor, 241.
- — — in Knight engine, 292.
- — — Ricardo's results for, 302.
- Mechanical efficiency, 228, 284.
- Melbourne University tests, 294.
- Melebiose, 64.
- Mercury, use of, in aldehyde synthesis, 176.
- Methyl alcohol, action on metals, 268.
- — amount of, in methylated spirits, 233.
- — calorific value of, 235.
- — explosive range of, 254.
- — latent heat of, 242.
- — in sulphite spirit, 155.
- Methylated spirits, 195.
- — composition of, 233.
- — fraudulent admixture of, with alcohol, 200.
- — industrial, 196.
- — mineralised, 196.
- — Power, regulations for, 197.
- — restrictions on sale of, 197.
- — temporary regulations during war, 196.
- Methylation, effect of, on cost of alcohol, 201.
- Methyl-glyoxal, 25.
- Methyl-violet, in methylated spirits, 196.
- Metroxylon*, 113.
- Meyer's tests, 274.
- Mhowa flowers, 110.
- Millet, 90.
- Mineral naphtha, as denaturant, 196, 203-204.
- Mitscherlich process, 149.
- Modification of malt, 32, 34-35.
- Molasses, 63, 108.
- alkaline carbonates in, 64.
- "black-strap," 110.
- cost of alcohol from, 109.
- fermentation of, 63.
- quantity used for rum, 109.
- as source of motor spirit in Hawaii and Cuba, 110.
- statistics, 109.
- sugar content of, 108.
- from wood, 146.
- yield of alcohol from, 109.
- Monilia*, 18.
- "Morterd" process, 152.
- Moulds, 19.
- action of, on cellulose, 126.
- conversion of starch by, 46.
- Moulds, use of, in amylo process, 54.
- Mowra flowers, 110, 111.
- Muco-celluloses, 129.
- Mucor*, 46, 54.
- Mucor Boulevard*, 57.
- "Mycelium," 18.
- Mycetes*, 17.
- Mycoderma*, 18.
- Naphthalene, in alcohol mixtures, 307.
- "Natalite," 269, 307.
- fuel consumption with, 308.
- Net calorific value, 228, 234.
- Nickel, as catalyst, 182.
- Nipa palm, 112.
- Nitrates, reduction of, in molasses worts, 64.
- Nitrogen, soluble, in wort, 46.
- Nitrous acid, production of, in molasses worts, 64.
- Nutrition of plants, 11.
- of yeast, 46, 159.
- Oats, 88.
- Opuntia*, 112.
- Organisation, of alcohol production in tropics, 123.
- Ormandy's tests, 286.
- Otto cycle, 211.
- Oxidising agents, in fuel mixtures, 311.
- Oxygen, relation of, to yeast growth, 19-22.
- Paraldehyde, 179.
- as constituent of motor fuel, 311.
- Parasites, 17.
- Peat, 148.
- Pecto-celluloses, 129.
- Pentane, explosive range of, 254.
- ignition temperature of, 251.
- Pentosans, 132.
- Pentoses, fermentation of, 58.
- Pepsin, 15.
- Petrol, average yield of, from petroleum, 5.
- consumption of, in U.S.A., 5.
- cost compared with alcohol, 117, 118.
- explosive range, 254.
- freight and distribution costs, 117.
- importation of, into U.K., 5.
- miscibility with alcohol, 255, 306.
- ultimate composition of, 233.
- Petrol engine, 3.
- Petroleum, output of, 4.
- reserves of, 4.
- Phosphates, effect on fermentation, 23.

- Photocatalysis, 12.
 Photosynthesis, 11.
 Picric acid, in fuel mixtures, 311.
 "Pinking," 244, 266.
Polymnia, 101.
 Potatoes, 91.
 — agricultural importance of distilleries, 92.
 — conditions in United Kingdom, 98.
 — conversion of, 40.
 — cost of, 91.
 — relative production in United Kingdom and Germany, 98.
 — as source of alcohol, 91.
 — use of, in amylo process, 57.
 — use of, in Germany, 92.
 — yield per acre, 91.
 — yield of alcohol from, 91.
 Potato spirit, fusel oil from, 29.
 — — industry, development of, in Germany, 92-97.
 — — reduced production of, in Germany, 98.
 Pot still, 72.
 Pounds per barrel, 39.
 Power, at different engine speeds, 288.
 — effect of air supply on, 238, 292.
 — effect of latent heat on, 241.
 — effect of water content on, 285.
 — unit of, 215.
 Power alcohol, denaturing of, 201, 205.
 — — allowance on, 198.
 — — importation of, 197.
 — Methylated Spirits Regulations, 1921, 197, 202.
 — plants, characteristics of, 2.
 Preignition, 244.
 Pressed yeast, manufacture of, 52.
 Pressing of beets, 59.
 Prickly pear, 112.
 Proof spirit, 189.
 — — in United States, 194.
 Propane, hydroxyl derivatives of, 25.
 Propyl alcohol, in fused oil, 29.
 Pyridine, 205.
 — as denaturant, 202, 203, 204.
 — specification for, 208.
 Pyrolusite, use of, in aldehyde synthesis, 177.
 Pyrrole, 206.
 Pyruvic acid, 25, 26, 28.

 "Rachis" of barley, 32.
 Raffinose, in beet molasses, 64.
 — fermentation of, 32, 64.
 Rate of flame, 243, 247, 284, 288.
 "Ratooning" of sugar cane, 105.
 Raw materials, 31.
 — — availability of, 86.

 Raw materials, comparison of cultivation costs, 116.
 — — maximum allowable cost per ton, 118.
 — — yields per acre, 115, 116.
 — — yield of alcohol from, 115.
 Rebate on spirits for methylation, 196.
 Rectification, 72.
 Reductase, 26.
 Reindeer moss, 113.
 Residuals as feeding stuffs, 9.
 — from acid saccharification, 45.
 — from bacterial process, 46.
 — from beet distilleries, 103.
 — in Germany, 39, 92.
 — from hydrolysis of wood, 139, 142.
 — from maize conversions, 42.
 — presence of fluorides in, 48.
 — in undeveloped countries, 123.
 Respiration of plants, 11.
Rhizopus, 54.
 Ricardo engine, 229.
 Rice, 90.
 — straw, 147.
 Ritter-Kellner process, 149.
 Roots, 102.
 Rotation of crops, 99, 100, 122.
 "Rückvergütung," 94.
 Rum, production of, from cane molasses, 63.
 — quantity produced, 109.
 Rye, 87, 88.
 — diastase in, 45.
 — malted, 36.

 "Saaz" yeasts, 19.
 Saccharification, 43.
 — by acid, 44.
 — by moulds, 46, 53-58.
 — of raw rye, 45.
 Saccharine sorghum, 107.
Saccharomyces, 17.
 — *anamensis*, 56.
 — *cerevisiæ*, 18.
 — *ellipsoideus*, 148.
 Sago palm, 113.
 Saprophytes, 17.
 Sawdust, alcohol from, 135-147.
Schizo-saccharomyces, 63.
 — *Pombe*, 50.
 Scutellum, 16.
 Seaweed, as source of alcohol, 114.
 Secondary constituents, 26, 28, 72, 155.
 — corrosion influenced by, 124.
 Secretory layer of barley, 15.
 Semi-Diesel engine, 214.
 Sikes's hydrometer, 192.
 — tables, 193.
 Sisal hemp, 114.

- Sorel's work on distillation, 65.
 Sorghum cane, 107.
 — grain, 90.
 Sotol plant, 114.
 Specific heat, 215.
 — at constant volume and constant pressure, 216.
 — increase of, at high temperatures, 220.
 — ratio of, 217.
 Speed, control of, 229.
 Spent grains, 39.
 — wash, for stock feeding, 39.
 Spirit Monopoly Act, 1918, 97.
 Spirits, differential duties and allowances on, 199.
 — methylated, 195.
 — "silent" or neutral, 77.
 Spirits Acts, 1860 and 1880, 195.
 Spruce, sulphite liquor from, 166.
 — yield of alcohol from, 144.
 Starch, 13.
 — action of diastase on, 37.
 — conversion of, 37.
 — conversion of, under pressure, 40.
 — gelatinisation of, 37.
 — hydrolysis of, 32.
 — liquefaction of, 38.
 — by bacteria, 45.
 — saccharification of, 38.
 — by moulds, 54.
 Steam engine, 1.
 "Steigraum," 44.
 Still, Bohm's, 68.
 — Coffey, 76.
 — continuous, 67, 75, 80.
 — Guillaume's, 70.
 — rectifying, 82.
 — Ilge's, 70.
 — pot, 72.
 — types of, 68-84.
 "Stomata," diffusion of carbon dioxide through, 11.
 Straw, 124, 147.
 Stroke, of engine, 210.
 Strong and Stone's tests, 279-286.
 Succinic acid, formation of, from glutamic acid, 29.
 Sucrose, 13.
 — fermentation of, 32.
 — inversion of, 64.
 Suction temperature, 252, 297.
 Sugar beet, 102.
 — Champonnois' process, 60.
 — content of sucrose, 102.
 — cost of alcohol from, 103.
 — cultivation of, 102.
 — diffusion process, 60.
 — distribution of, 102.
 — effect of distilleries on agriculture in France, 104.
 Sugar beet, in England, 102, 104.
 — maceration process, 59.
 — pressing of, 59.
 — production of alcohol from, 58, 103.
 — yield of alcohol from, 103.
 — cane, 105-107.
 Sulphite liquor, 148.
 — composition of, 149, 165, 166.
 — construction of still, 160.
 — content of carbohydrates, 151, 165, 166.
 — destruction of sugars in, 166.
 — distillation of fermented wash, 155, 159.
 — Ekström's process, 152.
 — fermentation of, 154, 158, 159.
 — fertilising value of spent wash, 160.
 — Landmark's process, 152.
 — Mitscherlich process, 149.
 — Morterud process, 152.
 — nature of sugars in, 164.
 — neutralisation of, 153, 157.
 — neutralisation sludge, 157.
 — pollution of streams, 150.
 — quantity of, per ton of cellulose, 150.
 — Ritter-Kellner process, 149.
 — steam consumption in distillation of, 159.
 — triple-effect evaporator for, 155.
 — Wallin's process, 152.
 — yield of alcohol from, 152-154.
 — spirit, acetaldehyde in, 155.
 — cost of, 160.
 — fuel consumption in distillation of, 161.
 — methyl alcohol in, 155.
 — statistics, 162.
 Sulphites, fermentation in presence of, 27.
 Sulphuric acid, use of, in beet distilleries, 61.
 — use of, in maize conversions, 42.
 — use of, in molasses fermentation, 64.
 Sulphurous acid, in sulphite liquor, 149.
 — compounds of, with lignin, 134, 149.
 — effect of, on yeast, 153.
 Surplus crops, as source of alcohol, 121.
 Surtax, on imported alcohol, 198.
 Synthetic alcohol, 171-185.
 — Excise supervision over, 195.
 Sweden, sulphite pulp mills in, 162.
 Sweet potato, 102.

- Taka diastase, 54.
 "Taka koji," 54.
 Tank steamers, transport of alcohol by, 123.
 "Tetralin," 307.
 Thermal efficiency, 224.
 — actual, 227.
 — air standard, 226.
 — comparative, at equal compression ratios, 249.
 — at different engine speeds, 289.
 — effect of air supply on, 240, 292.
 — effect of excess air on, 238.
 — effect of latent heat on, 250.
 — effect of operating conditions on, 281.
 — effect on, of size of engine, 283.
 — effect of water on, 285.
 — ideal, 226.
 — increase of, with compression ratio, 226.
 — over-all, 228.
 — relative, 227.
 — Ricardo's results, 302.
 — Strong's results, 282.
 — theoretical, 227.
 — Watson's results, 293.
 Toluene value, 246.
 Top yeasts, 19.
Torula, 18.
 Transport, in undeveloped countries, 122.
 — by tank steamer, 122.
 Tropics, advantage of, 126.
 — alcohol production in, 122.
 — water supply for distilleries in, 142.
 Tubers, 91.
 Turbulence, 245, 247.
 Two-stroke engine, 210.
 "Ueberbrand," 96.
 Ultra-violet light, photosynthetic action of, 12.
 United States, denaturation in, 203.
 — maize in, 89.
 — petroleum reserves of, 4.
 — petroleum output of, 4.
 — proof spirit in, 194.
 — sorghum cane in, 107.
 Valve pockets, 298.
 — influence of, on detonation, 245.
 Vapour tension, of liquid fuels, 260-266.
 Variable compression engine, 229.
 "Verbrauchsabgabe," 93.
 "Verschlussbrennereien," 97.
 Viscosity, of liquid fuels, 271.
 Volumetric efficiency, 223, 231, 290.
 — effect of latent heat on, 242.
 Volumetric efficiency, effect of pre-heating on, 224, 266, 284, 297.
 — effect of throttling on, 224, 246, 276, 291.
 Wallin's process, 152.
 Waste land, reclamation of, for alcohol production, 121.
 Water-gas, alcohol from, 183.
 Water supply, for distilleries, 122, 141.
 Watson's tests, 291.
 Wheat, 87.
 — malting of, 36.
 Wild yeasts, 18.
 "Wire-drawing," 224.
 Wood, alcohol from, 135.
 — arrangement of plant, 141.
 — Classen's process, 136.
 — comparison of methods, 143.
 — conifer, 133.
 — constituents of, 129.
 — cost of alcohol from, 139, 143.
 — distilleries, at Aachen, 136.
 — at Chicago, 137.
 — at Fullerton, 142.
 — at Georgetown, 139.
 — at Hattiesburg, 137.
 — at Port Hadlock, 142.
 — economic considerations, 146.
 — Ewen and Tomlinson's process, 137, 139.
 — hard, 133.
 — hydrolysed, composition of, 138.
 — hydrolysis of, by concentrated acids, 145.
 — nature of sugars formed in hydrolysis of, 163.
 — pine, composition of, 130.
 — ratio of liquor to, 144.
 — Simonsen's process, 136.
 — yield of alcohol from, 138, 140, 143.
 Wood dextrins, 159.
 — gum, 130, 132.
 — molasses, 146.
 — naphtha, 195, 200.
 — as cause of corrosion, 267.
 Wort, 39.
 — acidity of, 51.
 — attenuation of, 19, 51.
 — fermentation of, 49.
 — separation of, from grains, 44.
 — specific gravity of, 39.
Xanthorrhæa, 113.
 Xylan, 132.
 Xylose, 13, 133.
 — in sulphite liquor, 165-167.
 Yam, 102.
 Yeast, 17.

- Yeast, acclimatisation of, to hydro-
fluoric acid, 48.
— aerobic growth of, 21.
— anaerobic growth of, 21.
— attenuating power of, 19.
— baker's, 52.
— bottom, 19.
— "bub," 46.
— cell, permeability of, 24.
— cultivated, 18.
— dipeptide from, 28.
— effect of carbon dioxide on, 21.
— film, 18, 63.
— fission, 63.
— "Frohberg," 19.
— lag-phase in growth of, 21.
- Yeast, "Pombe," 50.
— pressed, 39, 52.
— pure cultures of, 18.
— races and types of, 19.
— "Saaz," 19.
— sporulation of, 17.
— top, 19.
— Vienna process, 39, 52.
— wild, 18.
Yeast juice, dialysis of, 24.
— — fermentation by, 23.
- Zamia palm, 112, 113.
"Zuschlag," 94.
Zymase, 15, 23.
Zymin, 28.

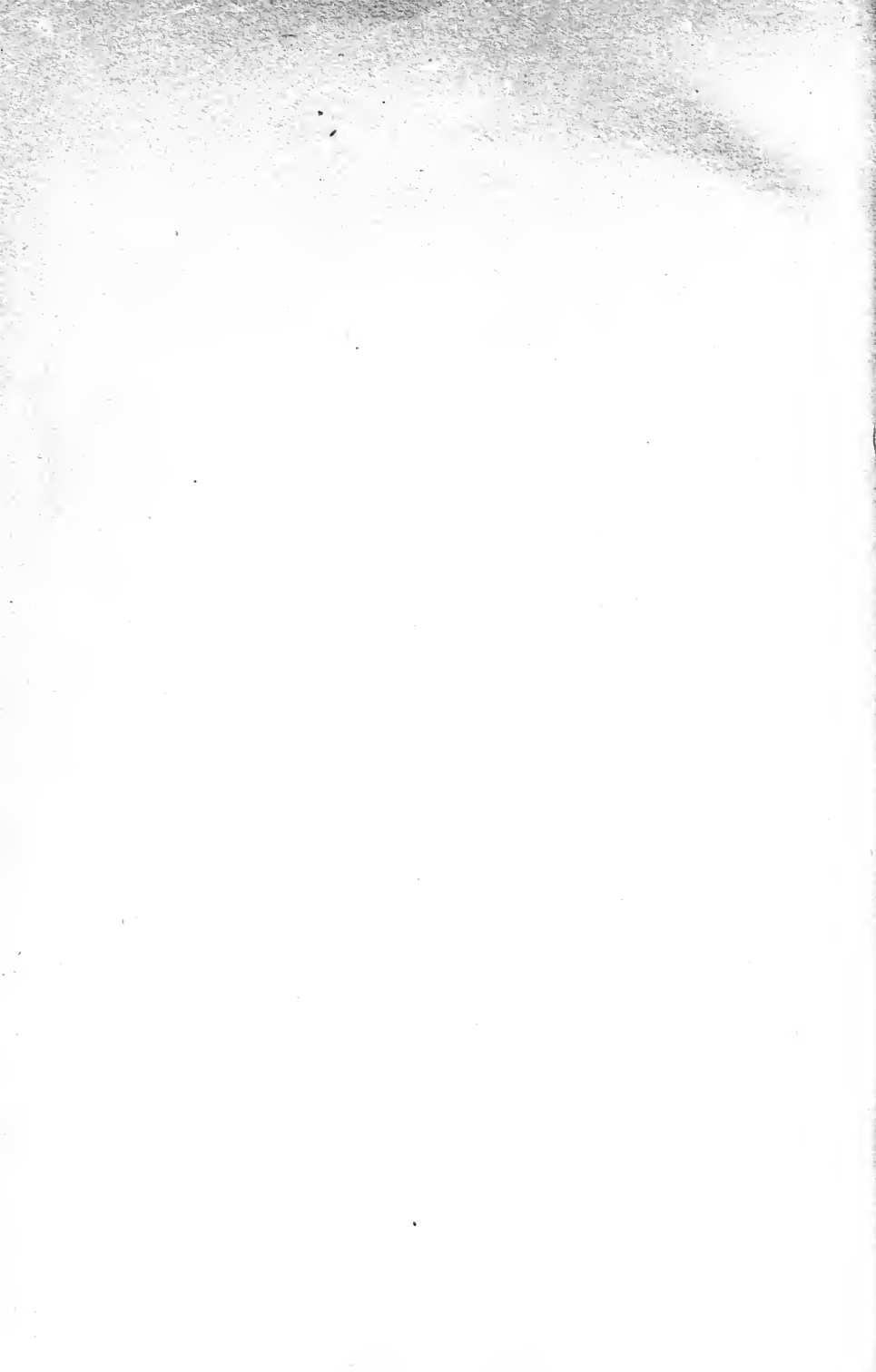

UNIVERSITY OF CALIFORNIA LIBRARY
BERKELEY

Return to desk from which borrowed.
This book is DUE on the last date stamped below.

MAY 18 1948

27 Dec '48 P3

24 Jan '60 CR

REC'D LD

JAN 10 1960

APR 6 1974 7

REC'D CIRC DEPT

APR 2 1979

NOV 14 1976

REC. CIR. NOV 26 '76

MAR 2 1980

REC. CIR. NOV 12 '80

INTERLIBRARY LOAN

MAY 21 1973

UNIV. OF CALIF., BERK.

YC 18317

520236

TP-93
A/6

UNIVERSITY OF CALIFORNIA LIBRARY

