

FACTICAL  
NET MASTER  
DESIGNER

6357

---

163 | 300



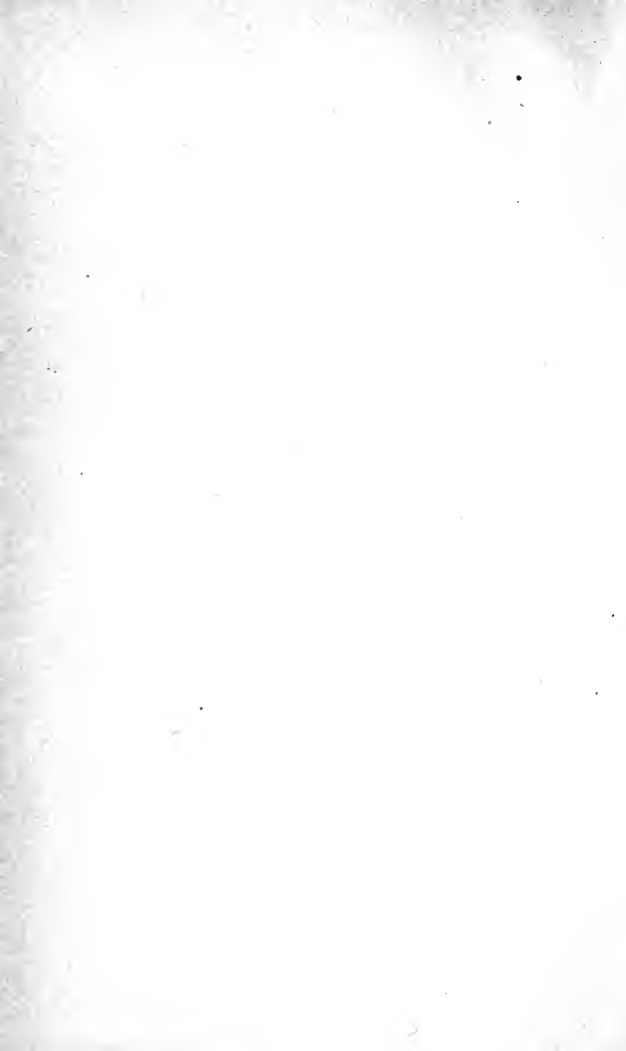







# *The* PRACTICAL CABINET MAKER

AND

Furniture Designer's Assistant

*WITH ESSAYS ON*

HISTORY OF FURNITURE, TASTE IN DESIGN, COLOR  
AND MATERIALS, WITH FULL EXPLANATION OF  
THE CANONS OF GOOD TASTE IN FURNITURE

Together with Many Practical Directions for Making  
Cabinet Work Generally, and a Number of Pieces of  
Furniture in Particular, along with Hundreds of Recipes  
for Finishing, Staining, Varnishing, Polishing and  
Gilding all kinds of Cabinet Work    ::    ::    ::

By FRED T. HODGSON, F. R. I. C. A.

Author of "PRACTICAL TREATISE ON THE STEEL SQUARE," "MODERN  
CARPENTRY," "HARDWOOD FINISHER, WOOD-CARVING," ETC., ETC.



Beautifully and Copiously Illustrated with over 200 Drawings  
and Sketches, Showing Various Styles of Furniture, from the  
Most Ancient to the Most Modern

CHICAGO  
FREDERICK J. DRAKE & CO., PUBLISHERS

Copyright 1910  
by  
Frederick J. Drake & Co.  
Chicago

Printed in U. S. A.

## PRELIMINARY REMARKS.

In preparing this work, I think it unnecessary to waste time and space in publishing a preface, which would at least occupy from three to five pages, and which at best, would be of little service to my readers; so I will content myself, and perhaps serve my readers better by inserting in these remarks the gist of what would be expected to appear in a preface, along with other material that may be both interesting and useful.

In these days, specialization in "Furniture-making" has in a great measure robbed the trade of many of its charms, as well as its claims to the dignified position it once held.

In the "good old times" every man who could hold up his head and say truthfully "I am a CABINET-MAKER," meant that he had given long years of apprenticeship to every branch and every detail of the business. His assertion, when interpreted, meant "that he could take timber, saw it, plane it, mould it, glue it, veneer it, join it, carve it, finish it, and upholster it, all by hand." It meant a full knowledge of everything connected with the manufacture from the entrance to the yard and to that of the wareroom. What might be expected of such workmen, in the way of completeness

and thoroughness, could be had for the hiring. Their experience was indelibly stamped upon their work.

Invention has disarranged this most certainly. The labor-saving machinery of later years has dispensed with something of the old-time necessity. Circular saws, jig and band saws, stickers, planers, jointers, carvers, and the many contrivances for economizing time, have made those long terms of apprenticeship in a measure, unnecessary, and to-day men are not CABINET-MAKERS in the sense we have referred to, but they are competent to do either circular-sawing, band-sawing, moulding, or planing, etc., alone, and but little else. This subdivision of labor has been the outgrowth of the advance of invention.

Often you will have among your applicants for work, men who belong to both classes—representatives of the "old school" as it were, and fledgelings who, having rubbed furniture three months in some manufactory, and consider themselves fit subjects for a diploma. It will be found to be advantageous to mix these two elements. Each has claims which are worthy of consideration. The former class, from having been drilled so faithfully in every department of the work; although workmen of this class are apt to be wedded a little too firmly to the methods in use when they were apprentices. Workmen of the latter kind are progressive, and restless under restraint; perhaps a little too much so sometimes. But the two average well, and the

conservatism of the one holds in check the radicalism of the other.

The bench hands, bear in mind, must be men of experience, with this quality more or less extended as the quality of the work may require. In cases where most of the work is machine work, the manufacturer will readily perceive that he can, with advantage to himself, engage the services of a class of men whose knowledge is confined exclusively to the machine they pledge themselves to run. Migratory workmen are a curse to themselves and the manufacturer. They are the best examples of the saying: "A rolling stone gathers no moss."

The close subdivision of work in our best manufactories is conducive to uniform and generally good results, that is, that the tools and machines produced are of equable quality and uniform in build.

The system that includes the individual workman only as the intelligent part of the machinery is admirable as making him an exact reproducing agent, and consequently aiding in uniform results; but it is to be questioned whether it is the best plan to make intelligent practical machines. It may be that possible excellence by it will be sacrificed to tolerable uniformity. Good mechanics of fifty-five years ago have little sympathy with a system that lowers the status of mechanical conditions to the level of the machine attendant, or the monotonous worker at a single branch. This system is

not consonant with the freedom of individual endeavour that seems to be a part of the American mechanics' aspirations.

After all the old-time job shop was about as reasonable a school as the embryo mechanic could desire. The foreman of one of the best known establishments in this country recently died. In conversation long ago he stated that his intimate knowledge of the different departments of the work was got from his experience in a "job shop," where he had a chance at everything, from the lathe to the carving room. He made his own drawings (sketches), and frequently made his own designs. These accomplishments may have been crude, but they gave him the idea of how a job should be done, as well as what was to be accomplished. He was an example of one sort of a practical mechanic, of which there should be more.

Since the grand art movement, of which Victor Hugo's "Notre-Dame de Paris" was the most brilliant expression, the taste for art objects has gradually developed with an intensity almost incredible. The stuffs, the china-ware, and above all the furniture of preceding centuries, are, now that they are old and battered, always sold for prices far higher, because of their excellence of construction and design. In this tendency it would be wrong to see nothing but a single fashion, a mania and an exaggeration, based upon fantasy and imitation; all the men of taste of one nation,



or, we might well say, of all great nations in the world, could not possibly be deceived to this extent, and with this unanimity of their fantasy, had it not a solid and serious basis. And this fashion for antique furniture does not rest upon a very reasonable and very logical foundation,—at first in its disdain for phantom furniture, which, through the perfecting of wood-working machines, has arrived at the last degrees of veneer, scarcely presenting the slightest degree of solidity, the mahogany, oak, walnut, and rose-wood with which they are coated cracking at the slightest shock, and peeling off at the least change in the dampness or dryness of the weather. All the world, too, knows equally well that the homely furniture of thirty years ago, Queen Anne and Eastlake, is equally inelegant in appearance, and uncomfortable in use. There is, then, in the desire of purchasing antique furniture, the just idea of procuring articles altogether solidly built, the form of which is always, if not absolutely conformable to the rules of art, at least entirely different from the veneer articles which, from their nature, can only be subject to very limited number of combinations, and can never furnish to the taste of architects and designers the same resources as solid wood. A longing to escape from the cold and monotonous furniture of the preceding generation added to the renaissance movement of the year of 1800, caused a greedy demand for antique furniture to suddenly arise; but when all of those arti-

cles which had remained sound and solid were sold off, it was necessary to repair, restore, and strengthen those articles which were only discovered in fragments.

While the introduction of machinery had had much to do with changing the character and working methods of the cabinet maker, it has proved a great boon to humanity generally, and has given to the masses, a class of furniture they never could have enjoyed but for the cheaper productions by the aid of power, and machines, and in these remarks, I do not wish to give the impression that machine made furniture is not good, or that it has not a beauty of its own, or that a majority of the designs are not graceful and well adapted to the days in which it was executed. In fact, I am of the belief that woodworking machinery has proved a blessing to both producer and user of cabinet work, while at the same time it has proved almost fatal to the distinctive and individual beauty of artistic handmade furniture.

The object of the writer of this book, is to aid the young cabinet-maker—and the old one too—in obtaining a knowledge of the art from A to Z, and to enable him to take his material from the rough, and work it up until it reaches a finished state ready to take the place for which it was intended. I also purpose reproducing a number of designs of, what was generally considered to be some of the finest examples of furniture, from which the young workman and designer, may absorb inspiration and give to his work a charm

and character to such work as he may undertake to execute, that can never be conveyed to articles made by the machine.

It may be said, and with justice, that there is little or no demand for handmade art furniture, but I am persuaded this condition is occasioned because of the little of it there is in the market, and the very high prices demanded for it by the owners. These high prices are placed on the articles, not by the maker, designer or workman, but by dealers, and the prices are often from four to five times the actual cost of the original work, and are only bought by rich people, whereas, if the prices were normal, the middle classes, whose taste is equal—and often superior—to that of the very rich, would indulge in handmade work to a very much larger extent than they now do.

The bright sharp workman, of whom there are hundreds in our cabinet factories, who have been trained from the lumber yards to the running of the most delicate machinery in the shop, who by a little study, and a little practical work, may soon become able to make and finish furniture—by hand—of the finest sort, furniture too, that will find a ready market if the maker does his best. Many fine pieces of furniture have been made by advanced students after work-hours or during holidays. I have in mind at this writing, a splendid oak side-board, that was made in Newark, N. J., by a young man who was serving some years in a furniture

shop, in that city, as an apprentice. The work was all done by hand, and in a shed in the rear of the house, polishing and all. The sideboard was intended for his father, but a wealthy neighbor of the latter, a man of taste, seeing the work before it was quite completed, offered to buy it, and thus, when finished was sold for the sum of \$280.00. The materials, including mirrors, stained and leaded glass, hardware, and other stuff, all told, cost about \$55.00. When it is considered, the work was done, nearly all after hours, between the fifteenth of October and the end of April, the amount was quite a comfortable addition to the young man's slender yearly salary. But the money gained, was but a fraction of the benefit he derived, as the experience, and the knowledge obtained in making the furniture, were worth to him many times the money he received for it.

Of course, I do not think every apprentice, or even a large percentage of them, could make such pieces of furniture, or find purchasers for them after they were made, but every apprentice or student could make something, that would be useful and ornamental, and have a cash value, besides opening a way for the cultivation of a broader and more exact artistic taste.

Taste was the founder of all our styles in furniture from the prehistoric log stool all the way down through the Egyptian, Babylonian, Chinese, Greek, Roman, Medieval, Byzantine, French, Gothic and the more

modern styles of Chipendale, Shereton, Adams, and our colonial styles, and it is essential that every cabinet-maker who aspires to know his business, should cultivate taste, make himself conversant with the various styles, and be able at a glance to tell to what style, or on what lines any given piece of furniture is intended to represent.

In this connection, I may say, it is proposed to lay before my readers a chapter or two on the various styles of furniture, with illustrations, explanations and some details. It is also intended to offer some instructions for performing such work as gilding, staining, polishing, and finishing the work complete.

There are but a few books of value, on the art of cabinet-making, available to the American reader, though in French, and German, and even in Italian, there are quite a number, but most of their renderings would be of little use to the English or American workman, however, I will try and cull from them, whatever I deem suitable to these pages. The cullings from these works will consist mostly of illustrations, representing some of the best works of French, Italian, and German masters, with such explanations as may be necessary. The only American work, of a real practical nature, that I have any knowledge of is, first, *Cabinet-maker's Companion*, by J. Stokes, published by Henry Carey Baird, Philadelphia, Pa., 1870. This is an excellent little work and contains quite a number of good re-

ceipts on dyeing, staining, and other useful matter. Another book, a still more modern one by Alvan Crocker Nye, Ph. B. and deals nearly altogether with the constructional principle of cabinet-making, but it has little to say regarding the styles or historical peculiarities of furniture. This book is published by Wm. Comstock, New York, and is dated 1900. Some other Manuals are very good in their way, but they are written chiefly for boys who have had little or no experience in woodworking, and who may not intend making Cabinet-making a life work, are suited more for amateur workers rather than for those intending to follow woodworking for a living. These manuals however, will prove useful to every one who intends to work in wood, either professionally or as an amateur.

There have been many essays on the art of furniture making, in our journals and art magazines, but these have generally been of an academic character, with a few exceptions, and have proved but of little service to the practical workman.

A brief history of furniture and its growth, may not be out of place, though I do not purpose going into the subject at great length, so I will devote one illustrated chapter only to it.

## FURNITURE HISTORY.

The first well-known reference to woodwork is to be found in the Book of Genesis in the instructions given to Noah to make an Ark of "Gopher Wood," to make a window, to pitch it within and without with pitch, and to observe definite measurements. From the specific directions thus handed down to us we may gather that mankind had acquired at a very early period of the World's history a knowledge of the different kinds of wood, and the use of the various tools.

We know also, from the various bas-reliefs and papyri to be found in the World's museums, how advanced were the Old Egyptians in the arts of civilization, and that the manufacture of comfortable and even luxurious furniture was well known. It is quite evident the Hebrews must have had the best of workmen for their teachers and taskmasters to have enabled them to acquire sufficient skill and experience to carry out such precise instructions as were given for the building of the ark, and the erection of the Tabernacle, the latter of which was built some 1500 years before Christ—as to the kinds of wood, measurements, ornaments, fastenings (loops and taches), curtains of linen, and coverings of dried skins. We have only to turn for

a moment to the 25th chapter of Exodus to be convinced that all the directions there mentioned were given to a people who had considerable experience in the methods of carrying out work, which must have resulted from some generations of cabinet-makers, carpenters, joiners, weavers, dyers, goldsmiths, and other craftsmen.

A thousand years before Christ, we have those descriptions of the building and fitting by Solomon of the glorious work of his reign, the great temple, and of his own, "the King's house," which gathered from different countries the most skilful artificers of the time, an event which marks an era of advance in the knowledge and skill of those who were thus brought together to do their best work towards carrying out the grand scheme. It is worth while, too, when we are referring to Old Testament information bearing upon the subject, to notice some details of furniture which are given, with their approximate dates as generally accepted, not because there is any particular importance attached to the precise chronology of the events concerned but because, speaking generally, they form landmarks in the history of furniture. One of these is the verse (2 Kings chap. iv) which tells us the contents of the "little chamber in the wall," when Elisha visited the Shunamite, about B. C. 895; and we are told of the preparations for the reception of the prophet: "And let us set for him there a bed and a table and a stool



and a candlestick." Another incident is some 420 years later, when, in the allusion to the grandeur of the Palace of Ahasuerus, we catch a glimpse of Eastern magnificence in the description of the drapery which furnished the apartment: "Where were white, green, and blue hangings, fastened with cords of fine linen and purple, to silver rings and pillars of marble: the beds were of gold and silver, upon a pavement of red and blue and white and black marble." (Esther 1:6).

There are, unfortunately, no trustworthy descriptions of ancient Hebrew furniture. The illustrations in Kitto's Bible, Mr. Henry Soltau's "The Tabernacle, The Priesthood and the Offerings," and other similar books, are apparently drawn from imagination, founded on descriptions in the Old Testament. In these, the "table for shew-bread" is generally represented as having legs partly turned, with the upper portions square, to which rings were attached for the poles by which it was carried. As a nomadic people, their furniture would be but primitive, and we may take it that as the Jews and Assyrians came from the same stock, and spoke the same language, such ornamental furniture as there was would, with the exception of the representations of figures of men or of animals, be of a similar character. At least this is what Litchfield says, and he is no mean authority.

Doubtless prehistoric men made use of stones, logs, or piled-up sods, for seats, and for spots to rest their

heads; the use of stones for pillows being quite common as late as early historic times. Be this as it may however, we find, the Egyptians had chairs, beds, tables and other furniture, some of which was highly wrought and ornamented, at least 4000 years before Christ, as shown by the monuments, and by the papyri that have come down to us. We also possess some fragments of bronze furniture of both Egyptian and Assyrian make.

The British Museum and the Louvre contain a few Egyptian chairs or seats that have been made in ebony and ivory, which owe their preservation to the lasting nature of the material.

Two Egyptian chairs or thrones are illustrated at Figs. 1 and 2, in the first part of this work. At Fig. 3, cabinet-makers are represented as occupied in chair making, the feet and legs of the chairs being designed from animals' limbs, and the stools on which the workmen are sitting are blocks of wood hollowed out at the top. The Egyptian couch was of a straight-lined design in the body with a curved head like an ordinary sofa, the legs, feet and other salient points being carved with heads, feet and tails of animals.

Some boxes and coffers with gable tops dovetailed together, small toilet boxes having carved or painted decoration, and Mummy cases of cedar-wood having elaborate hieroglyphic decorations, may be seen in the British Museum and in the Louvre. Chariot and horse furniture are well represented in the reliefs and wall

paintings. Egypt was famed for chariot building, and exported them in trade to the surrounding nations. We read that King Solomon imported his war-chariots from Egypt.

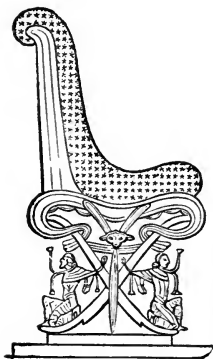

Figure 1



Figure 2

If examples of Egyptian furniture are scarce, the furniture of Assyria is practically non-existent, as the climate of the latter country was not so dry or preservative as that of Egypt, so that all examples that have not been wilfully destroyed have long ago perished. Many ornaments of bronze and of ivory decorations have been discovered that have been used as mountings to feet, ends of legs of seats, chairs, or thrones. The

bas-reliefs of the latter enables us to form a fairly accurate judgment of the nature and style of Assyrian furniture, the decoration of which was of a heavier and coarser character than that of the more elegant Egyptian (Fig. 4 and 5). Forms and parts of animals

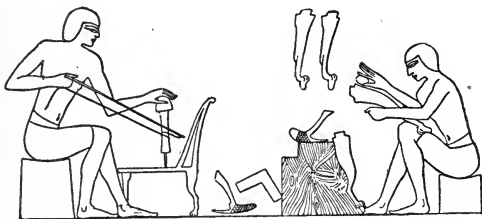

Figure 3

were used by the Assyrians and nearly all Oriental nations as furniture decorations. The human figure was also used, but generally in the representation of slaves or conquered peoples, who were degraded to the position of bearing the weight of the seat or throne of the monarch. The Egyptian chairs had also carved human figures as captives tied under the seat.

The furniture of the Hebrews was doubtless of the same kind as the Assyrian. From the description of King Solomon's throne it was apparently similar to those of the Assyrian kings. It had lions for the arm supports, and had six lions in gold and ivory on the six steps on either side of the throne.

In the manufacture of the furniture of the nations of antiquity the principal materials were—in woods, ebony, rosewood, walnut, pine, teak, and, above all, cedar-wood; ivory, gold, silver, bronze, and electrum were also much used for inlays and for solid mountings.

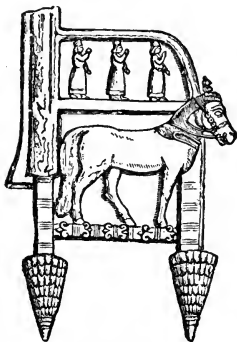

Figure 4

(Figs. 8, 9 and 10); couches resembling modern sofas, elaborate foot-stools, and arm-chairs with the sphinxes for the arms were made by the Greeks.

In the British Museum are some small models of Greek chairs made in lead, and wooden boxes showing the dovetail construction.

In the later Greek periods the furniture was inlaid with ivory, ebony, gold, and silver. Tripods were made of bronze, and had ornamented legs in the shapes of the limbs of lions, leopards, and sphinxes. The Roman bronze tripods were very similar to the Grecian ones

The furniture and the chariots of the Greeks in their early period were simply copied from Egyptian and Asiatic sources, with less of the animal forms and more of plant forms as decorative details (Figs. 6, 7). Folding stools and chairs were made in wood and in metal and the backs of the chairs were upright, or nearly so

in design, and were not only used for sacred purposes in the temples, but also to support braziers for heating purposes, or for burning perfumes in the houses of private people (Fig. 10).

Hand-mirrors and cistae were made in great quantities in bronze or in other metal alloys, in silver, and

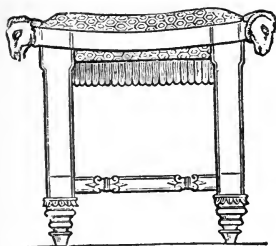

Figure 6

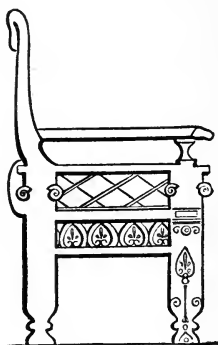

Figure 5

sometimes in gold. The mirrors were polished on the face, and had often rich designs of figure subjects. The Greek cistae were cylindrical metal boxes that rested on feet designed from those of various animals, having a lid or cover, with a handle or knot usually of figure design, the whole surface of the body being covered with engraved figure compositions and ornamental borders. They were probably used to contain jewelry

and trinkets. Some very fine specimens of these hand-mirrors and cistae may be seen in the British Museum.

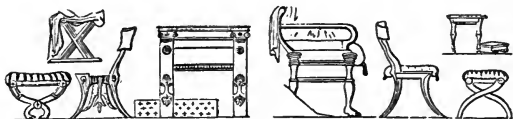

Figure 7

The furnishing of the houses of the Romans was very much of the same character as that of the Greeks



Figure 8



Figure 9



Figure 10

and Etruscans, from whom the Romans inherited all their arts.

The interior plan and aspects of the Roman houses were such as those of Pompeii and Herculaneum. Tables and tripods of bronze or braziers were supported

on three legs, some of which were made with hinges for folding purposes (Fig. 11), and others were of sphinx and animal forms of a rich design (Fig. 12). Lamp-stand designs were quaint and elegant and were



Figure 11

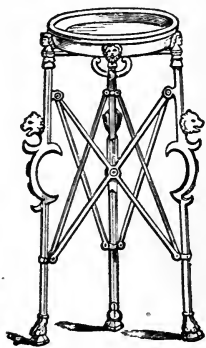

Figure 12

made in bronze (Fig. 13). Candelabra of architectural design were carved in marble and were from six to ten feet in height (Fig. 15).

The Romans highly prized and paid good sums for tables that were made from the pollard cross grain of different hard woods in which the knots and grain showed to advantage, the beauty of the wood being brought out by hand-polishing and by the staining it



with various colored dyes. Bird's eye maple and the wood of the *cedrus atlantica* were much prized. The smaller tables, abaci, rested usually on one foot—monopodium—and larger tables had three or four legs,

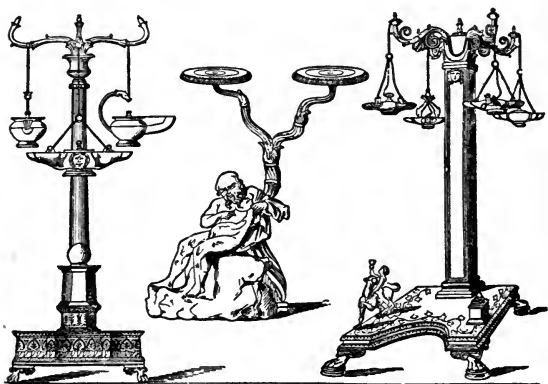

Figure 13

which had ivory claws or heads of animals as carved decoration (Fig. 14). Boxwood, beech, and palm, inlaid with ivory, ebony, and precious metals, were used in the materials of chairs and couches. The latter were often made in bronze (Figs. 15 and 16), and chairs of state were carved in marble, one of this kind being in the Louvre, a cast of which is now in the Kensington Museum (Fig. 17). The form of the Roman curule chair was like the letter X, and was so called because it

could be folded and carried easily in the curules or chariots. It was used from the earliest times of the Romans down to modern days in Italy, and was often constructed of elephants' tusks, wood, or metal, with ivory feet. The curule chairs were carried about for outdoor use and for the theatre. The sella or bisellium,

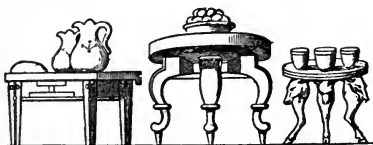

Figure 14

to seat two persons, was often a very ornate kind of seat with turned legs similar to the couches (Fig. 18).

In the houses of the Romans a separate room or wardrobe was fitted up to keep the dresses and cloths of the family; this room had cupboards with doors and shelves, drawers, and lockers.

Portable coffers and chests were used, in which they packed their cloths and valuables when carrying them to and from their town and country houses. The Roman furniture and wooden construction of their houses were decorated with paintings and carvings of animals' heads, limbs, and feet, and with the usual architectural acanthus foliage—veneering of woods was an art in which the Romans were skilled; both large and small design in Tazsia work were the chief decorations of the best furniture.

The representations we have of what was used by the Egyptians, the Greeks, and the Romans, are those only of the most finished and tasteful specimens; and, consequently, materials do not exist for the formation of a chronological series. But if we examine such as are of subsequent date in Europe, the reply will be found amply to repay the trouble.

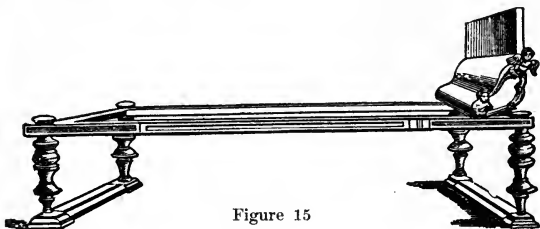

Figure 15

In endeavoring to obtain some little insight into the forms and materials of the furniture of ancient times, we are dependent on different sources, according to the country under consideration. If it be ancient Rome or Greece, the descriptions by the classical writers and the paintings at Pompeii are our chief authorities; if ancient Egypt, the paintings on the walls at Thebes and other places; if in China or India, or Asia generally, the specimens still existing, for the Asiatics are more stationary in their usages than the inhabitants of any other quarter of the globe. Footstools seemed to have formed part of the furniture of a sitting-room;

they were made both solid and open at the sides, and were covered at the top with leather or interlaced string.

The distinction between a bed and a couch does not seem to have been very clearly marked. They had couches of wood with one end raised and receding in a graceful curve, with feet fashioned to resemble those of some wild animal. It is supposed that those couches had a rich covering by day and bedding by night. The use of wooden pillows was customary; they were made of various materials, according to the rank of the possessor, and had a singular kind of cavity in which the head or the back of the neck might rest. Wicker bedsteads were sometimes made of palm-branches, forming a light kind of grating on which the bed and bedding were placed. The tables used were of various forms—round, square and oblong. At repasts the dining-table was generally circu-



Figure 16

lar, and supported by a central pillar, which was often the figure of a man as a captive. Other tables had three or four legs, and the material of the tables themselves, though generally wood, was sometimes metal or stone.

It is curious to remark that Egypt exhibited, three or four thousand years ago, articles of furniture bearing a much closer resemblance to those of modern Europe than Egypt does at the present day. The chairs of the early times might in many cases be readily mistaken for those now in use among ourselves; whereas the divans and cushions of modern Egypt, on which the natives indolently recline, belong to the oriental system of furniture. In Cairo no chambers are furnished as bed-rooms. The bed, in the day-time, is rolled up and placed on one side, or in an adjoining closet, which is a sleeping-place in the winter. In summer many persons sleep upon the house-tops. The furniture of a room is comprised pretty nearly by the mat or carpet spread upon the floor, and the divans or cushioned couches. For meals a round tray is brought in and placed upon a low stool, and the company sit round it on the ground. There is no fire-place, the room being warmed when necessary by charcoal burning in a chafing-dish.

Passing from Egypt to China, we find, in treating of the furniture of a room, as in many other matters, how singularly isolated the Chinese are from the other

nations of Asia, and how much more closely they resemble Europeans. The Chinese are the only Asiatic

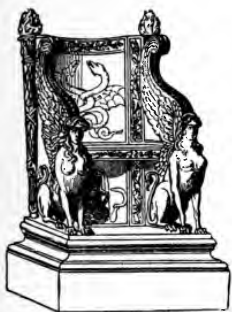

Figure 17

people who customarily use chairs; they resemble the solid and heavy chairs in fashion during the early part of the 18th century; (see illustration of Chinese chair). The seat of the chair has often a cushion, and the back a hanging of scarlet silk or woolen embroidered with silk. In the forms of their furniture the Chinese generally

avoid straight and uniform lines; even in their doorways, instead of a regular right-angled opening, they often have one presenting the form of a circle, or an oval, or a leaf, or a jar. These fanciful doorways, however, are only used when there are no doors, the opening being covered with hanging screens of silk or cloth, or with bamboo blinds, like those used in India. The Chinese beds are generally simple in form, with cotton or silk curtains in winter, and a fine mosquito-screen during the heat of summer; the bed of an individual among the middle classes usually consists of two or three boards laid upon a couple of narrow benches, a mat to lie upon, and four bamboo-sticks to support the mosquito-curtains. It may readily be sup-

posed that in the original country of porcelain a very usual ornament of dwellings consists in vases and jars of that material, of which the antiquity is valued above

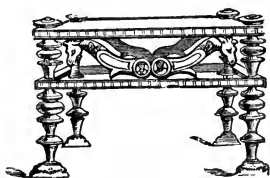

Figure 18

every other quality. This taste has led to the manufacture of fictitious antiques, not only in porcelain, but in bronze and other substances—points in which strangers are often very egregiously

taken in at Canton. The shapes of their tripods and other ancient vessels, real or imitated, are often fantastical, and not unlike similar vestiges in Europe.

The furniture, such as tables, chairs, beds, and the chariots of the Byzantine period, was like the architecture in having something of the classic Roman mixture with some Asiatic Greek forms in its design. Scarcely any remains of such are now in existence, although we have evidences of the extreme richness of the sumptuary furniture and vessels of the great houses and palaces of Constantinople, for owing to the decadence and destruction of the Roman empire in the provinces, the capital of the East became enriched by treasures of the Roman families, who naturally fled to Constantinople for protection for themselves and their valuable effects.

The old ivories known as consular diptychs have

different varieties of seats, chairs, and footstools, on which the consuls are seated, represented in the carving. Many originals of these and casts from others, are now in the Kensington Museum, London.

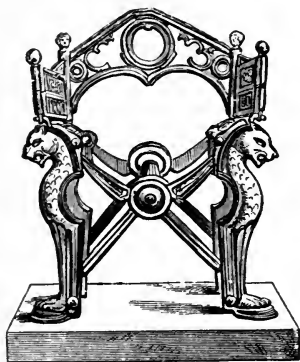

Figure 19

The chair of St. Maximian, preserved at Ravenna, is covered with ivory carvings, and is one of the finest examples of Byzantine work.

Much of the furniture of the early centuries of Christian art is represented in the Byzantine illuminated manuscripts. Beds and couches kept the old Roman forms with the turned legs. Chariots must have been used very much, as the old game of chariot racing was kept up by the Byzantines. The Iconoclasts of the Eastern Empire under Leo the Isaurian (A. D. 726)—



whose injurious rule lasted about one hundred and twenty years—were responsible for much destruction



Figure 20

of sumptuary furniture, as well as for other productions of an artistic nature, but at the same time they were the indirect means of causing a new development in art in the western parts of Europe, and more particularly in

the Rhenish Provinces, by driving the Byzantine artists and craftsmen to these places, where they were welcomed by Charlemagne, and by his powerful nobles and churchmen. In the course of time they succeeded in founding the school of art known as Rhenish-Byzantine. The finest illustrations of this art are seen in the magnificent enamelled reliquaries or shrines. The gilt-bronze chair of Dagobert is of Romanesque design, and is one of the earliest pieces of furniture of the Middle Ages (see Fig. 19). Another mediaeval chair or throne is high seated, and exceedingly rich in design (Fig. 20). It is of Scandinavian origin, and is a good example of the Romanesque style of Northern Europe. Many forms of the Romanesque are seen in the furniture and carving of the Gothic style that immediately succeeded the former.

During the Anglo-Saxon period in England the ordinary houses usually consisted of one room. Sometimes a shed-like structure was erected against the wall of the room to contain the bed of the mistress of the house, and as a rule the inmates slept on a large table placed in the center of the room, or on benches on which bags of straw were placed. Seats without backs, or stools, long settles or benches with backs and carved ends or arms, were the chief articles in furniture.

After the Norman Conquest domestic improvements were multiplied, more rooms were added to the houses, such as the solar or upper room, and the parlor or

talking room, and some of the rooms had fireplaces, but not chimneys. The principal room was the hall or assembly-room, which had a fireplace in the center, the smoke escaping through the lantern light in the roof.

In the Norman times the principal additions to the furniture of English manor-houses and castles were the cupboard, presses or armoires, and chests. These pieces



Figure 21

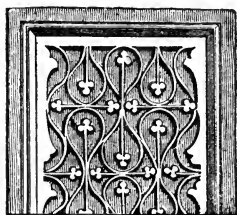

Figure 22

of furniture were introduced from France. Sometimes the portable presses and the chests were painted with tempera decorations, and were bound with wrought-iron clasps and hinges, which were just beginning to come into use.

The bed-clothes and personal clothing of the nobles and rich landowners began to assume a rich character, and were often embroidered.

Tapestry and painted cloth hangings were imported; also pottery of an ornamental description was not only imported, but made in England at this time. All this

applies to the homes of the rich only, for the poorer classes remained for a long period in a very primitive condition as regards their style of houses and their furniture.

The construction of furniture and the panelling of chests began to exhibit some workmanlike appearances



Figure 23

of good carpentry. Panels were placed in framework that was mortised and fastened with wooden pegs, which became the universal method of panelling throughout the Gothic period. Room paneling came into use in England in the early part of the thirteenth century, when pine timber was used at first for this work, but was displaced later by the more substantial oak. This oak panelling during the Gothic periods was often carved with elaborate tracery of an architectural character (Figs. 21, 22), and a common design was a carved imitation of a carefully folded textile, known as the "linen panel" (Fig. 23).

Chests were used as tables, and the tops had inlaid checkers to be used as chessboards. They were also used as sideboards on which to place dishes of food, the dining-table being a board which was placed on trestles, that could be removed and packed away when not required (Figs. 24, 25). A crossed-legged chair and a three-legged stool is shown at Fig. 27, which

were common shapes in the fourteenth century. The illustration, Fig. 26, is that of a bedroom of the same

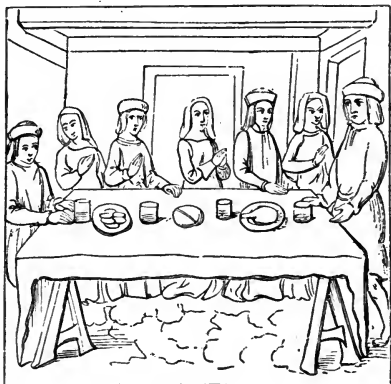

Figure 24

period, and is taken from an English manuscript of the date of 1400. For these illustrations, and many others

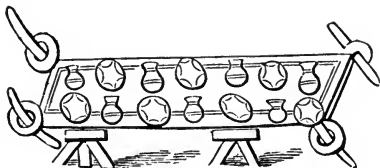

Figure 25

on the subject of furniture, we are indebted to the work of Mr. J. H. Pollen on "Furniture and Woodwork."

The bed in the latter illustration has a flat canopy, or tester, with embroidered hangings. The walls of the room are panelled, and the floor is in checkered par-



Figure 26

quetry. There is a curious seat that is partly an open press, with pottery, and metal vases placed as decoration on the top.

Chests, trunks, or baluts, were at this period, and in the time of the Normans, the most important articles in furniture; they were often made with inlaid wood decorations, and had strapwork of iron and ornate

hinges. They were the usual repositories of the household valuables, money, and other treasures, and were carried on horses or mules when the family moved about from place to place. By degrees the chest, with the addition of a back and arms, became the settles or principal seats in the living-room, and the back developed with an added hood or projecting covering into

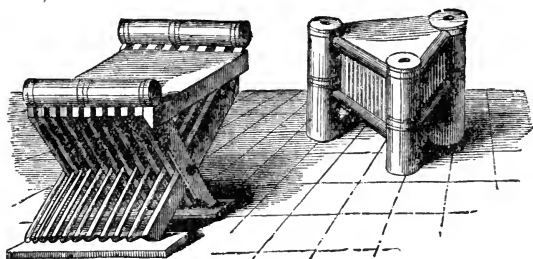

Figure 27

the dais, or throne-like seat, that was placed at the end of the chief room—the place of honor.

Another and later development of the chest was to raise it on legs, and to add a back arrangement to it, with shelves for the display of household plate, to which was given the name of *dressoir*, or *dresser*, the latter in time developing into the modern sideboard.

Chests were also important articles of church furniture, in which the sacred vessels, treasures, books, and priests' garments could be locked up, and a particular

form of chest kept in church vestries was the cope chest, which took the semicircular shape of the copes when laid out flat in these chests. Examples of these chests are still to be seen in some of the larger cathedrals.

The coronation chair (Fig. 28) gives a good idea of a state chair of the early Gothic period in England.

Carriages of the fourteenth century were used for the conveyance of women and children, but were not very common. They were long-shaped covered vehicles on four wheels, with or without paneled sides, and were painted and decorated (Figs. 29, 30). Carts for carrying and for agricultural purposes were used in the Anglo-Saxon and Norman periods in England, and in France at the same dates; these were two-wheeled vehicles, each being usually of one solid piece of wood.

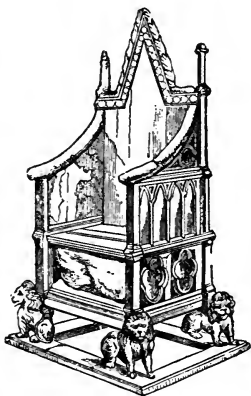

Figure 28

The Saracens were very ingenious in the using of wood, as in carpentry, carving, and turning in the lathe. Their ingenuity and skill in carpentry and turning is seen in the Meshrebiya work and lattice, and in the carvings of the pulpit and door panels.



Regarding the furniture of the domestic dwellings of the Saracens, whether of Egypt, Arabia, or elsewhere, there was very little of a movable nature except the small tables and reading-desks. The tables of Saracenic design are usually small and of a greater height than width (Fig. 31). These tables or kursys are sometimes panelled with turned, latticed, or carved decoration, having stalactites under the top, as in the illustration,



Figure 29

or in the kursys of a lighter construction are generally inlaid with ivory, ebony, and mother-of-pearl. Some of the richest variety are hexagonal in shape, are inlaid with brass and silver filigree ornamentation, and are of splendid workmanship. The next important article in movable furniture is the Saracen reading-desk, which is made in the form of a camp-stool, with cross legs. It is usually inlaid and decorated like the tables.

The divans are platforms raised slightly from the ground, and covered with cushions on the seats and backs. The carved cupboards or shelves on brackets

placed behind and above the divans, on which vases and trays are kept for ornament or when not in use, complete the usual furniture of the Saracenic living-room. Seats or chairs or lattice-work (*dikkas*), on



Figure 30

which the doorkeeper sits, are usually found in entrance-halls, and if we add the elaborate metal and colored-glass lamps, the vases, the large metal salvers or trays, and the rugs and carpets, the furniture of a Saracenic house is complete.



Figure 31

## ITALIAN AND OTHER FURNITURE OF THE RENAISSANCE.

In the early part of the fifteenth century and during the whole of the century the furniture of Europe generally was designed more or less on Gothic lines, but gradually the new forms that were now rapidly developing in the architecture of the Renaissance, but in a slower measure, began to assert themselves in furniture designs. Consequently, we find in many articles, such as armoires or presses, and cabinets, a mixture of style in the design—as, for instance, the upper panels would be in the Mediaeval, and the lower ones in the Renaissance style, or the general construction would be Gothic, and the details and decoration would be Italian.

This was more often the case in the furniture and other art in Germany, where the Renaissance was tardily welcomed.

Styles of design in furniture overlap each other so much, especially in the Renaissance period, that it became very difficult to assign a correct date to many pieces of important work. Gothic designs continued to be used during the sixteenth century, although the Renaissance had been developing for a hundred years

earlier. The most authentic means of fixing the date is when certain work can be proved to have come from the hand of a particular artist, or when there is a record of its having been made for a king or some great person, for the style is not always a sure proof of the correct date.

In the "Quattrocento" period (1400-1500), or fifteenth century, Italian furniture made for churches, palaces, or private houses, was usually decorated with paintings, sometimes on a gilt ground, which was prepared in a gesso material before the gold was applied, some parts of which had relief ornamentation.

Reliquaries, altar-fronts, panels or cabinets, chests, and marriage coffer were decorated in this way.

The work known as "tarsia," or certosina work, was made in great perfection about this time in Italy. It is inlaid work of a geometric character in design, or is composed of floral ornament, and sometimes consists of representations of landscapes and buildings. This kind of inlay derived from Persian sources, was developed chiefly by the Venetians, and was used mostly by them in the decoration of their stalls, tables, chairs, cabinets, &c. Ebony, ivory, and metals were also employed in the Italian inlays of this period.

The Italian cassoni, or marriage coffer, were the most ornate and most imposing articles of furniture of the fifteenth and sixteenth centuries. They were placed in the long halls and corridors of the palaces and great

houses, and were usually given as presents to newly married couples. They were generally used as the receptacle for the bride's trousseau and other treasures. In the latter century they were carved in walnut with sculptural mythological subjects, and had endings or corners of half-figures and half-foilage, as caryatids,



Figure 32

with feet designed from the claws of animals to raise them from the ground (Fig. 32). The carving was relieved by gilding in parts, and sometimes the whole of it was gilt.

Other examples of an earlier date were covered with a finely modelled decoration of gesso work, and gilded, and in other cases the large panels in the front were painted with figure subjects in brilliant colors and heightened with gold.

A less costly kind of marriage coffer was made in cypress-wood, and fitted up in the inside with drawers, having the decoration on the surface engraved or etched

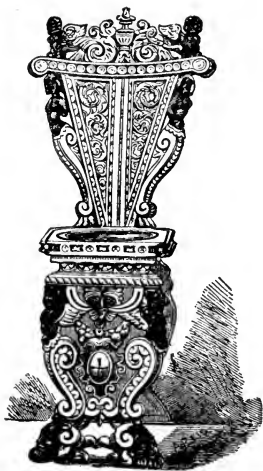

Figure 33



Figure 34

in brown lines, with the ground slightly recessed and punched or stamped with a fine ornamentation.

In the Kensington Museum there is an extensive collection of Italian cassoni embracing all the above varieties. Chairs carved and gilt of the same style and period as the coffers were usually placed between the rows of the latter in the halls of the Italian palaces (Fig. 33). These chairs had their backs and legs richly carved, each part being made out of a single slab of wood.

The pair of bellows (Fig. 34) is a further illustration of the design and excellence of workmanship as shown in the work of the wood carvers of Italy in the sixteenth century, or "Cinquecento" period.

Another fine specimen of wood carving is the Italian stool (Fig. 35) of the same date, which is remarkable for its delicacy of treatment.

Another form of chair of a rectangular character, with or without arms, having an embossed leather or velvet covering on the back and seat, with turned and carved legs and rails, was made in Italy about this time (Fig. 36); it was much used subsequently in Spain, France, and in England, and has continued to be in favor down to the present day.

Cabinets were made in Italy and in France in which slabs of beautifully colored and veined marbles and rare stones were inserted as panels in various shapes, to which the name of "pietradura" work was given.



In the seventeenth and eighteenth centuries painted plaques of porcelain took the place of these marbles.

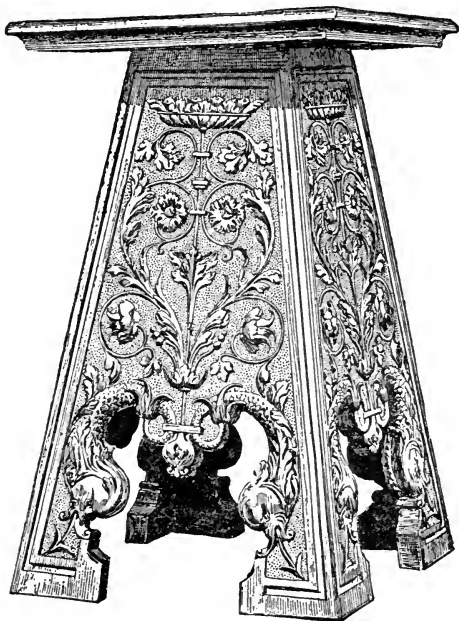

Figure 35

In England, France, Spain, and Germany, the great houses, both private and religious, and the king's palaces were elaborately furnished, and kept in a state of great splendor.

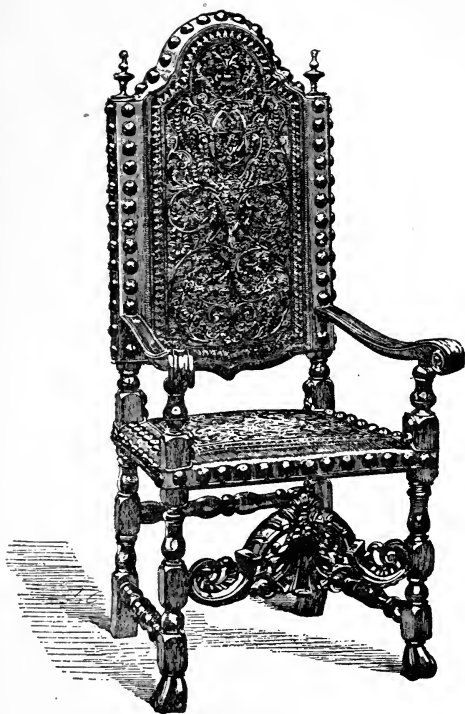

Figure 36

Churches were also furnished with elaborate stalls, pulpits, and rich utensils, but in the latter the style of the designs was still Mediaeval.

In the reigns of Henry VII. and Henry VIII. in England the style gradually altered to the Italian forms of the Renaissance, and great quantities of Italian, Flemish, and French furniture were largely imported. Jean de Mabuse and Torrigiano were employed as architects and sculptors by Henry VII., and Holbein and some Italian artists designed furniture and goldsmith's work for Henry VIII.

In France, during the reigns of Francois I., Catherine de Medici, and Henry II., a great activity took place in architecture and in all the industrial arts, in which that country was not only imitated, but sought to excel, the work of the Italian schools.

As already mentioned, the French kings and Medicean princesses in the sixteenth century had invited from Italy Cellini, Primaticcio, Il Rosso, Serlio, and others, who succeeded in founding the style of the Renaissance in France, and about the same time many French artists journeyed to Italy to acquire the newer style which had been evolved from the study of the old classic remains of that country. Among the names of the principal French artists, sculptors, and carvers of this period are those of Jean Goujon, Nicholas Bachelier of Toulouse, Jean Cousin, Germain Pilon, Philibert de L'Orme, Du Cerceau, who published

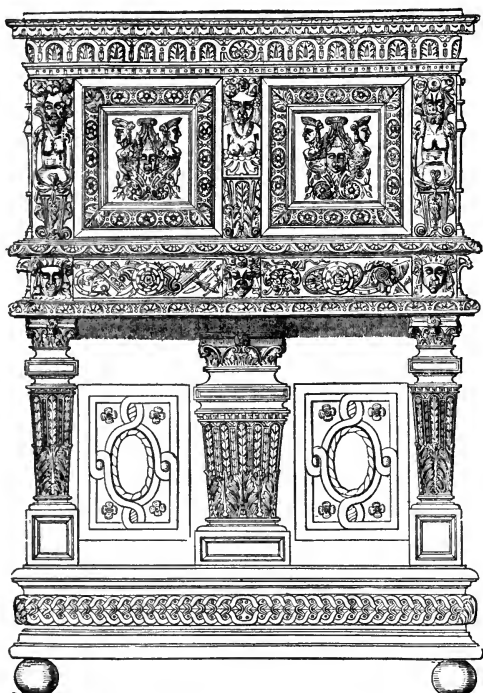

©.MATEAUX.24

Figure 37

designs for all kinds of decorations and carvings, and Hugues Sambin of Dijon. Most of these men were



Figure 38

architects and also designers of the heavy and rich furniture that was characteristic of the French Renaissance. Some of these artists and their works have been noticed in the chapters on Renaissance architecture and metal work. The cabinet (Fig. 37) is a good example of the architecturic style of French furniture of the sixteenth century. French wood carving is distinguished from the Italian of this period by the great use of the cartouche and strap-work (Fig. 38), which was so characteristic of the Henri-Deux style.

architects and also designers of the heavy and rich furniture that was characteristic of the French Renaissance. Some of these artists and their works have been noticed in the chapters on Renaissance architecture and metal work. The cabinet (Fig. 37) is a good example of the architecturic style of French furniture of the sixteenth century. French wood carving is distinguished from the

When the Renaissance had taken a firm root in Germany, the designers and carvers of altar-pieces and of furniture generally proved themselves thorough masters of the style, and were especially skilful in the carving of wood, both on a gigantic and on a minute scale. Whole fronts of houses were elaborately carved in designs consisting of figure work, animals, ornament, and grotesques of a quaint and humorous description, while exceedingly minute works of figure subjects and animals were carved in box and other woods with a delicacy and quaintness often excelling the ivory carvings of the Japanese. Escritaires, buffets, cabinets, and other furniture, were made and exported from Germany into Spain and other countries.

Flemish and English furniture and carving were pretty much alike in the reigns of Elizabeth—the Tudor period of English art—and of James I., the Stuart of Jacobean. The pieces of carved furniture, both Flemish and English, were very solid and heavy both in the design and thickness of material, which was generally of oak or chestnut. So much Flemish furniture was imported into England at this time, and the English-made work, being so close in resemblance to the former, that a great difficulty is experienced in classifying examples of this period. The table, Fig. 39, and the so-called "Great Bed of Ware," are examples of the furniture of the Elizabethan period (Fig. 40).

In Spain the Italian style in furniture was intro-

duced in the first instance by the great importations from Italy and Germany, but under such excellent native carvers and designers as Felipe de Borgona (six-

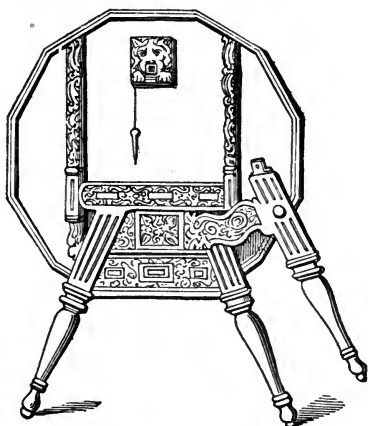

Figure 39 .

teenth century), and Berruguete (1480-1561), the style of the Renaissance soon spread from Toledo to Seville and Valladolid, where great quantities of carved and inlaid work and elaborate altar-pieces were executed during the prosperous Spanish period of the sixteenth century.

During the same century Venice and Florence were famed for their marquetry—inlaid work of ivory and metal—in cypress, walnut, and other woods, which art

had been imported from Persia and India by the Venetians, and which spread rapidly through Europe until the furniture made with marquetry decoration by degrees supplanted the heavier classical architectural designs.

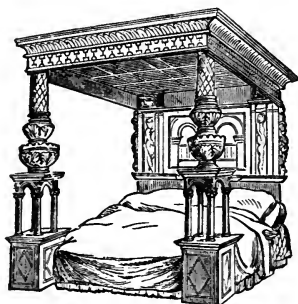

Figure 40

Before leaving the Italian sixteenth-century work we must notice the mirrors, with their elaborately carved frames of Venetian design and manufacture. In this century Venice was renowned for the making of glass, for which it is still famous, and certain privileges were granted by the State exclusively to Venetian manufacturers of looking-glasses. Two Murano glass makers named Andrea and Dominico, who were the inventors, were granted in the year 1507 the sole privilege of making "mirrors of crystal glass" for a term of twenty years. Previous to this time the mirrors



were made of various polished metals. The frames of the Venetian mirrors were often elaborately carved (Fig. 41), some of them being made in designs that were strictly architectural in character, representing a door, or window frame, with pilasters frieze, and cornice and sill or plinth. These carved frames were often part or wholly gilt, and were exported in considerable quantities. Pictures were framed in a similar way to the mirrors, and carved and gilt frames were soon used all over Europe as picture frames. Later on gilt furniture of all kinds was made in Venice and was in great favor in the other countries of the Continent.

The manufacture of marquetry furniture by the Dutch in the seventeenth century has been mentioned as having helped in a great measure to change the style of furniture design from its former architectural character to a greater simplicity of construction. Large panel surfaces were used for the purpose of showing to greater advantage the rich and bright colors of different kinds of hard woods used in the marquetry. Both natural and stained varieties of various wood were arranged in the designs in juxtaposition, and a free and picturesque kind of ornamental foliage was employed mixed with large tulips, roses, and birds in the Dutch marquetry decoration. Other materials such as ivory, ebony, and mother-of-pearl, were also used as inlays. In France a similar kind of marquetry

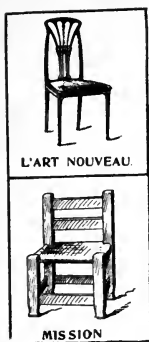

was developed, but the design consisted more of figure subjects and imitations of ruins in landscapes. A complete change in the design of the furniture in the latter country was also effected by the same desire to get large surface on which the inlaid work could be seen to great advantage, and the spaces were not divided by architectural mouldings, and the pilasters, as they had been in the preceding earlier work.

Towards the end of the sixteenth century, and during the earlier half of the seventeenth, the sumptuous furniture, the beds, and general furnishing of the better class of houses and palaces in France and other European countries, were characterized by the use of costly silk brocades, tissues, and embroidered coverings and hangings.

By thus seeking to give the furniture an appearance of the richest possible kind, such articles as chairs, couches, and beds lost in a corresponding degree their elegance and former constructive beauty. Under their gorgeous Italian and Oriental velvet coverings, their framed construction ceased to be visible. The above pieces of furniture still retained their sumptuous upholstery during the reign of Louis XIV., but the tables, armoires, cabinets, book-cases, pedestals, clock-stands

and cases, came under the influence of the architecture of the period, when the king's chief minister, Colbert, selected the best architects and cabinet-makers of the day to design the furniture for the palaces of the Tuileries, the Louvre, and Fontainebleau.

The greatest name connected with the design and manufacture of the magnificent furniture of the Louis-

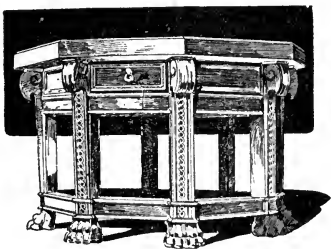

An Old Italian Table

Quatorze period is that of Andre-Charles Boulle, whose work is known under his name as "Boulle." This celebrated furniture is an elaborate kind of marquetry of which the materials are rare woods, ebony, tortoise-shell, brass, mother-of-pearl, and white metal or tin. The mountings, mouldings, and other salient points are made in brass beautifully chased and finished, some of the mouldings being in the forms of masks, foliage, cartouches, and animals' heads and feet as termination.

Andre-Charles Boulle was born in Paris in the year

1642. His father, Pierre Boulle was also a distinguished ebeniste, or cabinet-maker, but his more eminent son possessed the artistic gift in a much higher degree. In addition to making his special marquetry from his own designs Boulle also executed a good deal of his best works from the design of Jean Berain (1636-1711), his chief collaborateur. Berain's designs were more Italian in style, more symmetrical in the composition of the ornament, and more correct from an architectural point of view, than those attributed to Boulle himself, whose designs had much of the looseness and freedom of the prevalent Louis Quatorze.

At the death of Jean Mace, the king's ebeniste, in 1672, who had formerly lived in the royal galleries of the Louvre, the logement and office of ebeniste to the king had become vacant, and Boulle on the recommendation of Colbert, minister to Louis XIV., was appointed as the successor of Mace, and was installed in his rooms in the Louvre in the year 1673. He had previously executed some important work for the king, and was known as the ablest ebeniste at that time in Paris.

The origin of the Boulle marquetry can be traced to the Indian, Persian, and Damascus encrusted inlays in ivory, ebony, and metal, that found their way to Venice, Portugal, Spain, and France in the Middle Ages. These works consisted chiefly of caskets, coffers, and small pieces of furniture. In the inventories of

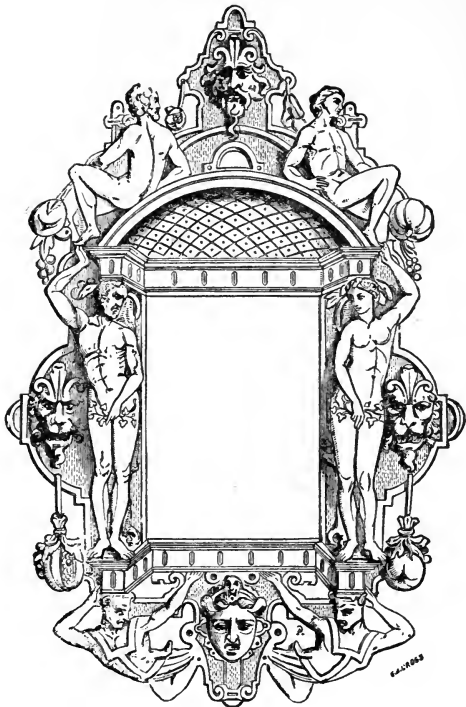

Figure 41

Charles V. of France (1380) mention is made of lecterns and coffer of inlaid ivory or bone, in ebony, and similar works are mentioned in the inventories of Charles VI. (1418), and of Anne of Brittany (1498). These are the earliest notices of marquetry furniture that was made in France, and was probably an imitation of Oriental work.

In the Renaissance period Francois I. bought some magnificent furniture of Indian workmanship, inlaid with mother-of-pearl, from Portuguese merchants, and mention is made of chairs, tables, coffer, cabinets, and mirror-frames that belonged to Queen Marie de Medicis (1600), the Cardinal d'Amboise (1500), and other great persons of the French Court, all of which works were made in marquetry.

In France before the sixteenth century, tortoise-shell, brass, tin, and exotic woods were used as inlays, in addition to the ivory, ebony, and nacre of the East. From this it will be seen that Boulle did not invent the celebrated marquetry that bears his name. He, however, brought this sumptuous form of cabinet work to great perfection, and under the patronage of Louis XIV. he had every opportunity to develop his artistic abilities to the utmost.

The method of procedure in the making of the Boulle marquetry was, first, to prepare the veneers of wood, shell, tin, and brass of the same thickness, each having perfectly plain surfaces; these veneers were

then glued together in pairs of opposite materials, according to the nature of the effect required in the



Figure 42

finished work, and were held together firmly in a vice. The design was then traced on the surface of the upper leaf, and the veneers were then cut through the lines of

the pattern with a burin, a sharp strong knife, or a fine saw; thus four pieces of marquetry were made at one cutting. When the plaque forming the design was composed of tin or brass, which was afterwards engraved or chased, it was technically called "boulle"; and when the design was formed by the shell or ebony it was called "counter"; the two effects are together known as "boulle and counter" or *premiere et contrepartie*.

A later kind of Boulle work, known as the Second Style, has the shell veneers laid on a clouded vermilion or on a gilt ground.

Boulle was an artist of great excellence as a sculptor and chaser of metals; his mountings of foliage and masks which decorated his works are spirited in design and are skilfully chased and finished (Fig. 42). He executed a great number of costly pieces of his famous marquetry for Louis XIV. and the Dauphin of France, many of which found their way to England a century later. Examples of Boulle work fetch great prices when, as on rare occasions, they make their appearance in a sale.

In Germany in the seventeenth century, the most prominent names as designers and makers of furniture are Philip Heinhofer, Baumgartner, and Hans Schwanhard. The former was the maker of the celebrated Pomeranian Cabinet (1611-1617) which is now in the Royal Museum at Berlin.



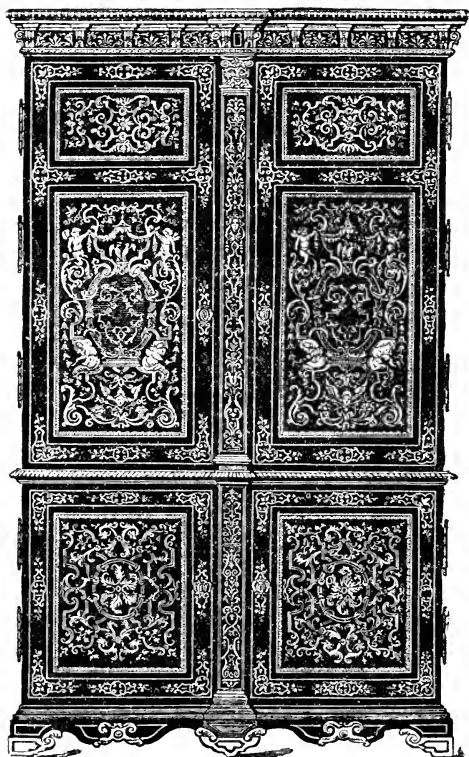

Figure 43

In this century, in Italy, Andrea Brustolone (1670-1732) was noted as a carver, gilder, and cabinet-maker who worked in the extravagant style of the Louis Quinze (Louis XV.), and in the first half of the



Figure 44

eighteenth century (1700-77) Pifetti, a Piedmontese cabinet-maker, was honored by the Italian Court, for which he executed many works in ivory carving and marquetry work in the style of Boulle. Many other cabinet-makers and carvers were employed to make furniture and to decorate the queen's palace at Turin, among whom may be mentioned the names of Galleti, the successor of Pifetti, and Maggiolino of Milan, who

chiefly made a kind of marquetry in light woods. We are indebted to Mr. J. H. Pollen's handbook on furniture for some of these names, and a list of many others will be found at the end of his useful book.

The French architect, Le Pantre (1617-82), designed furniture and decoration in the heavy classical style of the Roman antique, mixed with shell-work, grotesques, and little Cupids or "putti," and also engraved and published a book of studies of Roman ornament from sketches that his master, Adam Phillipon, had made in Italy. He worked with Le Brun, the painter and director of the decoration at Versailles. Le Brun's own work was heavy and dull, although he aimed at grandeur and gorgeousness of effect. He was director of the Gobelins tapestry manufactory, and his style of work was in harmony with the pompous ideas of Louis the "Grand Monarch." Madame de Maintenon says in one of her letters to a friend, that Louis was so fond of symmetry and stateliness in his architecture, as in other things, that he would have you "perish in his symmetry," for he caused his doors and windows to be constructed in pairs opposite to one another, which gave to everybody who lived in his palaces their death of cold by draughts of air.

In this century and early in the following one, the art of wood carving was greatly developed in England, chiefly owing to the genius of Grinling Gibbons and to the influence of Sir Christopher Wren, the style de-

veloped being a more or less realistic or baroque form of the Renaissance (Figs. 44 and 45). Gibbons carried

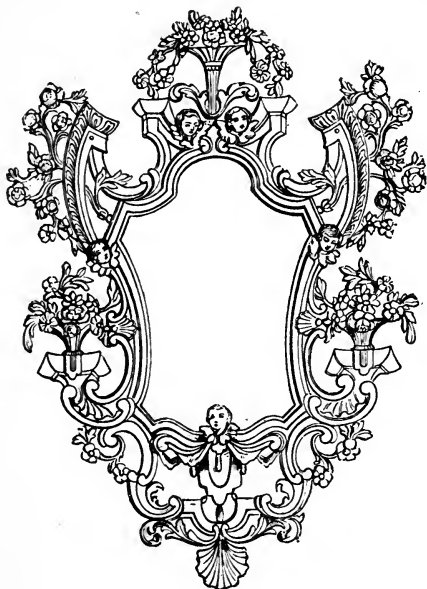

Figure 45

out some of his carvings to an astonishing degree of realism: bouquets of flowers, festoons of fruit and flowers, birds, figures, and drapery were executed by him in the highest possible relief, which looked de-

tached from the ground, and yet they usually formed a part of the solid wood with the background. Ornament was carved with a singular crispness, and apparently without any hesitation on the part of the carver. Though we may condemn the florid looseness of the style of Gibbons, we must admire the dexterity of workmanship and general technical excellence imparted to everything he touched. Some of his best work may still be seen at Chatsworth, Petworth House in Sussex, Lyme Hall in Cheshire, St. Paul's Cathedral, and Trinity College Chapel at Oxford.

Under the Regency of Philippe d'Orleans in France (1715-1723) decoration and ornament assumed a light and fanciful character, very naturalistic, but still having some classic details; of this style Claude Gillot is the chief exponent. Watteau, his pupil, made a great name as a painter of pastoral scenes, fetes galantes, and all kinds of light and daintily-treated subjects of a theatrical and artificial kind of composition. His color was silvery and harmonious, and sometimes he decorated furniture with pastoral scenes.

The Rococo style had begun under the Regency, if not earlier, and such men as Oppenort, the De Cottes, father and son, Francois de Cuvillies, the Italians Bernini and Borromini, and lastly the great apostle of the Rococo, Meissonier, were all designers of furniture or architects who belonged to the period of Louis XV., and who executed works that reflected the loose and

unrestrained character of the times (1723-1774). Chinese and naturalistic elements were grafted on, or mixed with, the former Louis Quatorze, with an addition of still life that did duty for architectural form in objects of pottery and metal work, and a combination of shell work; all these elements made up the style known under the different names of rococo, rocaille, baroque, or Louis Quinze.

Furniture was made with curved and swelling panels to show to more advantage the marquetry, or paintings on gold grounds; these kinds of panels and friezes were known as "bombe."

It is said that the Italian architects, Bernini and Borromini, were the first to introduce the rococo style into France, but no designer went so far in the wilderness of its vagaries as the French Meissonier. His ornament furnishes a perfect example of the want of balance and symmetry. He designed for furniture, woodwork, silver-smithery, and modelled decoration, all of which work illustrated the broken shell-shaped panels with frilled and scalloped edgings and curved mouldings.

Rooms were lined with looking-glasses having these rocaille mouldings, which were well adapted to show to the best advantage the glitter of the gold leaf that was used inordinately on the furniture and decoration of the Louis-Quinze period.

Pierre Germain, Jean Restout, and Jean Pillment are

well-known names of other designers of the rocaille style.

Painted panels of pastoral scenes and flower groups

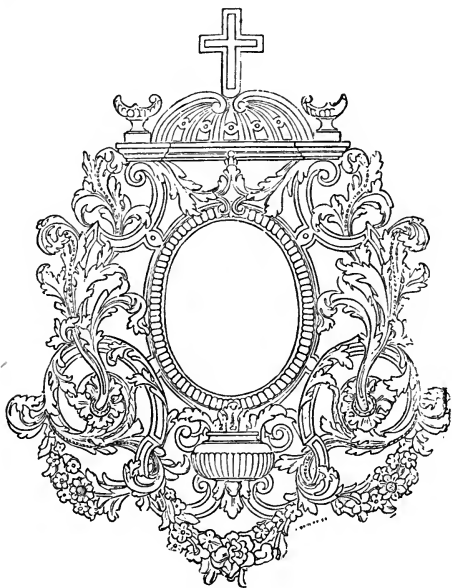

Figure 46

were the usual color decorations of ceilings, furniture, carriages, and a host of minor articles such as fans, etuis, snuff-boxes, &c. The latter smaller articles, as well as the state carriages, were decorated with paint-



Figure 47



ings in what was known as the Vernis-Martin style. Martin was a decorator of carriages and an heraldic painter, who invented the particular hard varnish or lacquer which bears his name. It was quite likely that this was as near as possible a successful imitation of the Japanese gold lacquer that decorated the articles which were at this period imported from Japan by the Dutch and Portuguese traders into Europe. Carriages, tables, cabinets, and especially smaller articles like snuff-boxes and needle-cases, were painted and decorated in "Vernis-Martin." Some of the smaller objects were beautifully mounted in chased gold.

It was quite a common practice to cover or to panel furniture with plaques of Japanese lacquer, and to mount them in chased metal or ormoulu decorations. A unique commode is illustrated at Fig. 47, made from panels of very old Japanese lacquer and highly decorated with ormoulu mounts by Caffieri, a skilled chaser of the Louis-Quinze period.

In the latter half of the eighteenth century an improvement in the design of furniture and of ornament generally crept in, owing to the study of the ornamentation and design of the classic objects that had been found in the buried cities of Herculaneum and Pompeii. These cities had been discovered in 1713, and about forty or fifty years later books were published illustrating the buried remains, which helped to change

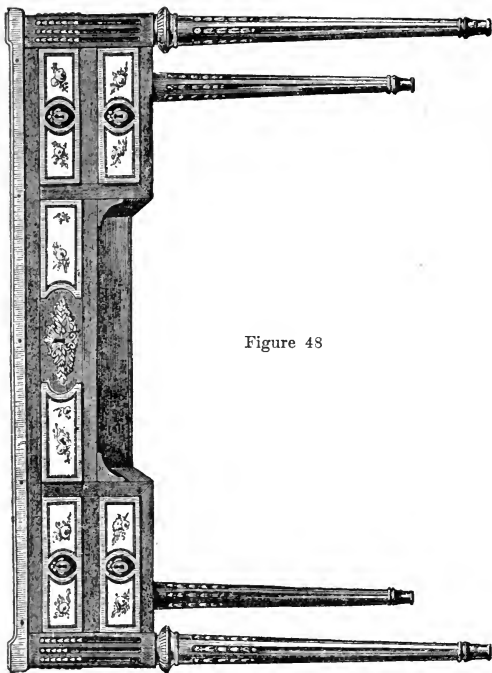

Figure 48

the public taste, and by degrees a demand arose for designs of a more severe and classic kind.

The prevailing taste was then apparently gratified by the mixture or grafting of a certain quality of classic forms with the former frivolous style of the Louis Quinze.

The style in furniture and in ornament now developed into what is known as the "Louis Seize" (Louis XVI.), and consisted in its ornament of a composition of then scrolls, garlands, bows and quivers of arrows, ribbons and knots, medallions with classic cameo-cut subjects. Mouldings were fine and delicately ornamented and of straight line variety; in fact, the straight line now reasserted itself in architecture and furniture design (see Figs. 48, 49), in refreshing and healthy contrast to the tottering and riotous curves of Louis XV. and the Du Barry period.

Some of the most beautiful furniture expressive of the utmost elegance was made by Riesner and David, and was decorated with ormoulu mounts by Gouthiere for the Queen Marie Antoinette. Riesner and Gouthiere were the ablest men of their time, who generally worked together in the making and decorating of the finest furniture of this period. There is in the Jones Collection at South Kensington some of the very finest examples of this furniture, much of which was made for Marie Antoinette (Figs. 50, 51).

Riesner usually worked in light and richly-colored

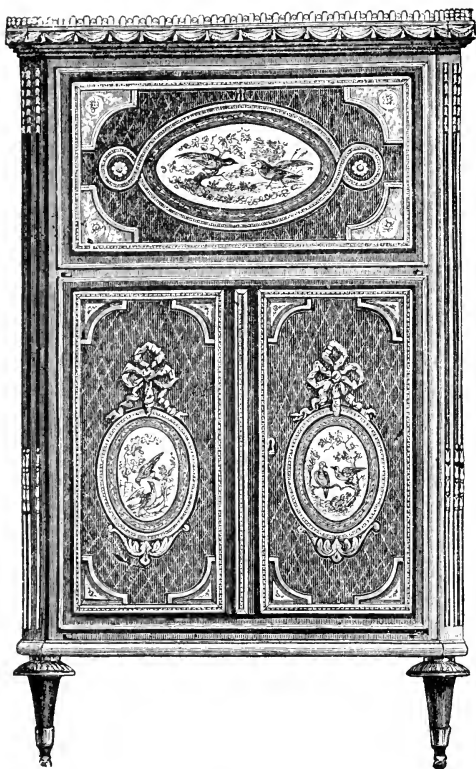

Figure 49

woods, such as tulip-wood, holly, maple, laburnum, purple-wood, and rosewood, for his marquetry work, and used oak for the linings and foundations.



Figure 50

The best pieces of David and Riesner were usually mounted in ormoulu or bronze-gilt metal by Gouthiere, who has never been equalled as a founder and chaser

of this class of work. Prieur was also a good chaser of the Louis Seize period. Delafosse was an architect and designer of furniture and decoration of the period, whose designs were of a more heavy and classical kind. Cauvet was a German who worked in Paris, and designed graceful arabesques and figure work, and who published a book of designs. Lalonde designed work that might be classed in the same category as that of Cauvet, and Salembier was a prolific designer of a light and free kind of arabesque. Many of his designs for silk may be seen in the fabric at the Silk Museum in the Bourse at Lyons. Le Notre designed for furniture, carving, and was also famed with La Quintinie as a designer of the state and public gardens.

In Italy the prevailing ornament in furniture and decoration was more classical than in France. Piranesi, Albertoli, Pergolese, and Bartolozzi are names of the principal designers of this country in the eighteenth century, most of whom published extensive works on ornament. The latter two were brought to England by the brothers John and Robert Adam (1728-1792), who had travelled in Italy, bringing also with them classical ideas, which they developed in England, and which influenced to a great extent the style of architecture and furniture design in this country. The Adelphi building and the houses in Portland Place were built from designs by the Adams.

All kinds of furniture, sedan chairs, carriages, plate,



Figure 51

&c., were made from their designs. Fine mouldings, medallions, rosettes, light garlands, capitals in classic form, fluted pilasters and columns, were all designed by them with the utmost restraint in style—even to coldness.



Figure 52

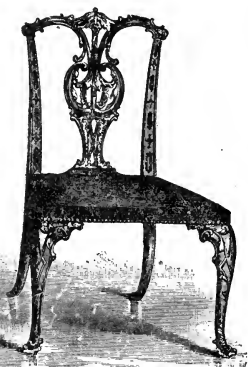

Figure 53

Thomas Chippendale was a famous cabinet-maker of the eighteenth century. His furniture, or even any good imitation of it, fetches a good price at the present time. He published a book on furniture design and interior decoration in the year 1764. His sons are supposed to have made nearly all the best of the mahogany furniture known as "Chippendale."

The parlor chairs (Figs. 52 and 53) are good examples of Chippendale furniture, and the chairs made



in the so-called "Chinese style" (Fig. 54) are attributed to the elder Chippendale.

Sheraton and Heppelwhite are names of two other

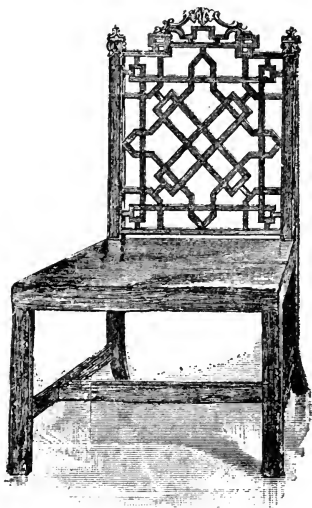

Figure 54

well-known cabinet-makers, who made excellent mahogany furniture in the last century, both of whom published works on the subject at the latter end of the century.

The names of Gillow, Lichfield, Lock, and Copland are those of eminent cabinet-makers and decorators of

this period, the two former firms being still in existence in London.

In France, after the Revolution (1792), more decided phase of the dry and heavy classicisms was apparent in the furniture design and decoration of the period (1801). This return to the classic heaviness has been attributed to the influence of the academic painter David, but is more likely to have been a pandering to the national worship of Napoleon and the French Empire. It seemed to have been the universal desire to make everything echo or reflect in some measure the glory of the Emperor Napoleon I. The meanest thing had some symbol or allusion by the way of decoration that should remind everybody of the greatness of the new monarch and of the French Empire, and consequently the heavy and ponderous style of that period was known as the "Empire Style." The furniture of the Empire was usually made in mahogany, decorated with mountings in brass or bronze, of sphinxes, griffins, Roman emblems, and antique scrollery.

Percier and Fontaine are names of French cabinet-makers and designers who worked in the Empire style, and who published a book of their designs. (Fig. 55.)

In England the style was copied, and endless imitations of the French fashion in tables, sofas, chairs, cabinets, and clocks were designed after the same antique ideals.

In this country, during the earlier half of the last

century the mediaeval Gothic style was partly revived in architecture and in furniture, mainly owing to the efforts of W. Pugin, the architect. He designed many



Figure 55

pieces of furniture, and published a work consisting of Gothic designs in the year 1835. Notwithstanding the efforts of Pugin and some other eminent architects and "purists," no particular lasting impression was made in this direction.

If we except a few of the best cabinet-makers' shops, where in the present day some furniture of good design



Figure 56

is made, the majority of such work is now made by machinery, or is often too much the work of the upholsterer, and is consequently less artistic and more mechanical in both design and construction.

Some of the most beautiful of Japanese and Chinese manufacture is made in carved wood and lacquered in black or red. Cabinets with drawers and quaintly contrived cupboards and recesses (Fig. 55) are made by the Japanese, finished in lacquers, and inlaid with ivory and mother-of-pearl. The Chinese are especially skilled in carving red lac-work. Some vases of great dimensions and of exquisite workmanship in this material may be seen in the various Museums. Lac-work is also executed with great skilfulness by the natives of India. Bracelets, armlets, or golias, are made of lac in various colors, the golden decorations of which are made from tin-foil and varnished with a yellow varnish made of myrrh, copal, and sweet oil boiled together. Boxes, bed-posts, and other furniture, made in wood or papier-mache, are lacquered and decorated with flat renderings of flowers and conven-



Figure 57

tional shapes of animals and birds (Figs. 56, 57). All kinds of toys, weights and measures, cooking utensils, circular playing-cards, turnery, etc., are objects in small wares made in the choicest lac-work of India.

### STYLE IN FURNITURE AND DETAILS OF STYLE.

In looking back through the past ages, since the days of the supremacy of the Roman Empire, and after listening to the wonderful tales of the magnificent luxury and extreme prodigality of the sovereigns who reigned, and of the Lords and Ladies who lived in those times, we are led to suppose that the furniture of these palaces was of a kind that if it could be restored to its original splendour would strike our eyes in this present generation as something great in architectural beauty and dazzling in its gorgeousness.

We have learned to look with longing eyes on the Ottoman Empire as the place where luxurious ease has reached the highest attainable point within the limits of human skill, and think that the harem of the Turkish Vizier must be a sort of fairy palace lined with silk and satin, and full of couches so soft and easy that to recline on them is enough to send one to sleep.

If the truth were told, not one person in ten has anything like a proper idea of what furniture was in days gone by; and stranger yet, except in a few instances, people know very little about the finest furniture of the present day. One shop will turn out a bedstead, an-

other a set of frames, and so on, but the people that make them seldom see them after they are finished, and in a house that is carpeted, curtained, and completely furnished, and if they did, would scarcely recognize them as the results of their handiwork.

The majority of people obtain their ideas of furniture, modern as well as ancient, from reading, and two-thirds of the descriptions of furniture that are written are fabrications of some fertile brain that does not know a sideboard with a glass in it from a bureau. Therefore when we read accounts of ancient furniture and its great superiority over that in use now, first see whence the authority comes before believing it all. We have seen accounts of the magnificence of the furniture of the Romans in the time of Constantine; of the tables and chairs inlaid with gold, silver, and precious stones; of ease and barbaric splendour that was startling; whereas the same chairs and tables were as uncouth and cumbersome and uncomfortable as most people believe them to be comfortable and elegant. They may have been heavy with gems, but the gems were beautiful—not the chairs.

In the twelfth and thirteenth centuries more attention was paid to the architectural part of furniture than at any time before or since, but they lacked comfort, and we owe it to the French that instead of following the true principles of architecture and endeavouring to furnish luxury with art, they adopted a gaudy tinsel

style that had no art and little comfort. Marie Antoinette set a fashion of glitter and glare, and in her time more money was spent in gorgeous furniture than at any other since the dark ages, not even excepting the shoddy time within our own recollection.

Although there is much fault to be found with modern furniture, at no time has it been any better than it is now, to meet the wants of the people—and while we condemn the want of architectural merit, much, particularly in the richer classes, of the present day, is superior to that of the ancients. The furniture of the twelfth and thirteenth centuries had artistic merit and but little comfort, and was so rude in construction that the beauty of design was lost in the rough, unfinished look it presented, while today high finish, elegance of construction, and inviting look of comfort, do much to retard the introduction of pure architecture. When these two things, art and comfort, are combined, as they well may be, and soon will be, for we are glad to see the inclination in that way, it will be said years hence that the people of the nineteenth century were the first to turn out perfect furniture. We ought more properly to have said in the latter part of the nineteenth century, for perhaps nothing could be much worse than the furniture of the earlier part, particu-

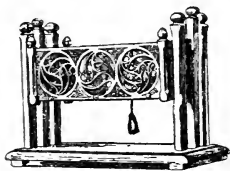

Fig. 58  
An Old Cradle



larly here in our own land, for we had a mixture of the French, always bad, of the English, that was nondescript, and of the Puritans, that was—what shall we call it? let it be nameless;—we all know how it looked, and none would now care to use it.

The sumptuous furniture of old, is of itself sufficient to prove the truth of the statement which has been made as to the advances made during the period of wealth and luxury. One could not desire to see a more beautiful bedroom, for instance, than that in which James I. of England was accustomed to sleep during his visits to Knole, in Kent, and which is, to our minds, only the more attractive for a kind of grave stateliness that pervades the whole. The mothers of the present day may, perhaps, feel interested in knowing what kind of article a cradle was about three centuries ago; it was a species of box, or coffer on rockers, decorated elaborately with carvings. In later times French feeling crept into our furniture and, to our thinking, by no means improved it.

Illustrations of the elaborate and highly decorated character of the furniture belonging to the sixteenth and seventeenth centuries, are shown in our pages, from which our readers may derive some useful and suggestive hints from these reproductions.

There is, we know, of great power in this world, a certain fascinating spirit, called fashion; which controls the fancy, and compels it to a predilection, and, at

its pleasure, to a change of predilection, for forms and colors, and practices, quite independently of reason, and not seldom in the most direct opposition to common-sense.

Fashion nevertheless is sometimes a brainless spirit, if the expression may be allowed of spirit; and without sense of good or evil. It will ally itself with taste, whether good or bad, and with moral order, good or bad. Among the Greeks of old, connecting itself with good taste (we wish we could add good morals) in its progress towards perfection, and maintaining the alliance, when perfection was attained, Fashion was of inestimable value. In some instances Fashion has been found capable of fixing a good moral order; and then of course it has been of worth still far more transcendent. But this brainless spirit, perhaps oftener has made bad taste immovable; of which the Chinese afford a great example.

But, among the Greeks, in architecture, in literature, even in dress, things were so settled, that one general character of Grecian taste has been the allowed criterion of perfection, for now about three thousand years. How was it that the spirit of fashion, among them, held such persevering connection with the spirits of common sense and good taste? Could it be because women were so excluded from general society as to have little influence in directing Fashion, or in supporting her in her wayward fancies? Surely the spirit of steadiness is not

alien from the English character: in graver matters we know it to be eminent. The famous "Nolumus leges Angliae mutari," has been persevered in for centuries; and we may hope will be persevered in as long as the world shall last, or as long as it shall please providence that the English nation exist. But in matters of taste, certainly it has not been so.

There is not a demon more adverse to good taste than the spirit of Novelty. In matters of taste, as in almost everything, there are commonly many wrong ways for one right. Now the spirit of Novelty allows readily the passing from wrong to right; but at no rate, the perseverance in right; whence wrong must, many times to one, with him, prevail. With this spirit, fashion has long, in this country, but especially of late days, held close alliance. Fashion has no will of her own; but Novelty, though ever-changing, has, for the moment, a most determined one. Thus, Fashion still appearing the imperial lady, and Novelty but her minister, he easily leads her his own way.

In what high estimation both these whimsical spirits are held very extensively, not to say universally, among the ladies, is enough known. The ladies even in America rarely have their natural good taste improved, but often much perverted by education. Taught from infancy to revere the majesty of Fashion and to consider her sovereignty as not to be even decently opposed, with a living feeling for the charms of Novelty, they set

about their imperial business of furnishing a house. Ranging the fashionable upholsterers' warehouses, they feel themselves as in a sea of delights, but as in a vessel with a port to seek. Without a compass they look to Fashion as their polar star, their sails are filled by Novelty, and they give the helm to fancy.

The sky is clear, the weather most temperate; but under license of Fashion, Novelty, with his handmaid Variety, dispensing the winds, they are ever shifting. Fancy, distracted, grows giddy; her nerves falter, her hand shakes, her eyes twinkle, and she can no longer by day take the height of the sun, or by night with any certainty discover her polar star, a changeling polar star, Fashion. Thus distressed, the lady seeks advice from experience, and the cabinet-maker or upholsterer is called to her assistance.

Beyond all others the spirit of Novelty and Variety are objects of the upholsterer's workshop. He professes infinite reverence for Fashion. But his loyalty is for the fashion that may happen to reign for the day: nor is it, like the Vicar of Bray's, an ever acquiescing loyalty; on the contrary, he is ever aiming at revolution. The lady is aware of the unsteadiness of the reign of Fashion; and not less anxious than the upholsterer to be prepared to adore the rising sun; but with this difference: he is always ready for revolution; she devotes herself more to the present power, and dreads changes, in which others may be before her. Not wholly un-

aware then of hazard in committing herself to his advice, having made her inquiries, and gained all attainable information, her purpose is to direct her upholsterer; but he is versed in the ways of leading her.

It behooves the cabinet-maker and upholsterer much to have talent in matters of taste, and to cultivate it so as to distinguish good from bad; but more, it behooves him to know the weak points in human nature. Nothing so advantageous for him as to gain prevalence for a new fashion of very bad taste; and the more grossly bad the surer and greater his benefit; because the easier will be the task to bring about another change; for of all things change is most beneficial to him.

The upholsterer's interest then is in direct opposition to the architect's credit. Put him into command in a room, and his first purpose must be to overwhelm the architect's work. What are elegancies in stucco, stone, or marble to him? For daylight indeed he is a little dependent; he must have windows from the architect; and till stoves were brought into use he wanted him also for the chimney. But for candlelight, "Give me a barn," he says, "and I will so throw my many-folded drapery, suspended on my golden thyrsus-fashioned poles, that nothing shall be seen needing the architect's art to supply."

To proceed with this subject, I will venture only to state a principle or two, which I trust you will admit, and I hope you will recommend to the ladies. When a

house is ready for the furnisher if it has any decoration of architecture fit to be seen, and not rather deserving to be treated as the upholsterer would very properly treat the barn, the style of that decoration should be respected in the design of the furniture. Either all should be upholstery, or the upholstery should be subordinate to the architecture, and harmonize with it. Can it be requisite—I fear it may—to superadd, that the furniture should harmonize with itself through all its parts; that gaudy and ill assorted colors, awkward forms, and even elegant forms and foldings, in that kind of display which may deserve the epithet meretricious, however warranted by the fashion of the day, should be avoided. With what ideas do that nakedness of the female figure, and that abundant complexity, that mystery of folding, of the drapery about the room to receive such figures, as we have been accustomed to see, harmonize? Fashion indeed is powerful, and sometimes grossly perverse. What could be reasonably done with the human head during the century and more of the successive fashions of the full bottomed wig, the aile-de-pigeon hair-dressing, and all that intervened and followed, till wigs and elaborate hair-dressing were both abolished? Fashion, it must be confessed, has a strange power of fascination, which even strong minds have difficulty wholly to resist, even when that power is exerted most in opposition to evident reason. But it is only when a fashion has obtained universal and lasting prevalence that rea-

son is so compelled to submit to it. Generally large choice is open. Reason and better taste may well venture upon opposition to partial and ephemeral absurdities, and, with due exertion, would prevent their gaining any overbearing ascendancy.

The present rage for old articles of household use, table decoration, and personal adornment is a whim of fashion, in many instances the coveted articles having no element of propriety in our modern life. Very few of them are valuable in the light of sentiment, having no association with beloved friends or with historical events.

But apart from these considerations the love for genuine old relics of furniture, especially, has an excellent reason for its being. There are really valuable and useful articles of household economy which unreasoning style has relegated to the second-hand furniture store, to the attic, or to the barn, or perhaps ruthlessly destroyed, and which have been replaced by modern articles far inferior. The present spring seat sofa with its tufted cushions and tortoise back seat is not half so inviting and restful as the old-fashioned, flat seated, broad sofa, long enough to receive a six-footer, and broad enough to hold him safely if sleep overtook him. Many of these articles are of solid wood with no suspicion of veneering, and their forms are really more elegant than those of to-day. Modern veneered and upholstered furniture requires repairing every few

years, or is worn beyond revamping within the recollection of a ten year old child. It is a source of regret that with the rage for antique furniture there is not also a demand for old time honesty in workmanship. In spite of the sneer against the old style straight backed chairs, most of the old style furniture was made for convenience. There never was a more convenient article of furniture than the old desk and drawers combined—drawers below a folded-back desk, the back

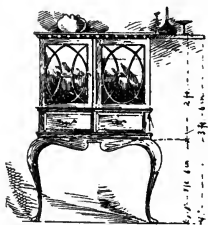

A Wine Cabinet

being pigeon holed, and the desk on hinges to be let down to form a writing shelf, and projecting far enough forward to give room for the writer's knees. The cupboard was another useful article for the kitchen or dining room. It contained two or more wide drawers, with doors above them opening on shelves and racks, the whole standing on legs high enough to admit of sweeping under the cupboard. Memory recalls one, the framing and ends being of white walnut or hickory and the door panels and drawer fronts of cherry, both native woods, the creamy white of the hickory contrasting finely with the warm wine red of the cherry. These colors were set off by pendent pulls and door key escutcheon of polished ungolded brass that could be re-polished and kept from the dilapidated appearance of



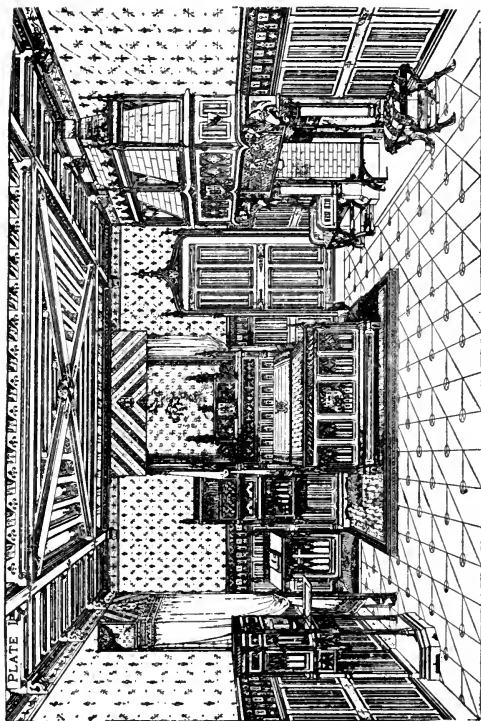

Plate I

the warm gilded brass of the present. Such an article of furniture would give an air of substantial comfort to any modern home.

The inferiority of modern made furniture cannot properly be attributed to machine duplicated work; it is as possible to make first class work by duplicating by machinery as by hand; else our hand tools and machine tools would be much more costly than they are. But it is undeniable that most of the furniture made within the memory of the elderly portion of the present generation compares favorably with that now made, in durability and integrity of workmanship. In these qualities it would be well if our manufacturers shared in the rage for the antique.

Mediaeval furniture—*Mobilia*, as it is rightly styled—is one of the rarest manifestations of art-work or handicraft. Our knowledge of it is principally from pictures, illustrated MSS. and carvings. Contrary to the received opinion of some of the acknowledged authorities on Mediaeval art, we are convinced that there would be no difficulty in producing a very complete history of *mobilia*, the material for which could be drawn from the sources indicated. We see many modern specimens of both a bad and vitiated class of works, made at a time when splendid decoration reigned in place of art, and indeed no such thing as art existed. From this period we moderns have borrowed almost all our models, it being precisely the most unhappy choice we

could have made, not only on account of the amount of useless, expensive, and vulgar decoration it has led us into, but because the mere system of construction adopted is false, and so far, happily, insuring no lasting durability to the products of such workmanship. The furniture of every country has echoed in its form and decoration the character and spirit of the art then prevailing.

In Egypt, of old, the tables, seats, couches, etc., preserved in the British Museum and other collections, testify to this; one or two things copied in bronze or marble from Greek works of this class, express exactly the same kind of thing, and point out by the extreme chastity of their forms, the peculiar idiosyncrasy of that nation, no less than by the skillful manner in which they are put together, the mechanical ability of the workman. Our knowledge of Roman doings in this matter is derived from similar sources. One or two examples of curule chairs that might have belonged to Pro-Consuls of Gaul or elsewhere, do indeed remain, with strange legends attached to them, and saints and monarchs of very questionable verity or appropriateness. Upon Pompeian pictures, bronzes, etc., we must rely, without which we should be more ignorant of these things than of the seemingly much more perishable and fragile manufactures in glass and earthenware, or even iron, of which such innumerable specimens exist. We have as many remains of Assyria as of old Rome. There is no doubt from the gorgeous illuminations of the

period of the lower Empire, that the furniture then in use was, characteristically wrought, of extraordinary splendour, gilded, incrustated, and inlaid with ivory and jewels to a degree that quite marred its artistic beauty. Of this, much purified by Italian taste, some slight

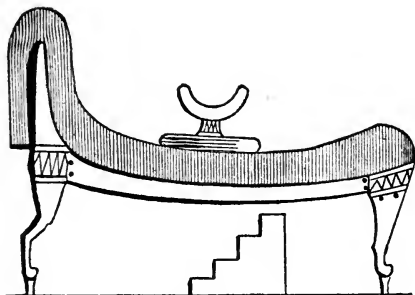

Figure 59

traces are to be found in the Venetian works, affected as they were in this, as in other things, by oriental neighborhood and associations. The Venetians improved these works, be it understood, and chastened, while they truly enriched the tawdry over-decoration of the Greeks. Their conquest in the islands and commercial seats in so many parts of the Byzantine Empire, brought them in contact with more than one point of its character. Of constructional felicity there is almost none in Byzantine examples of which we have knowledge.

In Europe, in the middle ages, the character of mobilia was ever that of current architecture, then the art to which all the other major as well as minor arts were subordinated,—that fact of their subordination being one to be ever most heedfully borne in mind by the student of archaeological science and mediaeval art. We find this leading fact constantly forgotten by writers on the arts. To furniture particularly, painting became serviceable, the thirteenth, fourteenth, and fifteenth centuries never missing an opportunity of employing that art in this way. Hence, several painters began life as decorators, as many more were sculptors who began as goldsmiths. Marquetry was another most effective means of decoration, becoming estimable from an early period of these epochs by the careful method of its execution, and, later, from the fine forms and colors its patterns displayed. In the sixteenth century much beautiful work was produced, its early decades being, indeed, to be regarded as the culminating period in furniture designing. Colors due to the above means, or rich velvets and silks, brocaded or woven with gold thread, took precedence in characteristic ornamentation at a somewhat late portion of this era. But carving, as so many French and German works testify, was largely employed. Both these characters ran into ruinous riot in the next epoch, and lavish magnificence took the place of beautiful design, the use of things themselves becoming hidden under a desire to waste all the

costliness and folly of extravagant ornamentation upon them. At this time began the still existing mania for furniture made for show; and to be shut up in a room, wastefully decorated with merely costly ornaments, intended to be seen only, and but sparingly brought into use. It was the "bright poker" idea at its maddest. Hence we now find reception rooms that were too fine for use, and frail furniture neither man nor woman dared to intrust their persons upon. More sumptuousness and ridiculous degradation of taste burst out under Louis XIV., when those preposterously tawdry gew-gaws that are to be seen here and there in sale rooms, when some old household is broken up, overloaded with tortoise shell, brass, sham jewelry, and vile carvings, and generally made to imitate something that had not the remotest resemblance to the real nature of article in question, but preferably that farthest from it. Thus a cabinet or "armoire" faced the world with an extrava-

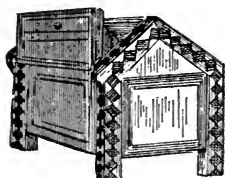
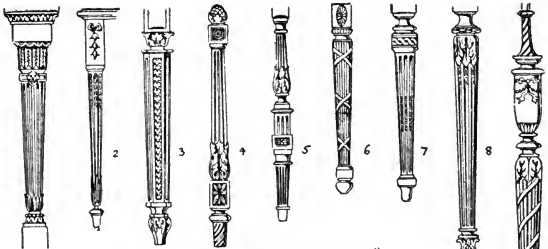

Figure 58

gant architectural frontage, and a chest of drawers was a miniature frontage. As was to be expected from the political state of the time, the most hideous of these monstrosities came, not from

France, where the taste for these originated, but from servile Germany, whose craftsmen vied with each other in the cities of Nuremburg, Augsburg, and Dres-



"LOUIS XV. AND XVI. DETAIL."

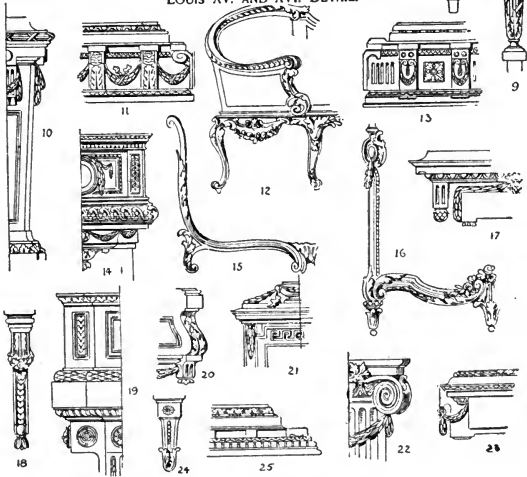

Plate II

den, as to who should make the most monstrous foolery at the most wasteful cost. Italy, as usual, before her utter degradation kept to the fashions of an earlier date or improved by her native gift of taste, upon that current in such a manner that something of her old inheritance is seen even at this time.

Later in the seventeenth century especially, this whimsicality took a new bent, and a queer hothouse sort of life, a meretricious vitality, such as disease often has, broke out, and the Louis XV. fashion got into vogue, when oddly shaped forms, mouldings and inlays were employed, and flat surfaces bore the works of men's lives—not of their minds, but of their patient dull drudgery at outre and elaborate combinations of art—necessarily, therefore, devoid of real taste and common sense. Incrustations of brass, copper, tin, and even silver were engraved by the burin to imitate relief or actual mouldings. Wreaths, termed masks—not the pretty Amorini of an earlier age—were attached to the articles, their office being almost invariably to hide some dishonesty of construction or to give a curve to some weak angle or strengthen some spindling line, to the eye at least, but not in fact. Indeed it is notably a marked characteristic of this class of works that all their tendencies are to be willfully false. One sees at once that the craftsman does not err in ignorance of the demands of his duty because things which might, constructionally employed, give real strength when needed, although of



a supplementary sort, willfully give only the look of strength, and, as if by malicious intention to lie for lying's sake, neglect their duty when it were easier to do it honestly than to fail or neglect. Thus it is in the major art of that time; thus it was in life, among the leaders, at least; thus it was upon everything that lies upon the surface of that rotten era, that nothing but the fiery ruin of revolution could purge pure.

Mere costliness is no element of art or good taste. We have seen very handsome chairs sold at a price that would condemn them in the eyes of untrained wealth, just as we have seen on the tea-table of the poor and lowly, low cost china that would put to blush—if it was possible—much of the high priced porcelain that decorates the cabinets of the wealthy. .

The perfecting of many processes of manufacture has placed at the disposal of artists and ornamental designers means for the reproduction and multiplication of their works, of which they have not been slow to avail themselves. As a class they undoubtedly occupy more definitely the position of leaders or teachers; and we are fairly entitled to hope that by this teaching the standard of public taste has been raised. The soil to be cultivated is rank with weeds, and the intelligent laborers are few. Our manufactures are in advance of our taste. The conditions of art and manufacture in the Middle Ages are in our day reversed: then there was a Raphael to design, but no Minton to reproduce skillfully

and at a cheap rate the pattern example; now we have the power of cheap reproduction, but not many designs worth reproducing; so we wisely store our museums with all the best examples of human invention, and thus provide ourselves at once with a standard, and with a check upon any vain ideas we may be disposed to entertain of our intellectual superiority and advanced taste.

Never in the world's history were the means of spreading a taste for art among the people as abundant. The productions of our manufacturers are placed before us with cheapness and certainty, and where bad taste in designs is to be noted, the fault can hardly be laid at the door of the producer, who, in many cases failing to secure the services of an original or even capable designer, is driven to pander to a taste which he would willingly enough direct if he could. We have so-called schools of design, instituted expressly to provide our manufacturers with intelligent designers; and we are able, by means of lithographic printing and photo engraving, to distribute cheaply and make common property throughout the length and breadth of the land the finest examples of all good art, in whatever form it may have appeared. Yet, after all, in the comprehension of good design, in appreciation of beautiful form, in sentiment of color, we are but a barbarous people as compared with any Eastern nation, or with our own Gothic ancestors. The best that can be said of us is

that we feel our inferiority when we look at an Indian shawl, at a Moorish pitcher, a Persian rug, or a Chinese vase. We try unsuccessfully to reproduce them; we do actually reproduce the ceramic ware of the 16th century, and glory in it; while we vainly strive to copy the mediaeval stained-glass windows, and are driven to confess that a people who flourished before the foundation of Rome were capable of designing a gold setting for a brooch which puts all our barbarous efforts to shame.

The spread of art is one thing; the advance is another. With our eyes open, it would be vain to deny that throughout the kingdom a new taste has arisen, and a desire among all classes of the people to appropriate some form of art is evident. But taste implies only accuracy of judgment, not that power of execution which follows in its wake. The taste of the man who knows is not that of the man who does.

The first-named may be considered as a *bon vivant*, who is fond of the dishes before him, and distinguishes nicely what is savoury and delicious, or flat and insipid in the ingredients of each; while the second may be regarded as the cook, who, from knowing what things will mix well together, and distinguishing by a nice taste, when he has arrived at that happy result, is able to compose such exquisite mixtures.

In the construction and ornamentation of furniture, as of buildings, grounds, clothing, and of everything

else of a material character, external to ourselves, several things are to be considered in their relation to our needs, comfort, and enjoyment. The mere necessities of life are really very few, though even these may be multiplied by habit, education, and circumstance. The man of thorough culture and high civilization certainly needs many things which the savage can do without and which would be even an incumbrance to him. But if these, increased in number as they are by artificial circumstances, are fully supplied, we are not, and ought not to be, satisfied. We may and should consider what is adapted to promote our comfort and gratify our taste, ministering appropriately, in both directions, to our enjoyment. For our present purpose and in connection with cabinet and upholstery work, it will be sufficient to consider three things—Novelty, Taste and Utility.

1. Novelty.—This is always a source of pleasure, affording a healthful excitement to the mind. This is the reason of the frequently sudden and extreme changes in fashion, of the desire to visit localities and scenes which are new and strange to us, and of the effort to secure for the gratification of all the senses ever new means of pleasure and excitement. The conservative critic may find fault with this universal tendency to innovation, but it will excite and exert its influence so long as the human mind tires of sameness, and seeks for change. We desire repose and permanency of con-

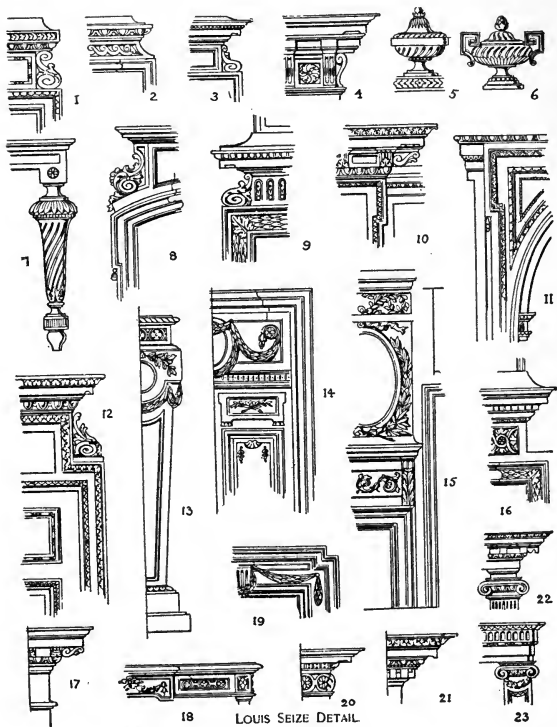

LOUIS SEIZE DETAIL

Plate III

ditions and surroundings only when we have ceased to acquire and develop, and our powers have begun to decline with the coming on of old age. This quality of novelty is one which all who would cater for the popular taste and, by so doing, secure and maintain a successful business, must aim at in connection with other qualities of excellence. It is also unquestionably true that the desire and effort for novelty leads sometimes to the adoption of styles and ornaments which are unsymmetrical and incongruous, and though striking and sometimes even almost pleasing to those who crave that which is startling and outre, they will greatly offend good taste. There are certain established principles which are the basis of all correct procedure, and any rule of mechanical practice, or even what has come to be an established custom may be departed from or neglected, so that there is no infringement of these fixed principles, among which may be named fitness, utility, propriety. If, in seeking novelty, the artist-mechanic introduces that which is in violation of the principles of unity and harmony, he will forfeit his claim to be called in any sense an artist. Let him rather search for the union of novelty with other beauties, with a constant consideration of a reference to fundamental principles, and to this end it will be well that he should thoroughly study the details of the works of ancient art, whether of the Gothic and other mediaeval styles, or of the more remote classical. From these may be gathered

suggestions which, by exact reproduction or suitable combination, will afford designs, which may be applied to modern uses with excellent effect for internal finishing and furniture.

2. We consider, in the next place, the element of Taste in construction and ornamentation. It has been well said that "art can lend to an object a value, greater than that of the material and workmanship of which it consists, even when the object is formed of precious materials, as of rare marbles, scarce woods, or 'silver or gold.'" And, where the material is of less intrinsic value, yet more will depend on art and the taste displayed in figure and ornament. The beautiful, the tasteful has a commercial value—a remark as true of the goods named in the opening sentence of this article, as of those in any line of manufacture. It follows, then, that the manufacturer, who can in the highest degree secure that the productions of his establishment shall be in the greatest degree tasteful, and worthy to be styled beautiful, will in this fact secure no mean advantage in the busy arena of competition. Expenditure in the employment of designers who shall be true artists, even though it may seem hardly necessary or profitable, may prove to be really wise in principle, and most satisfactory in results. The workman also may, with great benefit to himself, study these works thus greatly enhancing the value of his labor, and become more than a mechanic, for he that can, in a novel form or one that

is original with himself, form a chair or a table, which, either as a whole or in its details, is really tasteful—"a thing of beauty"—is truly an artist. If he has the laudable ambition in this manner to rise above his fellows, let him acquaint himself with the laws of beauty, so that he shall be able at once to see the difference, and the reason of it, between the beautiful and the ugly, the graceful and the deformed, the refined and the coarse. Let him study the works of art of all ages, in the great variety of subjects to which art has been applied, and he will not only have opened to him new and most fruitful sources of pleasures, but will add, to mere skill in the use of tools, the development of a talent that shall command its price.

3. The other point which we proposed to consider was—Utility. This may appear to be independent in some measure of the considerations before named, yet a manifest adaptation to the purpose for which it is designed will be an element in the decision of the question whether it is tasteful or not. Such is the constitution of the human mind that what might, aside from any consideration of its use, seem to be without form or comeliness, assumes a certain appearance of beauty, when it seems to be precisely fitted to the convenience of the user. It is also clear that the purpose for which an object is intended should be met in its structure and form, and no adjunct, for the sake merely of decoration, should be permitted to interfere with its utility, or be



inconsistent with the position which it occupies in relation to the whole subject or article. The material should be studied with its adaptability to those forms

CHAIR OF QUEEN HATASU  
WHO LIVED 1600 YEARS BC

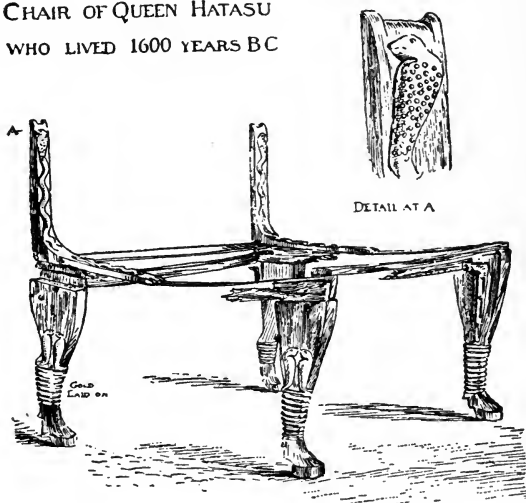

Figure 60

which are essential to the use of the article which is to be manufactured. It should not be assumed that, because certain forms and decorations may be appropriate to one material, they would be equally adapted to, and look equally well in, another material entirely different in its character. One of the essentials of a good design

in industrial art is the adaptation of the natural characteristics of the materials in which the design is to be realized. The form, also, must in every case subserve the purpose for which the article is to be made, the lines being as graceful and as true in the relative proportions of the parts as will be consistent with the convenience of the person who may use the article. When, however, the objection is made to a chair or to a lounge that one cannot sit or rest easily and comfortably upon it, it is not a sufficient answer that the form of the one is graceful and all its lines those of beauty, and that the other is tasteful in design, and that in material and covering there is harmony both of proportions and of colors. They are articles not to be looked at—not that merely or chiefly—but to be used, and in their very form should be suggestive of rest, refreshment, repose. Other illustrations might be given of this point; these, however, will suffice to illustrate the position that, whenever utility is sacrificed to novelty or to ornamental appearance, however pretty, the article is badly designed, and the art or skill exercised upon it has been practically thrown away.

Words are more or less indefinite in their meaning, and admit of wider and more comprehensive translation, according to their context with other words, or their association with ideas previously existing in the minds of their hearers. Among them all, there are perhaps none more difficult to explain than the word style,

by Webster, we shall find how large is its range, how wide its divergence from any center that can be marked out for it. Walker puts among other things as its signification "manner of writing," with regard to language; manner of speaking, appropriate to particular character; title, appellation. All this may be right; at any rate is enough for him who is not required to go into lengthy definitions, but merely to throw out such suggestions as will, when united with others, be the seed of future comprehension.

I think we may acknowledge style to be the instrument of power by which we convey emphasis of expression in our work, and render intelligible forms which would otherwise be both meaningless and purposeless. There is another word which artists are in the habit of associating, and even confusing with style, Manner, which when repeated again and again is designated as mannerism, a feature by which we are too often enabled to distinguish the productions of one man, and even of one age, from those of another; but there is a wide difference between it and style. Style advances whatever it is attached to, makes its intentions more evident, increases the force of its expression, as well as frees it from impurities which in no way help the object it has in view; while manner, or mannerism, on the contrary, serves no good purpose, is, in fact, most frequently merely the mirror in which the artist, or may be the period at which he lived, is unconsciously reflected.

That style and manner are frequently so mingled one with another as to render it difficult to separate them, or to distinguish which is which, I will confess; but the simple text I have here put to you will, I think, if carefully attended to, though perhaps not serving as an exact definition, show what is style and what is not, and even tell in what proportion mannerism, if any, is introduced.

This question the student will do well to constantly consider, as it tends to elevate what he may send forth, and keep it free from much that is detrimental to excellence, though at the same time highly seductive to the young mind. I wish to be the more impressive in this advice, because I cannot help fancying that at this moment there is a more than usual quantity of mannerism passing for style in the world of Art, and that students are mistaking one for the other, and running after the wrong thing, by affecting peculiarities and imitating weaknesses belonging to past ages, and quite out of place in the present day. I am not saying this in any invidious spirit; on the contrary, I am ready to acknowledge that many fine works are put forth among us, that carry out with powerful emphasis the spirit that is within them, simply because the treatment of every part is in unison with that spirit, and serves to elucidate the meaning intended by the sculptor; but the weed of mannerism is growing at the same time among us—mannerism, I fancy, not derived even from the best

time of Art; and I feel that it is my duty to protest against it.

Style is the gold that is the mark of genius, and mannerism the color by which you distinguish from whence it comes. All that relates to style is derived from the most profound knowledge.

With some style implies simple excellence of treatment in contradiction to the absence of that quality, and they read it as a mannerism always the same, and equally applicable to the carrying out in Art of all subjects—they talk of a Classical style and think this is the only adjunct that can properly be attached to it. There are other meanings to the word than this, or rather its meaning is capable of great extension. There is the Severe style, perhaps pretty much, though not quite the same thing as the Classical; then there is the Gothic style, which, clinging to a certain extent to the Classical, has its own peculiar mode of expression. Then, again, the simple and the Florid styles, which, it is not too much to say, are directly opposed to each other; and the Domestic style, which contradicts and entirely sets at defiance the Classical; and we might even add to them the Grotesque style, which hardly claims relationship with any of them. We will endeavour to explain the difference between them and the requirements of each.

The classical style would be the line we should adopt in our work when the subject to be treated belongs to

the classical days of old—when it associates itself with the grand old bards whose distant footsteps echo through the corridors of time, or whose conceptions are of that lofty nature that they admit of no minute detail, or dwelling on petty things. Our illustrations of them should then be in the same style, severe and simple, not

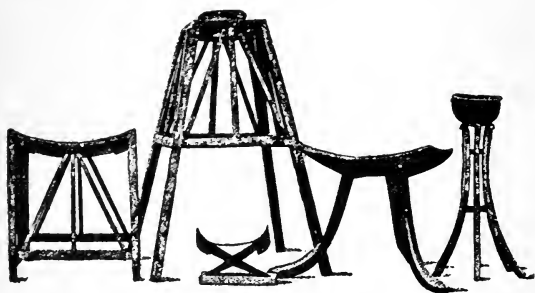

Figure 61

like everyday Nature, but like a something which we all of us, more or less, endeavour to conceive, and even long to be about us; but which can only exist ideally within ourselves, more or less clear, according as we are capable of entering into the feeling of the poet, or of becoming part of it ourselves.

The error modern imitators of Greek Art generally commit is exaggerating the tendency to straight lines and the repetition of them.

The Gothic style, as we have said before, retains some connection with the Classic by preserving its quiet

simplicity as well as its grace of line. That it has much of mannerism cannot be denied, arising, often from the mistake of the workers in it, who have fancied that rudeness and exaggeration of form necessarily belonged to it. This peculiarity, however, appertains only to the more decayed periods, and not to the time when it rose into beauty and fine art, as in the 13th century. That it had then and has now a style of its own is certain, for it had to express and does express the tone and feeling of a religion quite distinct from that of the Greeks—less earthly or sensuous, more pure and ethereal, more divine. We are now speaking, of course, of monumental and religious Art, the only things in which the Gothic is appropriate. In a domestic or homely sphere it always appears to be out of place and unsuited to the purpose.

The Gothics were greater architects than the Greeks, in a way, but it would be idle to assert that they were as good sculptors; there is no reason, however, why the finest works should not be combined with the Gothic style, for they can be made quite compatible with it.

Even the Florid style, which, from our dislike to it as somewhat debasing Art, we feel much inclined to stigmatize with the title of mannerism, is sometimes admissible; in fact, must be acknowledge to be, under some circumstances, the most appropriate—for instance in the decoration of the theatre, the ball-room, and other places of amusement. Surely when so placed it is

more in unison than any other with that elevation of the spirits which is supposed to pervade the scene.

The severe, unaffected Classical style would be a damper on our enjoyment under such circumstances, when we are not looking coldly on at real life, but taking, so to speak, a glance at it through a colored glass or our imagination.

Shakespeare, in his poetic drama of "The Tempest," seems to give us a view of it in this florid style. He elevates by his poetical imagination the scenes he portrays, and so leads us away into a realm of ideality more florid, more enjoyable than the reality we are compelled every day to take part in. You must do the same with your art, or at any rate furnish your portion in that enjoyment, and you will do it best by bending it to the same feeling.

It is under such influences that high and ornamental sculpture most frequently join hands together, and are present, not as real personages, or as representatives of particular ideas, but as decorations of a scene created for the transient pleasure of the moment. Your lines may now flow with greater freedom, your figures perform their parts with less reserve than on other occasions, your style may in short be florid. It is here, if anywhere, that color may be introduced into your statues, as well as into the ornaments about them. The danger is of their becoming sensuous; but the refinement, whether of design or execution, which you will



introduce, will keep that down in the same way as the great dramatist has done in the fairy tale I have just alluded to. There are scenes and characters in that which connect it with the lower features of humanity, and so preserve a relationship to the real, which no imaginative work, whether of Art or Literature, should be entirely without; whilst there are others, the creation of poetic fancy, which serve to lift us upwards into the realms of ideality; and make us the better for the enjoyment we receive. You will say we are soaring into the region of rhodomontade and losing the practical; but we may tell you that you need not feel yourself so strictly bound by rule in this style as in the others; your forms are not required to be so true to the modesty of Nature as they are generally; they may be made more effective by a departure from truth, or at any rate an exaggeration of fact. With those proportions which Nature has given to different objects of her creation you may deal freely, altering them to suit your own purposes of expression or effect. We will put before you Cellini, as the highest example in this walk of Art. Strictly speaking he is an ornamentalist; but he sometimes attempts high Art, where there is often with him a lack of correct proportion—for instance, in his statue of Perseus, where the over ornamentation hardly hides from a practical eye the want of proper balance of parts. Sometimes, indeed, in his metal works he uses his freedom as a license which serves the style to which his

work belongs, and so answers the purpose he has in view; he is rarely, if ever, quite natural, though always florid in his style, and always effective.

It will be impossible in a work of this kind, to write at length on the various styles, so we will content ourselves with touching on some of those styles which seem to have been much in favor at certain periods. To go into this matter extensively would require several volumes of greater dimensions than the present one.

As with all the arts, crafts and sciences, we get all our glimmerings from, or through the Egyptians, so everything pertaining to the earliest examples of furniture come to us from that source.

Many people imagine that the habit of sitting down, as practiced in this country and Europe, is a universal human habit, old as the race itself, and in no way associated with civilization. Investigations, however, have shown that the habit is acquired, and marks the highest notch of civilization and advancement; indeed, it is estimated that not more than 10 per cent of the human family practice sitting on the civilized plan.

Men who do not sit have two attitudes for resting; women use one of their own. Squatting on the heel is favored in India and China. In this position the weight of the body falls upon the toes, and to keep the balance comfortably the arms must hang over the knees, the hands dangling. The cross-legged attitude is general from Siam eastward, through the Malay countries. In

the jungle men crouch, the knees raised, the arms folded over them and the chin resting on the arm. The women

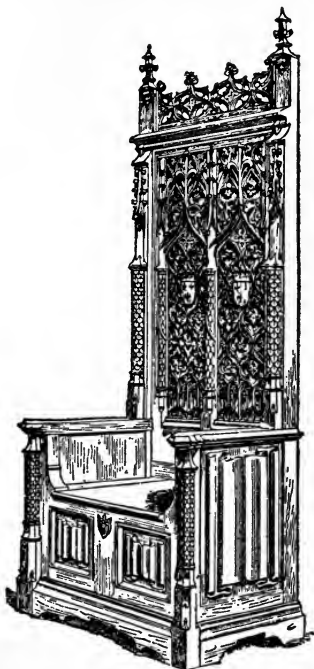

Figure 62

of that region rest upon the floor sideways, thus throwing the weight on the outer part of one thigh, not a very comfortable posture to a civilized Caucasian.,

As civilization advanced in Egypt the use of furniture became more and more necessary. First the rulers began with thrones and seats of honor for the kings and nobles; then the rich merchants followed, providing themselves with furniture less costly, perhaps, but equally as useful as that owned and used by State officials. The working classes and the poor were doubtless content to sit down on their mats of papyri stalks, under the shelter of their rough cabins of mud. The rich of the dynasties, dating from the twelfth to the thirtieth, furnished their houses with very costly furniture, which consisted principally of rich beds, or couches with their beds, or mattresses, pillows and cushions, and wooden head-rests, footstool stands, tables and chairs, both with high and low back; or folding stools, like the Greek *okladias*, boxes or chests for holding clothes and other objects. From the earliest period high-backed and other chairs were in use, and at the time of the eighteenth and nineteenth dynasties were imported as tribute from Ethiopia. Pillows of stone, wood and other objects were also of great antiquity, and are represented in coffins of the sixth and following dynasties. They exhibit a great variety of shape, consisting of a curved semi-elliptical portion, adapted to hold the back of the head, supported by a column or other contrivance resting on a base or pedestal. For furniture, various woods were employed—ebony, acacia or soft cedar, sycamore and others of species not determined; ivory, both of

the hippopotamus and the elephant, and used for inlaying, as also were glass pastes, and specimens of marquetry are not uncommon. In the paintings in the tombs gorgeous pieces of gilded furniture are depicted. For cushions and mattresses, linen cloth, feathers of water fowl and colored stuffs appear to have been used, while seats have plaited bottoms of linen cord or tanned and dyed leather thrown over them. Sometimes the skins of panthers were used for the purpose. On the whole an Egyptian house was lightly furnished and not encumbered with so many articles as are in use at the present day. For carpets they used mats of plain fiber, on which children and servants sat, or rather squatted.

The chest shown at Fig. 58 seems to have been a very popular piece of furniture, as numbers are found depicted on the tombs and monuments. The bedstead and ivory headrest shown in Fig. 59 were also common articles of furniture with the rulers and with the rich, and many of them were finely upholstered with handsome and costly fabrics.

The fragments of a chair shown in Fig. 60—are still in existence, and preserved in the British Museum, and show the remains of the veritable chair used as a throne by Queen Hatasu, a royal lady who made things lively for a while in the valley of the Nile some 1600 years before Christ and twenty-nine years before Moses. This is, so far as we know, the most venerable piece of wooden furniture in the world. There is in the Louvre,

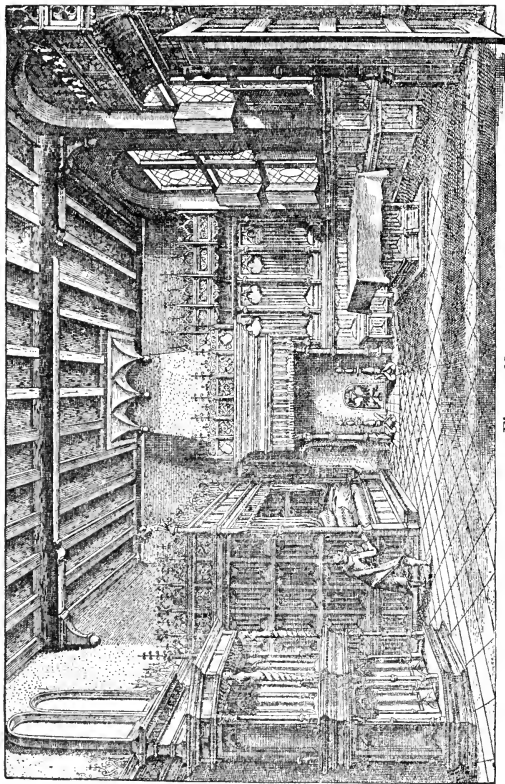

Figure 63

France, a metal chair, decorated and incrustated with mosaics, that is older by 400 years than the one exhibited. Hatasu's chair or throne, or rather what remains of it—as it is in a dilapidated condition and has to be secured with brass bands—is made of what appears to be *lignum-vitæ*, is of a dark color, like cocus wood, and is inlaid over all the carved portions with gold plates. The two sacred serpents, shown on the two uprights at the back, however, are not treated so, but, as the detail illustrates, with little silver rings sunk all over them; probably a conventional rendering of the snake skin.

The five articles of furniture exhibited in the group, Fig. 61, showing a stool, stand for a vase, workman's stool, head-rest and vase on a stand, are from photos of the originals in the British Museum. They are Egyptian examples and are more than 3000 years old. Nothing can be more suitable for its purpose than the "workman's stool." The seat is precisely like that of a modern kitchen chair (all wood), slightly concaved to promote the sitter's comfort, and supported by three legs curving outwards. This is simple, convenient and admirably adapted to long service. Besides these examples, there are in the museum several seats formed with cross legs on the principle of our common camp-stool, and all are well made and have the lower parts of their legs carved as heads of geese, with inlayings of

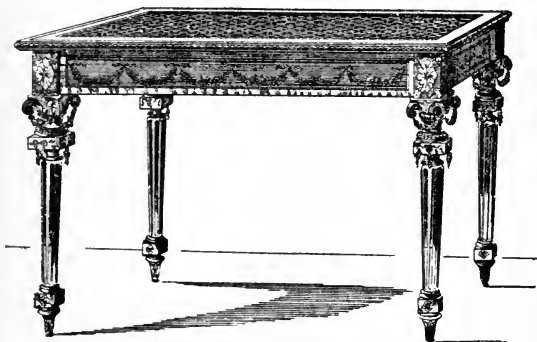
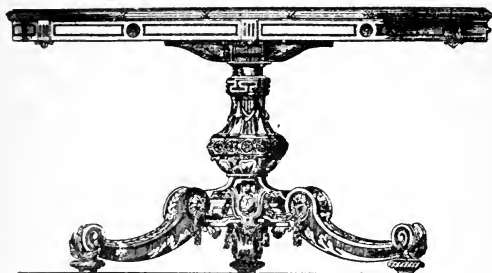

Plate IV



ivory to assist the design and give richness to the execution.

There are in the various museums many articles of luxury and comfort taken from Egyptian tombs, which demonstrate the extraordinary state of civilization and culture attained by these ancient people, that aid us in forming a picture of their domestic habits. Boxes, chests, tables and shelves in great variety have been unearthed, "some inlaid with various woods and with little squares of bright turquoise blue pottery let in as a relief; others veneered with ivory; wooden spoons carved in most intricate designs, of which one, representing a girl among lotus flowers, is a work of great artistic skill; boats of wood, head-rests and carved models of parts of houses and granaries, together with writing materials, different kinds of tools and implements and quantities of personal ornaments and requisites."

Indeed the more we know of the Egyptians the more we are led to believe that long before Greece or Rome were known they enjoyed a remarkably high state of civilization and learning, with all their accompanying advantages.

A figure given (in group) exhibit two very old chairs and a couple of Egyptian chairmakers at work, with some of the tools and materials scattered about on the floor. Here we see a square, a couple of adzes, and a drill in the hands of one of the workmen, who is bor-

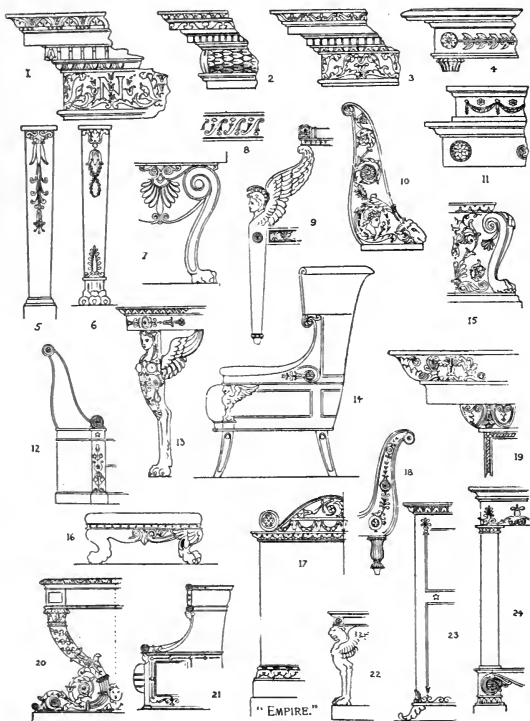

Plate V

ing a hole in the chair by using a bow to turn the drill. These tools are very much like the tools in use today. Several finished chair legs are seen on the wall. This carving on the walls of a tomb, was executed between two and three thousand years ago.

Furniture used by the Chaldeans, the Assyrians, Babylonians, Hebrews and other old nations, was of similar type to the Egyptian, as may be seen by referring to a number of illustrations shown, also examples of Greek and Roman furniture are given.

Some of the chairs shown are fine examples, and both are constructed on Egyptian and other lines. Later styles, or rather examples of later styles, are shown in Figs. 19, 20, the coronation chair, 28, and others shown in the first chapter.

The Gothic style in furniture began during the reign of Louis VIII, and St. Louis (Louis IX)—1223-1270; the style growing out of the Byzantine style of Architecture, and was introduced by the artists and craftsmen brought to France from Constantinople by the returning crusaders.

The thirteenth and fourteenth centuries had been remarkable for a general development of commerce; merchants had traded extensively with the East, and had grown opulent, and their homes naturally displayed signs of wealth and comfort that in former times had been impossible to any but princes and rich nobles.

Towards the fourteenth century, there was in high

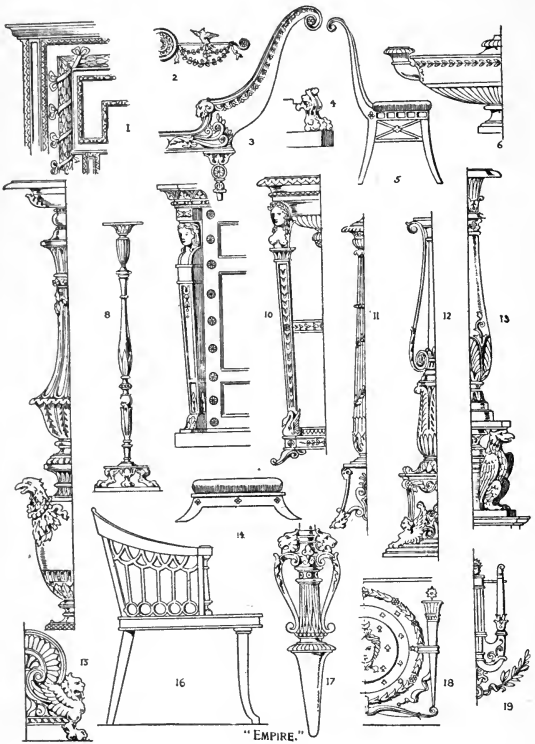
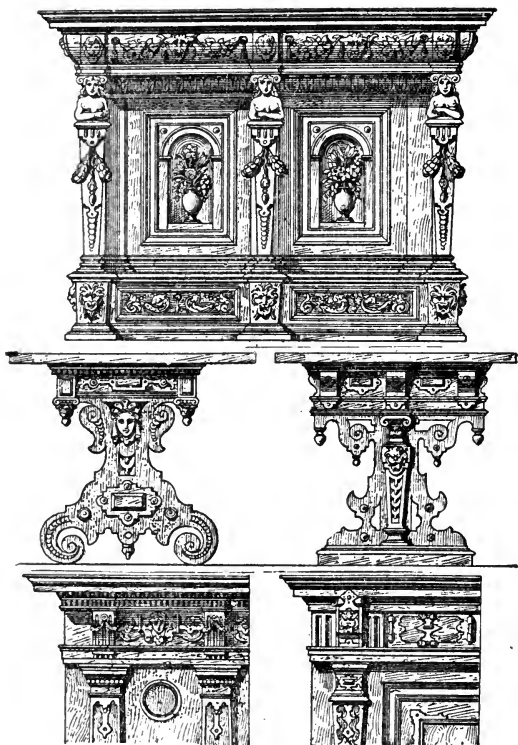

Plate VI

quarters a taste for high and rich colorings and we have the testimony of an old writer who describes the interior of the Hotel de Beheme, which, after being the residence of several great personages, was given by Charles VI. in 1388 to his brother the Duke of Orleans. "In this palace was a room used by the Duke, hung with cloth of gold, embroidered with windmills. There were besides rich carpets with gold flowers, cushions of cloth of gold, and summer carpets of Arragon leather."

As we approach the end of the fourteenth century we find canopies added to the "chairs," which were carved in oak and chestnut and sometimes elaborately gilded and picked out in color. The canopied seats were bulky and throne-like constructions, and were abandoned toward the end of the fifteenth century, for a somewhat smaller and less massive seat.

The high-backed chair shown in Fig. 62 is a sample of this style. Chairs, tables, beds and fittings were all made in this style and the interiors were rich in carvings, massive but stiff and informal. Plate I, exhibits a chamber in this style of the period of Louis XI, which shows a bed and several pieces of furniture. Fig. 63 shows a German chamber of a somewhat later date. The French carved bed with canopy, Fig. 64, is of the period of Louis XIV. It is an example that was much followed, and the fashion lasted well into the period of Louis the XVI. A gradual change in French furniture took place during the reign of Louis XVI, and the orna-



GERMAN RENAISSANCE.

Plate VII

mentation assumed the style as shown in Plate II. French furniture was continually changing in style, and we have early and late French, Louis Seize, and Empire styles, each of these having their changes, imitations and modifications.

Gilt wood, Chinese lacquers and their imitations by means of the varnish to which Robert Martin gave his name, are the preferred materials. Bronze mountings, set in the panels, and cut out in highly elaborate patterns, decorate the cabinets of Caffieri. The marquetry work of Boulle, made to conform with the prevailing style is continued by the heirs of the celebrated workman.

The ornamentation that is peculiar to the style of Louis XV. modifies the old elements and introduces new ones. A narrow but very much lengthened acanthus takes the place of the rich and broad acanthus of the Louis XIV.

This new form becomes associated with shells, rocaille, perforated stones. The development of the natural science, interest in which is manifested by the gathering of collections of shells, etc., has a share, together with the popularity of Dresden China, in bringing about the triumph of the style rocaille.

An interior of the style Louis XV. also includes the decorative Chinese fancies, the carved elephants of Caffieri's clocks; then the characters of Italian comedy, reminiscences of Watteau, and the little love sports

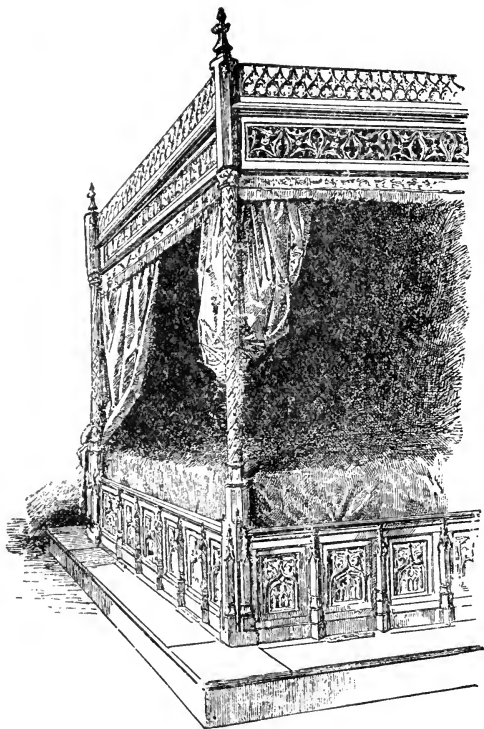

Figure 64



with pretty much everywhere, in Tapestry, ceramic jewelry, snuff-boxes, bon-bonnières, fans, transom panels, screens, and the many quaint and curious fancies peculiar to that era.

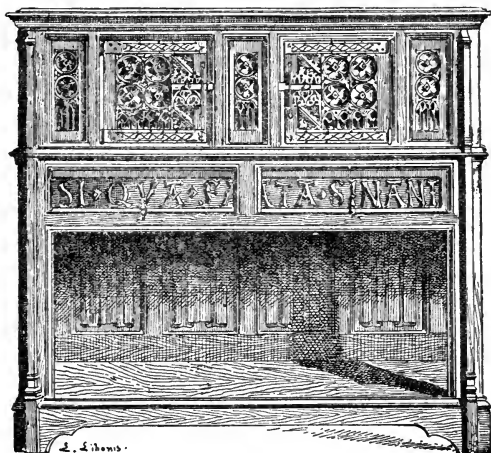

Figure 65

The cabinets, Figs. 65 and 66, and carved walnut bed, Fig. 67, of the fifteenth and sixteenth centuries are good examples of the work of those periods and offer many suggestions to designers, carvers and workmen. The bed shown in Fig. 68, was used by Pope Pius VII, at Fontainbleau, and is rich in decoration and costly drapery.

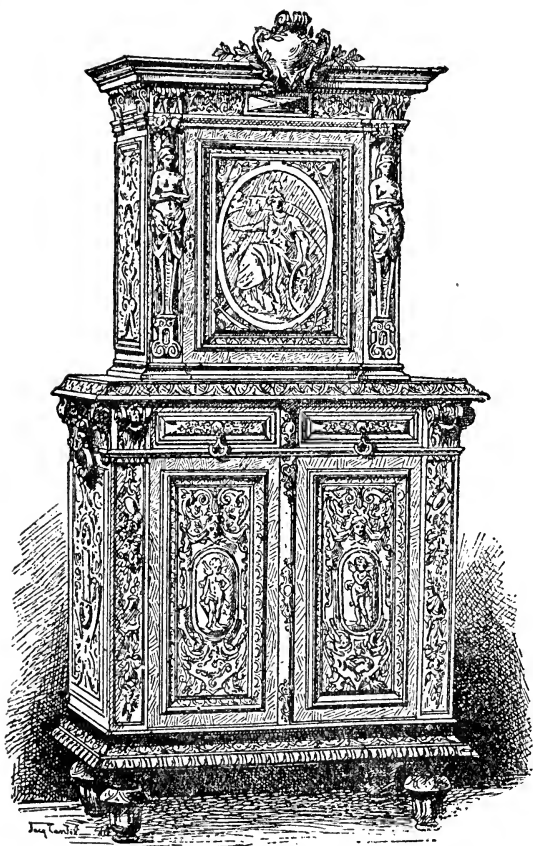

Figure 66

Plate III shows a whole series of details in Louis Seize style, from which the cabinet-maker may garner



Figure 67

many good things for nearly all purposes. Fig. 69 shows a cabinet in this style which is elaborately finished and decorated with gold. It is a thing of beauty

and was purchased for the museum at a cost of \$7,500. The table shown at Fig. 70 is a fine specimen of the style Louis Seize and is beautifully carved. Fig. 71 shows a good old-fashioned commode ornamented lavishly with gilt, bronze and inlay; the Louis Seize chairs illustrated in Fig. 72 are good examples of the period. They are finished in blue and gold and are very dainty pieces of furniture. These illustrations are drawn from photos of the originals now in the Cluny museum. A most beautiful piece of work is a little ebony cabinet, Fig. 73—now in the Kensington museum, which was made by the celebrated French cabinet-maker, Boulle. It is beautifully inlaid in the most exquisite designs and made nearly two hundred years ago.

Boulle, not to mention many others of the earlier period, was an artist; he conceived his own designs, he drew them out (the patent is given him in his name not only as a cabinet-maker, but as an architect and sculptor), he executed everything with his own hands; he was a chaser, engraver, and gilder; he was, as we see, a man of cultivated tastes into the bargain." When we add to his merit as a designer, and a delicate appreciator of the work of others, his merit as a good workman whose productions, without need of repair, are as stout in the present day, after two hundred years of use as they were the day they were made, it may be fairly conceded, even by the sternest rigorist, that Andre Boulle worked in what is understood as the true spirit. Not

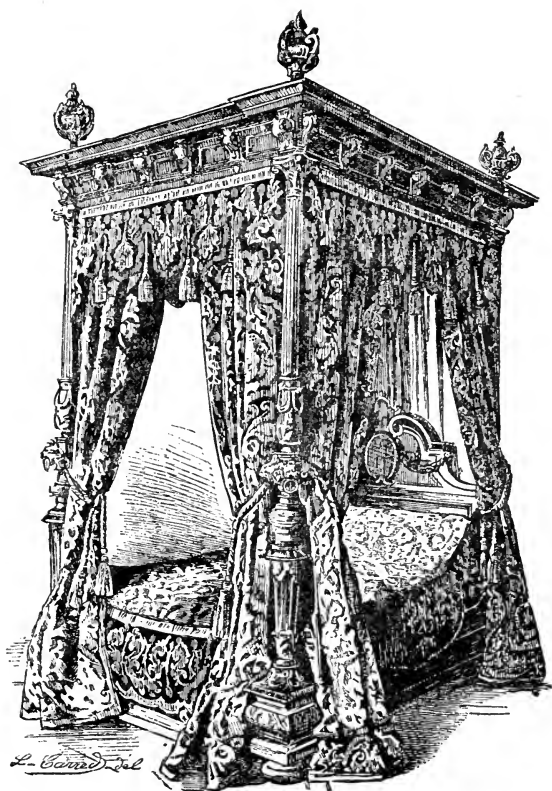

Figure 68

only in its construction, but in every feature, in the choice of the materials, in the chasing and gilding and the marquetry, his work will be found to be of the most honest kind, very different to the modern rubbish that passes under the name, where false tortoise shell, made of horn or gelatine; false mother-of-pearl, box or horn instead of ivory; brass or even zinc lacquered ornament tacked on to the ill-made joinery usurp the place of true work, whose only fault was that it was produced in a period when the traditions of art were on the decline. When Boulle used wood it was ebony, which the cabinet makers, his successors, on the plea of its difficulty in working, in taking the glue or varnish—Boulle never used varnish—and other reasons, replaced with stained pear-wood. In the choice of his woods Boulle showed the extremest care, and one of his severest blows was his loss, by the fire that destroyed his collection of prints, of a quantity of rare woods which he had, we learn from the inventory he made at the time, *long* stored by to season. The bronze he used was honestly chiselled and chased and gilt, not lacquered, and each ornament was a design not stamped out.

The secrets of Boulle's skill may be said to have died with their inventor, for though the traditions were continued, the sobriety and the grandiose style of the master will be found to be sadly wanting in all the work of his imitators. So much was this recognized that, throughout the last century, in all the sale catalogues the works



*W. Tucker junr*

Figure 69

by Boulle himself are conspicuously marked, more than one collector made it his specialty to gather specimens of the great cabinet maker's work.

Boulle died at the age of eighty-two (February 29, 1732) at his house in the Louvre, and was buried in the

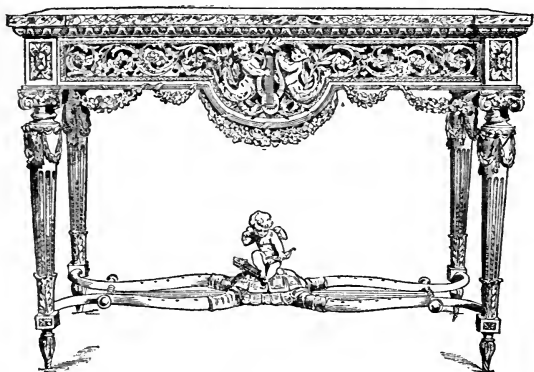

Figure 70

neighboring church of Saint Germain L'Auxerrois, leaving two sons to combine, only in name it is true, the traditions which he had in a measure positively created. One of the sons, employed at the Sevres manufactory, was, it would appear, the first to introduce, in the decoration of furniture, the use of porcelain.

Plate IV shows a couple of tables of the style of Louis XVI, which contain a number of very useful suggestions, suggestions that will be utilized in the manu-



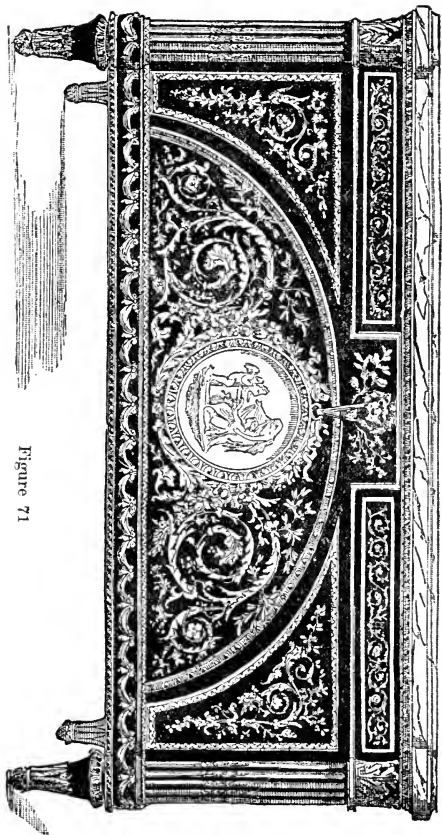

Figure 71

facture of modern Furniture, on similar lines, by some little modifications.

During the Marie Antoinette period, the most extravagant furniture was made and the most extravagant

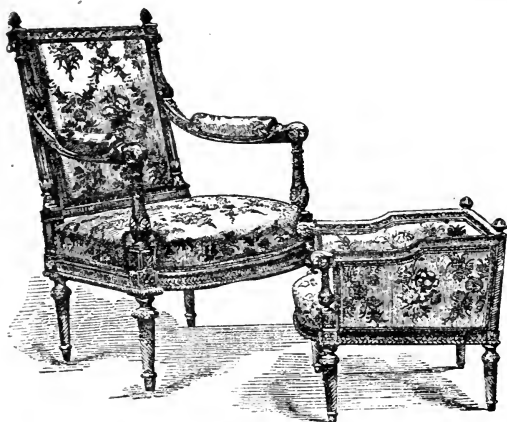

Figure 72

prices were paid for it, and some very handsome specimens were turned out. The little writing table shown in Fig. 74, was specially designed and made for the Queen, and cost a very large sum of money. This table is now in England and was bought some years ago for \$37,000, an enormous amount of money for so small a piece of furniture. An English writer who was at the sale, in speaking of it, says: "It amused me to notice

that it required a special attendant to guard this little specimen, so many were crowding round to inspect it.



Figure 73

It was literally mobbed as I tried to get a glimpse of it for my note book, and the adjectives showered upon it by the upper ten were the most expressive I have ever heard applied to furniture. It was oblong in shape, with a drawer fitted with inkstand, writing-slide, and shelf beneath an oval medallion of a trophy, and flowers on the top, and trophies with four medallions round the

sides. This was stamped J. Riesner, and branded underneath with cypher of Marie Antoinette and Garde Meuble de la Reine. This really beautiful article of fur-

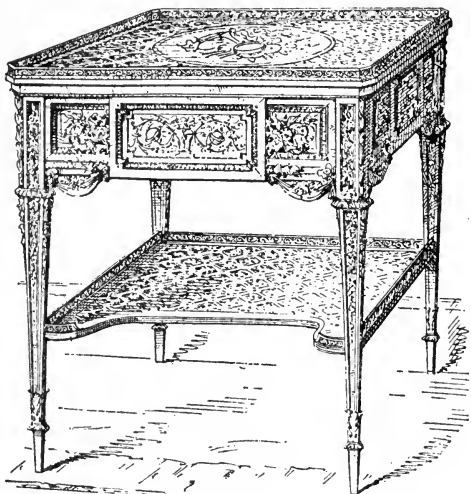

Figure 74

niture was exhibited in 1862 at the South Kensington Loan Exhibition. Three thousand guineas was the first bid for it, but it soon ran up to 4,500 guineas, at which price some dispute arose as to whose bid it was. This was settled by \$25,000 being offered, and the bidding continued till the price reached \$30,500, when, amid much applause, it became the property of Mr. Wer-

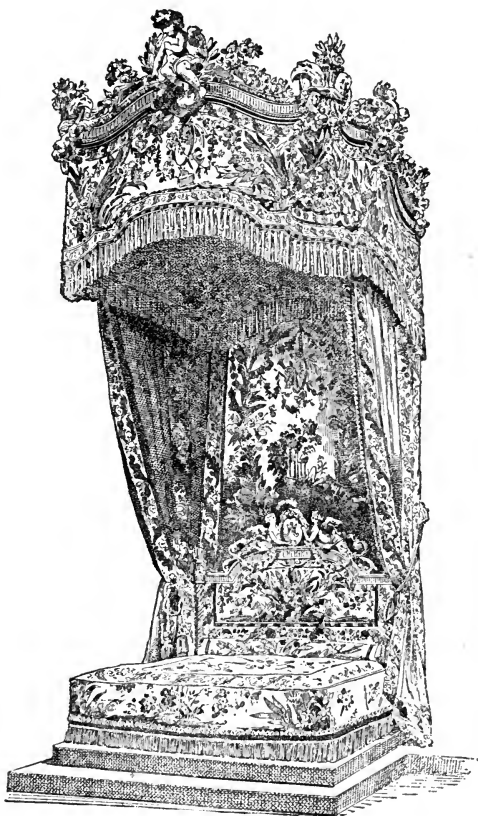

Figure 75

theimer. I anticipated that this little gem would realize a large sum, but the amount obtained for it is certainly fabulous. I can say, however, that the beauty of the workmanship must be seen to be believed."

Fig. 75 illustrates a bed introduced by Queen Marie Antoinette. This bed became quite popular for a time, but ran out of vogue during the revolution after which the Empire Style was introduced, when beds were specially designed for warriors, judges, statesmen and successful leaders; many of the beds were heaps of silly ornament and cumbersome and rich draperies. This phase of the Empire style did not last long, however, but gave place to a more sensible practice of construction and ornamentation. The two Plates, V and VI, show details and ornamentation in the better days of the Empire style. Plate V showing some of the best examples of the period.

The French revolution brought with it many good things—as well as bad, and it was really a blessing in disguise in many ways inasmuch as it cleared the way for better things among which may be mentioned the Empire style as represented in the illustrations and Plates shown herewith.

Among the many decorations in this style, quivers, torches, and armorial trophies were freely made use of, and this tendency to make ornament subservient to the general form, of which it should always be only the complement and accessory, so far from diminishing in

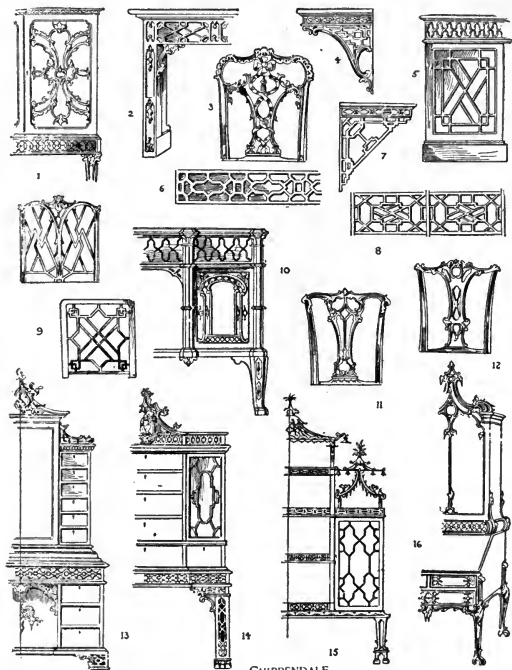

CHIPPENDALE.

Plate VIII

the next age, became accentuated, as the following illustrations of "Empire" will demonstrate. It had forced itself into fashion, and opened up fresh fields



Figure 76

and pastures new for the courageous decorator. Its promoters had gone to draw inspiration from the philosophical world of antiquity, and they studiously attempted to revive antique rules, traditions and customs, many of which were inconsistent with modern life. The broad-backed chair (Fig. 76) makes a fine looking, comfortable seat. Cleverly hollowed out to catch the back and support the shoulders, it proffers the acme of comfort, without, at the same time, being stuffy.



Passing to Fig. 77, we find a form of couch which was at one time very popular in this country. It reminds one of the old "high-low" designs which used to be the fashion in the "early fifties," and there is no doubt that this choice of a resting pad proves a comfort to the sitter who is dainty in the matter of position.

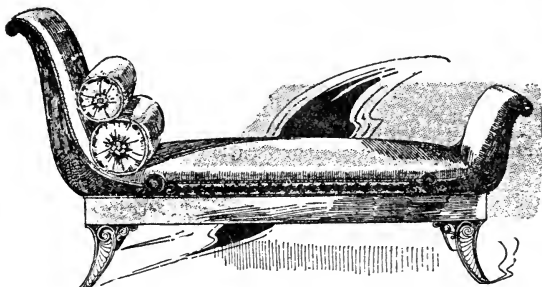

Figure 77

This design, which is without a back, is evidently for use rather than display. Before passing from this design we cannot help noticing the increased opportunities which it gives to the chair or settee frame maker, as he has been too much in the habit of hiding his work with ostentatious upholstery. The small table (Fig. 78) is for decorative rather than useful purposes. The design, if well executed, adds unusual classic dignity to the center of a room, or as a choice corner-piece. This belongs to the class erstwhile known as the "loo" table, and has been in the background of late years. It is

still in vogue in its larger forms as a dining-table, and those who still possess one will enthusiastically tell you that for a small dinner party there is nothing compar-

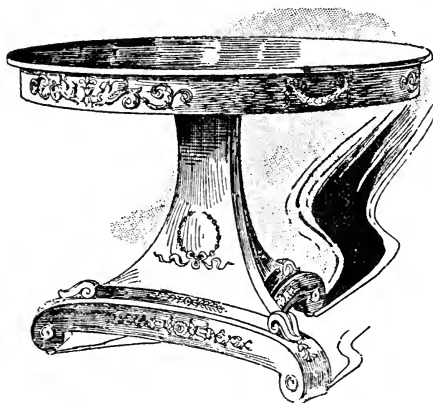
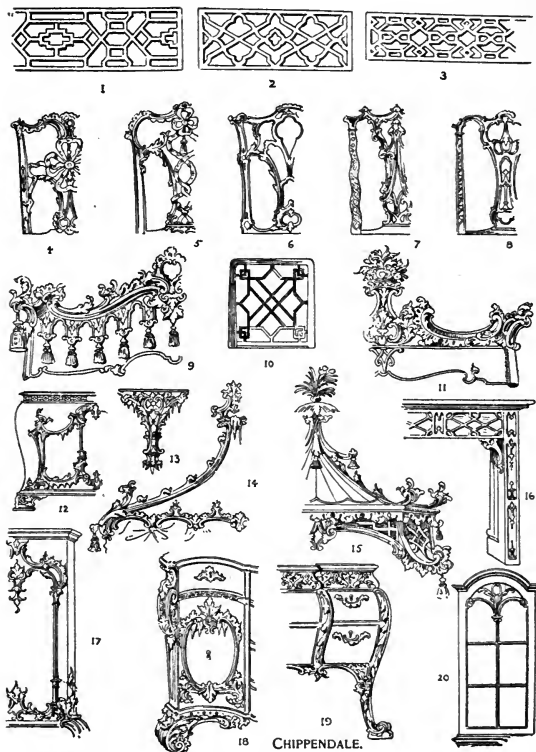

Figure 78

able with our circular friend. The outward bend and consequent placing of one's neighbors right and left, in a position where conversation is enjoyable, renders the round table unrivalled for the party of six or eight.

There is a sturdiness about German furniture, that does not obtain in French or in the furniture of other Latin races, as may be seen in the examples shown on Plate VII, where five pieces of German Renaissance are illustrated. True, these pieces are not so dainty, or so exquisitely beautiful as much of the French work, yet,



CHIPPENDALE.

Plate IX

they have a dignity of their own, and the carvings are stronger and more vigorous than those of French pro-



Figure 79

duction. The Frontispiece of this work shows a very fine example of German work, and is quite modern, both in style and construction.

The German bed shown at Fig. 79 is quite a solid looking piece of furniture, but has an inviting and comfortable appearance.

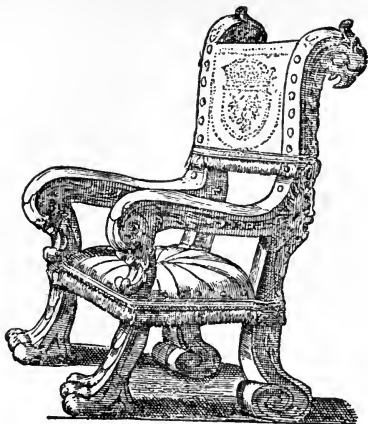

Figure 80



Figure 81

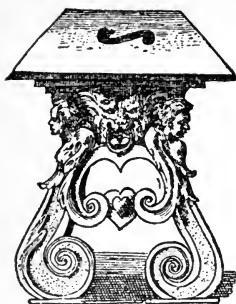

Figure 82

The two old German chairs shown at Figs. 80 and 81, are comfortable even if they are heavily built and ponderous looking. They are substantial and strong. The little table, Fig. 82, is characteristic of old time German work. The bed shown in Fig. 83 is drawn from a photo taken of the bed used by Napoleon, and his consort, the

unfortunate Josephine. It is said to be a very comfortable bed to rest in and there are many like it still used in France.

The sturdy old chair shown in Fig. 84, is from Spain. In form, the chair is of course, common enough; but a new idea may be gathered from the upholstery. It consists of stout velvet, stuffed properly with feathers, and quilted after down-quilt fashion. It is fastened to the walnut framing with "extra size" brass studs, and some negligé trellis fringe is added to finish. It seems to me that such quilted upholstery might be applied to many modern chairs where shallow stuffing is desirable. If hair is substituted for feathers, a comfortable and pleasing result could be obtained without the stiffness and fragility of bottoming. Altogether this old chair looks commanding as the center-piece in the large glass case in which it is preserved.

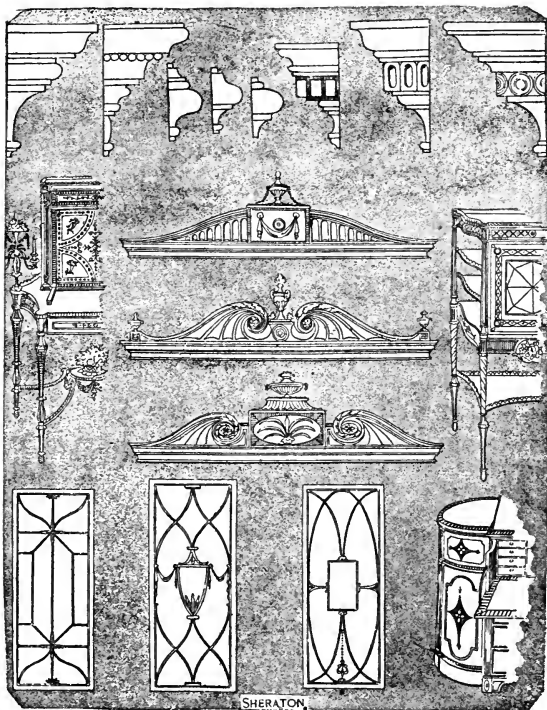

Plate X

We may now safely turn to English, and American furniture, and its makers, of the eighteenth, and the latter part of the seventeenth centuries, which were the periods of the most artistic work. In the earliest work, the lingering of Gothic and early Renaissance principles of construction gave a repose of line and appearance of stability and permanence often lacking in French

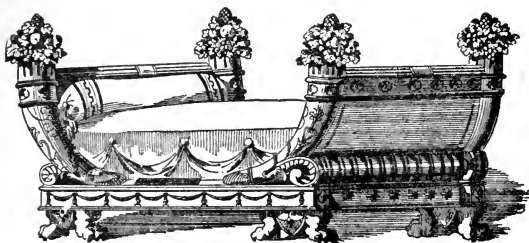

Figure 83

furniture of the same time. French eighteenth-century furniture, though in reality very substantially built, is apt to have a fragile appearance, and every one knows that the grace and freedom of its curves are only to be had at the cost of a considerable loss of strength. In keeping to simpler and more rigid forms the English and American makers were preserving good traditions, and if their ornamental systems were seldom appropriate or in pure taste, at least good workmanship and careful finish cannot be denied them.

Among the accompanying designs of furniture, the



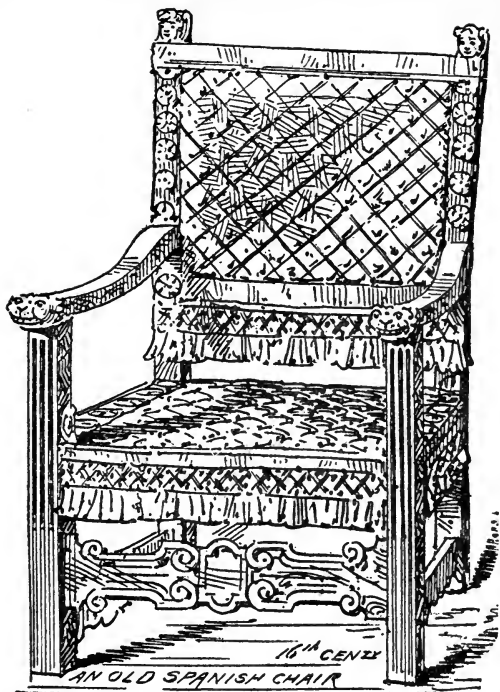

Figure 84

large bookcase, Fig. 85, as will be seen by the plan, is very simple in construction; but what a hotch-potch the designer has made of Gothic-looking clustered columns, false pediment with olive mouldings, and classic

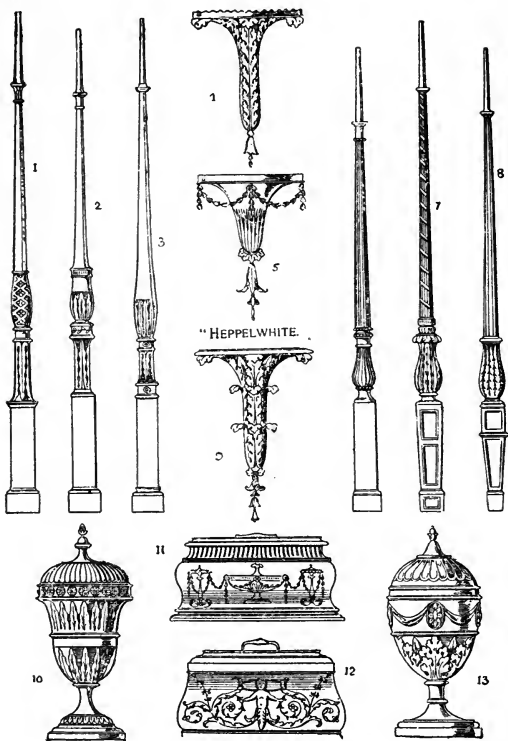

Plate XI

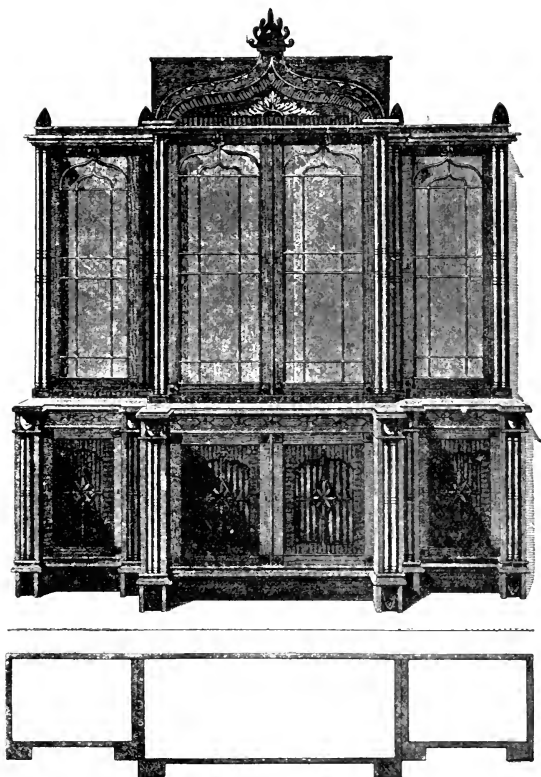

Figure 85

aeroteria. The other bookcase, Fig. 86, solid shelves alternating with closed cupboards, is again of sensible general design; but, though its proportions are much

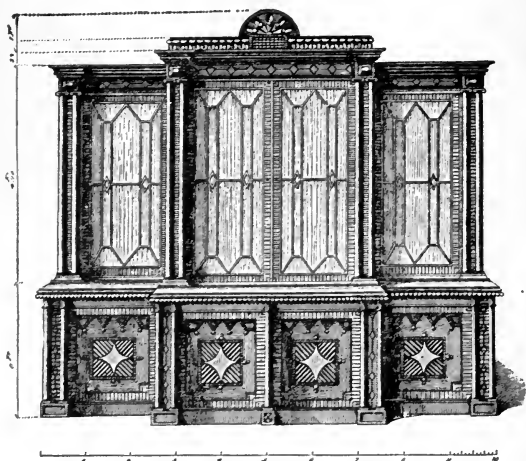

Figure 86

better, there is a mixture of ornamental motives which strikes the eye as incongruous. The pretty rococo crestings, to which, if cast in brass or gilt, no one need object as a finish for the top of the piece, are still not in keeping with the severe geometrical tracery of the panels and sash lines. The two end cupboards especially are out of all harmony with the center form of the pediments.

In less elaborate pieces of furniture, however, a happier result was often arrived at.

The two night tables by Ince and Mayhew, Fig. 89, show, that to the right the pure French style; that to



Figure 87

the left the English taste in an uncommonly straightforward example. Nothing has here been borrowed of the French but its lightness and finish. The geometrical tracery is not put out of countenance by the very discreet introduction of rococo foliage scrolls at the feet and supporting the raised parts of the slight rail. One feels how much more comfortable an object it is than

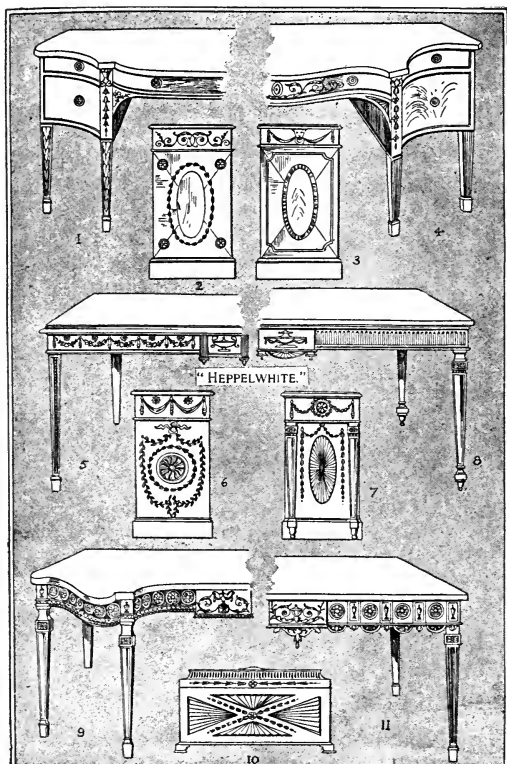

Plate XII

its neighbor, which, though really as soundly built, has an air of being in full dress, and not to be familiarly treated. The supper Canterbury and stand by Sheraton

are likewise simple and of a sturdy elegance. It is in such pieces as these that we have the best work by the best workmen. A father and son, under the firm title of Wm. Loyd & Son, Boston, Mass., made a lot of work of this kind before the revolution, and many pieces of this work found their way into Philadelphia and the south as far as Georgia; and was quite common in the

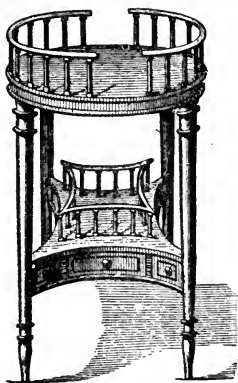

Figure 88

New England States, New York, and New Jersey. Odd pieces are occasionally found in some of the old colonial houses. This work may be known by the two letters L and B, which are usually found burned in some out of the way place on the specimen. The letters were rudely cut in the brand.

Chippendale the greatest English designer and cabinet maker revolutionized the styles of furniture and introduced many new features that seemed to take hold

of the people and stay by them, and his contemporaries and immediate followers kept the public favor by designing on lines somewhat similar to those of the master. Along with the meritorious things Chippendale designed there came a lot of stuff that was frivolous and



Figure 89

almost absurd and showed how the artist must have been lost in the struggle after novelties. His imitators were as faulty in many of their productions, and Sheraton, Heppelwhite, Mayhew, Ince, and even the Adam brothers, left much work behind them that had but little merit. I do not wish it to be inferred that I am



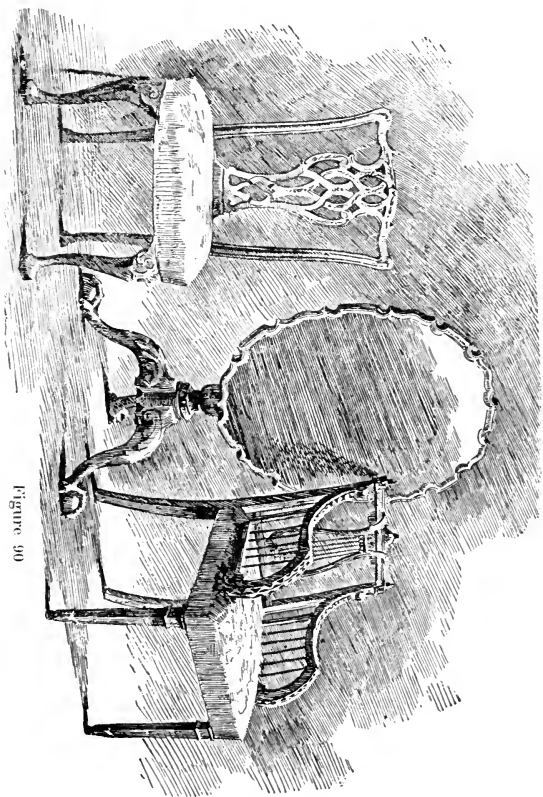

Figure 90

inveighling against the artistic merits of Chippendale and his coadjutors, I only speak of his shortcomings as a reminder, that even Homer himself sometimes nods.

The chairs and table shown in Fig. 90 are fine examples of the masters' work and are really handsome designs, and paragons of good construction and faithful workmanship.

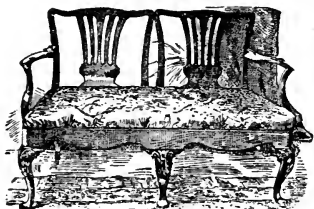

Figure 91

We show two plates—Nos. VIII and IX of Chippendale designs, which, with what we have shown in the foregoing pages, will enable our readers to recognize this master's work at sight. Plate VIII, illustrates some of his best work, especially the chair backs shown at 11 and 12. The other backs shown 1, 3 and 9 are not so chaste but are favorites with some people. The designs shown on Plate IX, are very clever, and in some instances, beautiful but are not by any means up to the best standard of Chippendale's work.

Perhaps on the whole, Sheraton, was as popular as any of the great English masters, and in our opinion,

justly so, for his work was, in many instances, as chaste in design, as finely finished and much more substantial in construction than the work turned out by Chippendale or Heppelwhite. Sheraton succeeded Chippendale



Figure 92

in fashionable esteem, and was a more sober and elegant designer. His pieces never offend the eye, but, on the other hand, they are not so characteristic as those of his less artistic predecessor. The double chair, Fig. 91, covered with a piece of Aubusson tapestry, is in his style, though it may not be of his make. He was very ingenious in inventions of the sort, and numerous contrivances for getting double service out of chairs and tables, are ascribed to him. The sofa, Fig. 92, is an excellent example of the same taste, for the alliance of straight lines with refined curves, on which his fame chiefly rests; indeed, reticence in ornament was his study.

The sofa shown in Fig. 93, is a dainty work both in design and finish, and is a typical Sheraton. The two

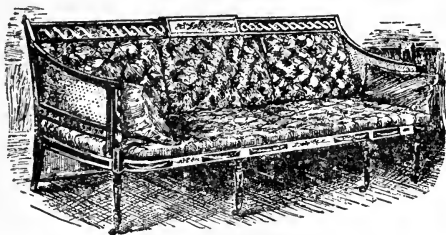

Figure 93

settees shown at Fig. 94 and 95, are Sheraton's work and are good examples of his style on furniture of this

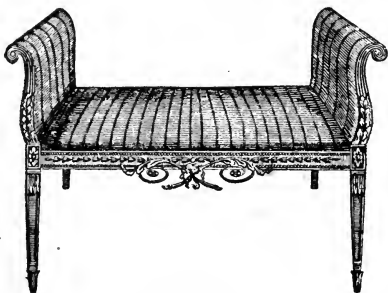
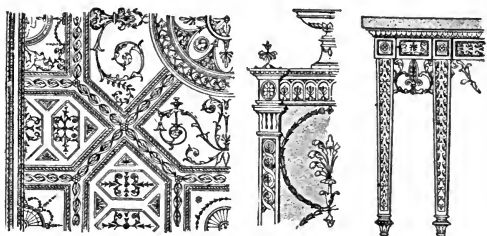

Figure 94

kind. They are evidently derived from the sofa of the period, diminished in size and robbed of its back.

The Sheraton table (Fig. 96) is a beautiful specimen



ADAMS' STYLE.



Plate XIII

of its class, well worthy of reproduction, notwithstanding that the center-table is at present out of favor. The diagram, Fig. 97, explains the somewhat unusual construction, and shows how the problem of drawers in a circular plan has been solved. The fictitious quadrant-

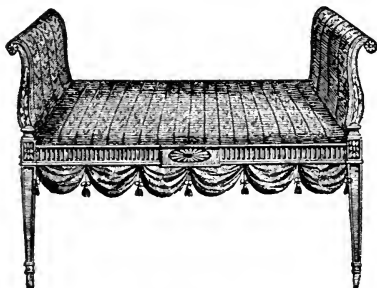

Figure 95

drawers are really little cupboards, as is indicated in the working drawing. That any manufacturer to-day would invest the labor needed to make this table properly, is perhaps, doubtful; yet the elements of its construction deserves study and adaptation.

The little table, and the arm-chair shown at Fig. 98, are fine chaste specimens of the Sheraton period and could well afford to be imitated. If space allowed we would very much like to publish three or four plates of Sheraton's designs, but we have already devoted more space than we first intended, so in this case we offer one Plate, X, which shows up quite a number of Sheraton's

best designs; and these, along with the figured illustrations, will, we think, make sufficient exhibits for one purpose.



Figure 96

1166-170  
Plates XI and XII show some fine examples of Heppelwhite's work. These are choice specimens of this style, and show up some very good work. Plate XII exhibits six sideboards, four pedestals, and a tea chest by Heppelwhite. The dimensions of the sideboards

are:—Length, from 5½ ft. to 7 ft.; height, 3 ft.; depth, 28 in. to 32 in. The notes referring to Nos. 5, 8, 9, and 11 state that “the ornaments to the fronts . . . may be carved, painted, or inlaid with various colored woods.” The pedestals were made of the same height as the sideboards, were generally about 16 in. or 18 in.

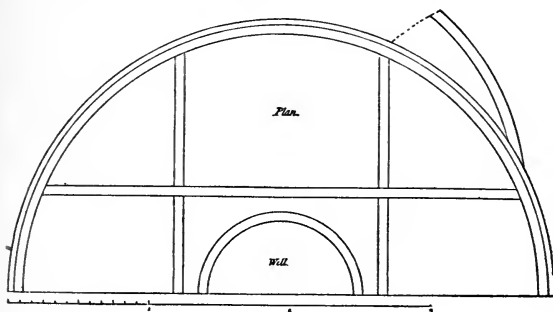

Figure 97

square, and were often surmounted by vases from 2 ft. to 2 ft. 3 in. high. The ornamentation of the tea chest may, according to Heppelwhite's book, either be inlaid, or “painted and varnished.”

Heppelwhite, while he did not reach the height in public esteem that Chippendale and Sheraton did, his work was much sought for and enormous prices were paid for examples, and to-day, when fashion has changed somewhat, well authenticated examples command prices that place them beyond the reach of or-



dinary purses. Cases are quoted where a single chair brought as much as 200 dollars. The designs which we illustrate could, probably, be reproduced for one-

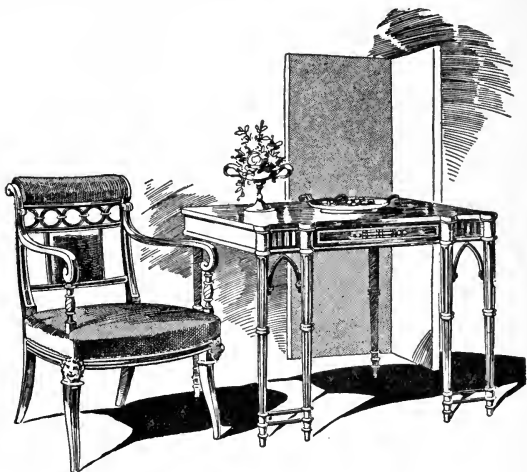

Figure 98

third of that sum, and with the carving omitted for still less. That is assuming that costly wood, like rosewood or mahogany, is exacted, and providing for the very best workmanship; quite as artistic results may be obtained as in those of the originals.

The most notable difference between the chairs of Heppelwhite and Chippendale is that the latter affected the large square backs and ultra-French details never

to the taste of Heppelwhite, who in his own book says: "Our idea of the useful, in such articles as are generally serviceable in real life, is to unite elegance and utility, and blend the useful with the agreeable"; this as he elsewhere points out, was better attained by allowing

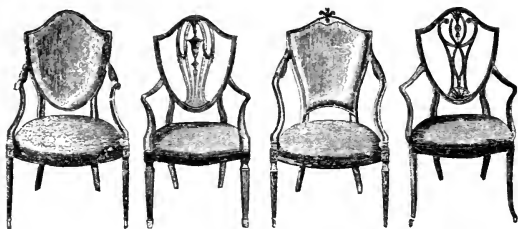
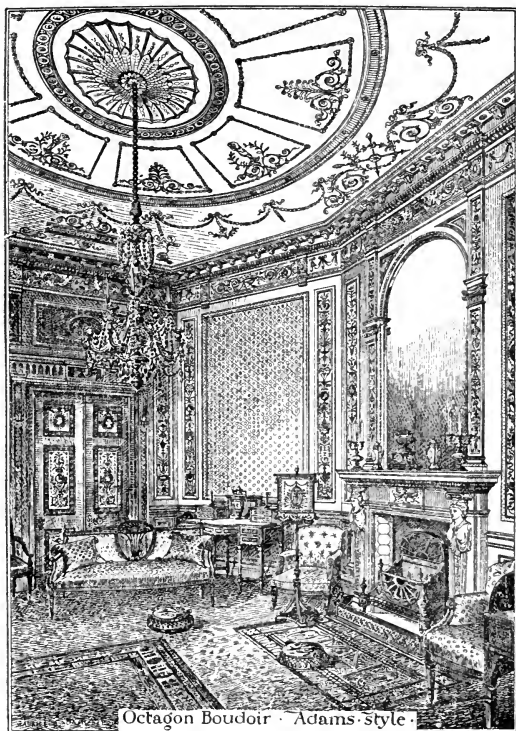

Figure 99

English taste and workmanship full play, than alien styles too literally with many anacronisms. The four Heppelwhite arm chairs shown in Fig. 99 are fair samples of the style and show in them, the peculiar characteristics of the Heppelwhite treatment.

The general dimensions of Heppelwhite's chairs are 19 or 20 inches for the width of the front; for the depth of the seat and length of seat frame, 17 inches each, and the total height about 3 ft. 1 in. He especially prided himself on the painted "japanned" decoration in his actual productions; yet in writing he disclaimed the mere novelty of such fugitive decorations and most strongly recommended the more durable method of in-



laying, although he confesses the former was pretty enough while it lasted. This divergence between theory and practice has always ruled in furniture, for, chosen

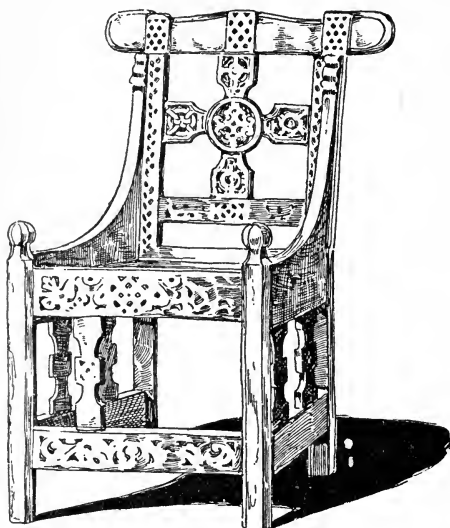

Figure 100

solely for its fashion and appearance by most buyers, no absurd innovation has failed to find a responsive purchaser.

Perhaps, of all the styles of furniture known, there is not one of them that appeals to the refined artistic feelings more than that evolved by the Adam Brothers

—Richard and James—who, in their early youth, became recognized as masters of elegant design. At this date, it is practically impossible to obtain a copy of their works, and to look them over Students are obliged to go to some National Library. There are copies we believe in the Lennox Library, New York, but we do not know of any other original work of theirs in the United States or even of copies of them. Examples of the work of these two men are scarcely ever found in the market, but when such is the case, the demand for them is so great that ridiculously high prices are paid for their possession. The efforts of these designers were secured altogether by royalty and the Nobility, and this accounts largely for the scarcity of examples.

Plates XIII and XIV, show a few examples of work in this style. Plate XIII shows a number of details for furniture and general house finish. Plate XIV shows a portion of an octagon Boudoir in this style, with several pieces of furniture and fittings. This style is better known as “The Adam’s Classic Style,” and is very beautiful indeed.

With this (Plate XIV) we will close this essay on “style,” as those we have mentioned cover pretty nearly all those various modes of construction and decoration worthy of the name of “style.”

We have not said much of the “Gothic Style” for this is not supposed to be employed—only for church work, though sometimes it is made use of in dwellings for

the clergy, or similar purposes. We may have more to say of "Gothic," later on. The "New Art" or "Art Nouveau," which was in such vogue a few years ago, was simply a "fad," and is now dead, and properly so—and is not likely to be even resurrected. We devote one Plate, XV, to this fad, so that posterity may have some idea as to what "Art Nouveau" was, "once upon a time."

### L'ART NOUVEAU.

Methought I had a curyous dreame, though, certes, I  
doe wot

That thynges are seldome what they seeme, whether in  
dreams or not;

Yet I dyd see soe vyvydly what I wyll eke rehearse,  
I wyst some lesson there must be yn thys, my humble  
verse.

Yt soe befell upon a daye ye desygn I'd conceyve,  
I drew yt not for Art, buy paye, my fortune to retryeve;  
I took yt to a fact'ry wyght, syth he was kynd to me,  
I thought he eke yn kyndness myght some meryt yn yt  
see.

Yet whyle he lookt wyth curyous eye my spyryts 'gan  
to synk,

When he upset quyte suddenly ye bottle of black ynk;

Yt tryckled down ye desygn sketch yn streamlets long  
and deepe  
Ere blotting paper I could fetch, and I was fayne to  
weepe.

But he, thys knowen fact'ry wyght, exclaimed, "I have  
yt now  
Thys accidente has thrown ye lyght, yt eke has shown  
me how  
To make ye fortune for ye, boy—come to my happy  
breaste;  
I chortle yn my newe-found joye, of golde thys ys a  
neste!"

Effsoones, he bade me goe my waye, with conge cour-  
teous,  
And ever synce that fateful daye I've been vycictoryous:  
For I have gotte ye piles of cash, of gold ye goodly sto;  
Some people saye my desygn's trash—I call yt l'Art  
Nouveau.

"The Mission fâd, is nearly as unartistic as the "Art Nouveau" and because of its easy construction, is likely to become more popular. This should be called "The carpenter style," for every carpenter having a fair knowledge of his trade, should be able to make almost any kind of "Mission Furniture." This style has no Artistic merit other than its simplicity and honesty.

For some purposes, the furniture made in this style becomes quite suitable and appropriate.

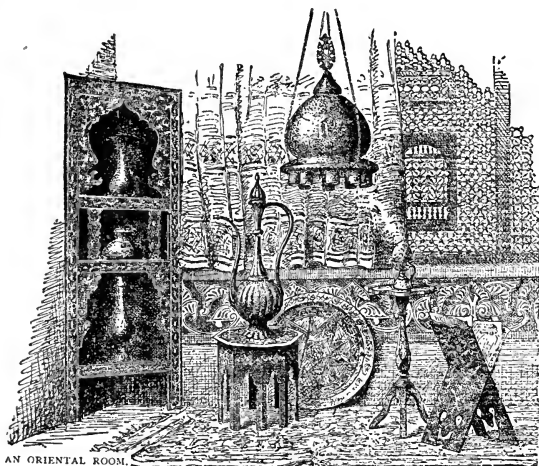

AN ORIENTAL ROOM.

Figure 101

On plate XV, a number of picturesque examples of "Swiss work" is shown. We offer these examples because of their artistic features, and their appropriateness for articles of furniture for sea or lakeside cottages, or bungalows. All these articles shown are easily made and as easily kept clean if left in a natural condition.

Fig. 100 shows an old Scandinavian chair which exhibits good solid workmanship. Fig. 101 shows a room





PICTURESQUE EXAMPLES OF SWISS WORK.

Plate XV

fitted up in oriental style with a few pieces of oriental furniture shown where some idea as to the shape and style of decoration of such furniture may be gleaned.

Fig. 102, shows an ebony "Koran" holder, from

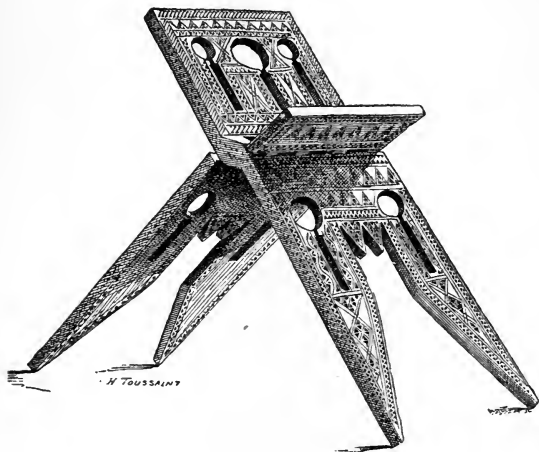

Figure 102

Algiers. This is a beautiful piece of work, the inlaying all being done in pearl and ivory.

Fig. 103, shows an old Italian chair. This is quite ornate, but is doubtless, very comfortable.

The chairs shown in Fig. 104, are of old German type and are, without doubt, a pair of cosy, comfortable chairs. The woodwork on them seems to be ash, but is

dark with age. The stiff prim looking chair shown in Fig. 105, is of old Dutch parentage, and has a stately, if not a lordly appearance.

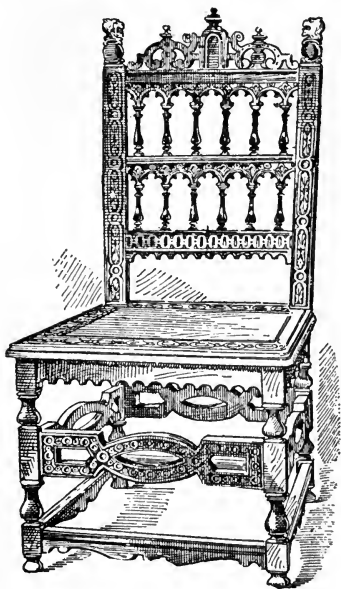

Figure 103

Fig. 106, shows another old Dutch chair, with cabriole legs. This is rather a pretentious affair. The Italian chair shown at Fig. 107 is of late Italian Renaissance style and is overloaded with unnecessary and

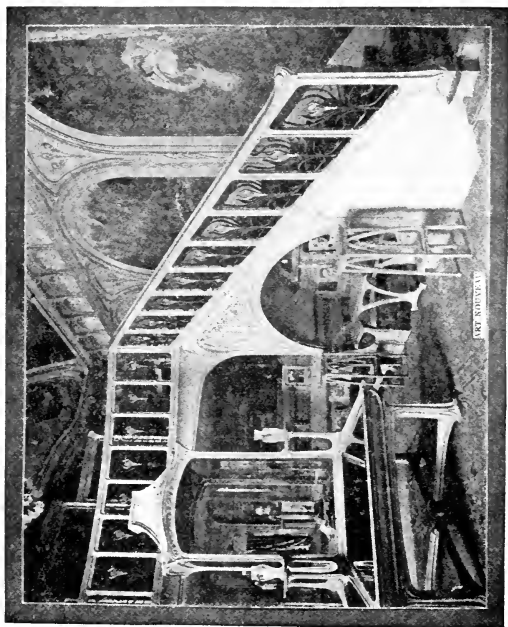

Plate XVI

frivolous carvings. It is a comfortable chair to sit in but is unwieldy and ponderous. Fig. 108, exhibits a neat German chair suitable for a library, den or even a hall. The carving on it, is chaste and excellently wrought.

The little writing table shown at Fig. 109 is one of

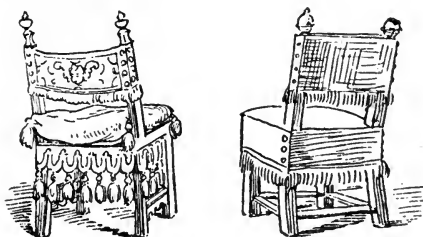

Figure 104

the most dainty pieces of furniture in existence. It was probably made by Oeban or Riesner and shows the most exquisite workmanship. As a mere matter of value it would probably fetch about thrice its weight in gold. It is throughout a model of the finest art workmanship, within and without; the beautiful marquetry panels; the elaborately chased metal mounts; the choice little porcelain requisites might each form the subject of a special essay. The table has only to be seen to be coveted. We are convinced that nothing we have seen of this description before or after, can compare in elegance and beauty with this little *escritoire*, once used by Marie Antoinette.

The table shown in Fig. 110, is German, and has a massive characteristic look, it is intended for library purposes. Fig. 111 shows a work table made for the

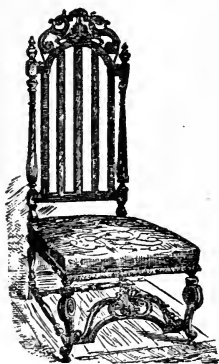

Figure 105



Figure 106

ill-fated Marie Antoinette and is considered a gem in its way and has a value far beyond the reach of ordinary mortals.

The table shown in Fig. 112, is in Mahogany and was executed for the war department, Washington, D. C. It is a fine specimen of American workmanship. It was made in Boston, Mass. The dainty little writing desks shown in Figs. 113 and 114, are of French manufacture of the period of Marie Antoinette, and were the forerunners of many of the present beautiful writing desks that are being made now by the thousands in

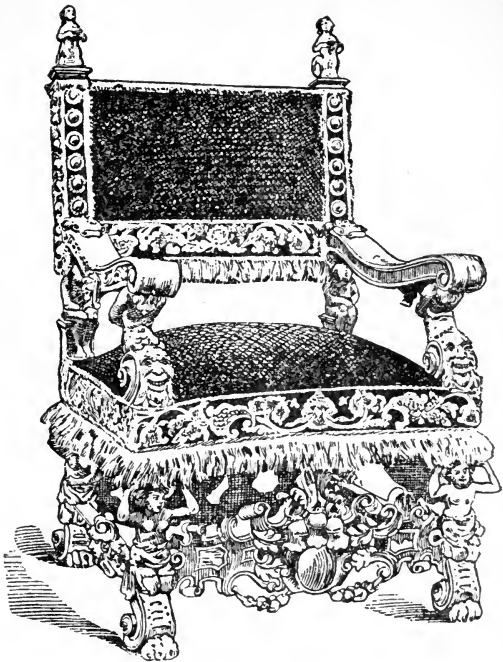

Figure 107

some of our Cabinet factories. They are worth imitating as they contain many features of beauty and good taste.

Stepping from chairs and tables to cabinets we have a large field to gather from, but it is not our intention



Figure 108



Figure 109



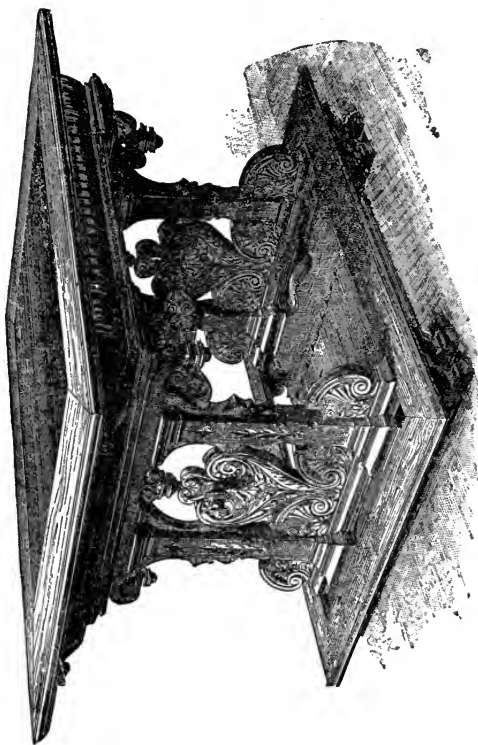

Figure 110



Figure 111

to deal at length with these articles, so a few examples must suffice. The Cabinet—or Armoire, as it is called in French—shown in Fig. 115 is said to be one of the finest pieces of woodwork in the world. It was designed

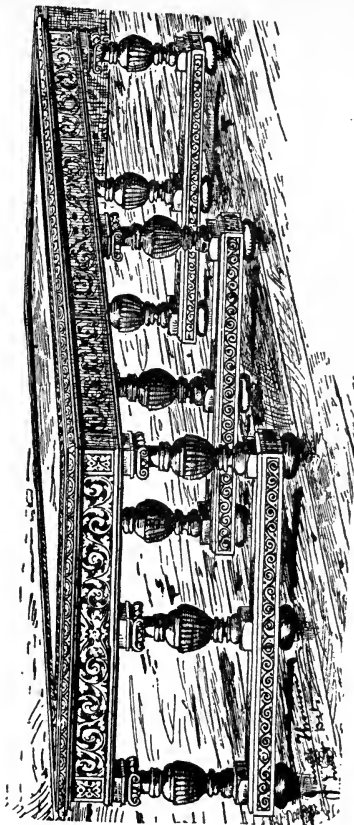

Figure 112

by Berain, and executed by Boulle, for Louis XIV. The delicacy and beauty of the coloring of the inlaid brass work, in metal of two tints, the boldness of the arabesque work, and the fine proportions and unusual

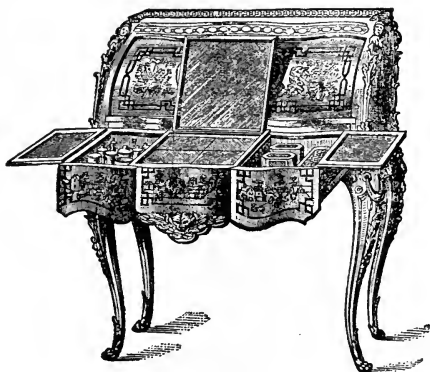

Figure 113

size of the cabinet, entitles it to the place of honor awarded it.

The German cabinet shown in Fig. 116, is a very fine example of workmanship, and nearly equals the French work in Artistic merit. The cabinet shown at Fig. 117, is not given for its beauty, but because of the usefulness, and combined purposes. It is in Queen Anne style and may prove suggestive, if nothing more.

The two cabinets shown at Figs. 118 and 119, show

two very fine cabinets well suited to receive curios and artistic trinkets. They are artistically designed.

Wall, or hanging cabinets, are very useful articles of furniture, and designs for them are numerous—

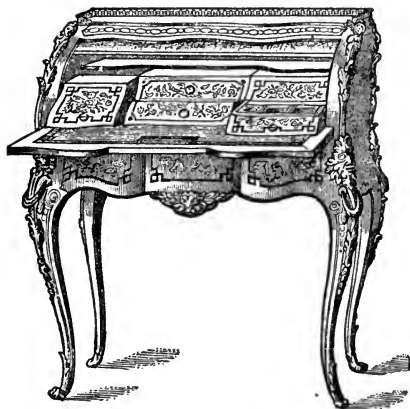

Figure 114

many of which are good—but we give a few herewith, which we think possess several good features. The two designs shown at Fig. 120 are very simple but very effective. The same may be said of the three designs shown in Fig. 121. These latter may be used for cabinets to hang on a flat wall, or for corner cabinets.



Figure 115

## SYNOPSIS OF STYLES.

The Gothic style followed the Romanesque or round-arched. In France and England it developed towards the end of the twelfth century. In this country the Decorated Gothic was the second stage (during the fourteenth century), and the Perpendicular Gothic followed in the fifteenth.

The Moorish or Saracenic developed in the eighth century. It was the style of the Mohammedans. A feature of the style is its extraordinary geometrical combinations. The Alhambra (Granada), built in the thirteenth century, is considered the most perfect specimen of architecture in this style.

Francis I. belongs to the Early French Renaissance (1515-1549). It is freely ornamented Gothic, developing under Italian influence. Its feature is a minuteness of detail. The palace of Fontainebleau was built in this style by Francis I.

Henry II. (Middle French Renaissance), who followed Francis I., developed the existing style along lines of greater purity, more closely resembling the original Italian. Many of the details in this style are applicable to modern requirements.

Henri IV. brings us to the period of the Late French Renaissance (1589-1610). A study of the illustrations following will clearly show the tendency of the time, preparing the way for the magnificence of the Louis XIV. style (treated later).



Figure 116

Louis XIV. (1643-1715). Magnificence in decorative designing. The era of Chas. le Brun, Andre Chas. Boulle, Jean Berain, Jean Le Pautre, and Daniel Marot.

The Regency (1715-1723). The period during the



minority of Louis Quinze. Elaborate detail is noticeable.

Louis XV. (1723-1774), Rococo period. The leading men of the time are Watteau, Nicholas Pineau, Jacques Caffieri, Jules Aurele Meissonier, Jacques Blondel, Denizol, Chas. Cressent, Oeben, Tessier, and Martin (originator of Vernis-Martin panels).

Louis XVI. (1774-1792), Era of daintiness and grace. Rococo ornament suppressed. The boudoir supersedes the salon. The leading men were Gouthiere, David Roentgen, and Riesner.

The Empire was a return, under Napoleon, to the classic styles of Greece and Rome. Details include decorated cornices, caryatides, pilasters, etc.

The English Renaissance was introduced at the beginning of the Sixteenth Century. The Elizabethan was its "golden age." The details on Page 121 are from the chimney-piece in the library at Holland House, the fretwork is from Audley End, and the carved panel is at the South Kensington Museum.

Chippendale (1754) needs little comment. His designs include French details, and also show signs of Chinese influence.

Sheraton (1751) is too well known to need description. The details given in this style are illustrative of all phases of his work.

Heppelwhite (1789), though often closely on Shera-

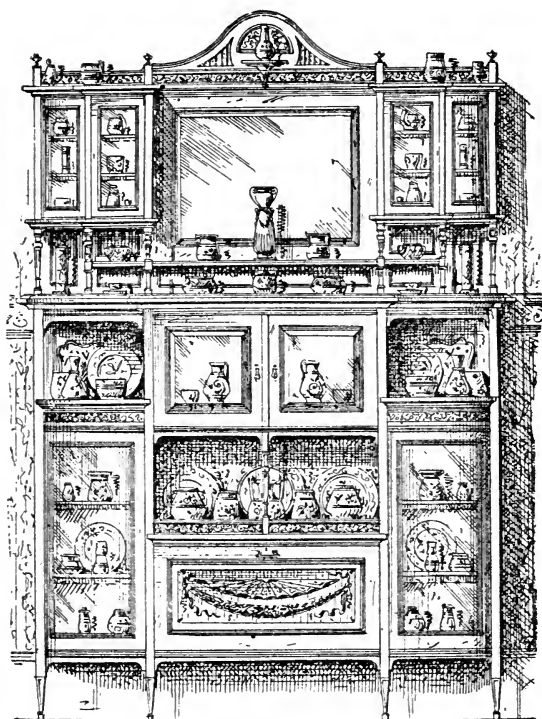

Figure 117

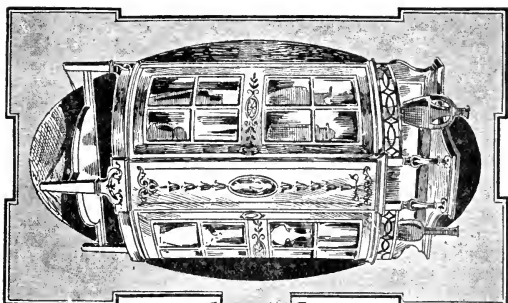

Figure 118

NEW  
DESIGNS  
FOR  
CURVED  
CABINETS

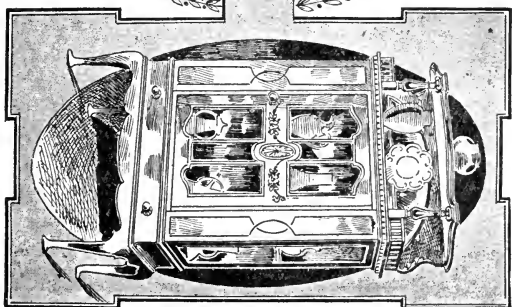

Figure 119

ton's lines, has a beauty of his own. Louis Seize influence is very apparent in this style.

Adam (1773) details are architectural, the furniture of the Brothers Adam being chiefly constructed to harmonize with the buildings in which it was to be used.

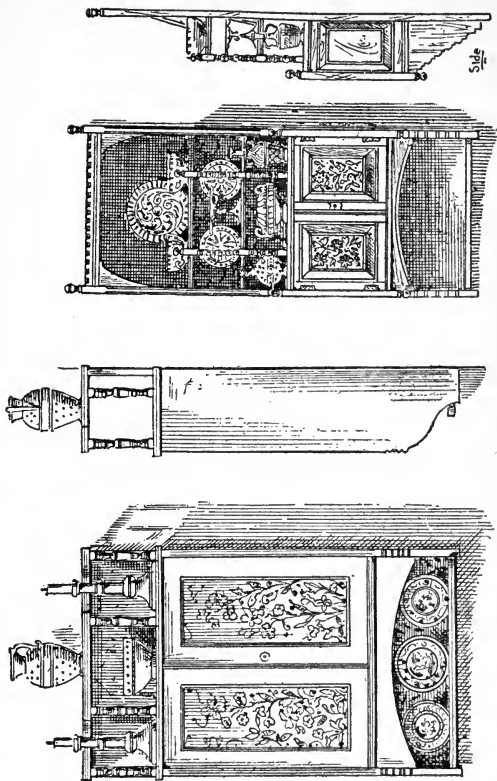

Figure 120

## PRACTICAL WORK.

In a simple treatise it is quite impossible to convey any adequate idea of the art of cabinet-making. So much could be said that it is most difficult to know what to leave out, and however fully this subject may be enlarged upon, the broad fact that but one-half has been told must remain. Further, a budding cabinet-maker will learn more during the first twelve months of his apprenticeship than all the text-books in the country can teach him. The old Roman motto, *Experientia docet*, is truer to-day than ever. Experience has been, and will be, the best teacher; but just as it is possible to start in life with better prospects upon the solid foundations laid by one's forebears, so by the aid of a few practical suggestions may a youth be helped upward on the ladder of perfection. The cabinet-maker must always strive after excellence. There is absolutely no room for men who are only half-masters of their craft; the net result of incompetence is a general leveling of the highest to the least efficient, a diminution of the rate of wages, and a disastrous lowering of the quality of work. The various styles of workmanship should incite the cabinet trade of to-day to patient and thoughtful work. It may be urged—and possibly truly—that these master-pieces of which we speak were not the daily product of the age which produced them. That inferior work was then produced

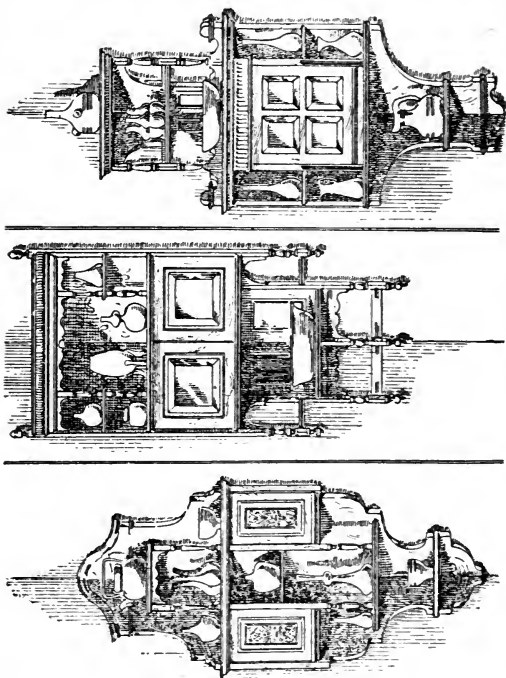

Figure 121

may be admitted; but the mere fact that time has wrought its destruction should be sufficient evidence that this class of work is not such as the twentieth-century cabinet-maker should imitate.

And here one word to the journeyman of to-day. The apprentice working under your superintendence will be exactly as you make him. Men are copyists ever, and youth is the most impressionable period. See to it, then, that your work be such as the novice treading in your footsteps may safely follow. And let the apprentice benefit by his master's experience, commencing where the latter leaves off, and thus raising the handicraft to a higher level of excellence. The only true way to success is that the heart be in the work; toiling not merely for the "standard wage," nor creating a piece of work only to "sell," but to last.

Just as to-morrow is the child of to-day, so is the journey-man the fulfilment of the apprenticeship. The groundwork of early days is the foundation upon which the after-work stands, and if the first be faulty then is there but inefficiency hereafter. One word as to the influence of trades-unionism upon the cabinet trade—it has its strong and weak points. On the one hand it demands, and rightly, from the master a standard rate of wage, which is beneficial insomuch that it puts all union shops on the same level, and prevents that "cutting" policy which is alike disastrous to good work and sound finance. On the other hand it gives no guarantee



of efficiency in the worker; good and bad are linked in one union, with the result that the least efficient are often out of work and maintained at the expense of their more skilled brothers. The remedy for this seems to lie here: let no man be made a member until he has passed through a satisfactory apprenticeship, and proved himself to be thoroughly acquainted with his trade, and capable of honestly earning the wage demanded; then would the term "union man" be understood to mean skill and efficiency, and be as proud a possession of the man earning it as a degree to a college graduate.

Possibly it may be thought that the preceding lines have savoured too much of the ethics of labor—of work in its highest and ideal form—rather than of the practical teaching of a competing age. But there is a danger that in the mad rush for cheap and badly manufactured furniture the true constructive art may be lost, and a race of men produced wedded to one job, year in and year out, and turning out work bearing neither the stamp of individuality nor the spirit of good workmanship.

Where a draughtsman is not employed, the usual method of setting out work is to make a full-size detail from the scale-drawing supplied. This is done most conveniently upon 36-inch lining-paper strained upon a board, say 7 ft. x 4 ft. This size will be found to be large enough for most jobs, which need only be drawn

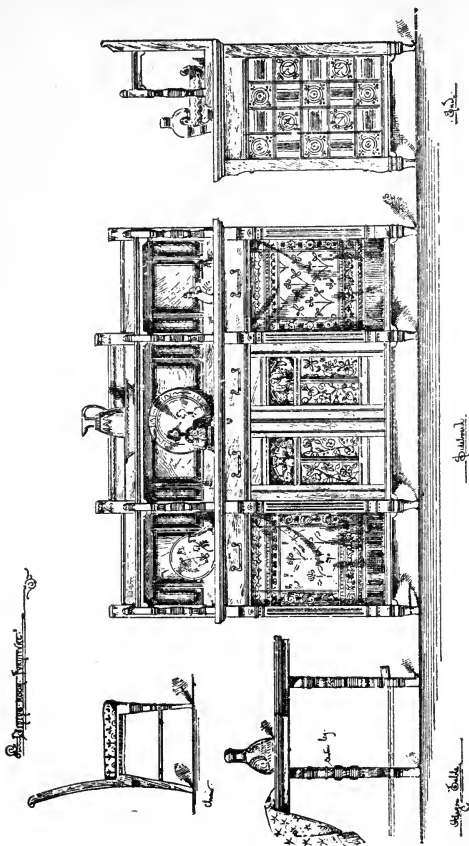

Figure 122

in the majority of cases to the center line, thus showing half the width of the job, the other half being a repeat. The thickness-sections, for the sake of clearness, may be put in with blue or red pencil. Having accomplished this, the next proceeding will be to take off the drawing the various sizes of the several pieces of wood, allowing sufficient margin for finishing to the net sizes, and for the length of tenons, &c. Many of the small pieces can be obtained from the "scrap"-room, where all sorts of ends, strips, &c., are stored in their respective classes, thus saving the cutting of a large board for the purpose of an odd rail or so, which might render it useless by reason of a corner having been cut away.

*Tools.*—The trade of to-day is so much the product of machine labor, that in a fully-equipped shop, where furniture is made to "stock" designs, the manual work is little more than that of fitting together the various parts. It is, however, still necessary that the craftsman should be fully acquainted with the use of the tools usually associated with the cabinet-maker's bench. The following list includes all those commonly required, but special tools may be necessary in certain cases:

- 1 Folding Rule, 2 or 3 feet.
- 2 Hammers (1 Bench and 1 Framing).
- 1 Mallet.
- 1 pair of Pincers.
- 3 Screwdrivers, 4, 8, and 15 inches.

- 3 Bradauls.
- 3 Gimlets.
- 1 Brace and Bits,  $\frac{3}{16}$  to  $1\frac{1}{2}$  inch.
- 2 Marking Gauges.
- 1 Cutting Gauge.
- 1 Mortise Gauge.
- x 1 Dovetail Saw, 8 inches.
- 1 Tenon Saw, 14 inches.
- 1 Hand Saw, 24 inches.
- x 1 Bow Saw, 18 inches.
- 1 set of Firmer Chisels,  $\frac{1}{16}$  to  $1\frac{1}{2}$  inch.
- 1 set of Mortise Chisels,  $\frac{1}{8}$  to  $\frac{3}{4}$  inch.
- 1 set of Gouges,  $\frac{1}{4}$  to 1 inch.
- 2 Spoke-shaves.
- 1 Trying Plane.
- 1 Jack Plane.
- 1 Smoothing Plane (wood).
- 1 Smoothing Plane (iron).
- + 1 Tothing Plane.
- 1 Iron Rebate Plane.
- 1 Wood Rebate Plane.
- 1 Oil Stone and Can.
- 1 Marker.
- + 6 Hand Screws.
- 2 Cork Rubbers (one for mouldings).
- 1 Scraper.
- 2 Rasps, 6 and 10 inches.
- 2 Wood Files, 6 and 10 inches.

- 2 Saw Files.
- 1 Square (iron), 6 inches.
- 1 Square (wood), 24 inches.
- 1 Bevel.
- 1 Nail-punch.
- 1 pair of Compasses.
- 1 Bench Holdfast.
- 1 Bench Brush.
- 1 Brace, 6 bits.

### CABINET MAKERS' JOINTS, &c.

What may be termed "edge-joints" are a necessity in cabinet-making, because timber is not always obtainable wide enough for the counter-top or panel desired; and if it were so, the cost would prohibit its general use; but more because a jointed top or panel will stand much better than a single piece, and this is the chief thing to be aimed at. There is a tendency in some quarters to avoid jointing, but the policy is an unsound one. Again, in the case of oak panelling, a much better effect can be obtained by a jointed panel—throwing all the figures to the center line—than by a single unjointed board. The chief objection to jointing seems to lie in the idea that sooner or later the joint will give; it may, just as anything is likely to happen in badly-constructed work, but given thoroughly dry and seasoned timber, a sound method of jointing, and a good workman to do it, nothing need be feared. The

necessity for jointing will, of course, be governed by the width of the timber employed. It may, however, be taken as a general rule that nothing wider than 13 or 14 inches should be used in a single piece, except in the case of countertops, which often run 3 feet 6 inches to 4 feet wide, and should only have one joint.

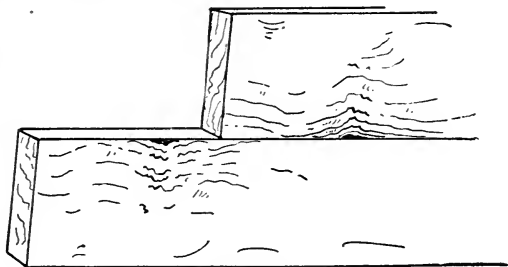

Figure 123

There are several methods of jointing which we will now consider in detail: (1) Glue joint; (2) Glue-and-dowel; (3) Tongue-and-groove (or rebate); and (4) Double groove and loose tongue.

The Glue Joint shown in Fig. 123 is perhaps the commonest of cabinet joints for such work as bears no weight,—that is, perpendicular work, as carcass ends. The method of making the joints is briefly thus: The two boards are shot with a trying or jointing plane until the surface edges are absolutely true; one piece is placed in the bench-cramp, the other being held so that

the two edges are together; run thin glue along the joint, then work the loose board backwards and forwards along its fellow until the superfluous glue is extracted; the joint should now be allowed to set. If the work has been well done the wood is much more likely

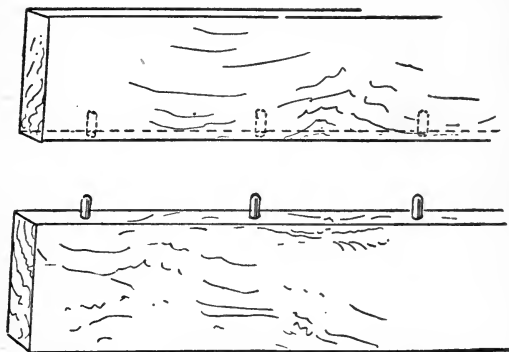

Figure 124

to break at some other point than the joint. Complete success depends upon two factors—true jointing with the plane, and good glue. There are so many good makes of the latter that there should be no difficulty whatever in obtaining it. Remember that the best glue is always the cheapest, for two reasons—its adhesive qualities and capacity for absorption of water. Good glue should take up its own weight of water, i. e., 1 lb. of glue in the cake should produce 2 lbs. weight in liquid

form. The joint to be glued should be thoroughly warmed, as this makes the glue much more adhesive than if applied to a cold surface.

Fig. 124 consists of jointing as in Fig. 123, with the

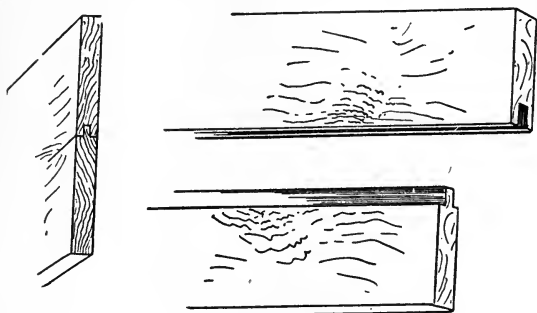

Figure 125

addition of a series of dowels placed along the joint, the object being to ensure greater strength for such purposes as a countertop. The dowels may be  $\frac{3}{8}$  inch or  $\frac{1}{2}$  inch in diameter, according to the thickness of the timber to be jointed. They should be placed (say) 12 inches apart and bored in 1 inch deep, the end of the dowel glued and knocked in with a framing hammer, then sawn off to the depth of the corresponding hole, and the ends of the dowels rounded over; glue both edges of the joint, the dowels, and dowel-holes, knock down, and cramp up. The superfluous glue will thus be



squeezed out, and when the glue has set, the board can be levelled off.

The Tongue-and-Groove Joint, Fig. 125, possesses advantages not found in the preceding ones, viz. a greater strength, and should the joint "give," the presence of the tongue prevents light from showing through. With

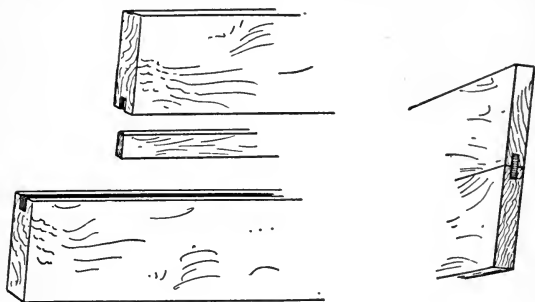

Figure 126

a pair of match-planes make a groove on one piece one-third the width of the timber used, by half an inch deep, and make a corresponding tongue on the other piece. When this has been done, fit the two together, seeing that the tongue will move freely along the groove, then glue and rub together as in Fig. 123, and clamp up.

In the Double Groove and Loose Tongue (Fig. 126)—the main idea seems to be that when jointing two soft-woods together a hard-wood tongue (which should be cut across the grain) may be inserted, rendering the

*Novetail Joints.*

Figure 127

joint less liable to snap than if a tongue were cut on the soft-wood itself and lengthways with the grain. Proceed as in Fig. 125, only making two grooves, each the same width and depth; glue the joints and loose tongue; rub, and cramp up.

We have previously spoken of straight jointing for panels, carcass ends, &c., but the methods described are not suitable for the joints of pieces meeting at an angle, as in the framing of a door or of panelling. Joints of this kind may be considered under four heads: (1) Dovetailing; (2) Mortise-and-tenon; (3) Dowel; and (4) Mitre. Two broad principles would seem to govern these, viz. that the wood employed be absolutely dry, and that the joint be true. Any deviation from either of these fixed rules must result in failure; and the second is to a large extent dependent on the first, for however good the workmanship may be, if the wood be unseasoned shrinkage must inevitably occur, with the result that it is almost impossible to put the work right when once the job has been framed up. Hence the necessity of insisting that absolutely dry stuff is an essential in the cabinet trade.

1. Dovetailing—Fig. 127, is undoubtedly the joint par excellence for cabinet work; it takes three forms. No. 1 represents the ordinary open dovetail. Each piece to be dovetailed is marked with a gauge and regulator, spacing the dovetails according to the width of wood to be jointed. This form is used wherever the

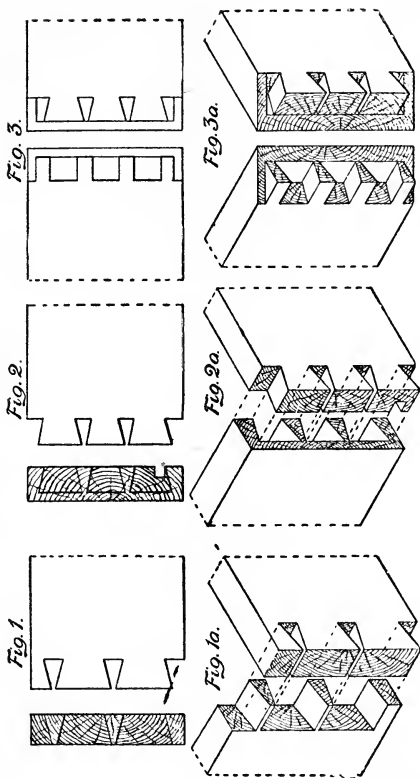
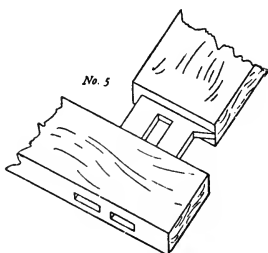
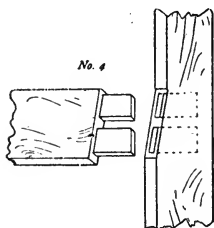
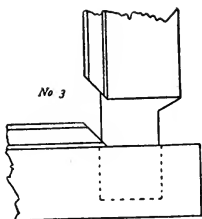
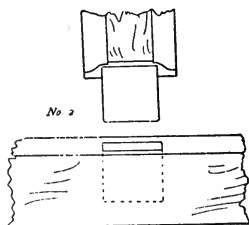
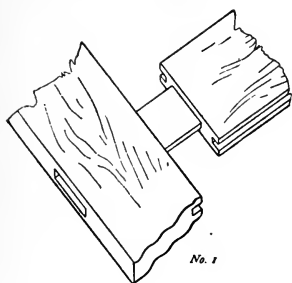

Figure 128

construction is hidden from view, its defect being that the ends of the dovetail are cut completely through, thus showing, if exposed, the end grain of the "keys" of the other piece. When this is not desired the dovetail is made as No. 2. All dovetails should be cut wedge-shaped, so that when glued and hammered they will tighten up, and when smoothed down present a perfect joint.

The overlapping or concealed dovetail (No. 2) is used in drawer fronts, where it is desirable to conceal the mode of construction. The dovetail is cut entirely through the side, but only two-thirds through the front; the joint, therefore, is visible on the end only and not on the front. This is an absolute necessity in the case of veneering, for which purpose an absolutely flat surface must be obtained, otherwise the "keys" would show through the thin veneer and spoil the whole effect. The jointing up and finishing is precisely the same as in No. 1.

The mitre-dovetailed (No. 3) is adopted for fine work where it is undesirable to show the dovetail either on front or side, and consists of a dovetail having a mitre on each outside edge; the finished joint appears as a single mitre without disclosing the dovetail within.

The Mortise-and-Tenon is the most satisfactory joint for two pieces in the same plane meeting at an angle; it takes a variety of forms (Fig. 128). The main point to be borne in mind is that the parts to form the

joint be cut true; otherwise, either the tenon will be slack and the joint useless, or too tight and will split open the mortise.

The mortise should be a little longer than the tenon,

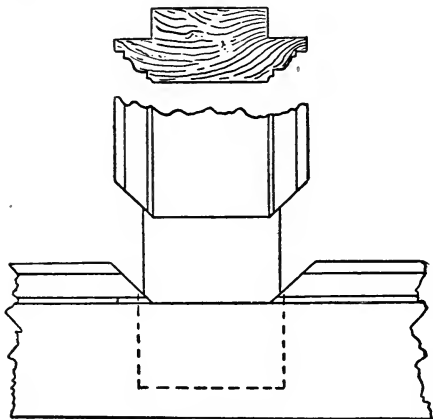

Figure 129

and should taper inward towards its base, so that the

tenon will be slightly wedged. Other methods of fixing the joints are: (1) to make the mortise large enough to admit of a wedge being driven in on each side the tenon, which effectually "keys" it; in this case the tenon is usually put in dry, that is without glue; and (2) to split open the tenon with a chisel, and insert a wedge in the center and drive home. The danger of

this method is that the tenon is liable to be necked off at the shoulder, while in the former case the rail may be split. If the mortise and tenon are fitted true, no wedging should be necessary.

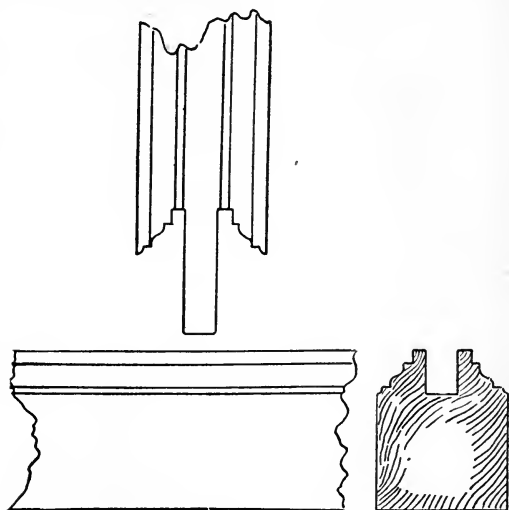

Figure 130

The thickness of the tenon should be one-third that of the rail and the width not more than 4 inches. If a wider rail has to be used, it would be better to make two mortises and tenons, as shown in Nos. 4 and 5.

No. 1.—Ordinary “cut-through” mortise. The tenon

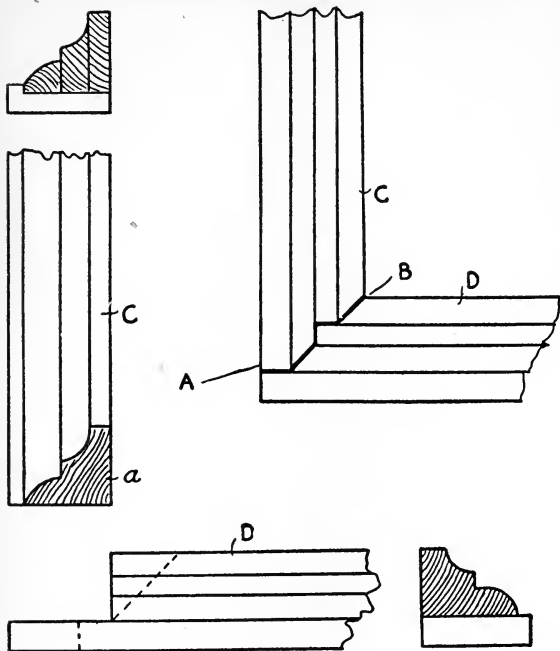

Figure 131

can be made as shown, or of the full width between the grooves, which are made on either side for the purpose of receiving the panels.

Nos. 2 and 3.—Joints for panel framing with internal



mortises. These should be cut slightly deeper than the tenon, the joint being glued up and cramped.

Nos. 4 and 5.—Methods of framing wide rails by means of double-tenons, suitable for doors where wide rails are necessary. No. 4 is usually called a gunstock joint.

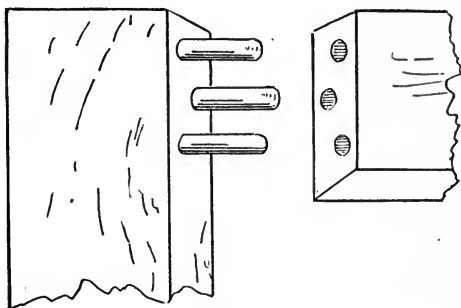

Figure 132

In framing angles having moulds on one or both edges, the moulds may be intersected either by mitring or scribing. In the mitred joint, the moulds are cut down at an angle of 45 degrees to the mortise-hole, and the moulds adjoining the tenon are cut to fit. The only danger in this method is that, if the wood is wet the mitre will dry in, leaving an open space impossible to deal with.

The process of scribing (Fig. 130) is to cut under one of the rails to the pattern of the other which it is

intended to join; but this cannot so easily be done with mouldings containing many members, as it would be too costly. It, however, has the advantage that, if shrinkage occurs, the joint can be knocked up again, which would be impossible in the former case.

These remarks apply to moulds worked upon the solid; loose or "planted" moulds are usually mitred,

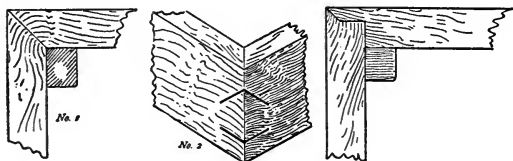

Figure 133

although not invariably. Fig. 131 shows a scribed joint for panel-mouldings. The vertical moulding C is cut away at A to fit on to the horizontal moulding D. The thick line AB shows the line the scribe will make at the point of intersection.

3. Dowel-Joint (Fig. 132) though often adopted, as it economizes labor, is not as satisfactory as the mortise-and-tenon. The dowels, which are usually  $\frac{3}{8}$  inch in diameter, often shrink, causing the joint to "give." If the dowels are of beech and the timber dry, the joint should be satisfactory. The usual method of setting out a dowel-joint is to cut a piece of paper the size of the rail and prick through the centers required according to

the number of dowels desired. These are afterwards marked upon the timber itself. If the wood is not more than 1 inch thick, the dowels should be set out in the center of the rail in a straight line; if thicker wood is used, put the dowels in zigzag fashion, which is the better way where it can be managed.

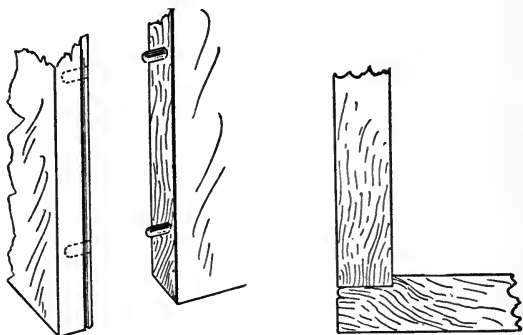

Figure 134

Where small sizes are used, the joint at the angle formed by two pieces not in the same plane is usually mitred. The construction of the joint is thus hidden. No. 1, Fig. 133, shows an ordinary mitre at an angle of 45 degrees, such as is used in the framing of a plinth or cornice frieze; the joint is strengthened by a block inside. No. 2 represents the same method, with the additional safeguard of keys; this would be adopted in the case of thin wood where the mitre surface is very

small, and where there is consequently a liability to break; the keys are usually put in with veneer, a saw-cut being all that is necessary for their insertion. Glue is run in and the joint levelled off.

No. 3 is a variation of No. 1.

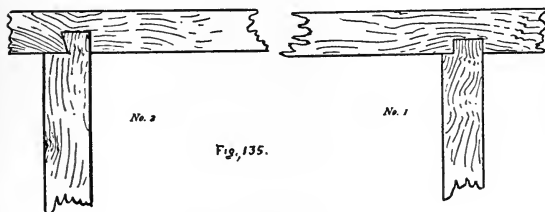

Fig. 135.

Figure 135

Fig. 134, shows an angle framed by dowels, having on the one edge a bead, which breaks the joint; this would be used in framing a pilaster upon the end of a carcass.

Fig. 135, shows two methods of framing an interior angle.

No. 1, Fig. 136, shows the method of framing a through rail intersected into a center leg, not more than three inches square. No. 2 shows the construction if the center leg is above that size, and is not mortised or dowelled. No. 3 is copied from an old card-table; the shouldering and dovetailing of the rail show advantages over No. 1.

A cornice may be worked out of the solid piece or built up in various pieces. The latter form is usually adopted by cabinet-makers, except for small cornices. No. 1, Fig. 137, shows a built-up mould; the pieces

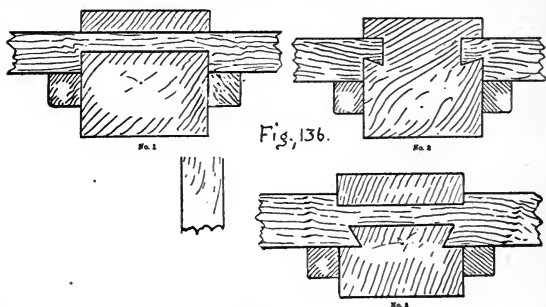

Figure 136

should be glued and screwed together, blocks being put at the back to give additional strength. No. 2 shows a solid hardwood moulding faced upon softwood, the mould having a rebate for the insertion of a dentil (shown by dotted lines), egg-and-dart, or other ornament.

Ofttimes the cabinet-maker is left to design the mouldings, in which case it is absolutely necessary that he be thoroughly conversant with the mouldings of the particular style or period in which he is working, as a Gothic mould would be out of place upon a Renaissance piece of work, and a Jacobean cornice upon a Sheraton

job. If the designer is not conversant with the grammar of ornament, all kinds of incongruous mixtures are

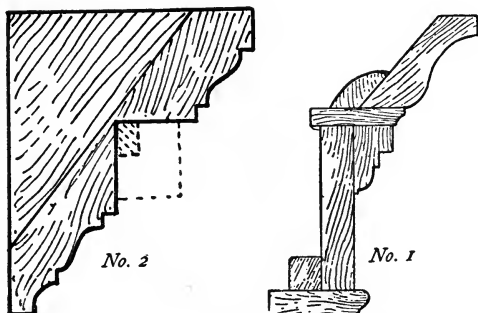
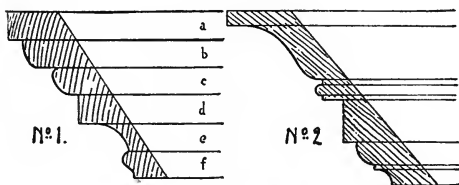

Figure 137

created, neither true to style nor beautiful. The same remarks apply also to carving and turnery, and as there



Cornices

Figure 138

are so many text-books of style published, there is absolutely no excuse for ignorance in this matter.

Another point upon which a word may be said is the proportioning of mouldings one to the other in the building-up of a cornice. Let it be supposed that one has to be stuck by hand. It is frequently possible to pick out a series of stock members all the same size,

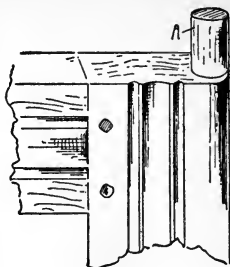

Figure 139

and to strike out a variety of cornices by ringing the changes on them. The result, however, will be a moulding as shown in No. 1, Fig. 138, where all the members, a,b,c,d,e,f, are of equal depth. This is both incorrect and inelegant; no moulding made up of a series of members should have any two in conjunction of the same depth, but the proportion should be varied after the manner shown in No. 2, the effect of which—it will be at once apparent—is much better than No. 1.

### 3. HINGES.

In cabinet-work the methods of hanging a door, table-leaf, &c., to its corresponding part, are simple, and the foundation of the joint varies but little, though in the case of hanging a door with heavy projecting moulding and cornice upon the face, special long-shouldered butts would be used. The main point in all hangings by

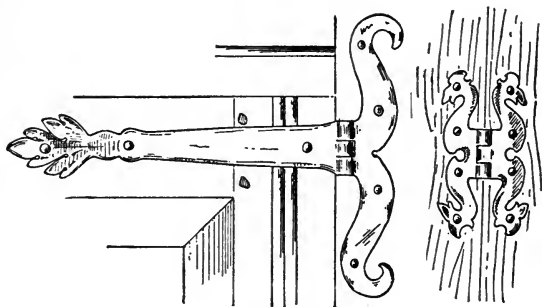

Figure 140

means of hinges is to see that each hinge bears its due proportion of weight, thus avoiding strain and consequent friction and possibly breakage.

Hinges may be of cast or malleable iron, steel, brass, copper, gun-metal, or a combination of metals, such as brass with steel washers; for heavy work these washers should always be used, the wearing parts being stronger.



The earliest form of hinge seems to have been in the form of an oak pin (A Fig. 139) shaped from the rail itself, and working in a socket cut into the cross rail above, the doors being framed up with the job itself; the form is common in fifteenth and sixteenth century wood-work. Later, the influence of Flemish work is

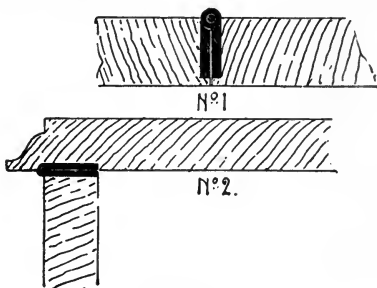

Figure 141

apparent, and the pin-joint gives place to wrought-iron hinges placed upon the face of the door and frame with artistic effect, and attached by means of large-headed nails (Fig. 140). During the Queen Anne and Chippendale periods, the hinges were delicately made of cast brass and fixed by screws.

The ordinary way of hanging by butts is shown in No. 1, Fig. 141, the rebate is not carried through the wood, and the knuckle projects on the front side. If this is not desired, the hinges must be fixed flush, and a bead of the same thickness as the knuckle run down

to make a better finish. When a lid is to be hinged, it would be done as in No. 2, the overhang at the back being, in the case of a small lid, sufficient to serve as a stop when the lid is open.

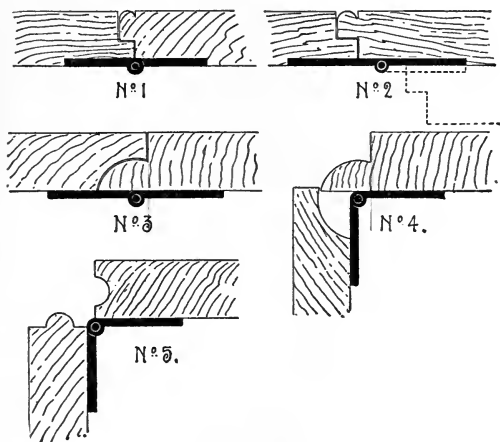

Figure 142

In hanging a table-leaf, many forms may be adopted. No. 1, Fig. 142, shows a beaded and rebated joint, the center of the hinge being directly under the joint. Except for dust-proof or light-tight purposes, the rebate is not necessary. This joint would open to 90 degrees. Should the leaf or door require to fold back behind the other part, the hinge should be placed as shown in No. 2, the dotted lines showing the position of the leaf when

folded back. Another form of leaf hanging is that known as a "rule joint," which is shown closed in No. 3, and open in No. 4. This has the advantage of concealing the hinge, and making a better finish when open

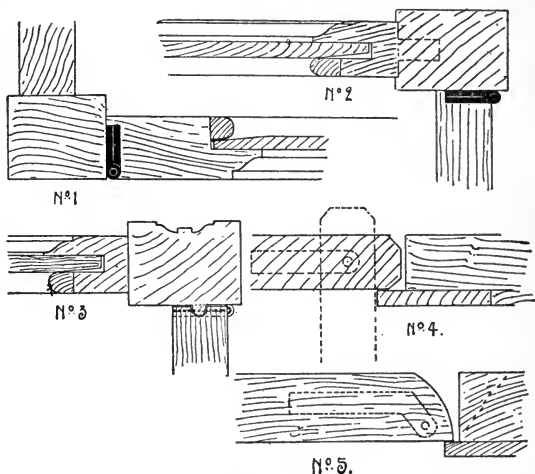

Figure 143

than otherwise would be the case; the joint is somewhat difficult to get true, but always repays the labor in effect. A variation of this joint is shown in No. 5.

Carcass doors are generally hung as shown in No. 1, Fig. 143, a bead the size of the knuckle being run down to break the joint, and the hinge rebated into the

door its entire thickness. No. 2 shows the method of hanging on to the ends of a carcass, where the full clearance of the door is desired, such as would be the case in a cupboard fitted with sliding trays. No. 3 shows the same method, but with air-tight bead for a cabinet or show-case.

Center hanging, as for wardrobe doors, is shown in Nos. 4 and 5, the door being set back in a rebate, or having a pilaster planted on to hide the joint. Sometimes this joint is made on the rule principle, but this adds to the expense.

Special hinges, such as are made for card-tables, bureaus, pianos, &c., while varying in shape and size to suit requirements, are fitted in exactly the same manner as the foregoing illustrations indicate.

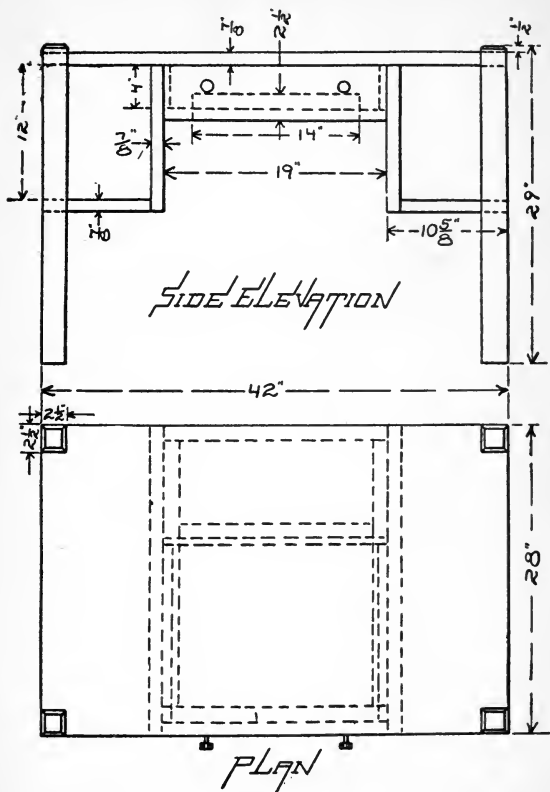

Figure 144

## SOME PRACTICAL EXAMPLES.

It is not our intention to offer much in the line of practical examples, showing details, dimensions of materials and methods of making such examples; but it is thought a few instances specified in full, may prove of use to the apprentice and younger workmen, who may want to "make things" during their leisure hours, or at odd times. We start off with a piece of work in the so-called mission style and which is easy to make. This makes a good table for a library, a den or an office. Besides fulfilling its purpose as a library table, it can be used as a bookcase, where the library is very small, and for a writing desk. The writing materials can be kept in the drawer and the absence of a lower shelf makes it possible to put the feet well under the table without interference.

The best lumber to use is oak, plain or quartered, as suits the convenience and pocket-book of the builder. Order it from the mill as follows and insist on its being well sanded before you accept it, as this greatly lessens the labor involved in its building.

- 1 piece 42x28x $\frac{7}{8}$ -inch oak.
- 2 pieces 12 $\frac{7}{8}$ x28x $\frac{7}{8}$ -inch oak.
- 2 pieces 9 $\frac{3}{4}$ x28x $\frac{7}{8}$ -inch oak.
- 4 pieces 29x2 $\frac{1}{2}$ x2 $\frac{1}{2}$ -inch oak.
- 2 pieces 24 $\frac{5}{8}$ x2 $\frac{1}{2}$ x $\frac{7}{8}$ -inch oak.
- 1 piece 19x4 $\frac{7}{8}$ x $\frac{7}{8}$ -inch oak.

- 1 piece 14x2½x7⁄8-inch oak.
- 1 piece 19x4x7⁄8-inch oak.
- 1 piece 19x2½x7⁄8-inch oak.
- 1 piece 19x3¾x½-inch pine.
- 2 pieces 17x3¾x½-inch pine.
- 6 pieces 19x3x3⁄8-inch pine.

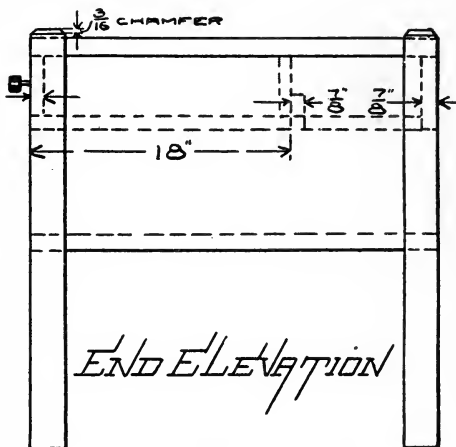

Figure 145

Three-eighth inch dowel pins should be used to fasten the shelves and top onto the legs, and if you run them through the legs, cover the ends with wooden buttons. The drawer linings can be nailed in place as the nail-heads will not show, and the other pieces can be screwed in place.

If desired, birch or other hard-wood may be used in lieu of oak, and the whole may be stained to suit the taste.

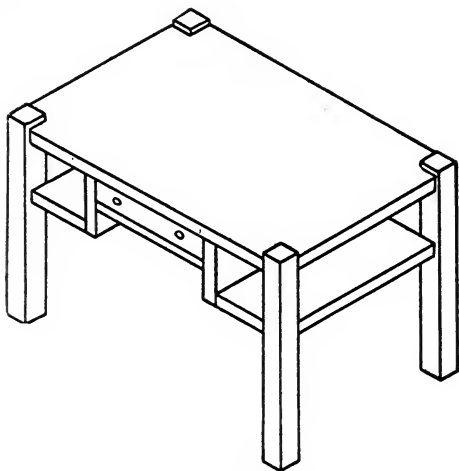

Figure 146

The illustrations show the method of construction and positions of rails, &c., and as they are all figured, showing lengths and positions, there will be no trouble in laying the table out or assembling the parts.

Fig. 144, shows a general plan and side elevation, and Fig. 145 shows end elevation, while Fig. 146, gives a perspective view of the finished work.

Another Mission table is shown in perspective at Fig.



147. This table is quite simple and may be easily made by an apprentice or any person who understands the use of ordinary woodworking tools. The table is equally suitable for use in the parlor, library or living room.

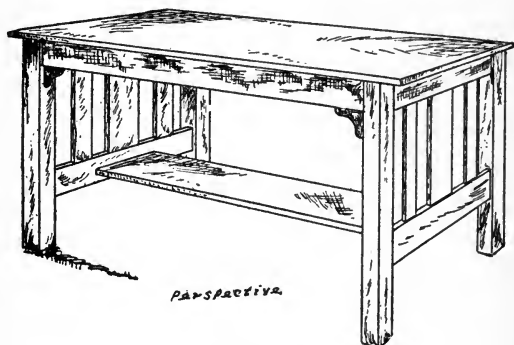

Figure 147

Quarter-sawed oak is the most suitable wood to use, and can be finished with a dark mission stain.

Fig. 148 is the side plan and dimensions of the table. The bottom footboard can be made twelve inches wide and held in place with three round-head brass screws at each end, which will make it very strong and neat in appearance.

Fig. 149 shows all dimensions and specifications for the ends. The top and bottom rails are  $\frac{7}{8}$  inch thick, while the slats are only  $\frac{3}{4}$  inch.

The top is held to the frame by glueing cleats on the inside of the top rails, then running screws through them into the top.

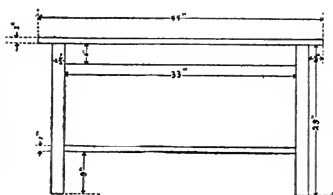

Figure 149

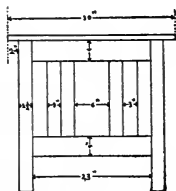

Figure 148

All the joints are tenon and mortise and glued. The ends are glued and clamped first, then the top side rails, while the bottom foot-board comes last.

These two examples exhibit the whole method of Mission furniture construction, and are quite sufficient to serve our purposes.

## SIDEBOARD FOR THE WOODWORKING BEGINNER.

The sideboard which is shown in perspective without the drawers by Fig. 150, has been designed specially for those with limited experience, and in its construction mortises, tenons, and dovetails are avoided. For fixing the various parts, glue and nails are only required.

Planed pine boarding as used for building purposes, will be found suitable; and when finished the job may be stained and varnished to suit. Fig. 151, is a half front elevation, and Fig. 152, end elevation, each drawer to scale.

The measurements may be taken from these two Figures, but for simplicity the finished sizes of the various pieces of wood are as follows: 1-in. stuff (finishing about  $\frac{7}{8}$  in. thick), top A (Fig. 151 and 152), 4 ft. 6 in. by 1 ft. 8 in.; ends B, 3 ft. by 1 ft. 5 in.; bottom C, 3 ft.  $10\frac{1}{2}$  in. by 1 ft. 5 in.; upper ends D, 2 ft. 6 in. by  $8\frac{1}{2}$  in.; cornice E, 4 ft. 5 in. by  $10\frac{1}{2}$  in.; pediment F, 4 ft. by 6 in. (widest part); drawers bearer G, 3 ft.  $10\frac{1}{2}$  in. by  $3\frac{1}{2}$  in.; division H between drawers, 1 ft. 5 in. by  $4\frac{1}{2}$  in.; brackets J, 6 in. by 5 in.; shaped span-rail K, 3 ft.  $10\frac{1}{2}$  in. by 3 in.; and corner shelves, 11 in. by 7 in. The pieces of  $\frac{3}{4}$ -in. stuff are: For the doors (made of three thicknesses of stuff), four stiles L, 2 ft. 1 in. by 3 in.; four cross rails 1 ft.  $5\frac{1}{4}$  in. by 3 in., and for the back face of the doors, four

stiles 1 ft.  $7\frac{1}{2}$  in. by  $2\frac{3}{4}$  in., and four cross rails 1 ft.  $11\frac{1}{4}$  in. by  $2\frac{3}{4}$  in. The  $\frac{1}{2}$ -in. stuff required (finishing about  $\frac{3}{8}$  in.) is: Two door panels, 1 ft.  $7\frac{1}{2}$  in. by 1 ft.

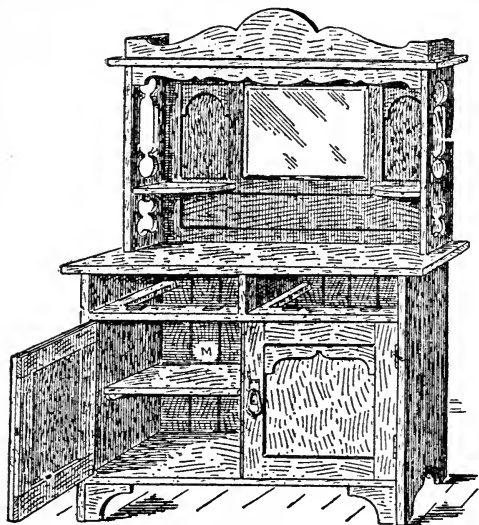

Figure 150

$5\frac{3}{4}$  in. wide; carcass back M (Fig. 152), sufficient matchboarding 3 ft. high at the ends and 4 ft. in width; for drawer fronts, two pieces N (Fig. 153), 1 ft.  $10\frac{7}{8}$  in. by  $4\frac{1}{2}$  in.; two pieces O (Fig. 153), 1 ft.  $10\frac{1}{8}$  in. by  $4\frac{1}{2}$  in.; for the drawer sides P (Fig. 154), four pieces 1 ft.  $4\frac{1}{4}$  in. by  $4\frac{1}{2}$  in.; drawer backs Q (Fig.

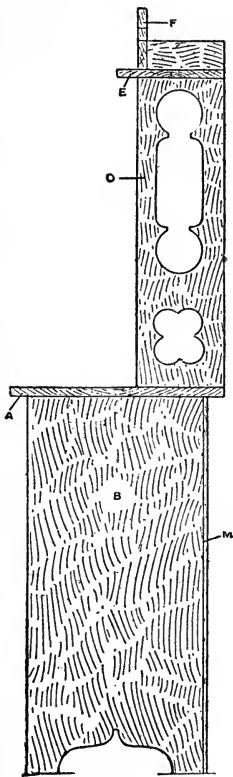

Figure 151

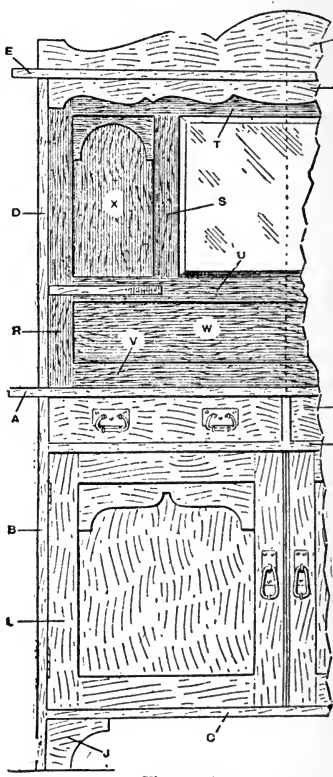

Figure 152

154), two pieces 1 ft.  $10\frac{1}{8}$  in. by  $3\frac{1}{2}$  in.; for the upper part of the sideboard (made up of three thicknesses of stuff), two front stiles R (Fig. 151), 2 ft. 6 in. by  $2\frac{1}{4}$  in.; two inner stiles S, 1 ft. 4 in. by  $2\frac{1}{4}$  in.; cross rails T, 3 ft. 6 in. by  $3\frac{1}{2}$  in.; cross rails U and V, 3 ft. 6 in. by  $2\frac{1}{4}$  in.; panel W, 3 ft.  $6\frac{1}{2}$  in. by  $6\frac{1}{2}$  in.;

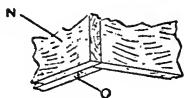

Figure 153

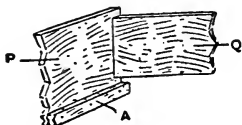

Figure 154

panel X, 1 ft.  $4\frac{1}{2}$  in. by 1 ft.  $4\frac{1}{2}$  in. by  $8\frac{1}{2}$  in. For inner layer Y and back layer Z (see Figs. 155 and 156, and 157), allow the stiles and rails to be  $\frac{1}{4}$  in. narrower than the front layer R, S, T, U, and V (Fig. 151). The shaped headings of the panels in the doors and top part are  $\frac{1}{4}$  in. thick. The top and ends being wider than the usual width of deal boards, these will have to be jointed and glued. Whitewood or pine can be obtained wide enough without joining; both woods are very suitable for varnishing.

In beginning the construction, the wood should be first planed to thickness, then the front edges, next the ends squared up, and finally taken to width. The bottom C is fixed with  $2\frac{1}{2}$ -in. oval nails driven through the ends B. Oval nails have small heads and are less un-

sightly when the work is filled up for varnishing or polishing. Next the bearer G and then top A are nailed in the same way. When nailing, if the nails are driven



Figure 155

slantwise, alternately leaning towards the front and back, they will act like dovetails, and prevent the top from lifting or the ends drawing away from the bot-



Figure 156

tom. The latter may also be prevented by screwing a strip to the under side of the bottom C and to the ends as shown in Fig. 158. Note that the top projects

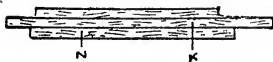

Figure 157



Figure 158

1½ in. at the front and 3 in. at each end. The division H may be fixed with 2-in. nails.

The matchboarding back M may now be fixed with

1 1/4-in. nails. The outer edges M (Fig. 152) should be worked half-round in section with a smoothing plane and course glasspaper; it will then look like a bead moulding worked on the back edges of the ends.



Figure 159

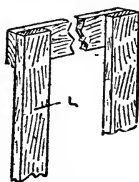

Figure 160

The doors made up of two thicknesses may next be taken in hand. Fig. 159 shows the stiles L fixed with glue and nails to the back cross rails; the front rails and back stiles are next fitted. *Note* that the back stiles and rails are 1/4 in. narrower than the front, so as to provide a rebate for the panels; see Fig. 160, which is an enlarged section of the door, stiles, and panel. When the doors are together, the shaped headings may be fitted; or for a better construction, the stiles and top rail could be rebated to receive it.

The drawer sides are nailed to the inner front O (Fig. 153) and back Q (Fig. 154). Strips A (Fig. 154) are nailed to the sides for the bottom to rest on, the latter passing under the back Q. The outer drawer front N is nailed to the drawer sides and glued to O. Of course, this method of construction is only to avoid dovetailing and ploughed grooves for the bottom.



The framing of the top part (Fig. 161) is fitted between ends D (Figs. 151 and 152) and under the shelf E, and rests on the top A. The method of construction is similar to the doors, the joints of the outer face being as shown in Fig. 151. The middle portion Y

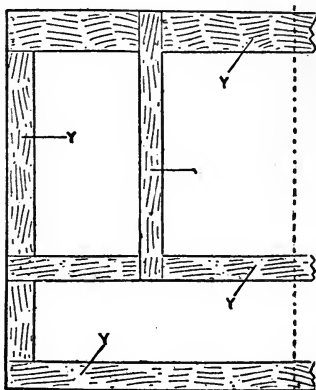

Figure 161

is as shown in Fig. 161, and the back face Z (Figs. 155, 156, and 157) the same as the front face in Fig. 151. The center mirror may be of bevelled-edge or plain silvered plate; or if desired a wood panel could be fixed. The half circular headings are fixed as described for the doors. The corner shelves, ends D, and shelf E are fixed to the framing with 2-in. nails.

For ease of handling, the upper part should be fixed

to the lower by driving screws through the under side of the top A into the ends D, also into the back framing

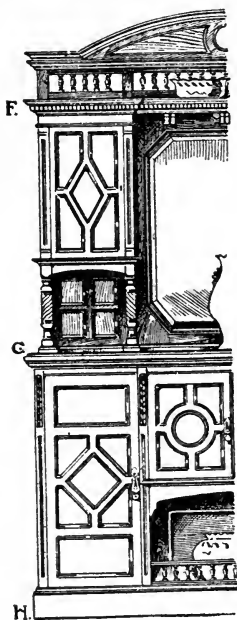

Figure 162

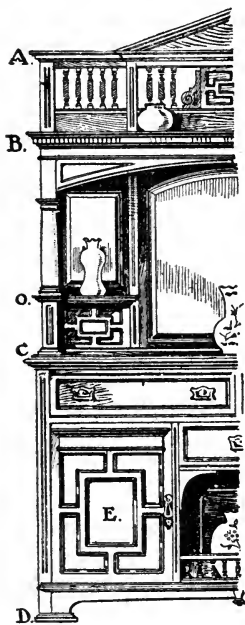

Figure 164

(Fig. 161). Suitable brass or copper handles for doors and drawers will add to the appearance of the side-board.

For staining the wood, use permanganate of potash

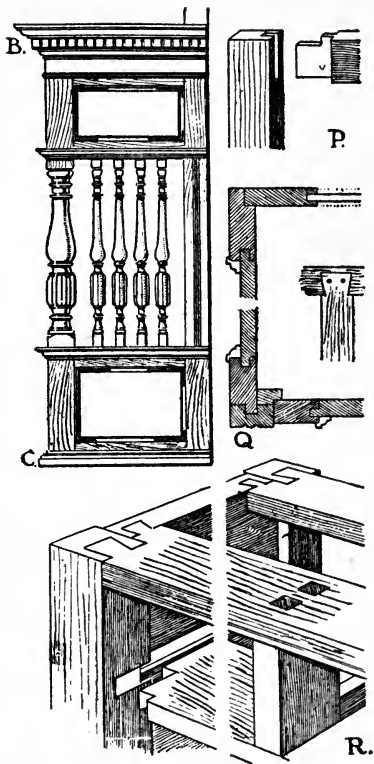

Figure 163

dissolved in hot water; less potash for oak than for walnut or mahogany. The correct shade may be got by experimenting on an odd piece of wood. When the stain is dry, give a coating of glue size. Then thin coats of varnish. When all parts show a gloss, put aside for twenty-four hours, then glasspaper, and apply the finishing coats of varnish or French polish. Bismarck brown added to the varnish will give mahogany color.

We show herewith in Figs. 162, 163, 164 and 165, part elevations and details of two low-cost sideboards, to make will be excellent practice for the younger workmen.

Fig. 162 includes center and two small side mirrors in upper part and three drawers, two cupboards and center recess in lower part. Height from A to B, 12 in.; B to C, 2 ft. 9 in.; C to D, 3 ft. 3 in.; cupboard door, say, 23 in. by 17 in.; depth of drawers, 5 in. outside. Turning is introduced, with alternative details for selection. Note swell and taper to turned column B, C,  $2\frac{3}{4}$ -in. swell, and see end elevation at Fig. 164, with  $3\frac{1}{4}$ -in. column receded. Corner B, with dentils and frieze, about 4 in.; lined up top C,  $2\frac{3}{4}$  in. moulded; 1 in. solid fronts to drawers, faced with  $\frac{1}{2}$  in. moulded and mitred strips. One 5-in., or two  $3\frac{1}{2}$ -in. lacquered brass handles. Hobbs' four lever locks. Panel at E may repeat on end, less capping. Shelf inside cupboard, 1 in. moulded thumb; 2-in. brass butt hinges; 1-in.

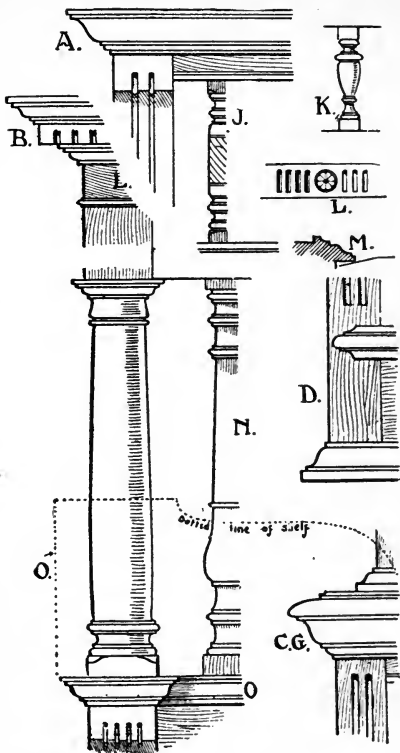

Figure 165

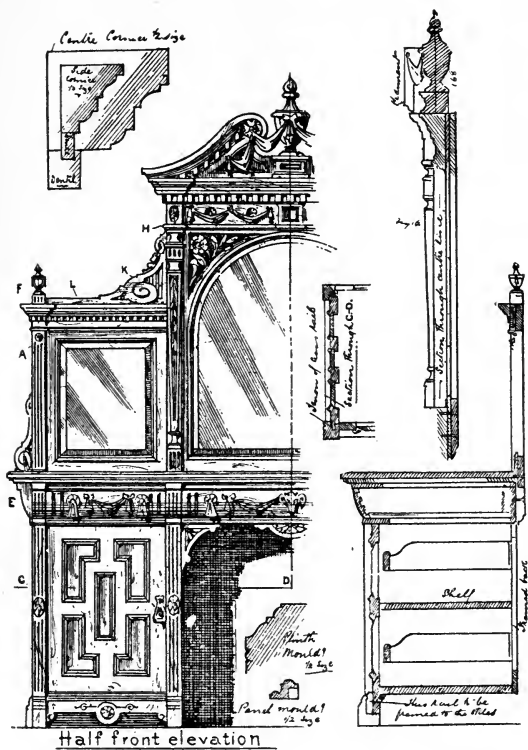

Figure 166

Figure 167

ends, and 1 ft. 9 in. back to front;  $1\frac{7}{8}$ -in. posts; 1-in. door stiles and rails; bottom under drawers through to back; flush framed back,  $\frac{3}{4}$  in., let in rebates; 1-in. bevel to mirror,  $1\frac{1}{2}$ -in. framing to back. Fig. 2 all cupboard doors, wood panels moulded; center mirror, 24 in. by 28 in.; back above F,  $13\frac{1}{2}$  in. high; F to G, 3 ft. 1 in.; upper door I,  $19\frac{1}{2}$  in. by 11 in.; inside depth,  $8\frac{1}{2}$  in.; lower side door, 2 ft.  $6\frac{1}{2}$  in. by 14 in. If a leaf is cut in posts as indicated, it will ensure a good effect. The columns supporting upper cupboard will rest on toes at G, returning to intersect with base moulding of back. The sideboard upper backs is fixed to lower carcass by dowelling into top, and also by continuing the uprights, some 9 in. or 12 in., below top to be screwed to carcass back. Either canted, as shown, or quadrant corners would be suitable for center mirror. All shelves are indicated by an outlined base. Fig. 165 gives a few details:—A refers to (Fig. 162) section,  $1\frac{3}{4}$  in., with top turning enlarged (J); K, small spindles in lower carcass; B, enlarged detail for cornice frieze and column in Fig. 162 and cornice, etc., F (Fig. 163). The pattern shown in detail at L may be carved in frieze with good effect. M, section for moulding round center mirror; N, alternative to lesser columns at C (Fig. 164); O, dotted line of shelf (Fig. 162); C, G, detail for table top (Figs. 162 and 163) of 1-in. stuff lined up; D, detail for Fig. 162 at floor line,  $1\frac{1}{2}$ -in. section. Door frames should be mortised

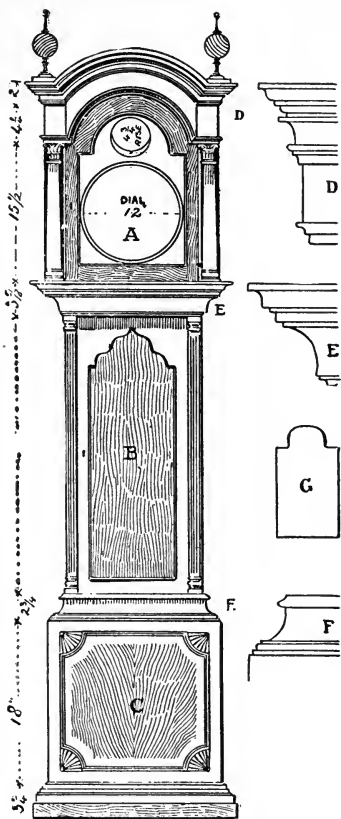

Figure 169



right through, as at P, and moulded oriels, the geometrical framing being mitred up and turned in to intersect to patterns shown. A section through lower carcass occurs at Q for pilasters and plain moulded panels front and ends. Another method is indicated by cut at R suitable for plain ends, vertical grain, or a 9-in. upper end rail, with panelling to match E (Fig. 162).

The half-Front elevation and details of sideboard in Fig. 166 is a little more pretentious than those preceding it, and of course will tax the skill of the workman proportionately, but we do not think it beyond the ability of the ordinary trained workman. The elevation sections and details have all been drawn to scale, and are, therefore, measurable.

Fig. 166 shows the half elevation. Fig. 167 shows section of lower portion and mirror portion of upper works. Fig. 167, is the upper part of board in section. The mouldings in section require no explanations.

Cabinet-makers as a rule do not often have calls to make Grandfather's clock cases, but, it does sometimes fall to the lot of the workman to make a case, so it may not be amiss to give one or two simple designs on this work, giving dimensions and style of finish. The proper material to be employed in making this case is mahogany, but of course, walnut or quartered oak—darkened—will answer very well, but in either case, good workmanship and fine finish will be necessary to give the clock an artistic appearance.

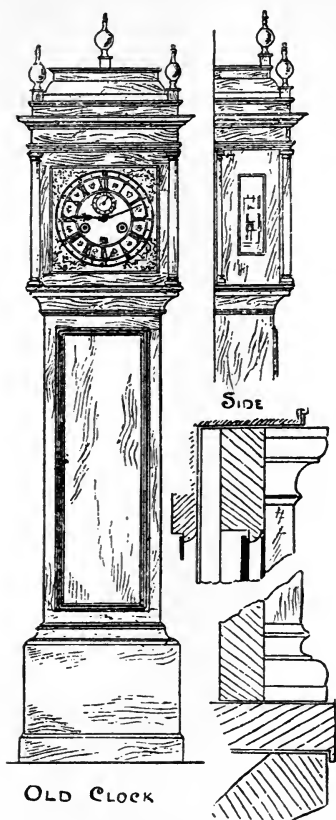

Figure 170

The sizes given in this example are suitable for a clock with 12 in. dial, and the remarks which follow should render the setting out a simple matter. (A) The clock case Fig. 169, consists of sides, front, and corner only, so that it may be pushed on from the front, along the moulding E, the back ends of sides being rebated to fit over the back—an arrangement which renders the clock easily accessible. Height through center of dial from bottom of door to top of cornice,  $25\frac{1}{2}$  in. Height of door in center, 21 in.; the rise being  $4\frac{3}{4}$  in.; width,  $15\frac{1}{4}$  in.; frame,  $1\frac{3}{8}$  in., out of  $\frac{3}{4}$ -in. stuff, and glazed. The door shuts on to an inner frame of same size, out of  $\frac{1}{4}$ -in. stuff, well screwed, with glued blocks. The ends,  $8\frac{1}{2}$  in. wide (cut out in center, and glazed, as G), and continued through cornice up to springing of top curve; frieze and cornice are built up thereon. The top or "roof" of case is built up of  $\frac{1}{8}$ -in. stuff, bradded or screwed to upper member of cornice, and to top back rail on case cut to same curve, both being rebated for the purpose. The cornice projects  $1\frac{1}{4}$  in. over sides, being supported by columns tapering from  $\frac{7}{8}$  in. to 1 in. diam. These may either be plain or mounted, with brass Corinthian capitals and bases, the shafts then being reeded. The upper finials are also of brass, and impart a most pleasing finish to the top. It should be added that the clock movement rests upon ledges about  $4\frac{1}{2}$  in. high, which also serves as guides to the loose case, and steady it when in position. Body

of clock (B): This is constructed of  $\frac{3}{4}$ -in. stuff—front framed (dowelled or rebated 15 in. wide) into  $1\frac{3}{4}$  in. posts, the outer corners of which are canted to receive  $1\frac{1}{4}$  in. turned pillars. Sides 7 in. wide, rebated flush into posts and top and bottom rails, and also rebated to receive back. Hide joints of rebates

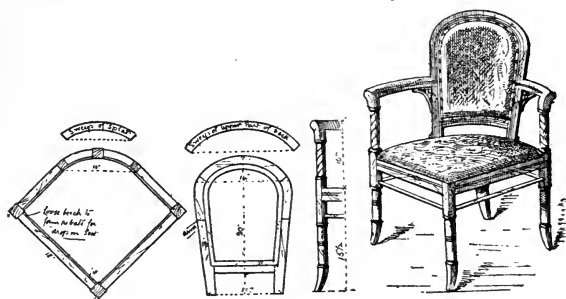

Figure 171

with a scratched brad. Back of  $\frac{1}{4}$ -in. stuff shaped at top to fit upper curve. Stiffen the joints with well-fitting blocks along the inner angles, using good strong glue for the purpose. The body B beds down about 6 in. lower than the upper moulding of the base F; sides (9 in. wide), front (19 in. wide), and back of which are rebated together and blocked. All mouldings are, of course, mitred round sides and front only. The door B (of  $\frac{3}{4}$ -in. stuff), is rebated to shut on to front frame, and projects  $\frac{1}{4}$  in. only. The moulding and carved fans at C might be further embellished by an

inlaid oval—in marquetry—and let into center of panel.

The old clock shown in Fig. 170, is English, and was designed and made by the celebrated Fromanteel, of



Figure 172



Figure 173

London, whose name is engraved on the dial between V. and VII. and over the figures registering the date of the month. A minute dial occupies the upper portion

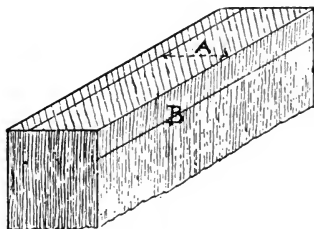

Figure 174

of the main dial, which is entirely of brass, the numeral disc being raised about an eighth of an inch above the central portion. The minutes are numbered throughout the circumference over the hours, and these latter are divided by fleur-de-lis. The hands are of beautiful design in steel, and the clock case is in oak. The ball

terminals are gilt, and screw into little wooden bases, as shown. At either angle beyond the dial are spandrels of cast-brass ornament in coarse style, representing two cupids bearing crossed sceptres and supporting a regal crown. The screw which fixes this ornament has a Tudor rose for its head, and forms the center of the composition.

## HOW TO MAKE A CORNER CHAIR.

The object, in the present design, is to make a corner chair capable of affording support to the shoulders; and in this respect the design annexed is somewhat original. The selection of the wood for same is a matter, of taste; black walnut, mahogany (stained dark), rosewood, or dull black are all suitable. To save expense, it might, moreover, be made without the underframing or listing shown, although the strength would be reduced without it. But our purpose for the moment is, "how to make," and a few practical hints may be useful on that point. The first business is to produce the moulds to working drawing shown, and as an inch scale is adopted, this should be a simple matter. Then get out the four legs—i. e., two long and two short. The two long legs must be out of 2 in. wood, to allow of throw over scroll at top;  $1\frac{1}{2}$  in. wood will do nicely for the short ones. The seat rails must be 2 in. solid wood, and beech cannot be used except for blocking, as all the wood is more or less seen. The back might be  $1\frac{1}{2}$  in. wood, to allow, when the top is glued on, for shaping back and front to bring it in a line with the top. The top would take a piece of  $4\frac{1}{2}$  in. wood, to allow for sweep. Of course where several chairs are made, the tops can be marked one into the other, and thus waste of timber avoided;  $1\frac{1}{4}$  in. wood will be stout enough for the arms and brackets. The splat

must be out of  $1\frac{1}{2}$  in., which will allow for stuffing rabbet.

### DRAWER MAKING AND FITTING.

It is often said that a man who can make and fit a drawer well can make almost anything in constructive

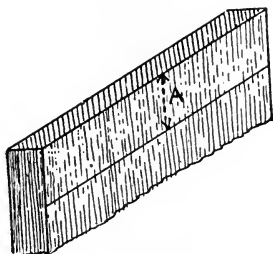

Figure 175

woodwork. This is probably true, with some reservations, for it is generally accepted as a good test of a man's skill, and we have no doubt that beginners find it one of the most difficult things to tackle, especially in the preparation and "setting out." The general method is as follows, applied to an average sized drawer:— Carefully select the stuff—i. e.,  $\frac{1}{2}$  in., finishing  $\frac{3}{8}$  in., for sides and back;  $\frac{3}{8}$  in. or  $\frac{1}{4}$  in. for the bottom, and 1 in., to finish  $\frac{7}{8}$  in. or  $\frac{3}{4}$  in., for the front. All the stuff should be dry and clean, as well as straight and even in the grain, and each piece must be planned up true and gauged to an equal thickness. Care must be



taken with the face marks, so that they can be easily read as indicating certain positions.

A handy and general workshop method is shown in Figs. 172 and 173, marked on the front of the drawer,

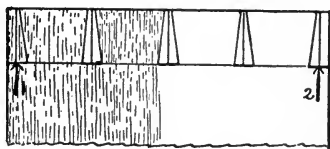

Figure 176

and the back of the back, and (2) on the front end of the sides. These marks indicate the outside and bottom edge of each piece, as well in the giving the number; and if this simple rule is applied there should be no mistake made. Where a set of drawers are the same depth, the same number should be written on the bearer or carcass. In all cases an allowance must be made on the width and length of the front and sides for fitting, and  $\frac{1}{8}$  in. is ample for this; but the sides can be squared on the shooting board at each end to the length required. It is never a good plan to let a drawer stop on to the back of a job, so the sides should be at least  $\frac{1}{2}$  in. or  $\frac{3}{4}$  in. less in length than the inside of the carcass.

After preparing the stuff, the next job is to fit it. Carefully joint one end of the front, and fit it to the corresponding end of the opening; then mark off length

at the other end, and fit tightly in the same, but leave the top edge until the final fit of the drawer. Then "run" or fit the sides in—remembering the marks—taking care they fit tight from end to end, and then plane the ends of the back to fit the opening in the same way as the front. The stuff is now ready for gauging and the cutting gauge is the best of the two to use. Gauge the lap on the ends of the front first (see distance A on Fig. 174), and then on both sides of the front ends of the sides (see A, Fig. 175). Then set the gauge to the thickness of the sides, and strike a line from the ends on the inside face of the front (see B, Fig. 174); and this same line must be gauged from the end and on both sides of the back. Lastly, the thickness of the back must be gauged in a like manner from the back ends of the sides. It will be noted that, even if a dozen drawers are to be made, the gauge is shifted only three times, and only twice if the back is the same thickness as the sides, which should always happen when the wood is obtainable. In gauging the thicknesses, care must be taken to set the gauge a little under, but never over, or a bad fit is bound to follow. It also might happen that the best planed stuff will "cast," and the sides may cast hollow in the length; whenever this does occur the round side should always be put outside.

The stuff is now ready for setting out and cutting the dovetails. Men of experience are able to just mark

off distances and cut the dovetails quickly and regularly. To those who are less skilled and beginning, a good and simple method is shown in Fig. 176. On the front end of one of the sides square down—with pencil—the lines 1 and 2,  $\frac{1}{8}$  in. from each edge, and then divide the space between these lines for the required number of dovetails. The lines will then become the center of the pins. To set out the dovetails, mark  $\frac{1}{16}$ th in. each side of the line at the top and  $\frac{1}{8}$  in. at the bottom; join these points, and the dovetails are given. The same method can be adopted on the fronts if the holes are to be cut first. There are various methods and many opinions as to which should be done first, but the safest course is to use the one you know and can best apply to the work at hand. We know of no simpler way of setting out dovetails than the one explained; and it will be noted that the half pin on the outside is left strong enough, whilst the spacing of the pins is regular and at a suitable angle.

## TO MAKE DRAWERS SLIDE EASILY.

In many cases when a drawer sticks it will be found that the place in which it slides, or ought to slide, is the part that requires most attention.

A drawer to run well must be perfectly parallel back and front all around, except that the sides and top and bottom may be eased off to the extent of  $1/16$  in. to  $1/8$  in. at the extreme ends, this easing off to extend to about  $1/2$  in. from the end. For small drawers much less will be sufficient; large drawers may have a little more taken off.

The runners, that is, the wood against which the drawer slides in its receptacle, should not be quite parallel, but a little wider at the back, or the drawer will never run well. Here again it is impossible to give exact measurements. A drawer 1 ft. wide, 6 in. high, and 1 ft. 6 in. long would require the space at the back to be about  $1/8$  in. wider and higher than the front.

One great fault with drawers is that they "wind," that is, if placed on a perfectly flat table, all four corners will not touch the level surface. This is most difficult to rectify. The cause may be bad workmanship or unseasoned wood which has twisted in drying. The high parts may be planed off, but then the drawer will be small, and must be made up to its proper size by gluing on strips of wood; or the receptacle may be reduced in size. The latter is usually the easier to do.

Suppose that the top long drawer of the 4-ft. chest of drawers which has stuck half-way is to be rectified. Do not use too much force in pulling the handles, or they may come off, or the whole front come away from the sides. Unscrew the back from the carcass, and while a helper pulls at the handles, gently tap the ends at the back with a hammer, a piece of wood being interposed endwise of the grain to act as a punch. Take care to hit the end of the drawer that is farthest in. If this does not move the drawer, it may be necessary to remove the partition between the drawers by sliding it out, and then the runners at the sides of the carcass, by gently prising them out, first previously removing the screws if necessary.

The drawer must be badly jammed if it still remains fixed, and removal to a warmer room had better be tried, and a little time allowed before resorting to stronger measures.

When the drawer is removed, first replace the partition and runners, and ascertain whether the latter are wider apart at the back than at the front. This is best done by cutting a strip of wood the exact length of the opening of the front, and sliding it to the back. If not, the runners must be reduced. Or it may happen that there is no runner, or that it has been forced out of place.

Having got the runners parallel, except for the little play mentioned, next see that they are straight from

back to front; the sides of the carcass may have bulged and bent them. Afterwards do the top and bottom in a similar way. Before and during the process of adjustment, see that the runners do not wind with the front. This can be ascertained by placing the eye about 3 in. from the front of the bottom rail on which the drawer slides and level with it, and observing that the runner ends are in the same plane, by looking first at one end and then the other without moving the eye. This requires practice, and is termed "taking it out of wind." Repeat the process for the under side of the top rail, and adjust the runners as required.

Having got the carcass right, next examine the drawer itself for winding, and whether it is parallel and straight from back to front. If the sides bulge, they can sometimes be knocked in a little. If not, the surplus must be planed off, first making a pencil mark where the parts are not to be planed.

Now try the drawer to see if it will run in. If it goes half way, take off a little with a plane (or scraper if the wood is hard) where it is tight. Run it in and out several times, and see where it shines, and carefully remove the shine. Avoid taking any off the edge of the front as long as possible, or it will be too small and a bad fit. In shutting or opening a well-fitting drawer, a little friction should be felt for the whole length.

The sides and top and bottom edges should next be well smoothed with middle and fine sand paper until

they shine. Finally they and the runners should be rubbed with spermaceti wax, and then with a linen rag, using plenty of pressure. Spermaceti sometimes crumbles away when used. If so, melt it at a low heat in a jar, pour into a cardboard box, and keep it there, cutting down the edges as required. Nothing need be added when using on wood; but for the joints of brass mathematical instruments, add 10 per cent of vaseline.

## VENEERING, STAINING AND FINISHING.

Veneering which we will first deal with, consists of laying an expensive or highly figured wood upon a foundation of a cheaper or more common wood. It does not always meet with approval, the prevailing idea being that if a piece of cabinet-work is veneered it is cheap; but a moment's consideration would convince the most incredulous that the finest effects in the works are to be obtained only by this process. It is a fact also that veneering gives greater strength to articles of furniture than if they were solidly made. Among the valuable woods for the purpose many are obtained from the far East, even the remote Siam and the Philippines furnishing supplies. Some of the most exquisitely colored and figured woods are only obtainable in small pieces, and are used for ornamental inlay designs, in devising and applying which the Hollanders are so expert that cabinets, tables, desks and other articles thus treated by them are imported here and find ready sale.

The best figured and most ornamental wood is usually to be found at the butt end of the tree, though good mottle may be obtained at the junction of the trunk and limbs. In buying timber for veneering purposes, only long experience can determine its quality and worth; the external appearance is not always a true index of the internal, and it is often a matter of chance,



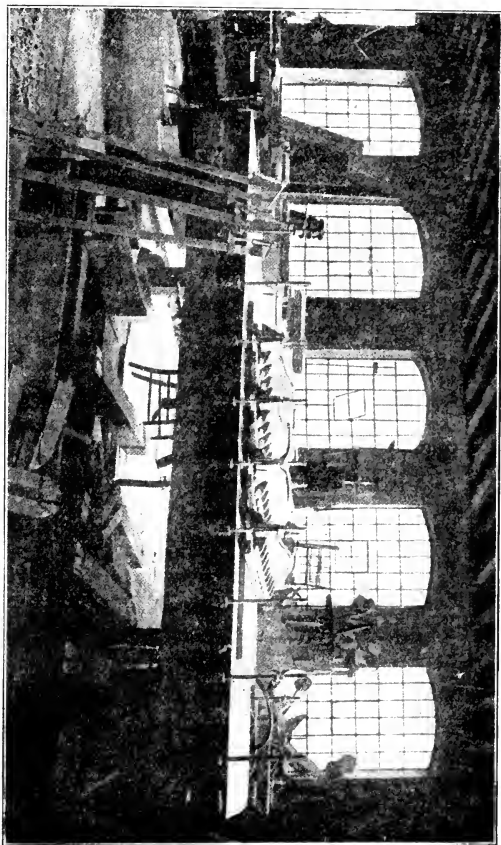

Figure 177

the most unlikely stick when opened up turning out to be finely-figured wood.

Cutting Veneers.—Veneers are of two kinds—"sawn" and "knife-cut."

"Sawn."—This term is applied to all veneers that are cut by saw. The log is placed upon a travelling platform, the fine saws being set in a vertical frame and cutting the veneers simultaneously through the log. The usual number of veneers to the inch is ten, but, if desired, twelve may be obtained; the latter are, however, thin, and not so serviceable. The veneers are numbered consecutively, so that "match" veneers may easily be determined. The ends should be bound with muslin to prevent splitting. Veneers to be in proper workable order must be kept in a damp place; they are then much more pliable, and less liable to crack. The waste of timber in cutting by this method is, roughly speaking, about  $\frac{3}{8}$  of an inch per inch of thickness.

"Knife-cut."—By this method there is no waste whatever. The log, having been opened up, is steamed, and, while saturated with moisture, placed under the knife. This works horizontally, and takes off the thinnest shaving possible. The usual number of veneers obtained per inch of thickness is from thirty-six to forty; they are therefore almost as thin as paper, and not at all reliable for hard wear or subsequent scraping and repolishing. Knife-cut veneers should only be used on

those parts of a job that are not liable to constant wear; the only advantage—and that a doubtful one—which they possess is that the veneer will “lie” more readily upon a sweep or on the flat owing to its thinness, and



Figure 178

with a reduction in time there is a corresponding abatement in price. Apart from economic reasons, a “sawn” veneer should always be used.

Veneering.—Any wood is suitable for veneering upon, but those usually selected are of the “bay-wood” or pines. The foundation, having been faced up, is “toothed” by a special hand plane, thus imparting a rough surface to the wood which will enable the glue to adhere more firmly. A solution of size and water used hot is next applied and allowed to dry. The heart side of a board should always be veneered upon, and the

reverse side damped with water to prevent the board going round when sized. Lay the board face down until ready for veneering. The veneer may now be laid, and can be done in two ways—by hand or machine.

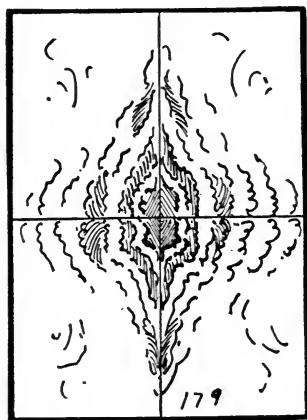

Figure 179

For small works, mouldings, or sweeps, use the former method; for panels, carcase ends, etc., the latter.

Process 1.—Quickly brush over with hot glue, taking care to spread it evenly. The veneer may then be laid down, pressed by hand to remove the air, and squeezed down by means of a “caul,” removing all blisters and superfluous glue. A weighted board then should be placed on the job until the following day.

In the case of sweeps, either a steel bow-cramp contracted to the shape, or a wooden template secured by means of cramps, should be used.

Process 2.—The machine usually constructed for

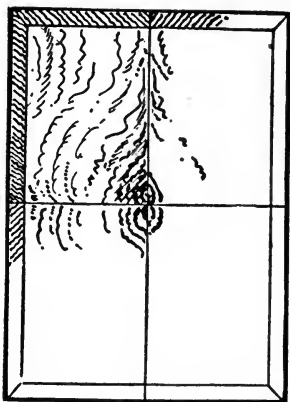

Figure 180

this purpose is shown at Fig. 172 and comprises an iron framework with perforated cast top, a series of gas-burners running at intervals of 9 inches or so the length of the machine, and over this an iron plate covered by a sheet of zinc. The gas having been turned on and the plate heated, the job to be veneered is laid on the machine, and cramps are then placed across and tightened down by means of set-screws, until the air between the foundation and the veneer is excluded, and

the superfluous glue squeezed out. This may be easily ascertained by a tap on the panel, a hollow sound indicating that the veneer is not bedded. When the veneer has been laid, turn off the gas and leave the job to cool naturally, say, through the night, the cramps remaining

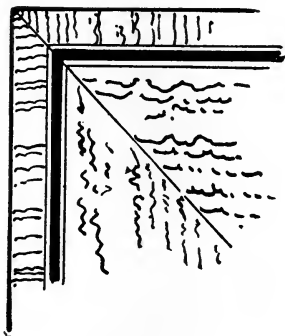

Figure 181

on. After standing for three days, the work may be finished off. It will be found that some of the glue has oozed through the pores of the veneer, while a general roughness is apparent. Proceed with an ordinary iron scraper or iron plane to smooth down (the latter is better if the veneer is thick enough, as the scraper may get too warm and soften the glue beneath), and finish with sand-paper upon a cork rubber. The job is then ready for the polisher.

When more than one veneer is used upon a panel, they are jointed in the following manner:—

The butt-joint (Fig. 178) is a most effective way of veneering a drawer-front or panel. Take two "match" veneers—that is, consecutive members—as cut from the log, cut through each where it is desired to butt, thus



Figure 182

making them "rights" and "lefts," the figure falling equally from the central joint. The veneer is then laid upon the foundation, and a few needle points or tacks placed on each side the joint, a strip of brown paper being glued upon the same to hold it in position. When dry, lay as before described.

Fig. 179.—A more elaborate way of panel-veneering is to use four match veneers quartered. All the joints must be pasted.

Fig. 180.—Still more elaborate is the addition of cross-banding, which is laid by hand after the center is completed.

Fig. 181.—The addition of a stringing is often advantageous to break the line of junction and throw up the center, a narrow band of the veneer being removed for this purpose by means of a cutting gauge.

Fig. 182.—If there is a defect or hole in a veneer, a new piece should be inserted matching the curl or mottle of the wood, the edges of which should be cut to the shape of the curl or follow the line of the grain. If this is done, detection is almost impossible; on no account insert a square piece, as the hard lines thus produced are most objectionable.



## FRENCH-POLISHING.

This most important branch of the wood-working trade seldom gets the attention it deserves, the common idea being that there is nothing in polishing demanding skill or judgment, or even worth the trouble of knowing. No greater mistake than this could be made. Polishers have in their hands the making or marring of the finished piece of furniture from the cabinet-maker's bench. Briefly, the process of French-polishing consists in the application of various gums, lacs, etc., dissolved in spirit, in order to give to the wood a surface or polish (bright or dull as required) which not only preserves the wood, but brings out the beauty of the grain.

Workshop and Fittings.—The workshop should be a large well-ventilated building, with a north light for preference and also top lights. It should be kept heated to a given temperature, say 60 degrees F., and be maintained at this heat night and day. Hot-water pipes around the walls, with regulating valves, will probably give the best results; steam-pipes may be used, but do not maintain such an equable temperature. A small enclosed coke-stove or gas-burner is an essential for the purpose of melting wax, obtaining hot water, etc.

The room should be free from dust, as any particles floating in the air and settling on a job in process, are bound to be worked up into it, producing a cloudy ef-

fect. There should also be a smaller room leading from the main shop for "Fumigating;" this must be air-tight, and have a pane of glass inserted in one of the upper panels of the door for observation purposes.

Trestles are required varying in height from 9 inches to 30 inches, and loose tops of different lengths and widths for placing on them. Several wooden battens covered with felt to protect a job are also necessary.

Materials.—It need hardly be said that upon the quality of the materials used in polishing depends very largely the ultimate results, good or bad. And here, as in other branches of trade, the best is always the cheapest. It will be found a mistake to lay in too much stock, as polish quickly evaporates and other materials deteriorate, but rather to buy small quantities of lac, spirit, &c., and mix fresh as required.

Not much in the way of plant is needed to fit a polishing shop:—say, half a dozen pint (and a few larger) stoppered bottles for polish, glaze, finish, varnish, &c.; a few jars of stain, oil, fillers; and tin canisters for keeping rubbers, more valued by the polisher than any part of his kit.

How to make a rubber.—Get a piece of clean white or gray wadding, remove the skin from it, and roll it into an egg shape, then cover the same with a thin linen rag strained tightly over the wadding, holding the ends in the palm of the hand, the two forefingers and thumb bedding themselves on the extremity of the rubber, flat-

ten the under side or polishing surface, and you will have an oval flat of, say, 3 by 2 inches. The proper size of the rubber depends upon the polisher himself and the class of work engaged on.

If new linen or calico prints be used, they should be washed to remove all trace of lime or dressing, and be as soft and pliable as possible. A different rubber should be used for different polishes, and they are so easy and inexpensive to make, there is no reason why work should be clouded through dirty rubbers. Cleanliness and good polishing go hand in hand. When the rubber is finished with, it should be kept in an air-tight canister. It will thus keep soft, and may be used repeatedly. Failure to do this will result in hardness, which renders it useless. We are now ready to commence work and proceed to the first page, viz:—

Filling-in.—This consists of coating the surface of the wood with a filler, which closes or fills up the grain, thus making it possible to get a perfectly smooth surface for polishing and also saving time and material in the after-work. Upon the efficiency of the filling-in depends the result of the finished job. There are many good fillers on the market, any one of which might be equally well adopted, but it is much better that the polisher should make his own polishes, &c., and many men prefer to do so. Consequently no two polishers use exactly the same formula, but work upon receipts best adapted to their own particular style. Before filling-in, the work

should be as finely papered down as possible. Too much stress cannot be laid on this point, for if well done at first much after-labor will be saved. The filler can then be put on with a flannel, and rubbed into the grain of the wood until the pores are filled up, then wipe all off and paper down. This will be found necessary, because the filler will have raised the grain. When dry, the work will be ready for the next process, bodying-up.

The following fillers will be found useful. The exact proportions can be ascertained when mixing, remembering that the filler must just be of the consistency to work freely.

Fillers.—(1) Spirit varnish laid on with a brush; this forms a good quick filler. Two coats should be given.

(2) Size.—Ordinary glue size may be used as a filler in the case of hard-grained wood, and will answer the purpose.

(3) Whiting and Russian Tallow.—Mix to a paste and apply as before.

(4) Whiting and Linseed-oil.—Mix these together into a paste and apply with a flannel. This is a filler generally adopted.

The disadvantage in Nos. 3 and 4 is that there is a great liability to get the job greasy, which will afterwards work its way through the polish, giving the surface a cobweb effect which is known as "sweating."

(5) Plaster of Paris and Water.—Mix as required,

and apply to the job, and rub off as quickly as possible. This filler is undoubtedly the cleanest and most effectual that can be used, and entirely obviates "sweating."

(6) Whiting and Turpentine.—Mix into a paste, and apply as before. This is preferred by many to No. 5.

Thus far these fillers are in the white, and suitable only for such woods as ash, maple, satinwood, birch, &c. In the case of dark-colored woods the filler should be tinted with rose-pink or venetian red; ebonized work, lamp-black; oak, walnut woods, &c., chromes, ochres, and umbers according to the tone required.

Bodying-up.—We now come to the second stage of polishing. The wood having been papered down with fine old glass paper, take a rubber, previously described, and sprinkle a little polish onto it from the stock bottle; then cover over with a rag, holding the ends tightly in the palm of the hand, and tap the rubber against the palm of the other hand, which will cause the polish to distribute itself over the whole rubber; put a spot of linseed-oil on with the finger, and the rubber is ready for work. Commence very lightly at one corner of the work, if it be a panel or carcass end, and by a series of motions forming interlacing curves, gradually work over the entire surface, never lifting the rubber until at the edge of the job. Care must be taken not to have the rubber too full of polish, or to press on the work too hard, in which case the polish will ooze out of the rubber and leave nasty ridges on the job; the idea is how

best to cover the entire work evenly. Having done this, let the job stand as long as possible—a few days will do no harm,—the shellac will then have sunk into the wood, the spirit evaporating. This will present a dull appearance, and feel rough to the touch. We then proceed to paper down again, in fact too much stress cannot be placed upon the value of judicious sand-papering. After this the operation is repeated until a good body of polish is obtained on the work. Be very sparing of using oil; though this eases the rubber, it ruins the job ultimately. After another papering or pumice-stoning down we can pass to the final stage, spiriting-off. It may be asked, how many times is it necessary to go over the work? This very much depends on the wood worked upon. It will be anything from three to six times, the object being to obtain a body, hard and that will not sink. Much of the modern work is completely ruined to-day because it is “rushed.” Time is not allowed between the rubbers, consequently no proper foundation is obtained, and in six months’ time the job requires redoing. The method described above will apply equally to either light or dark woods, the difference being in the polish used rather than the method.

Spiriting-off.—This process may be called the most difficult portion of French-polishing, and when once proficient in this a man may be said to know his trade. The process is similar to bodying-up, with this exception, that towards the last “spirits” only are used on

the rubber. This has the effect of polishing the "lac" put on during bodying-up, and giving to the work a fine, hard, bright surface; the oil previously worked in is spirited out.

Commence by using, say, two parts of polish to one of spirit, then equal parts, afterwards two of spirit to one of polish, and thus gradually reducing the polish to nil, and using only pure spirit. The rubber and motions are as previously described. A clean rubber should be used when pure spirit only is used, and a series of straight motions taken instead of the circular ones, running the same direction as the grain of the wood.

Small mouldings, angles, awkward corners, &c., which would be very difficult to spirit off in the ordinary way, may be done by "glazing." Applied with a rubber and worked straight along the moulds, this glaze quickly dries, and has the same appearance as if spirited-off. It is, however, softer, and will not stand wear. Much of this work could be obviated if the polisher were given the job in pieces; for instance, mouldings mitred around panels should be polished in long lengths, and cut and fitted afterwards, thus avoiding nasty corners. Turned work is better polished in the lathe, before being framed up. Panels should be polished before framing up, or if beaded in, left loose for that purpose.

Receipts for French Polish.—There is absolutely no

difficulty in mixing polishes, and every man should be able to do so, the process simply consisting in dissolving shellac in methylated spirit. This latter should be bought at 60 over-proof, stored in a cool place, and tightly sealed, as it soon evaporates.

Shellac is orange in color; the lighter the color the purer the quality. It is in small flakes, and requires crushing before dissolving in the spirits. This would be used for ordinary polish. If, however, a clear or white polish is desired, then bleached shellac is used. This is in lumps, and must be crushed before using. This lac must be kept in water. Coloring pigments can be added to any polish to intensify it as desired, such as Bismarck or Vandyke brown. These polishes should be mixed cold—the shellac will take a little longer to dissolve, but the operation is much safer,—then strain through muslin, and put in stoppered bottles.

Brown Polish.—(1) 1 pint methylated spirit, 4 oz. orange shellac,  $\frac{1}{2}$  oz. sandarac; or (3) 1 pint methylated spirit, 4 oz. orange shellac,  $\frac{1}{2}$  oz. sandarac,  $\frac{3}{4}$  oz. benzoin.

White Polish.—1 pint methylated spirit, 3 oz. bleached shellac, 1 oz. gum benzoin.

Black Polish.—Either Nos. 1, 2, or 3, adding drop-black or an aniline dye.

Glaze.—1 pint methylated spirits, 6 oz. benzoin,  $\frac{1}{2}$  oz. of sandarac can be added for harding purposes.

Furniture Revivers.—Under this head come those



preparations which are used to restore furniture which has already been polished, but has through neglect or other cause become cloudy. The first thing to be done in a case of this kind is to thoroughly wash the wood-work with a flannel soaped with curd soap and warm water; by this means all dirt and grease will be removed. After wiping down with a soft dry duster, apply one or other of the following revivers, and polish off with another clean duster. Much of the old polish will thus be brought back.

Reviver No. 1.—Take equal parts of methylated spirit, linseed-oil, and malt vinegar. Mix well and shake before using.

Reviver No. 2.—Turpentine, 1 quart; bees'-wax,  $\frac{3}{4}$  lb.; curd soap, 2 oz.; water, 1 quart. Dissolve the bees'-wax in the turpentine by moderate heat; shred the curd soap in the water and boil; then while both are hot mix together. This will set in a light paste, and prove an excellent polisher.

Repairs.—When a bruise has to be made good upon a job the best plan to adopt is as follows:—Raise the bruise by means of a hot iron placed upon a damp cloth. This, unless the wood is broken, will lift it to its original level, it may then be sand-papered off and polished.

Bleaching.—It sometimes happens that some parts of the wood are darker than the rest, in which event it is most important that the darker parts be reduced to

the lighter. This result is produced by bleaching. Dissolve 1 oz. of oxalic acid in half a pint of water, and apply with a rag; when dry, paper down, and if the density is not sufficiently reduced, repeat the operation until the desired result is obtained.

Sweating-out.—When too much oil has been used on the job, the surface presents a cobweb appearance which gradually increases and eats the polish away. When first detected, it may be removed with warm water, soap, and flannel; but when of long standing, nothing can be done to remove it except repolishing.

### 3. FUMIGATING.

This is the process of treating oak with ammonia, darkening it by this means to any required shade. This result can be achieved in two ways.

(1st.) Natural fumigation, that is, exposing the oak work in a sealed chamber to the fumes of ammonia until the required density is obtained.

(2nd.) By applying liquid ammonia to the job itself.

The ammonia used should be a solution of ammonia gas in water, and should have a specific gravity of 880. This must, on account of its volatile nature, be kept in a well-stoppered bottle.

Process 1.—To fumigate by this means a separate chamber is required. This may be an ordinary room or a fuming-cabinet built in the corner of the polishing shop. In either case it must be air-tight, and the door opening into it should have a square of glass for observation purposes. When the oak work has been placed within it, take, say 1 pint of ammonia and fill about a dozen saucers placed upon the floor. The door must then be closed, and sealed up by means of brown paper pasted round the joints. The process of fuming then begins, and can be watched through the glass until the desired shade is obtained. The smaller the chamber the quicker will the work be done; the time may vary from six to twelve hours according to the strength

of the ammoniated atmosphere. Practice alone will determine the time for opening the chamber. This is the only reliable and safe way of fumigating; in fact all other processes are but imitations of it, and the product of "cheapness and rush."

The advantages of this process are: (1) that as no liquid touches the job the grain is not raised, consequently sand-papering is avoided; (2) the ammonia fumes penetrate deeper into the wood than by outward application; (3) the exact density can be more easily determined.

The disadvantages are: (1) This process requires a separate room for the purpose; (2) It takes much more time than is required by the direct application of ammonia.

In connection with natural fuming it will be noticed that some parts of the job may not "take" at all. This often arises from the fact that various oaks have been used in its construction. Thus "Oak grown in one part of America may be susceptible to the fumes, while oak grown in another state, will not." Those parts which have not "taken" must then be treated by Process 2, and care must be exercised that the resultant color may be the same. Let the ammonia for this purpose be very weak. Let it dry before applying another coat (if necessary), as it is much easier to intensify than to bleach, and nothing looks worse than a patchy job.

Process 2.—This consists in the application of liquid ammonia (.880 spec. grav.) direct on to the work. It is usually applied with a sponge or rag. Water may be added to weaken the solution if only a light tint is desired. The wood immediately darkens upon the surface, but allowances should be made for its drying lighter. The objection to this process is that it raises the grain, which entails sand-papering down, while process No. 1 does not. This necessarily takes away much of the sharpness of the mouldings, the fillets suffering most of all. In this case it will be found that the work does not take the dye evenly, and the same shading or toning to a color will be found necessary to produce a good result.

In either process the job should be in the white, that is, without brass or copper work or silvered plates, as these are liable to be affected by the ammonia fumes.

Finishing.—The work, having been fumed by either of the foregoing processes, is now ready for finishing, and the usual way is either of the following:—(1) Egg-shell finish; (2) Wax finish.

(1) Apply a thin rubber of ordinary polish to the job, and dull down with powdered pumice-stone and a stiff brush. This will give a dull shine without in any way filling the grain of the wood. (2) Dissolve pure bees'-wax in turpentine, and apply with a rag, rubbing well in, and obtaining a polish by "elbow grease." This is a more tedious process than the former, but much

more satisfactory, as this process can be carried on after the job has left the polisher's hands and the polish will constantly improve.

Mahogany is the only other wood that will "fume." It assumes a purple tint, and should be treated in the same manner as oak.

#### 4. WAX-POLISHING.

This method of producing a polish was undoubtedly the earliest adopted by cabinetmakers, and is best suited to the finishing of dark oak, chestnut, and some other woods. The advantage appears to consist in the fact that the process is never complete, and, like Tennyson's "Brook," may go on forever. Much of the beauty of a piece of sixteenth-century carved oak is due to the polishing,—the result of years of rubbing—by use.

In wax-polishing two ingredients only are necessary, bees'-wax and turpentine. The wax should be melted, and sufficient turpentine added to form an easy workable paste; do not heat the turpentine or pour it into the melted wax while the latter is still on the fire, as it is highly inflammable. As all the turpentine must evaporate before the polishing is complete—leaving the wax to act as both filler and polisher,—no more should be added at the commencement than necessary, otherwise the work will be prolonged. If the stock sets hard it can be softened again by warming, but it is better to mix it in small quantities as required. The safest method of warming or melting all ingredients in the polish-shop is by steam, using a kettle or double pan, such as the cabinet-makers use for glue. This point is one not lost sight of by insurance companies.

In applying the wax-polish no skill is required, but "elbow-grease" and patience are absolutely necessary.

We will suppose that we are polishing an oak wainscoting, which has been previously fumed and stained. If the latter, we shall rub down with sand-paper; if the former, this will be unnecessary. By means of a flannel boss we apply the wax-polish, rubbing the panels in circular motion till every part receives an equal polish. The work may now with advantage be laid aside until the next day, when the process may be repeated. Let "a little and often" be the motto,—a little, in order that no clogging of wax occurs in the corners and mouldings, all the wax being rubbed in until an even bright surface is obtained, free from all tackiness or finger marking; and often, so that each thin coat may have a chance to sink into the grain and by the evaporation of the turpentine harden. Remember that the polish is produced not by the amount of wax used but by "elbow-grease."

If preferred, a piece of felt glued to a wooden block may be used; a stiff flat bristle brush is often used for polishing a carved panel or turned work.

Thus far we have spoken of wax-polishing as applied to oak, and it is questionable whether it can be applied with equal success to other woods; stained ash is perhaps the next best wood to oak for this method of polishing.

Floors are often treated in this way, including parquet surrounds, plain stained surrounds, or entire floors. Hard-wood floors are usually without previous



staining, as each polishing darkens the floor until a rich tone results. The method is as previously described, except that for floors a box-polisher is used, which is weighted. This is a wooden case (say) 12 x 8 x 6 inches, weighted inside with iron or lead to 14 lbs.; attached to this is a handle 6 feet long, working on a swivel, and thus allowing a sweep of 6 feet or so in each direction, in other words a clear swing of 12 feet or more. Upon the bottom of this case tack a piece of clean felt and proceed to polish.

The wax must previously have been rubbed on the floor with a flannel, and the first part of the polishing done with a weighted brush having a surface of 12 x 8 inches, and fitted with a swinging handle. This will evenly spread the wax and take up all superfluous quantities; it will also produce a certain amount of polish which can afterwards be brought up to a great brilliancy by the finishing felt polisher. This method would also be used in preparing the floor of a ball-room, which might afterwards be kept in condition by the sprinkling and rubbing-in of French chalk.

## 5. OIL-POLISHING.

If wax polishing was the original method of treating oak, it may be said with equal truth that oil-polishing was the method of finishing mahogany in the days when French-polishing was unknown; in fact, it is questionable whether any of the seventeenth and eighteenth-century work was dealt with in any other manner. Chippendale, Sheraton, and their contemporaries, certainly adopted it as best suited to their work, and the untouched jobs handed down prove their decision to have been right.

The great objection to oil-polishing is the length of time required to produce a good result; in fact, the longer you go on, the better it is. This fact has in these days of speed completely put oil-polishing in the background; the manufacturer wants a speedy return for his capital, and the public require their furniture the day after they give the order, so that it is impossible to have a job in the polisher's hands a month, and speedier methods have consequently been adopted.

It is unquestionable that oil-polishing will bring up the figure of mahogany and enrich its color better than any other method, and if time permits, it is, for large work (such as panelling, dadoes, doors, screens, counter tops, &c.), the very best way of polishing.

The application consists in simply producing a polish

upon the wood with raw linseed-oil, this being continually rubbed in with a flannel or felt pad. Let the operation be repeated day by day until a polish results. The process is, like wax-polishing, extremely tedious and laborious. Oil-polish can always be revived years afterwards by the same process, and a little judicious rubbing will keep the work constantly up to the mark.

## 6. STAINING AND VARNISHING.

The rage for effect at low cost has necessitated the staining of white woods to imitate the more expensive ones, and the bulk of the so-called walnut or dark mahogany fittings are but the product of the polisher who, with dexterous hand, produces the required deception. The woods commonly used for stained work are birch, canary wood, yellow pine, and other woods.

Stains should be placed on the wood direct before any size or filling has been applied. They may be applied in warm or cold water, diluted to their proper strength. A sponge is the best medium, and care should be taken that the stain floods the wood equally. When dry, the work should be sand-papered carefully—as the wet stain raises the grain—and a smooth surface obtained, then proceed with the finishing off as previously described. Aniline dyes are much used, and can be obtained in any shade in addition to the following. Let the stain be weak; it is easier to apply a second coat than lighten the first.

Walnut.—(1) Vandyke brown,  $\frac{1}{2}$  lb.; ammonia .880, 1 pint; water, 1 quart; (2) bichromate of potash, 4 oz.; water, 1 quart.

Mahogany.—(1) Bismarck brown, 2 oz.; water, 1 quart; (2) logwood,  $\frac{3}{4}$  lb.; water, 1 quart.

Black.—Logwood,  $\frac{1}{2}$  lb.; sulphate of iron,  $\frac{1}{4}$  lb.; water, 1 quart.

Green.—Sulphate of copper, 2 oz.; chrome yellow, 4 oz.; water, 1 quart.

Apply the stain to the wood with a sponge or rag, rubbing over the work until an even surface is obtained. Allow the stain to dry (which will raise the grain) then paper down, and proceed to finish by varnishing. This may be done in either oil or spirit, but the process is the same, except that for oil varnish a bristle brush may be used, while for spirit a camel-hair brush is desirable. After the first coat by either method, the work should be rubbed down before a second or finishing coat is applied. If an extra fine surface is required, paper down again after the second coat, and apply a third. Oil varnish would be used for such work as would be exposed to the weather, spirit varnish for indoor or protected woodwork.

The following are a few receipts for varnishes:—

Oak Varnish.—3 oz. resin, 1 pint turps, and 4 oz. sandarac.

Copal Varnish.—2 lb. Sierra Leone copal, 1 lb. linseed-oil, and 3½ pints turpentine.

Spirit Varnish.—1 lb. orange shellac, 6 oz. sandarac, 2 oz. hard resin, and 2 quarts meth. spirit.

Clear Spirit Varnish.—8 oz. sandarac, 1 quart meth. spirit, ⅛ pint of turpentine; this should stand and be strained through muslin to take out all sediment.

Spirit Varnish.—½ lb. orange shellac, 1 oz. resin, 1 oz. sandarac, and 1 pint meth. spirit; this makes a hard, quick-setting varnish.

## HOW TO MAKE REVOLVING BOOK-CASES.

In No. 1, Fig. 183, is an illustration of a completed revolving book-case of the ordinary type. It stands 3 or 4 feet high, and is about 20 inches square. A plan of the base on which the book-case revolves is shown on No. 2. This is made of two pieces of wood  $2\frac{1}{2}$  inches wide and  $1\frac{1}{2}$  inches thick. These are joined together by halving, and have rounded ends. Four castors are fixed at the base, one near each corner. The top is made of  $1\frac{1}{2}$  inch boards doweled together, and the edge moulded and a rebate cut on the under side. The top may also be made of a  $\frac{1}{2}$ -inch board with a  $1\frac{1}{2}$ -inch moulding fitted round the edge, and another  $\frac{1}{2}$ -inch board fastened below, thus saving material and effecting lightness. No. 3 is a section of the book-case showing the details of construction of the top and bottom and the method of attaching the revolving part to the base, A being the top, B F and B F two of the laths which keep the books in position, and H the fixed base (shown in No. 2). The base of the revolving part is made of  $1\frac{1}{2}$ -inch boards, C, which have a rebate cut round the lower edge to receive the 1-inch plinth, D D, which is mitred at the corners and fastened into the rebate. The lower edge of the plinth is rebated and a thin board, E, fixed into it.

No. 4 is a perspective view of the frame to which the shelves are fastened. It is made of four boards of equal

width and thickness joined by grooves and overlapping so that a square tube is formed. These boards must be of such a width that, when fastened in their places, the

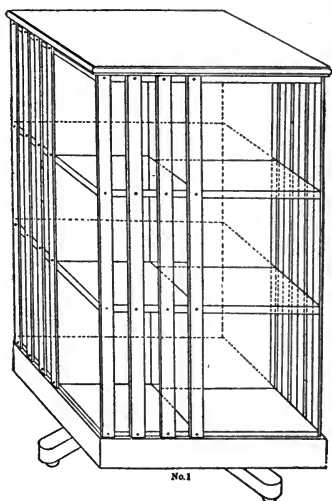

Figure 183

width of the frame is the same as that of the base, C (No. 3). The middle part of the frame should be  $1\frac{1}{2}$  inch longer than the rest, and fit into the center of C. Another way of fastening the shelves, which requires less material, is to make a square tube, and attach the shelves to this. Strips of wood 2 or 3 inches wide are fastened along the top and bottom of each shelf in the

position in which the boards (No. 4) would come. These strips keep the books in position at one end of each row, and the laths (B F and B F, No. 3) at the other end.

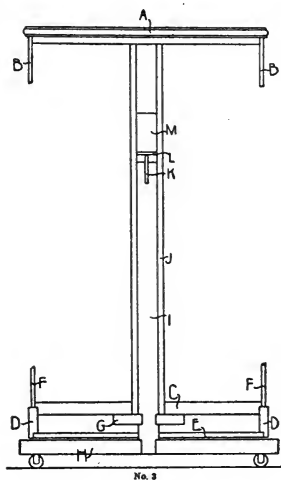
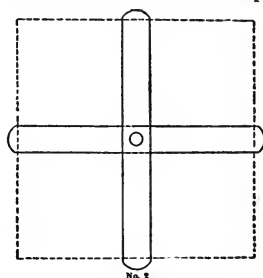

Fig. 183

The method of pivoting the revolving part is shown in No. 3. A circular pillar, I, is turned to fit the interior of the square tube, and the lower end is turned down to form a pivot which fits the hole in the fixed base, H; a little above the pivot a groove is cut in the pillar, forming a neck which works in a hole cut in a piece of 1-inch board, G, which is attached to the



under side of C. This piece of wood is sawn in half, the two halves placed in position on the pillar, and then glued together again. The pillar extends to within about 1 foot of the top of the tube. A steel spindle, K, with a pointed top is screwed into the upper end, and



No. 2

Revolving Book-case

Fig. 183

this spindle pivots in the under side of a metal plate, L, which is attached to a block of wood, M. The latter should exactly fit the tube, and is attached to it by screws.

The revolving apparatus can also be made by fastening two or more castors or wheels to the lower side of the base. These castors roll over a metal plate fastened to the upper side of the fixed base. The latter is attached to the revolving part by a spindle, which passes through the frame and the base, and is secured by nuts.

When the top and bottom has been attached to the tube, and the shelves are in their places, the laths B F and B F (No. 3) are attached to the shelves, and also

to the rebates at the top and bottom, by brass-headed nails or screws.

Revolving book-cases may be circular or hexagonal instead of square, the principles of construction being

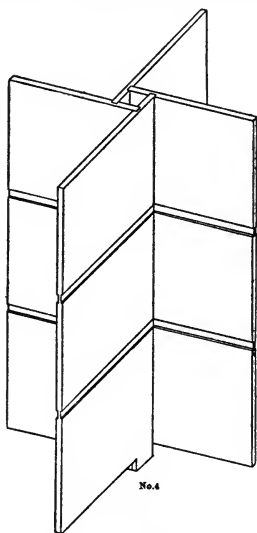

Figure 183

essentially the same. Sometimes the revolving part is made shorter, and legs added to the fixed base. They are also made to contain only one tier of books, so that they can stand on the table. Fixed book-stands are also made with shelves arranged similarly to the revolving book-cases.

## SOME MISSION AND CRAFTS EXAMPLES.

*Chairs.*—Although chairs have an infinite variety of form, as we have shown, they are constructed on nearly the same principles. No. 1, Fig. 184, is an illustration of the framework of a chair suitable for a sitting-room. The hind part consists of two long pieces of squared stuff, to which are mortised two horizontal upper rails forming the back, a third at the level of the seat, and a fourth below. These back legs are usually curved backwards above and below the seat, so that the chair-back has a slight slope and so that the feet are spread out sufficiently to prevent tilting. The front legs are joined by two rails, and are also fastened to the back by the same number. The tenons of the upper rails may come up flush with the top of the leg, as shown in the illustration, or can be fitted into an ordinary mortise. The width of the rails at the level of the seat depends upon the nature of the upholstery; if springs are to be fitted, they are about three inches wide. The bottom rails are omitted in some chairs of heavy build, or the side pairs of legs are connected by rails and the middle of these joined by a cross-piece.

All the parts of bedroom chairs, with the exception of the backs, are, as a rule, turned. The two back legs project above the seat to form the back, and are joined by two horizontal bars, which are slightly curved and joined to the vertical pieces by shallow mortises cut

in the latter. The joint is further strengthened by screws passed from the front through counter-sunk holes,

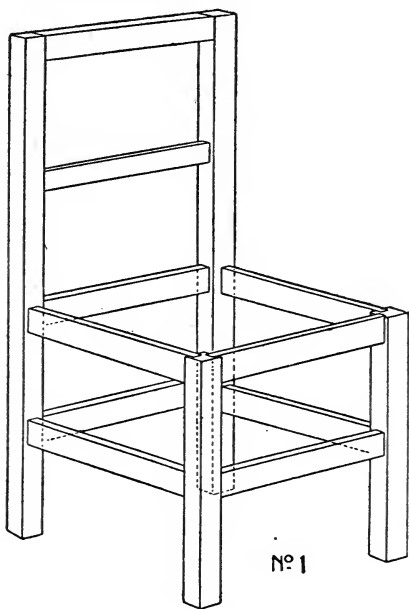

Figure 184

the heads being afterwards covered by small turned beads glued in, or if the chair is to be painted, the holes can be filled with wooden plugs. The lower rails are turned, and their rounded ends fit into corresponding

holes bored in the legs, where they are secured by glue. Sometimes only the front legs are turned, the back legs

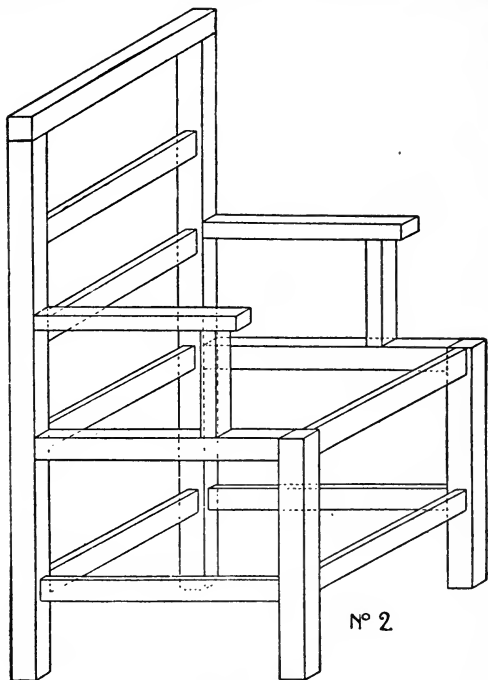

Figure 184a

being left square and bent slightly outwards. The seats of such chairs are made of four flat pieces of wood

about 1 inch thick mortised together, the front and back pieces overlapping the other two, and the back piece being shorter than that at the front. The corners and edges are slightly rounded, and sometimes the front piece is curved, as are also the sides. The front legs fit into the holes bored in the under side of the seat, and the back legs are fitted to the seat by grooves  $\frac{1}{2}$  inch deep cut in the former. Rounded backs are made by cutting the upper ends of the back legs to form part of a circle, and fitting across these a curved piece of wood. This is attached by mortise-and-tenon joints, or by dowels. The lower cross-bar is cut in a similar manner, so that, when the four are joined together, the back has the form of a segment of a circle or ellipse.

Drawing-room chairs are framed in a somewhat similar manner. Turned or fretted bars are sometimes inserted in the back, either horizontally or vertically, or part of the back is upholstered. The legs are squared, tapered, and slightly curved; or they are also turned and fluted, or left plain and carved.

No. 2, Fig. 184, shows the frame work of an arm-chair. The only difference between this and No. 1 is that the back is higher, the seat larger, and four extra rails forming the arms are added. The latter may be upholstered, or not, according to the design of the chair; turned spindles are sometimes inserted between them and the seat. The back of the arm-chair is sometimes slightly curved, and the seat may be made

of a large piece of stamped leather nailed across, without springs or other upholstery.

Dining-room chairs are now largely made of plain

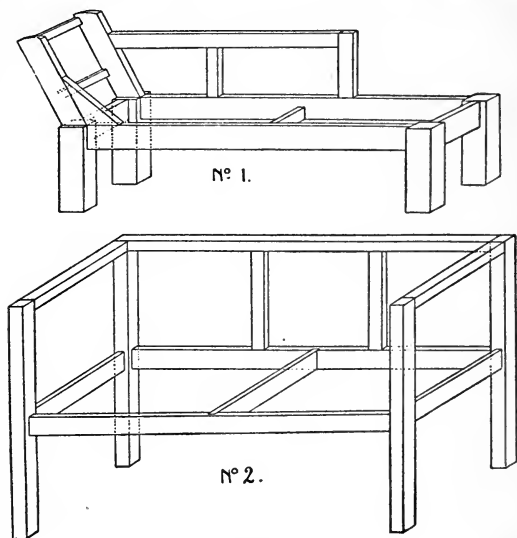

Figure 185

oak, the legs being square and tapering, the side and back rails flat, and the latter slightly curved. The wood may be darkened with ammonia, or stained dark-green, and the seat upholstered in leather. The backs of chairs of this type are not upholstered, but are generally made with top and bottom rails, the intermediate

space being filled in with flat bars about 1 inch wide.

In office chairs and others of a similar type the four legs are mortised to the wooden seat, which is made slightly hollow towards the middle part. The curved back is made up of several pieces, which are cut to form a curve and mortised or doweled together. It is attached to the seat by a series of turned or square vertical bars fixed by mortises, the two at the ends in front being stouter than the others. An extra piece of curved wood with a rounded edge is sometimes fixed to the middle part of the top of the back to serve as a shoulder-rest. When the seat is made to swivel round, the legs bend inwards, and meet at a small block of wood faced with metal, upon which the seat revolves. Office chairs are sometimes slightly upholstered instead of being left altogether plain.

The framework of an easy-chair is almost the same as that of an arm-chair, but the side rails which support the seat are much wider, the legs are shorter and thicker, and the seat stretches farther back. The back is not so high, and is made to slope slightly. The space between the arms and seat may be left open, filled with carved or turned work, or covered with upholstery. Some settees are made after the manner of large easy-chairs, wide enough to contain two or three persons; the framework of such is the same, but the seat and back are strengthened by additional cross-pieces.



*Music Stools.*—These are made either with a fixed top, or with a top that can be raised. The former have four legs and the top is round or square. The legs sometimes slope slightly outwards towards the feet to obtain greater stability. In the plainer kind of stool,

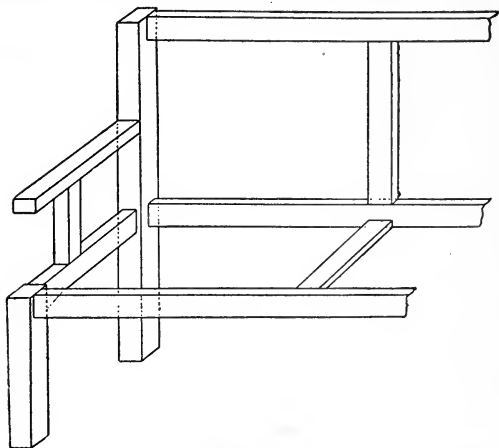

Figure 186

the seat is made of  $1\frac{1}{2}$ -inch boards with moulded edges, and of round, square, or oblong shape. If round, it is turned on the lathe out of one piece. If it is to be upholstered, a  $\frac{1}{2}$ -inch rebate is cut all round, and the upholstery is fastened to it with brass-headed nails and finished off with gimp. The legs are either square or turned, and are screwed into the under side

of the seat; they are strengthened near the lower ends by turned cross-rails. The coarse screws cut at the top of the legs are not turned on the lathe when they are being shaped, but are made subsequently with the aid of a "box-screw." This is a rectangular block of wood with a handle at either end, and pierced by a hole in which a female screw corresponding to the male screw is cut. The top end of the leg is turned down for about  $1\frac{1}{2}$  or 2 inches till it fits into one end of the hole, when it is pushed in and turned round at the same time, the screw being cut by a small knife inside. This method of joining legs is only used for light pieces of furniture and fancy tables, the legs being usually attached by mortise-and-tenon joints.

Stools with movable seats have a stout turned pillar to which three curved feet are fastened by mortise-and-tenon joints, meeting it about 6 inches from the ground. The top of the pillar is cut off flat and a hole 9 inches deep bored down it. A steel female screw is fixed into this, and a corresponding male screw about 9 inches long is fastened to the under side of the top. The latter is always circular and upholstered.

*Sofas and Settees.*—The framework of a sofa is shown in No. 1, Fig. 185. The four legs, which are represented simply as square blocks of wood, are fitted to the front and back rails with mortise-and-tenon joints. The upper part where the mortises are cut is generally made pretty stout to ensure strength, and

any resulting clumsiness is concealed by the upholstery. The lower part is tapered, carved, or turned. The front and back rails are strengthened by an additional cross-piece placed midway, and a similar cross-piece is fitted to the back, which is otherwise similar to the arm of an easy-chair. A method of fastening the head of the sofa is shown in the illustration; it consists of two rails mortised to the front and back legs in a slanting position, and strengthened by two cross-pieces. These rails are generally carved, and the front edges of both moulded. The outside of the front rail may also be carved. The top rail of the back is sometimes curved downwards until it meets the back rail of the lower frame, being made of two or more pieces mortised or doweled together. The space between the two is sometimes filled with turned bars. In order to obtain lightness, each pair of legs is sometimes joined by two slight rails placed 2 or 3 inches apart instead of by a solid rail.

The framework of the simple square settee is shown in No. 2, Fig. 185. As all the woodwork of this is usually hidden by upholstery which reaches nearly down to the floor, it is made of common wood and receives no high degree of finish. The four legs are turned at the lower end and left square at the upper. The four rails which form the seat are mortised into the sides of the legs, as are also the three rails which form the back and ends.

The back can be further strengthened, if necessary, by inserting two diagonal bars. These settees are made in a great variety of forms, from that above described to the lighter and more elegant pieces of furniture which are embellished with turned work and only partly upholstered. Sometimes the four legs which form the end-pieces are turned and the seat-frame inserted in notches cut in these, and so upholstered that the lower part of the latter and all the legs are visible.

Settees for billiard-rooms are framed similarly to arm-chairs (see No. 2, Fig. 184). They are generally made about 6 or 7 feet long, and either straight or bent to suit corners. The woodwork of a billiard-room settee is shown in Fig. 186. The parts are more massive than those of ordinary settees. The legs are made of 3-in. scantling, those at the front being turned, whilst the other pair are bent slightly backwards. The settee stands on a platform about 8 inches high, and of such and sides. The two front corners of the platform are slightly rounded. When the settee is not intended to be placed on a platform, the legs are made longer and a foot-rest is fastened to the front about 6 inches from the floor. This is made of 1-inch stuff with rounded edges; it is fastened at the back into grooves cut in the front legs, and in front is supported on stout turned feet.

Seats for railway-stations, waiting-rooms, public offices, &c., are made in the same manner as billiard-

room settees, and sometimes have an additional arm in the middle.

*Settles.*—No. 1, Fig. 187, is an illustration of a seat

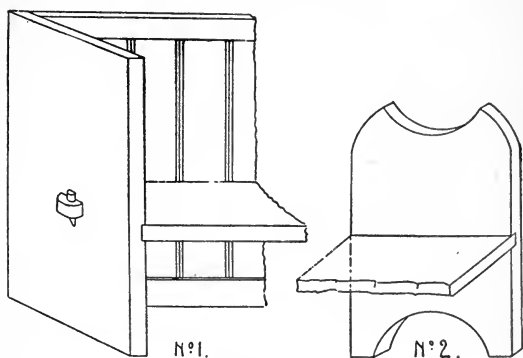

Figure 187

or settle in darkened oak, suitable for a hall. The sides are made of  $1\frac{1}{2}$  or 2-inch stuff, and grooves are cut in them to receive the seat, which is the same thickness. The seat is  $\frac{1}{2}$  inch less in width than the sides, and comes up flush at the front, thus leaving a space  $\frac{1}{2}$  inch wide for the back. It may be attached to the sides by cutting at each end a rounded tenon 2 inches wide. These tenons project about  $1\frac{1}{2}$  inch through mortises cut in the end-pieces. Half-round holes are cut through these projecting pieces so that they are flush with the sides. When the seat is in its place, a peg made by cutting a piece of tapering turned wood in a longitudinal

direction is hammered in tight. This is shown in the illustration, and holds the sides and seat firmly together. To form the back, two horizontal rails are dovetailed to the sides, one at the bottom and the other at the top. The inner edges of these are grooved to fit a series of vertical boards, which are  $\frac{1}{2}$  inch thick and chamfered at the edges. The top edge of the settle is moulded or left square.

Some settles are made five or six feet high. The back of these is upholstered for about 3 feet above the seat, and the remainder of the space is filled with solid or fretted panels. A narrow shelf for china, &c., is sometimes fixed near the top.

Settles (No. 2, Fig. 187) are sometimes made of only two end-pieces and a seat. The former are made of  $1\frac{1}{2}$ -inch oak, cut to any suitable shape. Settles of this kind serve as seats or for holding large pieces of china.

Another kind of settle which is very suitable for halls, has a seat 4 or 5 feet wide, and arms at the ends. The lower part forms a box, and is 1 foot deep, the lid being the seat. The sides and back are similar to those of an arm-chair. The four legs are usually of 2-inch scantling; the two back legs project above the seat and are joined by two horizontal 1-inch rails, one at the top and the other nearly at the level of the seat. Two rails, which are fitted with panels, join each pair of legs and form the sides of the box. Panels of  $\frac{1}{2}$ -inch stuff are grooved to these. The framing of the lid is formed of

1-inch stuff, and is 2 or 3 inches wide. This kind of settle may be left plain, or finished with flat or chip carving.

Settles which are intended for drawing-rooms are similar in structural details to those made for the hall, but they are much lighter, and the greater part of the back and sides is upholstered. Many are fitted with a narrow shelf at the top, and the back is curved instead of being square.



Bamboo Table

## WORKSHOP KINKS AND RECIPES. STAINING.

*Staining* is the process of imparting to the surface of wood a color different from its natural one. It consists of two varieties, surface-staining and body-staining. In the former, as the name implies, the staining is effected by various compounds in the nature of pigments, laid upon the surface like paint, and forming a thin opaque coating, which does not, to any considerable degree, affect the fibre of the wood. In the latter the changes are chemical, the stain being usually applied as a thin wash, which, entering the pores of the wood, colors it to some depth below the surface. Staining requires no preliminary preparation, the stain being applied directly to the wood. As most stains raise the grain of the wood to a considerable extent, it is necessary before applying the varnish, to sand-paper the wood enough to render the grain quite smooth; this sometimes renders a second coat necessary, after which the sand-paper must be again applied.

*A Good Black Stain.*—1. Gall-nuts coarsely broken, 2 ounces; rain water, 1 quart; boil until reduced one-half. 2. White vinegar, 1 pint; iron filings, 2 ounces; antimony (powdered) 2 ounces; vitriol, 1 ounce; log-wood, a small handful. Infuse in bottle eight days, tying the cork down. To stain a piece of wood, give the wood a coating of No. 1, which acts as a mordant;



when nearly dry put on No. 2; let it dry quite, and then brush it over again with No. 2.

*Another.*—Boil  $\frac{1}{2}$  lb. of chip logwood in 2 quarts of water, add 1 oz. of pearl-ash, and apply it hot to the work with a brush; then take  $\frac{1}{2}$  lb. of logwood, boil it as before in 2 quarts of water, and add  $\frac{1}{2}$  oz. of verdigris and  $\frac{1}{2}$  oz. of copperas; strain it off, put in  $\frac{1}{2}$  lb. of rusty steel filings, and with this go over the work a second time.

*Another.*—Boil the extract of logwood in water, and to it add slowly a little of the yellow prussiate of potash. Brush on hot.

*Another.*—Boil 1 lb. logwood in 4 quarts of water; add a double handful of walnut-peel or shells, boil it up again, take out the chips, add a pint of the best vinegar and it will be fit for use; apply hot. This will be improved by applying over the first stain a solution of one ounce of green copperas in a quart of water.

*Other Black Stains.*—1. Drop a little sulphuric acid into a small quantity of water; brush over the wood and hold it to the fire; it will be a fine black and receive a good polish. 2. For a beautiful black, on wood, nothing can exceed *black japan*. Apply two coats; after which, varnish and polish it. 3. To 1 gallon vinegar, add a quarter of a pound of iron rust; let it stand for a week; then add a pound of dry lamp-black, and three-quarters of a pound copperas; stir it up for a couple of days. Lay on five or six coats with a sponge,

allowing it to dry between each; polish with linseed oil and a soft woollen rag, and it will look like ebony.

4. Vinegar,  $\frac{1}{2}$  gal.; dry lamp-black,  $\frac{1}{2}$  lb.; iron rust sifted, 3 lbs.; mix and let stand for a week. Lay three coats of this on hot, and then rub with linseed oil, and you will have a fine deep black. 5. Add to the above stain nut-galls, 1 oz.; logwood chips,  $\frac{1}{2}$  lb.; copperas,  $\frac{1}{4}$  lb.; lay on three coats; oil well, and you will have a black stain that will stand any kind of weather, and is well adapted for ships' combings, etc. 6. Logwood chips,  $\frac{1}{2}$  lb.; Brazil-wood,  $\frac{1}{4}$  lb.; boil for  $1\frac{1}{2}$  hours in 1 gallon water. Brush the wood with this decoction while hot; make a decoction of nut-galls, by gentle simmering for three or four days, a quarter of a pound of the galls in 3 qts. water; give the wood three coats, and, while wet, lay on a solution of sulphate of iron (2 ozs. to a quart), and, when dry, oil or varnish. 7. Give three coats with a solution of copper filings in aquafortis, and repeatedly brush over with the logwood decoction until the greenness of the copper is destroyed. 8. Boil  $\frac{1}{2}$  lb. logwood chips in 2 quarts water; add an ounce of pearlsh, and apply hot with a brush. Then take 2 quarts of the logwood decoction, and  $\frac{1}{2}$  oz. of verdigris, and the same of copperas; strain, and throw in  $\frac{1}{2}$  lb. of iron rust. Brush the work well with this, and oil.

*Brown Stain.*—Boil 1 lb. of the brown pigment called Terre de Cassel with 4 quarts of water, until it is re-

duced one-third. Mix two ounces (Troy) of white potash with sufficient water to dissolve it, and mix with the Terre de Cassel. This stain must be applied with a brush, two or even three times, according to the depth of the shade required.

*Walnut Stain.*—Mix together, by stirring, 1 quart spirits of turpentine, 1 pint asphaltum varnish, 1 pint of japan, 1 lb. dry burnt umber, 1 lb. dry Venetian red; apply with a brush. This stain is transparent, and allows the grain of the wood to show through.

*Another.*—Boil  $1\frac{1}{2}$  ounces of washing-soda, and  $\frac{1}{4}$  ounce bichromate of potash, in 1 quart of water; add  $2\frac{1}{2}$  ounces Vandyke brown. This stain may be used either hot or cold.

*Another.*—With a brush apply a thin solution of permanganate of potassa in water, until the desired color is produced, allowing each coat to dry before another is applied.

*Oak Stain.*—Add to a quart of water 2 ounces each of potash and pearlash. This is a very good stain, but it should be used carefully as it blisters the hands and softens brushes. The stain may be made lighter by adding more water.

*Other Oak Stains.*—To darken the color of oak any of the following may be used:

Liquid ammonia laid on evenly with a rag or brush will deepen the color immediately, and it will not fade, this being an artificial production of result produced naturally by age.

Bichromate of potash, dissolved in cold water, and applied with a brush, will produce a similar result.

A decoction of green walnut-shells will bring new oak to any shade or nearly black.

*Rosewood Stain.*—Mix in a bottle  $\frac{1}{4}$  lb. of extract of logwood, 1 oz. salts of tartar, and 1 pint of water; in another bottle, put 1 lb. of old iron in small pieces, and 1 pint of vinegar, which, after standing twenty-four hours, will be ready for use; make a hard stiff brush with a piece of rattan sharpened at one end in a wedge shape, pounding it so as to separate the fibre. Mix in 1 pint of varnish,  $\frac{1}{4}$  lb. of finely-powdered rose-pink. The materials are now ready, and the first thing in the process is to stain the wood with the logwood stain; give two coats of this, allowing the first to become nearly dry before applying the second; then dip the rattan brush in the vinegar, and with it form the grain, after which give the work a coat of the varnish and rose pink. There can be no definite directions given for graining, except to study the natural wood and imitate it as near as possible. With the above materials skilfully applied, any common wood can be made to resemble rosewood so nearly that it will take a good judge to distinguish the difference.

*Another.*—Boil 1 lb. of logwood in 1 gallon of water, add a double handful of walnut shells, boil the whole again, strain the liquor and add to it 1 pint of the best vinegar. It is then ready for use. Apply it boiling

hot, and when the wood is dry, form red veins in imitation of the grain of rosewood with a brush dipped in the following solution: Nitric acid, 1 pint; metallic tin, 1 oz.; sal ammoniac, 1 oz. Mix and set aside to dissolve, occasionally shaking.

*Cherry Stain.*—Mix together, by stirring, 1 quart of spirits of turpentine, 1 pint of varnish, and 1 lb. of dry burnt sienna; apply with a brush, and after it has been on about five minutes wipe it off with rags. This stain takes about 12 hours to dry.

*Another Cherry Stain.*—Take 1 quart alcohol, 2 ozs. of dragon's-blood; pulverize the latter along with  $\frac{1}{4}$  oz. of alkanet root; mix, and let stand in a warm place a couple of days. Shake frequently in the meantime. Apply with a sponge or brush. Two or three coats may be required. This makes a fine stain.

*Red Stain for Common Work.*—Archil will produce a very good stain of itself when used cold, but if after one or two coats have been applied and suffered to get almost dry, it is brushed over with a hot solution of pearlsh in water, it will improve the color.

*Mahogany Stain.*—To darken mahogany, apply a weak solution of bichromate of potash in water. Apply successive coats, allowing each to dry, until the required shade is secured.

*Surface Stains.*—The following are for the most part used to apply to woods of inferior quality, to make them resemble choicer woods. The colors are all to be

mixed with very thin glue size, laid on warm with a soft woollen material, and the wood wiped dry after application. All the colors used in staining should be well pulverized, and before use the liquid should be strained.

*Imitation Oak Stain.*—Equal parts burnt umber and brown ochre.

*Imitation Mahogany Stain.*—One part Venetian red and two parts yellow lead.

*Imitation Rosewood Stain.*—Venetian red, darkened with lampblack to required shade.

*Imitation Walnut Stain.*—Burnt umber and yellow ochre, mixed in proportions to give desired shade.

*Fine Crimson Stain.*—Boil 1 lb. of good Brazil dust in 3 quarts of water for an hour; strain it, and add  $\frac{1}{2}$  oz. of cochineal; boil it again gently for half an hour, and it will be fit for use.

If you will have it more of a scarlet tint, boil half an ounce of saffron in a quart of water for an hour, and pass over the work previous to the red stain.

*Purple Stain.*—To 1 lb. of good chip logwood put 3 quarts of water; boil it well for an hour; then add 4 ozs. of pearlash, and 2 ozs. of indigo pounded.

*Fine Blue Stain.*—Into 1 lb. of oil of vitriol (sulphuric acid) in a clean glass phial, put 4 ozs. of indigo, and proceed as above directed in dyeing purple.

*Fine Green Stain.*—To 2 pints of the strongest vine-

gar, add 4 ozs. of the best verdigris pounded fine,  $\frac{1}{2}$  oz. of sap green, and  $\frac{1}{2}$  oz. of indigo.

Distilled vinegar, or verjuice, improves the color.

*Yellow Stain.*—Dissolve  $\frac{1}{4}$  lb. tumeric in 1 pint alcohol; let it stand until the tumeric settles to the bottom.

*Another.*—A small piece of aloes added to the varnish will have all the effect of a bright yellow stain.

*To Brighten Stains.*—Any of the stains named (except the surface stains) will be rendered much more brilliant by an application of the following: 1 oz. nitric acid,  $\frac{1}{2}$  teaspoonful muriatic acid,  $\frac{1}{4}$  oz. grain tin, 2 ozs. rain water. Mix in a bottle, at least two days before using, and keep the bottle well corked.

## DYEING WOOD.

*Dyeing* wood is mostly applied for the purpose of veneers, while staining is more generally had recourse to to give the desired color to the article after it has been manufactured. In the one case, the color should penetrate throughout, while in the latter the surface is all that is essential.

In dyeing, pear-tree, holly and beech, take the best black; but for most colors, holly is preferable. It is also best to have wood as young and as newly cut as possible. After the veneers are cut, they should be allowed to lie in a trough of water for four or five days before they are put into the copper; as the water, acting as a purgative to the wood, brings out an abundance of slimy matter, which must be removed, or the wood will never be a good color. After this purificatory process, they should be dried in the open air for at least twelve hours. They are then ready for the copper. By these simple means the color will strike much quicker, and be of a brighter hue. It would also add to the improvement of the colors, if, after the veneers have boiled a few hours, they are taken out, dried in the air, and again immersed in the coloring copper. Always dry veneers in the open air, for fire invariably injures the colors.

*Fine Black Dye.*—Put 6 lbs. of chip logwood into the copper, with as many veneers as it will conveniently



hold, without pressing too tight; fill it with water, and let it boil *slowly* for about three hours; then add half a pound of powdered verdigris, half a pound of copperas, and 4 ounces of bruised nut-galls; fill the copper up with vinegar as the water evaporates; let it boil gently two hours each day till the wood is dyed through.

*Another.*—Procure some liquor from a tanner's pit, or make a strong decoction of oak bark, and to every gallon of the liquor add a quarter of a pound of green copperas, and mix them well together; put the liquor into the copper, and make it quite hot, but not boil; immerse the veneers in it, and let them remain for an hour; take them out, and expose them to the air till it has penetrated its substance; then add some logwood to the solution, place the veneers again in it, and let it simmer for two or three hours; let the whole cool gradually, dry the veneers in the shade, and they will be a very fine black.

*Fine Blue Dye.*—Into a clean glass bottle put 1 lb. of oil of vitriol, and 4 ozs. of the best indigo pounded in a mortar (take care to set the bottle in a basin or earthen glazed pan, as it will ferment); then put the veneers into a copper or stone trough; fill it rather more than one-third with water, and add as much of the vitriol and indigo (stirring it about) as will make a fine blue, which may be known by trying it with a piece of white paper or wood. Let the veneers remain till the dye has struck through.

The color will be much improved if the solution of indigo in vitriol be kept a few weeks before using it. The color will strike better if the veneers are boiled in plain water till completely soaked through, and then allowed for a few hours to dry partially, previous to being immersed in the dye.

*Another.*—Throw pieces of quicklime into soft water; stir it well; when settled, strain or pour off the clear part; then to every gallon add ten or twelve ounces of the best turnsole; put the whole into the copper with the veneers, which should be of white holly, and prepared as usual by boiling in water; let them simmer gently till the color has sufficiently penetrated, but be careful not to let them boil in it, as it would injure the color.

*A Fine Yellow Dye.*—Reduce 4 lbs. of the root of barberry, by sawing, to dust, which put in a copper or brass trough; add 4 ozs. of turmeric and 4 gallons of water, then put in as many white holly veneers as the liquor will cover; boil them together for three hours, often turning them; when cool, add 2 ozs. of aquafortis and the dye will strike through much sooner.

*A Bright Yellow Dye.*—To every gallon of water necessary to cover the veneers, add 1 lb. of French berries; boil the veneers till the color has penetrated through; add to the infusion of the French berries, the liquid for brightening colors given on page 43, and let the veneers remain for two or three hours, and the color will be very bright.

*Bright Green Dye.*—Proceed as in either of the previous receipts to produce a yellow; but instead of adding aquafortis or the brightening liquid, add as much vitriolated indigo (see page 44) as will produce the desired color.

*Green Dye.*—Dissolve 4 ozs. of the best verdigris, and of sap-green and indigo half an ounce each, in 3 pints of the best vinegar; put in the veneers, and gently boil till the color has penetrated sufficiently.

The hue of the green may be varied by altering the proportion of the ingredients; and it is advised, unless wanted for a particular purpose, to leave out the sap-green, as it is a vegetable color very apt to change, or turn brown, when exposed to the air.

*Bright Red Dye.*—To 2 lbs. of genuine Brazil dust, add 4 gallons of water; put in as many veneers as the liquor will cover; boil them for three hours; then add 2 ozs. of alum, and 2 ozs. of aquafortis, and keep it lukewarm until it has struck through.

*Red Dye.*—To every pound of logwood chips, add 2 gallons of water; put in the veneers, and boil as in the last; then add a sufficient quantity of the brightening liquid (see page 43) till you see the color to your mind; keep the whole as warm as the finger can be borne in it, till the color has sufficiently penetrated.

The logwood chips should be picked from all foreign substances, with which it generally abounds, as bark, dirt, etc.; and it is always best when fresh cut, which

may be known by its appearing of a bright-red color; for if stale, it will look brown, and not yield so much coloring matter.

*Purple Dye.*—To 2 lbs. of chip logwood and half a pound of Brazil dust, add 4 gallons of water, and after putting in the veneers, boil them for at least three hours; then add 6 ozs. of pearlash and 2 ozs. of alum; let them boil for two or three hours every day, till the color has struck through.

The Brazil dust only contributes to make the purple of a more red cast; you may, therefore, omit it, if you require a deep bluish purple.

*Another.*—Boil 2 lbs. of logwood, either in chips or powder, in 4 gallons of water, with the veneers; after boiling till the color is well struck in, add by degrees vitriolated indigo (see page 44) till the purple is of the shade required, which may be known by trying it with a piece of paper; let it then boil for one hour, and keep the liquid in a milk-warm state till the color has penetrated the veneer. This method, when properly managed, will produce a brilliant purple, not so likely to fade as the foregoing.

*Liquid for Brightening and Setting Colors.*—To every pint of strong aquafortis, add 1 oz. of grain tin, and a piece of sal ammoniac of the size of a walnut; set it by to dissolve, shake the bottle round with the cork out, from time to time; in the course of two or three days it will be fit for use. This will be found an

admirable liquid to add to any color, as it not only brightens it, but renders it less likely to fade from exposure to the air.

*Orange Dye.*—Let the veneers be dyed by either of the methods given in page 45, of a fine deep yellow, and while they are still wet and saturated with the dye, transfer them to the bright red dye as in page 45, till the color penetrates equally throughout.

*Silver Gray Dye.*—Expose to the weather in a cast-iron pot of six or eight gallons, old iron nails, hoops, etc., till covered with rust; add 1 gallon of vinegar and 2 of water, boil all well for an hour; have the veneers ready, which must be hard-wood (not too dry), put them in the copper used to dye black, and pour the iron liquor over them; add 1 lb. of chip logwood and 2 ozs. of bruised nut-galls; then boil up another pot of the iron liquor to supply the copper with, keeping the veneers covered, and boiling two hours a day, till the required color is obtained.

*Gray Dye.*—Expose any quantity of old iron, or what is better, the borings of gun-barrels, etc., in any convenient vessel, and from time to time sprinkle them with spirits of salt (muriatic acid) diluted in four times its quantity of water, till they are very thickly covered with rust; then to every six pounds add a gallon of water, in which has been dissolved two ounces of salt of tartar; lay the veneers in the copper, and cover them with this liquid; let it boil for two or three hours till

well soaked, then to every gallon of liquor add a quarter of a pound of green copperas, and keep the whole at a moderate temperature till the dye has sufficiently penetrated.

## GILDING, SILVERING AND BRONZING.

*Gilding, Silvering and Bronzing* are processes of applying to previously prepared surfaces a thin layer of gold or silver leaf, or in bronzing, of a fine powder, prepared from various metals and intended to imitate the peculiar appearance of genuine bronze. The processes of gilding and silvering being identical, the description of one will suffice to explain the other.

*Gilding*.—Gold leaf, applied to articles of furniture as a means of decoration, is used in two ways; it is applied over an ordinary varnish or other finish, in which case but little special preparation is necessary; or, as when used for picture frames, cornices, etc., it is applied to a specially prepared foundation, the basis of which is whiting, mixed with various other ingredients suggested by experience or fancy. In either case, the gold leaf is caused to adhere to the work, by size specially prepared for the purpose, receipts for which follow herewith; the size being first applied to the work, and when it has become of the right consistency, the gold is laid upon it. OIL-GILDING and BURNISH-GILDING are different methods used to obtain certain desired effects, the former principally for articles exposed to the weather, and for heightening the effect of incised carving or engraving, and the latter for picture-frames and articles having a specially prepared foundation, whose entire surface is to be gilded. It is intended that the

gold shall adhere to the work only in the places to which the size has been applied, but the smallest portion of oil or even a slight dampness may cause the gold to partially adhere to the adjoining surface, resulting in slightly ragged edges; to prevent this, before applying the size to the desired design, the entire surface is covered with a thin film of some substance perfectly free from moisture, and easily removable by water, after completion of the process. Directions regarding this preliminary process are given under the caption: TO PREVENT GOLD ADHERING.

*The Requisites.*—First, a sufficient quantity of leaf-gold, which is of two sorts—the deep gold, as it is called, and the pale gold. The former is the best; the latter very useful, and may occasionally be introduced for variety or effect.

Second, a gilder's cushion: an oblong piece of wood, covered with rough calf-skin, stuffed with flannel several times doubled, with a border of parchment, about four inches deep, at one end, to prevent the air blowing the leaves about when placed on the cushion.

Thirdly, a gilding-knife, with a straight and very smooth edge, to cut the gold.

Fourthly, several camel-hair pencils in sizes, and tips, made of a few long camel's hairs put between two cards, in the same manner as hairs are put into tin cases for brushes, thus making a flat brush with a very few hairs.



Lastly, a burnisher, which is a crooked piece of agate set in a long wooden handle.

*Sizes.*—These are of two kinds: oil sizes are those which when applied, present an adhesive surface, requiring the immediate laying of the gold-leaf upon it; of this class is the oil-size commonly used in decorating furniture; water-sizes are those that are allowed to become dry and hard when applied, and are rendered adhesive when the gold is to be laid, by brushing over with water; for burnish-gilding these are always employed, as oil-size does not dry sufficiently hard to permit of burnishing.

*Oil-Size for Oil-Gilding.*—Grind calcined red-ochre with the best and oldest drying-oil. When desired for use, add sufficient oil of turpentine to make it work freely.

*Parchment-Size.*—For preparing Frames, etc.—To half a pound of parchment shavings, or cuttings of white leather, add three quarts of water, and boil it in a proper vessel till reduced to nearly-half the quantity; then take it off the fire, and strain it through a sieve. Be careful in the boiling to keep it well stirred, and do not let burn.

*Gold-Size for Burnish-Gilding.*—Grind fine sal-ammoniac well with a muller and stone; scrape into it a little beef suet, and grind all well together; after which, mix in with a pallet-knife a small proportion of parchment-size with a double proportion of water.

When about to use, add parchment-size until it will just flow from the brush.

*Another.*—Grind a lump of tobacco-pipe clay into a very stiff paste with thin size; add a small quantity of ruddle and fine black lead, ground very fine, and temper the whole with a small piece of tallow. When ready to use, reduce with parchment-size until it will just flow from the brush.

*Another.*—Grind separately in water, 1 lb. Armenian bole, 2 ozs. red lead, a sufficient quantity of black lead; mix, and regrind with a small quantity of olive oil. Reduce with parchment-size to the proper consistency.

*To Prevent Gold Adhering.*—Either one of the following methods will prevent gold-leaf or bronze from adhering to the surface beyond the outlines of the sizing laid on to receive it:

1. Whiting used dry, and applied by means of a pounce bag.

2. Whiting mixed in water, and applied with a soft brush. When the water has evaporated, dust off the superfluous whiting with an ordinary paint duster. By this method a very thin coating of whiting remains, which is free from any grittiness. One advantage gained by the use of whiting thus applied is, it furnishes a whitish ground over which clear varnish or oil-size may be distinctly seen as the striping progresses. After the leaf or bronze has been applied, the work must be carefully washed, so as to insure the removal of the whiting.

3. White of egg reduced with water, and applied with a piece of sponge.

4. A thin wash of starch water, either brushed on with a flat camel-hair brush, or applied with a soft sponge.

5. Take ball liquorice and water, a weak solution, and apply with a soft brush. This may be kept in a bottle ready for use at any time.

6. Cut a new potato in two, and rub over the part to be sized with the raw face exposed, allowing the juice to remain until dry.

It will be observed that any substance which interposes a film over the varnish, itself being free from tackiness and readily removed by water, will answer the purpose.

*Oil Gilding.*—Applying the Gold.—If the wood to be gilded is finished with varnish or otherwise, no additional foundation is necessary upon which to lay the gold-leaf; if the wood is not finished, after it has been smoothed and dusted, give it one or two coats of parchment size, after it is perfectly dry and hard, again smoothing the surface with fine sand-paper. That the gold may not adhere to any part of the work except where the size is hard, powder the surface lightly with whiting from a pounce-bag, which is a small bag made of material sufficiently loose to permit the powdered whiting to sift through as fine dust; if preferred, any of the preceding receipts for that purpose can be used.

instead. Remove the surplus whiting with the dusting-brush, and the work is then ready for the size. Apply this with a sable or fit brush of the proper size, carefully observing to make the outer lines of the design clear and sharp, that the work may not appear ragged. Let the size remain until it feels tacky, when the gold may be applied. This is the most difficult part of the operation, and experience is necessary before gold-leaf can be laid smoothly without a wrinkle or a break. Turn a leaf of gold out of the book upon the cushion; breathe gently upon the center of the leaf and it will lay flat on the cushion; cut it to the proper size by bringing the knife perpendicularly over it, and sawing it gently until divided. Take your tip (a brush used for the purpose) and after drawing it lightly over your hair to remove any particles of dust that may be upon it, breathe upon it gently, which will dampen it sufficiently to cause the leaf of gold to adhere to it; lay the tip upon the leaf of gold and carefully transfer it to the work; blow upon it gently and it will straighten out and adhere. It may be rendered quite smooth by slightly dabbing it with a bit of cotton. In about an hour wash off the superfluous gold from the edges, with a sponge and water. If the article is to be exposed to the weather or much wear, the gilding may be varnished with copal varnish.

*Burnish-Gilding.*—As previously stated, this process requires a specially prepared foundation upon which to

lay the gold, and as the preparation of this foundation is a distinct trade, the furniture dealer or cabinet-maker seldom finds it necessary to undertake it, the articles coming to his hand ready-prepared for gilding; but as in repairing picture-frames, cornices, mirror frames, etc., it frequently becomes necessary to renew the foundation, a comprehensive description of the whole process is given.

*Preparing the Wood-work.*—After smoothing and dusting the work, coat the frames in every part with boiling-hot parchment-size, as previously described, then mix a sufficient quantity of whiting with size to the consistency of thick cream, and with it by means of a brush, coat every part of the frame several times, permitting each coat to become perfectly dry before proceeding with the next. The wood will thus be covered with a layer of hard whiting nearly or quite a sixteenth of an inch in thickness. The size must not be too thick, and when mixed with the whiting should not be so hot as the preliminary coat of size.

*Polishing.*—When the prepared frames are quite dry, clean and polish them. To do this, wet a small piece at a time, and, with a smooth, fine piece of cloth, dipped in water, rub the part till all the bumps and inequalities are removed; and for those parts where the fingers will not enter, as the mouldings, etc., wind the wet cloth round a piece of wood, and by this means make the surface all smooth and even alike.

Where there is carved work, etc., it will sometimes be necessary to bring the mouldings to their original sharpness by means of chisels, gouges, etc., as the preparation will be apt to fill up all the finer parts of the work, which must be thus restored. It is sometimes the practice, after polishing, to go over the work once with fine yellow or Roman ochre; but this is rarely necessary.

*Applying the Size.*—Select the proper gold size from the receipts previously given; add parchment size until it will just flow from the brush; make it quite hot, and apply it to the work with a very soft brush, taking care not to make the first coat too thick; let it dry and give two or three successive coats, after the last brushing it with a stiff brush to remove any inequalities. The work is then ready for the gold.

*Laying the Gold.*—The manipulation of the gold-leaf has been described under the heading OIL-GILDING. In the process now being described, the size used (being water-size, which as previously explained is permitted to become hard and dry after being applied) must be moistened to cause the gold-leaf to adhere to it. For this purpose, with a long-haired camel-hair pencil, dipped in water, go over as much of the work as you intend the piece of gold to cover; then lay the gold upon it in the manner previously explained. Be sure that the part to which the gold is applied is sufficiently wet; indeed it must be floating, or the gold will be apt

to crack. Proceed in this manner a little at a time, and do not attempt to cover too much at once, until by experience you are able to handle the gold with freedom. In proceeding with the work, if any flows or cracks appear, immediately apply a portion of gold sufficient to cover them. Sometimes when the gold does not appear to adhere sufficiently tight, it will be necessary to draw a pencil quite filled with water close to the edge of the gold, that the water may run underneath it and soften the size.

*Burnishing.*—When the work is covered with gold, set it by to dry; there is a particular state or degree of dryness, known only by experience in which the moulding is in a fit state for burnishing; it will probably be ready to burnish in about eight of ten hours, but it will depend on the warmth of the room or state of the air.

When it is ready, those parts intended to be burnished must be dusted with a soft brush; then wiping the burnisher with a piece of soft wash-leather (quite dry) begin to burnish about an inch or two in length at a time, taking care not to bear too hard, but with a gentle and quick motion, applying the tool until all the parts of the surface are equally bright.

*Matting or Dead Gold.*—Certain portions only of the work are burnished, according to the fancy, and the facility with which the burnishing-tool can be applied; the remaining parts are now to be deprived of

their metallic lustre, to make a more effective contrast with the burnishing. The parts thus treated are said to be matted or dead-gold. The process is as follows:

Grind some vermilion or yellow ochre very fine, and mix a very small portion either with the parchment size or with the white of an egg, and with a very soft brush lay it evenly on the parts to be dulled; if well done, it will add greatly to the beauty of the work. Previous to matting, the work must be well cleared of superfluous gold, by means of a soft brush.

*Finishing.*—In elaborate works it is frequently impossible to lay gold-leaf into all the intricacies of an elaborate design, and the parts thus left bare must be finished by touching up with a small brush charged with shell-gold, or gold-powder, mixed with gum-Arabic to the proper consistency. The following receipt describes the preparation of shell-gold:

*Shell Gold.*—Take any quantity of leaf-gold and grind it with a small portion of honey, to a fine powder, add a little gum-Arabic and sugar-candy, with a little water, and mix it well together; let it dry.

*Silver Size.*—Grind pipe-clay fine with a little black-lead and good soap, and add parchment-size as directed for gold-size.

*Composition for Frame Ornaments.*—The ornaments for gilded mirror-frames, etc., are usually moulded from some plastic substance that is somewhat tougher and more durable than the ordinary gilding founda-



tion of whiting and size. The proper moulds being prepared they are thoroughly rubbed upon the inside with sweet oil, and the composition firmly pressed in; after removing the mould the cast may be dried by a gentle heat, or while still plastic it can be applied in its proper place and bent into any position. Following are receipts for composition:

Dissolve 1 lb. of glue in 1 gallon of water. In another kettle boil together 2 lbs. of resin, 1 gill of Venice turpentine, and 1 pint of linseed oil; mix altogether in one kettle, and boil and stir till the water has evaporated. Turn the whole into a tub of finely-rolled whiting, and work it till it is of the consistency of dough.

Boil 7 lbs. of best glue in 7 half-pints of water. Melt 3 lbs. of white resin in 3 pints of raw linseed oil. When the above has been well boiled put them into a large vessel and simmer them for half an hour, stirring the mixture and taking care that it does not boil over. The whole must then be turned into a box of whiting rolled and sifted, and mixed till it is of the consistency of dough.

*To Manipulate Gold Leaf.*—Get a piece of paper, thin enough to show shadow of gold-leaf through, slightly wax it, lay it on gold-leaf, the latter will then adhere, and can be easily worked, and will come off clean. The paper should be slightly larger than the gold-leaf, and the fingers passed over the paper to make the gold-leaf adhere.

*Bronzing.*—This is a process for imitating on metal, plaster, wood, or other material, the peculiar appearance produced by chemical action upon the surface of bronze metal. It is accomplished by spreading over the surface of the material to be ornamented a very thin coating of bronze-powder, which is caused to adhere either by applying it directly upon a coating of any of the sizes mentioned in the foregoing pages, or by mixing with a vehicle, such as gum-Arabic or transparent varnish. The latter is most desirable, as in the other case, being subject to the direct action of the atmosphere, the bronze-powder soon tarnishes. In ornamenting furniture, bronzing is generally employed to represent gilding, a variety of bronze called gold-bronze being used, which affords an excellent imitation but is not very lasting. It is usually applied after the completion of the other finishing processes, the ground work being prepared in the manner described under OIL-GILDING, and the size likewise applied as there described. A small wad of cotton-batting is then dipped in the bronze and passed gently over the sized portions, causing the bronze to adhere. In the other method—that of applying the bronze by means of a vehicle—the preliminaries of whitening the ground and sizing are not necessary, a small quantity of bronze being simply mixed with the vehicle employed to such a degree of fluidity that it will flow easily, and in that condition applied with a fine brush. Many preparations are

used as vehicles, such as transparent varnish thinned with turpentine, gum-Arabic dissolved in water, and gold-size reduced with parchment-size. There are a variety of colors in bronze-powders, and to produce the best effect the size or vehicle should be of a color similar to that of the bronze used; in gold-size the coloring pigment is ochre, and in its place, for green-bronze, red-bronze, or blue-bronze, may be employed respectively verditer, vermilion or Prussian blue, a very small quantity being sufficient. In bronzing on painted work the ground should be as nearly as possible the color of the bronze to be applied.

## GLUE.

*Glue.*—Glue is prepared from waste pieces of skin, horns, hoofs, and other animal offal. These are steeped, washed, boiled, strained, melted, reboiled and cast into square cakes, which are then dried. The strongest kind of glue is made from the hides of oxen; that from the bones and sinews is weaker. The older the animal the stronger the glue. Good glue should be hard in the cake, of a strong, dark color, almost transparent, free from black or cloudy spots, and with little or no smell. The best sorts are transparent and of a clear amber color. Inferior kinds are sometimes contaminated with the lime used for removing the hair from the skins of which they are made. The best glue swells considerably (the more the better) when immersed in cold water, but does not dissolve, and returns to its former size when dry. Inferior glue made from bones, will, however, dissolve almost entirely in cold water.

*To Prepare Glue.*—To prepare glue for use it should be broken up into small pieces, and soaked in as much cold water as will cover it, for about twelve hours. It should then be melted in a double glue pot, covered to keep the glue from dirt. Care must be taken to keep the outer vessel full of water, so that the glue shall not burn, or be brought to a temperature higher than that of boiling water. The glue is allowed to simmer for

two or three hours, then gradually melted, so much hot water being added as will make it liquid enough, just to run off a brush in a continuous stream, without breaking into drops. When the glue is done with, some boiling water should be added to make it very thin before it is put away. Freshly-made glue is stronger than that which has been repeatedly melted. Too large a quantity should not therefore be made at a time. Glue may be freed from the foreign animal matter generally in it by softening it in cold water, washing it with the same several times, till it no longer gives out any color, then bruising it with the hand, and suspending it in a linen bag beneath the surface of a large quantity of water at  $66^{\circ}$  Fahr. By doing this the pure glue is retained in the bag, and the soluble impurities pass through. If the softened glue be heated to  $122^{\circ}$  without water, and filtered, some other impurities will be retained by the filter, and a colorless solution of glue be obtained.

The addition of a little bichromate of potash will render glue impervious to moisture after exposing to the light, and a small quantity of methylated spirits will greatly improve its keeping qualities.

*Mixing Glue.*—A minimum amount of glue should be used in good work, and it should be applied as hot as possible. The surfaces of the wood to be united should be clean, dry, and true; they should be brought together as tightly as possible, so that the superfluous

glue is squeezed out. The cohesion of a piece of solid glue, or the force required to separate one square inch, is four thousand pounds. The strength of common glue for coarse work is increased by the addition of a little powdered chalk. The hotter the glue the greater its cohesion; therefore in all large and long joints the glue should be applied immediately after boiling. Glue loses much of its strength by frequent re-melting; that glue, therefore, which is newly made, is much preferable to that which has been re-boiled.

*Glue Pot.*—A glue pot recently perfected consists of a circular kerosene lamp, made of tin, resting upon a tin bottom  $8\frac{1}{2}$  inches in diameter. The lamp is fitted with a tin chimney in place of glass, and fitted with a small aperture, covered with mica, so as to see how to regulate the flame. The glue pot is made of copper, tinned on the inside and supported upon a rim setting up about six inches from the bottom of the lamp, the rim supported by three legs, soldered and riveted to the rim and bottom of lamp rest. The pot in which the bottom is placed has a portion of the bottom arched, to give more heating surface, and connecting with the chamber under the pot is a flue, passing out and up alongside of the pot, which carries off any smoke from the lamp, and also acts as a draft to the flame. This pot is five inches in diameter, and about six inches high. The pot for the reception of the glue is set in the same as an ordinary glue pot, and will hold about a

quart of glue. The whole can be carried to any place where you wish to use it, and still have the heat kept up. The cost of oil is but a few cents a week.

Another improvement is in the pot being of copper, tinned. It will not corrode and spoil the glue, as is the case with iron.

French cabinet-makers use a glue pot with an inside pan made of glazed earthenware and divided radially into three divisions, in one of which is kept strong glue, in another weaker, and in the third water only, with a brush or piece of sponge for cleaning off superfluous glue from the work.

A few holes bored near the top of the inner vessel of a glue pot by admitting steam from the outer vessel will prevent the glue from solidifying on the side. They need not be bored round the whole circumference of the pot, to allow of pouring out the glue if necessary.

*To Prevent Glue Cracking.*—Glue frequently cracks because of the dryness of the air in rooms warmed by stoves. The addition of chloride of calcium to glue will prevent this disagreeable property of cracking. Chloride of calcium is such a deliquescent salt that it attracts enough moisture to prevent the glue from cracking. Glue thus prepared will adhere to glass, metal, etc., and can be used for putting on labels without danger of their dropping off.

*Strong Glue to Resist Moisture.*—Dissolve gum-sandarac and mastic, of each a quarter of an ounce, in

a quarter of a pint of spirits of wine, to which add a quarter of an ounce of clear turpentine; now take strong glue, or that in which isinglass has been dissolved; then, putting the gums into a double glue-pot, add by degrees the glue, constantly stirring it over the fire till the whole is well incorporated; strain it through a cloth, and it is ready for use. You may now return it to the glue pot, and add half an ounce of very finely-powdered glass; use it quite hot. If you join two pieces of wood together with it, you may, when perfectly hard and dry, immerse it in water, and the joint will not separate.

*Glue to Resist Moisture.*—To two quarts of skimmed milk add half a pound of the best glue; melt them together, taking care they do not boil over, and you will have a very strong glue, which will resist damp or moisture.

*Portable Glue.*—Boil one pound of the best glue, strain it very clear; boil also four ounces of isinglass; put it into a double glue-pot, with half a pound of fine brown sugar, and boil it pretty thick; then pour it into plates or moulds. When cold you may cut and dry them for the pocket.

This glue is very useful to draughtsmen, architects, etc., as it immediately dilutes in warm water, and fastens the paper without the process of dampening; or, it may be used by softening it in the mouth, and applying it to the paper.



## FRESH AIR IN THE GLUE ROOM.

How to get fresh air in the glue room during the hot periods of summer, and at the same time not have the disturbing drafts that evaporate thinly-spread glue, is quite a problem. Yet, like many other problems, it is largely a matter of attention to details. There are various ways of ventilating rooms so as to get fresh air without getting a strong current. The temptation is naturally strong to throw open windows and doors in hot weather, so as to have a breeze, but generally this is the very thing one must guard against.

Some glue rooms that have windows on one side and the other three sides carefully inclosed, may have the windows opened without producing a strong draft, but, even so, it is better to have window screens made of fine, close-meshed wire, something like those used on railway trains to keep out the dust. They will help keep out the dust, keep out the draft, and also keep out insects that are tempted by the odor of the glue to make a visit to the glue room. There are other variations, such as letting down the top windows instead of raising the bottom ones; others in which a box-like arrangement opening upward instead of straight in, is inserted under the window to let in the fresh air and turn it upward instead of across the room. These are mechanical ventilators that can be used for scientifically ventilating a room without producing currents. And

there are, in fact, many ways to get around this draft business, and while their use may deprive the glue room of some of the breeziness that is inviting in summer, still they will furnish fresh air in a manner that is more healthful to those working in it, as well as less damaging to the glue work than strong currents.

## MISCELLANEOUS RECEIPTS.

*To Raise Old Veneers.*—First, wash the surface with boiling water, and, with a coarse cloth, remove dirt or grease; then place it before the fire, or heat it with a caul; oil its surface with common linseed-oil, place it again to the fire, and the heat will make the oil penetrate quite through the veneer, and soften the glue underneath; then, while hot, raise the edge gently with a chisel, and it will separate completely from the ground; be careful not to use too great force, or the work will be spoiled. Again, if it should get cold during the operation, apply more oil, and heat it again. Repeat this process till the veneer is entirely separated, then wash off the old glue and proceed to lay it again as a new veneer.

*To Take Out Bruises in Furniture.*—Wet the part with warm water; double a piece of brown paper five or six times, soak it, and lay it on the place; apply on that a hot flat-iron till the moisture is evaporated. If the bruise be not gone, repeat the process. After two or three applications, the dent or bruise will be raised level with the surface. If the bruise be small, merely soak it with warm water, and apply a red-hot poker very near the surface; keep it continually wet, and in a few minutes the bruise will disappear.

*To Make Paste for Laying Cloth or Leather.*—To a pint of the best wheaten flour add resin, very finely

powdered, about two large spoonfuls; of alum, one spoonful, in powder; mix them all well together, put them into a pan, and add by degrees soft or rain water, carefully stirring it till it is of the consistence of thin cream; put it into a saucepan over a clear fire, keeping it constantly stirred, that it may not get lumpy. When it is of a stiff consistence, so that the spoon will stand upright in it, it is done enough. Be careful to stir it well from the bottom, for it will burn if not well attended to. Empty it out into a pan and cover it over till cold, to prevent a skin forming on the top, which would make it lumpy.

This paste is very superior for the purpose, and adhesive. To use it for cloth or baize, spread the paste evenly and smoothly on the top of the table, and lay the cloth on it, pressing and smoothing it with a flat piece of wood; let it remain till dry; then trim the edges close to the cross-banding. If you cut it close at first, it will, in drying, shrink and look bad where it meets the banding all round: If used for leather, the leather must be first previously damped, and then the paste spread over it; then lay it on the table, and rub it smooth and level with a linen cloth, and cut the edges close to the banding with a short knife. Some lay their table cover with glue instead of paste, and for cloth perhaps it is the best method; but for leather it is not proper, as glue is apt to run through. In using it for cloth, great care must be taken that the glue be

not too thin, and that the cloth be well rubbed down with a thick piece of wood made hot at the fire, for the glue soon chills. By this method, the edges may be cut off close to the border at once.

*Cements for Stopping Flaws in Wood.*—Put any quantity of fine sawdust of the same wood your work is made with into an earthen pan, and pour boiling water on it, stir it well, and let it remain for a week or ten days, occasionally stirring it; then boil it for some time, and it will be of the consistence of pulp or paste; put it into a coarse cloth, and squeeze all the moisture from it. Keep for use, and, when wanted, mix a sufficient quantity of thin glue to make it into a paste; rub it well into the cracks, or fill up the holes in your work with it. When quite hard and dry, clean your work off, and if carefully done, you will scarcely discern the imperfection.

*Mahogany-Colored Cement.*—Melt two ounces of beeswax and half an ounce of Indian red, and a small quantity of yellow ochre, to bring the cement to the desired color; keep it in a pipkin for use.

*Cement for Turners.*—Melt together beeswax, one ounce; resin, half an ounce; and pitch, half an ounce; stir in the mixture some very fine brickdust to give it a body. If too soft, add more resin; if too hard, more wax. When nearly cold, make it up into cakes or rolls, which keep for use.

This will be found very useful for fastening any

piece of wood on the chuck, which is done by applying the roller of cement to the chuck and it will adhere with sufficient force.

*To Cut Good Steel Scrapers.*—Part of the blade of a broken saw makes the best scrapers; but, as it is hard, it is very difficult to cut it into the required form. The best and most expeditious way is to mark it out to the size wanted, and then to place the blade or steel plate in a vice whose chaps shut very close, placing the mark even with the face of the vise, and the part to be cut to waste above the vise. Then with a cold-chisel, or a common steel-firmer that has its basil broken off, holding it close to the vise and rather inclined upwards, begin at one end of the steel plate, and with a sharp blow of the hammer it will cut it. Keep going on by degrees, and you will with ease cut it to the shape required; then grind the edges of your scraper level, and finish by rubbing it on your oil stone.

*To Clean Oil Paintings.*—Wash with a sponge or a soft leather and water, and dry by rubbing with a silk handkerchief. When the picture is very dirty, take it out of its frame, procure a clean towel, and making it quite wet, lay it on the face of the picture, sprinkling it from time to time with clear soft water; let it remain wet for two or three days; take the cloth off and renew it with a fresh one; after wiping the picture with a clean wet sponge, repeat the process till all the dirt is soaked out; then wash it well with a soft sponge, and let

it get dry; rub it with some clear nut or linseed oil. Spirits of wine and turpentine may be used to dissolve the hard old varnish, but they will attack the paint as well as the varnish if the further action of the spirits is not stopped at the proper time by using water freely.

*Cleaning Varnished Pictures.*—There are conditions where the above simple process will not accomplish what is required; where a thick coating of varnish has been applied to the picture, and it has been hung in a smoky room, and dust and dirt has been allowed to gather and remain; then it is that no high lights will be visible, the sky will be dirty, no distance visible, and perhaps the figures in the foreground very indistinct. Under these conditions the varnish must be either removed or the smoke and dirt must be brought out of the varnish. If it is thought desirable to try the latter, the following receipt will be found valuable for the purpose: 2 oz. wood naphtha, 1 oz. spirits of salts,  $\frac{1}{4}$  pint of linseed-oil.

Mix the above well together, and before using shake the bottle. It can be used as follows: Get some soft linen rag, and make up a soft pad, which place on the mouth of the bottle and shake up some of the mixture into the pad, then commence rubbing the picture with a circular motion, and when nearly dry again give the pad another dressing of mixture, and continue this mode of procedure for some time, when the picture will gradually come out in all its detail.

*Cleaning Engravings.*—Put the engraving on a smooth board, cover it thinly with common salt finely powdered. Squeeze lemon juice upon the salt so as to dissolve a considerable portion of it; elevate one end of the board so that it may form an angle of about 45 or 50 degrees. Pour on the engraving boiling water from a tea kettle until the salt and lemon juice be all washed off. The engraving then will be perfectly clean and free from stains. It must be dried on the board or some smooth surface gradually. If dried by the fire or the sun it will be tinged with a yellow color.

*Cleaning Engravings.*—Presuming these to be mounted, proceed in the following manner: Cut a stale loaf in half, with a perfectly clean knife; pare the crust away from the edges. Now place the engravings on a perfectly flat table, and rubbing the surface with the fresh-cut bread, in circular sweeps, lightly but firmly performed, will remove all superficial markings. Now soak the prints for a short time in a dilute solution of hydrochloric acid, say 1 part acid to 100 of water, and then remove them into a vessel containing a sufficient quantity of clear chloride lime water to cover them. Leave them there until bleached to the desired point. Now remove, rinse well by allowing to stand an hour in a pan in which a constant stream of water is allowed to flow, and finally dry off by spreading on clean cloths. Perhaps the sheets may require ironing between two sheets of clean paper.



*To Smooth a Damaged Picture.*—Paintings sometimes get convex and concave patches on their surface, owing to pressure on one side or the other, and these inequalities cause a great deal of trouble to bring out. The most successful way is to well wet both sides of the picture on the spot, and keep it under pressure till dry. With small pictures the quickest way would be to take them off the stretcher and lay them in a press, with a light pressure between soft sheets of paper.

*Embossed Gilding for Illuminating.*—Gilding of figures and letters on paper and for the embellishment of manuscripts, is performed with shell gold tempered with gum water; or the characters may be drawn with a milky solution of gum ammanacum made in water, and gold leaf applied upon them when almost dry; they may again be sufficiently moistened for receiving the gold by breathing on them. Letters raised from the surface, if paper or parchment in the manner of embossed work, such as are seen on ancient manuscripts, may be formed either by friction on a proper body with a solid piece of gold, or by leaf gold.

The former method is practiced by tempering pulverizers' crystal with strong gum water, and with this paste forming the letters; when they are dry, they are rubbed with a piece of solid gold as in polishing, and the letters will appear as if gilt with burnished gold. The letters are formed with an embossed figure, either of the separate letters or of whole words cut in steel,

and each letter of these stamps when they are used, is oiled evenly with a feather. Then fill these concave letters with the above paste, and strike the stamps in a perpendicular direction on the paper or vellum laid on sheets of soft paper.

When the embossed letters are formed with leaf gold, the following or a similar composition must be used. Thicken beaten whites of eggs with as much vermilion as is necessary to give them the consistence of paste; use the stamps as before, and when the letters are dry moisten them by a small pencil with strong gum water, and when this is almost dry cover the letters with leaf gold, pressing it close to every part of them with cotton wood; when dry, burnish.

# INDEX

---

## A

	Page
American Mechanics .....	12
Apprentice Question .....	16
Art, The New .....	186

## B

Barogne Style .....	74
Beds, Covered .....	140
Elaborate .....	153
German Covered .....	160
Napoleonic .....	164
Roman .....	104
With Canopy .....	143
Greek and Roman .....	31
Bellows and Chairs, Carved .....	51
Bench Hands .....	11
Bleaching .....	293
Book-Cases, Revolving, How to Make .....	306
Sheraton .....	167
Books on Cabinet Making .....	18
British Museum Treasures .....	103
Burnishing .....	347

## C

Cabinet Makers, Egyptian .....	24
Cabinets .....	141
Cairene .....	47
Costly .....	151, 202
French .....	56
Hanging .....	209
Inlaid .....	69
Wine .....	100
Candelabra .....	28
Carriages and Carts, Old .....	45
Cements, Cabinet Maker's .....	361
Chairs, Beds and Tables, Egyptian .....	22

	Page
Chairs, Corner .....	264
Coronation .....	44
Double, by Sheraton.....	174
Dutch .....	191
Easy Backed .....	156
Gothic .....	127
Greek .....	26
Heppelwhite .....	182
High Backed .....	194
How to Make .....	267
Marie Antoinette .....	150
Of Dagobert .....	38
Of State .....	129
Of St. Maximian .....	36
Old .....	193
Old Spanish .....	165
Ponderous .....	195
Queen Hatasus .....	117
Scandinavian .....	37
Throne .....	34
Two German .....	161
Chinese Style .....	85
Work .....	138
Chippendale, Thomas .....	84
Chippendale Work .....	181
Cinquecento Period .....	52
Classical Style .....	121
Cleaning Engravings .....	364
Oil Paintings .....	362
Clock, Grandfather's .....	260
Old Mahogany .....	262
Coffers, Carved .....	50
Egyptian .....	106
Marriage .....	49
Couch .....	157
Cutting Veneers .....	278
Dovetailing .....	222
Method of .....	269

## F

Framed Work .....	232
French Polishing .....	285
French Renaissance .....	57
Fumigating .....	295
Fumigation, Natural .....	295
Furniture, Anglo-Norman .....	39
Anglo-Saxon .....	38
Assyrian .....	22

	Page
Furniture	
Byzantine	35
Chaldean	135
Dining Room	214
Dutch	61
English	58
Etruscan	27
Fashion in	94
Flemish	58
Fourteenth Century	137
French	55
Hand Made	15
History of	19
Homely	13
Indian	64
King Solomon's	23
Lacquered	88
Making	10
Medieval	41
Old	93, 131
Pompeiiian	31
Roman	27
Saracenic	45
Scriptural	21
Siam	126
Solid Wood	99
Some Egyptian	122
Spanish	59
Styles and Details of	90
Venetian	61

## G

German Renaissance	58
Gibbons, Grenling, Carver	71
Gilding, Embossed	365
Gilding, Silvering and Bronzing	339
Glue	352
Portable	356
Pot	354
Room, Fresh Air in	357
Gothic Period	40
Great Bed of Ware	58

## H

Hinges	236
Hinge for Table	236
Hinging, General	238
Household Article, Old	99

## I

	Page
Inlaid Work .....	67
Interior, Oriental .....	188
Italian Renaissance .....	48

## J

Job Work .....	12
Joints, Cabinet .....	225
Cabinet Maker's .....	217
Capped .....	228
Dowel .....	219
Feather .....	220
Grooved .....	218
Miter .....	226
Mortise and Tenon .....	223
Plain Glued .....	218
Rule .....	240
Scribed .....	229

## K

Koran Holder .....	190
--------------------	-----

## L

L'Art Nouveau .....	186
Lamp Stand .....	32
Louis Quatorze Period .....	63
Louis Quinze Period .....	70

## M

Machine Men .....	14
Making Drawers Slide Easily .....	272
Marquetry .....	66
Middle Age Interior .....	130
Mirror Frames .....	65
Mirrors, Hand .....	26
Mission and Crafts Examples .....	311
Fads .....	187
Work .....	243
Mobilia .....	102
Moorish Taste .....	111
Mouldings, Built up .....	234
Planted .....	230
Solid .....	230
Mummy Cases .....	22

## N

Novelty .....	95
Novelty, Taste and Utility .....	112

## O

Oil Polishing .....	Page 302
---------------------	-------------

## P

Picture Frames, Composition for.....	348
Pierre Boulle .....	64
Plate I. Gothic Interior .....	101
Plate II. Louis XV and XVI Details .....	107
Plate III. Louis Seize Detail.....	113
Plate IV. Two Tables .....	132
Plate V. Empire Details .....	134
Plate VI. Empire Style .....	136
Plate VII. German Renaissance .....	138
Plate VIII. Chippendale Style .....	155
Plate IX. Chippendale Details .....	159
Plate X. Sheraton Style .....	163
Plate XI. Heppelwhite Details .....	166
Plate XII. Heppelwhite Style .....	170
Plate XIII. Adam's Style .....	177
Plate XIV. Adam's Interior .....	183
Plate XV. Swiss Examples .....	189
Plate XVI. The New Art Interior.. ..	192

## Q

Quattrocento Period .....	49
---------------------------	----

## R

Receipts, Miscellaneous .....	359
Repairs .....	293
Revivers for Furniture .....	293
Roman Curule .....	29

## S

Seats, Antique .....	35
Of the Ancients .....	43
Seventeenth Century Work .....	108
Sideboards .....	206
Details of .....	251
Furnished .....	254
How to Make .....	247
View of .....	248
Smoothing a Damaged Picture.....	365
Sofa, Sheraton .....	175
Staining and Varnishing.....	304
Style, Details of .....	90
Domestic .....	121
Empire .....	86

	Page
Style, Florid .....	121
Grotesque .....	121
Mannerisms of .....	92
Marie Antoinette .....	92
Of Cabinet Work .....	17
Persian .....	64
Portuguese .....	64
Rococo .....	73
Romanesque .....	38
Turkish .....	90
Vernis Martin .....	77
Styles, Synopsis of .....	203
Subdivision of Work .....	11
Sweating Out .....	394

### T

Tabernacle .....	21
Table, Circular .....	158
Dining .....	199
Double .....	83
Dressing .....	78
Handy .....	245
Marie Antoinette .....	148
Mission .....	241
Riesner .....	152
Roman .....	30
Square .....	197
Unique Circular .....	179
Taste in Construction .....	115
Throne, Assyrian .....	25
Tools, Workman's .....	215
Trade Unionism .....	212

### U

Upholsterer's Trade .....	97
Utility .....	116

### V

Vehicles, Covered .....	46
Veneered Work, Modern .....	99
Veneering, Staining and Finishing .....	276

### W

Wax Polishing .....	299
Work-Shop Kinks and Staining Receipts .....	324
Writing Desk .....	81
Writing Desk and Cabinet .....	200



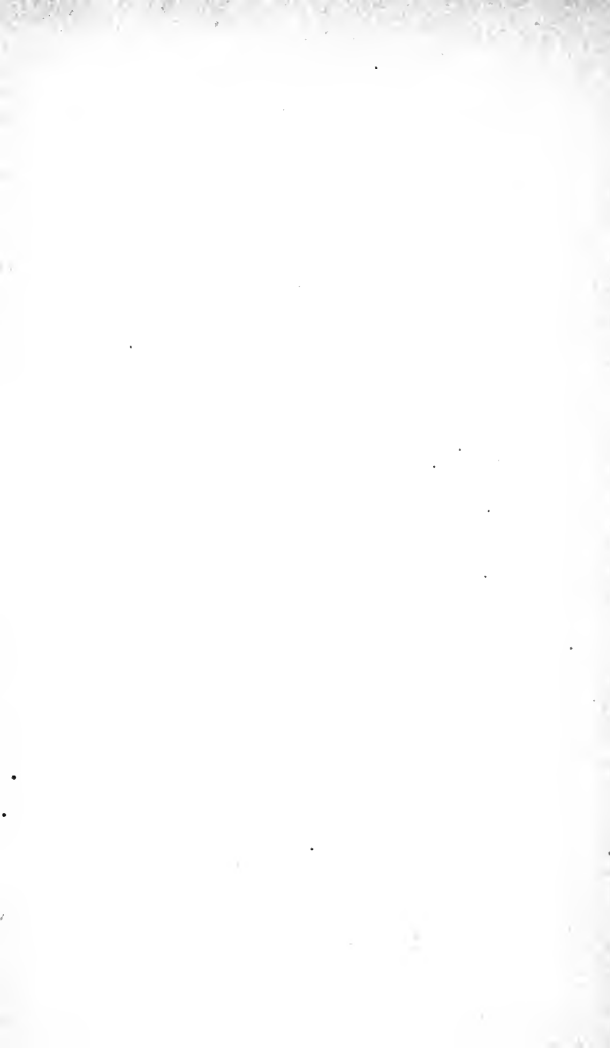





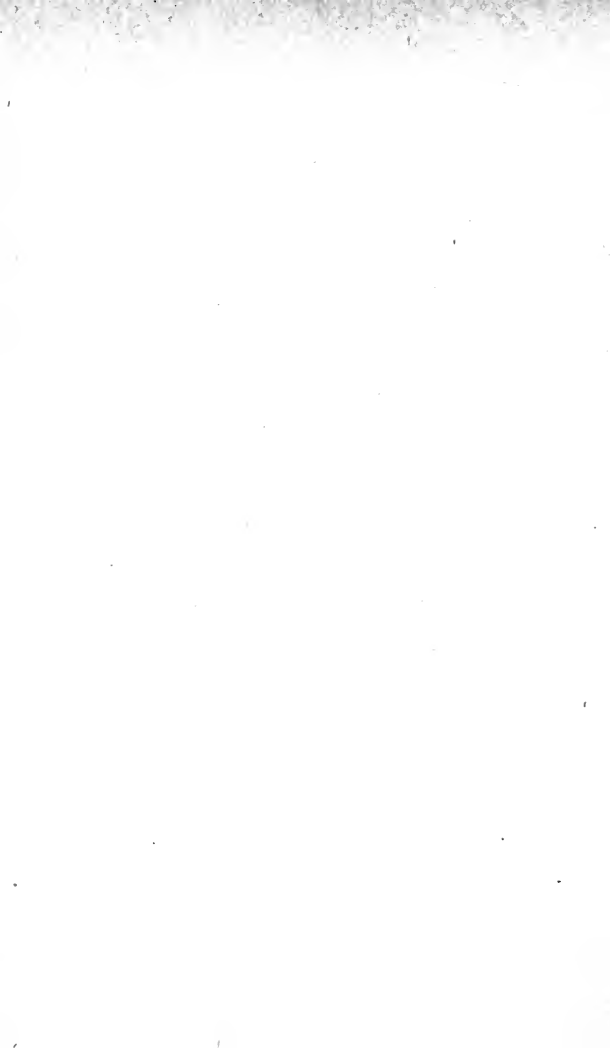







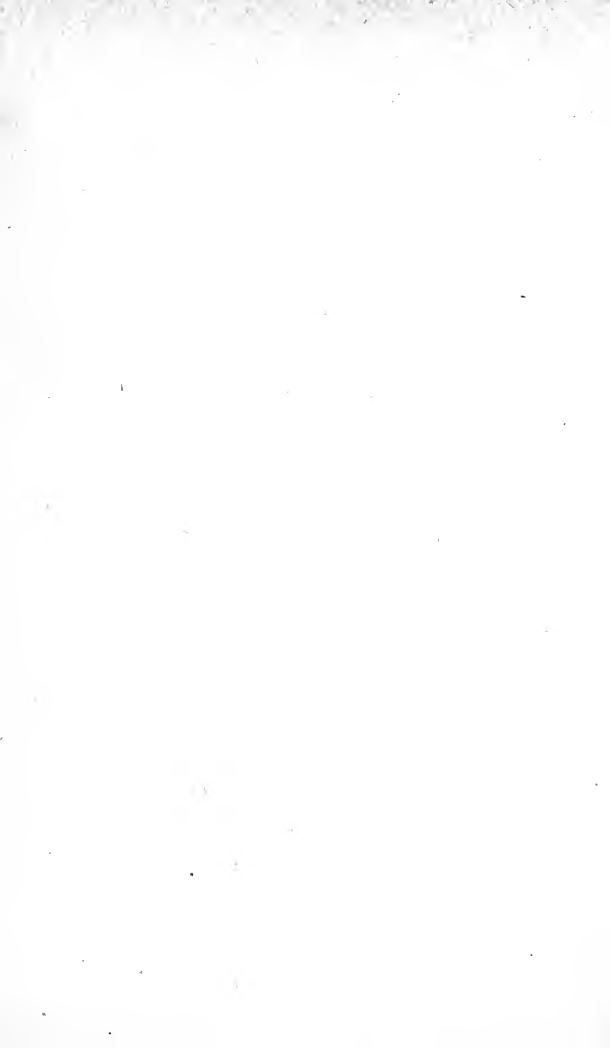





TT.  
197  
H62

THE LIBRARY  
UNIVERSITY OF CALIFORNIA  
Santa Barbara

THIS BOOK IS DUE ON THE LAST DATE  
STAMPED BELOW.

<del>NOV 22 '71 11 2</del>	
<del>DEC 13 '71 11 23</del>	
<del>JAN 10 '72 12 13</del>	
<del>JAN 31 '72 1 10</del>	



A 000 580 609 6

Woods-

Stone, N. ...

...

